



HIGH PERFORMANCE LED | LIGHTING & ACCESSORIES



Heise LED Lighting, by Metra Electronics, are exclusively developed and manufactured to meet all international standards. Our range of lighting integrates advanced thermal management, short circuit and open circuit protection and many other innovative features. All products undergo rigorous testing during the development and manufacturing process and again before leaving the factory. Metra's history, experience and approach to engineering and manufacturing ensure that their products stand out among the competitors and are the highest quality lights available on the market.

UNIVERSAL FIT

HIGH PERFORMANCE LED LIGHTING

Auxiliary driving and fog lights are intended for use solely as auxiliary lighting. They are not intended to be used for headlight purposes, nor are they certified for headlight usage. Auxiliary lights are designed to improve visibility during night time driving and inclement weather. Irresponsible use of any auxiliary light can be dangerous and illegal. Auxiliary driving lights are intended to supplement the high-beam of a standard headlamp system. They are not intended for use alone or with the low-beam of a standard headlamp system. Lighting laws vary from state to state.



NOT FOR USE
ON PUBLIC ROADS

LED LIGHTBARS **2-25**

WIRE HARNESSES & SWITCH PANEL **26-29**

LIGHTBAR LENS COVERS & BRACKETS **30-31**

BRACKETS & MOUNTS **33-40**

CUBE LIGHTS **41-48**

DRIVING LIGHTS **49-52**

RGB LIGHTS **53-72**

ACCENT LIGHTS **73-84**

VEHICLE LIGHTS **85-96**

MOTORCYCLE **97-108**

POWERSPORTS **109-112**

MARINE **113-124**

MUNICIPALITY **125-130**

TRAILER **133-144**

MERCHANDISE **145-147**



LED LIGHTBARS



LED LIGHTBARS

DESIGNED
EXCLUSIVELY FOR
OFF ROAD!





Heise LED Lighting Systems®, by Metra Electronics®, are exclusively engineered and manufactured to meet all international standards. Metra's history, experience and approach to engineering and manufacturing ensure that their products stand out among the competitors and are the highest quality lights available on the market.

The Heise range of lighting technology integrates advanced thermal management, short circuit and open circuit protection and many other innovative features. All products undergo rigorous testing during the development and manufacturing process and again before leaving the factory.



FEATURES

M MILITARY BREATHER PORT

MACHINED MECHANICAL VENT PORT

1. Allows for any internal moisture to escape which can be caused by extreme heat and rapid cooling
2. Also assists with preventing any external moisture from entering the lightbar housing



H HYBRID SYSTEM

THE BEST OF BOTH WORLDS

Intense spotlights in the center flanked by wide beam driving lights on each side give you everything in one lightbar

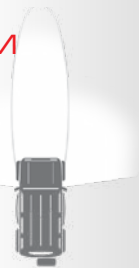

U UNIVERSAL DUAL MOUNT SYSTEM

MOUNT ANYWHERE

Heavy-duty rubber foot mounts help reduce vibration for LED lightbars anywhere



G GORE® MEMBRANE

GORE® MEMBRANE IS A SELF-ADHESIVE ONE WAY VALVE THAT HAS A DUAL PURPOSE

1. It allows for any internal moisture to escape which can be caused by extreme heat and rapid cooling.
2. It also assists with preventing any external moisture from entering the lightbar housing

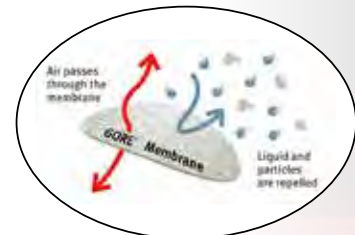

DUAL ROW LED LIGHTBARS

HIGH OUTPUT

HE-HDR8 08 INCH 12 LED

Wattage: 36W • Raw Lumens: 3240lm
Current Consumption @ 13.8V: 2.26A • IP Rating: IP67



HE-HDR14 14 INCH 24 LED

Wattage: 72W • Raw Lumens: 6480lm
Current Consumption @ 13.8V: 4.5A • IP Rating: IP67



HE-HDR22 22 INCH 40 LED

Wattage: 120W • Raw Lumens: 10800lm
Current Consumption @ 13.8V: 4.52A • IP Rating: IP67



HE-HDR32 32 INCH 60 LED

Wattage: 180W • Raw Lumens: 16200lm
Current Consumption @ 13.8V: 16.5A • IP Rating: IP67



HE-HDR42 42 INCH 80 LED

Wattage: 240W • Raw Lumens: 21600lm
Current Consumption @ 13.8V: 8.8A • IP Rating: IP67



HE-HDR50 50 INCH 96 LED

Wattage: 288W • Raw Lumens: 25920lm
Current Consumption @ 13.8V: 18.1A • IP Rating: IP67



H

HYBRID

U

UNIVERSAL

MMILITARY BREATHER
MEMBRANE

COMMON FEATURES

**INPUT VOLTAGE:** 10-30V DC**COLOR TEMPERATURE:** 6000K**BEAM PATTERN:** COMBO: 90° FLOOD / 8° SPOT**HOUSING MATERIAL:** DIE-CAST ALUMINUM**COLOR:** BLACK**MEMBRANE:** MILITARY BREATHER**LENS MATERIAL:** POLYCARBONATE**MOUNTING BOLT DRILL:** 0.25"**ELECTRONICS:** INTEGRATED-EPOXY ENCAPSULATED**HARDWARE:** ALUMINUM**OPERATING TEMPERATURE:** -40°F TO +140°F**PROTECTION:** REVERSE POLARITY**MOUNTING:** SIDE & REAR

SPECS & MEASUREMENTS

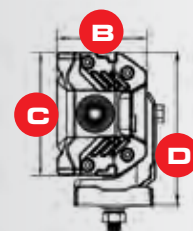
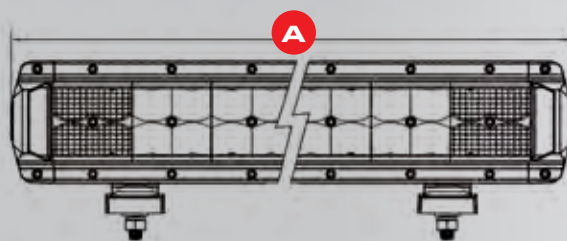

PART	A	B	C	D
HE-HDR8	8.11"	2.28"	3.07"	3.62"
HE-HDR14	14.13"	2.28"	3.07"	3.62"
HE-HDR22	22.17"	2.28"	3.07"	3.62"
HE-HDR32	32.20"	2.28"	3.07"	3.62"
HE-HDR42	42.24"	2.28"	3.07"	3.62"
HE-HDR50	50.28"	2.28"	3.07"	3.62"

DUAL ROW HEATED LED LIGHTBAR

HE-HDRH22

22 INCH

40 LED

HIGH OUTPUT

HEATED

Wattage: 120W • **Raw Lumens:** 10800lm • **IP Rating:** IP67

Current Consumption @ 13.8V: 8.27A

The lightbar's heating element will activate below 41° F to assist with defrosting and de-icing of the lightbar and will automatically shut off when temperature reaches above 41° F.



SPECS & MEASUREMENTS



Heating element

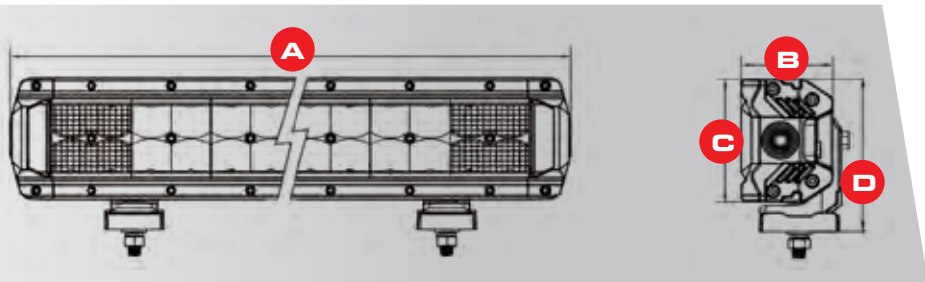

PART	A	B	C	D
HE-HDRH22	22.17"	2.28"	3.07"	3.62"

DUAL ROW SIDELIGHT LED LIGHTBARS

HIGH OUTPUT SIDELIGHT

HE-HDRS8

9.2 INCH

12 LED

Wattage: 48W • **Raw Lumens:** 4760lm

Current Consumption @ 13.8V: 3.58A • **IP Rating:** IP67



HE-HDRS14

15.2 INCH

24 LED

Wattage: 84W • **Raw Lumens:** 8000lm

Current Consumption @ 13.8V: 5.58A • **IP Rating:** IP67



HE-HDRS22

23.2 INCH

40 LED

Wattage: 132W • **Raw Lumens:** 12320lm

Current Consumption @ 13.8V: 9.58A • **IP Rating:** IP67

The High Output Sidelight series builds on the extreme power of the High Output series by incorporating a set of diffused LED endcaps. The result, a lightbar that produces an amazing 240 degree field of intense illumination.



H

HYBRID

U

UNIVERSAL

MMILITARY BREATHER
MEMBRANE

COMMON FEATURES

**INPUT VOLTAGE:** 10-30V DC**COLOR TEMPERATURE:** 6000K**BEAM PATTERN:** COMBO: 90° FLOOD / 8° SPOT**HOUSING MATERIAL:** DIE-CAST ALUMINUM**COLOR:** BLACK**MEMBRANE:** MILITARY BREATHER**LENS MATERIAL:** POLYCARBONATE**MOUNTING BOLT DRILL:** 0.25"**ELECTRONICS:** INTEGRATED-EPOXY ENCAPSULATED**HARDWARE:** ALUMINUM**OPERATING TEMPERATURE:** -40°F TO +140°F**PROTECTION:** REVERSE POLARITY**MOUNTING:** REAR ONLY

SPECS & MEASUREMENTS

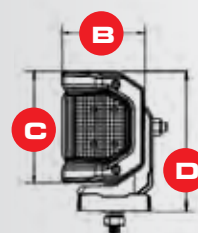
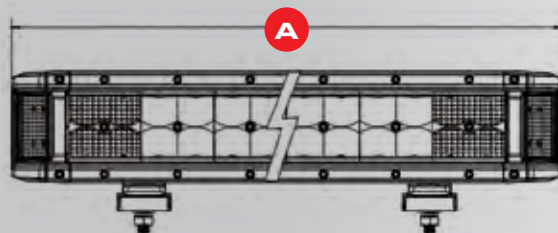

PART	A	B	C	D
HE-HDRS8	9.13"	2.28"	3.07"	3.62"
HE-HDRS14	15.16"	2.28"	3.07"	3.62"
HE-HDRS22	23.19"	2.28"	3.07"	3.62"



DRL SERIES LED LIGHTBARS

DAYTIME RUNNING LIGHTS

Heise's DRL Series dual-row lightbars have an integrated daytime running light in the center along the entire length of the bar, with a clean white light that provides additional visibility - day or night. The daytime running lights can be lit without the off-road lights being on and are powered by 6V to 24V circuits, using new 3-wire DT3 and ATP3 plugs and pigtails.

HE-DRL8

8 INCH

12 LED

Wattage: 36W • **Raw Lumens:** 2280lm • **Lux @ 10M:** 215
Current Consumption @ 13.8V: 2.6A • **IP Rating:** IP67



HE-DRL14

14 INCH

24 LED

Wattage: 72W • **Raw Lumens:** 5760lm • **Lux @ 10M:** 466
Current Consumption @ 13.8V: 5.2A • **IP Rating:** IP67



HE-DRL30

30 INCH

56 LED

Wattage: 180W • **Raw Lumens:** 13440lm • **Lux @ 10M:** 1909
Current Consumption @ 13.8V: 13.0A • **IP Rating:** IP67



HE-DRL40

40 INCH

76 LED

Wattage: 240W • **Raw Lumens:** 18240lm • **Lux @ 10M:** 2531
Current Consumption @ 13.8V: 17.4A • **IP Rating:** IP67



HE-DRL50

50 INCH

96 LED

Wattage: 288W • **Raw Lumens:** 23040lm • **Lux @ 10M:** 2750
Current Consumption @ 13.8V: 20.9A • **IP Rating:** IP67



H

HYBRID

U

UNIVERSAL

MMILITARY BREATHER
MEMBRANE

COMMON FEATURES

**INPUT VOLTAGE:** 6-30V DC**COLOR TEMPERATURE:** 6000K**BEAM PATTERN:** COMBO: 90° FLOOD / 8° SPOT**HOUSING MATERIAL:** POWDER COATED ALUMINUM**COLOR:** BLACK**MEMBRANE:** MILITARY BREATHER**LENS MATERIAL:** POLYCARBONATE**MOUNTING BOLT DRILL:** 0.25"**ELECTRONICS:** INTEGRATED-EPOXY ENCAPSULATED**HARDWARE:** STAINLESS 316**OPERATING TEMPERATURE:** -40°F TO +140°F**PROTECTION:** REVERSE POLARITY**MOUNTING:** SIDE & REAR

SPECS & MEASUREMENTS

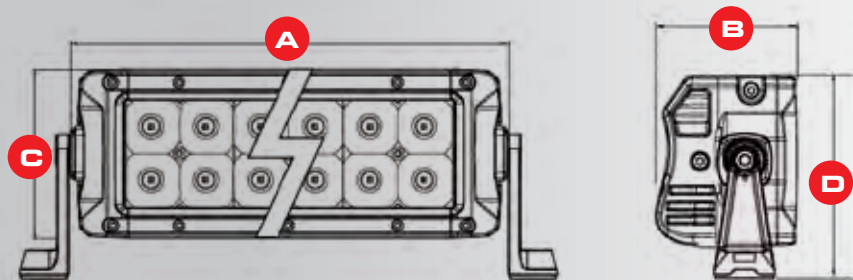

PART	A	B	C	D
HE-DRL8	8.11"	2.56"	3.09"	4.84"
HE-DRL14	14.09"	2.56"	3.09"	4.84"
HE-DRL30	30.20"	2.56"	3.09"	4.84"
HE-DRL40	40.24"	2.56"	3.09"	4.84"
HE-DRL50	50.12"	2.56"	3.09"	4.84"

INFINITE SERIES LED LIGHTBARS



RGB LEDS

HE-INFIN8 8 INCH 12 LED

Wattage: 18W • **Raw Lumens:** 2280lm • **Lux @ 10M:** 235
Current Consumption @ 13.8V: 1.3A • **IP Rating:** IP67



HE-INFIN22 22 INCH 40 LED

Wattage: 60W • **Raw Lumens:** 7600lm • **Lux @ 10M:** 1150
Current Consumption @ 13.8V: 4.34A • **IP Rating:** IP67



RGB LEDS

HE-INFIN30 30 INCH 56 LED

Wattage: 84W • **Raw Lumens:** 10640lm • **Lux @ 10M:** 1426
Current Consumption @ 13.8V: 6.1A • **IP Rating:** IP67



RGB LEDS

HE-INFIN40 40 INCH 76 LED

Wattage: 114W • **Raw Lumens:** 14440lm • **Lux @ 10M:** 1780
Current Consumption @ 13.8V: 9.5A • **IP Rating:** IP67



RGB LEDS

HE-INFIN50 50 INCH 96 LED

Wattage: 144W • **Raw Lumens:** 17100lm • **Lux @ 10M:** 2350
Current Consumption @ 13.8V: 14.3A • **IP Rating:** IP67



RGB LEDS

H

HYBRID

U

UNIVERSAL

MMILITARY BREATHER
MEMBRANE

COMMON FEATURES

**INPUT VOLTAGE:** 10-30V DC**COLOR TEMPERATURE:** 6000K**BEAM PATTERN:** 8° SPOT**HOUSING MATERIAL:** DIE-CAST ALUMINUM**COLOR:** BLACK**MEMBRANE:** MILITARY BREATHER**LENS MATERIAL:** POLYCARBONATE**MOUNTING BOLT DRILL:** 0.25"**ELECTRONICS:** INTEGRATED-EPOXY ENCAPSULATED**HARDWARE:** STAINLESS 316**OPERATING TEMPERATURE:** -40°F TO +140°F**PROTECTION:** REVERSE POLARITY**MOUNTING:** SIDE & REAR★ IP68 ★
CERTIFIED**NEW!****RGB-CB1****CONTROL BOX**Required for RGB functionality
on all Infinite Series lights.
(Sold separately)

SPECS & MEASUREMENTS

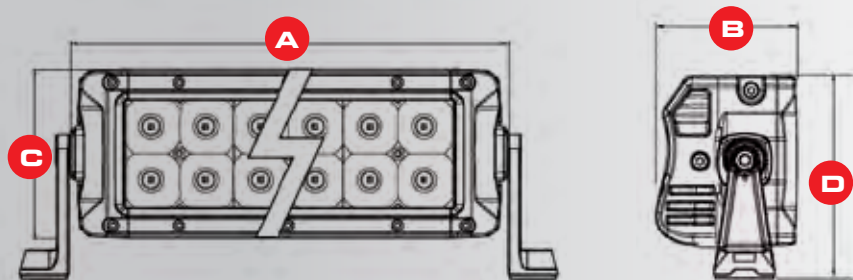

PART	A	B	C	D
HE-INFIN8	8.11"	2.56"	3.09"	4.84"
HE-INFIN22	22.17"	2.56"	3.09"	4.84"
HE-INFIN30	30.20"	2.56"	3.09"	4.84"
HE-INFIN40	40.24"	2.56"	3.09"	4.84"
HE-INFIN50	50.12"	2.56"	3.09"	4.84"

SINGLE ROW LED LIGHTBARS

SUPERSLIMLINE SERIES

HE-SS550 **5.5** INCH **3** LED

Wattage: 9W • **Raw Lumens:** 810lm
Current Consumption @ 13.8V: 0.55A • **IP Rating:** IP67



HE-SS9 **9** INCH **6** LED

Wattage: 18W • **Raw Lumens:** 1620lm
Current Consumption @ 13.8V: 1.08A • **IP Rating:** IP67



HE-SS2050 **20.5** INCH **15** LED

Wattage: 45W • **Raw Lumens:** 4050lm
Current Consumption @ 13.8V: 2.80A • **IP Rating:** IP67



HE-SS32 **32** INCH **24** LED

Wattage: 72W • **Raw Lumens:** 6480lm
Current Consumption @ 13.8V: 4.55A • **IP Rating:** IP67



HE-SS3950 **39.5** INCH **30** LED

Wattage: 90W • **Raw Lumens:** 8100lm
Current Consumption @ 13.8V: 5.78A • **IP Rating:** IP67



HE-SS51 **51** INCH **39** LED

Wattage: 117W • **Raw Lumens:** 10530lm
Current Consumption @ 13.8V: 7.60A
IP Rating: IP67





HYBRID



UNIVERSAL



GORE®
MEMBRANE

COMMON FEATURES

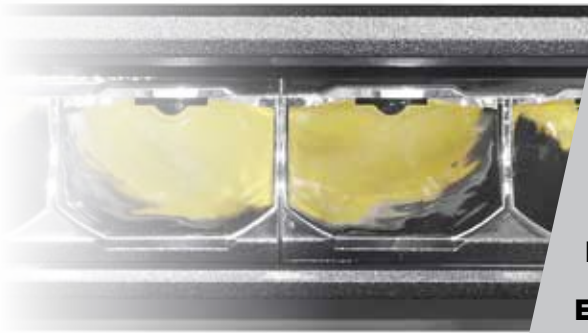

INPUT VOLTAGE: 10-30V DC

COLOR TEMPERATURE: 6000K

BEAM PATTERN: COMBO: 90° FLOOD / 8° SPOT

HOUSING MATERIAL: DIE-CAST ALUMINUM

COLOR: BLACK

MEMBRANE: GORE®

LENS MATERIAL: POLYCARBONATE

MOUNTING BOLT DRILL: 0.25"

ELECTRONICS: INTEGRATED-EPOXY ENCAPSULATED

HARDWARE: STAINLESS 316

OPERATING TEMPERATURE: -40°F TO +140°F

PROTECTION: REVERSE POLARITY

MOUNTING: SIDE & REAR

SPECS & MEASUREMENTS

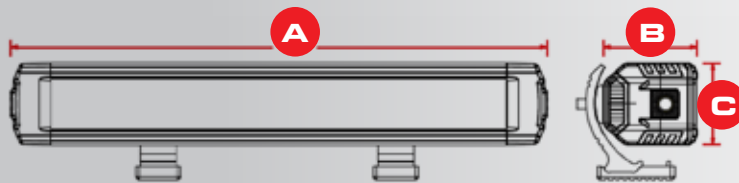

PART	A	B	C
HE-SS550	5.59"	2.05"	1.77"
HE-SS9	9.37"	2.05"	1.77"
HE-SS2050	20.71"	2.05"	1.77"
HE-SS32	32.05"	2.05"	1.77"
HE-SS3950	39.61"	2.05"	1.77"
HE-SS51	50.94"	2.05"	1.77"

SINGLE ROW LED LIGHTBARS

SLIMLINE SERIES

HE-SL550 5.5 INCH 03 LED

Wattage: 9W • Raw Lumens: 720lm • Lux @ 10M: 10
Current Consumption @ 13.8V: 0.4A • IP Rating: IP67



HE-SL914 9.25 INCH 06 LED

Wattage: 18W • Raw Lumens: 1440lm • Lux @ 10M: 22
Current Consumption @ 13.8V: 0.9A • IP Rating: IP67



HE-SL2014 20.25 INCH 15 LED

Wattage: 45W • Raw Lumens: 3600lm • Lux @ 10M: 1280
Current Consumption @ 13.8V: 2.4A • IP Rating: IP67



HE-SL32 32 INCH 24 LED

Wattage: 72W • Raw Lumens: 5760lm • Lux @ 10M: 2200
Current Consumption @ 13.8V: 4.0A • IP Rating: IP67



HE-SL3912 39.5 INCH 30 LED

Wattage: 90W • Raw Lumens: 7200lm • Lux @ 10M: 2920
Current Consumption @ 13.8V: 4.9A • IP Rating: IP67



HE-SL5034 50.75 INCH 39 LED

Wattage: 117W • Raw Lumens: 9360lm • Lux @ 10M: 3250
Current Consumption @ 13.8V: 6.5A • IP Rating: IP67





COMMON FEATURES



INPUT VOLTAGE: 10-30V DC
COLOR TEMPERATURE: 6000K
BEAM PATTERN: COMBO:
 90° FLOOD / 8° SPOT
HOUSING MATERIAL:
 DIE-CAST ALUMINUM
COLOR: BLACK
MEMBRANE: GORE®
LENS MATERIAL: POLYCARBONATE

MOUNTING BOLT DRILL: 0.25"
ELECTRONICS:
 INTEGRATED-EPOXY ENCAPSULATED
HARDWARE: STAINLESS 316
OPERATING TEMPERATURE:
 -40°F TO +140°F
PROTECTION: REVERSE POLARITY
MOUNTING: SIDE & REAR

SPECS & MEASUREMENTS

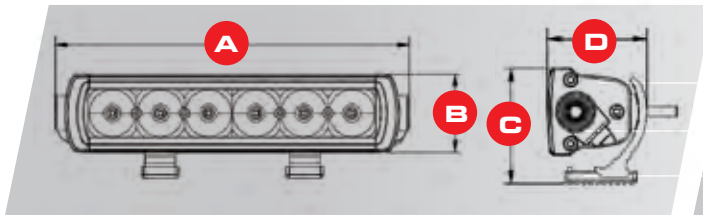

PART	A	B	C	D
HE-SL550	5.51"	2.05"	2.72"	2.32"
HE-SL914	9.29"	2.05"	2.72"	2.32"
HE-SL2014	20.63"	2.05"	2.72"	2.32"
HE-SL32	31.97"	2.05"	2.72"	2.32"
HE-SL3912	39.53"	2.05"	2.72"	2.32"
HE-SL5034	50.87"	2.05"	2.72"	2.32"

SINGLE ROW EDGELESS

SLIMLINE SERIES



MILITARY BREATHER MEMBRANE

HE-TSL20 20 INCH 03 LED

Wattage: 64W • **Raw Lumens:** 5309lm • **Beam Pattern:** 8° Spot
Current Consumption @ 13.8V: 5.33A • **IP Rating:** IP67
Membrane: Military Breather • **Mounting:** Side Only

The Edgeless Slimline lightbar offers a beam pattern that is more focused than previous models with a higher lumen output, as well as having a modern streamline appearance and is void of the traditional look of screws on front of the lightbar without sacrificing durability and/or IP rating.



SPECS & MEASUREMENTS

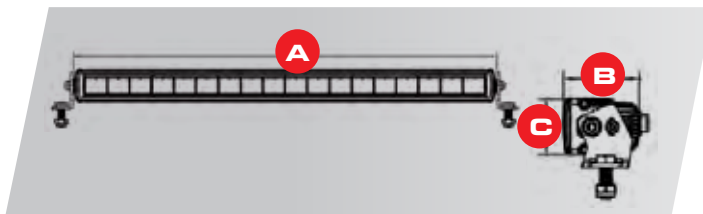

PART	A	B	C
HE-TSL20	19.88"	2.05"	1.52"

DUAL ROW LED LIGHTBARS

HE-DR8 **08** INCH **12** LED **★ IP68 ★ CERTIFIED**

Wattage: 36W • Raw Lumens: 2880lm • Lux @ 10M: 215
 Current Consumption @ 13.8V: 1.9A • IP Rating: IP68



HE-DR14 **14** INCH **24** LED **★ IP68 ★ CERTIFIED**

Wattage: 72W • Raw Lumens: 5760lm • Lux @ 10M: 466
 Current Consumption @ 13.8V: 3.7A • IP Rating: IP68



HE-DR20 **20** INCH **36** LED

Wattage: 108W • Raw Lumens: 8640lm • Lux @ 10M: 612
 Current Consumption @ 13.8V: 5.7A • IP Rating: IP67



HE-DR22 **22** INCH **40** LED

Wattage: 120W • Raw Lumens: 9600lm • Lux @ 10M: 655
 Current Consumption @ 13.8V: 6.3A • IP Rating: IP67



HE-DR30 **30** INCH **60** LED

Wattage: 180W • Raw Lumens: 14400lm • Lux @ 10M: 870
 Current Consumption @ 13.8V: 9.5A • IP Rating: IP67



HE-DR42 **42** INCH **80** LED

Wattage: 240W • Raw Lumens: 19200lm • Lux @ 10M: 1100
 Current Consumption @ 13.8V: 12A • IP Rating: IP67



HE-DR50 **50** INCH **96** LED

Wattage: 288W • Raw Lumens: 23040lm • Lux @ 10M: 2480
 Current Consumption @ 13.8V: 14.3A • IP Rating: IP67





COMMON FEATURES



INPUT VOLTAGE: 10-30V DC

COLOR TEMPERATURE: 6000K

BEAM PATTERN: COMBO: 90° FLOOD / 8° SPOT

HOUSING MATERIAL: DIE-CAST ALUMINUM

COLOR: BLACK

MEMBRANE: GORE®

LENS MATERIAL: POLYCARBONATE

MOUNTING BOLT DRILL: 0.25"

ELECTRONICS: INTEGRATED-EPOXY ENCAPSULATED

HARDWARE: STAINLESS 316

OPERATING TEMPERATURE: -40°F TO +140°F

PROTECTION: REVERSE POLARITY

MOUNTING: SIDE ONLY

SPECS & MEASUREMENTS

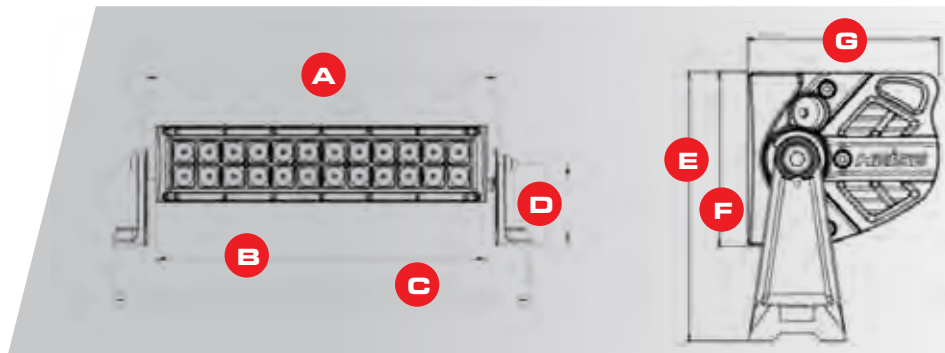

PART	A	B	C	D	E	F	G
HE-DR8	8.07"	7.22"	10.67"	3.23"	4.8"	3.09"	3.41"
HE-DR14	14.09"	13.27"	16.69"	3.23"	4.8"	3.09"	3.41"
HE-DR20	20.12"	19.29"	22.72"	3.23"	4.8"	3.09"	3.41"
HE-DR22	22.13"	21.3"	24.72"	3.23"	4.8"	3.09"	3.41"
HE-DR30	32.17"	31.34"	34.76"	3.23"	4.8"	3.09"	3.41"
HE-DR42	42.09"	41.38"	44.8"	3.23"	4.8"	3.09"	3.41"
HE-DR50	50.12"	49.41"	52.83"	3.23"	4.8"	3.09"	3.41"

DUAL ROW LED LIGHTBARS

CURVED

HE-DRC22 22 INCH 40 LED

Wattage: 120W • **Raw Lumens:** 9600lm • **Lux @ 10M:** 480
Current Consumption @ 13.8V: 6.3A • **IP Rating:** IP67



HE-DRC30 30 INCH 60 LED

Wattage: 180W • **Raw Lumens:** 14400lm • **Lux @ 10M:** 625
Current Consumption @ 13.8V: 9.5A • **IP Rating:** IP67



HE-DRC42 42 INCH 80 LED

Wattage: 240W • **Raw Lumens:** 19200lm • **Lux @ 10M:** 780
Current Consumption @ 13.8V: 12A • **IP Rating:** IP67



HE-DRC50 50 INCH 96 LED

Wattage: 288W • **Raw Lumens:** 23040lm • **Lux @ 10M:** 915
Current Consumption @ 13.8V: 14.3A • **IP Rating:** IP67



H

HYBRID

U

UNIVERSAL

GGORE®
MEMBRANE

COMMON FEATURES

**INPUT VOLTAGE:** 10-30V DC**COLOR TEMPERATURE:** 6000K**BEAM PATTERN:** COMBO: 90° FLOOD / 8° SPOT**HOUSING MATERIAL:** DIE-CAST ALUMINUM**COLOR:** BLACK**MEMBRANE:** GORE®**LENS MATERIAL:** POLYCARBONATE**MOUNTING BOLT DRILL:** 0.25"**ELECTRONICS:** INTEGRATED-EPOXY ENCAPSULATED**HARDWARE:** STAINLESS 316**OPERATING TEMPERATURE:** -40°F TO +140°F**PROTECTION:** REVERSE POLARITY**MOUNTING:** SIDE ONLY

SPECS & MEASUREMENTS

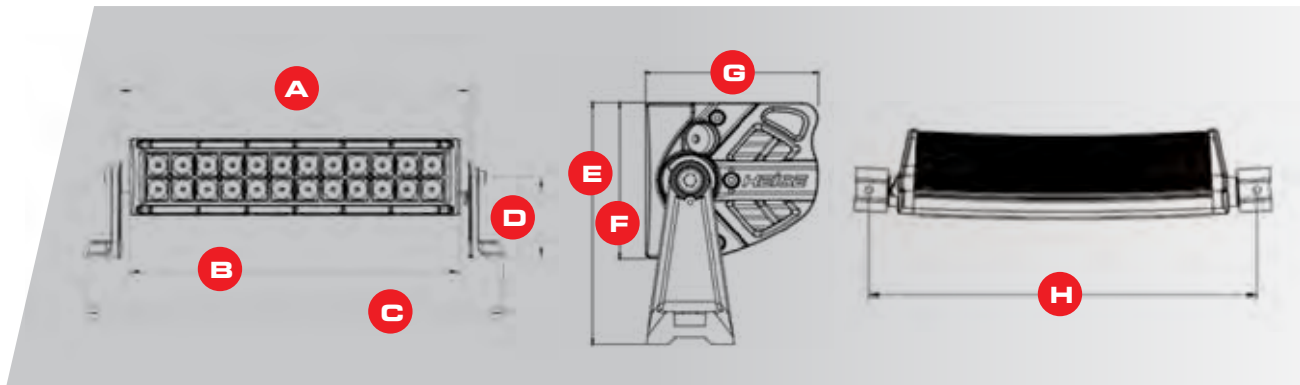

PART	A	B	C	D	E	F	G	H
HE-DRC22	22.32"	21.53"	25.00"	3.23"	4.80"	3.09"	3.86"	23.74"
HE-DRC20	32.22"	31.44"	34.88"	3.23"	4.80"	3.09"	4.39"	33.56"
HE-DRC42	42.09"	41.34"	44.76"	3.23"	4.80"	3.09"	5.14"	43.39"
HE-DRC50	50.12"	49.41"	52.83"	3.23"	4.80"	3.09"	5.91"	51.38"

DUAL ROW LED LIGHTBARS

BLACKOUT SERIES

HE-BDR8 08 INCH 12 LED ★ IP68 ★ CERTIFIED

Wattage: 36W • Raw Lumens: 2880lm • Lux @ 10M: 215
Current Consumption @ 13.8V: 1.9A • IP Rating: IP68



HE-BDR14 14 INCH 24 LED ★ IP68 ★ CERTIFIED

Wattage: 72W • Raw Lumens: 5760lm • Lux @ 10M: 466
Current Consumption @ 13.8V: 3.7A • IP Rating: IP68



HE-BDR20 20 INCH 36 LED

Wattage: 108W • Raw Lumens: 8640lm • Lux @ 10M: 612
Current Consumption @ 13.8V: 5.7A • IP Rating: IP67



HE-BDR22 22 INCH 40 LED

Wattage: 120W • Raw Lumens: 9600lm • Lux @ 10M: 655
Current Consumption @ 13.8V: 6.3A • IP Rating: IP67



HE-BDR30 30 INCH 60 LED

Wattage: 180W • Raw Lumens: 14400lm • Lux @ 10M: 870
Current Consumption @ 13.8V: 9.5A • IP Rating: IP67



HE-BDR42 42 INCH 80 LED

Wattage: 240W • Raw Lumens: 19200lm • Lux @ 10M: 1100
Current Consumption @ 13.8V: 12A • IP Rating: IP67



HE-BDR50 50 INCH 96 LED

Wattage: 288W • Raw Lumens: 23040lm • Lux @ 10M: 2480
Current Consumption @ 13.8V: 14.3A • IP Rating: IP67





HYBRID



UNIVERSAL



GORE®
MEMBRANE

COMMON FEATURES



INPUT VOLTAGE: 10-30V DC

COLOR TEMPERATURE: 6000K

BEAM PATTERN: COMBO: 90° FLOOD / 8° SPOT

HOUSING MATERIAL: DIE-CAST ALUMINUM

COLOR: BLACK

MEMBRANE: GORE®

LENS MATERIAL: POLYCARBONATE

MOUNTING BOLT DRILL: 0.25"

ELECTRONICS: INTEGRATED-EPOXY ENCAPSULATED

HARDWARE: STAINLESS 316

OPERATING TEMPERATURE: -40°F TO +140°F

PROTECTION: REVERSE POLARITY

MOUNTING: SIDE ONLY

SPECS & MEASUREMENTS

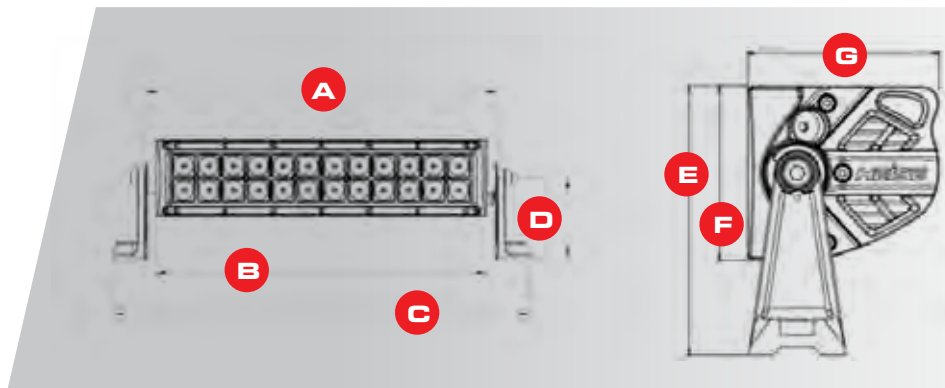

PART	A	B	C	D	E	F	G
HE-BDR8	8.07"	7.22"	10.67"	3.23"	4.80"	3.09"	3.41"
HE-BDR14	14.09"	13.27"	16.69"	3.23"	4.80"	3.09"	3.41"
HE-BDR20	20.12"	19.29"	22.72"	3.23"	4.80"	3.09"	3.41"
HE-BDR22	22.13"	21.3"	24.72"	3.23"	4.80"	3.09"	3.41"
HE-BDR30	32.17"	31.34"	34.76"	3.23"	4.80"	3.09"	3.41"
HE-BDR42	42.09"	41.38"	44.8"	3.23"	4.80"	3.09"	3.41"
HE-BDR50	50.12"	49.41"	52.83"	3.23"	4.80"	3.09"	3.41"

DUAL ROW LED LIGHTBARS

BLACKOUT
SERIES

CURVED

HE-BDRC22 **22** INCH **40** LED

Wattage: 120W • **Raw Lumens:** 9600lm • **Lux @ 10M:** 480
Current Consumption @ 13.8V: 6.3A • **IP Rating:** IP67



HE-BDRC30 **30** INCH **60** LED

Wattage: 180W • **Raw Lumens:** 14400lm • **Lux @ 10M:** 625
Current Consumption @ 13.8V: 9.5A • **IP Rating:** IP67



HE-BDRC42 **42** INCH **80** LED

Wattage: 240W • **Raw Lumens:** 19200lm • **Lux @ 10M:** 780
Current Consumption @ 13.8V: 12A • **IP Rating:** IP67



H
HYBRID

U
UNIVERSAL

G
GORE®
MEMBRANE

COMMON FEATURES



INPUT VOLTAGE: 10-30V DC

COLOR TEMPERATURE: 6000K

BEAM PATTERN: COMBO: 90° FLOOD / 8° SPOT

HOUSING MATERIAL: DIE-CAST ALUMINUM

COLOR: BLACK

MEMBRANE: GORE®

LENS MATERIAL: POLYCARBONATE

MOUNTING BOLT DRILL: 0.25"

ELECTRONICS: INTEGRATED-EPOXY ENCAPSULATED

HARDWARE: STAINLESS 316

OPERATING TEMPERATURE: -40°F TO +140°F

PROTECTION: REVERSE POLARITY

MOUNTING: SIDE ONLY

SPECS & MEASUREMENTS

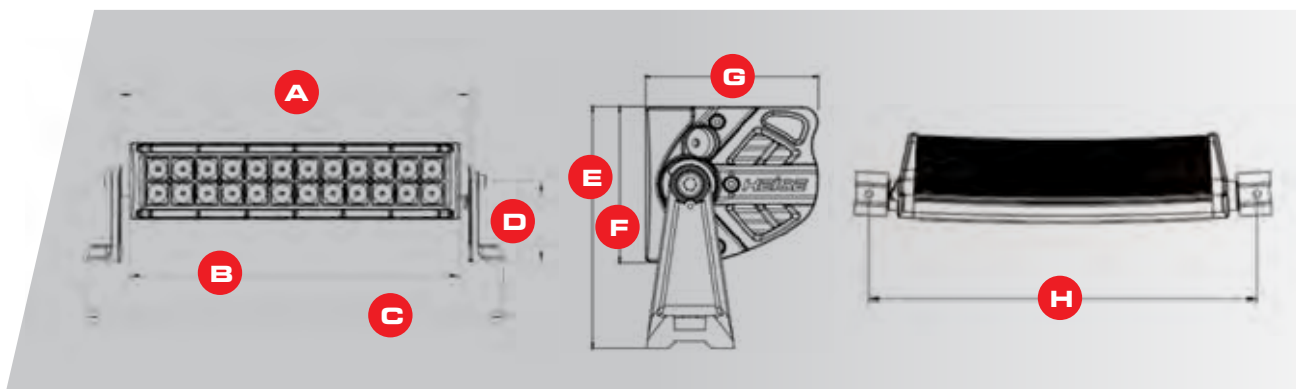

PART	A	B	C	D	E	F	G	H
HR-BDRC22	22.32"	21.53"	25.00"	3.23"	4.80"	3.09"	3.86"	23.74"
HR-BDRC30	32.22"	31.44"	34.88"	3.23"	4.80"	3.09"	4.39"	33.56"
HR-BDRC42	42.09"	41.34"	44.76"	3.23"	4.80"	3.09"	5.14"	43.39"

SINGLE ROW LED LIGHTBARS

CURVED

HE-SRC30 **30** INCH **14** LED

Wattage: 140W • Raw Lumens: 11200lm • Lux @ 10M: 640
 Current Consumption @ 13.8V: 8.6A • IP Rating: IP67



HE-SRC42 **42** INCH **20** LED

Wattage: 200W • Raw Lumens: 16000lm • Lux @ 10M: 785
 Current Consumption @ 13.8V: 11.8A • IP Rating: IP67



SPECS & MEASUREMENTS

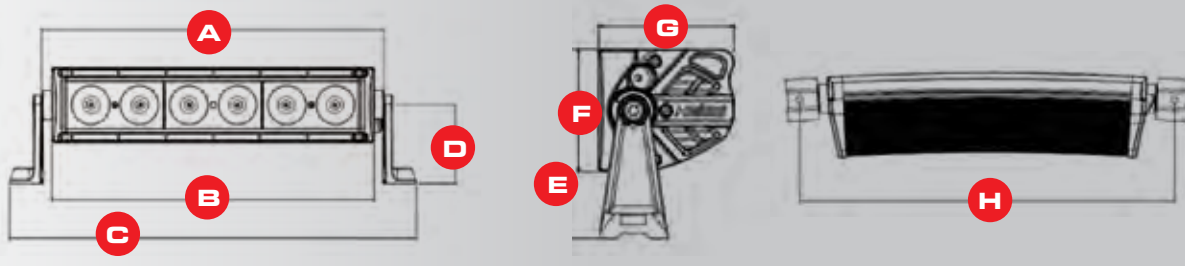

PART	A	B	C	D	E	F	G	H
HE-SRC30	30.31"	29.53"	32.99"	3.23"	4.80"	3.09"	4.19"	31.69"
HE-SRC42	42.09"	41.34"	44.76"	3.23"	4.80"	3.09"	5.14"	43.39"



COMMON FEATURES



INPUT VOLTAGE: 10-30V DC

COLOR TEMPERATURE: 6000K

BEAM PATTERN: COMBO: 120° FLOOD / 10° SPOT

HOUSING MATERIAL: DIE-CAST ALUMINUM

COLOR: BLACK

MEMBRANE: GORE®

LENS MATERIAL: POLYCARBONATE

MOUNTING BOLT DRILL: 0.25"

ELECTRONICS: INTEGRATED-EPOXY ENCAPSULATED

HARDWARE: STAINLESS 316

OPERATING TEMPERATURE: -40°F TO +140°F

PROTECTION: REVERSE POLARITY

MOUNTING: SIDE ONLY

SINGLE ROW LED LIGHTBARS

STRAIGHT

HE-SR22

22 INCH

10 LED

Wattage: 100W • Raw Lumens: 8000lm • Lux @ 10M: 535
Current Consumption @ 13.8V: 5.9A • IP Rating: IP67



SPECS & MEASUREMENTS

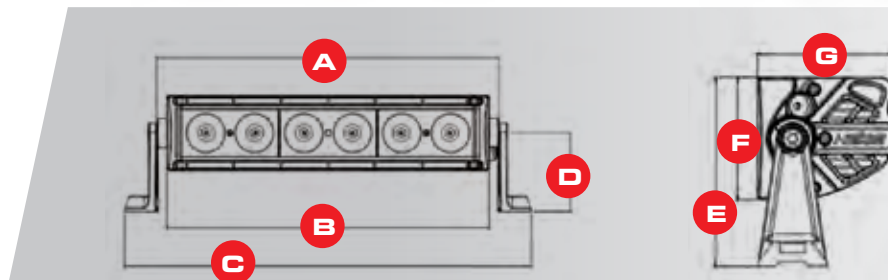

PART	A	B	C	D	E	F	G
HE-SR22	22.13"	21.30"	24.72"	3.23"	4.80"	3.09"	3.41"

TRIPLE ROW LED LIGHTBARS

HE-TR10

10 INCH

20 LED

Wattage: 60W • Raw Lumens: 4800lm • Lux @ 10M: 1296
Current Consumption @ 13.8V: 3.2A • IP Rating: IP67



HE-TR20

20 INCH

40 LED

Wattage: 120W • Raw Lumens: 9600lm • Lux @ 10M: 2573
Current Consumption @ 13.8V: 6.7A • IP Rating: IP67



FAQ

TRIPLE ROW SERIES

1. Can the feet be turned inwards? **No**
2. Does the three row design cause more wind noise? **No, it's actually 4db quieter than some of the other models**
3. What is the minimum and maximum voltage of the lightbars? **10 to 30 volts**



HYBRID



UNIVERSAL



GORE®
MEMBRANE

COMMON FEATURES



INPUT VOLTAGE: 10-30V DC

COLOR TEMPERATURE: 6000K

BEAM PATTERN: COMBO: 90° FLOOD / 8° SPOT

HOUSING MATERIAL: DIE-CAST ALUMINUM

COLOR: BLACK

MEMBRANE: GORE®

LENS MATERIAL: POLYCARBONATE

MOUNTING BOLT DRILL: 0.25"

ELECTRONICS: INTEGRATED-EPOXY ENCAPSULATED

HARDWARE: STAINLESS 316

OPERATING TEMPERATURE: -40°F TO +140°F

PROTECTION: REVERSE POLARITY

MOUNTING: SIDE ONLY

SPECS & MEASUREMENTS

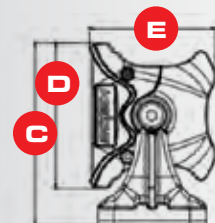
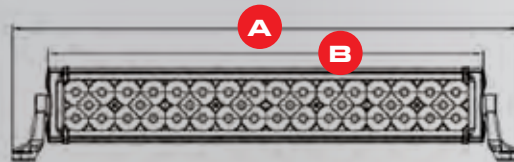

PART	A	B	C	D	E
HE-TR10	14.86"	11.61"	4.52"	3.60"	3.10"
HE-TR20	24.67"	21.43"	4.52"	3.60"	3.10"

WIRING HARNESSES

HE-SLWH2

1 LAMP

UNIVERSAL

ATP WIRING HARNESS & SWITCH KIT

- Universal wiring harness & switch kit (for 1 lamp, ATP connector)
- Universal plug-n-play wiring harness with on/off rocker switch
- 12V DC relay
- 30A fuse
- Use with 1 Heise light 160 watts or more
- 9ft switch cable
- 9ft light cable



HE-SLWH1

1 LAMP

UNIVERSAL

DT WIRING HARNESS & SWITCH KIT

- Universal wiring harness & switch kit (for 1 lamp, DT connector)
- Universal plug-n-play wiring harness with on/off rocker switch
- 12V DC relay
- 30A fuse
- Use with 1 Heise light 150 watts or less
- 9ft switch cable
- 9ft light cable



HE-DLWH1

2 LAMP

UNIVERSAL

WIRING HARNESS & SWITCH KIT

- Universal plug-n-play wiring harness with on/off rocker switch
- 12V DC relay
- 30A fuse
- 2-pin DT connectors for 2 lamps
- Water-resistant fuse holder
- Set includes wiring harness & switch
- Easy installation
- Use with 2 Heise lights 150 watts each or less
- 9ft switch cable
- 9ft light cable



HE-WRRK

WIRELESS REMOTE CONTROL

WIRELESS RELAY HARNESS

- 9-function RF remote
- No need to run wires into the vehicle
- Simple 2-wire connection
- Sealed control box can be mounted in engine compartment
- Use with any Heise lightbar, driving light or work light



HE-EYHK

Y ADAPTER

HARNESS KIT

- Use with the HE-WRRK
- Allows two heise lightbars, driving lights or work lights 240 watts or less



HE-DTSPLIT

150 WATT

CONNECTOR

- Connects two lights into one connector to make wiring easier and neater
- Use two lights or lightbars with 150 watts total or less and add our Heise wiring harness (HE-SLWH1 - sold separately) for a plug and play solution
- Length end to end: 22 inches



WIRING HARNESSSES



HE-SWP8

8 GANG

SWITCH PANEL

SPECS

- Input voltage: 12V-24V
- Power handling: 600-1200W
- Maximum current: 60A
- Panel material: Die-cast aluminum
- Switched or momentary operation
- Control box material: Die-cast aluminum
- Control box cover: ABS plastic
- Operating temperature: - 40° F to 302° F
- Panel size: 4.53"x 0.59"x 2.60"
- Circuit box size: 7.48"x 1.34"x 4.13"
- 50 custom label decals



HE-SWP8C

8 GANG

FLUSH MOUNT SWITCH PANEL CASE

NEW!

SPECS

- Fits HE-SWP8 switch panel
- Switch panel screws securely to the case box
- Included snap on trim plate for a clean installation
- Cut template and mounting hardware included



WIRING HARNESS ACCESSORIES

HE-WRC

WIRELESS REMOTE

HARNESS CONTROLLER

SPECS

- Frequency: 433MHZ
- Effective distance: 50m

FUNCTIONS

- On/off model
- 9 flash patterns
- SOS emergency mode
- Simple plug-n-play connection
- Rocker switch from Heise wiring harness and plug-in remote control interface box



HE-BRS

5 PACK

BLUE ROUND ROCKER SWITCH

- 20 amp
- Rubber cover helps protect switch from dust and water intrusion
- Illuminates blue



HE-RRS

5 PACK

RED ROUND ROCKER SWITCH

- 20 amp
- Rubber cover helps protect switch from dust and water intrusion
- Illuminates red



HE-ATPPIGTAIL

10 PACK

WITH WIRE

ATP CONNECTORS

- For lightbars 150-300 watts



HE-ATPLUG

10 PACK

WITH WIRE

ATP CONNECTORS

- For lightbars 150-300 watts



WIRING HARNESS ACCESSORIES

HE-ATP3PIGTAIL

10 PACK

WITH WIRE

ATP CONNECTORS

- For lightbars 180-300 watts



HE-DTPIGTAIL

10 PACK

WITH WIRE

DT CONNECTORS

- For lightbars up to 150 watts



HE-DTPLUG

10 PACK

WITH WIRE

DT CONNECTORS

- For lightbars up to 150 watts



HE-DT3PIGTAIL

10 PACK

WITH WIRE

DT CONNECTORS

- For lightbars up to 180 watts



HE-DT3PLUG

10 PACK

WITH WIRE

DT CONNECTORS

- For lightbars up to 180 watts



ANTI-THEFT LOCK KITS

HE-ATB

6 PIECES

FOR HEISE LIGHTBARS

For the original single and dual-row lightbars (straight and curved), the Blackout series lightbars and the Marine series lightbars. Included are (2) M8 x 16mm stainless steel anti-theft T-40 Torx bolts that screw into the lightbar itself where the mounting bracket attaches to the bar, a TT-40 anti-theft Torx bit, (2) M6 x 25mm stainless steel anti-theft T-27 Torx bolts that bolt the mounting bracket to the mounting surface (you still need to use the lock nuts that are supplied with the lightbar), and a TT-27 anti-theft Torx bit.



LIGHTBAR LENS COVERS

SLIMLINE SERIES

HE-SLLBC1

HE-SLLBC2

PROTECTIVE LIGHT COVER

- Polycarbonate protective lens

SLIMLINE SERIES LIGHTBARS AND HE-WL1 WORK LIGHT

HE-WL1	Use (1) HE-SLLBC1 Cover
HE-SL550	Use (1) HE-SLLBC1 Cover
HE-SL914	Use (1) HE-SLLBC2 Cover
HE-SL2014	Use (5) HE-SLLBC1 Covers
HE-SL32	Use (4) HE-SLLBC2 Covers
HE-SL3912	Use (5) HE-SLLBC2 Covers
HE-SL5034	Use (1) HE-SLLBC1 and (6) HE-SLLBC2 Covers



TRIPLE ROW LENS COVERS

HE-TRBLC1

HE-TRBLC2

PROTECTIVE LIGHT COVER

- Polycarbonate protective lens

THREE ROW STRAIGHT LIGHTBARS

HE-TR10	Use (1) HE-TRLBC1 and (1) HE-TRLBC2 Covers
HE-TR20	Use (2) HE-TRLBC1 and (2) HE-TRLBC2 Covers



LIGHTBAR LENS COLORED COVERS

AMBER	HE-SLC1A	6 INCH	PROTECTIVE LENS COVER	
BLACK	HE-SLC1BK		<ul style="list-style-type: none"> • Polycarbonate protective lens covers for Heise lightbars • 2 sizes can be combined together to suit straight lightbars • 6 colors available 	
CLEAR	HE-SLC1C			
RED	HE-SLC1R			
GREEN	HE-SLC1G			
BLUE	HE-SLC1BL			
SINGLE ROW STRAIGHT LIGHTBARS				
	HE-SR22		Use (2) HE-SLC1 and (1) HE-SLC2 Cover	
DUAL ROW STRAIGHT LIGHTBARS				
	HE-DR8	HE-BDR8	Use (1) HE-SLC1 Cover	
	HE-DR14	HE-BDR14	Use (2) HE-SLC1 Covers	
	HE-DR20	HE-BDR14	Use (2) HE-SLC1 Covers	
	HE-DR22	HE-BDR22	Use (2) HE-SLC1 and (1) HE-SLC2 Cover	
	HE-DR28	HE-BDR30	Use (5) HE-SLC1 Covers	
	HE-DR30	HE-BDR30	Use (5) HE-SLC1 Covers	
	HE-DR42	HE-BDR42	Use (4) HE-SLC1 and (2) HE-SLC2 Covers	
	HE-DR50	HE-BDR50	Use (8) HE-SLC1 Covers	



NOTE: Curved Lightbar Covers are not available

AMBER	HE-SLC2A	8 INCH	PROTECTIVE LENS COVER	
BLACK	HE-SLC2BK		<ul style="list-style-type: none"> • Polycarbonate protective lens covers for Heise lightbars • 2 sizes can be combined together to suit straight lightbars • 6 colors available 	
CLEAR	HE-SLC2C			
RED	HE-SLC2R			
GREEN	HE-SLC2G			
BLUE	HE-SLC2BL			



NOTE: Curved Lightbar Covers are not available

REPLACEMENT BRACKETS

HE-RMBK

REPLACEMENT

MOUNTING BRACKETS

- Replacement mounting brackets and hardware for DR, DRC, BDR, BDRC, SR and SRC Series Heise lightbars



HE-RSLBK

REPLACEMENT

MOUNTING BRACKETS

- Replacement mounting brackets and hardware for SLIMLINE Series Heise lightbars



DAMPERS

HE-LBD

4 PACK

LIGHTBAR DAMPERS

- Reduces vibration noise from lightbars
- Use with DR, DRC, BDR, BDRC, SR and SRC Series Heise lightbars
- Friction fit in place
- 4db noise reduction

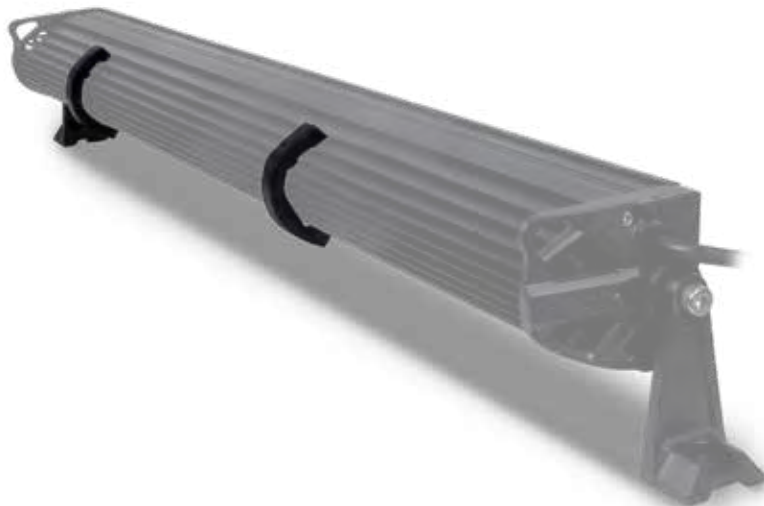



**BRACKETS &
MOUNTS**



**BRACKETS &
MOUNTS**

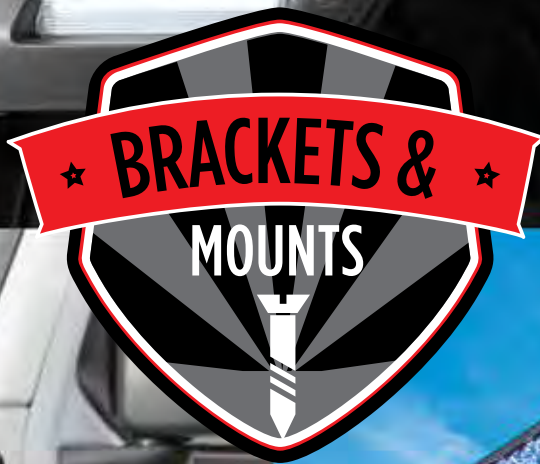

BRACKETS FITS CHEVY/GMC

Comes with instructions and hardware

SILVERADO | SIERRA
1500 **1999-2006**

SILVERADO | SIERRA
"CLASSIC" **2007**

SILVERADO | SIERRA
2500/3500 **2001-2006**

SUBURBAN | TAHOE | YUKON
2000-2006

HE-GMBK1

- Designed for 54" curved lightbar



HE-GMBK2

- Designed for 50" curved lightbar



SILVERADO | SIERRA
1500 **2007-2013**

SILVERADO | SIERRA
2500/3500 **2007-2014**

AVALANCHE | SUBURBAN | TAHOE | YUKON
YUKON XL **2007-2013**

HE-GMBK5

- Designed for 50" curved lightbar



HE-GMBK6

- Designed for 50" straight lightbar



SILVERADO | SIERRA **1500 2007-2013**
SILVERADO | SIERRA **2500/3500 2007-2014**
AVALANCHE | SUBURBAN | TAHOE
YUKON | YUKON XL **2007-2013**

HE-GMBK4

- Designed for 54" curved lightbar



SILVERADO | SIERRA **1500 2014-2018**
SILVERADO | SIERRA **2500/3500 2015-2018**

HE-GMBK8

- Designed for 50" curved lightbar



SILVERADO | SIERRA
1500 2014-2015
SILVERADO | SIERRA
2500 2015-2016

HE-GMBK9

- Designed for 50" straight lightbar



COLORADO
1500 2015-2018

HE-GMBK10

- Designed for 30" straight lightbar
- Hidden bumper mount



SILVERADO | SIERRA
1500 2007-2013

HE-GMBK11

- Designed for 20" straight lightbar
- Hidden bumper mount



BRACKETS FITS DODGE

Comes with instructions and hardware

RAM 1500 **2002-2008**

RAM 2500/3500 **2003-2009**

HE-DGBK1

- Designed for 54" curved lightbar



RAM 1500 **2002-2008**

RAM 2500/3500 **2003-2009**

HE-DGBK2

- Designed for 50" straight lightbar



RAM 1500/2500/3500

2009-2015

HE-DGBK4

- Designed for 50" curved lightbar



RAM 2500/3500 **2010-2014**

HE-DGBK5

- Designed for 20" straight lightbar
- Hidden bumper mount



RAM 2500/3500 **2003-2009**

HE-DGBK6

- Designed for 20" straight lightbar
- Hidden bumper mount



FITS TOYOTA

Comes with Instructions and Hardware

TACOMA **2005-2015**

HE-TOBK1

- Designed for 30" straight lightbar
- Hidden bumper mounts



BRACKETS FITS FORD

Comes with instructions and hardware

F-150 **2004-2014**

HE-FDBK1

- Designed for 54" curved lightbar



SUPERDUTY **1999-2014**

HE-FDBK2

- Designed for 54" curved lightbar



F-250/350 **1999-2016**

HE-FDBK4

- Designed for 50" curved lightbar



F-250/350/450 **2011-2015**

HE-FDBK9

- Designed for 20" straight lightbar
- Hidden bumper mount



F-150 **2009-2014**

HE-FDBK10

- Designed for 30" straight lightbar
- Grille mount



F-150 **2010-2014**

HE-FDBK11

- Cube fog light bracket
- For 2 sets of cube lights

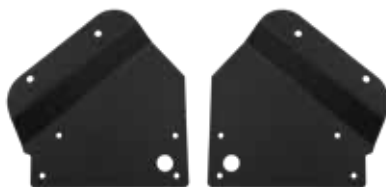

F-150 **2006-2008**

HE-FDBK12

- Designed for 20" straight lightbar
- Hidden bumper mount



RAPTOR **2017-UP**

HE-FDBK13 **NEW!**

- Mount to OE fog light location
- Accepts 3 cube lights per side (6 lights total)



BRACKETS FITS JL JEEP WRANGLER

5-gauge, powder coated steel and includes gaskets and mounting hardware

JL 2018-UP* JP-JFOG FOG LIGHT BRACKET

- Fits: 2018 - up* Jeep Wrangler JL Rubicon
2009- 2018 Jeep Wrangler JK Hard Rock, Rubicon X,
10th Anniversary Edition



JL 2018-UP* JP-JFOG2 FOG LIGHT BRACKET **NEW!**

- Fits: 2018 - UP* Jeep Wrangler JL Sport
- Mounts with factory hardware
- Converts any JP-xxx 4" fog light to a direct bolt-on
- ABS constructed brackets are marked Left, Right and Top for easier orientation



JL 2018-UP* JP-JLB7 7" LED HEADLIGHT ADAPTER

- Allows 7" LED headlights to fit into Jeep Wrangler JL 2018-up* models
- Includes factory to H4 wiring adapters
- Solid steel construction
- 3 points of beam adjustment
- Gaskets included
- Sold as a set of 2 brackets with 2 harnesses
- Headlights sold separately



JL 2018-UP JP-JLAPB PILLAR LIGHT BRACKET

- Designed for 50" straight lightbar
- 2 post mounts for cubes or work lights
- Anti-sway stabilization hardware



JL 2018-UP JP-JLPLMB POST MOUNT BRACKET

- Fits a cube, work or driving light
- Mount cubes on top and sides
- 6 different mounting locations



BRACKETS FITS JK JEEP WRANGLER

7-gauge (excluding JP-JFOG), powder coated steel and includes gaskets and mounting hardware

JK 2007-2018 JP-JFOG FOG LIGHT BRACKET

- Fits: 2018 - up* Jeep Wrangler JL Rubicon
2009- 2018 Jeep Wrangler JK Hard Rock, Rubicon X,
10th Anniversary Edition



JK 2007-2018 JP-JKGR1 GRILLE MOUNT

- Designed for 20" straight lightbar



BRACKETS FITS JK JEEP WRANGLER

7-gauge, powder coated steel and includes gaskets and mounting hardware

JK 2007-2018

JP-JKHM1

HOOD MOUNT BRACKET

- Designed for 10" straight lightbar



JK 2007-2018

JP-JKHM2

HOOD MOUNT BRACKET

- Designed for 20" lightbar



JK 2007-2018

JP-JKHM03

HOOD BRACKET

- Mount location for 4 cube lights



JK 2007-2018

JP-JKHMB

HOOD MOUNT BRACKET

- Designed for 22" straight lightbar

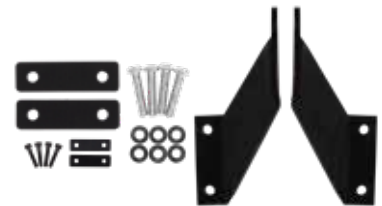

JK 2007-2018

JP-JKPLMB

POST MOUNT BRACKET

- Fits a cube, work or driving light



JK 2007-2018

JP-JKPMWS

POST MOUNT CUBE BRACKET

- Fits a cube, work or driving light



JK 2007-2018

JP-JKPM2

DUAL STACKED POST MOUNT

- Fits a cube, work or driving light



JK 2007-2018

JP-JKWIP

WHIP MOUNT BRACKET

- Mount 1 LED whip light or CB/HAM radio antenna mount to spare wheel carrier



JK 2007-2018

JP-JKAPB

A-PILLAR BRACKET

- Designed for 50" straight lightbar



BRACKETS FITS TJ JEEP WRANGLER

7-gauge, powder coated steel and includes gaskets and mounting hardware

TJ 1997-2006

JP-TJHMB

HOOD MOUNT BRACKET

- Designed for 22" straight lightbar



TJ 1997-2006

JP-TJPMLB

POST MOUNT BRACKET

- Fits a cube, work or driving light



TJ 1997-2006

JP-TJAPB

A-PILLAR BRACKET

- Designed for 50" straight lightbar



BRACKETS FITS YJ JEEP WRANGLER

YJ 1987-1995

JP-YJAPB

A-PILLAR BRACKET

- Designed for 50" straight lightbar



YJ 1987-1995

JP-YJPMLB

POST MOUNT BRACKET

- Fits a cube, work or driving light



UNIVERSAL MOUNTS

FOR US MARKET

HE-FLPUS

- Designed for front license plate
- Mounts a cube, work or driving light



FOR EUROPEAN MARKET

HE-FLPEU

- Designed for front license plate bracket
- Mounts a cube, work or driving light



MAGNET MOUNT

HE-UVMM

NEW!

- Ultra strong magnetic mount
- Mount 1 light per bracket or use set to mount a lightbar



HOOD MOUNT

HE-UVHM







NEW!

- No drill compression mount
- Mount 1 light per bracket or use set to mount a slim lightbar
- Rubber pad built onto bracket to protect vehicle's paint



ROLL BAR MOUNTS

Black plated aluminum to be attractive and strong • Use with lightbars, driving and work lights
 • Rubber gasket Included to protect the roll bar • Allen keys Included • Bulk parts are available

HE-RBM75 .75 INCH 2 PACK 	HE-RBM1 1 INCH 2 PACK 	HE-RBM125 1.25 INCH 2 PACK 
HE-RBM150 1.5 INCH 2 PACK 	HE-RBM175 1.75 INCH 2 PACK 	HE-RBM2 2 INCH 2 PACK 
HE-RBM225 2.25 INCH 2 PACK 	HE-RBM250 2.5 INCH 2 PACK 	HE-RBM3 3 INCH 2 PACK 

BULK 10 PACK

HE-RBMB	ROLL BAR MOUNT BODY	HE-RBC125	1.25" ROLL BAR CLAMPS	HE-RBC2	
HE-RBC1	1" ROLL BAR CLAMPS	HE-RBC150	1.5" ROLL BAR CLAMPS	HE-RBC3	2" ROLL BAR CLAMPS

POWERSPORTS BRACKETS & MOUNTS

UNIVERSAL ROLL BAR MOUNT

• Multiple applications • Powder coat black • Rubber insert

MPS-C02 3 INCH 	MPS-C03 1.5 INCH 	MPS-C04 2 INCH 
---	---	---

POWERSPORTS BRACKETS & MOUNTS



MPS-B01 8 INCH

UNIVERSAL LIGHTBAR BRACKET



MPS-B02 22 INCH

UNIVERSAL LIGHTBAR BRACKET



MPS-B03 32 INCH

UNIVERSAL LIGHTBAR BRACKET



MPS-B05 2011-2014 POLARIS RZR 900

SIDE PILLAR LIGHT BRACKET

- Fits cube and round work lights
- 2"-4" spot
- Sold as pair



MPS-B06 HONDA | POLARIS | YAMAHA

SIDE PILLAR LIGHT BRACKET

- Sold as pair



MPS-B07 2016-UP YAMAHA YXZ 1000R

SIDE PILLAR LIGHT BRACKET

- 2"-4" spot
- Sold as pair



MPS-B08 YAMAHA YXZ 1000R

ROOF LIGHT BRACKET

- 40"-42" spot
- Sold as pair



MPS-B09 HONDA | POLARIS | YAMAHA

ROLL CAGE LIGHTBAR BRACKET

- Holds 30"-32"
- Sold as pair



MPS-B10 2013-2020 CAN-AM MAVERICK X3

ROLL CAGE LIGHTBAR BRACKET

- Sold as pair



MPS-B11 2014-UP POLARIS RZR XP 1000 900 800

DUAL LIGHT POD

- Sold as pair



CUBE LIGHTS



CUBE LIGHTS



HIGH OUTPUT CUBE LED LIGHTS

HE-HCL140 **4** INCH **15** LED

HE-HCL1402PK **4** INCH **15** LED 2 LIGHT PACK

Wattage: 30W • **Raw Lumens:** 2850lm • **Lux @ 10M:** 122
IP Rating: IP67 • **Beam Pattern:** 140° Flood/15° Spot
Current Consumption @ 13.8V: 2.2A

Heise HE-DLWH1 dual light wiring harness included

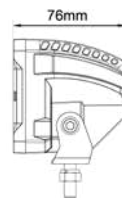

HE-HCL22PK **3** INCH **4** LED 2 LIGHT PACK

Wattage: 12W • **Raw Lumens:** 960lm • **Lux @ 10M:** 32
IP Rating: IP68 • **Beam Pattern:** 90° Flood
Current Consumption @ 13.8V: 0.7A

Heise HE-DLWH1 dual light wiring harness included

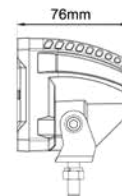

HE-HCL2S2PK **3** INCH **4** LED 2 LIGHT PACK

Wattage: 12W • **Raw Lumens:** 960lm • **Lux @ 10M:** 380
IP Rating: IP68 • **Beam Pattern:** 8° Spot
Current Consumption @ 13.8V: 0.7A

Heise HE-DLWH1 dual light wiring harness included

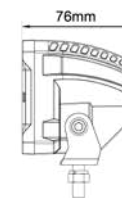

ACCENT CAPS

Customize your lights with included color accent caps!



PIGTAIL

Included with all high output cube LED lights

HIGH OUTPUT CUBE LED LIGHTS

HE-HCL3

3 INCH

6 LED

HE-HCL32PK

3 INCH

6 LED

2 LIGHT PACK

Wattage: 18W • **Raw Lumens:** 1440lm • **Lux @ 10M:** 32 • **IP Rating:** IP68
Beam Pattern: 90° Flood • **Current Consumption @ 13.8V:** 1.1A

Heise HE-DLWH1 dual light wiring harness included

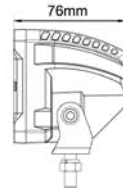

HE-HCL3S2PK

3 INCH

6 LED

2 LIGHT PACK

Wattage: 18W • **Raw Lumens:** 1440lm • **Lux @ 10M:** 416
IP Rating: IP68 • **Beam Pattern:** 8° Spot
Current Consumption @ 13.8V: 1.1A

Heise HE-DLWH1 dual light wiring harness included

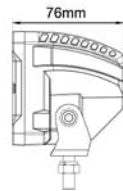

COMMON FEATURES

INPUT VOLTAGE: 10-30V DC

COLOR TEMPERATURE: 6000K

HOUSING MATERIAL: DIE-CAST ALUMINUM

COLOR: DARK GREY

LENS MATERIAL: PC

MOUNTING BRACKET: STAINLESS STEEL

ELECTRONICS: INTEGRATED-EPOXY ENCAPSULATED

HARDWARE: STAINLESS 316

OPERATING TEMPERATURE: -40°F TO +140°F

PROTECTION: REVERSE POLARITY

INFINITE CUBE LED LIGHTS

HE-ICL2 **3** INCH **4** LED



HE-ICL2PK **3** INCH **4** LED 2 LIGHT PACK

Wattage: 13W • **Raw Lumens:** 1080lm • **Lux @ 10M:** 411
Current Consumption @ 13.8V: 0.9A • **IP Rating:** IP67



Heise HE-DLWH1 dual light wiring harness included

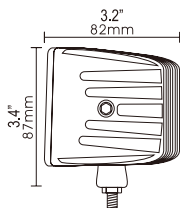

NEW! **RGB-CB1**
CONTROL BOX

Required for RGB functionality on all Infinite Series lights.
(Sold separately)

COMMON FEATURES

INPUT VOLTAGE: 10-30V DC

COLOR TEMPERATURE: 6000K

BEAM PATTERN: 8° SPOT

HOUSING MATERIAL: DIE-CAST ALUMINUM

COLOR: BLACK

LENS MATERIAL: PC

MOUNTING BRACKET: STAINLESS STEEL

ELECTRONICS: INTEGRATED-EPOXY ENCAPSULATED

HARDWARE: STAINLESS 316

OPERATING TEMPERATURE: -40°F TO +140°F

PROTECTION: REVERSE POLARITY

HE-BCL2

3 INCH

4 LED

HE-BCL22PK

3 INCH

4 LED

2 LIGHT PACK

Wattage: 12W • **Raw Lumens:** 960lm • **Lux @ 10M:** 17 • **IP Rating:** IP68
Beam Pattern: 90° Flood • **Current Consumption @ 13.8V:** 0.9A

Heise HE-DLWH1 dual light wiring harness included

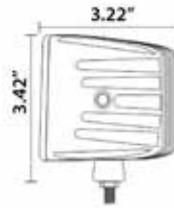

HE-BCL2S

3 INCH

4 LED

HE-BCL2S2PK

3 INCH

4 LED

2 LIGHT PACK

Wattage: 12W • **Raw Lumens:** 960lm • **Lux @ 10M:** 205 • **IP Rating:** IP68
Beam Pattern: 5° Spot • **Current Consumption @ 13.8V:** 0.9A

Heise HE-DLWH1 dual light wiring harness included

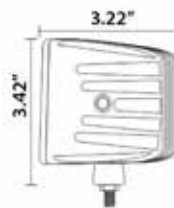

PIGTAIL

Included with all high output cube LED lights

COMMON FEATURES

INPUT VOLTAGE: 10-30V DC

COLOR TEMPERATURE: 6000K

HOUSING MATERIAL: DIE-CAST ALUMINUM

COLOR: BLACK

LENS MATERIAL: PC

MOUNTING BRACKET: STAINLESS STEEL

ELECTRONICS: INTEGRATED-EPOXY ENCAPSULATED

HARDWARE: STAINLESS 316

OPERATING TEMPERATURE: -40°F TO +140°F

PROTECTION: REVERSE POLARITY

CUBE LED LIGHTS

HE-CL1 **2** INCH **1** LED

Wattage: 10W • **Raw Lumens:** 600lm • **Lux @ 10M:** 12
IP Rating: IP68 • **Beam Pattern:** 40° Flood
Current Consumption @ 13.8V: 0.7A



HE-CL22PK **3** INCH **4** LED 2 LIGHT PACK

Wattage: 12W • **Raw Lumens:** 960lm • **Lux @ 10M:** 17 • **IP Rating:** IP68
Beam Pattern: 90° Flood • **Current Consumption @ 13.8V:** 0.9A

Heise HE-DLWH1 dual light wiring harness included

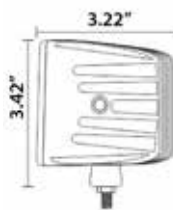

HE-CL2S2PK **3** INCH **4** LED 2 LIGHT PACK

Wattage: 12W • **Raw Lumens:** 960lm • **Lux @ 10M:** 205 • **IP Rating:** IP68
Beam Pattern: 5° Spot • **Current Consumption @ 13.8V:** 0.9A

Heise HE-DLWH1 dual light wiring harness included

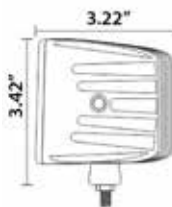

COMMON FEATURES

INPUT VOLTAGE: 10-30V DC

COLOR TEMPERATURE: 6000K

HOUSING MATERIAL: DIE-CAST ALUMINUM

COLOR: BLACK

LENS MATERIAL: PC

MOUNTING BRACKET: STAINLESS STEEL

ELECTRONICS: INTEGRATED-EPOXY ENCAPSULATED

HARDWARE: STAINLESS 316

OPERATING TEMPERATURE: -40°F TO +140°F

PROTECTION: REVERSE POLARITY

CUBE LED LIGHTS

HE-CL3 **3** INCH **6** LED

HE-CL32PK **3** INCH **6** LED 2 LIGHT PACK

Wattage: 18W • **Raw Lumens:** 1440lm • **Lux @ 10M:** 18 • **IP Rating:** IP68
Beam Pattern: 90° Flood • **Current Consumption @ 13.8V:** 1.2A

Heise HE-DLWH1 dual light wiring harness included

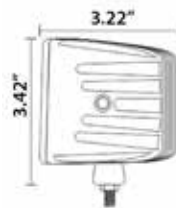

HE-CL3S2PK **3** INCH **6** LED 2 LIGHT PACK

Wattage: 18W • **Raw Lumens:** 1440lm • **Lux @ 10M:** 350
IP Rating: IP68 • **Beam Pattern:** 5° Spot
Current Consumption @ 13.8V: 1.2A

Heise HE-DLWH1 dual light wiring harness included

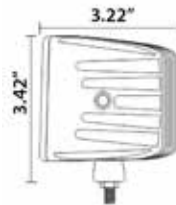

COMMON FEATURES

INPUT VOLTAGE: 10-30V DC

COLOR TEMPERATURE: 6000K

HOUSING MATERIAL: DIE-CAST ALUMINUM

COLOR: BLACK

LENS MATERIAL: PC

MOUNTING BRACKET: STAINLESS STEEL

ELECTRONICS: INTEGRATED-EPOXY ENCAPSULATED

HARDWARE: STAINLESS 316

OPERATING TEMPERATURE: -40°F TO +140°F

PROTECTION: REVERSE POLARITY

FLUSH MOUNT CUBE LED LIGHTS

HE-FMCL2

3 INCH

4 LED

Wattage: 12W • **Raw Lumens:** 960lm • **Lux @ 10M:** 17
IP Rating: IP68 • **Beam Pattern:** 90° Flood
Current Consumption @ 13.8V: 0.9A

Includes gasket and cut out template

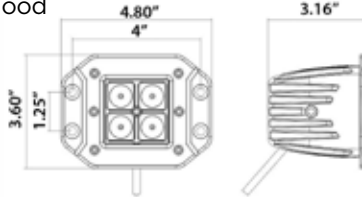

HE-BFMCL2

3 INCH

4 LED

BLACKOUT
SERIES

Wattage: 12W • **Raw Lumens:** 960lm • **Lux @ 10M:** 17
IP Rating: IP68 • **Beam Pattern:** 90° Flood
Current Consumption @ 13.8V: 0.9A

Includes gasket and cut out template

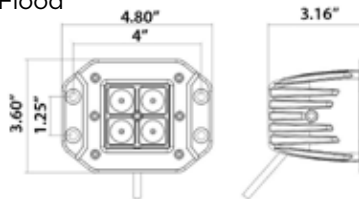

HE-FMCL3

3 INCH

6 LED

Wattage: 18W • **Raw Lumens:** 1440lm • **Lux @ 10M:** 18
IP Rating: IP68 • **Beam Pattern:** 90° Flood
Current Consumption @ 13.8V: 1.2A

Includes gasket and cut out template

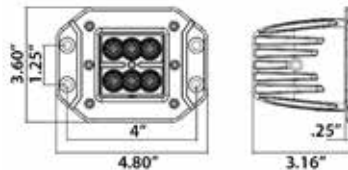

ACCESSORIES INCLUDED

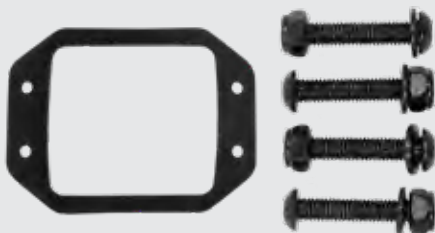

GASKET & SCREWS

Included with all flush mount cube LED lights

COMMON FEATURES

INPUT VOLTAGE: 10-30V DC

COLOR TEMPERATURE: 6000K

HOUSING MATERIAL: DIE-CAST ALUMINUM

COLOR: DARK GREY

LENS MATERIAL: PC

MOUNTING BRACKET: FLUSH MOUNT

ELECTRONICS: INTEGRATED-EPOXY ENCAPSULATED

HARDWARE: STAINLESS 316

OPERATING TEMPERATURE: -40°F TO +140°F

PROTECTION: REVERSE POLARITY

COLORED LENS COVERS CUBE

AMBER

HE-CLLA

CUBE

PROTECTIVE LENS COVER

BLACK

HE-CLL BK

CLEAR

HE-CLLC

RED

HE-CLLR

GREEN

HE-CLLG

BLUE

HE-CLLBL

- Polycarbonate protective lens
- Use with HE-CL2, HE-CL3, HE-CL22PK, HE-CL32PK, HE-CL2S, HE-CL2SA, HE-CL3S, HE-CL3SA, HE-BCL2, HE-BCL2S, HE-BCL22PK, HE-BCL2S2PK, HE-MCL2, HE-MCL3, HE-MCL22PK, HE-MCL32PK
- NOTE: Not for use with the high output cubes
- 6 colors available



FAQ

STANDARD CUBES

1. Does the flush mount come with a template? **YES, it does**
2. Are they available in different patterns? **YES, they are available in a spot or flood pattern**

HIGH OUTPUT CUBES

1. Are they available in different patterns? **YES, they are available in a spot or flood pattern**
2. What color are the accent trim pieces? **Black, Red, Blue and Yellow**



DRIVING LIGHTS

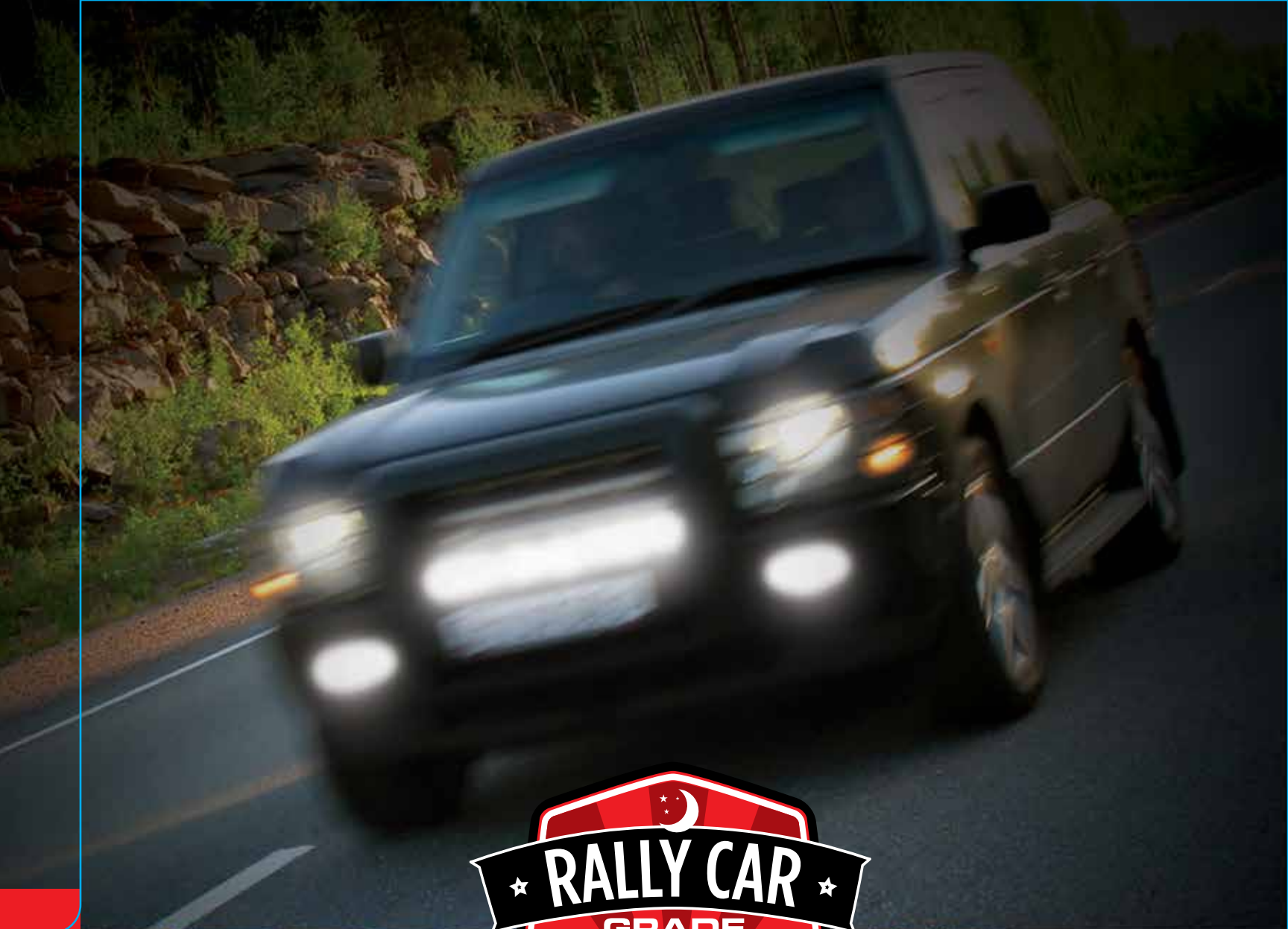

DRIVING LIGHTS



SINGLE ROW DRIVING LED LIGHTS

HE-DL1

6 LED

SINGLE ROW

Wattage: 18W • **Raw Lumens:** 1440lm • **Lux @ 10M:** 260 • **Current Consumption @ 13.8V:** 0.9A
IP Rating: IP67 • **Mounting Bracket:** Black Powder Coated Steel • **Hole Dimensions:** Mounting Bolt Drill .25"



6.25"W x 1.75"H

HE-FMDL1

6 LED

FLUSH MOUNT

Wattage: 18W • **Raw Lumens:** 1440lm • **Lux @ 10M:** 260 • **Current Consumption @ 13.8V:** 0.9A
IP Rating: IP67 • **Mounting Bracket:** Stainless Steel • **Hole Dimensions:** Mounting Bracket to Mounting Hole is 7"
Gasket and cut out template included



7.37"W x 2.5"H

COMMON FEATURES



HE-ARB2

**ANGLED
RUBBER BASE**

Use with the Heise HE-FDML1 flush mount driving light. Comes with black hardware.
(Base sold separately)

INPUT VOLTAGE: 10-30V DC

COLOR TEMPERATURE: 6000K

BEAM PATTERN: 25° SPOT

HOUSING MATERIAL: DIE-CAST ALUMINUM

COLOR: BLACK

LENS MATERIAL: PC

ELECTRONICS: INTEGRATED-EPOXY ENCAPSULATED

HARDWARE: STAINLESS 316

OPERATING TEMPERATURE: -40°F TO +140°F

PROTECTION: REVERSE POLARITY

ROUND DRIVING LED LIGHTS

HE-DL12

2 INCH

1 LED

Wattage: 10W • **Raw Lumens:** 600lm
Lux @ 10M: 10 • **Beam Pattern:** 60° Flood
Current Consumption @ 13.8V: 0.4A • **Mounting Bracket:** Stainless Steel
Hole Dimensions: Mounting Bolt Drill - 0.25"



HE-DL2

3.5 INCH

6 LED

Wattage: 18W • **Raw Lumens:** 1440lm
Lux @ 10M: 185 • **Beam Pattern:** 8° Spot
Membrane: Gore • **Current Consumption @ 13.8V:** 0.4A
Mounting Bracket: Black Powder Coated Steel
Hole Dimensions: Mounting Bolt Drill - 0.25"



3.50"W x 3.75"H x 2.375"D

HE-DL3

5 INCH

8 LED

Wattage: 24W • **Raw Lumens:** 1920lm
Lux @ 10M: 570 • **Beam Pattern:** 26° Spot
Membrane: Gore • **Current Consumption @ 13.8V:** 1.3A
Mounting Bracket: Black Powder Coated Steel
Hole Dimensions: Mounting Bolt Drill - 0.375"



5"W x 6.75"H x 2"D

HE-DL4

7 INCH

15 LED

Wattage: 45W • **Raw Lumens:** 3600lm
Lux @ 10M: 710 • **Beam Pattern:** 26° Spot
Membrane: Gore • **Current Consumption @ 13.8V:** 2.9A
Mounting Bracket: Black Powder Coated Steel
Hole Dimensions: Mounting Bolt Drill - 0.375"



7"W x 9"H x 3"D

ROUND DRIVING LED LIGHTS

HE-DL5 **9** INCH **25** LED

Wattage: 75W • **Raw Lumens:** 6000lm
Lux @ 10M: 940 • **Beam Pattern:** 26° Spot
Membrane: Gore • **Current Consumption @ 13.8V:** 4.4A
Mounting Bracket: Stainless Steel
Hole Dimensions: Mounting Bolt Drill - 0.375"



9"W x 11.375"H x 2.5"D

HE-DL6 **7** INCH **6** LED

Wattage: 60W • **Raw Lumens:** 4800lm
Lux @ 10M: 1210 • **Beam Pattern:** 26° Spot • **Membrane:** Gore
Current Consumption @ 13.8V: 3.1A (w/o halo) 3.2A (with halo)
Mounting Bracket: Stainless Steel
Hole Dimensions: Mounting Bolt Drill - 0.375"



7"W x 9"H x 4"D

SQUARE DRIVING LED LIGHTS

HE-DL8 **5.5** INCH **24** LED

Wattage: 72W • **Raw Lumens:** 5760lm • **Lux @ 10M:** 500
Beam Pattern: 20° Spot • **Current Consumption @ 13.8V:** 3.2A
Mounting Bracket: 304L with Stainless Steel Hardware



3.5"W x 3.75"H x 2.375"D

COMMON FEATURES

INPUT VOLTAGE: 10-30V DC

COLOR TEMPERATURE: 6000K

HOUSING MATERIAL: DIE-CAST ALUMINUM

COLOR: BLACK

LENS MATERIAL: PC

ELECTRONICS: INTEGRATED-EPOXY ENCAPSULATED

HARDWARE: STAINLESS 316

OPERATING TEMPERATURE: -40°F TO +140°F

IP RATING: IP67

PROTECTION: REVERSE POLARITY

PROTECTIVE LIGHT COVERS

HE-DLC5

DRIVING LIGHT COVER

- Driving light cover for HE-DL3



HE-DLC7

DRIVING LIGHT COVER

- Driving light cover for HE-DL4 and HE-DL6







RGB LIGHTS



Upgrade Your Lighting. Anytime. Anywhere.



RGB-CB1

LIGHTING CONTROLLER

- App controlled Android™ / iOS®
- Wireless BLE control
- 16 million color options
- Group multiple devices
- Camera color capture
- Sync lighting to your music
- Rainbow, water and fire patterns
- Fade, blink and pulsating transitions
- 4 programmable triggers
- Handles up to 10 amps of lights



RGB ACCENT LIGHTS

RGB-CB1

4 TRIGGERS

RGB CONTROL BOX

NEW!

- App controlled Android™ / iOS®
- Wireless BLE control
- 16 million color options
- Group multiple devices
- Camera color capture
- Sync lighting to your music
- Rainbow, water and fire patterns
- Fade, blink and pulsating transitions
- 4 programmable triggers
- Handles up to 10 amps of lights



7 INCH

6 LED

RGB BLACK FRONT FACE

JP-704RGB PAIR

- 75 watts total (set)
- 2200lm low beam + 4000lm high beam
- Polycarbonate lens cover is virtually unbreakable
- Requires RGB-CB1 control box sold separately



4 INCH

15 LED

RGB BLACK FRONT FACE

JP-704RGBFL NEW! PAIR

- 30 watts total (set)
- 1600lm (set)
- Polycarbonate lens cover is virtually unbreakable
- Standard 9145 connector
- LED color temp 6500K
- Number of RGB LEDs (per light): 6 LEDs, 0.2W/LED
- Number of halo LEDs (per light): 12 LEDs, 0.2W/LED
- Requires RGB-CB1 control box required for operation (sold separately)



RGB1-4KT

RGB

4 POD ROCK LIGHT SET

- Use with RGB1-CB1
- (3) 3-watt Cree LEDs per pod
- 9 watts per pod
- Raw lumens: 720lm
- Stainless 316 hardware included
- Current consumption @ 13.8 volts 0.2 amps
- PC lens - IP68 rated
- Works with RGB-CB1 (sold separately)
- 10 feet of cable on light



RGB ACCENT LIGHTS

HE-TL1RGB 1.5x3 INCH SINGLE RGB ROCK LIGHT

★ IP68 ★
CERTIFIED



- (3) 3-watt Cree LEDs
- 9 watts
- Raw lumens: 720lm
- Stainless 316 hardware included
- Black die-cast aluminum housing
- PC lens - IP68 rated
- Works with RGB-CB1 (sold separately)
- 10 feet of cable on light



*PODS SOLD INDIVIDUALLY

HE-ML1RGB 1.5x3 INCH SINGLE RGB ROCK LIGHT

★ IP68 ★
CERTIFIED



- (3) 3-watt Cree LEDs
- 9 watts
- Raw lumens: 720lm
- Stainless 316 hardware included
- White die-cast aluminum housing
- PC lens - IP68 rated
- Works with RGB-CB1 (sold separately)
- 10 feet of cable on light



*PODS SOLD INDIVIDUALLY

ADDITIONAL ACCESSORIES

ACCENT LIGHTING COVERS



HE-TL1DIV

The light cover is for use with the HE-TL1, HE-TL1R, HE-TL1B, HE-TL1A and HE-TL1G



HE-ML1DIV

The light cover is for use with the HE-ML1, HE-ML1R, HE-ML1B, HE-ML1A and HE-ML1G

MOUNTING BASE



HE-ARB1

The angled base is for use with the HE-TL1, HE-ML1 and all colors within series

RGB1-UNDGLED RGB 4 LED TUBE UNDER GLOW **NEW!**



- Includes (2) 48 inch and (2) 36 inch LED tubes
- Dual connection to controller maximum current and even illumination
- Requires RGB-CB1 controller (sold separately)
- Mounting hardware and extension cables included

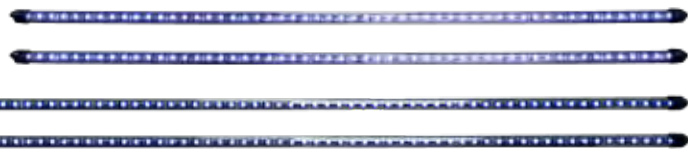

RED

GREEN

BLUE



INFINITE SERIES LED CUBE LIGHTS

HE-ICL2

3 INCH

4 LED

Wattage: 13W • **Raw Lumens:** 1080lm • **Lux @ 10M:** 411
Current Consumption @ 13.8V: 0.9A • **IP Rating:** IP67

Heise HE-DLWH1 dual light wiring harness included



RGB LEDES



HE-ICL2PK

3 INCH

4 LED

2 LIGHT PACK

Wattage: 13W • **Raw Lumens:** 1080lm • **Lux @ 10M:** 411
Current Consumption @ 13.8V: 0.9A • **IP Rating:** IP67

Heise HE-DLWH1 dual light wiring harness included



RGB LEDES

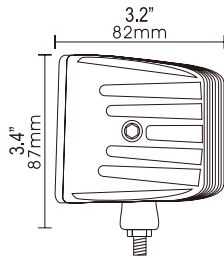

COMMON FEATURES

INPUT VOLTAGE: 10-30V DC

COLOR TEMPERATURE: 6000K

BEAM PATTERN: 8° SPOT

HOUSING MATERIAL: DIE-CAST ALUMINUM

COLOR: BLACK

LENS MATERIAL: PC

MOUNTING BRACKET: STAINLESS STEEL

ELECTRONICS: INTEGRATED-EPOXY ENCAPSULATED

HARDWARE: STAINLESS 316

OPERATING TEMPERATURE: -40°F TO +140°F

PROTECTION: REVERSE POLARITY



★ IP68 ★
CERTIFIED



RGB-CB1

CONTROL BOX

Required for RGB functionality
on all Infinite Series lights.
(Sold separately)

INFINITE SERIES LED LIGHTBARS

HE-INFIN8 **8** INCH **12** LED

Wattage: 18W • **Raw Lumens:** 2280lm • **Lux @ 10M:** 235
Current Consumption @ 13.8V: 1.3A • **IP Rating:** IP67



HE-INFIN22 **22** INCH **40** LED

Wattage: 60W • **Raw Lumens:** 7600lm • **Lux @ 10M:** 1150
Current Consumption @ 13.8V: 4.34A • **IP Rating:** IP67



HE-INFIN30 **30** INCH **56** LED

Wattage: 84W • **Raw Lumens:** 10640lm • **Lux @ 10M:** 1426
Current Consumption @ 13.8V: 6.1A • **IP Rating:** IP67



HE-INFIN40 **40** INCH **76** LED

Wattage: 114W • **Raw Lumens:** 14440lm • **Lux @ 10M:** 1780
Current Consumption @ 13.8V: 9.5A • **IP Rating:** IP67



HE-INFIN50 **50** INCH **96** LED

Wattage: 144W • **Raw Lumens:** 17100lm • **Lux @ 10M:** 2350
Current Consumption @ 13.8V: 14.3A • **IP Rating:** IP67



INFINITE SERIES LED LIGHTBARS



- INPUT VOLTAGE:** 10-30V DC
- COLOR TEMPERATURE:** 6000K
- BEAM PATTERN:** 8° SPOT
- HOUSING MATERIAL:** DIE-CAST ALUMINUM
- COLOR:** BLACK
- MEMBRANE:** MILITARY BREATHER
- LENS MATERIAL:** POLYCARBONATE
- MOUNTING BOLT DRILL:** 0.25"
- ELECTRONICS:** INTEGRATED-EPOXY ENCAPSULATED
- HARDWARE:** STAINLESS 316
- OPERATING TEMPERATURE:** -40°F TO +140°F
- PROTECTION:** REVERSE POLARITY

SPECS & MEASUREMENTS



★ IP68 ★
CERTIFIED

RGB-CB1

CONTROL BOX

Required for RGB functionality on all Infinite Series lights. (Sold separately)

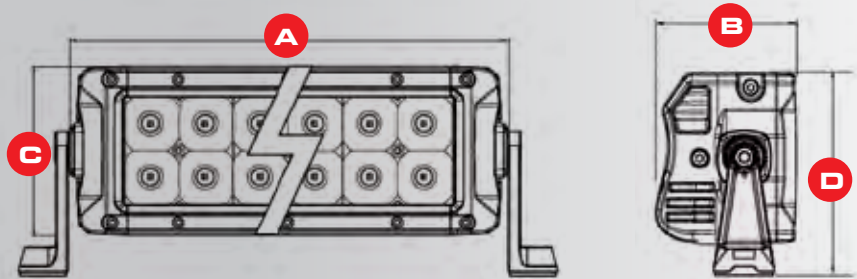

PART	A	B	C	D
HE-INFIN8	8.11"	2.56"	3.09"	4.84"
HE-INFIN22	22.17"	2.56"	3.09"	4.84"
HE-INFIN30	30.20"	2.56"	3.09"	4.84"
HE-INFIN40	40.24"	2.56"	3.09"	4.84"
HE-INFIN50	50.12"	2.56"	3.09"	4.84"

MARINE TRANSOM LED LIGHTS

ML-RGB15W

5 WATT

3 LED



RGB LEDS

15W UNDERWATER TRANSOM LIGHT

- (3) 5-watt LEDs
- 4-wire RGB
- Hardwire connections

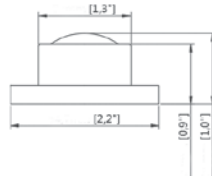
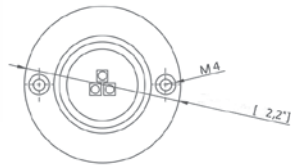

ML-RGB27W

3 WATT

9 LED



RGB LEDS

27W UNDERWATER TRANSOM LIGHT

- (9) 3-watt LEDs
- 4-wire RGB
- Hardwire connections

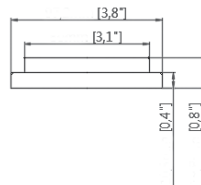
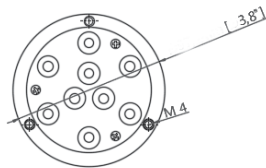

ML-RGB54W

9 WATT

6 LED



RGB LEDS

54W UNDERWATER TRANSOM LIGHT

- (6) 9-watt LEDs
- 4-wire RGB
- Hardwire connections

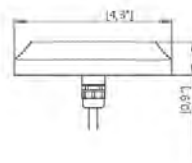
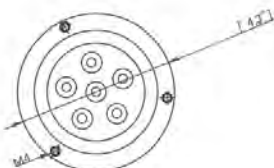

COMMON FEATURES

INPUT VOLTAGE: 10-30V DC

HOUSING MATERIAL: STAINLESS STEEL 316

MOUNT: SURFACE

MARINE DRAIN PLUGS

ML-DLRGB9W **3** WATT **3** LED

9W SMALL DRAIN PLUG LIGHT

- (3) 3-watt LEDs
- 4-wire RGB
- Hardwire connections

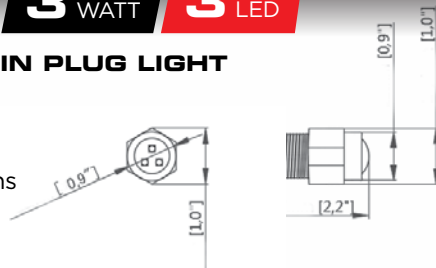

RGB LEDs

ML-DLRGB27W **3** WATT **9** LED

27W LARGE DRAIN PLUG LIGHT

- (9) 3-watt LEDs
- 4-wire RGB
- Hardwire connections

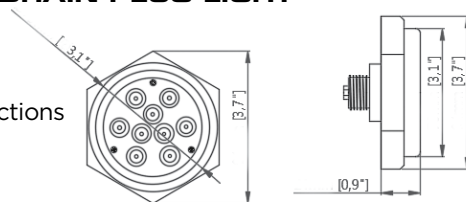

RGB LEDs

COMMON FEATURES

INPUT VOLTAGE: 10-30V DC **HOUSING MATERIAL:** BRASS OR STAINLESS STEEL 316
MOUNT: 1/2" NPT THREADS NO DRILLING REQUIRED

ADAPTERS, CABLES & WIRE

RGB-Y1 **6** INCH **"Y" ADAPTER**

- 6" RGB Y adapter
- 1 male - 2 female
- 4-pin connector works with RGB1-4KT and HE-TL1RGB



RGB-PT1 **4** PIN **PIGTAIL ADAPTER**

- 4-pin RGB hardwire pigtail



HE-EXTRGB **10** FOOT **4-PIN EXTENSION**

- 4-pin extension cable
- 10 feet long
- Used with RGB-CB1 and HE-TL1RGB



HE-RGBWIRE50-1 **50** FOOT **RGB WIRE**

- 4 conductor RGB wire for use with H-5MRGB-1 LED strip. 50 feet 15.24 meters



HE-RGBWIRE100-1 **100** FOOT **RGB WIRE**

- 4 conductor RGB wire for use with H-5MRGB-1 LED strip. 100 feet 30.48 meters



Upgrade Your Lighting. Anytime. Anywhere.



RGBW-CB1

LIGHTING CONTROLLER

- App controlled Android™ / iOS®
- Wireless BLE control
- 16 million color options
- Group multiple devices
- Camera color capture
- Sync lighting to your music
- Rainbow, water and fire patterns
- Fade, blink and pulsating transitions
- 4 programmable triggers
- Handles up to 10 amps of lights



RGBW LED ACCENT LIGHTS

RGBW-CB1

4 TRIGGERS

RGBW CONTROL BOX

- App controlled Android™ / iOS®
- Wireless BLE control
- 16 million color options
- Group multiple devices
- Camera color capture
- Sync lighting to your music
- Rainbow, water and fire patterns
- Fade, blink and pulsating transitions
- 4 programmable triggers
- Handles up to 10 amps of lights



RGBW1-4KT

IP68

4 POD ROCK LIGHT KIT

- RGB LED + True White LED
- (24) 3030 LEDs per pod
- 24 watts per pod
- Black die-cast aluminum housing
- PC lens - IP68 rated
- Works with RGBW-CB1 (sold separately)



RGBW1-S1

IP68

SINGLE RGBW ROCK LIGHT

- RGB LED + True White LED
- (24) 3030 LEDs per pod
- 24 watts per pod
- Black die-cast aluminum housing
- PC lens - IP68 rated
- Works with RGBW-CB1 (sold separately)



RGBW-Y1

"Y" ADAPTER

- 6" RGB Y adapter
- 1 male - 2 female
- 5-pin connector works with RGBW1-4KT and RGBW1-S1



RGBW-PT1

PIGTAIL ADAPTER

- 5-pin RGBW hardwire pigtail



RGBW1-EXT

5-PIN EXTENSION

- 5-pin 10 foot extension cable
- Used with RGBW-CB1 and RGBW1-S1
- IP68

MARINE TRANSOM LED LIGHTS

ML-RGBW24W **4** WATT **6** LED

24W UNDERWATER TRANSOM LIGHT

- (6) 4-watt LEDs
- 5-wire RGBW
- Hardwire connections

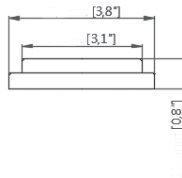
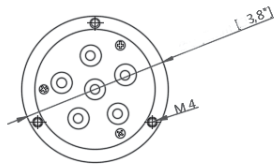

ML-RGBW72W **12** WATT **6** LED

72W UNDERWATER TRANSOM LIGHT

- (6) 12-watt LEDs
- 5-wire RGBW
- Hardwire connections

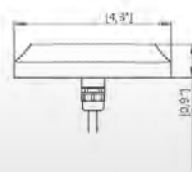
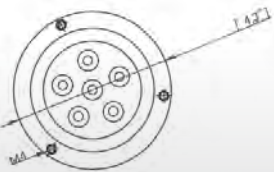

COMMON FEATURES

INPUT VOLTAGE: 10-30V DC

HOUSING MATERIAL: STAINLESS STEEL 316

MOUNT: SURFACE



Upgrade Your Lighting. Anytime. Anywhere.



RGB-CB3

LIGHTING CONTROLLER

- App controlled Android™ / iOS®
- Wireless BLE control
- 16 million color options
- Group multiple devices
- Camera color capture
- Sync lighting to your music
- Rainbow, water and fire patterns
- Fade, blink and pulsating transitions
- 4 programmable triggers
- Handles up to 10 amps of lights



RGB ACCENT LIGHTS

RGB-CB3

4 TRIGGERS

RGB CONTROL BOX

- Used for part # HE-PBHL702RGB HL and HE-JWBFL02RGB
- App controlled Android™ / iOS®
- Wireless BLE control
- 16 million color options
- Group multiple devices
- Camera color capture
- Sync lighting to your music
- Rainbow, water and fire patterns
- Fade, blink and pulsating transitions
- 4 programmable triggers
- Handles up to 10 amps
- Flat 4-pin



7 INCH

6 LED

RGB BLACK FRONT FACE WITH FULL HALO

HE-PBHL702RGB

PAIR

Wattage: (4) 10-watt CREE LEDs per Housing
2000lm low beam, draws 1.9A @ 13.8v
3000lm high beam, draws 2.7A @ 13.8v

- RGB angel eye halo



4 INCH

3 LED

RGB ANGEL EYE HALO CONNECTS TO RUNNING LIGHTS

HE-JWBFL02RGB

BLACK FRONT FACE PAIR

Wattage: (3) 10-watt CREE LEDs
Raw Lumens: 1200lm Per Light
Current Consumption @ 13.8V: 1.4A (halo off) 1.6A (halo on)



Upgrade Your Lighting. Anytime. Anywhere.

RGB-CB2

LIGHTING CONTROLLER

- App controlled Android™ / iOS®
- Wireless BLE control
- 16 million color options
- Group multiple devices
- Camera color capture
- Sync lighting to your music
- Rainbow, water and fire patterns
- Fade, blink and pulsating transitions
- 4 programmable triggers
- Handles up to 10 amps of lights



RGB ACCENT LIGHT KITS

RGB-CB2

4 TRIGGERS

RGB CONTROL BOX

- App controlled Android™ / iOS®
- Wireless BLE control
- 16 million color options
- Group multiple devices
- Camera color capture
- Sync lighting to your music
- Rainbow, water and fire patterns
- Fade, blink and pulsating transitions
- 4 programmable triggers
- Handles up to 10 amps of lights



RGB2-4KT

IP68

4-STRING ROCK LIGHT SET

- 4-piece kit
- 3 LED pods per strip
- 5 LEDs per pod
- 4-pin micro-DIN controller
- IP68 rated
- Works with RGB-CB2 (sold separately)



RGB LEDs



RGB2-S1

IP68

SINGLE RGB STRING LIGHT

- 3 LED pods per strip
- 5 LEDs per pod
- 4-pin micro-DIN controller
- IP68 rated
- Works with RGB-CB2 (sold separately)



RGB LEDs



MPS-RGBDL

IP68

RGB DOME LIGHT FIXTURE

- RGB LED with female micro-DIN wire
- IPX5 rated for RV, Marine, UTV or any vehicle
- 8 pieces of RGB SMD LEDs - 5 watts total
- Use with RGB-CB2 (sold separately)
- 10'



RGB LEDs



MPS-ECRGB36

RGB EXTENSION

- 36" RGB LED extension
- Male micro-DIN 4-pin and female micro-DIN 4-pin connectors



MPS-ECRGB72

RGB EXTENSION

- 72" RGB LED extension
- Male micro-DIN 4-pin and female micro-DIN 4-pin connectors



RGB-PT2

PIGTAIL ADAPTER

- 36"
- 4-pin RGBW hardwire pigtail



RGB-Y2

RGB2 "Y" ADAPTER

- 6"
- One 4-pin female micro-DIN to two micro-DIN males

Upgrade Your Lighting. Anytime. Anywhere.



RGBW-CB2

LIGHTING CONTROLLER

- App controlled Android™ / iOS®
- Wireless BLE control
- 16 million color options
- Group multiple devices
- Camera color capture
- Sync lighting to your music
- Rainbow, water and fire patterns
- Fade, blink and pulsating transitions
- 4 programmable triggers
- Handles up to 10 amps of lights



RGBW ACCENT LIGHTS

RGBW-CB2

4 TRIGGERS

RGBW CONTROL BOX

- App controlled Android™ / iOS®
- Wireless BLE control
- 16 million color options
- Group multiple devices
- Camera color capture
- Sync lighting to your music

- Rainbow, water and fire patterns
- Fade, blink and pulsating transitions
- 4 programmable triggers
- Handles up to 10 amps of lights



RGBW2-4KT

IP68

4-STRING ROCK LIGHT SET

- RGB LED + True White LED
- 4-piece kit
- 3 LED pods per strip
- 5 LEDs per pod
- IP68
- 5-pin micro-DIN connector
- Used with RGBW-CB2 controller (sold separately)



RGBW2-S1

IP68

SINGLE RGBW STRING LIGHT

- RGB LED + True White LED
- 3 LED pods per strip
- 5 LEDs per pod
- IP68
- Used with RGBW-CB2 controller (sold separately)
- 5-pin micro-DIN connector



RGBW2-DL

IP68

RGBW DOME LIGHT FIXTURE

- RGBW LED dome light 5-pin
- Multiple mounting options
- 10' cable
- RGBW-CB2 (sold separately)



RGBW-36

RGB EXTENSION

- 36" RGB LED extension
- Male micro-DIN 5-pin and female micro-DIN 5-pin connectors



RGBW-72

RGB EXTENSION

- 72" RGB LED extension
- Male micro-DIN 5-pin and female micro-DIN 5-pin connectors



RGBW-PT2

HARDWIRE PLUG

- 36"
- 5-pin RGBW hardwire plug



RGBW2-Y

"Y" ADAPTER

- 6"
- One 5-pin female micro-DIN to two micro-DIN males

RGB COMPLETE LIGHT KITS

JP-706RGBKT **7** INCH **9** LED

7" HEADLIGHT PAIR, 4" FOG LIGHT PAIR, RGB CONTROLLER AND 7" RETAINING RING

Wattage: Headlights (9) 5-watt LEDs for a total of 45 watts

Fog lights (6) 5-watt LEDs for a total of 30 watts

Headlights: 2400lm low beam, 3600lm high beam

Fog lights: 1400lm

- Addressable LEDs
- 120 color changing patterns
- DIY pattern functions
- Music sync functions
- App controlled (Car-lights app)
- Compatible with Android™ and iOS®
- 4-channel controller included



RGB LEDs



7 INCH **4** LED **ROUND WITH RGB HALO**

HE-BHL702RGB BLACK FRONT FACE PAIR

Wattage: (4) 10-watt CREE LEDs

RGB angel eye halo

2000lm low beam, draws 1.9A @ 13.8v

3000lm high beam, draws 2.7A @ 13.8



Includes RGB control box



RGB LEDs



7 INCH **9** LED **ROUND WITH RGB HALO**

BC-706RGBKT BLACK FRONT FACE

7" HEADLIGHT WITH (2) 4.5" AUXILIARY LIGHTS, RGB CONTROLLER AND 7" RETAINING RING

Wattage: Headlights (9) 5-watt LEDs for a total of 45 watts

Auxiliary lights (6) 5-watt LEDs for a total of 30 watts

Headlights: 2400lm low beam, 3600lm high beam

Auxiliary lights: 1400lm

- Addressable LEDs
- 120 color changing patterns
- DIY pattern functions
- Music sync functions
- App controlled (Car-lights app)
- Compatible with Android™ and iOS®



RGB LEDs



RGB COMPLETE LIGHT KITS

MPS-RZ1RGB **1** PAIR **RGB HALO BT CONTROLLED**

2014-2021
LED HEADLIGHTS FOR POLARIS® RZR EXTREME

Power: 30W/15W 6PCS CREE XTE LED CHIP
Voltage: DC10-30V
Housing Color: Black/Black
LED Power: 60W Halo ring
Lumen: 3500lm high beam, 1800lm low beam



- 121 different flashing modes: jumping, fading, flashing, dimming, watering and running, etc.
- RGB angel eye has more than 120 different color change modes
- 2-piece Polaris® RZR LED headlights (left and right)
- App controlled (Car-lights app)
- Compatible with Android™ and iOS®

POD LED STRING KIT

MPS-RGBWWK **4** ROPES **12** PODS **1** CONTROLLER

- Includes four (4) sets of pod LED string lights, MPS-RGBWWS4
- Includes one (1) hideaway RBG controller, MPS-RGBC-4



RGB LED WHIPS **4** FOOT

MPS-RGBWHIP4-1

MPS-FORGBWHIP4

MPS-CRGBWHIP4

RGB LED WHIPS **6** FOOT

MPS-RGBWHIP6-1

MPS-FORGBWHIP6

MPS-CRGBWHIP6

MPS-WHIPM COMES WITH 1.5, 1.75, 1.875 & 2 INCH RUBBER INSERTS

WHIP MOUNT

- Whip antenna mount for roll cages
- Milled aluminum
- Powder coated gloss black
- Adjusts to fit most angles



RGB COMPLETE LIGHT KITS

HE-8TLRGBK

8 RGB PODS

3 LED

**★ IP68 ★
CERTIFIED**



RGB LEDS



LEDs: 8 Pods - (3) 3W CREE LEDs Per Pod
Wattage: 9W Total Per Pod • **Raw Lumens:** 720lm

The HE-8TLRGBK is a complete kit to light up your vehicle. (8) HE-TL1RGB RGB accent lights and the HE-CBRGB control box will give you accent lighting where you want it.

HE-8MLRGBK

8 RGB PODS

3 LED

**★ IP68 ★
CERTIFIED**



RGB LEDS



LEDs: 8 Pods - (3) 3W CREE LEDs Per Pod
Wattage: 9W Total Per Pod • **Raw Lumens:** 720lm

The HE-8MLRGBK is a complete kit to light up your boat. (8) HE-ML1RGB RGB accent lights and the HE-CBRGB control box will give you accent lighting where you want it.

HE-4TLRGBK

4 RGB PODS

3 LED

**★ IP68 ★
CERTIFIED**



RGB LEDS



LEDs: 4 Pods - (3) 3W CREE LEDs Per Pod
Wattage: 9W Total Per Pod • **Raw Lumens:** 720lm

Designed as a starter kit this allows you get the RGB lights in your vehicle without breaking the bank, but also allows you add up to four more HE-TL1RGB lights.

HE-4MLRGBK

4 RGB PODS

3 LED

**★ IP68 ★
CERTIFIED**



RGB LEDS



LEDs: 4 Pods - (3) 3W CREE LEDs Per Pod
Wattage: 9W Total Per Pod • **Raw Lumens:** 720lm

Designed as a starter kit this allows you get the RGB lights in your boat without breaking the bank but also allows you add up to four more HE-ML1RGB lights.

HE-CBRGB

8 OUTPUT

REPLACEMENT CONTROL BOX

Control Box for RGB Accent Lights. Water-resistant control box for HE-TL1RGB and HE-ML1RGB. Control box can be mounted in the engine bay.







RGB LED STRIPS KITS

H-RGB5MRK2

KIT RGB

5 METER

- 5 meters (16.4 feet) RGB 5050 LED strip
- 5050 SMD LEDs at 60 LEDs per meter
- One 24-key IR remote & RGB controller
- 3 amp power supply
- IP65 water-resistant covering



RGB LEDs



H-RGB5MRK1

KIT RGB

5 METER

- 5 meters (16.4 feet) RGB 3528 LED Strip
- 3528 SMD LEDs at 60 LEDs per meter
- One 24-key IR remote & RGB controller
- 3 amp power supply
- IP65 water-resistant covering



RGB LEDs



RGB STRIP LIGHT

HE-RFRGBC-1

RF

- 16 color RGB control unit
- 24-button credit card sized IR remote included
- Cord for LEDs to plug into is 15"
- On/off buttons with built-in 8-way dimmer
- "Flash", "Strobe", "Fade" and "Smooth" buttons
- Draws 1.2 amps



HE-WFRGBC-1

WiFi

- WiFi controller for HE-5MRGB-1 lights
- 24-button credit card sized IR remote included
- Uses MagicHome WiFi app, available for Android™ and iOS®
- Works with Amazon Alexa® and Google Home®
- Control HE-5MRGB-1 lights anywhere in the world as long as the controller is connected to WiFi



RETAIL PKG

WHITE BOX PKG

H-RGBC-1

HE-RGBC-1

- 16 color RGB control unit
- 24-button credit card sized IR remote included
- Cord for LEDs to plug into is 15"
- On/off buttons with built-in 8-way dimmer
- "Flash", "Strobe", "Fade" and "Smooth" buttons
- Draws 1.2 amps



HE-RGBSAC-1

SOUND

- Sound activated controller
- 24-button credit card sized IR remote included
- You can connect up to three HE-5MRGB-1 lights to the controller
- Sensitivity adjustment



RETAIL PKG

ANTI-STATIC PKG

H-5MRGB-1

WHITE BASE

HE-5MRGB-1

WHITE BASE

HE-5MBRGB-1

BLACK BASE



RGB LEDs

5 METER

16 COLOR RGB

- 16 different selectable colors
- 5 meter flexible LED roll
- 5050 RGB LEDs
- 60 LEDs per meter, 300 total
- LED strip is 10mm wide and 2.5mm thick
- IP65 rated water-resistant covering
- 3M adhesive tape backing
- 12volt DC input
- Able to be cut every 3rd LED
- H-RGBC-1 control unit is required *(sold separately)*



RGB LED STRIP LIGHT ACCESSORIES

HE-RGBAMP-1 AMP

RGB-1

- In-line amplifier for H-5MRGB-1 LED strip lights
- Add after each 5 meter roll
- Functions of the RGB control box will be passed through the HE-RGBAMP-1



H-QCRGB-1 6 INCH

QUICK CONNECT

- 6" quick connector for 5MRGB-1 LED lights - 4 PACK
- 10 PACK - in anti-static bag **HE-QCRGB-1**



H-ECRGB-1 6 INCH

EXTENSION CONNECT

- 6" quick connector for 5MRGB-1 LED lights - 2 PACK
- 10 PACK - in anti-static bag **HE-ECRGB-1**

HE-ECRGB4PIN-1 RGB

SOLDERLESS CONNECTOR

- Solderless connection for H-5MRGB-1 to 4-pin header allows use of H-RGBAMP-1 with cut sections of H-5MRGB-1



HE-RGBWIRE50-1 50 FEET

RGB 4 CONNECTOR

- 4 conductor RGB wire for use with H-5MRGB-1 LED strip - 50 feet (15.24 meters)



HE-RGBWIRE100-1 100 FEET

RGB 4 CONNECTOR

- 4 conductor RGB wire for use with H-5MRGB-1 LED Strip - 100 feet (30.48 meters)

PROGRAMMABLE RGB

RETAIL PKG

WHITE BOX PKG

H-RGBC-3

HE-RGBC-3

RF CONTROL UNIT

- 132 preprogrammed lighting function
- 2.8 amps with two HE-5MRGB-3 connected
- 1.8 amps with one HE-5MRGB-3 connected
- Allows two 5 meter rolls to be connected and control LED by one remote
- Control box has same functions as remote and will work without remote



HE-5MRGB-3

5 METER

132 FUNCTION RGB

- 132 different functions that will get attention
- 5 meter flexible LED roll
- 5050 RGB LEDs
- LED strip is 10mm wide and 4mm thick



RGB LEDS



3528 LED STRIPS

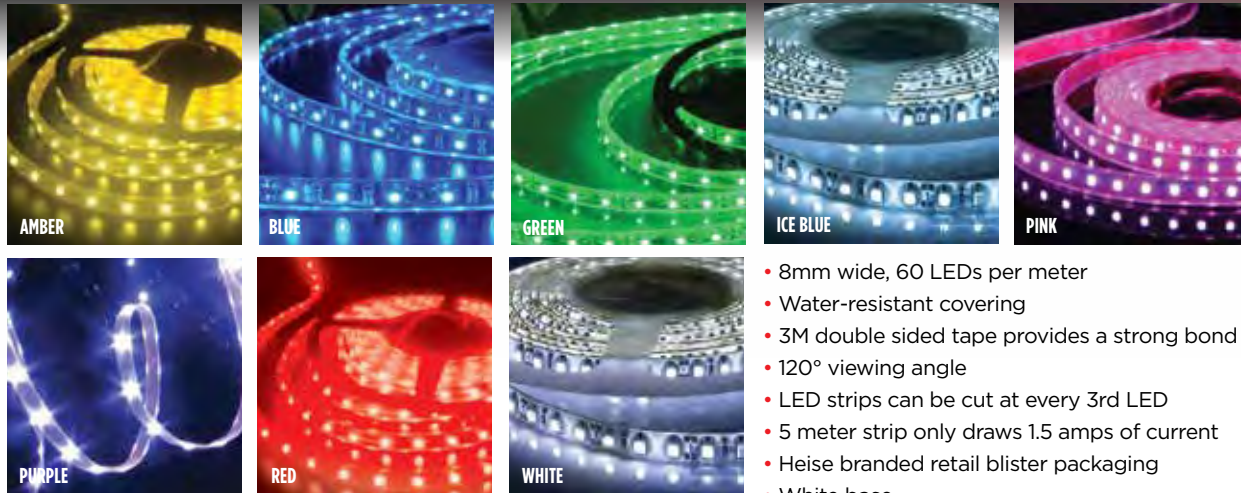

- 8mm wide, 60 LEDs per meter
- Water-resistant covering
- 3M double sided tape provides a strong bond
- 120° viewing angle
- LED strips can be cut at every 3rd LED
- 5 meter strip only draws 1.5 amps of current
- Heise branded retail blister packaging
- White base

IP65 RATED

1 METER **60** LEDs PER METER

COLOR	RETAIL PKG	ANTI-STATIC PKG
AMBER	H-A135	HE-A135
BLUE	H-B135	HE-B135
GREEN	H-G135	HE-G135
ICE BLUE	—	HE-IB135
PINK	H-PK135	HE-PK135
PURPLE	—	HE-PP135
RED	H-R135	HE-R135
WHITE	H-W135	HE-W135

IP65 RATED

3 METER **60** LEDs PER METER

COLOR	RETAIL PKG	ANTI-STATIC PKG
BLUE	H-B335	HE-B335
GREEN	H-G335	HE-G335
ICE BLUE	—	HE-IB335
PURPLE	H-PP335	HE-PP335
RED	H-R335	HE-R335
WHITE	H-W335	HE-W335

BLACK BASE

3 METER **60** LEDs PER METER

COLOR	RETAIL PKG
RED/BLK	H-R335-BLK
ANTI-STATIC PKG	
BLUE/BLK	HE-B335-BLK
RED/BLK	HE-R335-BLK
WHITE/BLK	HE-W335-BLK

IP65 RATED

5 METER **60** LEDs PER METER

COLOR	RETAIL PKG	ANTI-STATIC PKG
AMBER	H-A535	HE-A535
BLUE	H-B535	HE-B535
GREEN	H-G535	HE-G535
PINK	H-PK535	—
PURPLE	H-PP535	HE-PP535
RED	H-R535	HE-R535
WHITE	H-W535	HE-W535
COOL WHITE	H-CW535	—
WARM WHITE	H-WW535	—

IP20 RATED

5 METER **60** LEDs PER METER

COLOR	ANTI-STATIC PKG
BLUE	HE-B535I
WHITE	HE-W535I
COOL WHITE	HE-CW535I

- IP20 rated
- No covering over the LED lights
- For interior use only
- ANTI-STATIC packaging ONLY



5050 LED STRIPS



AMBER



BLUE



GREEN



ICE BLUE

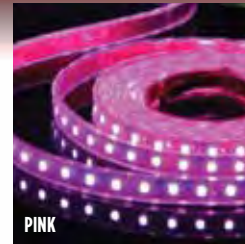

PINK

- 10mm wide, 60 LEDs per meter
- Water-resistant covering
- 3M double-sided tape provides a strong bond
- 120° viewing angle
- Led strips can be cut at every 3rd LED
- 5 meter strip only draws 4.5 amps of current
- Heise branded retail blister packaging
- White base



PURPLE



RED



WHITE

IP65 RATED

1 METER / **60** LEDs PER METER

COLOR	RETAIL PKG	ANTI-STATIC PKG
AMBER	H-A150	HE-A150
BLUE	H-B150	HE-B150
GREEN	H-G150	HE-G150
ICE BLUE	—	HE-IB150
PINK	—	HE-PK150
RED	H-R150	HE-R150
WHITE	H-W150	HE-W150

IP65 RATED

3 METER / **60** LEDs PER METER

COLOR	RETAIL PKG	ANTI-STATIC PKG
AMBER	—	HE-A350
BLUE	H-B350	HE-B350
GREEN	H-G350	—
PURPLE	H-PP350	HE-PP350
RED	H-R350	HE-R350
WHITE	H-W350	HE-W350

BLACK BASE

3 METER / **60** LEDs PER METER

COLOR	RETAIL PKG
BLUE/BLK	H-B350-BLK
RED/BLK	H-R350-BLK
WHITE/BLK	H-W350-BLK
ANTI-STATIC PKG	
BLUE/BLK	HE-B350-BLK
RED/BLK	HE-R350-BLK
WHITE/BLK	HE-W350-BLK

IP65 RATED

5 METER / **60** LEDs PER METER

COLOR	RETAIL PKG	ANTI-STATIC PKG
AMBER	H-A550	HE-A550
BLUE	H-B550	HE-B550
GREEN	H-G550	HE-G550
ICE BLUE	H-IB550	HE-IB550
PINK	H-PK550	HE-PK550
PURPLE	H-PP550	HE-PP550
RED	H-R550	HE-R550
WHITE	H-W550	HE-W550
COOL WHITE	H-CW550	HE-CW550
WARM WHITE	—	HE-WW550

IP20 RATED

5 METER / **60** LEDs PER METER

COLOR	ANTI-STATIC PKG
BLUE	HE-B550I
WHITE	HE-W550I
COOL WHITE	HE-CW550I
WARM WHITE	HE-WW550I

- IP20 rated
- No covering over the LED lights
- For interior use only
- ANTI-STATIC packaging ONLY

IP68 RATED

5 METER / **60** LEDs PER METER

COLOR	ANTI-STATIC PKG
BLUE	HE-B55068
GREEN	HE-G55068
RED	HE-R55068
WHITE	HE-W55068

- IP68 rated
- Mounts with brackets (included) instead of tape for secure mounting
- ANTI-STATIC packaging ONLY

SIDE VIEW LED STRIPS



WHITE



AMBER



BLUE

12volt side view LED light strips for an Audi-style headlight look without the price of an Audi. Flexible and water-resistant, these lights will give your vehicle a more expensive look.

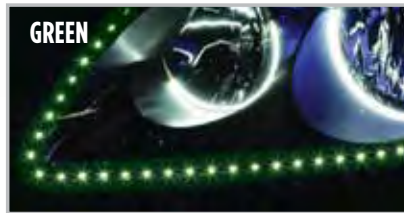

GREEN



RED

24 INCH **60** LEDS PER STRIP

H-WSV

WHITE

HE-BSV

BLUE PAIR

H-ASV

AMBER PAIR

HE-RSV

RED PAIR

H-BSV

BLUE PAIR

ANTI-STATIC PKG

H-RSV

RED PAIR

RETAIL PKG

54 INCH **135** LEDS PER STRIP

HE-WSV54

WHITE

HE-RSV54

RED PAIR

ANTI-STATIC PKG ONLY

COMMON FEATURES



PERFECT FOR HEADLIGHT ACCENT

Give your older model vehicle a face-lift with great looking LEDs. The pair of 24" strips is ready for a quick and easy installation.

SIZE: STRIPS ARE 6MM WIDE

WATER-RESISTANT: YES

USAGE: 0.7A

MOUNTING: 3M DOUBLE-SIDED TAPE

IP RATING: IP65

ACCESSORIES LED STRIPS

RETAIL PKG

ANTI-STATIC

H-PS2

HE-PS2

2 AMP

POWER SUPPLY

- 12volt 2 amp power supply for single color LEDs
- UL listed



HE-PS10

10 AMP

POWER SUPPLY

- 12volt 10 amp power supply for RGB LEDs and controllers



HE-PS6

6 AMP

POWER SUPPLY

- 12volt 6 amp power supply for RGB LEDs and controllers



HE-PS6UL

6 AMP

POWER SUPPLY

- 12volt 6 amp power supply
- UL listed



HE-AMP

SINGLE

AMP SINGLE COLOR

- In-line amplifier for single color LED strip lights
- Add after each 5 meter roll



HE-LEDDIM

CONTROLLER

LED STRIP LIGHT IR DIMMER

- In-line dimmer for single color LED strip lights



HE-DIM

DIMMER

SINGLE COLOR

- In-line dimmer for single color LED strip lights
- Plug in-line with power cord of LED lights



HE-SPLIT4

SPLITTER

MALE TO 4 FEMALE

- 12V DC single male to 4 female splitter that can connect 4 LED lights to one power supply
- Great for displays



HE-SPLIT8

SPLITTER

MALE TO 8 FEMALE

- 12V DC single male to 8 female splitter that can connect 8 LED lights to one power supply
- Great for displays



HE-SPLIT16

SPLITTER

MALE TO 16 FEMALE

- 12V DC single male to 16 female splitter that can connect 16 LED lights to one power supply
- Great for displays

HE-MFQC

2 WIRE

F&M 2 WIRE CONNECTOR

- Male and female two-wire connector adapter
- Allows simple plug-in to LED lights from a power and ground wire
- 2 PACK - 1 MALE, 1 FEMALE



HE-FQC5PK

2 WIRE

F 2 WIRE CONNECTOR

- Female two-wire to connector adapter
- Allows simple plug-in to LED lights from a power and ground wire
- 5 PACK - FEMALE



HE-MQC5PK

2 WIRE

M 2 WIRE CONNECTOR

- Male two-wire to connector adapter
- Allows simple plug-in to LED lights from a power and ground wire
- 5 PACK - MALE



ACCESSORIES LED STRIPS



HE-3528FW 10 PACK

ADAPTER

- 3528 LED + adapter



HE-5050CP 10 PACK

COUPLER

- 5050 LED coupler



HE-3528QC 5 PACK

QUICK CONNECT

- DC female quick connect for 3528 LEDs



HE-3528CP 10 PACK

COUPLER

- 3528 LED coupler



HE-3528T 10 PACK

ADAPTER

- 3528 LED T-adapter



HE-3528RA 10 PACK

ADAPTER

- 3528 LED right angle adapter

ACCESSORIES LED STRIPS



H-QC5050 1 COLOR

QUICK CONNECT

- Quick connector for single color 5050 LED - 4 PACK
- 10 PACK - in anti-static bag **HE-QC5050**



H-EC5050 1 COLOR

EXTENSION CONNECT

- Extension connector for single color 5050 LED - 2 PACK
- 10 PACK - in anti-static bag **HE-EC5050**



H-QCRP 1 COLOR

QUICK CONNECT

- Quick connector with 12" lead for single color 3528 LED - 4 PACK
- 10 PACK - in anti-static bag **HE-QC**



H-ECRP 1 COLOR

QUICK CONNECT

- 12" extension connector for single color 3528 LED - 2 PACK
- 10 PACK - in anti-static bag **HE-EC**

ALUMINUM SURFACE MOUNT TRACK

3 FOOT

HE-ATCL CLEAR, SURFACE MOUNT

HE-ATFL FROSTED, SURFACE MOUNT

HE-AFMTCL CLEAR, FLUSH MOUNT

HE-AFMTFL FROSTED, FLUSH MOUNT

HE-ATCLIPS 10 PACK

- To be used with the HE-ATFL or HE-ATCL tracks

- Aluminum surface mount track available in both clear and frosted cover for use with the 3528 and 5050 LED strip lights
- Provides a decorative look and secure place to attach your LED strip lights
- Flush mount requires a 5/8" wide 1/4" deep opening
- Hardware included



ACCENT LIGHTS



3 WATT

0.75" BLACK FACE

HE-BALW

WHITE

HE-BALB

BLUE

HE-BALR

RED

HE-BALY

YELLOW

HE-BALG

GREEN

HE-BALPP

PURPLE

Black or silver aluminum accent lights come in 6 colors; white, blue, red, yellow, green and purple. 3-watt COB LED, IP65 rated, and sold in pairs. Great for lighting up foot wells or highlighting installations.



3 WATT

0.75" SILVER FACE

HE-SALW

WHITE

HE-SALB

BLUE

HE-SALR

RED

HE-SALY

YELLOW

HE-SALG

GREEN

HE-SALPP

PURPLE

RGB1-UNDGLED

RGB

4 LED TUBE UNDER GLOW

NEW!



RGB LEDS

- Includes (2) 48 inch and (2) 36 inch LED tubes
- Dual connection to controller maximum current and even illumination
- Requires RGB-CB1 controller (sold separately)
- Mounting hardware and extension cables included

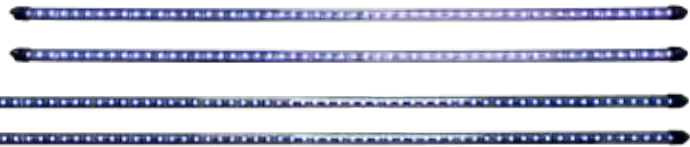

FOR HEISE RGB

ADDITIONAL ACCESSORIES

RGB-CB1

4 TRIGGERS

RGB CONTROL BOX

- App controlled Android™ / iOS®
- Wireless BLE control
- 16 million color options
- Group multiple devices
- Camera color capture
- Sync lighting to your music
- Rainbow, water and fire patterns
- Fade, blink and pulsating transitions
- 4 programmable triggers
- Handles up to 10 amps of lights



ACCENT LIGHTS

HE-TL1 **1.5x3** INCH **3** LED **★ IP68 ★ CERTIFIED**

SINGLE AUXILIARY LIGHT POD

White: (3) 5W CREE LEDs • **Wattage:** 15W
Color: (3) 3W CREE LEDs • **Wattage:** 9W

CONSTRUCTION

Housing Material: Black Die-Cast Aluminum Housing
Hardware: Black Screws

OPERATION

Current Consumption @ 13.8 Volts: .2A

** PODS SOLD INDIVIDUALLY*



WHITE LED

HE-TL1R RED

HE-TL1A AMBER

HE-TL1B BLUE

HE-TL1G GREEN

HE-ML1 **1.5x3** INCH **3** LED **★ IP68 ★ CERTIFIED**

SINGLE AUXILIARY LIGHT POD

White: (3) 5W CREE LEDs • **Wattage:** 15W
Color: (3) 3W CREE LEDs • **Wattage:** 9W

CONSTRUCTION

Housing Material: White Die-Cast Aluminum Housing
Hardware: Stainless 316

OPERATION

Current Consumption @ 13.8 Volts: .2A

** PODS SOLD INDIVIDUALLY*



WHITE LED

HE-ML1B BLUE

COLOR CHART

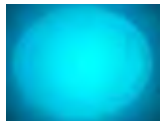

BLUE

COMMON FEATURES

INPUT VOLTAGE: 10-30V DC
BEAM PATTERN: 120° FLOOD
RAW LUMENS: 1200lm/720lm
COLOR: 3-3W CREE LEDS
LENS MATERIAL: PC

MOUNTING: TWO RUBBER BASES INCLUDED
OPERATING TEMPERATURE: -40°F TO +140°F
IP RATING: IP68

ADDITIONAL ACCESSORIES

ACCENT LIGHTING COVERS



HE-TL1DIV

The light cover is for use with the HE-TL1, HE-TL1R, HE-TL1B, HE-TL1A and HE-TL1G



HE-ML1DIV

The light cover is for use with the HE-ML1, HE-ML1R, HE-ML1B, HE-ML1A and HE-ML1G

MOUNTING BASE



HE-ARB1

The angled base is for use with the HE-TL1, HE-ML1 and all colors within series

ACCENT LIGHTS

HE-FMTL1 **1.5x3** INCH **3** LED ***IP68*** **CERTIFIED**

SINGLE FLUSH MOUNT AUXILIARY LIGHT POD

Input Voltage: 10-30V DC
White: (3) 5W CREE LEDs • **Wattage:** 15W
Color: (3) 3W CREE LEDs • **Wattage:** 9W
Raw Lumens: 1200lm/720lm • **Beam Pattern:** 120° Flood

CONSTRUCTION

Housing Material: Black Die-Cast Aluminum Housing
Lens Material: PC • **Hardware:** Black Screws
Mounting: Cutout Template and Gasket Included

OPERATION

Operating Temperature: -40° F to +140° F
Current Consumption @ 13.8 Volts: .2A • **IP Rating:** IP68

Also available in these colors:

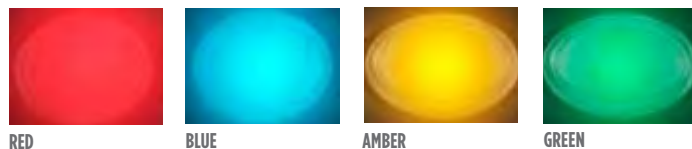

WHITE LED

- HE-FMTL1R** RED
- HE-FMTL1B** BLUE
- HE-FMTL1A** AMBER
- HE-FMTL1G** GREEN

** PODS SOLD INDIVIDUALLY*

72 WATT **24** LED **INTERIOR CABIN LIGHT WITH SWITCH**

ML-CLWHT WHITE

ML-CLBLU BLUE

Input Voltage: 10-30V DC • **White:** (24) 3-watt LEDs
Housing: Aluminum • **Mount:** Surface

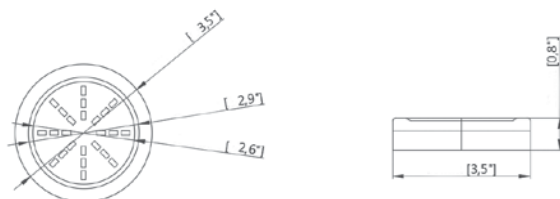



VEHICLE LIGHTING



VEHICLE LIGHTING



VEHICLE HEADLIGHT REPLACEMENT

5x7 INCH **17** LED

HE-5X7B1 BLACK FRONT FACE

Wattage: (17) 5-watt LEDs for a total of 85 watts
2400lm low beam, draws 4.3A @ 13.8v
3500lm high beam, draws 6.2A @ 13.8v



5x7 INCH **17** LED

HE-5X7S1 SILVER FRONT FACE

Wattage: (17) 5-watt LEDs for a total of 85 watts
2400lm low beam, draws 4.3A @ 13.8v
3500lm high beam, draws 6.2A @ 13.8v



4x6 INCH **18** LED

HE-4X6B1 BLACK FRONT FACE

Wattage: (18) 3-watt LEDs for a total of 60 watts
2400lm low beam, draws 2.9A @ 13.8v
3500lm high beam, draws 4.3A @ 13.8v



4x6 INCH **18** LED

HE-4X6S1 SILVER FRONT FACE

Wattage: (18) 3-watt LEDs for a total of 60 watts
2400lm low beam, draws 2.9A @ 13.8v
3500lm high beam, draws 4.3A @ 13.8v



COMMON FEATURES

HOUSING: DIE-CAST ALUMINUM

LED COLOR: 6500K

LENS: POLYCARBONATE

IP RATING: IP67

VEHICLE HEADLIGHT REPLACEMENT

7 INCH **9** LED **ROUND**

JP-701B BLACK FRONT FACE PAIR

JP-701S SILVER FRONT FACE PAIR

Wattage: (9) 5-watt LEDs for a total of 45 watts
2400lm low beam
3600lm high beam

- Values are for the set



7 INCH **9** LED **ROUND WITH FULL HALO**

JP-702B BLACK FRONT FACE PAIR

JP-702S SILVER FRONT FACE PAIR

Wattage: (9) 5-watt LEDs for a total of 45 watts
2400lm low beam
3600lm high beam

- White angel eye halo connects to running lights and flashes amber with turn signal connection
- Values are for the set



7 INCH **6** LED **ROUND WITH PARTIAL HALO**

JP-703B BLACK FRONT FACE PAIR

JP-703S SILVER FRONT FACE PAIR

Wattage: (6) 10-watt LEDs for a total of 60 watts
2000lm low beam
3000lm high beam

- White angel eye halo connects to running lights and flashes amber with turn signal connection
- Values are for the set



7 INCH **21** LED **ROUND WITH PARTIAL HALO**

JP-704B BLACK FRONT FACE PAIR

Wattage: (21) 5-watt LEDs for a total of 105 watts
3000lm low beam
5500lm high beam

- White partial angel eye halo connects to running lights and flashes amber with turn signal connection
- Values are for the set



VEHICLE HEADLIGHT REPLACEMENT

7 INCH **2** LED **ROUND**

JP-705B REFLECTIVE HOUSING PAIR

Wattage: (2) 10-watt LEDs for a total of 20 watts
1000lm low beam
1600lm high beam

- White light bar connects to running lights, flashes amber with turn signal connection
- Values are for the set



7 INCH **15** LED **RGB BLACK FRONT FACE PAIR**

JP-704RGB

Wattage: 75 watts
2200lm low beam
4000lm high beam

- Polycarbonate lens cover is virtually unbreakable
- Requires RGB-CB1 control box required for operation (sold separately)
- Values are for the set



RGB LEDs



4 INCH **15** LED **RGB BLACK FRONT FACE PAIR**

JP-704RGBFL **NEW!**

Wattage: 30 watts
Raw Lumens: 1600lm

- Polycarbonate lens cover is virtually unbreakable
- Standard 9145 connector
- LED color temp 6500K
- Number of RGB LEDs (per light): 6 LEDs, 0.2W/LED
- Number of halo LEDs (per light): 12 LEDs, 0.2W/LED
- Requires RGB-CB1 control box required for operation (sold separately)
- Values are for the set



RGB LEDs



ADDITIONAL ACCESSORIES

FOR HEISE RGB AND 704RGB HEADLIGHTS/FOG LIGHTS

RGB-CB1 **4 TRIGGERS** **RGB CONTROL BOX**

- App controlled Android™ / iOS®
- Sync lighting to your music
- Wireless BLE control
- Rainbow, water and fire patterns
- 16 million color options
- Fade, blink and pulsating transitions
- Group multiple devices
- 4 programmable triggers
- Camera color capture
- Handles up to 10 amps of lights



VEHICLE HEADLIGHT REPLACEMENT

7 INCH

6 LED

**ROUND WITH
RGB FULL HALO**

HE-PBHL702RGB BLACK FRONT FACE PAIR

Wattage: (6) 10-watt CREE LEDs per housing
2000lm low beam, draws 1.9A @ 13.8v
3000lm high beam, draws 2.7A @ 13.8v

- Standard H4 connector
- Requires RGB-CB3 control box required for operation (sold separately)



4 INCH

3 LED

**RGB ANGEL EYE HALO
CONNECTS TO RUNNING LIGHTS**

HE-JWBFL02RGB BLACK FRONT FACE PAIR

Wattage: (3) 10-watt CREE LEDs per housing
Raw Lumens: 1200lm (set)
Current Consumption @ 13.8V: 1.4A (halo off) 1.6A (halo on)

- Standard 9145 connector
- Requires RGB-CB3 control box required for operation (sold separately)



COMMON FEATURES

LENS: POLYCARBONATE **COLOR TEMP:** 6500K

ADDITIONAL ACCESSORIES

FOR HEISE 702RGB HEADLIGHTS/FOG LIGHTS

RGB-CB3

4 TRIGGERS

RGB CONTROL BOX

- App controlled Android™ / iOS®
- Wireless BLE control
- 16 million color options
- Group multiple devices
- Camera color capture
- Sync lighting to your music
- Rainbow, water and fire patterns
- Fade, blink and pulsating transitions
- 4 programmable triggers
- Handles up to 10 amps of lights



JP-706RGBKT

7 INCH

9 LED

**7" HEADLIGHT PAIR, 4" FOG LIGHT PAIR,
RGB CONTROLLER AND 7" RETAINING RING**

Wattage: Headlights (9) 5-watt LEDs for a total of 45 watts
Fog lights (6) 5-watt LEDs for a total of 30 watts
Headlights: 2400lm low beam, 3600lm high beam
Fog lights: 1400lm

- Addressable LEDs
- 120 color changing patterns
- App controlled (Car-lights app)
- Compatible with Android™ and iOS®
- 4-channel controller included
- DIY pattern functions
- Music sync functions



LIGHTING ACCESSORIES

2010 -UP*

2 PACK

**9145 CONNECTOR TO
PSX24W CONNECTOR**

JP-JWFLAH ADAPTER HARNESS

- Adapter harness for fog lights
- Adapts 9145 connector to PSX24W connector
- Use with fog lights JP-701FLS, JP-701FLB, JP-702FLB, JP-704RGBFL or JP-706RGBFL
- Makes connections plug-n-play
- Comes (2) in a package
- **Jeep JL fog light harness**



2007 -UP*

2 PACK

JP-H4H13DE H4 CONNECTOR TO H13 CONNECTOR

- Includes CANBUS decoder to eliminate bulb out light and flickering of headlight
- Use with any of the 7" headlights in 2007 and newer Jeep Wranglers
- Comes as a set: (2) adapters (2) CANBUS decoders



TURN/RUNNING/BRAKE LIGHTS



H-TTLB48 **48** INCH **48** LED

H-TTLB60 **60** INCH **60** LED

TAILGATE LIGHTBAR

- Pickup truck stop/turn/running light/reverse tailgate LED lightbar
- Pre-wired 4-pin trailer harness included for simple plug-n-play installation
- Reverse wire can be hard-wired in if so desired
- Sealed lightbar prevents moisture and dust from entering
- Mounts with 3M tape so no drilling required
- IP65 rated



VEHICLE HEADLIGHT REPLACEMENT

JP-JKMR **29** WATTS **11** LED

LED SIDE MIRROR COVERS

- (9) 3-watt white and (2) 1-watt amber
- Integrated running lights and turn signals
- Fits Jeep Wrangler JK 2007-2018



JP-SML1 **4** WATTS **8** LED

LED SIDE MARKERS

- (8) 2835 LEDs for a total of 4 watts
- Fits Jeep Wrangler JK 2007-2018



JP-SML2 **4** WATTS **8** LED **NEW!**

LED SIDE MARKERS

- (8) 2835 LEDs for a total of 4 watts
- Fits Jeep Wrangler JL 2018-UP*
- Fits Jeep Gladiator 2019-UP*



JP-TSL1 **4** WATTS **8** LED

LED TURN SIGNAL

- (8) 2835 LEDs for a total of 4 watts
- Has resistors built-in to eliminate bulb out warning or rapid flash
- Fits Jeep Wrangler JK 2007-2018



VEHICLE HEADLIGHT REPLACEMENT

JP-TTL

6 WATTS

6 LED

LED THIRD TAILLIGHT

- (6) 1-watt CREE LEDs
- Replaces the OEM third taillight
- Smoked lens
- Fits Jeep Wrangler JK 2007-2018



JP-TTL2

6 WATTS

6 LED

LED THIRD TAILLIGHT WITH REVERSE

- (6) 1-watt CREE LEDs
- Replaces the OEM third taillight
- Transparent lens
- Fits Jeep Wrangler JK 2007-2018



JP-TTL3T

2.5 WATTS

5 LED

NEW!

LED THIRD TAILLIGHT WITH REVERSE

- (5) 0.5-watt LEDs
- Polycarbonate lens
- Plug and play with factory connector
- IP67
- Fits Jeep Wrangler JL 2018-UP*



COMMON FEATURES

USAGE: PLUGS INTO OEM HARNESS

IP RATING: IP67

JEEP TURN/RUNNING/BRAKE LIGHTS

JP-STL **85** WATTS **85** LED

LED SPARE TIRE LIGHT

- (85) 1-watt LEDs
- Brake light
- Fits Jeep Wrangler JL 2018-UP*
- Fits Jeep Wrangler JK 2007-2018



19 WATTS **32** LED **LED GRID TAILLIGHT**

JP-TL01T **TRANSPARENT LENS**

JP-TL01S **SMOKED LENS**

- Turn signal (14) 1-watt LEDs, brake light (6) .5-watt LEDs and running light (12) .2-watt LEDs
- Gives your Jeep Wrangler a new, updated look
- Fits Jeep Wrangler JK 2007-2018



JP-TL02T **38** WATTS **29** LED

LED BAR TAILLIGHT

- Turn signal (10) 1-watt LEDs, brake light (2) 3-watt LEDs and running light (17) 1-watt LEDs (each)
- Gives your Jeep Wrangler a rugged look
- Fits Jeep Wrangler JK 2007-2018



JP-TL03T **42** WATTS **21** LED

LED LUX TAILLIGHT

- Turn signal, brake light, and running light
- (21) 1-watt LEDs (each)
- 30 watts high-output reverse light
- Gives your Jeep Wrangler a rugged look
- Fits Jeep Wrangler JK 2007-2018



JP-TL04T **42** WATTS

TJ TAILLIGHT

- Turn signal, reverse light, brake light and running light
- Built-in license plate light
- Fits Jeep Wrangler TJ 1998-2006



COMMON FEATURES

USAGE: PLUGS INTO OEM HARNESS **LED COLOR:** 2000K **IP RATING:** IP67

LED BULBS



LED **25** WATTS PER BULB

- Sold in pairs
- 2nd generation LED chipset
- 6500K color temperature with 3000K & 8000K films
- 6000 lumens
- 25 watts per bulb (single beam kits)
- IP67 rated
- Operating temperature: -40°F to 176°F
- Keep your original factory bulbs so that you can replace them for use on public roads. Keep the box that the new bulbs came in to store the bulbs and be sure to handle them with care when removing and re-installing

SINGLE BEAM

HE-H1LED	HE-H16LED	HE-PSX24LED
HE-H3LED	HE-5202LED	HE-PSX26LED
HE-H7LED	HE-880LED	HE-P13LED
HE-H8LED	HE-881LED	
HE-H9LED	HE-9005LED	
HE-H10LED	HE-9006LED	
HE-H11LED	HE-9012LED	

DUAL BEAM

HE-H4LED
HE-H13LED
HE-9004LED
HE-9007LED



CANBUS DECODERS

- Use with vehicles that have CANBUS systems that monitor the headlights
- Stops the headlights from flashing and have simple plug-n-play connections



PACKAGED PAIR

HE-H4D	HE-9007D	HE-H9D	HE-H16D	HE-9006D	HE-PSX24D	HE-H3D
HE-H13D	HE-H7D	HE-H10D	HE-P13D	HE-9012D	HE-5202D	HE-880D
HE-9004D	HE-H8D	HE-H11D	HE-9005D	HE-PSX26D	HE-H1D	HE-881D

LOAD RESISTOR

HE-LR **50** WATTS **1** PAIR

6 OHM LOAD RESISTOR

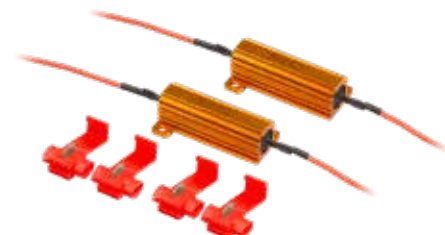

LED BULBS PRO SERIES - HID

NEW!

16,000
LUMENS | 70W

260%
BRIGHTER THAN
OTHER LEDS

HID to LED CONVERSION

Introducing Heise's first HID to LED conversion bulbs. These five Pro Series bulbs cover every application of HID currently available on the market. Matched with a brand new extreme LED chipset, they not only outlast but will outperform HID bulbs. These bulbs are meticulously designed optimizing the LED position to maximize the headlight housing optics for both projector and reflector systems.

The "C" designation given to these bulb is in reference to the unique collar design that allows them to be properly keyed into projector "S" housings and reflector "R" housings.

- Keep your original factory bulbs so that you can replace them for use on public roads. Keep the box that the new bulbs came in to store the bulbs and be sure to handle them with care when removing and re-installing

NOT FOR USE
ON PUBLIC ROADS



HE-D1CPRO

FITS: D1S & D1R



HE-D2CPRO

FITS D2S & D2R



HE-D3CPRO

FITS D3S, D3R & D8S



HE-D4CPRO

FITS D4S & D4R



HE-D5CPRO

FITS D5S & D5R



LED BULBS PRO SERIES SINGLE & DUAL BEAM

NEW!

260%
BRIGHTER THAN
OTHER LED



NOT FOR USE
ON PUBLIC ROADS

SINGLE BEAM

SINGLE BEAM & DUAL BEAM

- 16,000 lumens / 70 watts* / 6500K color temp
- 260% brighter than other LED bulbs
- Built-in reverse polarity protection
- Side cable connection for slimmer installation
- IC Thermal controller with high speed smart fan
- 2mm solid copper thermodynamic core
- Rotatable collar for beam pattern adjustment
- IP65 Rated

- Instantaneous full lumen start-up
 - Voltage: 12V-24V
 - Keep your original factory bulbs so that you can replace them for use on public roads. Keep the box that the new bulbs came in to store the bulbs and be sure to handle them with care when removing and re-installing
- * Ratings for bulb set



HE-H1PRO



HE-H3PRO



HE-H7PRO



HE-H8PRO



HE-H9PRO



HE-H10PRO



HE-H11PRO



HE-H16PRO



HE-5202PRO



HE-9005PRO



HE-9006PRO



HE-9012PRO



HE-PSX24PRO



HE-PSX26PRO



HE-880PRO



HE-881PRO



HE-P13PRO

DUAL BEAM



HE-H4PRO



HE-H13PRO



HE-9004PRO



HE-9007PRO

AUXILIARY LIGHTING

HE-DRL2PK-55 **5.5** INCH **2** PACK

- Self-adhesive
- LED color: white
- Voltage: 12V DC

HE-DRL2PK-67 **6.7** INCH **2** PACK

- Self-adhesive
- LED color: white
- Voltage: 12V DC



TURN / BRAKE / BACKUP BULBS

INTEGRATED INTERNAL CANBUS SYSTEM

REPLACEMENT BULBS **2** PACK



COLOR	T10 APPLICATIONS
WHITE	HE-CT10W
AMBER	HE-CT10A
RED	HE-CT10R NEW!



COLOR	T15 APPLICATIONS
WHITE	HE-CT15W
AMBER	HE-CT15A
RED	HE-CT15R NEW!



COLOR	1156 APPLICATIONS
WHITE	HE-C1156W
AMBER	HE-C1156A



COLOR	1157 APPLICATIONS
WHITE	HE-C1157W
AMBER	HE-C1157A



COLOR	7440 APPLICATIONS
WHITE	HE-C7440W
AMBER	HE-C7440A



COLOR	7443 APPLICATIONS
WHITE	HE-C7443W
AMBER	HE-C7443A



COLOR	3156 APPLICATIONS
WHITE	HE-C3156W
AMBER	HE-C3156A



COLOR	3157 APPLICATIONS
WHITE	HE-C3157W
AMBER	HE-C3157A

BULB REPLACEMENT GUIDE

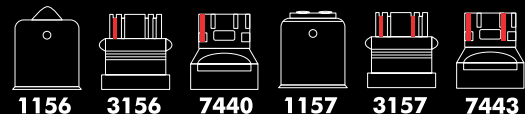

MOTORCYCLE®

Saddle Tramp

ACCESSORIES



MOTORCYCLE

MOTORCYCLE

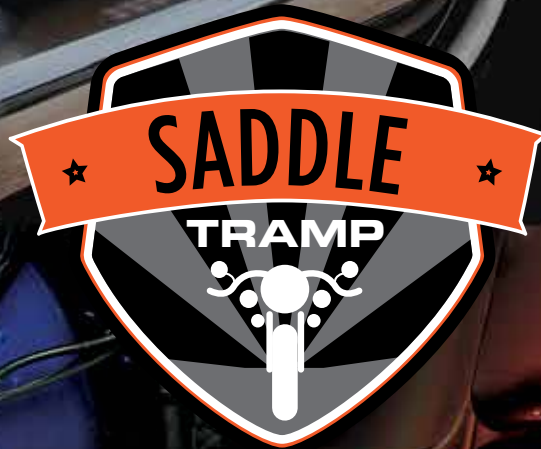

MOTORCYCLE HEADLIGHTS

7 INCH **9** LED **ROUND**

BC-701B **BLACK FRONT FACE**

BC-701S **SILVER FRONT FACE**

Wattage: (9) 5-watt LEDs for a total of 45 watts
2400lm low beam
3600lm high beam



7 INCH **9** LED **ROUND WITH FULL HALO**

BC-702B **BLACK FRONT FACE**

Wattage: (9) 5-watt LEDs for a total of 45 watts
2400lm low beam
3600lm high beam

- RGB angel eye halo



7 INCH **6** LED **ROUND WITH PARTIAL HALO**

BC-703S **SILVER FRONT FACE**

Wattage: (6) 10-watt LEDs for a total of 60 watts
2000lm low beam, draws 1.9A @ 13.8v
3000lm high beam, draws 2.7A @ 13.8v



COMMON FEATURES

LED COLOR: 6500K **CONNECTOR:** H4 **HOUSING:** DIE-CAST ALUMINUM **LENS:** POLYCARBONATE

MOTORCYCLE HEADLIGHTS

5.6 INCH **8** LED **ROUND WITH PARTIAL HALO**

BC-561B BLACK FRONT FACE

BC-561S SILVER FRONT FACE



Wattage: (8) 5-watt LEDs for a total of 45 watts
1350lm low beam, draws 1.6A @ 13.8v
1770lm high beam, draws 2.1A @ 13.8v

- White partial angel eye halo connects to running lights and flashes amber with turn signal connection

5.6 INCH **9** LED **ROUND**

BC-562B BLACK FRONT FACE

BC-562S SILVER FRONT FACE



Wattage: (8) 5-watt LEDs and (1) 10-watt LED for a total of 55 watts
2800lm low beam
3450lm high beam

2004-2013
FITS HARLEY-DAVIDSON® ROAD GLIDES

5.6 INCH **9** LED **DUAL ROUND**

BC-RGHKB BLACK FRONT FACE



Wattage: (9) 5-watt LEDs for a total of 45 watts
2000lm low beam, draws 1.2A @ 13.8v
3500lm high beam, draws 1.9A @ 13.8v

COMMON FEATURES

LED COLOR: 6500K **CONNECTOR:** H4 **HOUSING:** DIE-CAST ALUMINUM **LENS:** POLYCARBONATE

MOTORCYCLE HEADLIGHTS RGB KITS

7 INCH **4** LED **ROUND WITH RGB HALO**

HE-BHL702RGB BLACK FRONT FACE PAIR

Wattage: (4) 10-watt CREE LEDs
 2000lm low beam, draws 1.9A @ 13.8v
 3000lm high beam, draws 2.7A @ 13.8

- RGB angel eye halo



RGB LEDs



Includes RGB control box



7 INCH **9** LED **ROUND WITH RGB HALO**

BC-706RGBKT BLACK FRONT FACE

7" HEADLIGHT WITH (2) 4.5" AUXILIARY LIGHTS, RGB CONTROLLER AND 7" RETAINING RING

Wattage: Headlights (9) 5-watt LEDs for a total of 45 watts
 Auxiliary lights (6) 5-watt LEDs for a total of 30 watts
 Headlights: 2400lm low beam, 3600lm high beam
 Auxiliary lights: 1400lm

- Addressable LEDs
- 120 color changing patterns
- DIY pattern functions
- Music sync functions
- App controlled (Car-lights app)
- Compatible with Android™ and iOS®



RGB LEDs



MOTORCYCLE AUXILIARY LIGHTS

4.5 INCH **6** LED AUXILIARY PAIR

BC-451B BLACK FRONT FACE

BC-451S SILVER FRONT FACE

Wattage: (6) 5-watt LEDs for a total of 30 watts
1440lm (set)



4.5 INCH **6** LED AUXILIARY PAIR

BC-452B BLACK FRONT FACE

BC-452S SILVER FRONT FACE

Wattage: (6) 5-watt LEDs for a total of 30 watts
1440lm (set)



BC-LBFL **4.5** INCH FOG LIGHT **NEW!**

LED PROJECTOR LIGHT

- **Current Consumption @13.8V:** 0.55A (Low Beam), 0.13A (Fog), 0.3A (Strobe)
- **Wattage:** 30W
- **Raw Lumens:** 1200LM
- **3-Way Switchback:** Low Beam/Fog Light/Strobe
- Clamp mount design
- Sold individually



COMMON FEATURES

LED COLOR: 6500K **CONNECTOR:** 9145 **HOUSING:** DIE-CAST ALUMINUM **LENS:** POLYCARBONATE

MOTORCYCLE HEADLIGHT HOUSING

MULTI-FIT HEADLIGHT HOUSING BUCKET
FITS MOST HARLEY-DAVIDSON®

BC-HDBUC1 **5.6** INCH HEADLIGHT
CHROME



1984-2006
MULTI-FIT HEADLIGHT HOUSING BUCKET
FITS MOST HARLEY-DAVIDSON®

BC-HDBUC2 **5.6** INCH HEADLIGHT
GLOSS BLACK



1992-2017
FOG/PASSING LIGHT HOUSING BUCKET
FITS MOST HARLEY-DAVIDSON® | INDIAN | YAMAHA

BC-HDBUC5 **4.5** INCH FOG LIGHT
GLOSS BLACK



1992-2017
FOG/PASSING LIGHT HOUSING BUCKET
FITS MOST HARLEY-DAVIDSON® | INDIAN | YAMAHA

BC-HDBUC6 **4.5** INCH FOG LIGHT
CHROME



COMMON FEATURES

TRIM RING: INCLUDED **CONNECTOR:** H4 **MOUNT:** STAINLESS STEEL

MOTORCYCLE TRIM RINGS & BRAKELIGHTS

RETAINING RING

FITS MOST 2013-OLDER HARLEY-DAVIDSON®

7 INCH

ROUND
ADAPTER

BC-HB7 CHROME FRONT FACE

- Use when replacing 7" headlights on 2013 and older Harley-Davidson® motorcycles
- Zinc plated for corrosion resistance



LIGHT TRIM RING

FITS MOST 1983-2017 HARLEY-DAVIDSON®

7 INCH

VISOR STYLE

BC-HDTRIM3 BLACK

BC-HDTRIM4 CHROME

- Classic 50's style profile
- Easy installation



LIGHT TRIM RING

FITS MOST 1994-2016 HARLEY-DAVIDSON®

5.75 INCH

VISOR STYLE

BC-HDTRIM1 BLACK

BC-HDTRIM2 CHROME

- Classic 50's style profile
- Easy installation



CHOPPED FENDER EDGE BRAKE LIGHTS

2004-2013

FITS HARLEY-DAVIDSON®

BC-HDTL1 RED LENS

BC-HDTL2 CLEAR LENS

- Bright, fast acting LED lamp
- 1.44W (8 LEDs @ 0.18W per LED)
- Easy installation with double-sided tape
- Low-profile, contoured to curve of chopped fender



MOTORCYCLE TAILLIGHTS

LED REPLACEMENT TAILLIGHT WITH TURN SIGNALS

1999-2016

FITS HARLEY-DAVIDSON®

BC-HDTL3 RED LENS

BC-HDTL4 CLEAR LENS

- Bright, fast acting LEDs
- Brake light, running light and turn signal
- Red brake, red running light and yellow turn signal
- Replaces stock rear tail lamp



LED REPLACEMENT TAILLIGHTS

1999-2009

FITS HARLEY-DAVIDSON®

BC-HDTL5 RED LENS

BC-HDTL6 SMOKE LENS

- Layback, angular style with low profile
- Bright, fast acting LEDs
- Brake light, running light and turn signal
- Red brake, red running light and yellow turn signal
- No cutting or splicing required
- Does not fit models with bobtail fenders



LED REPLACEMENT TAILLIGHTS

1999-2009

FITS HARLEY-DAVIDSON®

BC-HDTL7 RED LENS

BC-HDTL8 SMOKE LENS

- OE style profile
- Bright, fast acting LEDs
- Red brake, red running light and white plate light
- 20 LEDs (running & brake) + 6 LEDs (license plate)
- No cutting or splicing required
- Does not fit models with bobtail fenders



LED REPLACEMENT TAILLIGHTS

BC-HDTL9

1999-UP

FITS HARLEY-DAVIDSON®

SMOKE LENS

- Eagle claw style
- Color: black with red lens, clear protective cover
- Light source: 20 LEDs (running & brake) +6 LEDs (license plate)
- Light color: red (running), bright red (brake) and white (license plate)
- LED color temp: 6000K - 6500K



MOTORCYCLE TURN SIGNALS

TURN SIGNAL AND DRL SIDE LIGHTS FITS 2015-2020 HARLEY-DAVIDSON® ROAD GLIDE

BC-RGSM **2** PACK **31** LED **NEW!**

- Mounts to factory locations around headlight
- Integrated t-harnesses for plug and play wiring
- 6000K DRL and 3000K turn signals
- (31) 0.2W white LEDs and (31) 0.2W amber LEDs
- Black ABS housing with a polycarb lens



CHROME LED WINDSHIELD TRIM FITS 2014-UP* HARLEY-DAVIDSON®

BC-WSTSB14 **2** PACK **16** LED

- Generation II brighter, flat style LED
- 16 amber turn LEDs, 16 amber running LEDs
- 2 brightness levels: dim for running and brighter for turning



2" TURN SIGNAL WITH RUNNING LIGHT BULLET STYLE FRONT 1157 LED INSERT | FITS HARLEY-DAVIDSON®

BC-1157AW **2** PACK **48** LED

- Generation II brighter, flat style LED
- 48 white LEDs, 48 yellow LEDs
- 3.25" light housing requires adapter BC-1157RING
- * 2013 and earlier may require load equalizer*



2" TURN SIGNAL WITH RED RUNNING LIGHT BULLET STYLE FRONT 1157 LED INSERT | FITS HARLEY-DAVIDSON®

BC-1157RD **2** PACK **48** LED

- Generation II brighter flat style LED
- 48 brake LEDs, 48 running LEDs
- 3.25" light housing requires adapter BC-1157RING
- * 2013 and earlier may require load equalizer*



2" RED BRAKE WITH RED RUNNING LIGHT REAR 1156 LED INSERT | FITS HARLEY-DAVIDSON®

BC-1156RD **2** PACK **48** LED

- Generation II brighter flat style LED
- 48 turn LEDs, 48 brake LEDs
- 3.25" light housing requires adapter BC-1157RING
- * 2013 and earlier may require load equalizer*



ADDITIONAL ACCESSORIES



BC-1157RING LED RING TURN SIGNAL ADAPTER BRACKET

- Adapts BC-1157AW, BC-1157RD, BC-1156RD to fit in 3.25" light housing
- Comes with 3M automotive-grade adhesive tape pre-installed
- Made from metal alloy, with strong heat resistant adapters
- Sold as a pair

MOTORCYCLE TURN SIGNALS

LED TURN SIGNAL - SMOKE LENS

3.25 INCH

2 PACK

FITS HARLEY-DAVIDSON®

BC-PC1157A AMBER LED TURN SIGNAL/RUNNING

BC-PC1156R RED LED BRAKE LIGHT

BC-PC1157AW AMBER LED TURN SIGNAL/WHITE RUNNING



- 1156 and 1157 base styles
- Smoke colored domed lens
- Fits Harley-Davidson® with 3.25" round lights
- (24) 6-watt LEDs @ 720lm
- Direct replacement, no adapter needed
- 2013 and earlier may require load equalizer

BC-ST51

3 INCH

2 PACK

UNIVERSAL

NEW!

BAR END SEQUENTIAL TURN SIGNALS

- Sequential turn signal
- LED color: Amber
- LED count: 12 LEDs per light
- Current Consumption @ 13.8V: 0.01A (each)
- Length: 3.5"
- Set of 2



BC-ST53

3 INCH

2 PACK

UNIVERSAL

NEW!

SEQUENTIAL TURN SIGNALS

- Sequential turn signal
- Adhesive mounting
- LED color: Amber
- LED count: 12 LEDs per light
- Current Consumption @ 13.8V: 0.09A (each)
- Length: 3"
- Set of 2



HIGHWAY BAR SWITCHBACK LIGHTS - AMBER/WHITE

1.25 INCH

2 PACK

FITS HARLEY-DAVIDSON®

BC-MHBSBB BLACK

BC-MHBSBC CHROME

- Driving and signal lights
- White driving, amber turning
- Fits 1.25" round bars
- Rubber inserts included
- (12) 6-watt LEDs (6 white, 6 amber)
- 2013 and earlier may require load equalizer



MOTORCYCLE LIGHT ACCESSORIES



Download it FREE at the Apple Store or Google Play

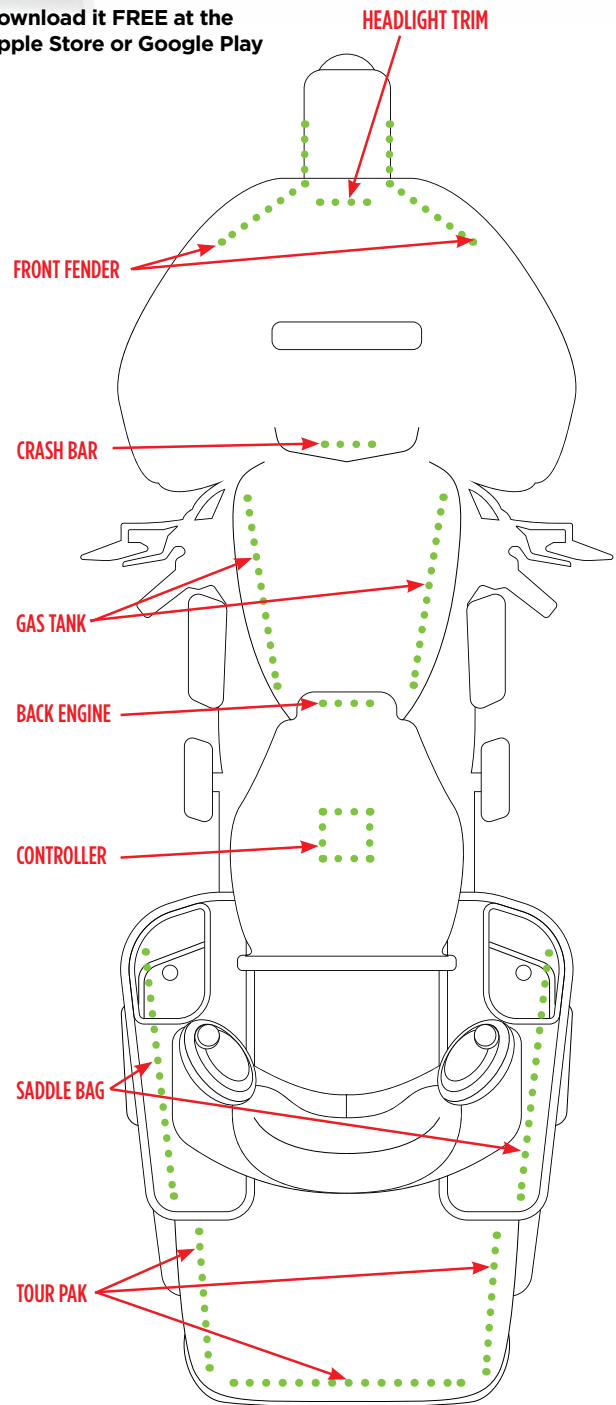

NEW 12-STRIP RGB PLUG-N-PLAY KIT!!



BC-RGB-K1
 RGB 12-LED STRIP KIT WITH CONTROLLER
FITS HARLEY-DAVIDSON® FLH AND FLT WITH TOUR-PAK®

▶ 1996-UP*

- + Kit is completely plug-n-play with OE style connections
- + Water-tight connectors
- + 5050 LED strips with black base
- + 3M adhesive backing
- + RGB colors are app controlled
- + RGB controller included
- + Trigger controls for brake and turn signals pre-wired

KIT INCLUDES

- + Plug-n-play rear lighting T-harnesses
- + 1996-2013 8-pin OE plug
- + 2010-2013 6-pin OE plug
- + 2014-UP* 6-pin OE plug
- + Independent On/Off switch that can turn your lights on with ignition off
- + Alcohol prep pads, adhesive promoter and zip ties

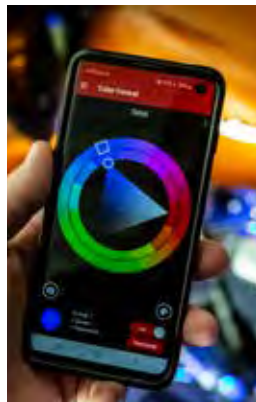

MOTORCYCLE LIGHT ACCESSORIES

NEW 6-STRIP RGB PLUG-N-PLAY KIT!!

BC-RGB-K2
 RGB 6-LED STRIP KIT WITH CONTROLLER
 FITS HARLEY-DAVIDSON® FLH AND FLT®



RGB LEDS

▶ 1996-UP*

- + Kit is completely plug-n-play with OE style connections
- + Water-tight connectors
- + 5050 LED strips with black base
- + 3M adhesive backing
- + RGB colors are app controlled
- + RGB controller included
- + Trigger controls for brake and turn signals pre-wired



KIT INCLUDES

- + Plug-n-play rear lighting T-harnesses
- + 1996-2013 8-pin OE plug
- + 2010-2013 6-pin OE plug
- + 2014-UP* 6-pin OE plug
- + Independent On/Off switch that can turn your lights on with ignition off.
- + Alcohol prep pads, adhesive promoter and zip ties

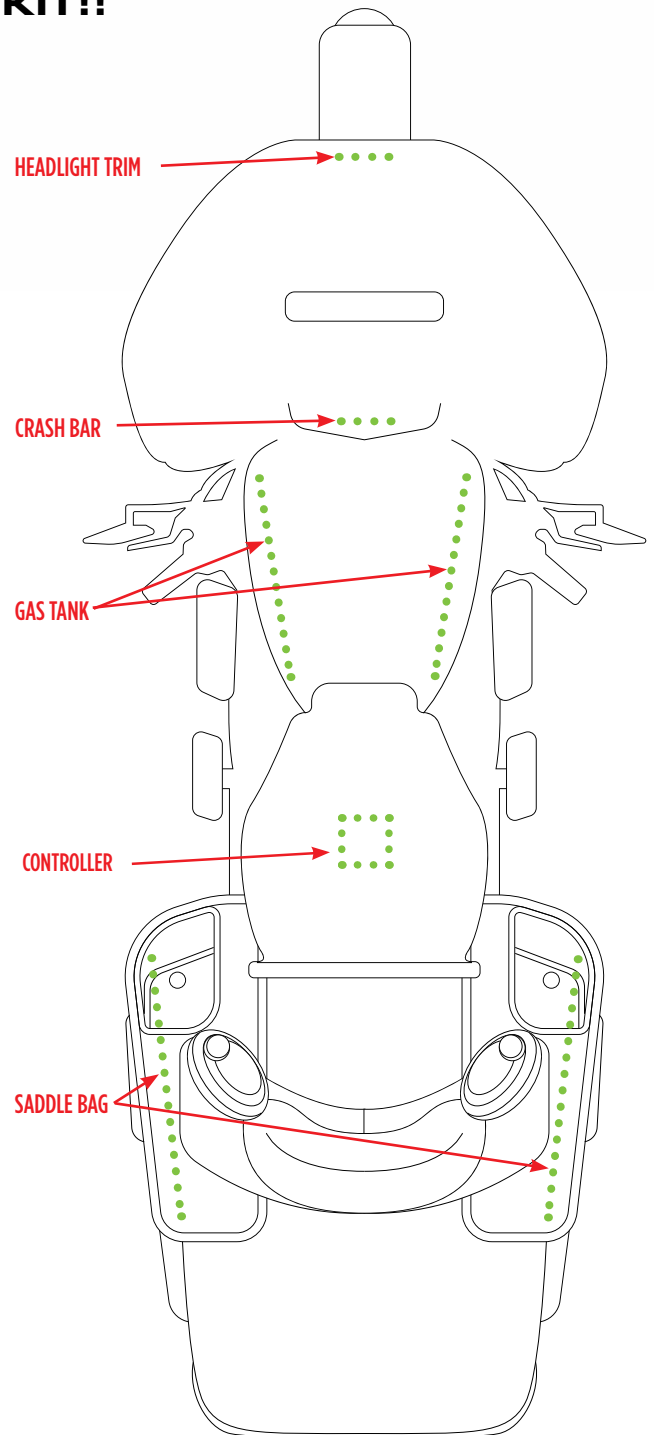

BC-RGB-PT1 UNIVERSAL

RGB HARNESS

- Female to bare end

BC-RGB-PT2 UNIVERSAL

RGB HARNESS

- Male to bare end

BC-RGB-Y1 UNIVERSAL

RGB Y HARNESS

- 1 female to 2 male ends

BC-RGB-Y2 UNIVERSAL

RGB Y HARNESS

- 1 male to 2 female ends

MOTORCYCLE LIGHT ACCESSORIES

1997-2013*

TURN SIGNAL LOAD EQUALIZER

BC-HARLE1

FITS MOST HARLEY-DAVIDSON®
TOURING GLIDES, SOFTAILS & SPORTSTERS



2010-2013*

TURN SIGNAL LOAD EQUALIZER

BC-HARLE2

FITS HARLEY-DAVIDSON® FLHX/FLTRX



- Compatible with HD factory alarm
- Stops hyper flashing when adding LED turning lights
- Plug-n-play, no cutting and splicing required

Warning! Gets extremely HOT. Do not mount on plastic and make sure it's not touching any wires

1997-2013*

BRAKE FLASHER MODULE - INCANDESCENT BULBS

BC-HDBLF

FITS MOST HARLEY-DAVIDSON®
TOURING GLIDES, SOFTAILS & SPORTSTERS



1997-2013*

BRAKE FLASHER MODULE - LED CONVERSION LIGHT

BC-HDLEDBLF

FITS HARLEY-DAVIDSON® FLHX/FLTRX



- Plug-n-play installation
- Significantly increases braking visibility
- Flashes/strobes multiple times then remain lit until brake is released

2014-UP

H4 CONNECTOR TO 4-PIN ADAPTER HARNESS

HE-H44PIN

FITS HARLEY-DAVIDSON®



- Adapts H4 to 4-pin Harley-Davidson® connector
- Use when replacing the headlight
- Some splicing may be required

BRAKE LIGHT FLASHER

IBBLF

UNIVERSAL



- For use with non-LED third brake lights
- Flashes third brake light for greater visibility

STROBE FLASH CONTROLLER

IBLEDBLF

UNIVERSAL



- For use with non-LED third brake lights
- Flashes third brake light for greater visibility



POWERSPORTS



POWERSPORTS



POWERSPORTS HEADLIGHTS

2014-2021 LED HEADLIGHTS

MPS-RZ1LEDH

1 PAIR

FITS POLARIS®
RZR EXTREME

Power: 30W/15W 6PCS CREE XTE LED CHIP
Voltage: DC10-30V
Housing Color: Black/Chrome
LED Power: 60W Halo Ring
Lumen: 3500lm High Beam, 1800lm Low Beam



- LED DRL halo white angel eye
- 2 piece Polaris® RZR LED headlights (left and right)
- Angel eyes controlled by trigger wire

2014-2021 RGB HALO BT CONTROLLED LED HEADLIGHTS

MPS-RZ1RGB

1 PAIR

FITS POLARIS®
RZR EXTREME

Power: 30W/15W 6PCS CREE XTE LED CHIP
Voltage: DC10-30V
Housing Color: Black/Black
LED Power: 60W Halo Ring
Lumen: 3500lm High Beam, 1800lm Low Beam



RGB LEDS



- 121 different flashing modes: jumping, fading, flashing, dimming, watering and running, etc.
- More than 120 different color change modes
- 2-piece Polaris® RZR LED headlights (left and right)
- App controlled (Car-lights app)
- Compatible with Android™ and iOS®

COMMON FEATURES

LED COLOR: 6000K **SOCKET TYPE:** H4 **HOUSING:** DIE-CAST ALUMINUM **WARRANTY:** 1 YEAR

HEADLIGHT ADAPTER HARNESS ATV/UTV WITH STOCK HALOGEN LIGHTS

MPS-RZRHI

FITS POLARIS®

- Compatible with stock halogen headlights



HEADLIGHT ADAPTER HARNESS ATV/UTV WITH STOCK LED LIGHTS

MPS-RZRHLH1

FITS POLARIS®

- Compatible with stock LED headlights
- Separate high and low beam connection
- Simple plug-n-play
- One pair (left & right) (4) 4-pin Delphi, (2) Deutsch connectors



POWERSPORTS RACE BAR

HE-RACBAR

29 INCH

40 LED

- **Wattage:** 24W
- **Current Consumption @ 13.8V:** 1.75A
- **IP Rating:** IP65
- **Color Configuration:** Red/Blue/Amber/Amber/Blue/Red
- **Functions:** Red - Brake/Running Lights, Blue - Slow Moving Caution Lights, Amber - Hazard lights
- **Flash Patterns:** Blue - 1 Pattern, Amber - 22 Selectable Patterns
- **Beam Pattern:** Flood

- **Housing Material:** Die-Cast Aluminum
- **Housing Color:** Black
- **Lens Material:** Polycarbonate
- **Electronics:** Integrated-Epoxy Encapsulated
- **Hardware:** Aluminum
- **Operating Temperature:** -40°F to +140°F
- **Protection:** Reverse Polarity



POWERSPORTS ACCENT LIGHTS

SIDE MIRROR SYSTEM

MPS-RBSVMS

1 PAIR

9 LED

- Aluminum alloy housing designed to withstand the most extreme punishment
- Anti-glare mirror surface
- Wide angle viewing (convex)
- Smoke colored LED lens
- Universal adjustable brackets fits 1.5" to 2.5" roll bars
- 9 LEDs each in mirror producing 4500 lumens of white light
- 1 x pair of side mirrors (left & right)
- 1 x wiring harness with relay, fuse, and carling switch
- All necessary hardware



POD LED STRING KIT

MPS-RGBWWK

4 ROPES

12 PODS

1 CONTROLLER

- Includes four (4) sets of pod LED string lights, MPS-RGBWWS4
- Includes one (1) hideaway RBG controller, MPS-RGBC-4



RGB LEDs



RGB LED CONTROLLER

MPS-RGBC-4

20 MODES

10 SPEEDS

1 CONTROLLER

- Water-resistnt RGB LED Controller
- Use RGB MPS APP to control your infinite colors
- Operational voltage: 12-24V DC
- Maximum Current: 10A
- Fused power and ground wires for easy connection



RGB LEDs



DOME LIGHT FIXTURE

MPS-DL

6 WATT

50,000 HOURS
LIFE EXPECTANCY

- IPX5 rated for RV, Marine, UTV or any vehicle
- 12 pieces of .5 watt high output/power SMD LEDs
- Touch control on/off and 10-step dimmer
- Color temperature: 6000-6500K warm white



RGBW DOME LIGHT FIXTURE

MPS-RGBWDL

6 WATT

50,000 HOURS
LIFE EXPECTANCY

- Dedicated white LED channel
- RGB LED with female micro-DIN wire
- IPX5 rated for RV, Marine, UTV or any vehicle
- 8 pieces of RGB SMD LEDs - 5 watts total
- Can be used as accent lighting
- Use with RGBW-CB2
- 10'



RGB LEDs

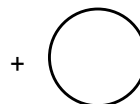

TRUE
WHITE LEDs



POWERSPORTS RGB ACCENT LIGHT KITS

RGB-CB2

4 TRIGGERS

RGB CONTROL BOX

- App controlled Android™ / iOS®
- Wireless BLE control
- 16 million color options
- Group multiple devices
- Camera color capture
- Sync lighting to your music
- Rainbow, water and fire patterns
- Fade, blink and pulsating transitions
- 4 programmable triggers
- Handles up to 10 amps of lights



RGB2-4KT

IP68

4-STRING ROCK LIGHT SET

- 4-piece kit
- 3 LED pods per strip
- 5 LEDs per pod
- 4-pin micro-DIN controller
- IP68 rated
- Works with RGB-CB2 (sold separately)



RGB LEDs



RGB2-S1

IP68

SINGLE RGB STRING LIGHT

- 3 LED pods per strip
- 5 LEDs per pod
- 4-pin micro-DIN controller
- Works with RGB-CB2 (sold separately)



RGB LEDs



MPS-RGBDL

IP68

RGB DOME LIGHT FIXTURE

- RGB LED with female micro-DIN wire
- IPX5 rated for RV, Marine, UTV or any vehicle
- 8 pieces of RGB SMD LEDs - 5 watts total
- Use with RGB-CB2 (sold separately)
- 10'



RGB LEDs



MPS-ECRGB36

RGB EXTENSION

- 36" RGB LED extension
- Male micro-DIN 4-pin and female micro-DIN 4-pin connectors



MPS-ECRGB72

RGB EXTENSION

- 72" RGB LED extension
- Male micro-DIN 4-pin and female micro-DIN 4-pin connectors



RGB-PT2

PIGTAIL ADAPTER

- 36"
- 4-pin RGBW hardwire pigtail



RGB-Y2

RGB2 "Y" ADAPTER

- 6"
- One 4-pin female micro-DIN to two micro-DIN males

POWERSPORTS RGBW ACCENT LIGHT KITS

RGBW-CB2

4 TRIGGERS

RGBW CONTROL BOX

- App controlled Android™ / iOS®
- Wireless BLE control
- 16 million color options
- Group multiple devices
- Camera color capture
- Sync lighting to your music

- Rainbow, water and fire patterns
- Fade, blink and pulsating transitions
- 4 programmable triggers
- Handles up to 10 amps of lights



RGBW2-4KT

IP68

4-STRING ROCK LIGHT SET

- RGB LED + True White LED
- 4-piece kit
- 3 LED pods per strip
- 5 LEDs per pod
- IP68
- 5-pin micro-DIN connector
- Used with RGBW-CB2 controller (sold separately)



RGBW2-S1

IP68

SINGLE RGBW STRING LIGHT

- RGB LED + True White LED
- 3 LED pods per strip
- 5 LEDs per pod
- IP68
- Used with RGBW-CB2 controller (sold separately)
- 5-pin micro-DIN connector



MPS-RGBWDL

IP68

RGBW DOME LIGHT FIXTURE

- RGBW LED dome light 5-pin
- Multiple mounting options
- 10' cable
- RGBW-CB2 (sold separately)



RGBW-36

RGB EXTENSION

- 36" RGB LED extension
- Male micro-DIN 5-pin and female micro-DIN 5-pin connectors



RGBW-72

RGB EXTENSION

- 72" RGB LED extension
- Male micro-DIN 5-pin and female micro-DIN 5-pin connectors



RGBW-PT2

HARDWIRE PLUG

- 36"
- 5-pin RGBW hardwire plug



RGBW2-Y

"Y" ADAPTER

- 6"
- One 5-pin female micro-DIN to two micro-DIN males

An aerial photograph of a white speedboat moving across a dark body of water, leaving a white wake. The image is overlaid with a semi-transparent nautical chart. The chart features a compass rose in the upper left with 'MAGNETIC' and 'ANNUAL INCREASE' markings. The boat's path is visible as a white line on the chart's grid. The text 'Metra Marine' is prominently displayed in the upper center, with 'Metra' in white and 'Marine' in blue. A red vertical bar is on the right side of the image.

Metra[®] Marine

(Aband Lt Ho) TOWER

MARINE

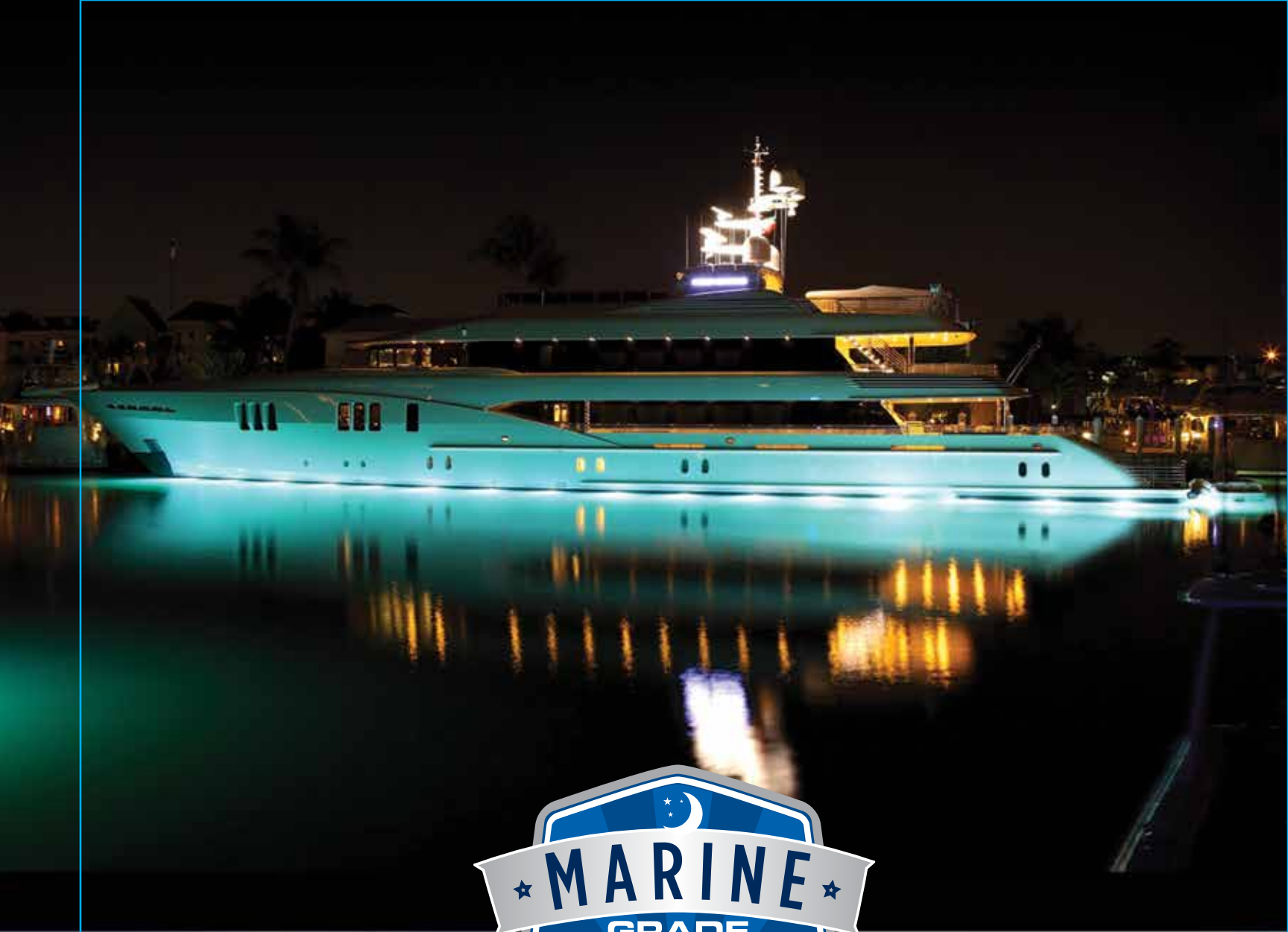

MARINE

MARINE TRANSOM LED LIGHTS

ML-BLU90W **90** WATT **30** LED

90W UNDERWATER TRANSOM LIGHT

- (30) 3-watt blue LEDs
- Hardwire connections

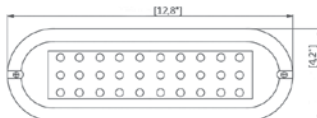

27 WATT **9** LED

27W UNDERWATER TRANSOM LIGHT

ML-WHT27W WHITE

ML-BLU27W BLUE

- (9) 3-watt LEDs
- Hardwire connections

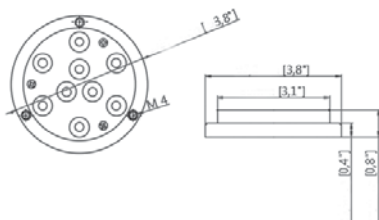

30 WATT **6** LED

30W UNDERWATER TRANSOM LIGHT

ML-WHT30W WHITE

ML-BLU30W BLUE

- (6) 5-watt LEDs
- Hardwire connections

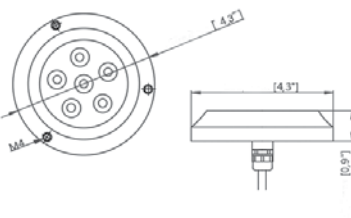

72 WATT **24** LED

INTERIOR CABIN LIGHT WITH SWITCH

ML-CLWHT WHITE

ML-CLBLU BLUE

- (24) 3-watt LEDs
- Voltage 10-30V DC
- Aluminum housing
- Hardwire connections

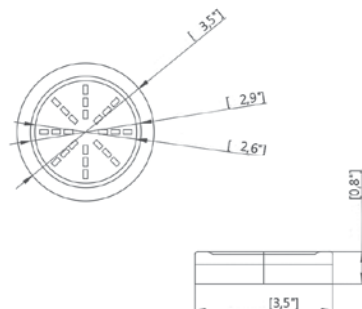

COMMON FEATURES

INPUT VOLTAGE: 10-30 VOLTS DC **HOUSING:** STAINLESS STEEL 316 **MOUNT:** SURFACE

MARINE DRAIN PLUG

9 WATT **3** LED 9W SMALL DRAIN PLUG LIGHT

ML-DLWHT9W WHITE

ML-BLU9W BLUE

ML-DLGRN9W GREEN

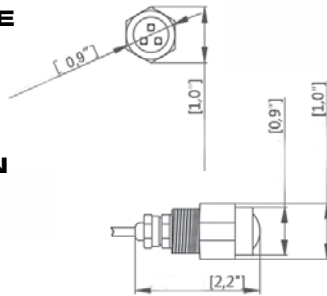

- (3) 3-watt LEDs
- Input voltage: 10-30V DC
- Housing material: Brass
- Mount: 1/2" NPT threads no drilling required
- Hardwire connections

RGB
PRODUCTS

MARINE DRAIN PLUGS

ML-DLRGB9W **9** WATT **3** LED

9W SMALL DRAIN PLUG LIGHT

- (3) 3-watt LEDs
- 4-wire RGB
- Hardwire connections

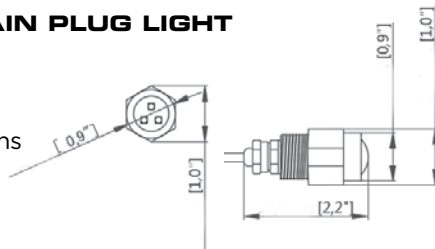

RGB LEDS

ML-DLRGB27W **27** WATT **9** LED

27W LARGE DRAIN PLUG LIGHT

- (9) 3-watt LEDs
- 4-wire RGB
- Hardwire connections

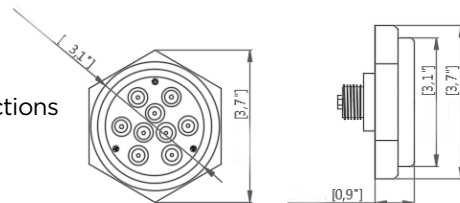

RGB LEDS

COMMON FEATURES

INPUT VOLTAGE: 10-30V DC

HOUSING MATERIAL: BRASS OR STAINLESS STEEL 316

MOUNT: 1/2" NPT THREADS NO DRILLING REQUIRED

MARINE RGB TRANSOM LED LIGHTS

ML-RGB15W **15** WATT **3** LED

15W UNDERWATER TRANSOM LIGHT

- (3) 5-watt LEDs
- 4-wire RGB
- Hardwire connections

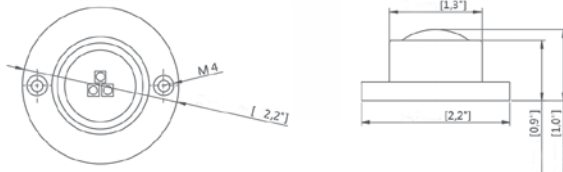

ML-RGB27W **27** WATT **9** LED

27W UNDERWATER TRANSOM LIGHT

- (9) 3-watt LEDs
- 4-wire RGB
- Hardwire connections

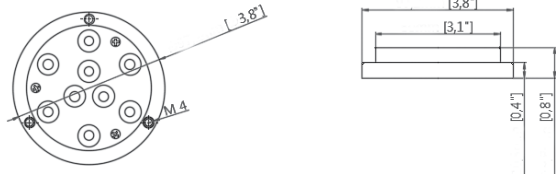

ML-RGB54W **54** WATT **6** LED

54W UNDERWATER TRANSOM LIGHT

- (6) 9-watt LEDs
- 4-wire RGB
- Hardwire connections

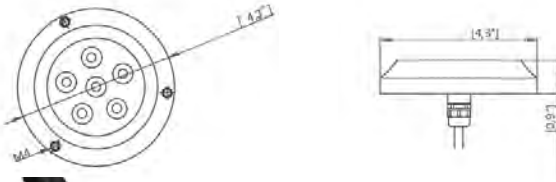

★ IP68 ★
CERTIFIED

RGB-CB1

CONTROL BOX

Required for RGB functionality on all Infinite Series lights. Sold separately.

COMMON FEATURES

INPUT VOLTAGE: 10-30V DC

HOUSING MATERIAL: STAINLESS STEEL 316

MOUNT: SURFACE

MARINE RGBW TRANSOM LED LIGHTING

ML-RGBW24W **24** WATT **6** LED

24W UNDERWATER TRANSOM LIGHT

- (6) 4-watt LEDs
- 5-wire RGBW

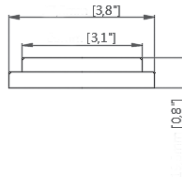
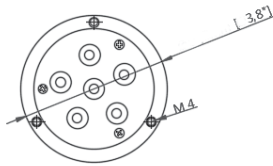

ML-RGBW72W **72** WATT **6** LED

72W UNDERWATER TRANSOM LIGHT

- (6) 12-watt LEDs
- 5-wire RGBW

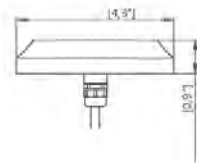
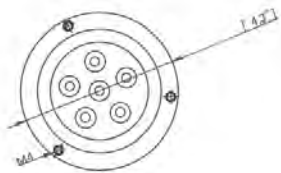

COMMON FEATURES

INPUT VOLTAGE: 10-30V DC **HOUSING MATERIAL:** STAINLESS STEEL 316 **MOUNT:** SURFACE

ADDITIONAL ACCESSORIES



RGBW CONTROL BOX

RGBW-CB1

MARINE RGB LIGHTING

HE-8MLRGBK

8 RGB PODS

3 LED

★ IP68 ★
CERTIFIED



RGB LEDS



LEDs: 8 Pods - (3) 3W CREE LEDs Per Pod
Wattage: 9W Total Per Pod • **Raw Lumens:** 720lm

The HE-8MLRGBK is a complete kit to light up your boat. (8) HE-ML1RGB RGB accent lights and the HE-CBRGB control box will give you accent lighting where you want it.



HE-4MLRGBK

4 RGB PODS

3 LED

★ IP68 ★
CERTIFIED



RGB LEDS



LEDs: 4 Pods - (3) 3W CREE LEDs Per Pod
Wattage: 9W Total Per Pod • **Raw Lumens:** 720lm

Designed as a starter kit this allows you get the RGB lights in your boat without breaking the bank but also allows you add up to four more HE-ML1RGB lights.

HE-ML1

1.5x3 INCH

3 LED

★ IP68 ★
CERTIFIED

AUXILIARY LIGHTING PODS

Input Voltage: 10-30V DC
White: (3) 5W CREE LEDs • **Wattage:** 15W
Color: (3) 3W CREE LEDs • **Wattage:** 9W
Raw Lumens: 1200lm/720lm • **Beam Pattern:** 120° Flood

CONSTRUCTION

Housing Material: White Die-Cast Aluminum Housing
Lens Material: PC • **Mounting:** Surface, Two Rubber Bases Included
Hardware: Stainless 316

OPERATION

Operating Temperature: -40° F to +140° F
Current Consumption @ 13.8 Volts: 0.2A • **IP Rating:** IP68

COLOR CHART



BLUE



WHITE LED

HE-ML1B

BLUE

MARINE LED LIGHTBARS DUAL ROW

STRAIGHT

HE-MDR8

08 INCH

12 LED

★ IP68 ★
CERTIFIED

Wattage: 36W • Raw Lumens: 2800lm • Lux @ 10M: 215
Current Consumption @ 13.8V: 1.9A • IP Rating: IP68



HE-MDR14

14 INCH

24 LED

★ IP68 ★
CERTIFIED

Wattage: 72W • Raw Lumens: 5760lm • Lux @ 10M: 466
Current Consumption @ 13.8V: 3.7A • IP Rating: IP68



HE-MDR20

20 INCH

36 LED

Wattage: 108W • Raw Lumens: 8640lm • Lux @ 10M: 612
Current Consumption @ 13.8V: 5.7A • IP Rating: IP68



MARINE LED LIGHTBARS SINGLE ROW

SPECS & MEASUREMENTS

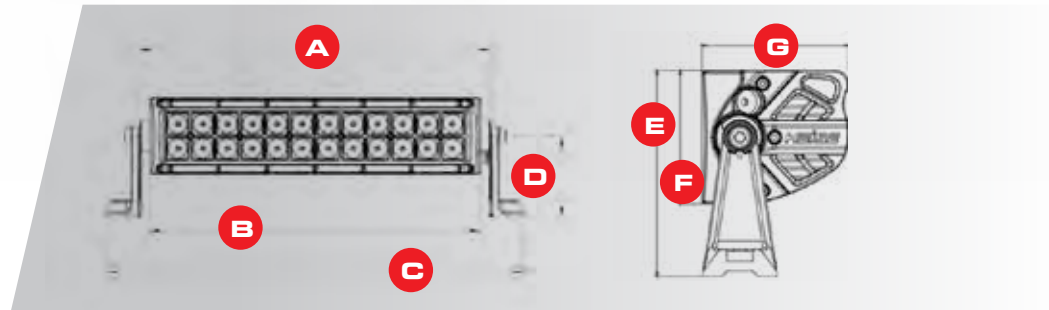

PART	A	B	C	D	E	F	G
HE-MDR8	8.07"	7.22"	10.67"	3.23"	4.8"	3.09"	3.41"
HE-MDR14	14.09"	13.27"	16.69"	3.23"	4.8"	3.09"	3.41"
HE-MDR20	20.12"	19.29"	22.72"	3.23"	4.8"	3.09"	3.41"

COMMON FEATURES



INPUT VOLTAGE: 10-30V DC

COLOR TEMPERATURE: 6000K

BEAM PATTERN: COMBO: 90° FLOOD / 8° SPOT

HOUSING MATERIAL: DIE-CAST ALUMINUM

COLOR: WHITE COATING WITH UV

MEMBRANE: GORE®

LENS MATERIAL: POLYCARBONATE

MOUNTING BOLT DRILL: 0.25"

ELECTRONICS: INTEGRATED-EPOXY ENCAPSULATED

HARDWARE: STAINLESS 316

OPERATING TEMPERATURE: -40 °F TO +140 °F

PROTECTION: REVERSE POLARITY

MARINE LED LIGHTBARS DUAL ROW

CURVED

HE-MDRC30

30 INCH

60 LED

Wattage: 180W • **Raw Lumens:** 14400lm • **Lux @ 10M:** 625
Current Consumption @ 13.8V: 9.5A • **IP Rating:** IP67



HE-MDRC42

42 INCH

80 LED

Wattage: 240W • **Raw Lumens:** 19200lm • **Lux @ 10M:** 780
Current Consumption @ 13.8V: 12A • **IP Rating:** IP67



HE-MDRC50

50 INCH

96 LED

Wattage: 288W • **Raw Lumens:** 23040lm • **Lux @ 10M:** 915
Current Consumption @ 13.8V: 14.3A • **IP Rating:** IP67



HE-MDRC54

54 INCH

100 LED

Wattage: 300W • **Raw Lumens:** 24960lm • **Lux @ 10M:** 1050
Current Consumption @ 13.8V: 16A • **IP Rating:** IP67



COMMON FEATURES



- INPUT VOLTAGE:** 10-30V DC
- COLOR TEMPERATURE:** 6000K
- BEAM PATTERN:** COMBO: 90° FLOOD / 8° SPOT
- HOUSING MATERIAL:** DIE-CAST ALUMINUM
- COLOR:** WHITE COATING WITH UV
- MEMBRANE:** GORE®
- LENS MATERIAL:** POLYCARBONATE
- MOUNTING BOLT DRILL:** 0.25"
- ELECTRONICS:** INTEGRATED-EPOXY ENCAPSULATED
- HARDWARE:** STAINLESS 316
- OPERATING TEMPERATURE:** -40°F TO +140°F
- PROTECTION:** REVERSE POLARITY

SPECS & MEASUREMENTS

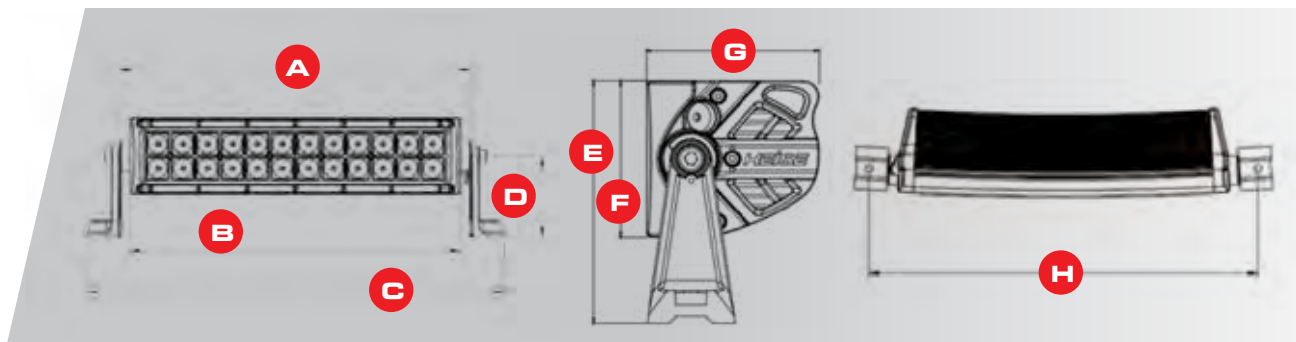

PART	A	B	C	D	E	F	G	H
HE-MDRC30	32.22"	31.44"	34.88"	3.23"	4.80"	3.09"	4.39"	33.56"
HE-MDRC42	42.09"	41.34"	41.34"	3.23"	4.80"	3.09"	5.14"	43.39"
HE-MDRC50	50.12"	49.41"	52.83"	3.23"	4.80"	3.09"	5.91"	51.38"
HE-MDRC54	54.01"	53.30"	56.72"	3.23"	4.80"	3.09"	6.30"	55.24"

MARINE HIGH OUTPUT CUBE LED LIGHTS

HE-MCL1

2 INCH

1 LED

IP68
CERTIFIED

Wattage: 10W • **Raw Lumens:** 600lm • **Lux @ 10M:** 12 • **IP Rating:** IP68
Beam Pattern: 40° Flood • **Current Consumption @ 13.8V:** 0.7A



HE-MHCL2

3 INCH

4 LED

IP68
CERTIFIED

Wattage: 12W • **Raw Lumens:** 960lm • **Lux @ 10M:** 34 • **IP Rating:** IP68
Beam Pattern: 90° Flood • **Current Consumption @ 13.8V:** 0.7A



ACCESSORIES INCLUDED

ACCENT CAPS

Customize your marine light with included color accent caps!



HE-MHCL2 AND
HE-MHCL3 ONLY

PIGTAIL



Included with all marine high output cube LED lights

COMMON FEATURES

INPUT VOLTAGE: 10-30V DC

COLOR TEMPERATURE: 6000K

HOUSING MATERIAL: DIE-CAST ALUMINUM

COLOR: WHITE COATING WITH UV INHIBITORS

LENS MATERIAL: PC

MOUNTING BRACKET: STAINLESS STEEL

ELECTRONICS: INTEGRATED-EPOXY ENCAPSULATED

HARDWARE: STAINLESS 316

OPERATING TEMPERATURE: -40°F TO +140°F

PROTECTION: REVERSE POLARITY

MARINE CUBE LED LIGHTS

HE-MCL32PK

3 INCH

6 LED

**★ IP68 ★
CERTIFIED**

2 LIGHT PACK

Wattage: 18W • **Raw Lumens:** 1440lm • **Lux @ 10M:** 18 • **IP Rating:** IP68
Beam Pattern: 90° Flood • **Current Consumption @ 13.8V:** 1.2A
Mounting Bracket: Stainless Steel



ADDITIONAL ACCESSORIES



CUBE PROTECTIVE LENS COVERS

Polycarbonate protective lens
6 colors available. Sold separately.
See page 44

COMMON FEATURES

INPUT VOLTAGE: 10-30V DC

COLOR TEMPERATURE: 6000K

HOUSING MATERIAL: DIE-CAST ALUMINUM

COLOR: WHITE COATING WITH UV INHIBITORS

LENS MATERIAL: PC

MOUNTING BRACKET: STAINLESS STEEL

ELECTRONICS: INTEGRATED-EPOXY
ENCAPSULATED

HARDWARE: STAINLESS 316

OPERATING TEMPERATURE: -40°F TO +140°F

PROTECTION: REVERSE POLARITY

MARINE FLUSH MOUNT LED LIGHTS

HE-MFMCL2

3 INCH

4 LED

★ IP68 ★
CERTIFIED

Wattage: 12W • **Raw Lumens:** 960lm

Lux @ 10M: 17 • **IP Rating:** IP68

Beam Pattern: 90° Flood

Current Consumption @ 13.8V: 0.9A

Includes gasket and cut out template



HE-MFMCL3

3 INCH

6 LED

★ IP68 ★
CERTIFIED

Wattage: 18W • **Raw Lumens:** 1440lm

Lux @ 10M: 18 • **IP Rating:** IP68

Beam Pattern: 90° Flood

Current Consumption @ 13.8V: 1.2A

Includes gasket and cut out template



ACCESSORIES INCLUDED

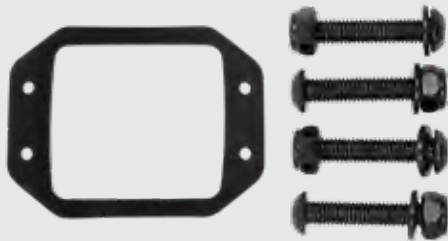

GASKET & SCREWS

Included with all Flush Mount
Cube LED Lights

COMMON FEATURES

INPUT VOLTAGE: 10-30V DC

COLOR TEMPERATURE: 6000K

HOUSING MATERIAL: DIE-CAST ALUMINUM

COLOR: WHITE COATING WITH UV INHIBITORS

LENS MATERIAL: PC

MOUNTING BRACKET: FLUSH MOUNT

ELECTRONICS: INTEGRATED-EPOXY
ENCAPSULATED

HARDWARE: STAINLESS 316

OPERATING TEMPERATURE: -40°F TO +140°F

PROTECTION: REVERSE POLARITY



MUNICIPALITY





EXTERIOR LIGHTBARS & BEACON

HE-MU47-SLM

AMBER SLIM LIGHTBAR

47.25 INCH

88 LED

Voltage: 12-24V DC • **LED Color:** White & Amber
Patterns: 25 Selectable patterns • **IP Rating:** IP65
Construction: Aluminum housing poly lens

- Wired controller with take down, alley, traffic advisor, marker switches and pattern indicator
- Amber primary lighting, white alley and take down lights



HE-MU5-BCON

AMBER LIGHT BEACON

3.5 INCH

48 LED

Voltage: 12-24V DC • **LED Color:** Amber • **Patterns:** Strobe & rotator flash patterns
IP Rating: IP65 • **Construction:** Amber poly housing

- Power outlet adapter with on/off and pattern control switch



HE-MU13-MINI

AMBER MINI LIGHTBAR

12.9 INCH

36 LED

Voltage: 12-24V DC • **LED Color:** Amber • **Patterns:** 15 self-controlled with memory
IP Rating: IP65 • **Construction:** Amber poly housing

- Power outlet adapter with on/off and pattern control switch



INTERIOR LIGHTBARS

HE-MULB-WA

REAR WINDOW LIGHTBAR

38.2 INCH

32 LED

Voltage: 12-24V DC • **LED Color:** White & Amber • **Patterns:** 16 alternative flash patterns / 3 selectable direction patterns • **IP Rating:** IP65 • **Construction:** Aluminum housing poly lens

- Includes brackets and hardware and 10ft cable
- 3-wire hardwire (power, ground, pattern select)



HE-MUWL-WA

WINDSHIELD LIGHTBAR

9.84 INCH

8 LED

Voltage: 12VDC • **LED Color:** White & Amber • **Patterns:** 16 alternative flash patterns
IP Rating: IP65 • **Construction:** Amber poly housing

- Includes suction, bracket and hardware and 10ft cable
- 3-wire hardwire (power, ground, pattern select)



CUBE LED LIGHTS

HE-CL22PK

3 INCH

4 LED

2 LIGHT PACK

Wattage: 12W • **Raw Lumens:** 960lm

Lux @ 10M: 17 lx • **IP Rating:** IP68

Beam Pattern: 90° Flood • **Current Consumption @ 13.8V:** .9A

Heise HE-DLWH1 dual light wiring harness included

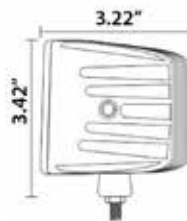

HE-CL3SA

AMBER LED CUBE

3 INCH

6 LED

Wattage: 18W • **Raw Lumens:** 1400lm

Lux @ 10M: 104 lx • **IP Rating:** IP68

Beam Pattern: 5° Spot • **Current Consumption @ 13.8V:** 1.2A

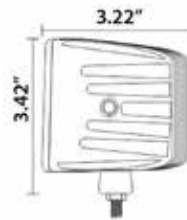

HE-CL3

3 INCH

6 LED

Wattage: 18W • **Raw Lumens:** 1440lm

Lux @ 10M: 18 lx • **IP Rating:** IP68

Beam Pattern: 90° Flood • **Current Consumption @ 13.8V:** 1.2A

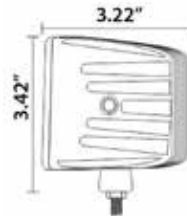

COMMON FEATURES

INPUT VOLTAGE: 10-30V DC

COLOR TEMPERATURE: 6000K

HOUSING MATERIAL: DIE-CAST ALUMINUM

COLOR: BLACK

LENS MATERIAL: PC

MOUNTING BRACKET: STAINLESS STEEL

ELECTRONICS: INTEGRATED-EPOXY ENCAPSULATED

HARDWARE: STAINLESS 316

OPERATING TEMPERATURE: -40°F TO +140°F

PROTECTION: REVERSE POLARITY

WORK LED LIGHTS

HE-WL1

3.625x2 INCH

33 LED

Wattage: 60W • **Raw Lumens:** 726lm • **Lux @ 10M:** 0.1 lx
Beam Pattern: 120° Flood • **Current Consumption @ 13.8V:** 0.3A
Lens Design: Unique waffle



3.75"W x 3"H x .75"D

HE-WL2

3.625x1.75 INCH

2 LED

Wattage: 10W • **Raw Lumens:** 800lm • **Lux @ 10M:** 28 lx
Beam Pattern: 90° Flood • **Current Consumption @ 13.8V:** 0.4A



3.50"W x 2.50"H x 2.50"D

COMMON FEATURES

INPUT VOLTAGE: 10-30V DC

COLOR TEMPERATURE: 6000K

HOUSING MATERIAL: DIE-CAST ALUMINUM

COLOR: BLACK

LENS MATERIAL: PC

MOUNTING BRACKET: DIE-CAST ALUMINUM

HOLE DIMENSIONS: MOUNTING BOLT DRILL - .25"

ELECTRONICS: INTEGRATED-EPOXY ENCAPSULATED

HARDWARE: STAINLESS 316

IP RATING: IP67

PROTECTION: REVERSE POLARITY

SAFETY/CAUTION LIGHTS

HE-MUSTR-GRW

WHITE GRILLE STROBE KIT

4 PIECE

8 LED

Voltage: 12V DC • **LED Color:** White

Patterns: 15 self-controlled with memory • **IP Rating:** IP65

- Wired controller with on/off and pattern control switch



HE-MUSTR-GRA

AMBER GRILLE STROBE KIT

4 PIECE

8 LED

Voltage: 12V DC • **LED Color:** Amber

Patterns: 15 self-controlled with memory • **IP Rating:** IP65

- Wired controller with on/off and pattern control switches



HE-MUSTR-G2A

AMBER GRILLE STROBE SET

2 PIECE

NEW!

HE-MUSTR-G2W

WHITE GRILLE STROBE SET

2 PIECE

NEW!

- 2 pack
- LED Color: Amber or White
- Hardware and harness included
- For use with HE-MUSTR-GR(x) (sold separately)



SAFETY/CAUTION LED LIGHTS

HE-MUSTR-W

LED STROBE KIT

4 PIECE

8 LED

Voltage: 12-24V DC • **LED Color:** White
Patterns: 15 self-controlled with memory • **IP Rating:** IP65

- Wired controller with on/off and pattern control switch



HE-MUSTR-S1W

LED STROBE BULB

8 LED

NEW!

- LED replacement bulb
- LED Color: White
- Sold individually
- For use with HE-MUSTR-W (sold separately)



HIDDEN STROBE LED MARKER LIGHTS

HE-MUHSR-W

WHITE STROBE

1 INCH

9 LED

HE-MUHSR-A

AMBER STROBE

HE-MUHSR-B

BLUE STROBE

HE-MUHSR-R

RED STROBE

Voltage: 12-14V DC • **LED Count:** (9) 3W • **Wattage:** 27W • **Input Voltage:** 12-24 DC
Patterns: 10 alternative flash patterns • **Current Consumption @ 13.8V:** 1.95A
IP Rating: IP65 • **Construction:** Aluminum housing poly lens

- Includes 9ft cable
- 4-wire hardwire (power, ground, synchronization/pattern select, wig-wag)



SINGLE COLOR MARKER LIGHTS

HE-MUMRK-4W	WHITE MARKER	3.8 INCH	4 LED	 <p>3.8"W x 1.1"H x 0.64"D</p>
HE-MUMRK-4A	AMBER MARKER			
HE-MUMRK-4B	BLUE MARKER			
HE-MUMRK-4R	RED MARKER			

Voltage: 12-24V DC • **LED Count:** (4) 3W
Patterns: 19 self-controlled with memory
IP Rating: IP67 • **Construction:** Aluminum housing poly lens

- Sync multiple units of the same model

HE-MUMRK-6W	WHITE MARKER	4.9 INCH	6 LED	 <p>4.9"W x 1.1"H x 0.64"D</p>
HE-MUMRK-6A	AMBER MARKER			
HE-MUMRK-6B	BLUE MARKER			
HE-MUMRK-6R	RED MARKER			

Voltage: 12-24V DC • **LED Count:** (6) 3W
Patterns: 19 self-controlled with memory
IP Rating: IP67 • **Construction:** Aluminum housing poly lens

- Sync multiple units of the same model

HE-MULTE-4W	WHITE LITE MARKER	3.4 INCH	4 LED	 <p>3.4"W x 1.1"H x 0.4"D</p>
HE-MULTE-4A	AMBER LITE MARKER			

Voltage: 12-24V DC • **LED Count:** (4) 1W
Patterns: 19 self-controlled with memory
IP Rating: IP67 • **Construction:** Aluminum housing poly lens

- Sync multiple units of the same model

SINGLE COLOR MARKER LIGHTS

HE-MULTE-6W	WHITE LITE MARKER	4.4 INCH	6 LED	
HE-MULTE-6A	AMBER LITE MARKER			
HE-MULTE-6B	BLUE LITE MARKER			
HE-MULTE-6R	RED LITE MARKER			

Voltage: 12-24V DC • **LED Count:** (6) 1W
Patterns: 19 self-controlled with memory
IP Rating: IP67 • **Construction:** Aluminum housing poly lens

4.4"W x 1.1"H x 0.4"D

- Sync multiple units of the same model

HE-MULH-4W	WHITE LIGHT HEAD	4.6 INCH	4 LED	
HE-MULH-4A	AMBER LIGHT HEAD			
HE-MULH-4B	BLUE LIGHT HEAD			
HE-MULH-4R	RED LIGHT HEAD			

Voltage: 12-24V DC • **LED Count:** (4) 1W
Patterns: 19 self-controlled with memory
IP Rating: IP67 • **Construction:** Aluminum housing poly lens

4.6"W x 1.5"H x 1.2"D

- Sync multiple units of the same model

HE-MUGRL-6W	WHITE GRILLE MARKER	4.1 INCH	6 LED	
HE-MUGRL-6A	AMBER GRILLE MARKER			
HE-MUGRL-6B	BLUE GRILLE MARKER			
HE-MUGRL-6R	RED GRILLE MARKER			

Voltage: 12-24V DC • **LED Count:** (6) 1W
Patterns: 16 self-controlled with memory
IP Rating: IP65 • **Construction:** Aluminum housing poly lens

4.1"W x 2.2"H x 0.9"D

- Sync multiple units of the same model

BI-COLOR MARKER LIGHTS

HE-MUMRK-6WA	1/2 WHITE	1/2 AMBER	4.9 INCH	6 LED
HE-MUMRK-6BA	1/2 BLUE	1/2 AMBER		
HE-MUMRK-6BR	1/2 BLUE	1/2 RED		

Voltage: 12-24V DC
LED Count: (6) 1W
Patterns: 19 self-controlled with memory
IP Rating: IP67
Construction: Aluminum housing poly lens

- Sync multiple units of the same model





4.9"W x 1.1"H x 0.64"D

HE-MULTE-6WA	1/2 WHITE	1/2 AMBER	4.4 INCH	6 LED
HE-MULTE-6BA	1/2 BLUE	1/2 AMBER		
HE-MULTE-6BR	1/2 BLUE	1/2 RED		

Voltage: 12-24V DC
LED Count: (6) 1W
Patterns: 19 self-controlled with memory
IP Rating: IP67
Construction: Aluminum housing poly lens

- Sync multiple units of the same model





4.4"W x 1.1"H x 0.4"D

HE-MUGRL-6WA	1/2 WHITE	1/2 AMBER	4.1 INCH	6 LED
HE-MUGRL-6BA	1/2 BLUE	1/2 AMBER		
HE-MUGRL-6BR	1/2 BLUE	1/2 RED		

Voltage: 12-24V DC
LED Count: (6) 1W
Patterns: 16 self-controlled with memory
IP Rating: IP65
Construction: Aluminum housing poly lens

- Sync multiple units of the same model





4.1"W x 2.2"H x 0.9"D



TRAILER



TRAILER



TRAILER LIGHT LED BAR

HE-TR1501

15.5 INCH

13 LED

**THINLINE LED STOP/TURN/
TAIL/BACKUP LIGHT**

- 10 LEDs: Stop, turn, taillight functions
- Hard wire connections
- FMVSS S T I R/U3
- @ 12VDC 0.1A for backup
- 3 LEDs for backup lights
- Red & white polycarbonate lens
- @ 12VDC 0.445A for stop/turn LEDs
- @ 12VDC 0.03A for taillight

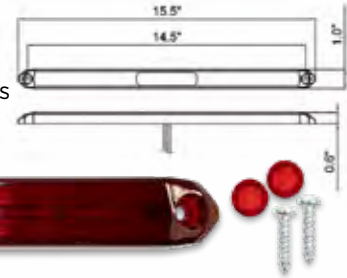

TRAILER OVAL LED LIGHTS

HE-TR6001

6 INCH

14 LED

OVAL WITH GROMMET

- 14 red LEDs: Stop, turn, taillight functions
- @ 12VDC 0.06A for taillight
- @ 12VDC 0.38A for stop/turn LEDs



HE-TR6002

6 INCH

14 LED

OVAL WITH GROMMET

- 14 amber LEDs: Turn functions
- @ 12VDC 0.06A for taillight



HE-TR6003

6 INCH

14 LED

OVAL WITH GROMMET

- 14 white LEDs: Backup function
- @ 12VDC 0.24A for backup



SPECS & MEASUREMENTS

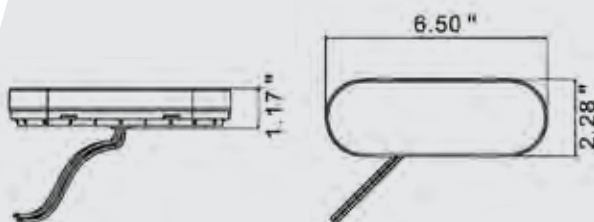

COMMON FEATURES

CONNECTOR: PL-3

HOUSING MATERIAL: ABS

LENS MATERIAL: PMMA

FMVSS: S2 T2 I6 / I6 / R

PROTECTION: WEATHER-RESISTANT

TRAILER OVAL LED LIGHTS

HE-TR6004 6 INCH 10 LED OVAL

- 10 LEDs: Stop, turn, taillight functions
- 4 LEDs for backup lights
- @ 12VDC 0.43A for stop/turn LEDs
- @ 12VDC 0.06A for taillight
- @ 12VDC 0.24A for backup



HE-TR6005 6 INCH 14 LED OVAL

- 14 red LEDs: Stop, turn, taillight functions
- @ 12VDC 0.06A for taillight
- @ 12VDC 0.38A for stop/turn LEDs



HE-TR6006 6 INCH 14 LED OVAL

- 14 amber LEDs: Turn functions
- @ 12VDC 0.06A for turn signal



HE-TR6007 6 INCH 14 LED OVAL

- 14 white LEDs: Backup function
- @ 12VDC 0.24A for backup



SPECS & MEASUREMENTS

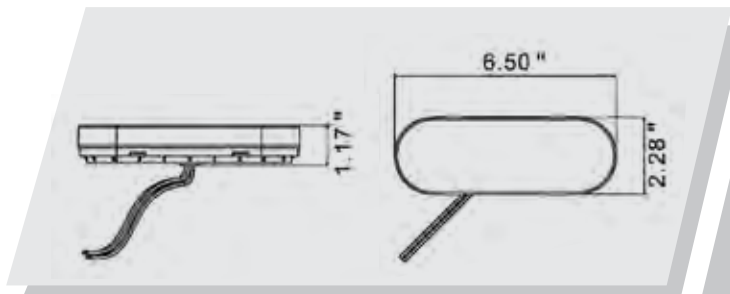

COMMON FEATURES

- CONNECTOR:** PL-3
- HOUSING MATERIAL:** ABS
- LENS MATERIAL:** PMMA
- FMVSS:** S2 T2 I6 / I6 / R
- PROTECTION:** WEATHER-RESISTANT

TRAILER ROUND LED LIGHTS

HE-TR4001 4 INCH 14 LED ROUND WITH GROMMET

HE-TR4005 4 INCH 14 LED ROUND

- 14 red LEDs: Stop, turn, taillight functions
- @ 12VDC 0.38A for stop/turn LEDs



HE-TR4002 4 INCH 14 LED ROUND WITH GROMMET

HE-TR4006 4 INCH 14 LED ROUND

- 14 amber LEDs: Turn functions
- @ 12VDC 0.06A for turn



HE-TR4003 4 INCH 14 LED ROUND WITH GROMMET

HE-TR4007 4 INCH 14 LED ROUND

- 14 white LEDs: Backup functions
- @ 12VDC 0.24A for backup



HE-TR4004 4 INCH 10 LED ROUND LED STOP/TURN/ TAIL/BACKUP LIGHT

- 10 LEDs: Stop, turn, taillight functions
- 4 LEDs for backup lights
- @ 12VDC 0.43A for stop/turn LEDs
- @ 12VDC 0.06A for taillight
- @ 12VDC 0.24A for backup



SPECS & MEASUREMENTS

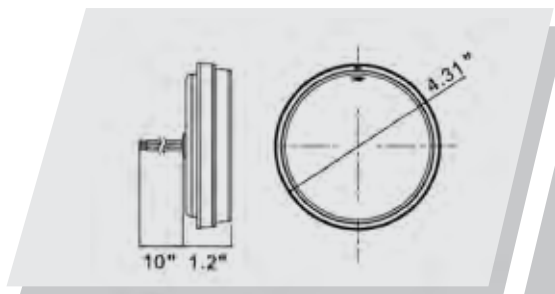

COMMON FEATURES

- CONNECTOR:** PL-3
- HOUSING MATERIAL:** ABS
- LENS MATERIAL:** PMMA
- FMVSS:** S2 T2 I6 / I6 / R
- PROTECTION:** WEATHER-RESISTANT

TRAILER MARKER/CLEARANCE LIGHT WITH REFLECTOR

HE-TRRF01	4 INCH	2 LED	RED
HE-TRRF02	4 INCH	2 LED	AMBER

- 2 LEDs: Side marker function
- LED and reflector in one
- @ 12VDC 0.03A



SPECS & MEASUREMENTS

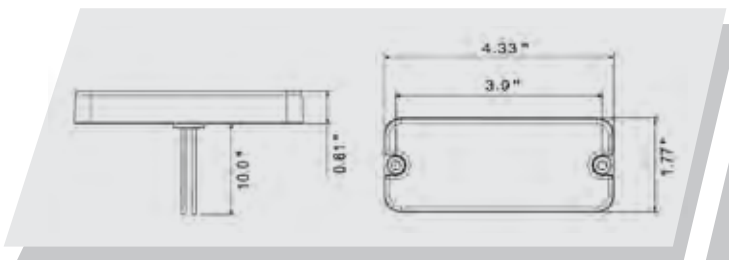

COMMON FEATURES

- CONNECTOR:** HARDWIRE
- HOUSING MATERIAL:** ABS
- LENS MATERIAL:** PMMA
- FMVSS:** AP P2

TRAILER ROUND MARKER/CLEARANCE LIGHT

HE-TR7501	0.75 INCH	3 LED	RED ROUND
HE-TR7502	0.75 INCH	3 LED	AMBER ROUND
HE-TR7503	0.75 INCH	3 LED	WHITE ROUND

- 3 LED round marker
- @ 12VDC 0.03A



SPECS & MEASUREMENTS

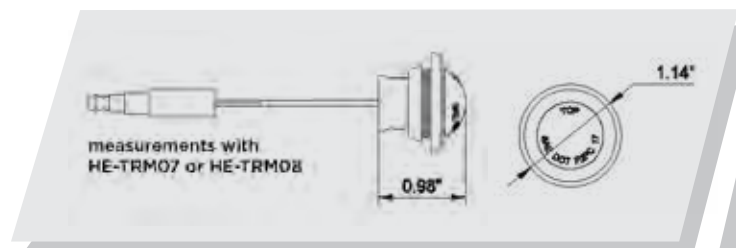

COMMON FEATURES

- CONNECTOR:** BULLET
- LENS MATERIAL:** POLYCARBONATE
- FMVSS:** P2
- PROTECTION:** WEATHER-RESISTANT

TRAILER ROUND MARKER/CLEARANCE LIGHT

HE-TR2501 **2.5** INCH **9** LED **ROUND WITH GROMMET**

HE-TR2504 **2.5** INCH **9** LED **ROUND**



- 9 LED round marker - red
- @ 12VDC 0.03A

HE-TR2502 **2.5** INCH **9** LED **ROUND WITH GROMMET**

HE-TR2505 **2.5** INCH **9** LED **ROUND**



- 9 LED round marker - amber
- @ 12VDC 0.03A

HE-TR2503 **2.5** INCH **9** LED **ROUND WITH GROMMET**

HE-TR2506 **2.5** INCH **9** LED **ROUND**



- 9 LED round marker - white
- @ 12VDC 0.03A

HE-TR2001 **2** INCH **6** LED **RED ROUND**

HE-TR2002 **2** INCH **6** LED **AMBER ROUND**

HE-TR2003 **2** INCH **6** LED **WHITE ROUND**



- 6 LED round marker
- @ 12VDC 0.03A

SPECS & MEASUREMENTS

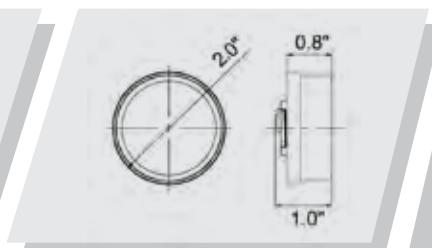
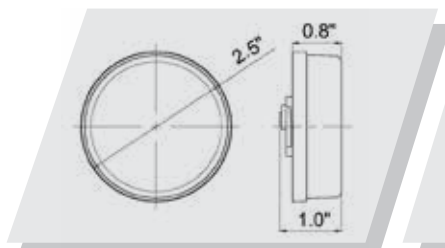

COMMON FEATURES

CONNECTOR: PL-10
HOUSING MATERIAL: ABS
LENS MATERIAL: PMMA
FMVSS: P2 P3

TRAILER ACCESSORIES

HE-TRWH01

1/8" INCH BULLET CONNECTOR

10 PACK

- Bulk 10 pack of 1/8" bullet connectors
- Used for the following lights: HE-TR6004 and HE-TR4004



HE-TRWH02

PL-10 MALE 2 PIN CONNECTOR

10 PACK

- Bulk 10 pack of PL-10 connectors
- 2-pin male
- Used for the following lights: HE-TR25xx and HE-TR20xx series



HE-TRWH03

PL-3 MALE RIGHT ANGLE CONNECTOR

10 PACK

- Bulk 10 pack of PL-3 connectors
- 3-pin male
- Use with HE-TR60xx and HE-TR40xx



HE-TRWH04

PL-3 FEMALE CONNECTOR

10 PACK

- Bulk 10 pack of PL-3 connectors
- 3-pin female
- Mating connector for HE-TRWH03
- Two PL-3 female connectors per harness



HE-TRWH05

2 SWITCH M/L OUTLET ADAPTER



TRAILER BULK FLANGES & GROMMETS

HE-TRM01 **6** INCH OVAL SURFACE MOUNT **10** PACK

- 6" plastic flange
- Bulk 10 pack



HE-TRM02 **6** INCH OVAL GROMMET **10** PACK

- 6" rubber grommet
- Bulk 10 pack



HE-TRM03 **4** INCH ROUND SURFACE MOUNT **10** PACK

- 4" stainless steel flange
- Bulk 10 pack



HE-TRM04 **4** INCH ROUND GROMMET **10** PACK

- 4" rubber grommet
- Bulk 10 pack



HE-TRM05 **2.5** INCH ROUND GROMMET **10** PACK

- 2.5" rubber grommet
- Bulk 10 pack



HE-TRM06 **2** INCH ROUND GROMMET **10** PACK

- 2" rubber grommet
- Bulk 10 pack



HE-TRM07 **0.75** INCH ROUND STAINLESS FLANGE **10** PACK

- 0.75" stainless flange
- Bulk 10 pack



HE-TRM08 **0.75** INCH ROUND GROMMET **10** PACK

- 0.75" rubber grommet
- Bulk 10 pack



TRAILER FLANGES & GROMMETS

HE-TRM101 6 INCH OVAL SURFACE MOUNT

- 6" plastic flange
- Single pack



HE-TRM102 6 INCH OVAL GROMMET

- 6" plastic grommet
- Single pack



HE-TRM103 4 INCH ROUND SURFACE MOUNT

- 4" stainless steel flange
- Single pack



HE-TRM104 4 INCH ROUND GROMMET

- 4" rubber grommet
- Single pack



HE-TRM105 2.5 INCH ROUND GROMMET

- 2.5" rubber grommet
- Single pack



HE-TRM106 2 INCH ROUND GROMMET

- 2" rubber grommet
- Single pack



HE-TRM107 0.75 INCH ROUND STAINLESS FLANGE

- 0.75" stainless steel flange
- Single pack



HE-TRM108 0.75 INCH ROUND GROMMET

- 0.75" rubber grommet
- Single pack



TRAILER BRAKE LIGHT FLASHERS

IBLEDBLF STROBE FLASH CONTROLLER FOR LED BRAKE LIGHT

- For use with LED third brake lights
- Flashes third brake light for greater visibility



IBBLF BRAKE LIGHT FLASHER

- For use with LED third brake lights
- Flashes third brake light for greater visibility



TRAILER QUICK DISCONNECT CABLES

TE-TCEX-1 DUAL CAMERA QUICK DISCONNECT CABLE

- 3.5ft trailer coil cable & 1.5ft 2-camera connection
- 32ft extension cable with quick disconnect
- Stainless steel quick disconnects
- Water-resistant seals
- Used for trailer hitches
- Allows for 2 camera connections-1 audio and video and 1 video only
- 4-pin DIN connections for cameras



TE-TRBRKT PAIR OF TRAILER QUICK DISCONNECT BRACKETS

- Mounting bracket for quick disconnects
- Open slot for easy running of cable
- Includes 2 brackets
- Heavy-duty metal



TE-CTR3 3 METER COILED CONNECTOR TRAILER CABLE

- Cable for commercial cameras
- Coiled cable to adjust for different trailer tongue lengths
- 3m / 9.8ft in length
- 4-pin DIN connectors



TRAILER CAMERAS & CABLES

TE-CCM

HEAVY-DUTY NIGHT VISION CAMERA + MICROPHONE

- IP67 rated
- Built-in microphone
- Extension cable not included



TE-CCS

HEAVY-DUTY NIGHT VISION SIDE-VIEW CAMERA

- IP69K rated
- Extension cable not included



COMMON FEATURES

HOUSING MATERIAL: METAL
MOUNT : SURFACE
VEHICLE SIZE: LARGE

NIGHT VISION: 0 LUX/18 IR LEDS
VIEWING ANGLE: 120°
REAR MOUNTING: YES

TE-HEX10

HD 4-PIN DIN EXTENSION CABLE

32.8 FEET

TE-HEX20

HD 4-PIN DIN EXTENSION CABLE

65.6 FEET



- HD extension cable for HD commercial cameras
- 4-pin DIN connectors

TRAILER WIRING

ALL COPPER HOOK-UP WIRE

IBTH12	12GA 2-PIN/2-PIN RED/BLACK	EA/1FT
IBTH16	16GA 2-PIN/2-PIN RED/BLACK	EA/1FT
IBTH18	18GA 2-PIN/2-PIN RED/BLACK	EA/1FT

IBTH16



TRAILER CONNECTORS

- Black pvc housing with copper internals

IBT-E01	6-PIN ROUND/4-WAY FLAT	EA	IBT-E05	7-WAY BLADE TO TRAILER END	EA
IBT-E02	7-PIN ROUND/6-WAY ROUND	EA	IBT-E06	7-WAY BLADE TO VEHICLE END	EA
IBT-E03	7-WAY BLADE/4-WAY FLAT	EA	IBT-E07	7-BLADE 12V LED TESTER	EA
IBT-E04	7-WAY BLADE/5-WAY FLAT	EA	IBT-E08	MOUNTING BRACKET	EA



TRAILER WIRING

ALL COPPER TRAILER WIRE

Wire recommended for RVs, boats and utility trailers.

2 CONDUCTOR TRAILER WIRE

TWBKRD14100	14GA BLACK/RED	100FT SPL
TWBKRD16100	16GA BLACK/RED	100FT SPL
TWBKRD18100	18GA BLACK/RED	100FT SPL



TWBKRD16100

ALL COPPER JACKETED PRIMARY WIRE

Wire recommended for auto/truck/construction and light marine. Heavy duty PVC outer jacket is abrasion resistant and protects against moisture, oil, acid and salt.

2 CONDUCTOR

JPWBW8100	8GA BLACK/WHITE	EA/100FT
JPWBW10100	10GA BLACK/WHITE	EA/100FT
JPWBW14100	14GA BLACK/WHITE	EA/100FT
JPWBW16100	16GA BLACK/WHITE	EA/100FT

3 CONDUCTOR

JPWBGW12100	12GA BLK/GRN/WHT	EA/100FT
JPWBGW16100	16GA BLK/GRN/WH	EA/100FT

4 CONDUCTOR

JPWBGRW12100	12GA BLK/GRN/RED/WHT	EA/100FT
JPWBGRW14100	14GA BLK/GRN/RED/WHT	EA/100FT
JPWBGRW16100	16GA BLK/GRN/RED/WHT	EA/100FT



JPWBGW10100



JPWBGRW10100

BULK TRAILER WIRE COLORS

GPT is designed for electrical usage in fleet vehicles. PVC coated high temp rated.

US18500R	18GA US GPT WIRE RED	EA/500FT
US18500BL	18GA US GPT WIRE BLUE	EA/500FT
US18500BR	18GA US GPT WIRE BROWN	EA/500FT
US18500GR	18GA US GPT WIRE GREEN	EA/500FT
US18500OR	18GA US GPT WIRE ORANGE	EA/500FT
US18500PL	18GA US GPT WIRE PURPLE	EA/500FT
US18500WT	18GA US GPT WIRE WHITE	EA/500FT
US18500YL	18GA US GPT WIRE YEL	EA/500FT



ALL COPPER TRAILER WIRING PLUGS

IBTH4P	4-WAY 18GA	5PK
IBTH5P	5-WAY 18GA	5PK

Connectors that allow the basic hookup of the three lighting functions (running, turn and brake lights) plus one pin is provided for a ground wire (IBTH4P). One pin is available to provide support for another function (IBTH5P)



ALL COPPER TRAILER HARNESS

IBTH8P72	12GA, 16GA, 8 PIN 72"	5PK
----------	-----------------------	-----

For custom harness applications:

12ga = RD, WT, BK

16ga = YL, BN, GN, BL, GY

TRAILER WIRING REFERENCE GUIDE

VEHICLE-SIDE CONNECTIONS

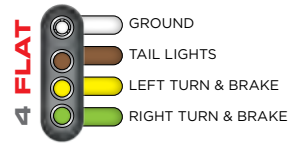
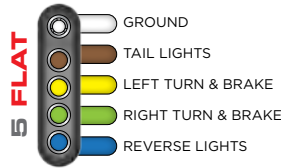
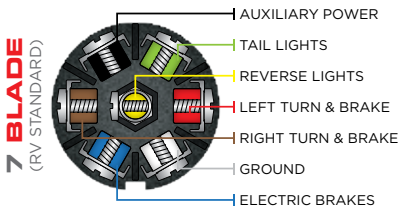
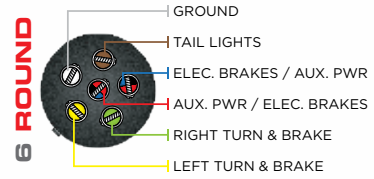
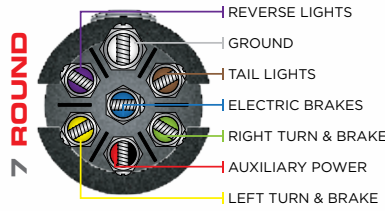
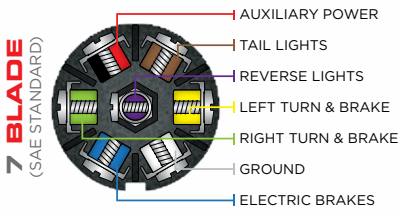

TRAILER-SIDE CONNECTIONS

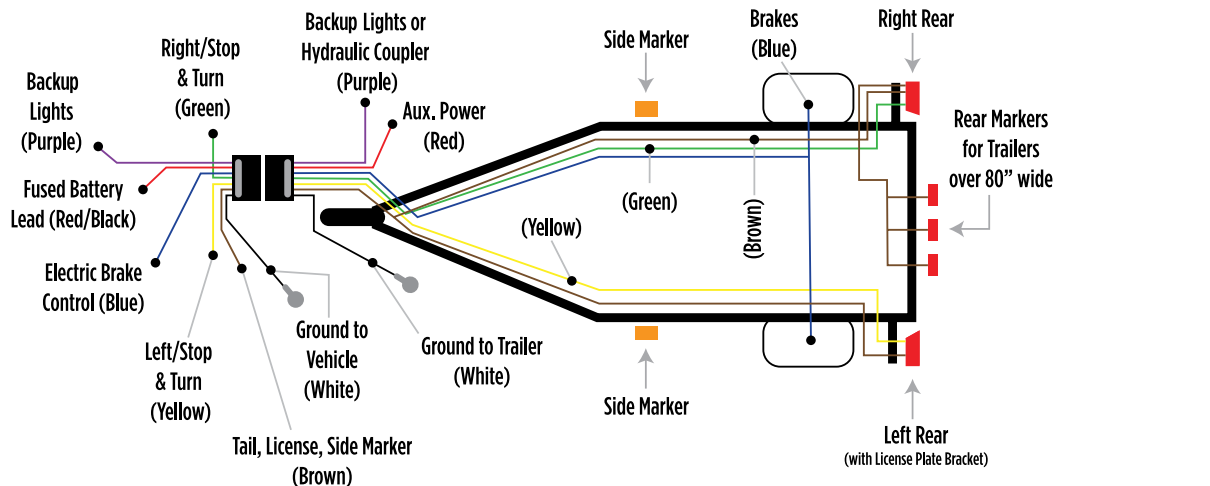
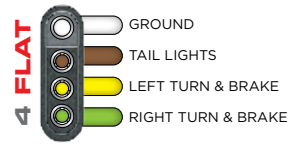
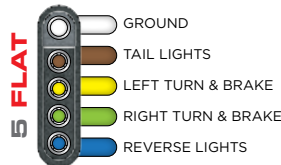
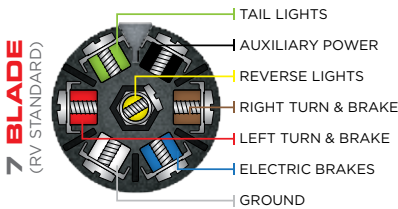
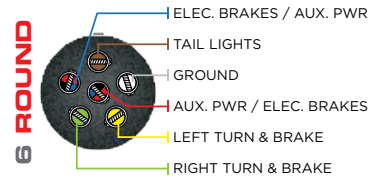
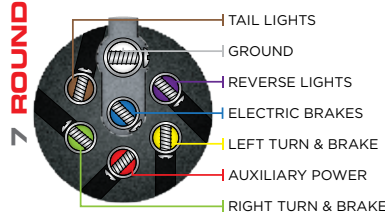
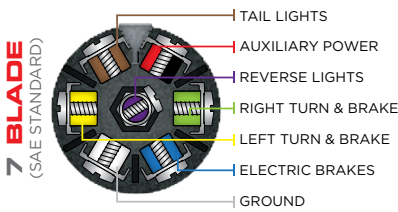



MERCHANDISE





HEISELED.COM • HIGH PERFORMANCE LED STRIPS & LIGHTBARS

MERCHANDISE & DISPLAYS

HE-DISP-MTBL1

HE-DISP-MTBL2

MARINE LIGHTBAR DISPLAYS

- High quality printed graphics
- Lightweight, rigid material
- Dimensions: 27.5”h x 18”w x 6”d
- Power supply and wiring included

PARTS:

HE-MSR14
HE-MCL2
HE-MCL3



HE-DISP-MTBL1

PARTS:

ML-RGB15W
ML-DLGRN9W
ML-BLU27W
ML-CLBLU
ML-RGBW24W
ML-BLU30W
RGBW-CB1



HE-DISP-MTBL2

TABLE TOP DISPLAYS

HE-DISP-TBL1

HE-DISP-TBL2

HE-DISP-TBL3

HE-MUNTTD-1

MPS-TTD-1



HE-DISP-TBL1

PARTS:

HE-BDR14
HE-BCL2S
HE-CL3SA



HE-DISP-TBL3

- High quality printed graphics
- Lightweight, rigid material
- Dimensions: 27.5”h x 18”w x 6”d
- Power supply and wiring included

PARTS:

RGBW1-4KT
RGB1-4KT
RGBW-CB2
HE-5MRGB-1
HE-PTRGB



HE-DISP-TBL2

PARTS:

HE-TL1RGB HE-ARB1
HE-ML1RGB HE-CBRGB
HE-TL1DIV HE-5MRGB-1
HE-ML1DIV HE-JWBFLO2RGB



HE-MUNTTD-1

PARTS:

HE-MUMRK-6WA HE-MUMRK-6R
HE-MUMRK-4B HE-MUMRK-4A
HE-MULTE-6BA HE-MULTE-6BR
HE-MUHSR-A HE-MULH-4W



MPS-TTD-1

PARTS:

MPS-RGBWWK
MPS-RGBDL
MPS-RGB
MPS-ECR72

MERCHANDISE & DISPLAYS

A-FRAME DISPLAY

- Dimensions: 76"h x 40"w x 27"d
- High quality print
- Includes Heise graphics



* Products listed below may change based on availability

HE-AFM3

PARTS:

HE-FMTL1
HE-FMTL1A
HE-TL1B
HE-TL1G
HE-ML1
HE-ML1A
HE-HCL2
HE-CL3
HE-BCL2S
HE-FMDL1
HE-WL1
HE-WL2
HE-WL3
HE-SL550
HE-DRL8
HE-INFIN30
HE-4TLRGBK

HE-AFM4

PARTS:

HE-MDR8
HE-MSR14
HE-MDRC30
HE-MHCL2
HE-MHCL3
HE-MCL1
HE-MCL2
HE-MCL3
HE-MFMCL3
HE-4MLRGBK
HE-ML1
HE-ML1G
HE-FMML1B
HE-FMML1R
HE-ML1DIV

HE-AFRAMEDISP

- Blank display
- build your own
- Includes Heise graphics

JP-AFM1

PARTS:

JP-706RGBKT
JP-702B
JP-704B
JP-SML1
JP-TSL1
JP-TTL
JP-TTL2
JP-TL03T
JP-TL04T
107-CH3B
JP-1014

BC-AFM1

PARTS:

BC-706RGBKT
BC-703B
BC-561B
BC-562B
BC-452B
BC-HDTL9
BC-WSTSB14
BC-PC1157AW
BC-MHBSBB
BC-HBTS
BC-HDLSP-1
BC-HDLFP

HE-DISP-HL

HEADLIGHT DISPLAY

- High quality printed graphics
- 1x 9007 LED dual beam bulb
- AA batteries (not included)



HE-LEDDISPLAY

LED STRIP DISPLAY

- High quality printed graphics
- Lightweight, rigid material
- Color LEDs mounted for light sampling
- Dimensions: 12"h x 9.5"w



MERCHANDISE & DISPLAYS

SKINNY DISPLAY

RACK700

- Dimensions: 72"h x 20"w x 13.5"d
- Black powder coated metal display
- Metal pegboard for high strength
- Display stand only

HEISE DECALS

HE-700TOP HE-700BOT

- Heise small top magnetic decal HE-700TOP
- Heise small bottom magnetic decal HE-700BOT

HE-RACK7001

- Includes RACK700 and Heise decals

PARTS:

H-RGB5MRK2 (X4)
H-A550 (X3)
H-B550 (X3)
H-G550 (X3)
H-IB550 (X3)
H-R550 (X3)
H-W550 (X3)
H-CW550 (X3)
H-PP550 (X3)
H-RGBC-1 (X2)

PARTS:

H-RGB5MRK1 (X4)
H-A535 (X3)
H-B535 (X3)
H-G535 (X3)
H-IB535 (X3)
H-R535 (X3)
H-W535 (X3)
H-PP535 (X3)
H-PK535 (X3)
H-RGBC-1 (X2)



XL DISPLAY

RACK750

- Dimensions: 78"h x 39.5"w x 13.5"d
- Large black powder coated metal display
- Metal pegboard for high strength
- Display stand only

HEISE DECALS

HE-LARGETOP

- Heise large top magnetic decal



HEISE T-SHIRT & HAT

HE-TSHIRTL LARGE

- Black shirt with white & red screenprint on front & back

HE-TSHIRTXL X-LARGE

HE-TSHIRTXXL XX-LARGE

HEISE-HAT

- One size fits all
- Black



HE-STICKER

HEISE STICKERS

- 1.5"H X 5.75"W silver diecut vinyl

HE-DISPSTKR

TORTURE SHELF TALKER

- Call to action by your display



HEISE-SLATHDR

SLATWALL HEADER

- High quality printed logo graphic
- Lightweight, rigid material
- Dimensions: 48"h x 8"w



HE-BANNER

HEISE BANNER

- High quality printed banner
- Includes reinforced holes for hanging
- Dimensions: 48"h x 24"w

