



2020
CATALOG





PARAMOUNT AUTOMOTIVE

Paramount Automotive's mission has always been to design and manufacture innovative vehicle-enhancing products for off-road enthusiasts. To maintain our position at the peak of our industry, we are investing ourselves in new product development and quality improvements for a wide variety of vehicles and customers. Whether you drive a Truck, Jeep, or SUV, Paramount Automotive is here to enhance your vehicle with products that deliver quality, functionality, and profitability.

To deliver on that highest standard of quality and innovation, Paramount Automotive has enhanced our design and manufacturing operations in metal and plastics to create superior off-road products. Our metalworking and thermoforming machinery is the finest in the industry, surpassing our competition by all standards of quality and innovation, as we continue to advance from strength to strength.

This positions Paramount Automotive as the pinnacle in off-road design and manufacturing both now and in the future.



- 04-07** CONTRACTOR RACKS
- 08-09** IMPULSE GRILLES
- 10-11** EVOLUTION GRILLES
- 12 -15** JT/JL FRONT BUMPERS
- 16-17** JL REAR BUMPERS & TIRE CARRIERS
- 18-21** JK FRONT BUMPERS
- 22-25** JK REAR BUMPERS & TIRE CARRIER
- 26-27** TJ/YJ FRONT BUMPERS
- 28-29** TJ/YJ REAR BUMPERS & TIRE CARRIER
- 30-31** WJ BUMPERS
- 32-33** XJ BUMPERS
- 34-35** TRUCK BUMPERS
- 36-37** JL/JK ROOF RACKS
- 38-39** JK R-5 CANYON PRODUCTS
- 40-41** TJ STEEL FENDER FLARES
- 42-43** JL/JK ROCK SLIDERS
- 44-45** TJ/YJ ROCK GUARDS
- 46-47** JEEP PLASTIC FENDER FLARE
- 48-49** JEEP FENDER FLARE INNER LINERS
- 50** JEEP GRILLE INSERTS
- 51** JEEP ACCESSORIES
- 52-53** JK FLOOR LINERS
- 54** BUMPER DISPLAY RACKS

Paramount Automotive's professional truck racks combine impressive strength, elegant design and ease of installation. Our unique design allows for infinite adjustability in all the right places for a custom fit on all trucks - long bed or short bed. All of our racks include no-drill mounting.

CONTRACTOR RACKS

CONTRACTOR RACKS



19601
CAMPER SHELL RACK



16601
COMPACT RACK



18601
HEAVY DUTY RACK

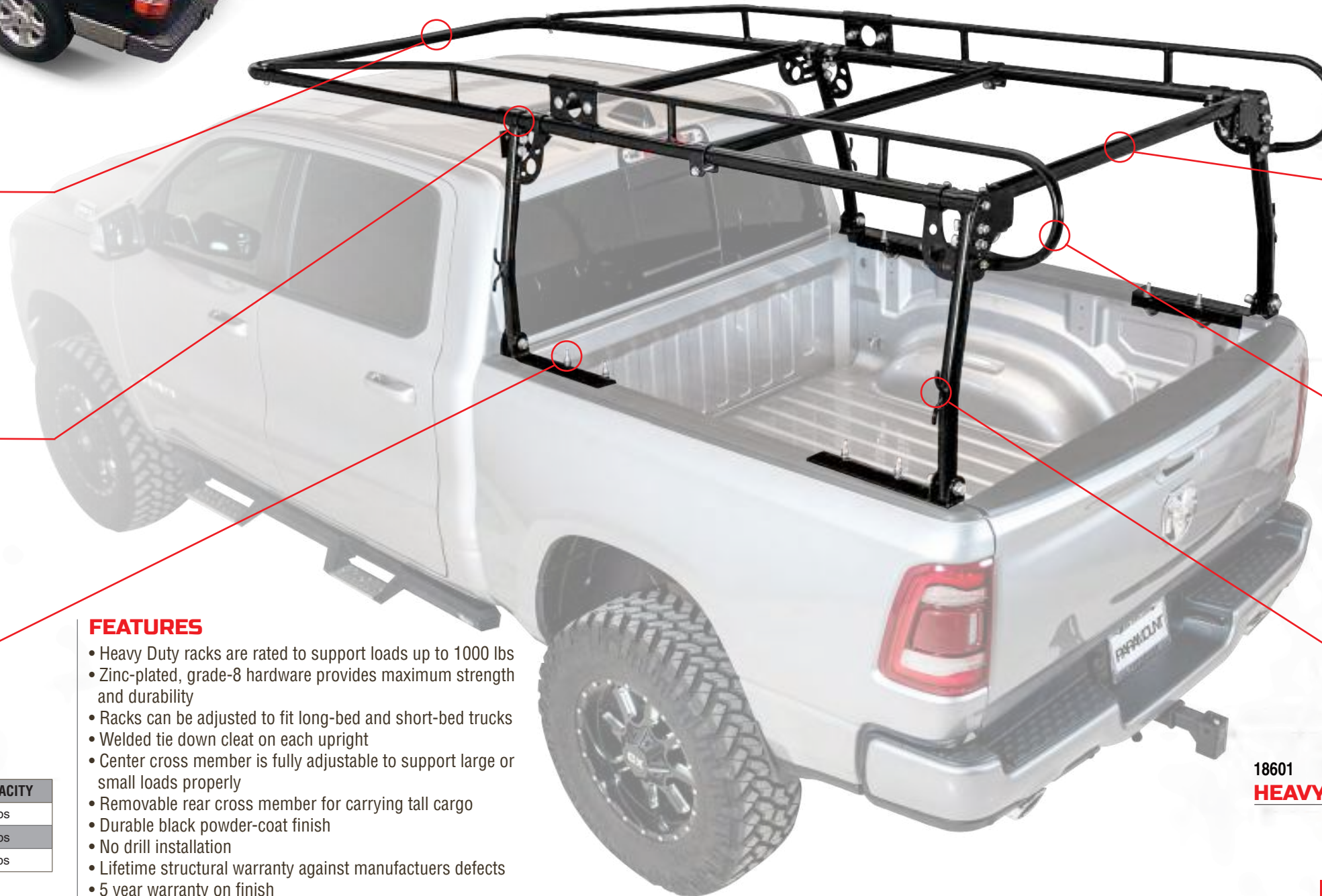

**WIND DEFLECTOR
ELIMINATES CAB NOISE**



**TWO WAY ADJUSTABLE
FOR UNIVERSAL FIT**



EASY, NO DRILL INSTALL



REMOVABLE REAR BAR



EASY GET IN HANDLE



WELDED TIE DOWN CLEAT

FEATURES

- Heavy Duty racks are rated to support loads up to 1000 lbs
- Zinc-plated, grade-8 hardware provides maximum strength and durability
- Racks can be adjusted to fit long-bed and short-bed trucks
- Welded tie down cleat on each upright
- Center cross member is fully adjustable to support large or small loads properly
- Removable rear cross member for carrying tall cargo
- Durable black powder-coat finish
- No drill installation
- Lifetime structural warranty against manufacturers defects
- 5 year warranty on finish

PART	CONTRACTOR RACKS	LOAD CAPACITY
16601	COMPACT RACK	1000 lbs
18601	HEAVY DUTY RACK	1000 lbs
19601	CAMPER SHELL RACK	1000 lbs

18601
HEAVY DUTY RACK



WIND DEFLECTOR
ELIMINATES CAB NOISE



WELDED TIE DOWN CLEAT



NO DRILL INSTALL



ADJUSTABLE FOR
UNIVERSAL FIT



REMOVABLE REAR BAR



CONVENIENT GRAB
HANDLE



FEATURES

- All racks are rated to support loads up to 1500 pounds
- Durable black power-coat finish
- No drill installation with supplied J-Hooks
- Adjustable center cross member
- Welded tie down cleat on each upright
- Front air dam engineered to reduce wind noise
- Removable rear cross member for carrying tall cargo
- Durable black powder coat finish
- Ships in two boxes
- Lifetime structural warranty against manufacturers defect
- 5 year warranty on finish
- Vehicle specific design

18602
PREMIUM RACK

PART	CONTRACTOR RACKS	LOAD CAPACITY
18602	PREMIUM RACK	1500 lbs



Paramount Automotive's new line of Impulse Grilles for GM, Nissan, RAM and Toyota trucks give you OE quality at an affordable price. Our precision manufacturing and injection molding processes create durable, impact resistant grilles for that rugged look that lasts and lasts.

FEATURES

- Full grille replacement uses OE mounting locations
- Integrated 3W amber LED running lights
- Includes complete wiring harness
- Impact-resistant light weight ABS plastic
- Premium matte black finish
- Lifetime structural warranty against manufacturers defects
- 5 year warranty on finish
- Vehicle specific application



AMBER LED LIGHTS

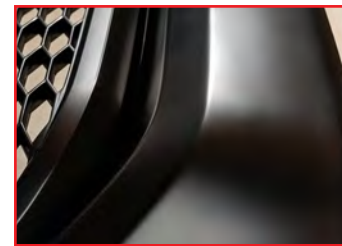

MATTE BLACK ABS



HIGH QUALITY MESH



STYLED AIR VENTS



**41-0170MB
IMPULSE GRILLE**

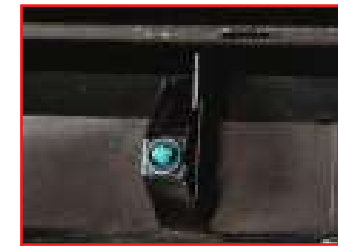

**FULL REPLACEMENT
EASY INSTALL**



WIRING HARNESS

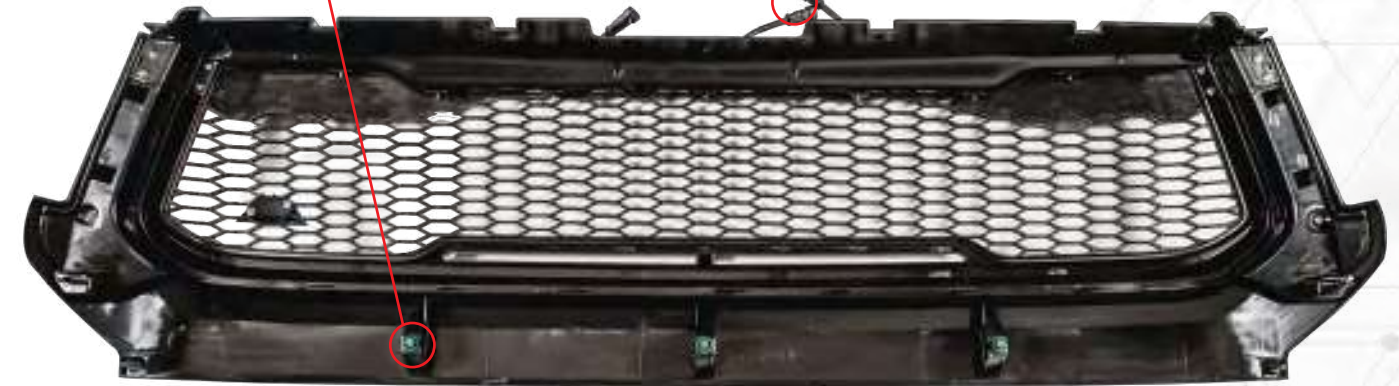

PART	YEAR	MAKE	MODEL
41-0193MB	16-18	CHEVROLET	SILVERADO 1500
41-0174MB	14-15	CHEVROLET	SILVERADO 1500
41-0196MB	07-13	CHEVROLET	SILVERADO 1500
41-0190MB	15-19	CHEVROLET	SILVERADO 2500/3500
41-0181MB	11-14	CHEVROLET	SILVERADO 2500/3500
41-0177MB	07-10	CHEVROLET	SILVERADO 2500/3500
41-0183MB	13-18	DODGE	RAM 1500 (NON REBEL)
41-0180MB	09-12	DODGE	RAM 1500
41-0197MB	02-05	DODGE	RAM 1500
41-0176MB	13-18	DODGE	RAM 2500/3500
41-0175MB	10-12	DODGE	RAM 2500/3500
41-0195MB	06-08	DODGE	RAM 2500/3500
41-0197MB	03-05	DODGE	RAM 2500/3500
41-0194MB	16-18	GMC	SIERRA 1500
41-0192MB	14-15	GMC	SIERRA 1500
41-0178MB	07-13	GMC	SIERRA 1500
41-0204MB	15-19	GMC	SIERRA 2500/3500
41-0182MB	11-14	GMC	SIERRA 2500/3500
41-0179MB	07-10	GMC	SIERRA 2500/3500
41-0203MB	04-07	NISSAN	TITAN
41-0171MB	16-19	TOYOTA	TACOMA
41-0201MB	12-15	TOYOTA	TACOMA
41-0202MB	05-11	TOYOTA	TACOMA
41-0170MB	14-20	TOYOTA	TUNDRA
41-0169MB	10-13	TOYOTA	TUNDRA

Paramount Automotive's Evolution LED Full Replacement Grille and Shell Combos are the precision manufactured solution to replace your factory grille with a rugged, functional upgrade. With no cutting necessary, our grilles come complete with Plug-and-Play performance LED lighting pre-installed.

EVOLUTION GRILLES

EVOLUTION GRILLES

FEATURES

- Full grille replacement using OE mounting locations
- Chrome accent rivets
- Designed in CAD and CNC machined for accuracy
- Pre-installed LED cube lights and light bar
- 304 Stainless steel mesh design
- Premium matte black finish
- Lifetime structural warranty against manufacturers defects
- 5 year finish warranty
- Vehicle specific application

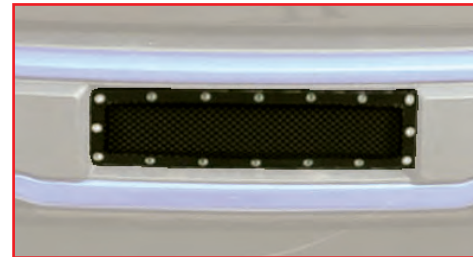

**46-0777
EVOLUTION BUMPER INSERT**



ACCENT RIVETS



**304 STAINLESS STEEL
WOVEN MESH**



24PC, 3W LED LIGHT BAR



4PC, 4W LED LIGHT



MATTE BLACK ABS

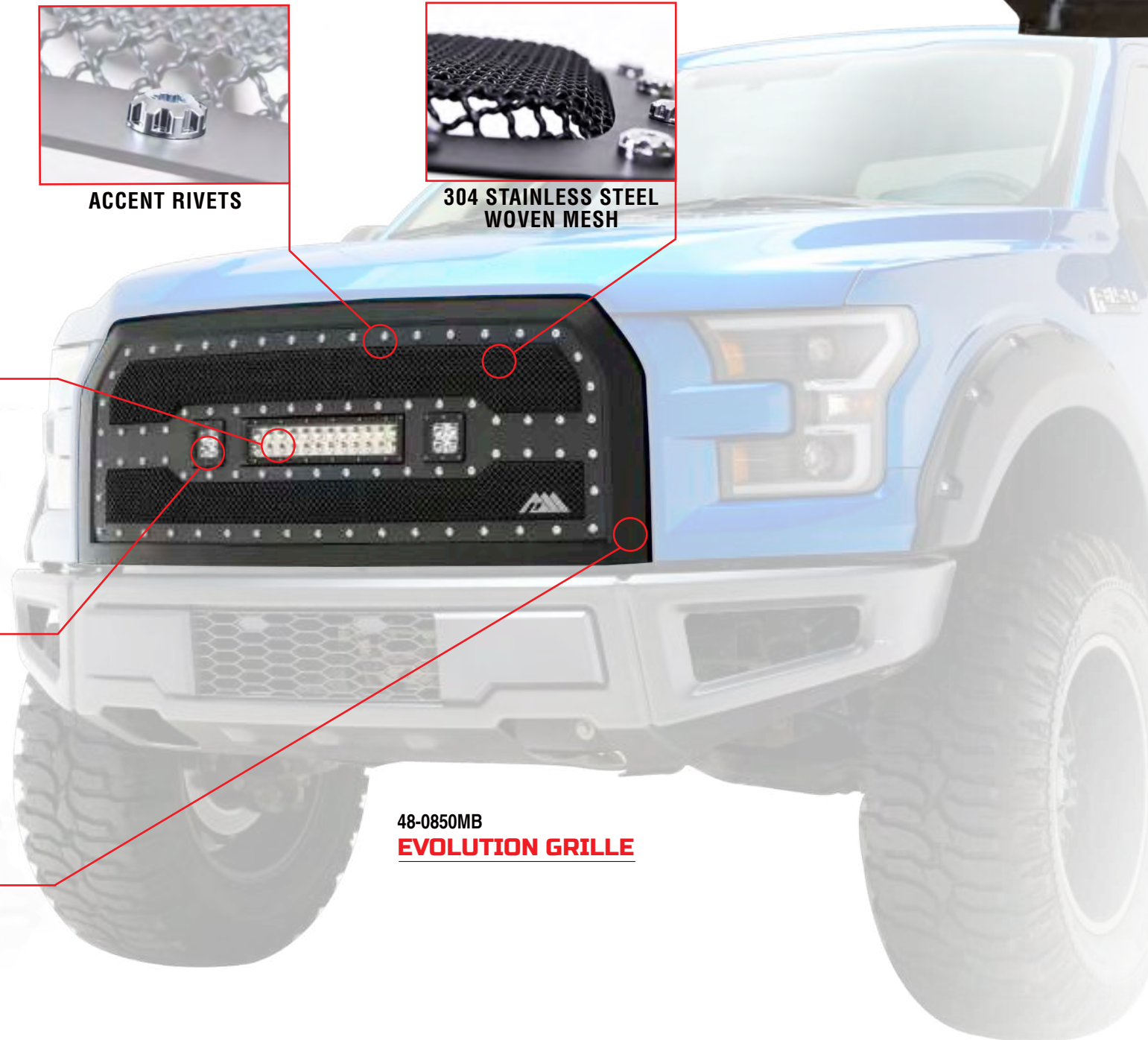

**48-0850MB
EVOLUTION GRILLE**

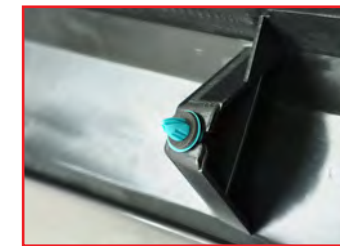

**FULL REPLACEMENT
EASY INSTALL**



WIRING HARNESS

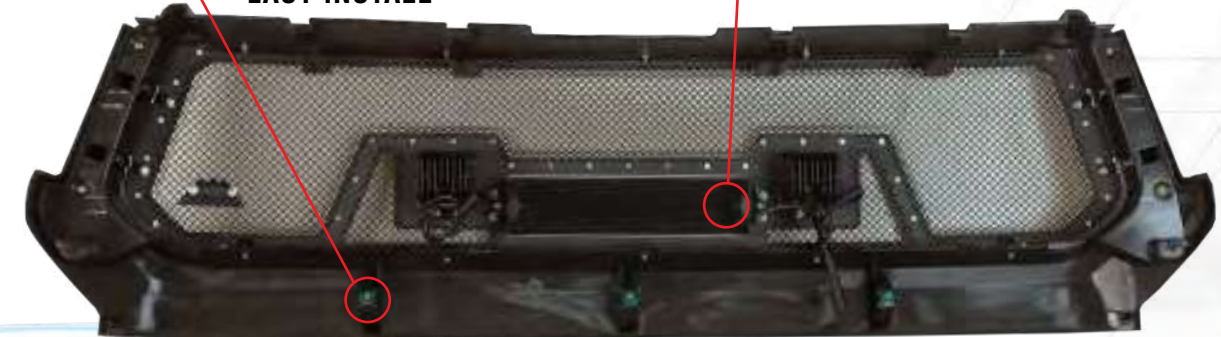

UPPER GRILLE	BUMPER INSERT	YEAR	MAKE	MODEL
48-0854	-	16-18	CHEVROLET	SILVERADO 1500
48-0843	46-0758	14-15	CHEVROLET	SILVERADO 1500
48-0844	46-0725	07-13	CHEVROLET	SILVERADO 1500
48-0853	-	15-19	CHEVROLET	SILVERADO 2500/3500
48-0835	-	11-14	CHEVROLET	SILVERADO 2500/3500
48-0834	-	07-10	CHEVROLET	SILVERADO 2500/3500
48-0847	-	13-18	DODGE	RAM 1500(NON REBEL)
48-0829	-	09-12	DODGE	RAM 1500
48-0812	-	06-08	DODGE	RAM 1500/2500/3500
48-0813	-	02-05	DODGE	RAM 1500/2500/3500
48-0848	-	13-18	DODGE	RAM 2500/3500
48-0828	-	10-12	DODGE	RAM 2500/3500
48-0859	-	18-19	FORD	F-150
48-0850	46-0777	15-17	FORD	F-150
48-0824	46-0744	09-14	FORD	F-150
48-0807	-	04-08	FORD	F-150
48-0858	-	17-19	FORD	F-250/F-350
48-0825	46-0740	11-16	FORD	F-250/F-350
48-0803	46-0745	08-10	FORD	F-250/F-350
48-0804	46-0746	05-07	FORD	F-250/F-350
48-0805	-	99-04	FORD	F-250/F-350
48-0857	-	16-18	GMC	SIERRA 1500
48-0851	-	14-15	GMC	SIERRA 1500
48-0832	46-0726	07-13	GMC	SIERRA 1500
48-0852	-	15-19	GMC	SIERRA 2500/3500
48-0842	46-0743	11-14	GMC	SIERRA 2500/3500
48-0833	-	07-10	GMC	SIERRA 2500/3500
48-0849	46-0778	07-14	TOYOTA	FJ CRUISER
48-0819	46-0754	05-11	TOYOTA	TACOMA
48-0855	-	12-15	TOYOTA	TACOMA
48-0856	-	16-19	TOYOTA	TACOMA
48-0846	-	14-19	TOYOTA	TUNDRA
48-0836	-	10-13	TOYOTA	TUNDRA
48-0817	-	07-09	TOYOTA	TUNDRA

Paramount Automotive's Stubby and Midwidth Front Bumpers are the versatile front protection for your Jeep that you need for your next offroad adventure. Heavy duty steel construction and multiple features give you the confidence to tackle any trail.

JL/JT FRONT BUMPERS

JL/JT FRONT BUMPERS

FEATURES

- Improves tire clearance while providing superior protection
- Built-in winchplate accommodates up to 12,000 pound winch
- Includes 4.75 ton D-Ring shackles with isolators
- CNC laser cut and welded for precision and durability
- Manufactured from 4mm steel plate with a 2-3/8" overrider
- Textured black powder-coat finish for durability and corrosion resistance
- Lifetime structural warranty against manufacturers defects
- 5 year finish warranty
- Engineered to be direct bolt-on OE replacement

**51-8007
SPORT FRONT BUMPER**



BUILT IN LIGHT TABS

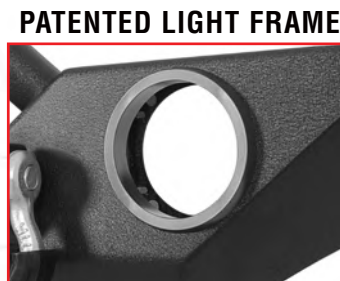

PATENTED LIGHT FRAME

OE FOG LIGHT PROVISION



INCLUDES SHACKLES WITH ISOLATORS



WINCH COMPATIBILITY



D-RING MOUNTS WELDED INSIDE AND OUT



SEAMLESS STEEL TUBE

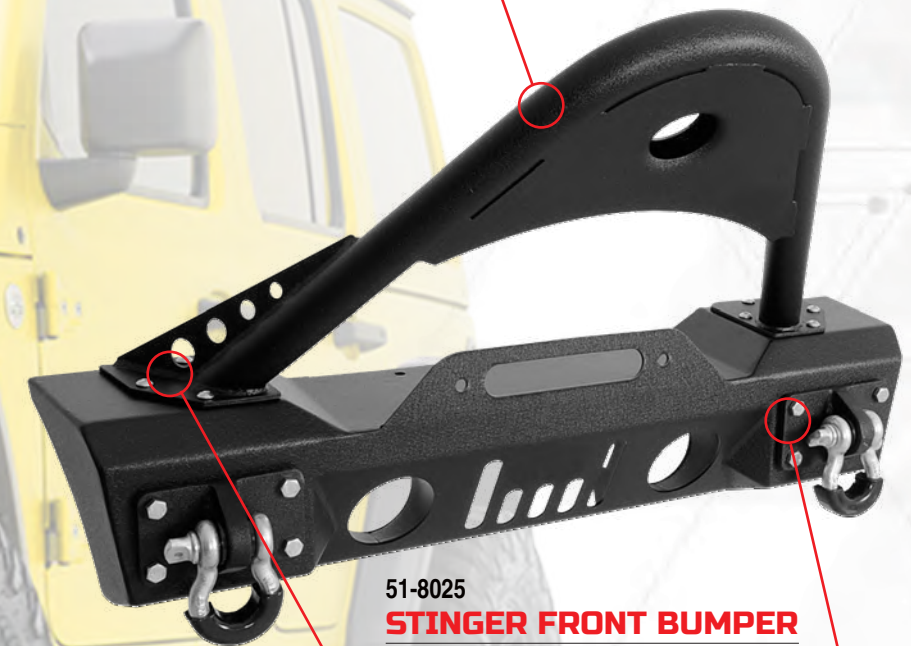

**51-8025
STINGER FRONT BUMPER**



REMOVABLE STINGER



REMOVABLE D-RING MOUNTS FOR VERSATILITY

PART	YEAR	MAKE	MODEL	DESCRIPTION
51-8007	07-20	JEEP	WRANGLER JL, GLADIATOR JT	FRONT BUMPER WITH OE FOG LIGHT HOUSING AND FRAMES
51-8025	07-20	JEEP	WRANGLER JL, GLADIATOR JT	STINGER FRONT BUMPER WITH OE FOG LIGHT HOUSING

Paramount Automotive's Paramount Automotive's Full Width Front Bumpers are the versatile front protection for your Jeep that you need for your next offroad adventure. Heavy duty steel construction and multiple features give you the confidence to tackle any trail.

JL/JT FRONT BUMPERS

JL/JT FRONT BUMPERS



FOUR 16W CUBE LED LIGHTS



120W LED LIGHT BAR



51-8062
FULL WIDTH FRONT BUMPER



WIRING HARNESS AND SWITCH



WINCH COMPATIBILITY



BUILT IN LIGHT TABS



REMOVABLE OVERRIDER



D-RING MOUNTS WELDED INSIDE AND OUT



INCLUDES SHACKLES WITH ISOLATORS

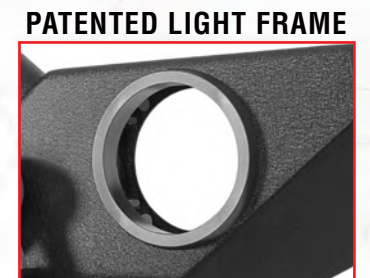

PATENTED LIGHT FRAME
OE FOG LIGHT PROVISION



51-8061
FULL WIDTH FRONT BUMPER

FEATURES

- Improves tire clearance while providing superior protection
- Built-In winchplate accommodates up to 12,000 pound winch
- Includes 4.75 ton D-Ring shackles with isolators
- CNC laser cut and welded for precision and durability
- Manufactured from 4mm steel plate with a 2-3/8" override
- Textured black powder-coat finish for durability and corrosion resistance
- Lifetime structural warranty against manufacturers defects
- 5 year finish warranty

PART	YEAR	MAKE	MODEL	DESCRIPTION
51-8061	07-18	JEEP	WRANGLER JL, GLADIATOR JT	FULL WIDTH FRONT BUMPER WITH OE FOG LIGHT HOUSING
51-8062	07-18	JEEP	WRANGLER JL, GLADIATOR JT	FULL WIDTH LED LIGHT STYLE FRONT BUMPER



Paramount Automotive's Rear Bumpers for the JL Wrangler are a high energy mashup of quality design and heavy duty construction allowing you to hit trails with confidence.

JL REAR BUMPERS & TIRE CARRIER

JL REAR BUMPERS & TIRE CARRIER

FEATURES

- Improves tire clearance while providing superior protection
- 2" Class 3 rated receiver hitch with safety chain loop
- Includes 4.75 ton D-Ring shackles with isolators
- CNC laser cut and welded for precision and durability
- Manufactured from durable 4mm steel plate
- Textured black powder-coat finish for durability and corrosion resistance
- Lifetime structural warranty against manufacturers defects
- 5 year finish warranty
- Engineered to be a full bolt-on OE replacement

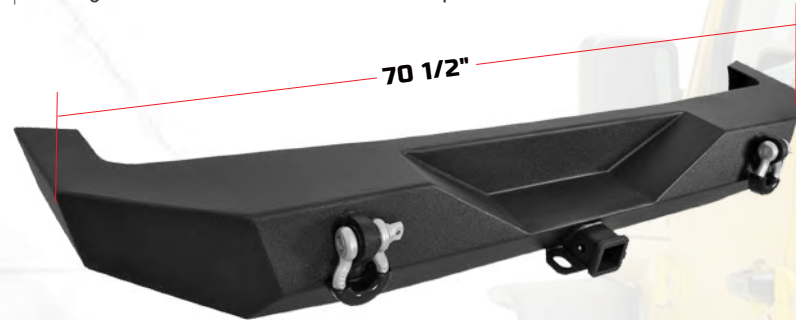

51-8021
FULL WIDTH REAR BUMPER



51-8010
BODY WIDTH REAR BUMPER



51-8011
BODY WIDTH BUMPER WITH SUREGRIP TIRE CARRIER



51-8022
FULL WIDTH REAR BUMPER

PART#	YEAR	MAKE	MODEL	DESCRIPTION
51-8021	18-19	JEEP	WRANGLER JL	FULL WIDTH REAR BUMPER
51-8022	18-19	JEEP	WRANGLER JL	FULL WIDTH LED REAR BUMPER WITH SUREGRIP TIRE CARRIER
51-8010	18-19	JEEP	WRANGLER JL	ROCK CRAWLER REAR BUMPER
51-8011	18-19	JEEP	WRANGLER JL	REAR BUMPER WITH SURGRIP LATCH TIRE CARRIER, BACKUP CAMARA TIRE ADAPTOR AND HARNESS

Paramount Automotive's Stubby and Midwidth JK Front Bumpers are the versatile front protection for your Jeep that you need for your next offroad adventure. Heavy duty steel construction and multiple features give you the confidence to tackle any trail.

JK FRONT BUMPERS

JK FRONT BUMPERS

FEATURES

- Improves tire clearance while providing superior protection
- Includes 4.75 ton D-Ring shackles with isolators
- Built-in winchplate accommodates up to 12,000 pound winch
- Manufactured from 4mm steel plate with a 2-3/8" overrider
- CNC laser cut and welded for precision and durability
- Textured black powder-coat finish for durability and corrosion resistance
- Lifetime structural warranty against manufacturers defects
- 5 year finish warranty
- Engineered to be direct bolt-on OE replacement

51-0328
SPORT FRONT BUMPER

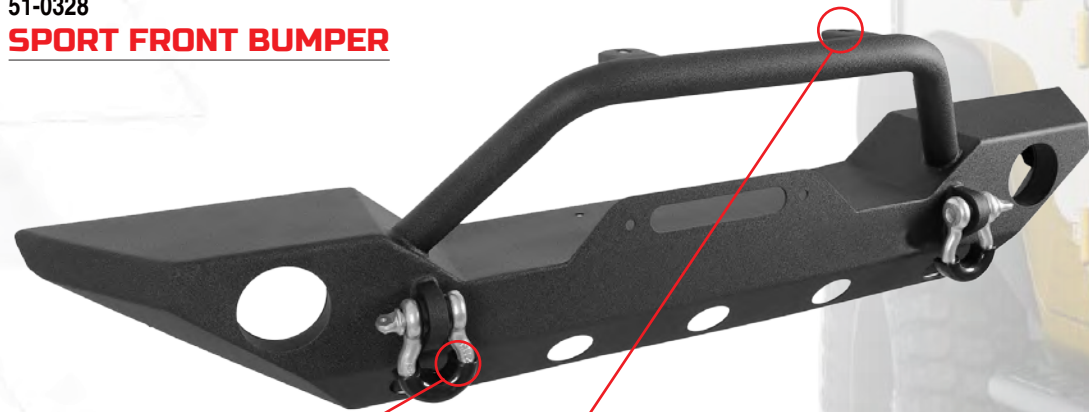

INCLUDES SHACKLES WITH ISOLATORS



BUILT IN LIGHT TABS

51-0366
STINGER FRONT BUMPER

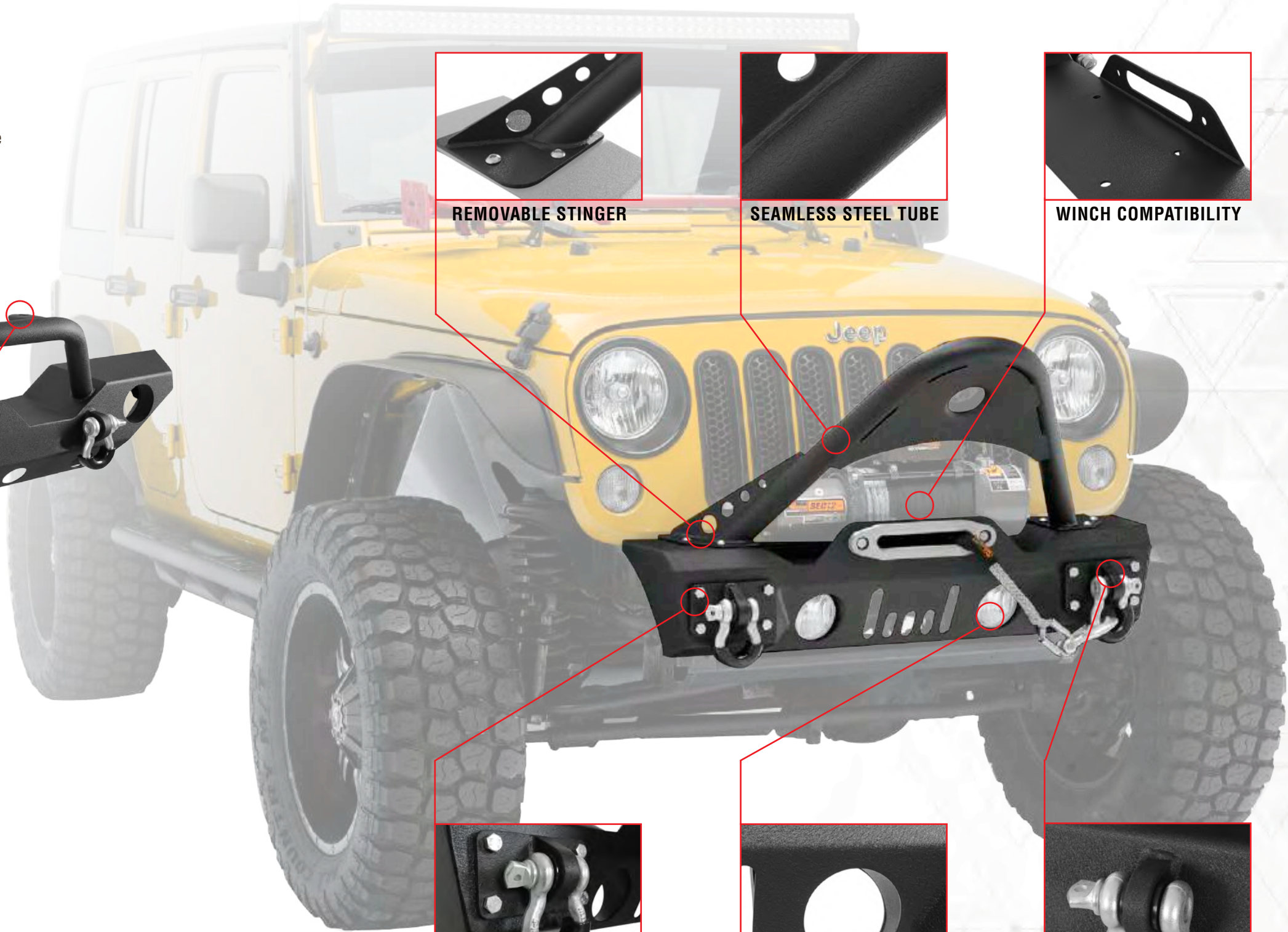

REMOVABLE STINGER



SEAMLESS STEEL TUBE



WINCH COMPATIBILITY



REMOVABLE D-RING MOUNTS FOR VERSATILITY

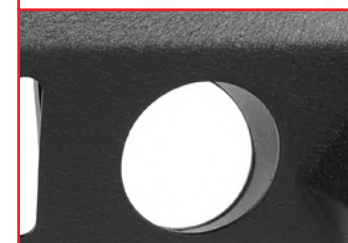

OE FOG LIGHT PROVISION



D-RING MOUNTS WELDED INSIDE AND OUT

PART	YEAR	MAKE	MODEL	DESCRIPTION
51-0328	07-19	JEEP	WRANGLER JK	R3 FRONT BUMPER WITH OE FOG LIGHT HOUSING
51-0366	07-18	JEEP	WRANGLER JK	STINGER FRONT BUMPER W/ OE FOG LIGHT HOUSING

Paramount Automotive's Full Width JK Front Bumpers are the versatile front protection for your Jeep that you need for your next off road adventure. Heavy duty steel construction and multiple features give you the confidence to tackle any trail.

JK FRONT BUMPERS

JK FRONT BUMPERS

FEATURES

- Improves tire clearance while providing superior protection
- Includes 4.75 ton D-Ring shackles with isolators
- Built-In winchplate accommodates up to 12,000 pound winch
- Manufactured from 4mm steel plate with a 2-3/8" overrider
- CNC laser cut and welded for precision and durability
- Textured black powder-coat finish for durability and corrosion resistance
- Lifetime structural warranty against manufacturers defects
- 5 year finish warranty
- Engineered to be direct bolt-on OE replacement

51-7016
FULL WIDTH FRONT BUMPER

51-0362
FULL WIDTH FRONT BUMPER



BUILT IN LIGHT TABS



REMOVABLE OVERRIDER



FOUR 16W CUBE LED LIGHTS



INCLUDES SHACKLES WITH ISOLATORS



120W LED LIGHT BAR



D-RING MOUNTS WELDED INSIDE AND OUT



OE FOG LIGHT PROVISION



INTEGRATED WINCH PLATE



WIRING HARNESS AND SWITCH

PART	YEAR	MAKE	MODEL	DESCRIPTION
51-0362	07-18	JEEP	WRANGLER JK	FULL WIDTH FRONT BUMPER WITH OE FOG LIGHT HOUSING
51-7016	07-18	JEEP	WRANGLER JK	FULL WIDTH LED LIGHT STYLE FRONT BUMPER

Paramount Automotive's SureGrip Rear Bumpers for the JK Wrangler are the choice for the off-road ready Jeep. With its innovative redesign of the rear tire carrier latch, heavy duty construction, increased clearance, built in Class 3 rated receiver hitch and adjustable brake light mount that can accommodate a 37" tire - the SureGrip Bumper is the protection you need for your next off-road adventure.

JK REAR BUMPERS & TIRE CARRIER

JK REAR BUMPERS & TIRE CARRIER

FEATURES

- Improves tire clearance while providing superior protection
- 2" Class 3 rated receiver hitch with safety chain loop
- Includes 4.75 ton D-Ring shackles with isolators
- CNC laser cut and welded for precision and durability
- Manufactured from durable 4mm steel plate
- Textured black powder-coat finish for durability and corrosion resistance
- Lifetime structural warranty against manufacturers defects
- 5 year finish warranty
- Engineered to be a full bolt-on OE replacement

51-0315
BODY WIDTH REAR BUMPER



51-0364
FULL WIDTH REAR BUMPER

62 7/8"

51-0310
BODY WIDTH REAR BUMPER

PART	YEAR	MAKE	MODEL	DESCRIPTION
51-0310	07-18	JEEP	WRANGLER JK	HEAVY DUTY ROCK CRAWLER REAR BUMPER
51-0315	07-18	JEEP	WRANGLER JK	ROCK CRAWLER REAR BUMPER WITH SUREGRIP LATCH TIRE CARRIER
51-0364	07-18	JEEP	WRANGLER JK	FULL WIDTH REAR BUMPER WITH SUREGRIP LATCH TIRE CARRIER



PATENT PENDING

SUREGRIP LATCH



2" CLASS 3 RECEIVER HITCH

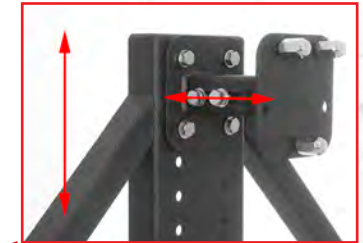

TWO WAY ADJUSTABLE TIRE MOUNT



D-RING MOUNTS WELDED INSIDE AND OUT



CARRIER STOP TO PREVENT BODY DAMAGE



INCLUDES SHACKLES WITH ISOLATORS

FEATURES

- Improves tire clearance while providing superior protection
- 2" Class 3 rated receiver hitch with safety chain loop
- Includes 4.75 ton D-Ring shackles with isolators
- CNC laser cut and welded for precision and durability
- Manufactured from durable 4mm steel plate
- Textured black powder-coat finish for durability and corrosion resistance
- Lifetime structural warranty against manufacturers defects
- 5 year finish warranty
- Engineered to be a full bolt-on OE replacement

51-0400
HEAVY DUTY TIRE CARRIER

51-0395
ROCK CRAWLER REAR BUMPER



ADJUSTABLE THIRD BRAKE LIGHT BRACKET



TWO WAY ADJUSTABLE TIRE CARRIER



BOLT ON INSTALL



HEAVY DUTY PIVOT

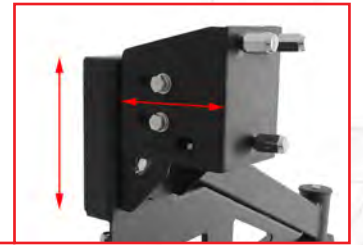

TWO WAY ADJUSTABLE TIRE MOUNT



D-RING MOUNTS WELDED INSIDE AND OUT



INCLUDES SHACKLES WITH ISOLATORS



2" CLASS 3 RECEIVER HITCH

PART	YEAR	MAKE	MODEL	DESCRIPTION
51-0395	07-18	JEEP	WRANGLER JK	BODY WIDTH REAR BUMPER WITH TAILGATE TIRE CARRIER
51-0400	07-18	JEEP	WRANGLER JK	HD STEEL HINGED TIRE CARRIER WITH ADJUSTABLE SPARE TIRE MOUNT

Paramount Automotive's TJ/YJ Front Bumpers offer a variety of high quality steel bumper choices for the off-road ready Jeep. All of our bolt on installation bumpers feature heavy duty design and manufacturing innovations, and options to suit your Jeep's need for superior front and rear protection.

TJ/YJ FRONT BUMPERS

TJ/YJ FRONT BUMPERS

FEATURES

- Improves tire clearance while providing superior protection
- Built-In winchplate accommodates up to 12,000 pound winch
- Includes 4.75 ton D-Ring shackles with isolators
- CNC laser cut and welded for precision and durability
- Manufactured from 4mm steel plate with a 2-3/8" overrider
- Textured black powder-coat finish for durability and corrosion resistance
- Lifetime structural warranty against manufacturers defects
- 5 year finish warranty
- Engineered to be direct bolt-on OE replacement



51-0034
ROCK CRAWLER FRONT BUMPER



51-0007
CLASSIC FRONT BUMPER

PART	YEAR	MAKE	MODEL	DESCRIPTION
51-0007	87-06	JEEP	WRANGLER TJ/YJ	CLASSIC FRONT BUMPER
51-0034	87-06	JEEP	WRANGLER TJ/YJ	ROCK CRAWLER FRONT BUMPER
51-0037	87-06	JEEP	WRANGLER TJ/YJ	FRONT BUMPER



51-0037
STUBBY FRONT BUMPER



BUILT IN LIGHT TABS



WINCH COMPATIBILITY



D-RING MOUNTS WELDED INSIDE AND OUTSIDE



INCLUDES SHACKLES WITH ISOLATORS



HIGH CLEARANCE

Paramount Automotive's TJ/YJ Rear Bumpers offer a variety of high quality steel bumper choices for the off-road ready Jeep. All of our bolt on installation bumpers feature heavy duty design and manufacturing innovations, and options to suit your Jeep's need for superior front and rear protection.

TJ/YJ REAR BUMPERS

TJ/YJ REAR BUMPERS

FEATURES

- Bumper accepts up to 12,000 pound winch with integrated fairlead mount
- 9,500 pound rated 4-3/4 D-Ring shackles
- CNC laser cut and welded for precision and durability
- Manufactured from durable 4mm steel sheet and 2-3/8" steel tubing
- Textured black powder coat finish for durability and corrosion protection
- Lifetime structural warranty 5 Year finish warranty
- Paramount engineered to be direct bolt-on OE replacement

51-0015
HEAVY DUTY REAR BUMPER WITH TIRE CARRIER



51-0014
HEAVY DUTY REAR BUMPER

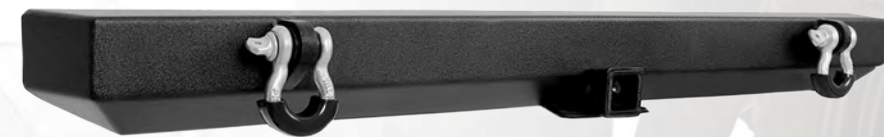

51-0008
CLASSIC REAR BUMPER

PART	YEAR	MAKE	MODEL	DESCRIPTION
51-0008	87-06	JEEP	WRANGLER TJ/YJ	CLASSIC REAR BUMPER
51-0014	87-06	JEEP	WRANGLER TJ/YJ	HEAVY DUTY REAR BUMPER
51-0015	87-06	JEEP	WRANGLER TJ/YJ	HEAVY DUTY REAR BUMPER WITH TIRE CARRIER

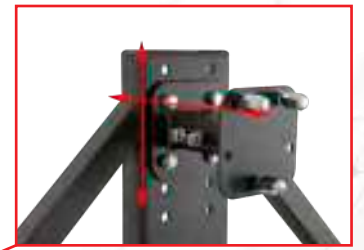

TWO WAY ADJUSTABLE TIRE MOUNT



CARRIER STOP TO PREVENT BODY DAMAGE



INCLUDES SHACKLES WITH ISOLATORS



2" CLASS 3 RECEIVER HITCH



D-RINGS MOUNTS WELDED INSIDE AND OUTSIDE



"SUREGRIP LATCH"

PATENT PENDING



Paramount Automotive's Bumpers for the Grand Cherokee WJ are the muscular front and rear protection designed for the Jeep Wrangler that tackles rugged terrain. Clean, body wrapping design in various widths and options keep your Jeep safe from hazards in even the tightest off-road conditions.

WB

WJ BUMPERS

WJ BUMPERS

FEATURES

- Designed for maximum protection and rear tire boulder clearance
- 2" Class 3 rated receiver hitch with safety chain loop
- Solid 4-3/4 ton capacity D-Ring shackles
- Built in 10x4.5" bolt pattern plate supports up to a 12,000lb winch
- Manufactured from durable 4mm steel sheet
- Fabricated with precise CNC laser cut, and welding for durability
- Lifetime structural warranty 5 Year finish warranty
- Paramount engineered to be a full bolt-on OE replacement



WIRING HARNESS AND SWITCH



TWO 16W CUBE LED LIGHTS



INCLUDES SHACKLES WITH ISOLATORS



WINCH COMPATIBILITY



D-RING MOUNTS WELDED INSIDE AND OUT



2" CLASS 3 RECEIVER HITCH



**51-0805
REAR BUMPER**

**51-0804
FRONT BUMPER WITH LED LIGHTS**

PART	YEAR	MAKE	MODEL	DESCRIPTION
51-0804	99-04	JEEP	GRAND CHEROKEE	FRONT BUMPER WITH LED LIGHTS
51-0805	99-04	JEEP	GRAND CHEROKEE	REAR BUMPER



WINCH COMPATIBILITY



BUILT IN LIGHT TABS



REMOVABLE OVERRIDER



TWO WAY ADJUSTABLE TIRE MOUNT



PATENT PENDING

SUREGRIP LATCH



D-RING MOUNTS WELDED INSIDE AND OUT



INCLUDES SHACKLES WITH ISOLATORS

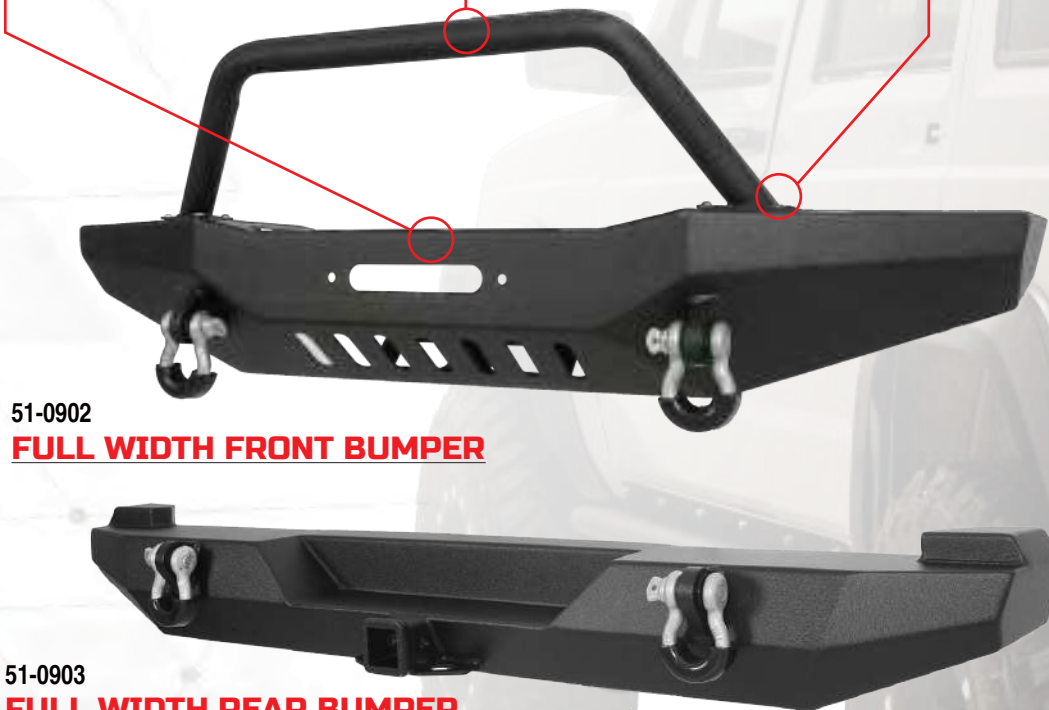

51-0902
FULL WIDTH FRONT BUMPER

51-0903
FULL WIDTH REAR BUMPER



51-0911
REAR BUMPER WITH TIRE CARRIER



2" CLASS 3 RECEIVER HITCH

PART	YEAR	MAKE	MODEL	DESCRIPTION
51-0902	84-01	JEEP	WRANGLER XJ	FULL WIDTH FRONT BUMPER
51-0903	84-01	JEEP	WRANGLER XJ	FULL WIDTH REAR BUMPER
51-0911	84-01	JEEP	WRANGLER XJ	REAR BUMPER WITH TIRE CARRIER

FEATURES

- Improves tire clearance while providing superior protection
- 2" Class 3 rated receiver hitch with safety chain loop
- Includes 4.75 ton D-Ring shackles with isolators
- Built-In winch plate accommodates up to 12,000 pound winch
- Manufactured from durable 4mm steel plate
- CNC laser cut and welded for precision and durability
- Textured black powder-coat finish for durability and corrosion resistance
- Lifetime structural warranty against manufacturers defects
- 5 year finish warranty
- Engineered to be a full bolt-on OE replacement

Improve your truck's appearance, visibility and protection with **Paramount Automotive's** LED Truck Winch Bumper. Designed with built-in brackets for optional 30" LED light bar, heavy duty steel construction to protect and accommodate your 15,000 lb. winch and armored with a textured powder coat to prevent corrosion, this LED Truck winch bumper is the peace of mind you've been wanting for your off road truck. .

TRUCK BUMPERS

TRUCK BUMPERS



57-0115
REAR LED TRUCK BUMPER



WIRING HARNESS AND SWITCH FOR LED LIGHTS

FEATURES

- Improves tire clearance while providing superior protection
- Built-In winch plate accommodates up to 15,000 pound winch
- Includes 4.75 ton D-Ring shackles with isolators
- Injection molded LED light housings
- Pre-installed LED cube lights and light bar
- Brackets for optional 30" LED light bar (Light bar not included)
- Includes wiring harness and switch for LED LIGHTS
- Manufactured from durable 4mm steel plate
- Textured black powder-coat finish for durability and corrosion resistance
- Lifetime structural warranty against manufacturers defects
- Vehicle specific application

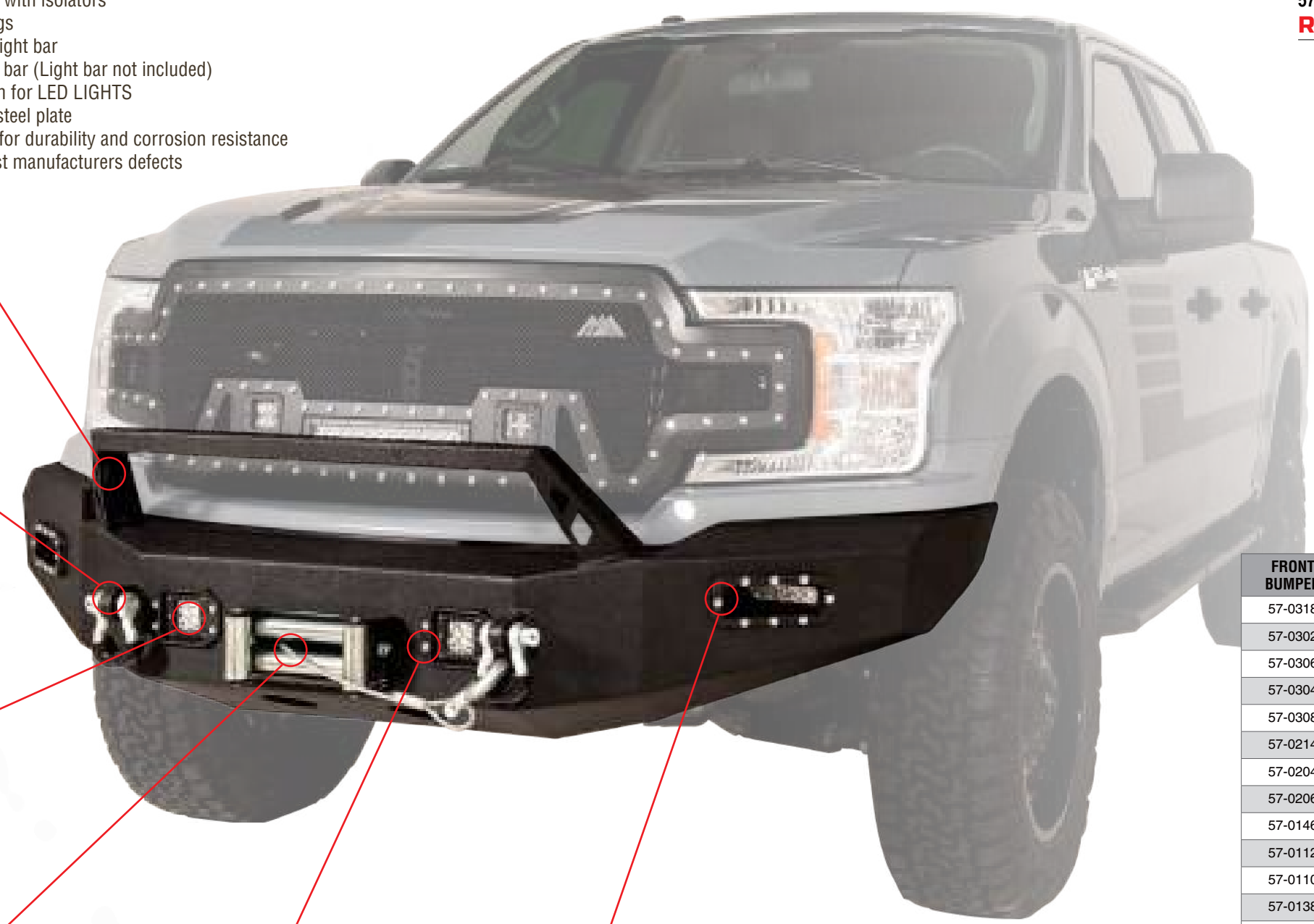

FITS UP TO 30" LED LIGHT



INCLUDES SHACKLES WITH ISOLATORS



TWO 16W CUBE LED LIGHTS



WINCH COMPATIBILITY



ACCENT RIVET



15 WATT LED LIGHTS

57-0146
FRONT LED TRUCK BUMPER

FRONT BUMPER	REAR BUMPER	YEAR	MAKE	MODEL
57-0318	57-0303	16-18	CHEVROLET	SILVERADO 1500
57-0302	57-0303	14-15	CHEVROLET	SILVERADO 1500
57-0306	57-0307	07-13	CHEVROLET	SILVERADO 1500
57-0304	57-0305	15-19	CHEVROLET	SILVERADO 2500/3500
57-0308	57-0309	11-14	CHEVROLET	SILVERADO 2500/3500
57-0214	57-0215	19-20	DODGE	RAM 1500
57-0204	57-0205	13-18	DODGE	RAM 1500
57-0206	57-0207	10-18	DODGE	RAM 2500/3500
57-0146	57-0113	18-19	FORD	F-150
57-0112	57-0113	15-19	FORD	F-150
57-0110	57-0111	09-14	FORD	F-150
57-0138	57-0139	17-19	FORD	F250/F350/F450
57-0114	57-0115	11-16	FORD	F250/F350/F450
57-0514	57-0303	16-18	GMC	SIERRA 1500
57-0502	57-0303	14-15	GMC	SIERRA 1500
57-0306	57-0307	07-13	GMC	SIERRA 1500
57-0504	57-0305	15-19	GMC	SIERRA 2500/3500
57-0418	57-0419	16-19	TOYOTA	TACOMA
57-0404	57-0405	14-19	TOYOTA	TUNDRA
57-0406	57-0407	07-13	TOYOTA	TUNDRA

Paramount Automotive's Roof Rack for the JK/JL Wrangler is the solution you need to haul extra gear and free up much needed breathing room in your Jeep. Our low profile mounting system, front air dam, durable texture powder coated finish, and bolt on installation keep our two and four door rack styles as stealthy as possible.

JL/JK ROOF RACKS

JL/JK ROOF RACKS

FEATURES

- Aerodynamic design with front wind deflector
- Removable center section for access to freedom tops
- Fully welded 1" round steel tubing
- Bolt-on installation
- Capable of carrying up to 300 pounds
- Mounts to factory hard top
- Textured black powder-coat finish for durability and corrosion resistance
- Lifetime structural warranty against manufacturers defects
- 5 year finish warranty



51-0688
(2 DOOR) FULL LENGTH ROOF RACK



51-0687
(4 DOOR) FULL LENGTH ROOF RACK



WIND DEFLECTOR



HEAVY-DUTY DESIGN



REMOVABLE CENTER SECTION



EASY BOLT ON INSTALLTION

51-8125
(4 DOOR) FULL LENGTH ROOF RACK

PART	YEAR	MAKE	MODEL	DESCRIPTION
51-8125	18-19	JEEP	WRANGLER JL	(4 DOOR) FULL LENGTH ROOF RACK (93" X 55")
51-8126	18-19	JEEP	WRANGLER JL	(2 DOOR) FULL LENGTH ROOF RACK (71" X 55")
51-0687	07-18	JEEP	WRANGLER JK	(4 DOOR) FULL LENGTH ROOF RACK (93" X 55")
51-0688	07-18	JEEP	WRANGLER JK	(2 DOOR) FULL LENGTH ROOF RACK (71" X 55")

Paramount Automotive's steel Fender Flares provide your Jeep JK with the additional protection, durability, and increased clearance you need to tackle the off road. Designed and manufactured of 5mm cold rolled steel plate, these "broad shoulders" are designed for easy bolt-on installation making fitment a breeze.

JK R-5 CANYON PRODUCTS

JK R-5 CANYON PRODUCTS

FEATURES

- Fabricated from 5mm cold rolled steel plate
- Maximum clearance ranging from 5" or 8.5" options
- 5-axis robotic welding ensures quality assembly
- Textured black powder-coat finish for durability and corrosion resistance
- Some drilling required for proper installation
- Lifetime structural warranty against manufacturers defects
- 5 year finish warranty

51-0712 + 51-0713
STUBBY FENDER FLARES



RUBBER TRIM



LED LIGHT



5MM SHEET PLATE



REENFORCED STRUCTURE



BRACKET INSIDE



BRACKET INSIDE



51-0710
CANYON FRONT FENDER FLARES

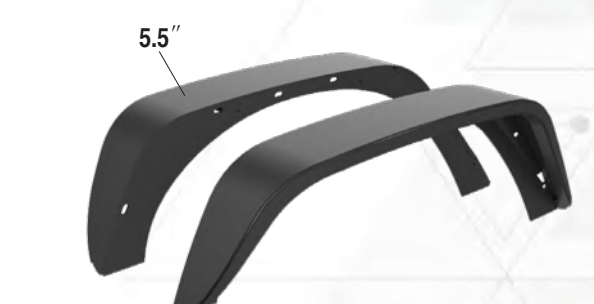

51-0711
CANYON REAR FENDER FLARES



HEAVY DUTY
MOUNTING BRACKET

51-0719
(4 DOOR) CANYON ROCK SLIDER

PART	YEAR	MAKE	MODEL	DESCRIPTION
51-0710	07-18	JEEP	WRANGLER JK	R-5 CANYON OFFROAD FRONT FENDER FLARE WITH LED EAGLE LIGHTS
51-0711	07-18	JEEP	WRANGLER JK	R-5 CANYON OFFROAD REAR FENDER FLARE
51-0712	07-18	JEEP	WRANGLER JK	R-5 CANYON STUBBY FRONT FENDER FLARES WITH LED LIGHTS
51-0713	07-18	JEEP	WRANGLER JK	R-5 CANYON STUBBY REAR FENDER FLARES
51-0719	07-18	JEEP	WRANGLER JK	R-5 CANYON OFFROAD ROCK SLIDER(4 DOOR)
51-0728	07-18	JEEP	WRANGLER JK	R-5 CANYON OFFROAD ROCK SLIDER(2 DOOR)

Built from heavy gauge steel for the highest durability and powder-coated for long life. Every fender flare is engineered to give the maximum clearance allowing the largest tire options. We also incorporated air vents to allow for greater air flow in the engine compartment during extreme conditions. Choose from our armor style front fenders and combine them with our corner guards and rear fender flares makes for ultimate protection off-road.

FEATURES

- Manufactured from 4mm heavy duty steel plate
- Textured black powder-coat finish for durability and corrosion resistance
- Front fenders include a 3/4" LED marker light
- Designed for maximum tire clearance
- Some drilling required for proper installation
- Lifetime structural warranty against manufacturers defects
- 5 year finish warranty

TJ FENDER FLARES

TJ FENDER FLARES



AMBER LED LIGHTS

51-0066 + 0067
FRONT & REAR FENDER FLARES



SHEET METAL STRUCTURE



MAXIMUM TIRE CLEARANCE

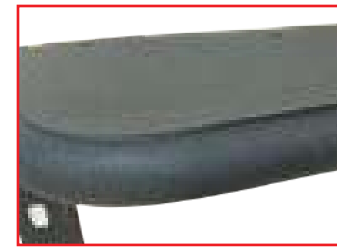

1 5/8" TUBE STRUCTURE

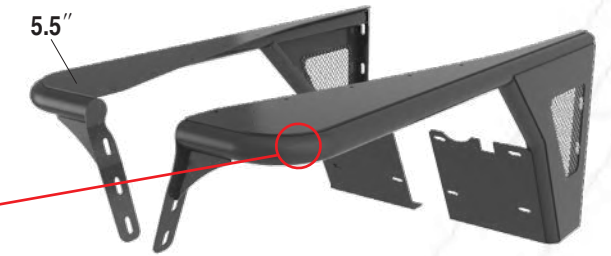

51-0041
ARMOR FRONT FENDERS



51-0042
ARMOR FRONT FENDERS



51-0044
ARMOR REAR FENDERS

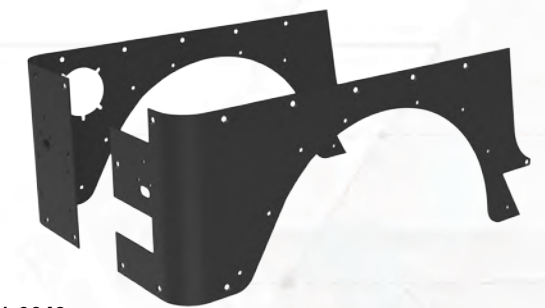

51-0043
CORNER GUARDS



51-0065
FRONT FENDERS



VENTED MESH DESIGN

PART	YEAR	MAKE	MODEL	DESCRIPTION
51-0041	97-06	JEEP	WRANGLER TJ	FRONT FENDER (ALSO FIT 04-16 LJ)
51-0042	97-06	JEEP	WRANGLER TJ	FRONT FENDER WITH FLAIR (ALSO FIT 04-16 LJ)
51-0043	97-06	JEEP	WRANGLER TJ	CORNER GUARD (NOT FIT FOR LJ)
51-0044	97-06	JEEP	WRANGLER TJ	REAR FENDER (ALSO FIT 04-16 LJ)
51-0065	97-06	JEEP	WRANGLER TJ	FRONT FENDER WITH LED LIGHTS
51-0066	97-06	JEEP	WRANGLER TJ	FRONT FENDER WITH FLAIR WITH LED LIGHTS
51-0067	97-06	JEEP	WRANGLER TJ	REAR FENDER

Paramount Automotive's JK Rock Sliders offer a variety of stylish, steel hard protection for your JK Wrangler's rocker panels. Whether bouncing off of boulders or glancing off of a tree, you'll have peace of mind knowing that your Jeep's rocker panels will be armored for off road adventures, and look good doing it.

JL/JK ROCK SLIDERS

JL/JK ROCK SLIDERS

FEATURES

- Bolt on installation using OE body mounts
- Rock sliders provides side and undercarriage protection
- Available for both 2 door and 4 door applications
- Manufactured from durable 2.120" wall steel tube
- Textured black powder-coat finish for durability and corrosion resistance
- Lifetime structural warranty against manufacturers defects
- 5 year finish warranty



DIMPLE DIED PLATE DESIGN



HD BODY MOUNT BRACKET

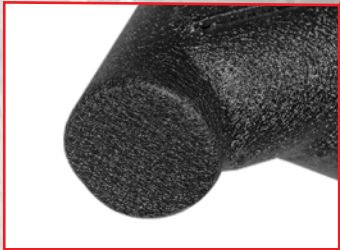

SEALED TO ELIMINATE RUST



2 INCH .120" WALL STEEL TUBING



51-0726
(4 DOOR) ROUND HOLE ROCKER SLIDER



51-7008
(4 DOOR) ROUND HOLE RUNNING BOARD



51-8119
(4 DOOR) TRI-TUBE ROCK SLIDER WITH STEP BAR

PART	YEAR	MAKE	MODEL	DESCRIPTION
51-0727	07-18	JEEP	WRANGLER JK	(2 DOOR) ROUND HOLE ROCK SLIDER
51-0726	07-18	JEEP	WRANGLER JK	(4 DOOR) ROUND HOLE ROCK SLIDER
51-7009	07-18	JEEP	WRANGLER JK	(2 DOOR) ROUND HOLE RUNNING BOARD
51-7008	07-18	JEEP	WRANGLER JK	(4 DOOR) ROUND HOLE RUNNING BOARD
51-7014	07-18	JEEP	WRANGLER JK	(2 DOOR) TRI-TUBE ROCK SLIDER WITH STEP BAR
51-7013	07-18	JEEP	WRANGLER JK	(4 DOOR) TRI-TUBE ROCK SLIDER WITH STEP BAR
51-8118	18-19	JEEP	WRANGLER JL	(2 DOOR) ROUND HOLE ROCK SLIDER/RUNNING BOARD
51-8117	18-19	JEEP	WRANGLER JL	(4 DOOR) ROUND HOLE ROCK SLIDER/RUNNING BOARD
51-8120	18-19	JEEP	WRANGLER JL	(2 DOOR) TRI-TUBE ROCK SLIDER WITH STEP BAR
51-8119	18-19	JEEP	WRANGLER JL	(4 DOOR) TRI-TUBE ROCK SLIDER WITH STEP BAR
51-8151	18-19	JEEP	WRANGLER JL	(2 DOOR) TUBULAR ROUND HOLE ROCK SLIDER
51-8150	18-19	JEEP	WRANGLER JL	(4 DOOR) TUBULAR ROUND HOLE ROCK SLIDER

Paramount Automotive's Rock Guards offer the steel hard armored solution your TJ or YJ needs against the punishing off road terrain. The durable steel sheet and tubing construction and textured powder coat protection keep your Jeep looking as good as when you pulled out of the driveway.

FEATURES

- Manufactured from heavy duty 4mm steel plate
- Integrated side steps double as side armor for additional protection
- CNC laser cut and precision brake formed for an exact fit
- Some drilling required for proper installation
- Textured black powder-coat finish for durability and corrosion resistance
- Lifetime structural warranty against manufacturers defects
- 5 year finish warranty

51-0039
TJ ROCK GUARD

51-0040
TJ ROCK GUARD WITH STEP BOARD

51-0104
YJ ROCKER GUARD

51-0105
YJ ROCK GUARD WITH STEP BOARD



**DURABLE 4MM
STEEL SHEET**



**2" X .120" WALL
STEEL TUBING**

TJ/YJ ROCK GUARDS

TJ/YJ ROCK GUARDS

PART	YEAR	MAKE	MODEL	DESCRIPTION
51-0039	97-06	JEEP	WRANGLER TJ	ROCKER GUARD
51-0040	97-06	JEEP	WRANGLER TJ	ROCKER GUARD WITH STEP BOARD
51-0104	87-96	JEEP	WRANGLER YJ	ROCKER GUARD
51-0105	87-96	JEEP	WRANGLER YJ	ROCKER GUARD WITH STEP BOARD



Paramount Automotive's Traildriver Jeep Fender Flares are your stylish protection solution to safeguard your Jeep for off-road adventuring and street driving. Designed and manufactured from high impact ProGuard® thermoformed plastic materials, our fender flares combine rugged durability, easy-to-install flexibility, and stylish versatility accepting a variety of modifications.



JEEP PLASTIC FENDER FLARES

JEEP PLASTIC FENDER FLARES

FEATURES

- Constructed of heavy duty ProGuard® plastic
- 100% UV protection for maximum durability
- Includes LED lights or accepts OE side marker
- Can be paint-matched to Jeep color if so desired
- No-Drill design for fast and simple installation
- Made in the U.S.A.
- 5 year warranty

17191
YJ RIVET/POCKET FENDER FLARES



ACCENT RIVET

17192
TJ/YJ FLAT-STYLE FENDER FLARES



17195
JK PLASTIC FENDER FLARES

PART	YEAR	MAKE	MODEL	DESCRIPTION
17195	07-18	JEEP	WRANGLER JK	4 PIECE FLAT STYLE FENDER FLARES
17192	87-96	JEEP	WRANGLER TJ/YJ	4 PIECE FLAT-STYLE FENDER FLARE
17191	97-06	JEEP	WRANGLER YJ	RIVET/POCKET TEXTURED FENDER FLARE



Paramount Automotive's Fender Flare Inner Liners provide your Jeep JK/JL with additional protection, durability, and increased clearance, with a rugged, stylish design. Manufactured from cold-rolled steel, aluminum or plastic, these inner liners are your easy bolt-on protection and style solution.

FEATURES

PLASTIC

- Constructed of Thermo-formed ABS plastic
- Compatible with any aftermarket fender flares
- Some drilling required for proper installation
- Engineered and manufactured in the U.S.A.
- 5 year warranty

FEATURES

ALUMINUM

- Constructed to reseal your engine and provide airflow
- Manufactured from 6061 aircraft-grade aluminum alloy
- Wire-drawing finish that is rust-free and appealing
- 5 year warranty

FENDER FLARE INNER LINERS

FENDER FLARE INNER LINERS



58-0100

JK FENDER FLARE INNER LINERS (PLASTIC)

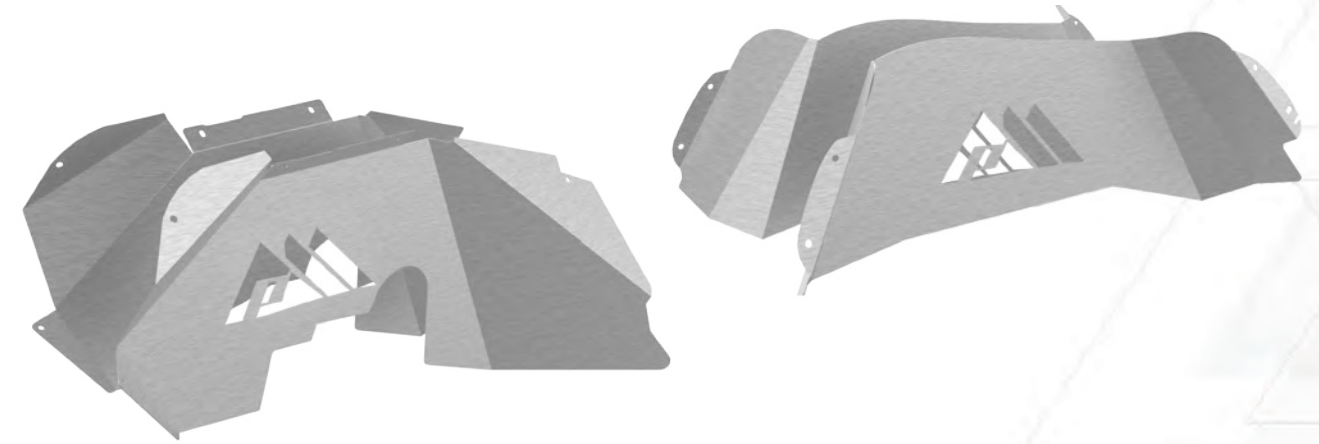

51-0685+51-0686

JK FENDER FLARE INNER LINERS (ALUMINUM)



PART	YEAR	MAKE	MODEL	DESCRIPTION
51-0685	07-18	JEEP	WRANGLER JK	JK ALUMINUM FRONT INNER FENDER KIT
51-0686	07-18	JEEP	WRANGLER JK	JK ALUMINUM REAR INNER FENDER KIT
58-0100	07-18	JEEP	WRANGLER JK	JK PLASTIC FENDER INNER LINER
58-0101	08-19	JEEP	WRANGLER JL	JL PLASTIC FENDER INNER LINER
58-0102	19-20	JEEP	WRANGLER JT	JT PLASTIC FENDER INNER LINER

Paramount Automotive's Jeep Wrangler Grilles offer a wide range of grilles to help complete your Jeep's look. From inserts made of ABS plastic, aluminum billet, and stainless steel mesh to full replacement packaged grilles, Paramount Automotive has just the grille for you. No drilling or cutting is required on most of these easy to install grilles.

Paramount Automotive's Accessories provide an extensive range of products to maximize the utility off your Jeep. Offering a wide series of light mount brackets, hood scoops, and even a patent pending backup camera extension, Paramount Automotive is relentless in trying to cater to your needs. Use Paramount Automotive Accessories to unlock your Jeep's full potential!

GRILLE INSERTS & ACCESSORIES

GRILLE INSERTS & ACCESSORIES

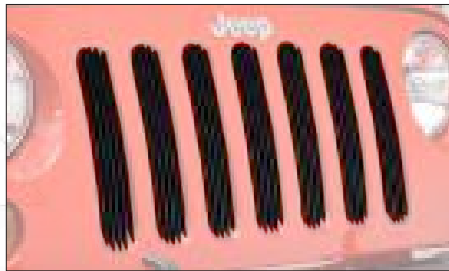

30-0105B
JK 7PCS Black Overlay Billet Grilles



30-0116
JL 7PCS POLISHED OVERLAY BILLET GRILLES



30-0116B
JL 7PCS BLACK OVERLAY BILLET GRILLES



43-0340B
JK BLACK STAINLESS STEEL WIRE MESH GRILLE INSERT

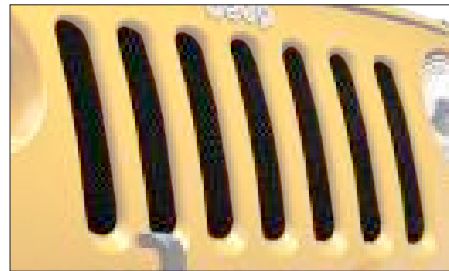

43-0340B
JK BLACK STAINLESS STEEL WIRE MESH GRILLE INSERT



43-0354
JL 7PCS CHROME OVERLAY STAINLESS STEEL WIRE MESH GRILLE



51-0452
TJ 52" LED LIGHT BAR MOUNT BRACKETS



51-0453
JK WINDSHIELD LIGHT MOUNT BRACKETS



51-0464
JK HOOD 20" LED BAR MOUNTING BRACKETS



51-0470
JK WINDSHIELD DOUBLE LIGHT MOUNT BRACKETS



51-8401
JL TIRE RELOCATION BRACKET



51-8420
JL/JK LICENSE PLATE BRACKET ON TIRE CARRIER (NOT FIT FOR JL OR TIRE CARRIER)



51-0549
JL HI LIFT JACK BRACKET ON FRONT/REAR DOOR HINGE OR HOOD HINGE



51-0445
JK SPARE TIRE RELOCATION MOUNTING BRACKET

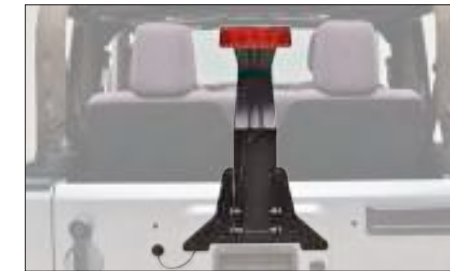

51-0459
JK THIRD BRAKE LIGHT MOUNTING BRACKET



51-0534
JK DOOR HINGE STEP



51-0538
JK VACUUM RELOCATION BRACKET



51-0490
JK SIDE VIEW MIRROR WITH PILLAR MOUNT



51-0511
CJ/YJ/TJ/JK SIDE VIEW MIRROR (PAIR)



51-0526
RED D-RING (4.75 TON, PAIR) WITH BLACK ISOLATOR

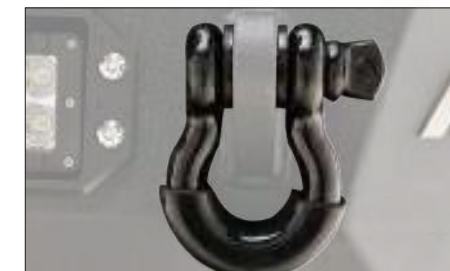

51-0532
BLACK D-RING (4.75 TON, PAIR) WITH BLACK ISOLATOR



Paramount Automotive's Fender Flare Inner Liners provide your Jeep JK/JL with additional protection, durability, and increased clearance, with rugged styling design. Manufactured from aluminum or plastic, these inner liners are easy bolt-on protection and style solution



JK FLOOR LINERS

JK FLOOR LINERS

FEATURES

- 2" high sidewalls trap spills and keeps your factory carpets fresh and clean
- Cross hatch pattern provides traction to help remove mud, snow, and dirt away from shoes and boots
- Thermo Polyolefin (TPO) construction provides ultimate long lasting durability
- Factory hook attachment ensures the floor liners stay in place long after installation
- Designed and built in the USA
- 5 year warranty

59-0211
REAR CARGO FLOOR LINERS

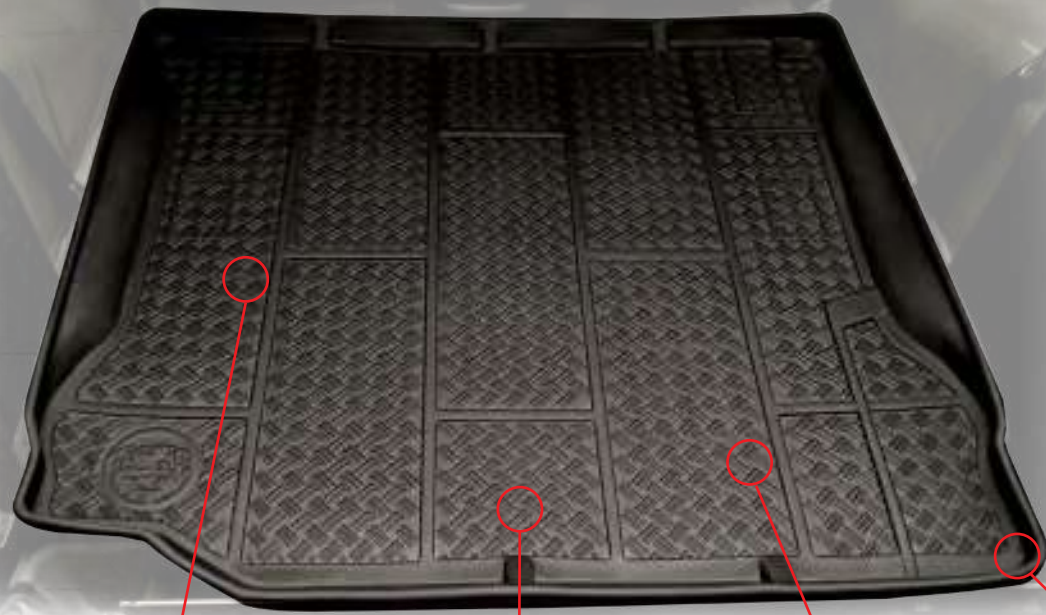

CUSTOM MOLDED



SPILL RESISTANT



PROTECTS VEHICLE INTERIOR



2" HIGH SIDEWALLS

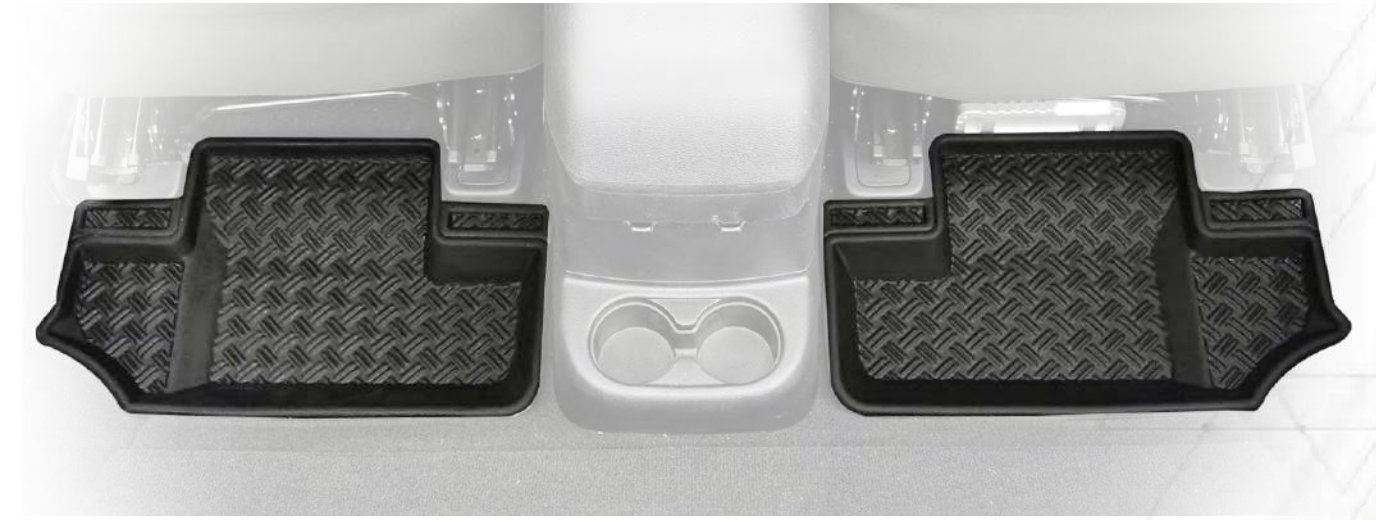

CONTOURED FIT



CROSS HATCH PATTERN

PART	YEAR	MAKE	MODEL	DESCRIPTION
59-0111	07-13	JEEP	WRANGLER JK	2PC 2 DOOR/4 DOOR FRONT FLOOR LINERS
59-0112	07-18	JEEP	WRANGLER JK	2PCS 2 DOOR REAR FLOOR LINERS
59-0113	07-18	JEEP	WRANGLER JK	1PCS 4 DOOR REAR FLOOR LINER
59-0114	14-18	JEEP	WRANGLER JK	2PCS 2 DOOR/4 DOOR FRONT FLOOR LINERS
59-0211	07-18	JEEP	WRANGLER JK	1PC 2 DOOR/4 DOOR REAR CARGO FLOOR LINER
59-1124	07-13	JEEP	WRANGLER JK	4PCS 2 DOOR FRONT AND REAR FLOOR LINERS
59-1125	07-13	JEEP	WRANGLER JK	3PCS 4 DOOR FRONT AND REAR FLOOR LINERS
59-1126	14-18	JEEP	WRANGLER JK	4PCS 2 DOOR FRONT AND REAR FLOOR LINERS
59-1127	14-18	JEEP	WRANGLER JK	3PCS 4 DOOR FRONT AND REAR FLOOR LINERS

Now available Paramount Automotive's point-of-purchase displays are made from heavy duty steel and powder-coated for a great look in any showroom. Available in three configurations; Jeep Wrangler JL bumper applications, two front and one rear with tire carrier, Jeep Wrangler JK bumper applications, two front and rear with tire carrier and Jeep Wrangler JK/JL rock sliders and steel fender flares. Every rack comes pre-packaged; with hardware, brackets, casters, and sign holder.

POP BUMPER DISPLAY RACKS



51-3001
POP BUMPER DISPLAY RACK WITH JEEP JK BUMPERS



51-3002
POP BUMPER DISPLAY RACK WITH JEEP JL BUMPERS



51-3003
POP BUMPER DISPLAY RACK WITH JEEP JK/JL ROCK GUARDS AND FENDERS

PART#	DESCRIPTION
51-3001	POP BUMPER DISPLAY RACK WITH JEEP WRANGLER JK BUMPERS
51-3002	POP BUMPER DISPLAY RACK WITH JEEP WRANGLER JL BUMPERS
51-3003	POP DISPLAY RACK WITH JEEP WRANGLER JK/JL ROCK SLIDERS AND FENDER FLARES