

Water pumps

Legend

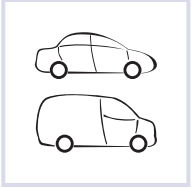

Make and model

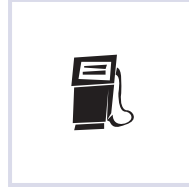

Type of fuel

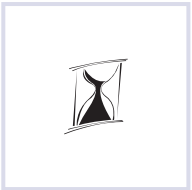

Manufacturing year

- B** Petrol
- BF** Bi-Fuel
- D** Diesel
- FF** Flex-Fuel
- G** Gas
- M** Methane



Number of cylinders



Output kW

cm³

Capacity cm³

Magneti Marelli references



Type of gear



Technical information

A Automatic transmission

M Manual transmission

OES/IAM

IAM/OES Reference

NO. OF VALVES

No. of valves

(+)AC

Air Conditioning Unit

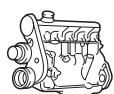

Motor code

(-)AC

Without air conditioning Ohne

(+)COP

With backhousing

(+)SS

Power steering

(-)COP

Without backhousing

(-)SS

W/O Power steering

M

Engine No.

T

Chassis no.

MAT AL

Aluminium

VA

Automatic ventilator

MAT Gh

Cast iron

VF

Fixed ventilator

| | | | |
|--------------------------------|--------------------|------------------------------------|------------------------|
| ALBERINO | Alberino | Diametro Mozzo | Hub diameter |
| Altezza Puleggia | Pulley height | Diametro Puleggia | Pulley diameter |
| Diametro Alberino | Shaft diameter | Dimensione Fori Flangia | Flange holes dimension |
| Diametro Centraggio | Centering diameter | FLANGIA | Flange |
| Diametro Girante | Impeller diameter | N° Alette Girante | No. Impeller fins |

| | | | |
|--|--------------------------|----------------------------------|-------------------|
| Numero Denti/ Gole Puleggia | No. pulley teeth/throats | Posizione Girante | Impeller position |
| Numero Fori Flangia | No. flange holes | PULEGGIA | Pulley |
| Posizione Attacco | Fixing position | Tipo Filetto Alberino | Shaft thread type |

Magneti Marelli After Market Parts and Services S.p.A. has devoted its best attention to the editing of this catalogue; it nevertheless declines any responsibility for possible mistakes or omissions regarding figures, drawings, pictures, correspondence with O.E. codes etc. and it reserves the right to modify the contents without prior notice. Users' comments, reports of inaccuracies or any other suggestions which may in any way improve the next edition of this catalogue are warmly welcomed.

Vehicle application guide

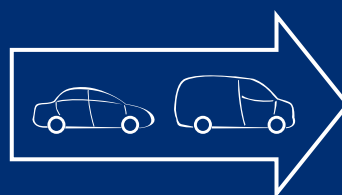

KW

cm³

NO. OF VALVES

ABARTH
500

| | | | | | | | | | | |
|-----|-----|---------|-------|---|---|---|----|----------------------|----------|-------|
| 1.4 | 99 | 08/08 → | 1.368 | B | M | 4 | 16 | 312A1.000 | PIERBURG | 81369 |
| | 103 | 05/10 → | 1.368 | B | M | 4 | 16 | 312A3.000 | TESMA | 82070 |
| | 118 | 08/08 → | 1.368 | B | M | 4 | 16 | 312A1.000, 312A3.000 | TESMA | 82070 |
| | 132 | 08/08 → | 1.368 | B | M | 4 | 16 | 312A3.000 | TESMA | 82070 |
| | 139 | 08/08 → | 1.368 | B | M | 4 | 16 | 312A1.000, 312A9.000 | TESMA | 82070 |

500C

| | | | | | | | | | | |
|-----|-----|---------|-------|---|---|---|----|----------------------|-------|-------|
| 1.4 | 99 | 01/11 → | 1.368 | B | M | 4 | 16 | 312A1.000 | TESMA | 82070 |
| | 103 | 09/09 → | 1.368 | B | M | 4 | 16 | 312A3.000 | TESMA | 82070 |
| | 118 | 05/11 → | 1.368 | B | M | 4 | 16 | 312A1.000, 312A3.000 | TESMA | 82070 |
| | 132 | 09/09 → | 1.368 | B | M | 4 | 16 | 312A3.000 | TESMA | 82070 |

Grande Punto

| | | | | | | | | | | |
|-----|-----|---------------|-------|---|---|---|----|----------------------|----------|-------|
| 1.4 | 114 | 12/07 → 06/10 | 1.368 | B | M | 4 | 16 | 199A8.000 | PIERBURG | 81369 |
| | 132 | 12/07 → 12/12 | 1.368 | B | M | 4 | 16 | 199A8.000, 955A8.000 | PIERBURG | 81369 |

Punto

| | | | | | | | | | | |
|-----|-----|---------|-------|---|---|---|----|----------------------|-------|-------|
| 1.4 | 120 | 10/09 → | 1.368 | B | M | 4 | 16 | 955A8.000 | TESMA | 82070 |
| | 132 | 07/08 → | 1.368 | B | M | 4 | 16 | 199A8.000, 955A8.000 | TESMA | 82070 |

ACURA
CL

| | | | | | | | | | | |
|----------|-----|---------------|-------|---|---|---|----|-------|--|-------|
| 2.2 | 108 | 10/96 → 09/97 | 2.156 | B | M | 4 | 16 | F22B2 | | 81708 |
| 2.3 Vtec | 112 | 10/98 → 09/00 | 2.254 | B | M | 4 | 16 | F23A7 | | 81708 |

Integra III

| | | | | | | | | | | |
|--------|-----|---------------|-------|---|---|---|----|-------|--|-------|
| 1.8 LS | 125 | 10/93 → 09/01 | 1.797 | B | M | 4 | 16 | F18C1 | | 81839 |
|--------|-----|---------------|-------|---|---|---|----|-------|--|-------|

ALFA ROMEO
33 I, Sportwagon

| | | | | | | | | | | |
|-----|----|---------------|-------|---|---|---|---|---------|--|--------|
| 1.5 | 70 | 05/83 → 12/93 | 1.490 | B | M | 4 | 8 | AR30182 | | 11706T |
|-----|----|---------------|-------|---|---|---|---|---------|--|--------|

33 II, Sportwagon

| | | | | | | | | | | |
|-------------|-----|---------------|-------|---|---|---|----|------------------|--|--------|
| 1.4 i.e. | 65 | 06/91 → 09/94 | 1.351 | B | M | 4 | 8 | AR30753, AR30755 | | 11706T |
| | 66 | 06/91 → 09/94 | 1.351 | B | M | 4 | 8 | AR30755 | | 11706T |
| | 65 | 06/91 → 09/94 | 1.351 | B | M | 4 | 8 | AR30753, AR30755 | | 11706T |
| | 66 | 06/91 → 09/94 | 1.351 | B | M | 4 | 8 | AR30753, AR30755 | | 11706T |
| 1.5 | 77 | 01/90 → 04/93 | 1.490 | B | M | 4 | 8 | AR30734 | | 11706T |
| 1.5 i.e. | 71 | 01/90 → 09/94 | 1.490 | B | M | 4 | 8 | AR30751 | | 11706T |
| | 74 | 07/90 → 08/91 | 1.490 | B | M | 4 | 8 | AR30750 | | 11706T |
| 1.7 16V | 101 | 01/90 → 03/92 | 1.712 | B | M | 4 | 16 | AR30746 | | 11706T |
| | 95 | 01/90 → 09/94 | 1.712 | B | M | 4 | 16 | AR30747 | | 11706T |
| | 97 | 01/90 → 03/92 | 1.712 | B | M | 4 | 16 | AR30747 | | 11706T |
| | 101 | 01/90 → 03/92 | 1.712 | B | M | 4 | 16 | AR30746 | | 11706T |
| 1.7 16V 4x4 | 95 | 01/90 → 09/94 | 1.712 | B | M | 4 | 16 | AR30747 | | 11706T |
| | 97 | 01/90 → 09/94 | 1.712 | B | M | 4 | 16 | AR30747 | | 11706T |
| | 101 | 01/90 → 09/94 | 1.712 | B | M | 4 | 16 | AR30746 | | 11706T |

KW

cm³

NO. OF VALVES

ALFA ROMEO
33 II, Sportwagon

| | | | | | | | | | | |
|--------------|----|---------------|-------|---|---|---|---|------------------|--|--------|
| 1.7 i.e. | 77 | 04/92 → 09/94 | 1.712 | B | M | 4 | 8 | AR30737 | | 11706T |
| | 77 | 04/92 → 09/94 | 1.712 | B | M | 4 | 8 | AR30737A | | 11706T |
| | 79 | 01/90 → 09/94 | 1.712 | B | M | 4 | 8 | AR30736, AR30737 | | 11706T |
| 1.7 i.e. 4x4 | 79 | 01/90 → 03/92 | 1.712 | B | M | 4 | 8 | AR30736, AR30737 | | 11706T |
| | 79 | 01/90 → 03/92 | 1.712 | B | M | 4 | 8 | AR30736, AR30737 | | 11706T |
| 1.8 TD | 62 | 07/90 → 09/94 | 1.779 | D | M | 3 | 6 | VM96A | | 81302 |

75

| | | | | | | | | | | |
|----------------|-----|---------------|-------|---|---|---|----|------------------|----|---------|
| 1.6 | 81 | 05/89 → 02/92 | 1.567 | B | M | 4 | 8 | AR61101 | | 11701T |
| 1.8 | 95 | 05/89 → 12/92 | 1.779 | B | M | 4 | 8 | AR61202 | | 11701T |
| | 95 | 08/89 → 02/92 | 1.773 | B | M | 4 | 8 | AR67101 | | 11701T |
| | 88 | 09/88 → 02/92 | 1.779 | B | M | 4 | 8 | AR06168, AR61102 | | 11701T |
| | 90 | 08/89 → 02/92 | 1.779 | B | M | 4 | 8 | AR61201 | | 11701T |
| 1.8 Turbo | 110 | 09/86 → 02/92 | 1.779 | B | M | 4 | 8 | AR06134 | | 11701T |
| 1.8 Turbo i.e. | 114 | 02/86 → 01/90 | 1.779 | B | M | 4 | 8 | AR06134, AR06158 | | 11701T |
| 2.0 T.S | 109 | 05/85 → 02/92 | 1.962 | B | M | 4 | 8 | AR06224 | | 11701T |
| | 107 | 01/87 → 02/92 | 1.962 | B | M | 4 | 8 | AR06166, AR06224 | | 11701T |
| 2.5 V6 Cat. | 113 | 09/86 → 05/90 | 2.492 | B | M | 6 | 12 | AR01648 | BC | 11707 |
| 3.0 V6 | 136 | 01/87 → 02/92 | 2.959 | B | M | 6 | 12 | AR06120, AR06124 | BC | 11707 |
| | 141 | 02/90 → 02/92 | 2.959 | B | M | 6 | 12 | AR61503 | | 19532/E |

145

| | | | | | | | | | | |
|----------------------|-----|---------------|-------|---|---|---|----|------------------------------|---------------------------------|--------|
| 1.4 i.e. | 66 | 07/94 → 12/96 | 1.351 | B | M | 4 | 8 | AR33501 | 07-1994 →, → 09-1996 | 11706T |
| 1.4 i.e. 16V T.S. | 76 | 12/96 → 01/01 | 1.370 | B | M | 4 | 16 | AR33503, AR38501 | | 81331 |
| 1.6 16V T.S. | 82 | 09/97 → 12/00 | 1.598 | B | M | 4 | 16 | AR32102 | | 81348 |
| 1.6 i.e. | 76 | 10/94 → 12/96 | 1.596 | B | M | 4 | 8 | AR33201 | | 11706T |
| 1.6 i.e. 16V T.S. | 88 | 12/96 → 01/01 | 1.598 | B | M | 4 | 16 | AR38201, AR67601 | | 81348 |
| 1.7 i.e. 16V | 95 | 10/94 → 12/96 | 1.712 | B | M | 4 | 16 | AR33401 | | 11706T |
| 1.8 i.e. 16V | 106 | 03/98 → 01/01 | 1.747 | B | M | 4 | 16 | AR32201 | | 81331 |
| 1.8 i.e. 16V T.S. | 103 | 12/96 → 12/98 | 1.747 | B | M | 4 | 16 | AR38401, AR67106, AR67199 | | 81331 |
| 1.9 JTD | 77 | 02/99 → 01/01 | 1.910 | D | M | 4 | 8 | AR32302 | | 81352 |
| 1.9 TD | 66 | 10/94 → 02/99 | 1.929 | D | M | 4 | 8 | AR33601, AR67501 | (-)COP, 10-1994 →, → 02-1999 | 81326 |
| | 66 | 10/94 → 02/99 | 1.929 | D | M | 4 | 8 | AR33601, AR67501 | (-)COP, 10-1996 →, → 02-1999 | 81363 |
| | 66 | 10/94 → 02/99 | 1.929 | D | M | 4 | 8 | AR33601, AR67501 | (+)COP, 10-1994 →, → 09-1996 | 81464 |
| | 66 | 10/94 → 02/99 | 1.929 | D | M | 4 | 8 | AR33601, AR67501 | (+)COP, 10-1996 →, → 02-1999 | 81347 |
| 2.0 16V Quadrifoglio | 114 | 03/98 → 01/01 | 1.970 | B | M | 4 | 16 | AR32301 | | 81331 |
| 2.0 16V T.S. | 110 | 10/95 → 01/01 | 1.970 | B | M | 4 | 16 | AR67204 | | 81331 |

| | | | | | | | | | | | |
|--|--|-----------|--|-----------------------|--|--|--|----------------------|--|--|------------------------|
| | | KW | | cm³ | | | | NO. OF VALVES | | | MAGNETI MARELLI |
|--|--|-----------|--|-----------------------|--|--|--|----------------------|--|--|------------------------|

ALFA ROMEO

146

| | | | | | | | | | | |
|----------------------|-----|---------------|-------|---|---|---|----|------------------|---------------------------------|--------|
| 1.4 i.e. | 66 | 12/94 → 12/96 | 1.351 | B | M | 4 | 8 | AR33501 | 05-1995 →, → 09-1996 | 11706T |
| 1.4 i.e. 16V T.S. | 76 | 11/96 → 01/01 | 1.370 | B | M | 4 | 16 | AR33503, AR38501 | | 81331 |
| 1.6 16V T.S. | 82 | 09/97 → 12/00 | 1.598 | B | M | 4 | 16 | AR32102 | | 81348 |
| 1.6 i.e. | 76 | 12/94 → 12/96 | 1.596 | B | M | 4 | 8 | AR33201 | 05-1995 →, → 09-1996 | 11706T |
| 1.6 i.e. 16V T.S. | 88 | 11/96 → 01/01 | 1.598 | B | M | 4 | 16 | AR38201, AR67601 | | 81348 |
| 1.7 i.e. 16V | 95 | 12/94 → 12/96 | 1.712 | B | M | 4 | 16 | AR33401 | 05-1995 →, → 09-1996 | 11706T |
| 1.8 i.e. 16V T.S. | 103 | 11/96 → 01/01 | 1.747 | B | M | 4 | 16 | AR38401, AR67106 | | 81331 |
| | 106 | 03/98 → 01/01 | 1.747 | B | M | 4 | 16 | AR32201 | | 81331 |
| 1.9 JTD | 77 | 02/99 → 01/01 | 1.910 | D | M | 4 | 8 | AR32302 | | 81352 |
| 1.9 TD | 66 | 12/94 → 02/99 | 1.929 | D | M | 4 | 8 | AR33601, AR67501 | (-)COP, 10-1995 → | 81363 |
| | 66 | 12/94 → 02/99 | 1.929 | D | M | 4 | 8 | AR33601, AR67501 | (-)COP, 12-1994 →, → 09-1996 | 81326 |
| | 66 | 12/94 → 02/99 | 1.929 | D | M | 4 | 8 | AR33601, AR67501 | (+)COP, 10-1996 →, → 02-1999 | 81347 |
| | 66 | 12/94 → 02/99 | 1.929 | D | M | 4 | 8 | AR33601, AR67501 | (+)COP, 12-1994 →, → 09-1996 | 81464 |
| 2.0 16V Quadrifoglio | 114 | 03/98 → 01/01 | 1.970 | B | M | 4 | 16 | AR32301 | | 81331 |
| 2.0 16V T.S. | 110 | 10/95 → 01/01 | 1.970 | B | M | 4 | 16 | AR67204 | 10-1995 → | 81331 |

147

| | | | | | | | | | | |
|---------------------|-----|---------------|-------|---|----|---|----|-----------|--|-------|
| 1.6 16V T.SPARK | 88 | 01/01 → 03/10 | 1.598 | B | M | 4 | 16 | AR32104 | | 81331 |
| 1.6 16V T.SPARK ECO | 77 | 01/01 → 03/10 | 1.598 | B | M | 4 | 16 | AR37203 | | 81331 |
| 1.9 JTD | 74 | 06/03 → 03/10 | 1.910 | D | M | 4 | 8 | 182B9.000 | | 81352 |
| | 81 | 11/00 → 09/04 | 1.910 | D | M | 4 | 8 | AR37101 | | 81352 |
| | 85 | 04/01 → 03/10 | 1.910 | D | M | 4 | 8 | 937A2.000 | | 81352 |
| 1.9 JTD 16V | 93 | 09/03 → 09/04 | 1.910 | D | M | 4 | 16 | 937A4.000 | | 81872 |
| | 100 | 10/04 → 03/10 | 1.910 | D | M | 4 | 16 | 192B1.000 | | 81872 |
| | 103 | 11/02 → 03/10 | 1.910 | D | M | 4 | 16 | 192A5.000 | | 81872 |
| 1.9 JTDM | 85 | 10/04 → 03/10 | 1.910 | D | M | 4 | 8 | 939A7.000 | | 81352 |
| 1.9 JTDM 16V | 110 | 09/04 → 03/10 | 1.910 | D | M | 4 | 16 | 937A5.000 | | 81872 |
| | 125 | 06/08 → 03/10 | 1.910 | D | M | 4 | 16 | 937A6.000 | | 81872 |
| 1.9 JTDM 8V | 88 | 07/05 → 03/10 | 1.910 | D | M | 4 | 8 | 937A3.000 | | 81352 |
| 2.0 | 121 | 07/02 → 05/05 | 1.970 | B | M | 4 | 16 | 937A1.000 | | 81331 |
| 2.0 16V T.SPARK | 110 | 01/01 → 03/10 | 1.970 | B | AM | 4 | 16 | AR32310 | | 81331 |
| 3.2 GTA | 184 | 02/03 → 03/10 | 3.179 | B | M | 6 | 24 | 932A.000 | | 81355 |

155

| | | | | | | | | | | |
|--------------|-----|---------------|-------|---|---|---|----|---------|-----------|--------|
| 1.6 16V T.S. | 88 | 05/96 → 12/97 | 1.598 | B | M | 4 | 16 | AR67601 | 05-1996 → | 81348 |
| 1.7 T.S. | 83 | 04/93 → 04/96 | 1.748 | B | M | 4 | 8 | AR67103 | | 11708T |
| | 85 | 04/93 → 04/96 | 1.748 | B | M | 4 | 8 | AR67105 | | 11708T |
| 1.7 T.S. 16V | 103 | 05/96 → 12/97 | 1.747 | B | M | 4 | 16 | AR67106 | 05-1996 → | 81348 |

KW

cm³

NO. OF VALVES

ALFA ROMEO
155

| | | | | | | | | | | |
|------------------|-----|---------------|-------|---|---|---|----|------------------|---------------------------------|--------|
| 1.8 T.S. | 77 | 02/92 → 12/97 | 1.756 | B | M | 4 | 8 | AR67402 | 07-1993 →, → 04-1996 | 11708T |
| | 95 | 02/92 → 06/93 | 1.773 | B | M | 4 | 8 | AR67101 | 03-1992 →, → 06-1993 | 11708T |
| 1.8 T.S. Sport | 93 | 01/92 → 12/96 | 1.773 | B | M | 4 | 8 | AR67101, AR67102 | 07-1993 →, → 04-1996 | 11708T |
| 1.9 TD | 66 | 04/93 → 12/97 | 1.929 | D | M | 4 | 8 | AR67501 | (-)COP, 02-1996 →, → 12-1997 | 81363 |
| | 66 | 04/93 → 12/97 | 1.929 | D | M | 4 | 8 | AR67501 | (-)COP, 04-1993 →, → 02-1996 | 81326 |
| | 66 | 04/93 → 12/97 | 1.929 | D | M | 4 | 8 | AR67501 | (+)COP, 02-1996 →, → 12-1997 | 81347 |
| | 66 | 04/93 → 12/97 | 1.929 | D | M | 4 | 8 | AR67501 | (+)COP, 04-1993 →, → 02-1996 | 81464 |
| 2.0 16V Turbo Q4 | 140 | 01/92 → 12/97 | 1.995 | B | M | 4 | 16 | AR67203 | 07-1992 →, → 02-1996 | 81322 |
| | 137 | 01/92 → 12/97 | 1.995 | B | M | 4 | 16 | AR67203 | 07-1992 →, → 02-1996 | 81322 |
| 2.0 T.S. | 104 | 02/92 → 02/95 | 1.995 | B | M | 4 | 8 | AR67202 | | 11708T |
| | 106 | 02/92 → 04/93 | 1.995 | B | M | 4 | 8 | AR67201 | | 11708T |
| 2.0 T.S. 16V | 110 | 03/95 → 12/97 | 1.970 | B | M | 4 | 16 | AR67204, AR67299 | | 81331 |
| 2.5 TD | 92 | 04/93 → 12/97 | 2.499 | D | M | 4 | 8 | VM07B, VM31B | 04-1993 → | 81302 |

156, Sportwagon

| | | | | | | | | | | |
|-----------------|-----|---------------|-------|---|---|---|----|---------------------------------------|-------------------------|-------|
| 1.6 16V T.SPARK | 82 | 09/97 → 09/05 | 1.598 | B | M | 4 | 16 | AR32102 | | 81348 |
| | 88 | 09/97 → 09/05 | 1.598 | B | M | 4 | 16 | AR32102, AR32103, AR32104, AR67601 | 05-2000 → | 81331 |
| | 88 | 09/97 → 09/05 | 1.598 | B | M | 4 | 16 | AR32102, AR32103, AR32104, AR67601 | 11-1997 →, → 04-2000 | 81348 |
| | 88 | 05/00 → 05/06 | 1.598 | B | M | 4 | 16 | AR32102, AR32103, AR32104, AR67601 | | 81331 |
| 1.8 16V T.SPARK | 103 | 10/00 → 09/05 | 1.747 | B | M | 4 | 16 | AR32205 | | 81348 |
| | 106 | 09/97 → 10/00 | 1.747 | B | M | 4 | 16 | AR32201 | | 81348 |
| | 106 | 05/00 → 10/00 | 1.747 | B | M | 4 | 16 | AR32201 | | 81331 |
| 1.9 JTD | 93 | 11/03 → 09/05 | 1.910 | D | M | 4 | 16 | 937A4.000 | | 81872 |
| | 100 | 11/02 → 11/04 | 1.910 | D | M | 4 | 16 | 192B1.000 | | 81872 |
| | 110 | 07/04 → 09/05 | 1.910 | D | M | 4 | 16 | 937A5.000 | | 81872 |
| | 77 | 09/97 → 10/00 | 1.910 | D | M | 4 | 8 | AR32302 | | 81352 |
| | 81 | 10/00 → 05/01 | 1.910 | D | M | 4 | 8 | AR37101 | | 81352 |
| | 85 | 05/01 → 09/05 | 1.910 | D | M | 4 | 8 | 937A2.000 | | 81352 |
| 1.9 JTD 16V | 103 | 11/02 → 09/05 | 1.910 | D | M | 4 | 16 | 192A5.000 | | 81872 |
| 1.9 JTD 16V Q4 | 110 | 07/04 → 05/06 | 1.910 | D | M | 4 | 16 | 937A5.000 | | 81872 |
| 2.0 16V T.SPARK | 110 | 10/00 → 03/02 | 1.970 | B | M | 4 | 16 | AR32310 | | 81331 |
| | 114 | 09/97 → 10/00 | 1.970 | B | M | 4 | 16 | AR32301 | 11-1997 → | 81331 |
| | 114 | 05/00 → 06/02 | 1.970 | B | M | 4 | 16 | AR32301 | | 81331 |

| | | | | | | | | | | | |
|--|--|-----------|--|-----------------------|--|--|--|----------------------|--|--|------------------------|
| | | KW | | cm³ | | | | NO. OF VALVES | | | MAGNETI MARELLI |
|--|--|-----------|--|-----------------------|--|--|--|----------------------|--|--|------------------------|

ALFA ROMEO

156, Sportwagon

| | | | | | | | | | | |
|------------|-----|---------------|-------|---|---|---|----|--------------------|-----------|-------|
| 2.0 JTS | 119 | 11/97 → 09/05 | 1.970 | B | M | 4 | 16 | 932A2.000 | | 81331 |
| | 122 | 03/02 → 09/05 | 1.970 | B | M | 4 | 16 | 937A1.000 | | 81331 |
| 2.4 JTD | 120 | 06/03 → 09/05 | 2.387 | D | M | 5 | 20 | 841M.000, 841N.000 | | 81872 |
| | 129 | 10/03 → 09/05 | 2.387 | D | M | 5 | 20 | 841G.000 | | 81872 |
| | 100 | 09/97 → 09/03 | 2.387 | D | M | 5 | 10 | AR32501 | | 81352 |
| | 103 | 10/00 → 09/05 | 2.387 | D | M | 5 | 10 | 839A6.000 | | 81352 |
| | 110 | 03/02 → 09/05 | 2.387 | D | M | 5 | 10 | 841C000 | | 81352 |
| 2.5 V6 24V | 140 | 05/00 → 08/03 | 2.492 | B | M | 6 | 24 | AR32401 | | 81355 |
| | 140 | 09/97 → 12/01 | 2.492 | B | M | 6 | 24 | AR32401, AR32402 | 11-1997 → | 81355 |
| | 141 | 10/00 → 09/05 | 2.492 | B | M | 6 | 24 | AR32405 | | 81355 |
| 3.2 GTA | 184 | 03/02 → 09/05 | 3.179 | B | M | 6 | 24 | 932A.000 | | 81355 |

159, Sportwagon

| | | | | | | | | | | |
|--------------|-----|---------------|-------|---|---|---|----|----------------------|--|-------|
| 1.8 MPI | 103 | 03/07 → 11/11 | 1.796 | B | M | 4 | 16 | 939A4.000 | | 82083 |
| 1.8 TBi | 147 | 05/09 → 11/11 | 1.742 | B | M | 4 | 16 | 939B1.000 | | 81331 |
| 1.9 JTDM 16V | 100 | 03/06 → 11/11 | 1.910 | D | M | 4 | 16 | 937A8.000 | | 81872 |
| | 100 | 09/05 → 11/11 | 1.910 | D | M | 4 | 16 | 937A8.000, 939A8.000 | | 81872 |
| | 110 | 09/05 → 11/11 | 1.910 | D | M | 4 | 16 | 939A2.000 | | 81872 |
| 1.9 JTDM 8V | 85 | 03/06 → 11/11 | 1.910 | D | M | 4 | 8 | 937A7.000 | | 81352 |
| | 85 | 09/05 → 11/11 | 1.910 | D | M | 4 | 8 | 937A7.000, 939A7.000 | | 81352 |
| | 88 | 09/05 → 11/11 | 1.910 | D | M | 4 | 8 | 939A1.000 | | 81352 |
| 1.9 JTS | 118 | 09/05 → 11/11 | 1.859 | B | M | 4 | 16 | 939A6.000 | | 81812 |
| 2.0 JTDM | 100 | 06/10 → 11/11 | 1.956 | D | M | 4 | 16 | 939B4.000 | | 81872 |
| | 120 | 05/09 → 11/11 | 1.956 | D | M | 4 | 16 | 844A2.000 | | 81872 |
| | 125 | 05/09 → 11/11 | 1.956 | D | M | 4 | 16 | 939B3.000 | | 81872 |
| 2.2 JTS | 136 | 09/05 → 11/11 | 2.198 | B | M | 4 | 16 | 939A5.000 | | 81812 |
| 2.4 JTDM | 147 | 09/05 → 11/11 | 2.387 | D | M | 5 | 20 | 939A3.000 | | 81872 |
| | 154 | 05/07 → 11/11 | 2.387 | D | M | 5 | 20 | 939A9.000 | | 81872 |
| 2.4 JTDM Q4 | 154 | 05/07 → 11/11 | 2.387 | D | M | 5 | 20 | 939A9.000 | | 81872 |
| 3.2 JTS | 191 | 02/08 → 11/11 | 3.195 | B | M | 6 | 24 | 939A.000 | | 84057 |
| 3.2 JTS Q4 | 191 | 12/05 → 11/11 | 3.195 | B | M | 6 | 24 | 939A.000 | | 84057 |

164

| | | | | | | | | | | |
|--------------|-----|---------------|-------|---|---|---|----|------------------------------------|-----------|---------|
| 2.0 T.S. | 106 | 09/92 → 09/98 | 1.995 | B | M | 4 | 8 | AR64103 | | 11708T |
| 2.0 Turbo | 128 | 10/87 → 09/98 | 1.995 | B | M | 4 | 8 | AR06476 | | 81443 |
| | 129 | 02/88 → 10/92 | 1.995 | B | M | 4 | 8 | AR06476 | | 81443 |
| 2.0 V6 Turbo | 148 | 09/92 → 09/98 | 1.996 | B | M | 6 | 12 | AR64102 | | 19532/E |
| | 150 | 03/91 → 09/92 | 1.996 | B | M | 6 | 12 | AR64101 | | 19532/E |
| 2.5 TD | 84 | 06/87 → 09/92 | 2.499 | D | M | 4 | 8 | VM84A | 10-1989 → | 81302 |
| | 92 | 09/92 → 09/98 | 2.499 | D | M | 4 | 8 | VM08B, VM32B | (-)COP | 81362 |
| 2.5 V6 | 120 | 09/92 → 09/98 | 2.492 | B | M | 6 | 12 | AR66201 | | 19532/E |
| 3.0 i.e. QV | 147 | 09/90 → 09/92 | 2.959 | B | M | 6 | 12 | AR06430, AR64301 | | 19532/E |
| 3.0 V6 | 132 | 09/92 → 09/98 | 2.959 | B | M | 6 | 12 | AR64303, AR64305, AR64399, AR66303 | | 19532/E |
| | 135 | 06/87 → 09/92 | 2.959 | B | M | 6 | 12 | AR06412 | | 19532/E |
| | 141 | 06/87 → 09/92 | 2.959 | B | M | 6 | 12 | AR06410 | | 19532/E |

KW

cm³

NO. OF VALVES

ALFA ROMEO

| 166 | | | | | | | | | | |
|-------------|-----|---------------|-------|---|----|---|----|--------------------|------------------|-------|
| 2.0 T.Spark | 110 | 10/00 → 06/07 | 1.970 | B | M | 4 | 16 | AR36301 | | 81331 |
| | 114 | 09/98 → 10/00 | 1.970 | B | M | 4 | 16 | AR34103 | | 81331 |
| 2.0 V6 | 151 | 09/98 → 10/00 | 1.996 | B | M | 6 | 12 | AR34102 | | 81355 |
| 2.4 JTD | 110 | 04/02 → 06/07 | 2.387 | D | M | 5 | 10 | 841C000 | | 81352 |
| | 120 | 10/03 → 06/07 | 2.387 | D | M | 5 | 20 | 841M.000, 841N.000 | | 81872 |
| | 129 | 10/03 → 06/07 | 2.387 | D | M | 5 | 20 | 841G.000, 841H.000 | | 81872 |
| | 132 | 07/06 → 06/07 | 2.387 | D | M | 5 | 20 | 841M.000 | | 81872 |
| | 136 | 07/05 → 06/07 | 2.387 | D | M | 5 | 20 | 841M.000, 936B.000 | | 81872 |
| | 100 | 09/98 → 10/00 | 2.387 | D | M | 5 | 10 | AR34202 | | 81352 |
| | 103 | 10/00 → 06/07 | 2.387 | D | M | 5 | 10 | 839A6.000 | | 81352 |
| 2.5 V6 24V | 138 | 10/00 → 06/07 | 2.492 | B | M | 6 | 24 | AR36201 | | 81355 |
| | 140 | 09/98 → 10/00 | 2.492 | B | M | 6 | 24 | AR34201 | | 81355 |
| 3.0 V6 24V | 162 | 10/00 → 06/07 | 2.959 | B | AM | 6 | 24 | AR36101 | | 81355 |
| | 166 | 09/98 → 10/00 | 2.959 | B | M | 6 | 24 | AR34301, AR34302 | | 81355 |
| 3.2 V6 24V | 176 | 10/03 → 06/07 | 3.179 | B | M | 6 | 24 | 936A.000 | M: AR34301/36101 | 81355 |

| Brera | | | | | | | | | | |
|--------------|-----|---------------|-------|---|---|---|----|-----------|--|------------------|
| 1.8 TBi | 147 | 05/09 → 06/10 | 1.742 | B | M | 4 | 16 | 939B1.000 | | 81331 |
| 2.0 JTDM | 120 | 03/08 → 06/10 | 1.956 | D | M | 4 | 16 | 844A2.000 | | 81872 |
| | 125 | 05/09 → 06/10 | 1.956 | D | M | 4 | 16 | 939B3.000 | | 81872 |
| 2.2 JTS | 136 | 01/06 → 06/10 | 2.198 | B | M | 4 | 16 | 939A5.000 | | 81812 |
| 2.4 JTDM 20V | 147 | 01/06 → 06/10 | 2.387 | D | M | 5 | 20 | 939A3.000 | | 81872 |
| | 154 | 05/07 → 06/10 | 2.387 | D | M | 5 | 20 | 939A9.000 | | 81872 |
| 3.2 JTS | 191 | 03/08 → 06/10 | 3.195 | B | M | 6 | 24 | 939A.000 | | 84057 NEW |
| 3.2 JTS Q4 | 191 | 01/06 → 06/10 | 3.195 | B | M | 6 | 24 | 939A.000 | | 84057 NEW |

| Giulietta III | | | | | | | | | | |
|----------------------|----------|---------|---------|-------|---|---|----|----------------------|-----------|-------|
| 1.4 BiFuel | 88 | 12/11 → | 1.368 | BF | M | 4 | 16 | 198A4.000 | TESMA | 82070 |
| 1.4 TB | 77 | 04/11 → | 1.368 | B | M | 4 | 16 | 940B1.000, 940B8.000 | TESMA | 82070 |
| | 85 | 04/10 → | 1.368 | B | M | 4 | 16 | 940A6.000 | TESMA | 82070 |
| | 88 | 04/10 → | 1.368 | B | M | 4 | 16 | 198A4.000, 940B7.000 | TESMA | 82070 |
| | 110 | 09/14 → | 1.368 | B | M | 4 | 16 | 940A2.000 | TESMA | 82070 |
| | 120 | 04/10 → | 1.368 | B | M | 4 | 16 | 955A8.000 | TESMA | 82070 |
| | 125 | 04/10 → | 1.368 | B | M | 4 | 16 | 940A2.000 | TESMA | 82070 |
| | 1.6 JTDM | 77 | 04/10 → | 1.598 | D | M | 4 | 16 | 940A3.000 | |
| 1.8 TBi | 173 | 04/10 → | 1.742 | B | M | 4 | 16 | 940A1.000 | | 81331 |
| | 177 | 09/13 → | 1.742 | B | M | 4 | 16 | 960A1.000 | | 81331 |
| 2.0 JTDM | 100 | 04/10 → | 1.956 | D | M | 4 | 16 | 940A8.000, 940B6.000 | | 81872 |
| | 103 | 04/10 → | 1.956 | D | M | 4 | 16 | 940A5.000 | | 81872 |
| | 110 | 08/13 → | 1.956 | D | M | 4 | 16 | 940B5.000 | | 81872 |
| | 120 | 04/10 → | 1.956 | D | M | 4 | 16 | 940A7.000 | | 81872 |
| | 125 | 04/10 → | 1.956 | D | M | 4 | 16 | 940A4.000 | | 81872 |
| 2.0 JTDM | 129 | 11/13 → | 1.956 | D | M | 4 | 16 | 940B4.000 | | 81872 |

| | | | | | | | | | | | |
|--|--|-----------|--|-----------------------|--|--|--|----------------------|--|--|------------------------|
| | | KW | | cm³ | | | | NO. OF VALVES | | | MAGNETI MARELLI |
|--|--|-----------|--|-----------------------|--|--|--|----------------------|--|--|------------------------|

ALFA ROMEO

GT II

| | | | | | | | | | | |
|---------|-----|---------------|-------|---|---|---|----|----------------------|--|-------|
| 1.8 TS | 103 | 11/03 → 09/10 | 1.747 | B | M | 4 | 16 | AR32205 | | 81348 |
| 1.9 JTD | 110 | 11/03 → 09/10 | 1.910 | D | M | 4 | 16 | 937A5.000 | | 81872 |
| | 125 | 05/08 → 09/10 | 1.910 | D | M | 4 | 16 | 937A6.000 | | 81872 |
| 2.0 JTS | 119 | 12/06 → 09/10 | 1.970 | B | M | 4 | 16 | 932A2.000 | | 81331 |
| | 121 | 11/03 → 09/10 | 1.970 | B | M | 4 | 16 | 932A2.000, 937A1.000 | | 81331 |
| 3.2 GTA | 176 | 11/03 → 09/10 | 3.179 | B | M | 6 | 24 | 936A.000 | | 81355 |

GTV II

| | | | | | | | | | | |
|-----------------|-----|---------------|-------|---|---|---|----|------------------|------------|-------|
| 1.8 16V | 106 | 05/98 → 10/05 | 1.747 | B | M | 4 | 16 | AR32201 | | 81331 |
| 2.0 JTS | 121 | 04/03 → 10/05 | 1.970 | B | M | 4 | 16 | 937A1.000 | | 81331 |
| 2.0 T.SPARK 16V | 110 | 06/95 → 10/05 | 1.970 | B | M | 4 | 16 | AR16201, AR32310 | | 81331 |
| | 114 | 05/98 → 08/00 | 1.970 | B | M | 4 | 16 | AR32301 | | 81331 |
| 3.0 V6 24V | 162 | 10/96 → 10/00 | 2.959 | B | M | 6 | 24 | AR16102 | | 81355 |
| 3.2 V6 24V | 176 | 04/03 → 10/05 | 3.179 | B | M | 6 | 24 | 936A6.000 | M: AR16102 | 81355 |

Mito

| | | | | | | | | | | |
|--------------------|-----|---------|-------|----|---|---|----|----------------------|----------|-------|
| 0.9 | 74 | 12/13 → | 875 | B | M | 2 | 8 | 199B6.000 | | 84008 |
| 0.9 TwinAir | 63 | 07/11 → | 875 | B | M | 2 | 8 | 312A2.000 | | 84008 |
| | 77 | 04/13 → | 875 | B | M | 2 | 8 | 199B6.000 | | 84008 |
| 1.3 MultiJet | 59 | 12/13 → | 1.248 | D | M | 4 | 16 | 199B8.000 | | 81862 |
| | 62 | 01/11 → | 1.248 | D | M | 4 | 16 | 199B4.000 | | 81862 |
| | 66 | 09/08 → | 1.248 | D | M | 4 | 16 | 199A3.000 | | 81862 |
| | 70 | 10/09 → | 1.248 | D | M | 4 | 16 | 199B1.000 | | 81862 |
| | 70 | 09/08 → | 1.248 | D | M | 4 | 16 | 199B1.000 | | 81862 |
| 1.414 | 51 | 05/11 → | 1.368 | B | M | 4 | 8 | 955A9.000 | TESMA | 82070 |
| | 57 | 03/11 → | 1.368 | B | M | 4 | 8 | 350A1.000 | TESMA | 82070 |
| | 57 | 03/11 → | 1.368 | B | M | 4 | 16 | 955A1.000 | TESMA | 82070 |
| | 58 | 09/08 → | 1.368 | B | M | 4 | 16 | 955A1.000 | PIERBURG | 81369 |
| | 58 | 09/08 → | 1.368 | B | M | 4 | 16 | 955A1.000 | TESMA | 82070 |
| | 70 | 09/08 → | 1.368 | B | M | 4 | 16 | 199A6.000 | PIERBURG | 81369 |
| | 70 | 09/08 → | 1.368 | B | M | 4 | 16 | 199A6.000 | TESMA | 82070 |
| 1.4 Bifuel | 88 | 07/11 → | 1.368 | BF | M | 4 | 16 | 198A4.000 | TESMA | 82070 |
| 1.4 MultiAir | 77 | 08/10 → | 1.368 | B | M | 4 | 16 | 955A6.000 | TESMA | 82070 |
| 1.4 TB | 103 | 12/13 → | 1.368 | B | M | 4 | 16 | 955B1.000 | TESMA | 82070 |
| 1.4 TJet | 88 | 09/08 → | 1.368 | B | M | 4 | 16 | 198A4.000 | PIERBURG | 81369 |
| | 88 | 09/08 → | 1.368 | B | M | 4 | 16 | 198A4.000 | TESMA | 82070 |
| | 110 | 09/08 → | 1.368 | B | M | 4 | 16 | 198A1.000 | TESMA | 82070 |
| | 114 | 09/08 → | 1.368 | B | M | 4 | 16 | 199A8.000 | TESMA | 82070 |
| 1.4 Turbo MultiAir | 99 | 10/09 → | 1.368 | B | M | 4 | 16 | 955A2.000, 955A7.000 | TESMA | 82070 |
| | 120 | 10/09 → | 1.368 | B | M | 4 | 16 | 955A8.000 | TESMA | 82070 |
| | 125 | 10/09 → | 1.368 | B | M | 4 | 16 | 940A2.000 | TESMA | 82070 |
| 1.6 JTDM | 85 | 09/08 → | 1.598 | D | M | 4 | 16 | 955A4.000 | | 81872 |
| | 88 | 09/08 → | 1.598 | D | M | 4 | 16 | 198A2.000, 955A3.000 | | 81872 |

KW

cm³

NO. OF VALVES

ALFA ROMEO

Spider III

| | | | | | | | | | | |
|-------------|----|---------------|-------|---|---|---|---|------------------|-------------------------|--------|
| 1600 | 76 | 03/76 → 12/90 | 1.570 | B | M | 4 | 8 | AR00526 | → 12-1985 | 11701T |
| | 76 | 03/76 → 12/90 | 1.570 | B | M | 4 | 8 | AR00526 | 01-1989 → | 11701T |
| | 79 | 01/90 → 12/93 | 1.570 | B | M | 4 | 8 | AR01563 | | 11701T |
| 2000 | 85 | 08/86 → 12/90 | 1.962 | B | M | 4 | 8 | AR01544 | 01-1989 → | 11701T |
| | 88 | 01/90 → 12/93 | 1.962 | B | M | 4 | 8 | AR01588 | | 11701T |
| | 92 | 08/86 → 12/90 | 1.962 | B | M | 4 | 8 | AR00515 | 01-1989 → | 11701T |
| 2000 Veloce | 93 | 01/77 → 12/93 | 1.962 | B | M | 4 | 8 | AR00515, AR01590 | 01-1978 →, → 12-1985 | 11701T |
| | 93 | 01/77 → 12/93 | 1.962 | B | M | 4 | 8 | AR00515, AR01590 | 01-1989 → | 11701T |

Spider IV

| | | | | | | | | | | |
|-----------------|-----|---------------|-------|---|---|---|----|------------------|--|-------|
| 1.8 16V | 106 | 05/98 → 04/05 | 1.747 | B | M | 4 | 16 | AR32201 | | 81331 |
| 2.0 JTS | 121 | 04/03 → 04/05 | 1.970 | B | M | 4 | 16 | 937A1.000 | | 81331 |
| 2.0 T.SPARK 16V | 110 | 06/95 → 04/05 | 1.970 | B | M | 4 | 16 | AR16201, AR32310 | | 81331 |
| | 114 | 05/98 → 08/00 | 1.970 | B | M | 4 | 16 | AR32301 | | 81331 |
| 3.0 V6 24V | 162 | 01/99 → 10/03 | 2.959 | B | M | 6 | 24 | AR16102 | | 81355 |
| 3.2 V6 24V | 176 | 04/03 → 04/05 | 3.179 | B | M | 6 | 24 | 936A6.000 | | 81355 |

Spider V

| | | | | | | | | | | |
|------------|-----|---------------|-------|---|---|---|----|-----------|--|-------|
| 1.8 TBi | 147 | 05/09 → 06/10 | 1.742 | B | M | 4 | 16 | 939B1.000 | | 81331 |
| 2.0 JTDM | 120 | 04/09 → 06/10 | 1.956 | D | M | 4 | 16 | 844A2.000 | | 81872 |
| | 125 | 05/09 → 06/10 | 1.956 | D | M | 4 | 16 | 939B3.000 | | 81872 |
| 2.2 JTS | 136 | 03/06 → 06/10 | 2.198 | B | M | 4 | 16 | 939A5.000 | | 81812 |
| 2.4 JTDM | 147 | 04/07 → 06/10 | 2.387 | D | M | 5 | 20 | 939A3.000 | | 81872 |
| | 154 | 03/08 → 06/10 | 2.387 | D | M | 5 | 20 | 939A3.000 | | 81872 |
| 3.2 JTS | 191 | 03/08 → 06/10 | 3.195 | B | M | 6 | 24 | 939A.000 | | 84057 |
| 3.2 JTS Q4 | 191 | 03/06 → 06/10 | 3.195 | B | M | 6 | 24 | 939A.000 | | 84057 |

AUDI

80 IV

| | | | | | | | | | | |
|---------------|----|---------------|-------|---|---|---|---|--------|--------|-------|
| 1.6 | 51 | 08/87 → 09/91 | 1.595 | B | M | 4 | 8 | PP | (-)COP | 81522 |
| | 51 | 08/87 → 09/91 | 1.595 | B | M | 4 | 8 | PP | (+)COP | 82080 |
| | 55 | 09/86 → 08/91 | 1.595 | B | M | 4 | 8 | RN | (-)COP | 81522 |
| | 55 | 09/86 → 08/91 | 1.595 | B | M | 4 | 8 | RN | (+)COP | 82080 |
| | 75 | 08/90 → 10/91 | 1.595 | B | M | 4 | 8 | ABB | (-)COP | 81522 |
| | 75 | 08/90 → 10/91 | 1.595 | B | M | 4 | 8 | ABB | (+)COP | 82080 |
| 1.6 TD | 59 | 09/86 → 08/91 | 1.588 | D | M | 4 | 8 | RA, SB | (-)COP | 81522 |
| | 59 | 09/86 → 08/91 | 1.588 | D | M | 4 | 8 | RA, SB | (+)COP | 82080 |
| 1.8 | 55 | 10/86 → 01/90 | 1.781 | B | M | 4 | 8 | RU | (-)COP | 81522 |
| | 55 | 10/86 → 01/90 | 1.781 | B | M | 4 | 8 | RU | (+)COP | 82080 |
| 1.8 E | 82 | 06/86 → 08/91 | 1.781 | B | M | 4 | 8 | DZ | (-)COP | 81522 |
| | 82 | 06/86 → 08/91 | 1.781 | B | M | 4 | 8 | DZ | (+)COP | 82080 |
| 1.8 E quattro | 82 | 09/86 → 08/91 | 1.781 | B | M | 4 | 8 | DZ | (-)COP | 81522 |
| | 82 | 09/86 → 08/91 | 1.781 | B | M | 4 | 8 | DZ | (+)COP | 82080 |
| 1.8 quattro | 83 | 09/86 → 08/90 | 1.847 | B | M | 4 | 8 | SD | (-)COP | 81522 |
| | 83 | 09/86 → 08/90 | 1.847 | B | M | 4 | 8 | SD | (+)COP | 82080 |

KW

cm³

NO. OF VALVES

MAGNETI MARELLI
AUDI
80 IV

| | | | | | | | | | | |
|-------------------|-----|---------------|-------|---|---|---|----|------------|--------|-------|
| 1.8 S | 65 | 08/86 → 01/90 | 1.781 | B | M | 4 | 8 | SF | (-)COP | 81522 |
| | 65 | 08/86 → 01/90 | 1.781 | B | M | 4 | 8 | SF | (+)COP | 82080 |
| | 66 | 09/86 → 10/91 | 1.781 | B | M | 4 | 8 | JN, NE, PM | (-)COP | 81522 |
| | 66 | 09/86 → 10/91 | 1.781 | B | M | 4 | 8 | JN, NE, PM | (+)COP | 82080 |
| 1.8 S quattro | 65 | 09/86 → 07/90 | 1.781 | B | M | 4 | 8 | SF | (-)COP | 81522 |
| | 65 | 09/86 → 07/90 | 1.781 | B | M | 4 | 8 | SF | (+)COP | 82080 |
| | 66 | 09/86 → 09/91 | 1.781 | B | M | 4 | 8 | JN, NE, PM | (-)COP | 81522 |
| | 66 | 09/86 → 09/91 | 1.781 | B | M | 4 | 8 | JN, NE, PM | (+)COP | 82080 |
| 1.9 D | 50 | 08/89 → 08/91 | 1.896 | D | M | 4 | 8 | 1Y | (-)COP | 81522 |
| | 50 | 08/89 → 08/91 | 1.896 | D | M | 4 | 8 | 1Y | (+)COP | 82080 |
| 2.0 | 82 | 10/90 → 08/91 | 1.984 | B | M | 4 | 8 | AAD | (-)COP | 81522 |
| | 82 | 10/90 → 08/91 | 1.984 | B | M | 4 | 8 | AAD | (+)COP | 82080 |
| 2.0 E | 83 | 08/88 → 10/90 | 1.984 | B | M | 4 | 8 | 3A | (-)COP | 81522 |
| | 83 | 08/88 → 10/90 | 1.984 | B | M | 4 | 8 | 3A | (+)COP | 82080 |
| 2.0 E 16V | 101 | 03/90 → 09/91 | 1.984 | B | M | 4 | 16 | 6A | (-)COP | 81522 |
| | 101 | 03/90 → 09/91 | 1.984 | B | M | 4 | 16 | 6A | (+)COP | 82080 |
| 2.0 E 16V quattro | 101 | 03/90 → 08/91 | 1.984 | B | M | 4 | 16 | 6A | (-)COP | 81522 |
| | 101 | 03/90 → 08/91 | 1.984 | B | M | 4 | 16 | 6A | (+)COP | 82080 |
| 2.0 E quattro | 83 | 08/88 → 09/90 | 1.984 | B | M | 4 | 8 | 3A | (-)COP | 81522 |
| | 83 | 08/88 → 09/90 | 1.984 | B | M | 4 | 8 | 3A | (+)COP | 82080 |
| 2.0 quattro | 82 | 08/88 → 07/90 | 1.984 | B | M | 4 | 8 | 3A | (-)COP | 81522 |
| | 82 | 08/88 → 07/90 | 1.984 | B | M | 4 | 8 | 3A | (+)COP | 82080 |
| | 85 | 10/90 → 08/91 | 1.984 | B | M | 4 | 8 | AAD | (-)COP | 81522 |
| | 85 | 10/90 → 08/91 | 1.984 | B | M | 4 | 8 | AAD | (+)COP | 82080 |

80 V, Avant

| | | | | | | | | | | |
|-------------------|-----|---------------|-------|---|---|---|----|-----|--------|-------|
| 1.6 | 52 | 09/91 → 12/94 | 1.595 | B | M | 4 | 8 | ABM | (-)COP | 81522 |
| | 52 | 09/91 → 12/94 | 1.595 | B | M | 4 | 8 | ABM | (+)COP | 82080 |
| 1.6 E | 74 | 06/93 → 12/94 | 1.595 | B | M | 4 | 8 | ADA | (-)COP | 81522 |
| | 74 | 06/93 → 12/94 | 1.595 | B | M | 4 | 8 | ADA | (+)COP | 82080 |
| 1.9 TD | 55 | 09/91 → 12/94 | 1.896 | D | M | 4 | 8 | AAZ | (-)COP | 81522 |
| | 55 | 09/91 → 12/94 | 1.896 | D | M | 4 | 8 | AAZ | (+)COP | 82080 |
| 1.9 TDI | 66 | 09/91 → 12/94 | 1.896 | D | M | 4 | 8 | 1Z | (-)COP | 81522 |
| | 66 | 09/91 → 12/94 | 1.896 | D | M | 4 | 8 | 1Z | (+)COP | 82080 |
| 2.0 | 66 | 09/91 → 12/94 | 1.984 | B | M | 4 | 8 | ABT | (-)COP | 81522 |
| | 66 | 09/91 → 12/94 | 1.984 | B | M | 4 | 8 | ABT | (+)COP | 82080 |
| 2.0 E | 85 | 09/91 → 12/94 | 1.984 | B | M | 4 | 8 | ABK | (-)COP | 81522 |
| | 85 | 09/91 → 12/94 | 1.984 | B | M | 4 | 8 | ABK | (+)COP | 82080 |
| 2.0 E 16V | 103 | 08/92 → 12/94 | 1.984 | B | M | 4 | 16 | ACE | (-)COP | 81522 |
| | 103 | 08/92 → 12/94 | 1.984 | B | M | 4 | 16 | ACE | (+)COP | 82080 |
| 2.0 E 16V quattro | 103 | 04/92 → 12/94 | 1.984 | B | M | 4 | 16 | ACE | (-)COP | 81522 |
| | 103 | 04/92 → 12/94 | 1.984 | B | M | 4 | 16 | ACE | (+)COP | 82080 |
| 2.0 E quattro | 85 | 09/91 → 12/94 | 1.984 | B | M | 4 | 8 | ABK | (-)COP | 81522 |
| | 85 | 09/91 → 12/94 | 1.984 | B | M | 4 | 8 | ABK | (+)COP | 82080 |

KW

cm³

NO. OF VALVES

AUDI
80 V, Avant

| | | | | | | | | | | |
|---------------|-----|---------------|-------|---|---|---|----|-----|--------|-------|
| 2.0 quattro | 79 | 11/93 → 01/96 | 1.984 | B | M | 4 | 8 | ADW | (-)COP | 81522 |
| | 79 | 11/93 → 01/96 | 1.984 | B | M | 4 | 8 | ADW | (+)COP | 82080 |
| 2.3 E | 98 | 09/91 → 12/94 | 2.309 | B | M | 5 | 10 | NG | | 81700 |
| 2.3 E quattro | 98 | 09/91 → 12/94 | 2.309 | B | M | 5 | 10 | NG | | 81700 |
| RS2 quattro | 232 | 03/94 → 05/95 | 2.226 | B | M | 5 | 20 | ADU | | 81700 |
| S2 quattro | 169 | 02/93 → 12/94 | 2.226 | B | M | 5 | 20 | ABY | | 81700 |

90 II

| | | | | | | | | | | |
|-------------------|-----|---------------|-------|---|---|---|----|--------|--------------------|-------|
| 1.6 TD | 59 | 04/87 → 09/91 | 1.588 | D | M | 4 | 8 | RA, SB | (-)COP | 81522 |
| | 59 | 04/87 → 09/91 | 1.588 | D | M | 4 | 8 | RA, SB | (+)COP | 82080 |
| 2.0 | 85 | 07/88 → 09/91 | 1.994 | B | M | 5 | 10 | PS | T →: F89-J-394.743 | 81683 |
| 2.0 20 V | 118 | 08/89 → 07/91 | 1.994 | B | M | 5 | 20 | NM | | 81683 |
| 2.0 20 V quattro | 118 | 08/88 → 09/91 | 1.994 | B | M | 5 | 20 | NM | | 81683 |
| 2.0 quattro | 101 | 08/89 → 07/90 | 1.984 | B | M | 4 | 16 | 6A | (-)COP | 81522 |
| | 101 | 08/89 → 07/90 | 1.984 | B | M | 4 | 16 | 6A | (+)COP | 82080 |
| 2.2 E | 100 | 04/87 → 07/91 | 2.226 | B | M | 5 | 10 | KV | T →: F89-J-394.743 | 81683 |
| 2.2 E quattro | 100 | 04/87 → 09/91 | 2.226 | B | M | 5 | 10 | KV | T →: F89-J-394.743 | 81683 |
| 2.3 E | 98 | 04/87 → 09/91 | 2.309 | B | M | 5 | 10 | NG | T →: F89-J-394.743 | 81683 |
| | 100 | 04/87 → 07/91 | 2.309 | B | M | 5 | 10 | NG | T →: F89-J-394.743 | 81683 |
| 2.3 E 20V | 123 | 04/90 → 07/91 | 2.309 | B | M | 5 | 20 | 7A | | 81683 |
| | 125 | 08/88 → 07/91 | 2.309 | B | M | 5 | 20 | 7A | | 81683 |
| 2.3 E 20V quattro | 123 | 04/90 → 09/91 | 2.309 | B | M | 5 | 20 | 7A | | 81683 |
| | 125 | 06/88 → 09/91 | 2.309 | B | M | 5 | 20 | 7A | | 81683 |
| 2.3 E quattro | 98 | 04/87 → 09/91 | 2.309 | B | M | 5 | 10 | NG | T →: F89-J-394.743 | 81683 |
| | 100 | 04/87 → 07/91 | 2.309 | B | M | 5 | 10 | NG | T →: F89-J-394.743 | 81683 |

100 III, Avant

| | | | | | | | | | | |
|---------------------|-----|---------------|-------|---|---|---|----|--------|--------------------------------|-------|
| 1.8 | 65 | 02/86 → 07/90 | 1.781 | B | M | 4 | 8 | SH | (-)COP | 81522 |
| | 65 | 02/86 → 07/90 | 1.781 | B | M | 4 | 8 | SH | (+)COP | 82080 |
| 1.8 Cat. | 66 | 03/85 → 11/90 | 1.781 | B | M | 4 | 8 | 4B, PH | (-)COP | 81522 |
| | 66 | 03/85 → 11/90 | 1.781 | B | M | 4 | 8 | 4B, PH | (+)COP | 82080 |
| 1.8 quattro | 65 | 08/86 → 07/90 | 1.781 | B | M | 4 | 8 | SH | (-)COP | 81522 |
| | 65 | 08/86 → 07/90 | 1.781 | B | M | 4 | 8 | SH | (+)COP | 82080 |
| 1.8 quattro Cat. | 66 | 08/85 → 11/90 | 1.781 | B | M | 4 | 8 | 4B, PH | (-)COP | 81522 |
| | 66 | 08/85 → 11/90 | 1.781 | B | M | 4 | 8 | 4B, PH | (+)COP | 82080 |
| 2.0 Cat. | 85 | 01/88 → 11/90 | 1.994 | B | M | 5 | 10 | RT | M →: 010.236 | 81683 |
| 2.0 D | 51 | 03/83 → 11/90 | 1.986 | D | M | 5 | 10 | CN | → 05-1990, → T: F-L-100.000 | 81593 |
| 2.0 D Turbo | 74 | 03/88 → 11/90 | 1.986 | D | M | 5 | 10 | NC | → 05-1990, → T: F-L-100.000 | 81593 |
| 2.0 E Cat. | 85 | 01/88 → 11/90 | 1.994 | B | M | 5 | 10 | RT | M →: 010.236 | 81683 |
| 2.0 TD | 74 | 03/88 → 11/90 | 1.986 | D | M | 5 | 10 | NC | → 05-1990, → T: F-L-100.000 | 81593 |
| 2.2 Cat. | 101 | 06/89 → 11/90 | 2.226 | B | M | 5 | 10 | HX, KU | | 81683 |
| 2.2 E Turbo quattro | 121 | 08/86 → 11/90 | 2.226 | B | M | 5 | 10 | MC | 05-1988 →, M →: 039.951 | 81683 |

| | | | | | | | | | |
|--|--|--|--|--|--|--|--|--|--|
| | | | | | | | | | |
|--|--|--|--|--|--|--|--|--|--|

AUDI

100 III, Avant

| | | | | | | | | | | |
|-------------------|-----|---------------|-------|---|---|---|----|--------|--------------------------------|-------|
| 2.2 quattro Cat. | 101 | 06/89 → 11/90 | 2.226 | B | M | 5 | 10 | HX, KU | | 81683 |
| 2.2 Turbo | 121 | 08/86 → 11/90 | 2.226 | B | M | 5 | 10 | MC | 05-1988 →, M →: 039.951 | 81683 |
| 2.2 Turbo quattro | 121 | 08/86 → 11/90 | 2.226 | B | M | 5 | 10 | MC | 05-1988 →, M →: 039.951 | 81683 |
| 2.3 | 98 | 03/90 → 11/90 | 2.309 | B | M | 5 | 10 | NF | | 81683 |
| | 100 | 08/86 → 11/90 | 2.309 | B | M | 5 | 10 | NF | 05-1988 →, M →: 063.969 | 81683 |
| 2.3 E | 98 | 01/90 → 11/90 | 2.309 | B | M | 5 | 10 | NF | | 81683 |
| | 100 | 10/86 → 11/90 | 2.309 | B | M | 5 | 10 | NF | 05-1988 →, M →: 063.969 | 81683 |
| 2.3 E quattro | 100 | 08/86 → 11/90 | 2.309 | B | M | 5 | 10 | NF | 05-1988 →, M →: 063.969 | 81683 |
| 2.3 quattro | 98 | 01/90 → 11/90 | 2.309 | B | M | 5 | 10 | NF | | 81683 |
| 2.4 D | 60 | 08/89 → 07/91 | 2.370 | D | M | 5 | 10 | 3D | → 05-1990, → T: F-L-100.000 | 81593 |

100 IV, Avant

| | | | | | | | | | | |
|-------------------|-----|---------------|-------|---|---|---|----|----------|--------|-------|
| 2.0 | 74 | 12/90 → 06/94 | 1.984 | B | M | 4 | 8 | AAE | (-)COP | 81522 |
| | 74 | 12/90 → 06/94 | 1.984 | B | M | 4 | 8 | AAE | (+)COP | 82080 |
| 2.0 E | 74 | 09/91 → 06/94 | 1.984 | B | M | 4 | 8 | AAE | (-)COP | 81522 |
| | 74 | 09/91 → 06/94 | 1.984 | B | M | 4 | 8 | AAE | (+)COP | 82080 |
| | 85 | 12/90 → 06/94 | 1.984 | B | M | 4 | 8 | AAD, ABK | (-)COP | 81522 |
| | 85 | 12/90 → 06/94 | 1.984 | B | M | 4 | 8 | AAD, ABK | (+)COP | 82080 |
| 2.0 E 16V | 103 | 01/92 → 06/94 | 1.984 | B | M | 4 | 16 | ACE | (-)COP | 81522 |
| | 103 | 01/92 → 06/94 | 1.984 | B | M | 4 | 16 | ACE | (+)COP | 82080 |
| 2.0 E 16V quattro | 103 | 07/92 → 06/94 | 1.984 | B | M | 4 | 16 | ACE | (-)COP | 81522 |
| | 103 | 07/92 → 06/94 | 1.984 | B | M | 4 | 16 | ACE | (+)COP | 82080 |
| 2.0 E quattro | 85 | 12/90 → 07/92 | 1.984 | B | M | 4 | 8 | AAD | (-)COP | 81522 |
| | 85 | 12/90 → 07/92 | 1.984 | B | M | 4 | 8 | AAD | (+)COP | 82080 |
| 2.3 E | 98 | 12/90 → 06/94 | 2.309 | B | M | 5 | 10 | AAR | | 81700 |
| 2.3 E quattro | 98 | 12/90 → 06/94 | 2.309 | B | M | 5 | 10 | AAR | | 81700 |
| 2.4 D | 60 | 12/90 → 06/94 | 2.370 | D | M | 5 | 10 | AAS | | 81701 |
| 2.5 TDI | 85 | 12/90 → 06/94 | 2.461 | D | M | 5 | 10 | AAT, ABP | | 81701 |
| S4 Turbo quattro | 169 | 08/91 → 06/94 | 2.226 | B | M | 5 | 20 | AAN | | 81700 |

200 II, Avant

| | | | | | | | | | | |
|-----------------------|-----|---------------|-------|---|---|---|----|----|--------------------|-------|
| 2.2 20V Turbo quattro | 162 | 03/89 → 12/90 | 2.226 | B | M | 5 | 20 | 3B | T →: F44-J-246.282 | 81683 |
| 2.2 Turbo | 121 | 08/85 → 09/91 | 2.226 | B | M | 5 | 10 | MC | M →: 039.951 | 81683 |
| | 140 | 02/88 → 12/90 | 2.226 | B | M | 5 | 10 | 2B | M →: 001.069 | 81683 |
| | 147 | 02/88 → 12/90 | 2.226 | B | M | 5 | 10 | 1B | M →: 001.571 | 81683 |
| 2.2 Turbo quattro | 121 | 01/85 → 12/91 | 2.226 | B | M | 5 | 10 | MC | M →: 039.951 | 81683 |
| | 147 | 02/88 → 11/90 | 2.226 | B | M | 5 | 10 | 1B | M →: 001.571 | 81683 |
| 2.3 | 100 | 11/86 → 09/91 | 2.309 | B | M | 5 | 10 | NF | | 81683 |

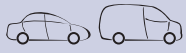
KW

cm³

NO. OF VALVES

MAGNETI MARELLI
AUDI
A1, Sportback

| | | | | | | | | | | | |
|------------------|-----|---------|-------|---|---|---|----|------------------|--|-------|------------|
| 1.2 TFSI | 63 | 05/10 → | 1.197 | B | M | 4 | 8 | CBZA | | 84045 | NEW |
| 1.4 TFSI | 90 | 05/10 → | 1.390 | B | M | 4 | 16 | CAXA, CNVA | | 82097 | |
| | 136 | 11/11 → | 1.390 | B | M | 4 | 16 | CAVG, CTHG, CTJA | | 82097 | |
| | 92 | 11/14 → | 1.395 | B | M | 4 | 16 | CZCA, CZDB | | 84062 | NEW |
| | 103 | 04/12 → | 1.395 | B | M | 4 | 16 | CPTA | | 84062 | NEW |
| | 110 | 11/14 → | 1.395 | B | M | 4 | 16 | CZEA | | 84062 | NEW |
| 1.6 TDI | 66 | 03/11 → | 1.598 | D | M | 4 | 16 | CAYB | | 84001 | |
| | 77 | 05/10 → | 1.598 | D | M | 4 | 16 | CAYC | | 84001 | |
| 1.8 TFSI | 141 | 02/15 → | 1.798 | B | M | 4 | 16 | DAJB | | 84037 | NEW |
| 2.0 TDI | 100 | 05/12 → | 1.968 | D | M | 4 | 16 | CFHB | | 84001 | |
| | 105 | 09/11 → | 1.968 | D | M | 4 | 16 | CFHD | | 84001 | |
| 2.0 TFSI quattro | 188 | 03/12 → | 1.984 | B | M | 4 | 16 | CDLH | | 82025 | |
| S1 quattro | 170 | 03/14 → | 1.984 | B | M | 4 | 16 | CWZA | | 84037 | NEW |

A2

| | | | | | | | | | | | |
|---------|----|---------------|-------|---|---|---|----|----------|--|-------|------------|
| 1.2 TDI | 45 | 03/01 → 08/05 | 1.191 | D | M | 3 | 6 | ANY | | 84010 | NEW |
| | 45 | 03/01 → 08/05 | 1.191 | D | M | 3 | 6 | ANY | | 81791 | |
| 1.4 | 55 | 02/00 → 08/05 | 1.390 | B | M | 4 | 16 | AUA, BBY | | 81777 | |
| 1.4 TDI | 55 | 02/00 → 08/05 | 1.422 | D | M | 3 | 6 | AMF, BHC | | 84010 | NEW |
| | 55 | 02/00 → 08/05 | 1.422 | D | M | 3 | 6 | AMF, BHC | | 81791 | |
| | 66 | 11/03 → 08/05 | 1.422 | D | M | 3 | 6 | ATL | | 84010 | NEW |
| | 66 | 11/03 → 08/05 | 1.422 | D | M | 3 | 6 | ATL | | 81791 | |
| 1.6 FSI | 81 | 05/02 → 08/05 | 1.598 | B | M | 4 | 16 | BAD | | 81840 | |

A3 I

| | | | | | | | | | | | |
|-----------------|-----|---------------|-------|---|----|---|----|--------------------|--------------------|-------|------------|
| 1.6 | 74 | 09/96 → 05/03 | 1.595 | B | M | 4 | 8 | AEH, AKL, APF | | 81702 | |
| | 75 | 08/00 → 05/03 | 1.595 | B | AM | 4 | 8 | AVU, BFQ | | 81702 | |
| 1.8 | 92 | 09/96 → 05/03 | 1.781 | B | AM | 4 | 20 | AGN, APG | | 81703 | |
| 1.8 T | 110 | 12/96 → 05/03 | 1.781 | B | M | 4 | 20 | AGU, AQA, ARZ, AUM | | 81703 | |
| | 132 | 12/98 → 05/03 | 1.781 | B | M | 4 | 20 | AJQ, APP, ARY, AUQ | | 81703 | |
| 1.8 T quattro | 110 | 12/96 → 05/03 | 1.781 | B | M | 4 | 20 | AGU, AQA, ARX | | 81703 | |
| | 132 | 10/98 → 05/03 | 1.781 | B | M | 4 | 20 | AJQ, ARY | | 81703 | |
| 1.9 TDI | 66 | 09/96 → 07/01 | 1.896 | D | M | 4 | 8 | AGR, ALH | T →: F8L-V-115.001 | 81706 | |
| | 74 | 10/00 → 05/03 | 1.896 | D | M | 4 | 8 | ATD, AXR | | 81816 | |
| | 74 | 10/00 → 05/03 | 1.896 | D | M | 4 | 8 | ATD, AXR | | 84011 | NEW |
| | 81 | 08/97 → 07/01 | 1.896 | D | M | 4 | 8 | AHF, ASV | T →: F8L-V-115.001 | 81706 | |
| | 96 | 08/00 → 05/03 | 1.896 | D | AM | 4 | 8 | ASZ | | 81816 | |
| | 96 | 08/00 → 05/03 | 1.896 | D | AM | 4 | 8 | ASZ | | 84011 | NEW |
| 1.9 TDI quattro | 96 | 08/00 → 05/03 | 1.896 | D | M | 4 | 8 | ASZ | | 81816 | |
| | 96 | 08/00 → 05/03 | 1.896 | D | M | 4 | 8 | ASZ | | 84011 | NEW |
| S3 quattro | 154 | 03/99 → 04/02 | 1.781 | B | M | 4 | 20 | AMK, APY, AUL | | 81703 | |
| | 165 | 10/01 → 05/03 | 1.781 | B | M | 4 | 20 | BAM | | 81703 | |

| | | | | | | | | | | |
|--|--|-----------|--|-----------------------|--|--|--|----------------------|--|--|
| | | KW | | cm³ | | | | NO. OF VALVES | | |
|--|--|-----------|--|-----------------------|--|--|--|----------------------|--|--|

AUDI

A3 II, Sportback, Cabriolet

| | | | | | | | | | | | |
|---------------------|-----|---------------|-------|----|---|---|----|-----------------------------------|--------|-------|--|
| 1.2 TFSI | 77 | 03/10 → 05/13 | 1.197 | B | M | 4 | 8 | CBZB | | 84045 | |
| 1.2 TSI | 77 | 04/10 → 08/12 | 1.197 | B | M | 4 | 8 | CBZB | | 84045 | |
| 1.4 TFSI | 92 | 02/11 → 05/13 | 1.390 | B | M | 4 | 16 | CAXC | | 82097 | |
| | 92 | 09/07 → 08/12 | 1.390 | B | M | 4 | 16 | CAXC, CMSA | | 82097 | |
| 1.6 | 75 | 05/03 → 08/12 | 1.595 | B | M | 4 | 8 | BGU, BSE, BSF, CCSA, CMXA | | 81702 | |
| | 75 | 09/08 → 05/10 | 1.595 | B | M | 4 | 8 | BSE | | 81702 | |
| 1.6 E-Power | 75 | 01/11 → 08/12 | 1.595 | FF | M | 4 | 8 | CCSA, CMXA | | 81702 | |
| 1.6 FSI | 85 | 08/03 → 09/07 | 1.598 | B | M | 4 | 16 | BAG, BLF, BLP | | 81865 | |
| | 85 | 09/04 → 09/07 | 1.598 | B | M | 4 | 16 | BLF, BLP | | 81865 | |
| 1.6 TDI | 66 | 05/09 → 08/12 | 1.598 | D | M | 4 | 16 | CAYB | | 84001 | |
| | 77 | 05/09 → 08/12 | 1.598 | D | M | 4 | 16 | CAYC | | 84001 | |
| 1.8 T | 110 | 08/06 → 08/12 | 1.781 | B | M | 4 | 20 | BPU | | 81702 | |
| 1.8 TFSI | 118 | 11/06 → 08/12 | 1.798 | B | M | 4 | 16 | BYT, BZB, CDAA | | 84016 | |
| | 118 | 04/08 → 05/13 | 1.798 | B | M | 4 | 16 | BZB, CDAA | | 84016 | |
| 1.8 TFSI quattro | 118 | 07/08 → 08/12 | 1.798 | B | M | 4 | 16 | CDAA | | 84016 | |
| 1.9 TDI | 77 | 05/03 → 05/10 | 1.896 | D | M | 4 | 8 | BKC, BLS, BXE | | 84010 | |
| | 77 | 05/03 → 05/10 | 1.896 | D | M | 4 | 8 | BKC, BLS, BXE | | 81791 | |
| | 77 | 04/08 → 10/09 | 1.896 | D | M | 4 | 8 | BLS | | 84010 | |
| | 77 | 04/08 → 10/09 | 1.896 | D | M | 4 | 8 | BLS | | 81791 | |
| 2.0 FSI | 110 | 05/03 → 06/08 | 1.984 | B | M | 4 | 16 | AXW, BLR, BLX, BLY, BMB, BVY, BVZ | | 81702 | |
| 2.0 TDI | 100 | 05/03 → 08/12 | 1.968 | D | M | 4 | 16 | AZV, CBAA, CFFA | | 81816 | |
| | 100 | 05/03 → 08/12 | 1.968 | D | M | 4 | 16 | AZV, CBAA, CFFA | | 84011 | |
| | 100 | 04/08 → 05/13 | 1.968 | D | M | 4 | 16 | CBAA, CFFA | | 81816 | |
| | 100 | 04/08 → 05/13 | 1.968 | D | M | 4 | 16 | CBAA, CFFA | | 84011 | |
| | 103 | 06/05 → 06/08 | 1.968 | D | M | 4 | 8 | BMM | | 81816 | |
| | 103 | 06/05 → 06/08 | 1.968 | D | M | 4 | 8 | BMM | | 84011 | |
| | 103 | 04/08 → 05/13 | 1.968 | D | M | 4 | 16 | CBAB, CFFB | | 81816 | |
| | 103 | 04/08 → 05/13 | 1.968 | D | M | 4 | 16 | CBAB, CFFB | | 84011 | |
| | 120 | 06/06 → 06/08 | 1.968 | D | M | 4 | 16 | BUY | | 81816 | |
| | 120 | 06/06 → 06/08 | 1.968 | D | M | 4 | 16 | BUY | | 84011 | |
| | 125 | 03/06 → 08/12 | 1.968 | D | M | 4 | 16 | BMN, CBBB, CFGB | | 81816 | |
| | 125 | 03/06 → 08/12 | 1.968 | D | M | 4 | 16 | BMN, CBBB, CFGB | | 84011 | |
| 2.0 TDI 16V | 103 | 05/03 → 08/12 | 1.968 | D | M | 4 | 16 | BKD, CBAB, CFFB, CLJA | | 81816 | |
| | 103 | 05/03 → 08/12 | 1.968 | D | M | 4 | 16 | BKD, CBAB, CFFB, CLJA | | 84011 | |
| 2.0 TDI 16V quattro | 103 | 08/04 → 08/12 | 1.968 | D | M | 4 | 16 | BKD, CBAB, CFFB | | 81816 | |
| | 103 | 08/04 → 08/12 | 1.968 | D | M | 4 | 16 | BKD, CBAB, CFFB | | 84011 | |
| | 103 | 11/05 → 03/13 | 1.968 | D | M | 4 | 16 | BKD, CBAB, CFFB | M: BKD | 81816 | |

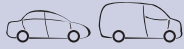
KW

cm³

NO. OF VALVES

MAGNETI MARELLI
AUDI
A3 II, Sportback, Cabriolet

| | | | | | | | | | | |
|------------------|-----|---------------|-------|---|---|---|----|---------------------------------|-------|------------|
| 2.0 TDI quattro | 100 | 05/03 → 06/08 | 1.968 | D | M | 4 | 16 | AZV | 81816 | |
| | 100 | 05/03 → 06/08 | 1.968 | D | M | 4 | 16 | AZV | 84011 | NEW |
| | 103 | 01/06 → 06/08 | 1.968 | D | M | 4 | 8 | BMM | 81816 | |
| | 103 | 01/06 → 06/08 | 1.968 | D | M | 4 | 8 | BMM | 84011 | NEW |
| | 125 | 03/06 → 08/12 | 1.968 | D | M | 4 | 16 | BMN, CBBB, CFGB | 81816 | |
| | 125 | 03/06 → 08/12 | 1.968 | D | M | 4 | 16 | BMN, CBBB, CFGB | 84011 | NEW |
| 2.0 TFSI | 147 | 09/04 → 03/13 | 1.984 | B | M | 4 | 16 | AXX, BPY, BWA, CAWB, CBFA, CCZA | 82025 | |
| | 147 | 09/04 → 08/12 | 1.984 | B | M | 4 | 16 | AXX, BWA, CAWB, CCZA | 82025 | |
| 2.0 TFSI | 147 | 04/08 → 05/13 | 1.984 | B | M | 4 | 16 | CAWB, CCZA | 84016 | NEW |
| 2.0 TFSI quattro | 147 | 09/04 → 03/13 | 1.984 | B | M | 4 | 16 | AXX, BPY, BWA, CCZA | 82025 | |
| | 147 | 09/04 → 08/12 | 1.984 | B | M | 4 | 16 | AXX, BWA, CCTA, CCZA | 82025 | |
| 3.2 V6 quattro | 184 | 07/03 → 05/09 | 3.189 | B | M | 6 | 24 | BDB, BMJ, BUB | 81866 | |
| | 184 | 09/04 → 05/09 | 3.189 | B | M | 6 | 24 | BMJ, BUB | 81866 | |
| S3 quattro | 188 | 02/07 → 08/12 | 1.984 | B | M | 4 | 16 | BZC, CDLC | 82025 | |
| | 188 | 07/08 → 03/13 | 1.984 | B | M | 4 | 16 | CDLC | 82025 | |
| | 195 | 11/06 → 08/12 | 1.984 | B | M | 4 | 16 | BHZ, CDLA | 82025 | |

A3 III, Sportback, Cabriolet

| | | | | | | | | | | |
|------------------|-----------------|---------|---------|-------|---|---|----|------------|------------|------------|
| 1.2 TFSI | 77 | 02/13 → | 1.197 | B | M | 4 | 16 | CJZA | 84062 | NEW |
| | 81 | 05/14 → | 1.197 | B | M | 4 | 16 | CYVB | 84062 | NEW |
| 1.4 TFSI | 85 | 02/16 → | 1.395 | B | M | 4 | 16 | CZCC | 84062 | NEW |
| | 90 | 04/12 → | 1.395 | B | M | 4 | 16 | CMBA, CXSA | 84062 | NEW |
| | 92 | 05/14 → | 1.395 | B | M | 4 | 16 | CXSB, CZCA | 84062 | NEW |
| | 103 | 03/13 → | 1.395 | B | M | 4 | 16 | CPTA | 84062 | NEW |
| | 110 | 05/14 → | 1.395 | B | M | 4 | 16 | CZEA | 84062 | NEW |
| | 1.4 TFSI e-tron | 110 | 05/14 → | 1.395 | | M | 4 | 16 | CUKB, CXUA | 84062 |
| 81 | | 11/13 → | 1.395 | | M | 4 | 16 | CPWA | 84062 | NEW |
| 1.8 TFSI | 125 | 05/14 → | 1.798 | B | M | 4 | 16 | CNSB | 84037 | NEW |
| | 132 | 04/12 → | 1.798 | B | M | 4 | 16 | CJSA | 84037 | NEW |
| | 132 | 05/13 → | 1.798 | B | M | 4 | 16 | CJSA, CJSB | 84037 | NEW |
| 1.8 TFSI quattro | 132 | 08/12 → | 1.798 | B | M | 4 | 16 | CJSB | 84037 | NEW |
| S3 quattro | 206 | 02/13 → | 1.984 | B | M | 4 | 16 | CJXB | 84037 | NEW |
| | 210 | 05/14 → | 1.984 | B | M | 4 | 16 | CJXF | 84037 | NEW |
| S3 quattro | 221 | 11/12 → | 1.984 | B | M | 4 | 16 | CJXC | 84037 | NEW |

KW

cm³

NO. OF VALVES

AUDI
A4 I, Avant

| | | | | | | | | | | |
|-----------------|-----|---------------|-------|---|---|---|----|----------------------------|---|------------------|
| 1.6 | 74 | 11/94 → 09/01 | 1.595 | B | M | 4 | 8 | ADP, AHL, ANA, ARM | (-)COP, 03-1996 →, → 12-1997 | 81526 |
| | 74 | 11/94 → 09/01 | 1.595 | B | M | 4 | 8 | ADP, AHL, ANA, ARM | (+)COP, 03-1996 →, → 12-1997 | 81529 |
| | 74 | 11/94 → 10/00 | 1.595 | B | M | 4 | 8 | ADP, AHL, ANA, ARM | (-)COP, 01-1995 →, → 12-1997 | 81526 |
| | 74 | 11/94 → 10/00 | 1.595 | B | M | 4 | 8 | ADP, AHL, ANA, ARM | (+)COP, 01-1995 →, → 12-1997 | 81529 |
| | 74 | 11/94 → 10/00 | 1.595 | B | M | 4 | 8 | ADP, AHL, ANA, ARM | 12-1997 →, → 07-2000, M: AHL/ ANA/ARM | 81702 |
| | 75 | 07/00 → 11/00 | 1.595 | B | M | 4 | 8 | ALZ | | 81702 |
| 1.81.8 | 85 | 04/95 → 11/00 | 1.781 | B | M | 4 | 20 | AFY | (-)COP | 81526 |
| | 85 | 04/95 → 11/00 | 1.781 | B | M | 4 | 20 | AFY | (+)COP | 81529 |
| | 92 | 01/95 → 11/00 | 1.781 | B | M | 4 | 20 | ADR, APT, ARG, AVV | (-)COP | 81526 |
| | 92 | 01/95 → 11/00 | 1.781 | B | M | 4 | 20 | ADR, APT, ARG, AVV | (+)COP | 81529 |
| | 95 | 01/95 → 11/00 | 1.781 | B | M | 4 | 20 | ADR | (-)COP | 81526 |
| | 95 | 01/95 → 11/00 | 1.781 | B | M | 4 | 20 | ADR | (+)COP | 81529 |
| 1.8 quattro | 85 | 07/95 → 11/00 | 1.781 | B | M | 4 | 20 | AFY | (-)COP | 81526 |
| | 85 | 07/95 → 11/00 | 1.781 | B | M | 4 | 20 | AFY | (+)COP | 81529 |
| | 92 | 01/95 → 11/00 | 1.781 | B | M | 4 | 20 | ADR, APT, ARG | (-)COP | 81526 |
| | 92 | 01/95 → 11/00 | 1.781 | B | M | 4 | 20 | ADR, APT, ARG | (+)COP | 81529 |
| 1.8 T | 110 | 01/95 → 11/00 | 1.781 | B | M | 4 | 20 | AEB, ANB, APU, ARK, AWT | (-)COP | 81526 |
| | 110 | 01/95 → 11/00 | 1.781 | B | M | 4 | 20 | AEB, ANB, APU, ARK, AWT | (+)COP | 81529 |
| | 132 | 12/97 → 11/00 | 1.781 | B | M | 4 | 20 | AJL | (-)COP | 81526 |
| | 132 | 12/97 → 11/00 | 1.781 | B | M | 4 | 20 | AJL | (+)COP | 81529 |
| 1.8 T quattro | 110 | 01/95 → 11/00 | 1.781 | B | M | 4 | 20 | AEB, ANB, APU, ARK, AWT | (-)COP | 81526 |
| | 110 | 01/95 → 11/00 | 1.781 | B | M | 4 | 20 | AEB, ANB, APU, ARK, AWT | (+)COP | 81529 |
| | 132 | 12/97 → 11/00 | 1.781 | B | M | 4 | 20 | AJL | (-)COP | 81526 |
| | 132 | 12/97 → 11/00 | 1.781 | B | M | 4 | 20 | AJL | (+)COP | 81529 |
| 1.9 DUO | 66 | 03/98 → 09/01 | 1.896 | | M | 4 | 8 | AHU | M: AHU, M: AHH | 81528 |
| 1.9 TDI | 55 | 12/95 → 11/00 | 1.896 | D | M | 4 | 8 | AFF | | 81528 |
| | 66 | 01/95 → 11/00 | 1.896 | D | M | 4 | 8 | 1Z, AHH, AHU | | 81528 |
| | 81 | 10/95 → 11/00 | 1.896 | D | M | 4 | 8 | AFN, AVG | | 81528 |
| | 85 | 03/00 → 11/00 | 1.896 | D | M | 4 | 8 | AJM | | 81816 |
| | 85 | 03/00 → 11/00 | 1.896 | D | M | 4 | 8 | AJM | | 84011 NEW |
| 1.9 TDI quattro | 81 | 09/96 → 11/00 | 1.896 | D | M | 4 | 8 | AFN, AVG | | 81528 |
| | 85 | 03/00 → 11/00 | 1.896 | D | M | 4 | 8 | AJM, ATJ | | 81816 |
| | 85 | 03/00 → 11/00 | 1.896 | D | M | 4 | 8 | AJM, ATJ | | 84011 NEW |

KW

cm³

NO. OF VALVES

AUDI
A4 I, Avant

| | | | | | | | | | | |
|-------------------|-----|---------------|-------|---|---|---|----|------------------------------|-----------|-------|
| 2.4 | 110 | 07/95 → 07/97 | 2.393 | B | M | 6 | 12 | AFM | | 81842 |
| | 120 | 08/97 → 11/00 | 2.393 | B | M | 6 | 30 | AJG, AMM, APZ | | 81842 |
| | 121 | 03/97 → 11/00 | 2.393 | B | M | 6 | 30 | AGA, ALF, AML, APS, ARJ | | 81842 |
| 2.4 quattro | 120 | 08/97 → 11/00 | 2.393 | B | M | 6 | 30 | APZ | | 81842 |
| | 121 | 03/97 → 11/00 | 2.393 | B | M | 6 | 30 | AGA, ALF, AML, APS, ARJ | | 81842 |
| 2.5 TDI | 110 | 09/97 → 11/00 | 2.496 | D | M | 6 | 24 | AFB, AKN | | 81705 |
| 2.5 TDI quattro | 110 | 09/97 → 11/00 | 2.496 | D | M | 6 | 24 | AFB, AKN | | 81705 |
| 2.6 | 102 | 01/96 → 07/97 | 2.598 | B | M | 6 | 12 | ACZ | | 81842 |
| | 110 | 01/95 → 11/00 | 2.598 | B | M | 6 | 12 | ABC | | 81842 |
| 2.6 quattro | 110 | 01/95 → 11/00 | 2.598 | B | M | 6 | 12 | ABC | | 81842 |
| 2.7 Turbo quattro | 169 | 02/99 → 09/00 | 2.671 | B | M | 6 | 30 | AJK | | 81842 |
| 2.8 | 128 | 09/95 → 07/97 | 2.771 | B | M | 6 | 12 | AAH | | 81842 |
| | 142 | 10/96 → 11/00 | 2.771 | B | M | 6 | 30 | ACK, AHA, ALG, AMX, APR, AQD | | 81842 |
| 2.8 quattro | 128 | 01/95 → 07/97 | 2.771 | B | M | 6 | 12 | AAH | | 81842 |
| | 142 | 10/96 → 08/01 | 2.771 | B | M | 6 | 30 | ACK, AHA, ALG, AMX, APR, AQD | | 81842 |
| RS4 quattro | 280 | 05/00 → 09/01 | 2.671 | B | M | 6 | 30 | ASJ, AZR | | 81842 |
| S4 quattro | 195 | 09/97 → 09/01 | 2.671 | B | M | 6 | 30 | AGB, AZB | 01-1999 → | 81842 |
| | 195 | 09/97 → 09/01 | 2.671 | B | M | 6 | 30 | AGB, AZB | | 81842 |

A4 II, Avant, Cabriolet

| | | | | | | | | | | |
|-----------------|-----|---------------|-------|---|---|---|----|----------|--------|------------------|
| 1.6 | 75 | 11/00 → 12/04 | 1.595 | B | M | 4 | 8 | ALZ | | 81702 |
| 1.8 T | 110 | 11/00 → 07/02 | 1.781 | B | M | 4 | 20 | AVJ | | 81703 |
| | 120 | 07/02 → 12/04 | 1.781 | B | M | 4 | 20 | BFB | | 81703 |
| | 120 | 07/02 → 12/04 | 1.781 | B | M | 4 | 20 | BFB, BKB | | 81703 |
| | 125 | 07/01 → 12/04 | 1.781 | B | M | 4 | 20 | AMB | | 81703 |
| | 140 | 11/02 → 12/04 | 1.781 | B | M | 4 | 20 | BEX | | 81703 |
| 1.8 T quattro | 110 | 11/00 → 07/02 | 1.781 | B | M | 4 | 20 | AVJ | | 81703 |
| | 120 | 07/02 → 12/04 | 1.781 | B | M | 4 | 20 | BFB | | 81703 |
| | 125 | 07/01 → 12/04 | 1.781 | B | M | 4 | 20 | AMB | | 81703 |
| | 140 | 11/02 → 12/04 | 1.781 | B | M | 4 | 20 | BEX | | 81703 |
| 1.9 TDI | 74 | 05/01 → 12/04 | 1.896 | D | M | 4 | 8 | AVB | | 81816 |
| | 74 | 05/01 → 12/04 | 1.896 | D | M | 4 | 8 | AVB | | 84011 NEW |
| | 85 | 06/04 → 12/04 | 1.896 | D | M | 4 | 8 | BKE | | 81816 |
| | 85 | 06/04 → 12/04 | 1.896 | D | M | 4 | 8 | BKE | | 84011 NEW |
| | 96 | 11/00 → 12/04 | 1.896 | D | M | 4 | 8 | AVF, AWX | | 81816 |
| | 96 | 11/00 → 12/04 | 1.896 | D | M | 4 | 8 | AVF, AWX | | 84011 NEW |
| 1.9 TDI quattro | 96 | 11/01 → 12/04 | 1.896 | D | M | 4 | 8 | AVF | | 81816 |
| | 96 | 11/01 → 12/04 | 1.896 | D | M | 4 | 8 | AVF | | 84011 NEW |
| 2.0 | 96 | 09/04 → 12/05 | 1.984 | B | M | 4 | 20 | ALT | M: ALT | 81702 |
| | 96 | 11/00 → 12/04 | 1.984 | B | M | 4 | 20 | ALT | | 81702 |
| 2.0 FSI | 110 | 07/02 → 12/04 | 1.984 | B | M | 4 | 16 | AWA | | 81702 |

KW

cm³

NO. OF VALVES

AUDI
A4 II, Avant, Cabriolet

| | | | | | | | | | | |
|------------------|-----|---------------|-------|---|----|---|----|---------------|--|------------------|
| 2.0 TDI | 100 | 01/06 → 03/09 | 1.968 | D | M | 4 | 8 | BRC | | 81816 |
| | 100 | 01/06 → 03/09 | 1.968 | D | M | 4 | 8 | BRC | | 84011 NEW |
| | 103 | 01/06 → 03/09 | 1.968 | D | M | 4 | 8 | BPW | | 81816 |
| | 103 | 01/06 → 03/09 | 1.968 | D | M | 4 | 8 | BPW | | 84011 NEW |
| 2.0 TFSI 16V | 147 | 01/06 → 03/09 | 1.984 | B | M | 4 | 16 | BWE, BWT | | 82025 |
| 2.0 TFSI quattro | 147 | 11/05 → 03/09 | 1.984 | B | M | 4 | 16 | BWT | | 82025 |
| 2.4 | 120 | 09/01 → 12/04 | 2.393 | B | M | 6 | 30 | AMM | | 81842 |
| | 125 | 09/01 → 12/04 | 2.393 | B | M | 6 | 30 | BDV | | 81842 |
| 2.5 TDI | 114 | 08/01 → 07/02 | 2.496 | D | M | 6 | 24 | AYM | | 81705 |
| | 120 | 07/02 → 12/04 | 2.496 | D | M | 6 | 24 | BCZ, BDG, BFC | | 81705 |
| | 132 | 10/00 → 05/03 | 2.496 | D | M | 6 | 24 | AKE | | 81705 |
| 2.5 TDI quattro | 132 | 11/00 → 12/04 | 2.496 | D | M | 6 | 24 | AKE, BAU, BDH | | 81705 |
| 2.7 TDI | 132 | 06/06 → 03/09 | 2.698 | D | M | 6 | 24 | BPP | | 82015 |
| 3.0 | 160 | 04/01 → 12/04 | 2.976 | B | M | 6 | 30 | BBJ | | 81819 |
| | 162 | 09/01 → 12/04 | 2.976 | B | M | 6 | 30 | ASN | | 81819 |
| | 162 | 11/00 → 12/04 | 2.976 | B | M | 6 | 30 | ASN, AVK | | 81819 |
| 3.0 quattro | 160 | 04/01 → 12/04 | 2.976 | B | M | 6 | 30 | BBJ | | 81819 |
| | 162 | 05/03 → 12/05 | 2.976 | B | M | 6 | 30 | ASN | | 81819 |
| | 162 | 09/01 → 12/04 | 2.976 | B | AM | 6 | 30 | ASN, AVK | | 81819 |
| | 162 | 11/00 → 12/04 | 2.976 | B | M | 6 | 30 | ASN, AVK | | 81819 |
| 3.0 TDI quattro | 150 | 01/06 → 03/09 | 2.967 | D | M | 6 | 24 | BKN | | 82015 |
| | 171 | 01/06 → 03/09 | 2.967 | D | M | 6 | 24 | ASB | | 82015 |
| 3.2 FSI | 188 | 01/06 → 03/09 | 3.123 | B | M | 6 | 24 | AUK | | 82015 |
| 3.2 FSI quattro | 188 | 01/06 → 03/09 | 3.123 | B | M | 6 | 24 | AUK | | 82015 |
| S4 quattro | 253 | 03/03 → 12/04 | 4.163 | B | M | 8 | 40 | BBK | | 82046 |

A4 III, Avant

| | | | | | | | | | | |
|---------------|-----|---------------|-------|---|---|---|----|----------|--|------------------|
| 1.6 | 75 | 11/04 → 06/08 | 1.595 | B | M | 4 | 8 | ALZ | | 81702 |
| 1.8 T | 120 | 11/04 → 06/08 | 1.781 | B | M | 4 | 20 | BFB | | 81703 |
| 1.8 T quattro | 120 | 11/04 → 06/08 | 1.781 | B | M | 4 | 20 | BFB | | 81703 |
| 1.9 TDI | 85 | 11/04 → 06/08 | 1.896 | D | M | 4 | 8 | BKE, BRB | | 81816 |
| | 85 | 11/04 → 06/08 | 1.896 | D | M | 4 | 8 | BKE, BRB | | 84011 NEW |
| 2.0 | 96 | 11/04 → 06/08 | 1.984 | B | M | 4 | 20 | ALT | | 81702 |
| 2.0 TDI | 89 | 09/05 → 09/06 | 1.968 | D | M | 4 | 16 | BVG | | 81816 |
| | 89 | 09/05 → 09/06 | 1.968 | D | M | 4 | 16 | BVG | | 84011 NEW |
| | 93 | 11/05 → 11/06 | 1.968 | D | M | 4 | 16 | BVF | | 81816 |
| | 93 | 11/05 → 11/06 | 1.968 | D | M | 4 | 16 | BVF | | 84011 NEW |
| | 100 | 11/04 → 06/08 | 1.968 | D | M | 4 | 16 | BNA, BRF | | 81816 |
| | 100 | 11/04 → 06/08 | 1.968 | D | M | 4 | 16 | BNA, BRF | | 84011 NEW |
| | 103 | 11/04 → 06/08 | 1.968 | D | M | 4 | 8 | BPW | | 81816 |
| | 103 | 11/04 → 06/08 | 1.968 | D | M | 4 | 8 | BPW | | 84011 NEW |
| | 120 | 06/06 → 06/08 | 1.968 | D | M | 4 | 16 | BVA | | 81816 |
| | 120 | 06/06 → 06/08 | 1.968 | D | M | 4 | 16 | BVA | | 84011 NEW |
| | 125 | 06/06 → 06/08 | 1.968 | D | M | 4 | 16 | BRD | | 81816 |
| | 125 | 06/06 → 06/08 | 1.968 | D | M | 4 | 16 | BRD | | 84011 NEW |

KW

cm³

NO. OF VALVES

MAGNETI MARELLI
AUDI
A4 III, Avant

| | | | | | | | | | | | |
|------------------|-----|---------------|-------|---|---|---|----|--------------------|--|-------|------------|
| 2.0 TDI 16V | 103 | 11/04 → 06/08 | 1.968 | D | M | 4 | 16 | BLB, BRE | | 81816 | |
| | 103 | 11/04 → 06/08 | 1.968 | D | M | 4 | 16 | BLB, BRE | | 84011 | NEW |
| 2.0 TDI quattro | 103 | 01/06 → 06/08 | 1.968 | D | M | 4 | 8 | BPW | | 81816 | |
| | 103 | 01/06 → 06/08 | 1.968 | D | M | 4 | 8 | BPW | | 84011 | NEW |
| | 120 | 06/06 → 06/08 | 1.968 | D | M | 4 | 16 | BVA | | 81816 | |
| | 120 | 06/06 → 06/08 | 1.968 | D | M | 4 | 16 | BVA | | 84011 | NEW |
| | 125 | 06/06 → 06/08 | 1.968 | D | M | 4 | 16 | BRD | | 81816 | |
| | 125 | 06/06 → 06/08 | 1.968 | D | M | 4 | 16 | BRD | | 84011 | NEW |
| 2.0 TFSI | 125 | 10/06 → 06/08 | 1.984 | B | M | 4 | 16 | BPJ, BYK | | 82025 | |
| | 147 | 11/04 → 06/08 | 1.984 | B | M | 4 | 16 | BGB, BPG, BWE, BWT | | 82025 | |
| | 147 | 11/04 → 06/08 | 1.984 | B | M | 4 | 16 | BGB, BWE | | 82025 | |
| | 162 | 06/05 → 06/08 | 1.984 | B | M | 4 | 16 | BUL | | 82025 | |
| 2.0 TFSI quattro | 147 | 11/04 → 06/08 | 1.984 | B | M | 4 | 16 | BGB, BPG, BWE, BWT | | 82025 | |
| | 147 | 11/04 → 06/08 | 1.984 | B | M | 4 | 16 | BGB, BWE, BWT | | 82025 | |
| 2.5 TDI | 120 | 11/04 → 05/06 | 2.496 | D | M | 6 | 24 | BDG | | 81705 | |
| | 120 | 11/05 → 06/08 | 2.698 | D | M | 6 | 24 | BSG | | 82015 | |
| 2.7 TDI | 132 | 01/06 → 06/08 | 2.698 | D | M | 6 | 24 | BPP | | 82015 | |
| | 160 | 11/04 → 05/06 | 2.976 | B | M | 6 | 30 | BBJ | | 81819 | |
| 3.0 quattro | 160 | 11/04 → 07/06 | 2.976 | B | M | 6 | 30 | BBJ | | 81819 | |
| 3.0 TDI quattro | 150 | 11/04 → 06/08 | 2.967 | D | M | 6 | 24 | BKN | | 82015 | |
| | 171 | 01/06 → 06/08 | 2.967 | D | M | 6 | 24 | ASB | | 82015 | |
| 3.2 FSI | 188 | 01/05 → 06/08 | 3.123 | B | M | 6 | 24 | AUK | | 82015 | |
| 3.2 FSI quattro | 188 | 01/05 → 06/08 | 3.123 | B | M | 6 | 24 | AUK | | 82015 | |
| | 188 | 01/05 → 06/08 | 3.123 | B | M | 6 | 24 | AUK, BKH | | 82015 | |
| S4 quattro | 253 | 11/04 → 06/08 | 4.163 | B | M | 8 | 40 | BBK | | 82046 | |
| | 253 | 11/04 → 06/08 | 4.163 | B | M | 8 | 40 | BBK, BHF | | 82046 | |

A4 IV, Avant, Allroad

| | | | | | | | | | | | |
|------------------|-----|---------------|-------|---|---|---|----|------------------|--|-------|------------|
| 1.8 TFSI | 88 | 01/08 → 12/15 | 1.798 | B | M | 4 | 16 | CABA, CDHA | | 84016 | NEW |
| | 88 | 04/08 → 12/15 | 1.798 | B | M | 4 | 16 | CDHA | | 84016 | NEW |
| | 118 | 11/07 → 03/12 | 1.798 | B | M | 4 | 16 | CABB, CCUA, CDHB | | 84016 | NEW |
| | 125 | 11/11 → 12/15 | 1.798 | B | M | 4 | 16 | CJEB | | 84037 | NEW |
| 1.8 TFSI quattro | 118 | 09/08 → 03/12 | 1.798 | B | M | 4 | 16 | CDHB | | 84016 | NEW |
| | 125 | 11/11 → 12/15 | 1.798 | B | M | 4 | 16 | CJEB | | 84037 | NEW |

KW

cm³

NO. OF VALVES

AUDI
A4 IV, Avant, Allroad

| | | | | | | | | | | |
|--------------------------------|-----|---------------|-------|---|---|---|----|------------------------|--|------------------|
| 2.0 TDI | 88 | 06/08 → 12/15 | 1.968 | D | M | 4 | 16 | CAGC, CJCC | | 81816 |
| | 88 | 06/08 → 12/15 | 1.968 | D | M | 4 | 16 | CAGC, CJCC | | 84011 NEW |
| | 100 | 11/07 → 12/15 | 1.968 | D | M | 4 | 16 | CAGB, CJCB, CSUB | | 81816 |
| | 100 | 11/07 → 12/15 | 1.968 | D | M | 4 | 16 | CAGB, CJCB, CSUB | | 84011 NEW |
| | 105 | 11/07 → 12/15 | 1.968 | D | M | 4 | 16 | CAGA, CJCA, CMEA, CMFA | | 81816 |
| | 105 | 11/07 → 12/15 | 1.968 | D | M | 4 | 16 | CAGA, CJCA, CMEA, CMFA | | 84011 NEW |
| | 110 | 05/13 → 12/15 | 1.968 | D | M | 4 | 16 | CJCD, CMFB, CSUA | | 84001 |
| | 120 | 08/08 → 12/15 | 1.968 | D | M | 4 | 16 | CAHB, CGLD, CNHC | | 81816 |
| | 120 | 08/08 → 12/15 | 1.968 | D | M | 4 | 16 | CAHB, CGLD, CNHC | | 84011 NEW |
| | 125 | 01/08 → 03/12 | 1.968 | D | M | 4 | 16 | CAHA | | 81816 |
| | 125 | 01/08 → 03/12 | 1.968 | D | M | 4 | 16 | CAHA | | 84011 NEW |
| | 130 | 11/11 → 12/15 | 1.968 | D | M | 4 | 16 | CGLC | | 84001 |
| | 130 | 11/11 → 12/15 | 1.968 | D | M | 4 | 16 | CGLC, CMGB | | 84001 |
| 2.0 TDI quattro | 100 | 09/09 → | 1.968 | D | M | 4 | 16 | CAGB, CJCB, CSUB | | 81816 |
| | 100 | 09/09 → | 1.968 | D | M | 4 | 16 | CAGB, CJCB, CSUB | | 84011 NEW |
| | 105 | 11/08 → 12/15 | 1.968 | D | M | 4 | 16 | CAGA, CJCA | | 81816 |
| | 105 | 11/08 → 12/15 | 1.968 | D | M | 4 | 16 | CAGA, CJCA | | 84011 NEW |
| | 120 | 04/09 → | 1.968 | D | M | 4 | 16 | CAHB, CGLD, CNHC | | 81816 |
| | 120 | 04/09 → | 1.968 | D | M | 4 | 16 | CAHB, CGLD, CNHC | | 84011 NEW |
| | 125 | 01/08 → 03/12 | 1.968 | D | M | 4 | 16 | CAHA | | 81816 |
| | 125 | 01/08 → 03/12 | 1.968 | D | M | 4 | 16 | CAHA | | 84011 NEW |
| | 130 | 11/11 → 12/15 | 1.968 | D | M | 4 | 16 | CGLC | | 84001 |
| 2.0 TFSI | 132 | 06/08 → 12/15 | 1.984 | B | M | 4 | 16 | CAEA, CDN, CFKA | | 84016 NEW |
| | 155 | 06/08 → 05/13 | 1.984 | B | M | 4 | 16 | CAEB, CDNC | | 84016 NEW |
| | 165 | 05/13 → 12/15 | 1.984 | B | M | 4 | 16 | CNCD | | 84037 NEW |
| 2.0 TFSI flexible fuel | 132 | 11/09 → 12/15 | 1.984 | | M | 4 | 16 | CFKA | | 84016 NEW |
| 2.0 TFSI flexible fuel quattro | 132 | 11/09 → 12/15 | 1.984 | | M | 4 | 16 | CFKA | | 84016 NEW |
| 2.0 TFSI quattro | 155 | 06/08 → 12/15 | 1.984 | B | M | 4 | 16 | CAEB, CDNC | | 84016 NEW |
| | 155 | 06/08 → 12/15 | 1.984 | B | M | 4 | 16 | CAEB, CDNC, CPMA | | 84016 NEW |
| | 155 | 04/09 → | 1.984 | B | M | 4 | 16 | CDNC, CPMA | | 84016 NEW |
| | 162 | 05/13 → 12/15 | 1.984 | B | M | 4 | 16 | CAED, CPMB | | 84016 NEW |
| | 162 | 05/13 → | 1.984 | B | M | 4 | 16 | CPMB | | 84016 NEW |
| | 165 | 05/13 → 12/15 | 1.984 | B | M | 4 | 16 | CNCD | | 84037 NEW |
| 2.7 TDI | 120 | 11/07 → 03/12 | 2.698 | D | M | 6 | 24 | CAMB, CGKB | | 82015 |
| | 140 | 11/07 → 03/12 | 2.698 | D | M | 6 | 24 | CAMA, CGKA | | 82015 |
| 3.0 TDI | 150 | 11/11 → 12/15 | 2.967 | D | M | 6 | 24 | CLAB | | 84021 NEW |
| 3.0 TDI quattro | 155 | 06/08 → 05/10 | 2.967 | D | M | 6 | 24 | CCWB | | 82015 |
| | 176 | 11/07 → 03/12 | 2.967 | D | M | 6 | 24 | CAPA, CCLA, CCWA | | 82015 |
| | 176 | 04/09 → | 2.967 | D | M | 6 | 24 | CCWA | | 82015 |
| | 180 | 11/11 → 12/15 | 2.967 | D | M | 6 | 24 | CDUC, CKVB, CKVC | | 84021 NEW |

KW

cm³

NO. OF VALVES

MAGNETI MARELLI
AUDI
A4 IV, Avant, Allroad

| | | | | | | | | | | | |
|------------|-----|---------------|-------|---|---|---|----|------------------------------------|--|-------|--|
| S4 quattro | 245 | 11/08 → 12/15 | 2.995 | B | M | 6 | 24 | CAKA, CCBA, CGWC, CGXC, CREC, CTUB | | 82015 | |
|------------|-----|---------------|-------|---|---|---|----|------------------------------------|--|-------|--|

A4 V, Avant, Allroad

| | | | | | | | | | | | |
|------------------|-----|---------|-------|---|---|---|----|------------|--|-------|------------|
| 1.4 TFSI | 110 | 08/15 → | 1.395 | B | M | 4 | 16 | CVNA | | 84062 | NEW |
| 2.0 TFSI | 140 | 05/15 → | 1.984 | B | M | 4 | 16 | CVKB | | 84037 | NEW |
| | 183 | 11/15 → | 1.984 | B | M | 4 | 16 | CYRC | | 84037 | NEW |
| | 185 | 05/15 → | 1.984 | B | M | 4 | 16 | CYMC, CYRB | | 84037 | NEW |
| 2.0 TFSI quattro | 183 | 11/15 → | 1.984 | B | M | 4 | 16 | CYRC | | 84037 | NEW |
| | 185 | 05/15 → | 1.984 | B | M | 4 | 16 | CYMC, CYRB | | 84037 | NEW |
| | 185 | 08/15 → | 1.984 | B | M | 4 | 16 | CYRB | | 84037 | NEW |

A5, Sportback, Cabriolet

| | | | | | | | | | | | |
|-----------------|---------|---------|-------|---|---|----|------|------------------------|-----------|------------|------------|
| 1.8 TFSI | 106 | 09/14 → | 1.798 | B | M | 4 | 16 | CJED | | 84037 | NEW |
| | 118 | 05/09 → | 1.798 | B | M | 4 | 16 | CDHB | | 84016 | NEW |
| | 125 | 10/07 → | 1.798 | B | M | 4 | 16 | CABD, CJEB | | 84016 | NEW |
| | 125 | 10/11 → | 1.798 | B | M | 4 | 16 | CABD, CJEB | | 84037 | NEW |
| | 125 | 08/11 → | 1.798 | B | M | 4 | 16 | CJEB | | 84037 | NEW |
| | 130 | 05/15 → | 1.798 | B | M | 4 | 16 | CJEE | | 84037 | NEW |
| 2.0 TDI | 100 | 09/09 → | 1.968 | D | M | 4 | 16 | CAGB, CJCB | | 81816 | |
| | 100 | 09/09 → | 1.968 | D | M | 4 | 16 | CAGB, CJCB | | 84011 | NEW |
| | 105 | 09/09 → | 1.968 | D | M | 4 | 16 | CAGA, CJCA, CMEA, CMFA | | 81816 | |
| | 105 | 09/09 → | 1.968 | D | M | 4 | 16 | CAGA, CJCA, CMEA, CMFA | | 84011 | NEW |
| | 105 | 10/11 → | 1.968 | D | M | 4 | 16 | CJCA | | 84001 | |
| | 110 | 05/13 → | 1.968 | D | M | 4 | 16 | CJCD | | 84001 | |
| | 120 | 08/08 → | 1.968 | D | M | 4 | 16 | CAHB, CGLD | | 81816 | |
| | 120 | 08/08 → | 1.968 | D | M | 4 | 16 | CAHB, CGLD | | 84011 | NEW |
| | 125 | 08/08 → | 1.968 | D | M | 4 | 16 | CAHA | | 81816 | |
| | 125 | 08/08 → | 1.968 | D | M | 4 | 16 | CAHA | | 84011 | NEW |
| 2.0 TDI quattro | 130 | 10/11 → | 1.968 | D | M | 4 | 16 | CGLC | | 84001 | |
| | 125 | 08/08 → | 1.968 | D | M | 4 | 16 | CAHA | | 81816 | |
| | 125 | 08/08 → | 1.968 | D | M | 4 | 16 | CAHA | | 84011 | NEW |
| 2.0 TFSI | 132 | 03/09 → | 1.984 | B | M | 4 | 16 | CAEA, CDNB | | 84016 | NEW |
| | 132 | 11/08 → | 1.984 | B | M | 4 | 16 | CDNB | | 84016 | NEW |
| | 155 | 03/09 → | 1.984 | B | M | 4 | 16 | CAEB, CDNC | → 07-2011 | 84016 | NEW |
| | 155 | 03/09 → | 1.984 | B | M | 4 | 16 | CAEB, CDNC | 08-2011 → | 84037 | NEW |
| | 155 | 06/08 → | 1.984 | B | M | 4 | 16 | CDNC | → 07-2011 | 84016 | NEW |
| | 155 | 06/08 → | 1.984 | B | M | 4 | 16 | CDNC | 08-2011 → | 84037 | NEW |
| | 162 | 05/13 → | 1.984 | B | M | 4 | 16 | CAED | | 84016 | NEW |
| | 165 | 05/13 → | 1.984 | B | M | 4 | 16 | CNCD | | 84016 | NEW |
| 169 | 08/15 → | 1.984 | B | M | 4 | 16 | CNCE | | 84037 | NEW | |

KW

cm³

NO. OF VALVES

MAGNETI MARELLI
AUDI
A5, Sportback, Cabriolet

| | | | | | | | | | | | |
|------------------|-----|---------|-------|---|---|---|----|--|-----------|-------|------------|
| 2.0 TFSI quattro | 155 | 06/08 → | 1.984 | B | M | 4 | 16 | CAEB, CDNC | → 07-2011 | 84016 | NEW |
| | 155 | 06/08 → | 1.984 | B | M | 4 | 16 | CAEB, CDNC | 08-2011 → | 84037 | NEW |
| | 155 | 09/09 → | 1.984 | B | M | 4 | 16 | CDNC | → 07-2011 | 84016 | NEW |
| | 155 | 09/09 → | 1.984 | B | M | 4 | 16 | CDNC | 08-2011 → | 84037 | NEW |
| | 162 | 03/12 → | 1.984 | B | M | 4 | 16 | CAED, CPMB | | 84016 | NEW |
| | 165 | 05/13 → | 1.984 | B | M | 4 | 16 | CNCD | | 84016 | NEW |
| | 169 | 08/15 → | 1.984 | B | M | 4 | 16 | CNCE | | 84037 | NEW |
| 2.7 TDI | 120 | 09/07 → | 2.698 | D | M | 6 | 24 | CAMB, CGKB | | 82015 | |
| | 120 | 05/09 → | 2.698 | D | M | 6 | 24 | CGKB | | 82015 | |
| | 140 | 06/07 → | 2.698 | D | M | 6 | 24 | CAMA, CGKA | | 82015 | |
| | 140 | 03/09 → | 2.698 | D | M | 6 | 24 | CGKA | | 82015 | |
| 3.0 TDI | 150 | 10/11 → | 2.967 | D | M | 6 | 24 | CLAB | | 84021 | NEW |
| 3.0 TDI quattro | 155 | 03/08 → | 2.967 | D | M | 6 | 24 | CCWB | | 82015 | |
| | 176 | 06/07 → | 2.967 | D | M | 6 | 24 | CAPA, CCWA | | 82015 | |
| | 176 | 03/09 → | 2.967 | D | M | 6 | 24 | CCWA | | 82015 | |
| | 180 | 10/11 → | 2.967 | D | M | 6 | 24 | CDUC, CKVB, CKVC | | 84021 | NEW |
| | 180 | 10/11 → | 2.967 | D | M | 6 | 24 | CDUC, CKVC | | 84021 | NEW |
| S5 quattro | 245 | 06/09 → | 2.995 | B | M | 6 | 24 | CAKA, CCBA, CGWC, CGXC, CREC, CTDA, CTUB | | 82015 | |
| | 245 | 10/11 → | 2.995 | B | M | 6 | 24 | CAKA, CGWC, CGXC, CREC, CTDA, CTUB | | 82015 | |

A6 I, Avant

| | | | | | | | | | | | |
|-----------------|-----|---------------|-------|---|---|---|----|---------|---------------|-------|--|
| 1.8 | 92 | 12/95 → 10/97 | 1.781 | B | M | 4 | 20 | ADR | (-)COP | 81526 | |
| | 92 | 12/95 → 10/97 | 1.781 | B | M | 4 | 20 | ADR | (+)COP | 81529 | |
| 1.8 quattro | 92 | 12/95 → 10/97 | 1.781 | B | M | 4 | 20 | ADR | (-)COP | 81526 | |
| | 92 | 12/95 → 10/97 | 1.781 | B | M | 4 | 20 | ADR | (+)COP | 81529 | |
| 1.9 TDI | 66 | 06/94 → 10/97 | 1.896 | D | M | 4 | 8 | 1Z, AHU | (-)COP, M: 1Z | 81522 | |
| | 66 | 06/94 → 10/97 | 1.896 | D | M | 4 | 8 | 1Z, AHU | (+)COP | 82080 | |
| | 66 | 06/94 → 10/97 | 1.896 | D | M | 4 | 8 | 1Z, AHU | (+)COP, M: 1Z | 82080 | |
| | 66 | 06/94 → 10/97 | 1.896 | D | M | 4 | 8 | 1Z, AHU | M: AHU | 81528 | |
| 2.0 | 74 | 06/94 → 10/97 | 1.984 | B | M | 4 | 8 | AAE | (-)COP | 81522 | |
| | 74 | 06/94 → 10/97 | 1.984 | B | M | 4 | 8 | AAE | (+)COP | 82080 | |
| | 79 | 08/95 → 07/96 | 1.984 | B | M | 4 | 8 | ADW | (-)COP | 81522 | |
| | 79 | 08/95 → 07/96 | 1.984 | B | M | 4 | 8 | ADW | (+)COP | 82080 | |
| | 85 | 06/94 → 10/97 | 1.984 | B | M | 4 | 8 | ABK | (-)COP | 81522 | |
| | 85 | 06/94 → 10/97 | 1.984 | B | M | 4 | 8 | ABK | (+)COP | 82080 | |
| 2.0 16V | 103 | 06/94 → 10/97 | 1.984 | B | M | 4 | 16 | ACE | (-)COP | 81522 | |
| | 103 | 06/94 → 10/97 | 1.984 | B | M | 4 | 16 | ACE | (+)COP | 82080 | |
| 2.0 16V quattro | 103 | 06/94 → 10/97 | 1.984 | B | M | 4 | 16 | ACE | (-)COP | 81522 | |
| | 103 | 06/94 → 10/97 | 1.984 | B | M | 4 | 16 | ACE | (+)COP | 82080 | |
| 2.3 | 98 | 06/94 → 12/95 | 2.309 | B | M | 5 | 10 | AAR | | 81700 | |
| 2.3 quattro | 98 | 06/94 → 12/95 | 2.309 | B | M | 5 | 10 | AAR | | 81700 | |
| 2.4 | 110 | 07/95 → 06/96 | 2.393 | B | M | 6 | 12 | AFM | | 81842 | |

KW

cm³

NO. OF VALVES

AUDI
A6 I, Avant

| | | | | | | | | | | |
|---------------------|-----|---------------|-------|---|---|---|----|--------------------|--|-------|
| 2.5 TDI | 84 | 01/95 → 10/97 | 2.461 | D | M | 5 | 10 | AAT | | 81701 |
| | 85 | 06/94 → 10/97 | 2.461 | D | M | 5 | 10 | AAT | | 81701 |
| | 103 | 08/94 → 10/97 | 2.461 | D | M | 5 | 10 | AEL | | 81701 |
| 2.5 TDI quattro | 103 | 10/95 → 10/97 | 2.461 | D | M | 5 | 10 | AEL | | 81701 |
| 2.6 | 102 | 06/94 → 02/97 | 2.598 | B | M | 6 | 12 | ACZ | (+)COP, 08-1996 →, → 02-1997, T →: F44-S-026.715 | 81529 |
| | 102 | 06/94 → 10/97 | 2.598 | B | M | 6 | 12 | ACZ | 08-1996 →, → 02-1997, T →: F44-S-026-715 | 81842 |
| | 110 | 06/94 → 10/97 | 2.598 | B | M | 6 | 12 | ABC | 08-1996 →, → 02-1997, T →: F44-S-026-715 | 81842 |
| | 110 | 06/94 → 12/97 | 2.598 | B | M | 6 | 12 | ABC | 08-1996 →, → 12-1997, T →: F44-S-026.715 | 81842 |
| 2.6 quattro | 110 | 06/94 → 10/97 | 2.598 | B | M | 6 | 12 | ABC | 08-1996 →, → 02-1997, T →: F44-S-026-715 | 81842 |
| | 110 | 06/94 → 12/97 | 2.598 | B | M | 6 | 12 | ABC | 08-1996 →, → 12-1997, T →: F44-S-026.715 | 81842 |
| 2.8 | 128 | 06/94 → 12/97 | 2.771 | B | M | 6 | 12 | AAH, AEJ | 08-1996 →, → 12-1997, T →: F44-S-026.715 | 81842 |
| | 128 | 06/94 → 10/97 | 2.771 | B | M | 6 | 12 | AAH, AEJ, AFC | 08-1996 →, → 02-1997, T →: F44-S-026.715 | 81842 |
| | 142 | 12/95 → 10/97 | 2.771 | B | M | 6 | 30 | ACK | T →: F44-S-026.715 | 81842 |
| 2.8 quattro | 128 | 06/94 → 10/97 | 2.771 | B | M | 6 | 12 | AAH, AEJ | 08-1996 →, → 02-1997, T →: F44-S-026.715 | 81842 |
| | 128 | 06/94 → 12/97 | 2.771 | B | M | 6 | 12 | AAH, AEJ | 08-1996 →, → 12-1997, T →: F44-S-026.715 | 81842 |
| | 142 | 12/95 → 10/97 | 2.771 | B | M | 6 | 30 | ACK | | 81842 |
| | 142 | 12/95 → 12/97 | 2.771 | B | M | 6 | 30 | ACK | T →: F44-S-026.715 | 81842 |
| S6 Turbo quattro | 169 | 06/94 → 10/97 | 2.226 | B | M | 5 | 20 | AAN | | 81700 |
| A6 II, Avant | | | | | | | | | | |
| | 85 | 05/97 → 01/05 | 1.781 | B | M | 4 | 20 | AFY | (-)COP | 81526 |
| | 85 | 05/97 → 01/05 | 1.781 | B | M | 4 | 20 | AFY | (+)COP | 81529 |
| | 92 | 07/97 → 01/05 | 1.781 | B | M | 4 | 20 | AJP, ANQ, AQE, ARH | | 81702 |
| | 92 | 12/97 → 01/05 | 1.781 | B | M | 4 | 20 | AJP, AQE, ARH | | 81702 |



KW

cm³

NO. OF VALVES

AUDI
A6 II, Avant

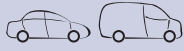
| | | | | | | | | | | |
|---------------|-----|---------------|-------|---|----|---|----|------------------------------|---------------------------------|------------------|
| 1.8 T | 110 | 01/97 → 01/05 | 1.781 | B | M | 4 | 20 | AEB, ANB, APU, ARK, AWL, AWT | (-)COP, NOT FOR: M AWT | 81526 |
| | 110 | 01/97 → 01/05 | 1.781 | B | M | 4 | 20 | AEB, ANB, APU, ARK, AWL, AWT | (+)COP, NOT FOR: M AWT | 81529 |
| | 110 | 01/97 → 01/05 | 1.781 | B | M | 4 | 20 | AEB, ANB, APU, ARK, AWL, AWT | 05-2000 →, → 07-2004, M: AWT | 81703 |
| | 110 | 12/97 → 01/05 | 1.781 | B | M | 4 | 20 | AEB, ANB, APU, ARK, AWT | (-)COP, NOT FOR: M AWT | 81526 |
| | 110 | 12/97 → 01/05 | 1.781 | B | M | 4 | 20 | AEB, ANB, APU, ARK, AWT | (+)COP, NOT FOR: M AWT | 81529 |
| | 110 | 12/97 → 01/05 | 1.781 | B | M | 4 | 20 | AEB, ANB, APU, ARK, AWT | 02-2000 →, → 07-2004, M: AWT | 81703 |
| | 132 | 12/97 → 01/05 | 1.781 | B | M | 4 | 20 | AJL | (-)COP | 81526 |
| | 132 | 12/97 → 01/05 | 1.781 | B | M | 4 | 20 | AJL | (+)COP | 81529 |
| 1.8 T quattro | 110 | 02/97 → 01/05 | 1.781 | B | M | 4 | 20 | AEB, ANB, APU, ARK, AWT | (-)COP, NOT FOR: M AWT | 81526 |
| | 110 | 02/97 → 01/05 | 1.781 | B | M | 4 | 20 | AEB, ANB, APU, ARK, AWT | (+)COP, NOT FOR: M AWT | 81529 |
| | 110 | 02/97 → 01/05 | 1.781 | B | M | 4 | 20 | AEB, ANB, APU, ARK, AWT | 05-2000 →, → 07-2004, M: AWT | 81703 |
| | 132 | 12/97 → 01/05 | 1.781 | B | M | 4 | 20 | AJL | (-)COP | 81526 |
| | 132 | 12/97 → 01/05 | 1.781 | B | M | 4 | 20 | AJL | (+)COP | 81529 |
| 1.9 TDI | 81 | 04/97 → 10/00 | 1.896 | D | M | 4 | 8 | AFN, AVG | | 81528 |
| | 85 | 07/00 → 01/05 | 1.896 | D | M | 4 | 8 | AJM | | 81816 |
| | 85 | 07/00 → 01/05 | 1.896 | D | M | 4 | 8 | AJM | | 84011 NEW |
| | 96 | 08/01 → 01/05 | 1.896 | D | M | 4 | 8 | AVF, AWX | | 81816 |
| | 96 | 08/01 → 01/05 | 1.896 | D | M | 4 | 8 | AVF, AWX | | 84011 NEW |
| 2.0 | 96 | 08/01 → 01/05 | 1.984 | B | M | 4 | 20 | ALT | | 81702 |
| 2.4 | 100 | 07/98 → 01/05 | 2.393 | B | M | 6 | 30 | ALW, ARN, ASM | | 81842 |
| | 115 | 02/97 → 01/05 | 2.393 | B | M | 6 | 30 | APC | | 81842 |
| | 120 | 02/97 → 01/05 | 2.393 | B | M | 6 | 30 | AJG, AMM, APZ | | 81842 |
| | 121 | 02/97 → 01/05 | 2.393 | B | M | 6 | 30 | AGA, ALF, AML, APS, ARJ | | 81842 |
| | 121 | 12/97 → 01/05 | 2.393 | B | M | 6 | 30 | AGA, ALF, AML, APS, ARJ | T →: F44-S-026.715 | 81842 |
| | 125 | 08/01 → 01/05 | 2.393 | B | AM | 6 | 30 | BDV | | 81842 |
| 2.4 quattro | 115 | 08/98 → 07/99 | 2.393 | B | M | 6 | 30 | APC | | 81842 |
| | 120 | 02/97 → 01/05 | 2.393 | B | M | 6 | 30 | AJG, APZ | | 81842 |
| | 121 | 02/97 → 01/05 | 2.393 | B | M | 6 | 30 | AGA, ALF, AML, APS, ARJ | | 81842 |
| | 121 | 12/97 → 01/05 | 2.393 | B | M | 6 | 30 | AGA, ALF, AML, APS, ARJ | T →: F44-S-026.715 | 81842 |
| | 125 | 08/01 → 01/05 | 2.393 | B | AM | 6 | 30 | BDV | | 81842 |

KW

cm³

NO. OF VALVES

MAGNETI MARELLI
AUDI
A6 II, Avant

| | | | | | | | | | | |
|------------------|-----|---------------|-------|---|---|---|----|------------------------------|--------------------|-------|
| 2.5 TDI | 110 | 07/97 → 01/05 | 2.496 | D | M | 6 | 24 | AFB, AKN | | 81705 |
| | 114 | 08/01 → 01/05 | 2.496 | D | M | 6 | 24 | AYM | | 81705 |
| | 120 | 07/02 → 01/05 | 2.496 | D | M | 6 | 24 | BCZ, BDG, BFC | | 81705 |
| | 132 | 02/00 → 01/05 | 2.496 | D | M | 6 | 24 | AKE, BAU, BDH | | 81705 |
| | 132 | 02/00 → 01/05 | 2.496 | D | M | 6 | 24 | AKE, BAU, BDH, BND | | 81705 |
| 2.5 TDI quattro | 110 | 07/97 → 01/05 | 2.496 | D | M | 6 | 24 | AFB, AKN | | 81705 |
| | 132 | 02/00 → 01/05 | 2.496 | D | M | 6 | 24 | AKE, BAU, BDH | | 81705 |
| 2.7 | 187 | 05/01 → 07/04 | 2.671 | B | M | 6 | 30 | APB, BEL | | 81842 |
| 2.7 quattro | 187 | 05/01 → 07/04 | 2.671 | B | M | 6 | 30 | APB, BEL | | 81842 |
| | 195 | 11/03 → 07/04 | 2.671 | B | M | 6 | 30 | BEL | | 81842 |
| 2.7 T | 169 | 02/99 → 01/05 | 2.671 | B | M | 6 | 30 | AJK | T →: F44-S-026.715 | 81842 |
| | 169 | 02/99 → 01/05 | 2.671 | B | M | 6 | 30 | AJK | | 81842 |
| 2.7 T quattro | 169 | 12/97 → 01/05 | 2.671 | B | M | 6 | 30 | AJK, AZA | 01-1999 → | 81842 |
| | 169 | 12/97 → 01/05 | 2.671 | B | M | 6 | 30 | AJK, AZA | T →: F44-S-026.715 | 81842 |
| | 169 | 12/97 → 01/05 | 2.671 | B | M | 6 | 30 | AJK, AZA | | 81842 |
| | 184 | 08/01 → 01/05 | 2.671 | B | M | 6 | 30 | ARE, BES | | 81842 |
| 2.8 | 132 | 10/97 → 05/00 | 2.771 | B | M | 6 | 30 | AGE | | 81842 |
| | 140 | 07/99 → 01/05 | 2.771 | B | M | 6 | 30 | ATX | | 81842 |
| | 140 | 07/99 → 01/05 | 2.771 | B | M | 6 | 30 | ATX, BBG | | 81842 |
| | 142 | 02/97 → 01/05 | 2.771 | B | M | 6 | 30 | ACK, AHA, ALG, AMX, APR, AQD | T →: F44-S-026.715 | 81842 |
| | 142 | 02/97 → 01/05 | 2.771 | B | M | 6 | 30 | ACK, AHA, ALG, AMX, APR, AQD | | 81842 |
| 2.8 quattro | 132 | 01/98 → 04/00 | 2.771 | B | M | 6 | 30 | AGE | | 81842 |
| | 140 | 07/99 → 05/01 | 2.771 | B | M | 6 | 30 | ATX | | 81842 |
| | 142 | 02/97 → 01/05 | 2.771 | B | M | 6 | 30 | ACK, AHA, ALG, AMX, APR, AQD | T →: F44-S-026.715 | 81842 |
| | 142 | 02/97 → 01/05 | 2.771 | B | M | 6 | 30 | ACK, AHA, ALG, AMX, APR, AQD | | 81842 |
| 3.0 | 162 | 08/01 → 01/05 | 2.976 | B | M | 6 | 30 | ASN | | 81819 |
| 3.0 quattro | 160 | 06/01 → 07/04 | 2.976 | B | M | 6 | 30 | BBJ | | 81819 |
| | 162 | 08/01 → 01/05 | 2.976 | B | M | 6 | 30 | ASN | | 81819 |
| 3.7 | 191 | 03/99 → 01/05 | 3.697 | B | A | 8 | 40 | AQG | | 82081 |
| 3.7 quattro | 191 | 03/99 → 01/05 | 3.697 | B | A | 8 | 40 | AQG | | 82081 |
| 4.2 quattro | 220 | 11/98 → 01/05 | 4.172 | B | M | 8 | 40 | ARS, ASG, AWN | 04-1999 → | 82081 |
| | 220 | 11/98 → 01/05 | 4.172 | B | M | 8 | 40 | ARS, ASG, AWN | | 82081 |
| RS6 plus quattro | 353 | 04/04 → 01/05 | 4.172 | B | M | 8 | 40 | BRV | | 82081 |
| RS6 quattro | 331 | 07/02 → 01/05 | 4.172 | B | M | 8 | 40 | BCY | | 82081 |
| S6 quattro | 250 | 09/99 → 01/05 | 4.172 | B | M | 8 | 40 | ANK, AQJ | 04-1999 → | 82081 |
| | 250 | 09/99 → 01/05 | 4.172 | B | M | 8 | 40 | ANK, AQJ | | 82081 |

KW

cm³

NO. OF VALVES

AUDI
A6 III, Avant, Allroad

| | | | | | | | | | | | |
|------------------------------|---------------|---------------|-------|---|---|----|------|----------------|-----------|------------|------------|
| 2.0 TDI | 89 | 09/05 → 06/06 | 1.968 | D | M | 4 | 16 | BVG | | 81816 | |
| | 89 | 09/05 → 06/06 | 1.968 | D | M | 4 | 16 | BVG | | 84011 | NEW |
| | 100 | 07/04 → 03/11 | 1.968 | D | M | 4 | 16 | BNA, BRF, CAGB | | 81816 | |
| | 100 | 07/04 → 03/11 | 1.968 | D | M | 4 | 16 | BNA, BRF, CAGB | | 84011 | NEW |
| | 103 | 07/04 → 10/08 | 1.968 | D | M | 4 | 16 | BLB, BRE | | 81816 | |
| | 103 | 07/04 → 10/08 | 1.968 | D | M | 4 | 16 | BLB, BRE | | 84011 | NEW |
| | 120 | 04/09 → 03/11 | 1.968 | D | M | 4 | 16 | CAHB | | 81816 | |
| | 120 | 04/09 → 03/11 | 1.968 | D | M | 4 | 16 | CAHB | | 84011 | NEW |
| | 125 | 11/08 → 03/11 | 1.968 | D | M | 4 | 16 | CAHA | | 81816 | |
| 125 | 11/08 → 03/11 | 1.968 | D | M | 4 | 16 | CAHA | | 84011 | NEW | |
| 2.0 TFSI | 125 | 06/05 → 08/11 | 1.984 | B | M | 4 | 16 | BPJ | | 82025 | |
| | 125 | 06/05 → 03/11 | 1.984 | B | M | 4 | 16 | BPJ, BYK | | 82025 | |
| 2.4 | 130 | 05/04 → 10/08 | 2.393 | B | M | 6 | 24 | BDW | | 82015 | |
| 2.4 quattro | 130 | 01/05 → 10/08 | 2.393 | B | M | 6 | 24 | BDW | | 82015 | |
| 2.7 TDI | 120 | 11/04 → 03/11 | 2.698 | D | M | 6 | 24 | BSG, CANB | | 82015 | |
| | 132 | 11/04 → 10/08 | 2.698 | D | M | 6 | 24 | BPP | | 82015 | |
| | 140 | 10/08 → 03/11 | 2.698 | D | M | 6 | 24 | CANA | | 82015 | |
| 2.7 TDI quattro | 120 | 06/05 → 03/11 | 2.698 | D | M | 6 | 24 | BSG, CAND | | 82015 | |
| | 132 | 11/04 → 10/08 | 2.698 | D | M | 6 | 24 | BPP | | 82015 | |
| | 140 | 10/08 → 03/11 | 2.698 | D | M | 6 | 24 | CANC | | 82015 | |
| 3.0 | 160 | 08/04 → 05/06 | 2.976 | B | M | 6 | 30 | BBJ | | 81819 | |
| 3.0 quattro | 160 | 05/04 → 05/06 | 2.976 | B | M | 6 | 30 | BBJ | | 81819 | |
| 3.0 TDI | 171 | 06/06 → 03/11 | 2.967 | D | M | 6 | 24 | ASB | | 82015 | |
| 3.0 TDI quattro | 155 | 05/04 → 03/11 | 2.967 | D | M | 6 | 24 | BNG, CDYB | | 82015 | |
| | 165 | 05/04 → 05/06 | 2.967 | D | M | 6 | 24 | BMK | | 82015 | |
| | 171 | 06/06 → 10/08 | 2.967 | D | M | 6 | 24 | ASB | | 82015 | |
| | 176 | 10/08 → 03/11 | 2.967 | D | M | 6 | 24 | CDYA, CDYC | | 82015 | |
| 3.0 TFSI quattro | 213 | 10/08 → 03/11 | 2.995 | B | M | 6 | 24 | CAJA | → 02-2009 | 82015 | |
| | 213 | 10/08 → 08/11 | 2.995 | B | M | 6 | 24 | CAJA | | 82015 | |
| | 220 | 10/08 → 03/11 | 2.995 | B | M | 6 | 24 | CCAA | | 82015 | |
| 3.2 FSI | 188 | 03/05 → 10/08 | 3.123 | B | M | 6 | 24 | AUK | | 82015 | |
| | 188 | 05/04 → 05/09 | 3.123 | B | M | 6 | 24 | AUK, BKH | | 82015 | |
| | 195 | 05/09 → 03/11 | 3.197 | B | M | 6 | 24 | CALA | | 82015 | |
| 3.2 FSI quattro | 183 | 09/06 → 10/08 | 3.123 | B | M | 6 | 24 | BYU | | 82015 | |
| | 188 | 05/06 → 10/08 | 3.123 | B | M | 6 | 24 | AUK | | 82015 | |
| | 188 | 05/04 → 10/08 | 3.123 | B | M | 6 | 24 | AUK, BKH | | 82015 | |
| 4.2 quattro | 246 | 05/04 → 05/06 | 4.163 | B | M | 8 | 40 | BAT | | 82046 | |
| A6 IV, Avant, Allroad | | | | | | | | | | | |
| 1.8 TFSI | 140 | 09/14 → | 1.798 | B | M | 4 | 16 | CYGA | | 84037 | NEW |
| 2.0 TDI | 100 | 01/12 → | 1.968 | D | M | 4 | 16 | CGLG, CSUE | | 84001 | |
| | 120 | 03/11 → | 1.968 | D | M | 4 | 16 | CGLD | | 84001 | |
| | 130 | 03/11 → | 1.968 | D | M | 4 | 16 | CGLC, CMGB | | 84001 | |

KW

cm³

NO. OF VALVES

MAGNETI MARELLI
AUDI
A6 IV, Avant, Allroad

| | | | | | | | | | | | |
|------------------|-----|---------------|-------|---|---|---|----|------------|--|-------|------------|
| 2.0 TFSI | 132 | 05/11 → | 1.984 | B | M | 4 | 16 | CDNB | | 84016 | NEW |
| | 155 | 03/11 → 05/13 | 1.984 | B | M | 4 | 16 | CAEB | | 84016 | NEW |
| | 185 | 09/14 → | 1.984 | B | M | 4 | 16 | CYNB, CYPA | | 84037 | NEW |
| 2.0 TFSI hybrid | 155 | 11/11 → | 1.984 | | M | 4 | 16 | CHJA | | 84016 | NEW |
| 2.0 TFSI quattro | 183 | 05/15 → | 1.984 | B | M | 4 | 16 | CYPB | | 84037 | NEW |
| | 185 | 05/14 → | 1.984 | B | M | 4 | 16 | CYNB, CYPA | | 84037 | NEW |
| | 185 | 05/15 → | 1.984 | B | M | 4 | 16 | CYPA | | 84037 | NEW |
| 3.0 TDI | 150 | 11/10 → | 2.967 | D | M | 6 | 24 | CLAB | | 84021 | NEW |
| 3.0 TDI quattro | 150 | 03/11 → | 2.967 | D | M | 6 | 24 | CLAA | | 84021 | NEW |

A7

| | | | | | | | | | | | |
|------------------|-----|---------|-------|---|---|---|----|------------------------|------------------|-------|------------|
| 1.8 TFSI | 140 | 04/15 → | 1.798 | B | M | 4 | 16 | CYGA | | 84037 | NEW |
| 2.0 TFSI | 185 | 09/14 → | 1.984 | B | M | 4 | 16 | CYPA | | 84037 | NEW |
| 2.0 TFSI quattro | 183 | 05/15 → | 1.984 | B | M | 4 | 16 | CYPB | | 84037 | NEW |
| | 185 | 05/15 → | 1.984 | B | M | 4 | 16 | CYNB, CYPA | | 84037 | NEW |
| 3.0 TDI | 150 | 11/10 → | 2.967 | D | M | 6 | 24 | CLAB | | 84021 | NEW |
| 3.0 TDI quattro | 150 | 12/10 → | 2.967 | D | M | 6 | 24 | CLAA | | 84021 | NEW |
| | 180 | 10/10 → | 2.967 | D | M | 6 | 24 | CDUC, CDUD, CKVB, CKVC | M: CDUD, M: CDUC | 84021 | NEW |

A8 I

| | | | | | | | | | | | |
|-----------------|-----|---------------|-------|---|---|---|----|-------------------------|--------------------|-------|--|
| 2.5 TDI | 110 | 01/97 → 04/00 | 2.496 | D | M | 6 | 24 | AFB, AKN | | 81705 | |
| | 132 | 09/00 → 09/02 | 2.496 | D | M | 6 | 24 | AKE | | 81705 | |
| 2.5 TDI quattro | 110 | 07/97 → 04/00 | 2.496 | D | M | 6 | 24 | AFB, AKN | | 81705 | |
| | 132 | 09/00 → 09/02 | 2.496 | D | M | 6 | 24 | AKE | | 81705 | |
| 2.8 | 142 | 04/96 → 09/02 | 2.771 | B | M | 6 | 30 | ACK, ALG, AMX, APR, AQD | T →: F4D-S-000.497 | 81842 | |
| 2.8 quattro | 142 | 04/96 → 09/02 | 2.771 | B | M | 6 | 30 | ACK, AMX, APR, AQD | T →: F4D-S-000.497 | 81842 | |
| 3.3 TDI quattro | 165 | 06/00 → 09/02 | 3.328 | D | M | 8 | 40 | AKF | | 82041 | |
| 3.7 | 191 | 11/98 → 09/02 | 3.697 | B | A | 8 | 40 | AKC, AQQ | | 82081 | |
| 3.7 quattro | 191 | 11/98 → 09/02 | 3.697 | B | A | 8 | 40 | AKC, AQQ | | 82081 | |
| 4.2 quattro | 175 | 02/99 → 04/00 | 4.172 | B | M | 8 | 32 | ARU | | 82081 | |
| | 228 | 11/98 → 09/02 | 4.172 | B | M | 8 | 40 | AQF, AUW, AUX | | 82081 | |
| S 8 quattro | 265 | 06/99 → 09/02 | 4.172 | B | A | 8 | 40 | AQH, AVP | | 82081 | |

A8 II

| | | | | | | | | | | | |
|-----------------|-----|---------------|-------|---|---|---|----|-----|--|-------|--|
| 3.0 | 160 | 07/03 → 05/06 | 2.976 | B | M | 6 | 30 | BBJ | | 81819 | |
| | 162 | 07/03 → 05/05 | 2.976 | B | M | 6 | 30 | ASN | | 81819 | |
| 3.0 quattro | 160 | 11/03 → 05/04 | 2.976 | B | M | 6 | 30 | BBJ | | 81819 | |
| 3.0 TDI quattro | 155 | 11/03 → 07/10 | 2.967 | D | M | 6 | 24 | BNG | | 82015 | |
| | 171 | 08/03 → 07/10 | 2.967 | D | M | 6 | 24 | ASB | | 82015 | |
| 3.2 FSI | 191 | 06/05 → 07/10 | 3.123 | B | M | 6 | 24 | BPK | | 82015 | |
| 3.2 FSI quattro | 191 | 06/05 → 07/10 | 3.123 | B | M | 6 | 24 | BPK | | 82015 | |
| 3.7 quattro | 206 | 10/02 → 05/06 | 3.697 | B | A | 8 | 40 | BFL | | 82081 | |
| 4.0 TDI quattro | 202 | 05/03 → 07/05 | 3.936 | D | M | 8 | 32 | ASE | | 82046 | |
| 4.2 quattro | 246 | 10/02 → 07/10 | 4.172 | B | M | 8 | 40 | BFM | | 82081 | |

| | | | | | | | | | |
|--|--|--|--|--|--|--|--|--|--|
| | | | | | | | | | |
|--|--|--|--|--|--|--|--|--|--|

AUDI

A8 II

| | | | | | | | | | | |
|-----------------|-----|---------------|-------|---|---|---|----|-----|--|-------|
| 4.2 TDI quattro | 235 | 01/05 → 06/05 | 4.134 | D | M | 8 | 32 | BMC | | 82046 |
| | 240 | 07/05 → 07/10 | 4.134 | D | M | 8 | 32 | BVN | | 82046 |

A8 III

| | | | | | | | | | | | |
|-----------------|-----|---------|-------|---|---|---|----|------------------|--|-------|--|
| 2.0 TFSI hybrid | 155 | 02/12 → | 1.984 | | M | 4 | 16 | CHJA | | 84016 | |
| 3.0 TDI | 150 | 09/11 → | 2.967 | D | M | 6 | 24 | CLAB | | 84021 | |
| 3.0 TDI quattro | 155 | 08/10 → | 2.967 | D | M | 6 | 24 | CDTB, CTBB | | 84021 | |
| | 184 | 07/10 → | 2.967 | D | M | 6 | 24 | CDTA, CDTC, CMHA | | 84021 | |

Allroad

| | | | | | | | | | | |
|-----------------|-----|---------------|-------|---|---|---|----|----------|--|-------|
| 2.5 TDI quattro | 120 | 05/03 → 08/05 | 2.496 | D | M | 6 | 24 | BCZ | | 81705 |
| | 132 | 05/00 → 08/05 | 2.496 | D | M | 6 | 24 | AKE, BAU | | 81705 |
| 2.7 quattro | 187 | 09/00 → 08/05 | 2.671 | B | M | 6 | 30 | APB, BEL | | 81842 |
| 2.7 T quattro | 184 | 05/00 → 08/05 | 2.671 | B | M | 6 | 30 | ARE, BES | | 81842 |
| 4.2 V8 quattro | 220 | 07/02 → 08/05 | 4.163 | B | M | 8 | 40 | BAS | | 82046 |

Cabriolet

| | | | | | | | | | | |
|---------|-----|---------------|-------|---|---|---|----|---------|--------|-------|
| 1.8 | 92 | 01/97 → 08/00 | 1.781 | B | M | 4 | 20 | ADR | (-)COP | 81526 |
| | 92 | 01/97 → 08/00 | 1.781 | B | M | 4 | 20 | ADR | (+)COP | 81529 |
| 1.9 TDI | 66 | 06/95 → 08/00 | 1.896 | D | M | 4 | 8 | 1Z, AHU | (-)COP | 81522 |
| | 66 | 06/95 → 08/00 | 1.896 | D | M | 4 | 8 | 1Z, AHU | (+)COP | 82080 |
| 2.0 16V | 103 | 06/95 → 07/96 | 1.984 | B | M | 4 | 16 | ACE | (-)COP | 81522 |
| | 103 | 06/95 → 07/96 | 1.984 | B | M | 4 | 16 | ACE | (+)COP | 82080 |
| 2.0 E | 85 | 01/93 → 07/98 | 1.984 | B | M | 4 | 8 | ABK | (-)COP | 81522 |
| | 85 | 01/93 → 07/98 | 1.984 | B | M | 4 | 8 | ABK | (+)COP | 82080 |
| 2.3 E | 98 | 05/91 → 07/94 | 2.309 | B | M | 5 | 10 | NG | | 81700 |

Coupé II

| | | | | | | | | | | |
|------------------|-----|---------------|-------|---|---|---|----|----------|----------------------------------|-------|
| 1.8 | 82 | 08/89 → 07/91 | 1.781 | B | M | 4 | 8 | DZ | → 12-1990, → T: F88-M-033.000 | 81683 |
| | 82 | 08/89 → 07/91 | 1.781 | B | M | 4 | 8 | DZ | 01-1991 →, T →: F88-M-033-001 | 81700 |
| 2.0 | 82 | 03/90 → 07/90 | 1.984 | B | M | 4 | 8 | 3A | (-)COP | 81522 |
| | 82 | 03/90 → 07/90 | 1.984 | B | M | 4 | 8 | 3A | (+)COP | 82080 |
| | 83 | 05/89 → 03/90 | 1.984 | B | M | 4 | 8 | 3A | (-)COP | 81522 |
| | 83 | 05/89 → 03/90 | 1.984 | B | M | 4 | 8 | 3A | (+)COP | 82080 |
| | 85 | 05/89 → 12/96 | 1.984 | B | M | 4 | 8 | AAD, ABK | (-)COP | 81522 |
| | 85 | 05/89 → 12/96 | 1.984 | B | M | 4 | 8 | AAD, ABK | (+)COP | 82080 |
| 2.0 16 V | 101 | 01/92 → 07/92 | 1.984 | B | M | 4 | 16 | 6A | (-)COP | 81522 |
| | 101 | 01/92 → 07/92 | 1.984 | B | M | 4 | 16 | 6A | (+)COP | 82080 |
| | 103 | 08/92 → 12/96 | 1.984 | B | M | 4 | 16 | ACE | (-)COP | 81522 |
| | 103 | 08/92 → 12/96 | 1.984 | B | M | 4 | 16 | ACE | (+)COP | 82080 |
| 2.0 20 V | 118 | 08/89 → 07/91 | 1.994 | B | M | 5 | 20 | NM | → T: F88-M-033.000 | 81683 |
| | 118 | 08/89 → 07/91 | 1.994 | B | M | 5 | 20 | NM | T →: F88-M-033.001 | 81700 |
| 2.0 20 V quattro | 118 | 08/89 → 07/91 | 1.994 | B | M | 5 | 20 | NM | → T: F88-M-033.000 | 81683 |
| | 118 | 08/89 → 07/91 | 1.994 | B | M | 5 | 20 | NM | T →: F88-M-033.001 | 81700 |
| 2.2 quattro | 100 | 11/88 → 07/91 | 2.226 | B | M | 5 | 10 | KV | | 81683 |

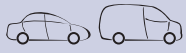
KW

cm³

NO. OF VALVES

AUDI
Coupé II

| | | | | | | | | | | |
|-----------------|-----|---------------|-------|---|---|---|----|------------------|----------------------------------|------------------|
| 2.3 | 98 | 03/90 → 12/96 | 2.309 | B | M | 5 | 10 | NG | → 12-1990, → T: F88-M-033.000 | 81683 |
| | 98 | 03/90 → 12/96 | 2.309 | B | M | 5 | 10 | NG | 01-1991 →, T →: F88-M-033-001 | 81700 |
| | 100 | 10/88 → 07/94 | 2.309 | B | M | 5 | 10 | NG | → 12-1990, → T: F88-M-033.000 | 81683 |
| | 100 | 10/88 → 07/94 | 2.309 | B | M | 5 | 10 | NG | 01-1991 →, T →: F88-M-033-001 | 81700 |
| 2.3 20V | 123 | 08/90 → 07/91 | 2.309 | B | M | 5 | 20 | 7A | → 12-1990, → T: F88-M-033.000 | 81683 |
| | 123 | 08/90 → 07/91 | 2.309 | B | M | 5 | 20 | 7A | 01-1991 →, T →: F88-M-033-001 | 81700 |
| | 125 | 08/89 → 07/91 | 2.309 | B | M | 5 | 20 | 7A | → 12-1990, → T: F88-M-033.000 | 81683 |
| | 125 | 08/89 → 07/91 | 2.309 | B | M | 5 | 20 | 7A | 01-1991 →, T →: F88-M-033-001 | 81700 |
| 2.3 20V quattro | 123 | 05/90 → 12/96 | 2.309 | B | M | 5 | 20 | 7A | → 12-1990, → T: F88-M-033.000 | 81683 |
| | 123 | 05/90 → 12/96 | 2.309 | B | M | 5 | 20 | 7A | 01-1991 →, T →: F88-M-033-001 | 81700 |
| | 125 | 11/88 → 07/91 | 2.309 | B | M | 5 | 20 | 7A | → 12-1990, → T: F88-M-033.000 | 81683 |
| | 125 | 11/88 → 07/91 | 2.309 | B | M | 5 | 20 | 7A | 01-1991 →, T →: F88-M-033-001 | 81700 |
| 2.3 quattro | 98 | 05/90 → 12/96 | 2.309 | B | M | 5 | 10 | NG | → 12-1990, → T: F88-M-033.000 | 81683 |
| | 98 | 05/90 → 12/96 | 2.309 | B | M | 5 | 10 | NG | 01-1991 →, T →: F88-M-033-001 | 81700 |
| | 100 | 11/88 → 12/92 | 2.309 | B | M | 5 | 10 | NG | → 12-1990, → T: F88-M-033.000 | 81683 |
| | 100 | 11/88 → 12/92 | 2.309 | B | M | 5 | 10 | NG | 01-1991 →, T →: F88-M-033-001 | 81700 |
| S2 quattro | 162 | 09/90 → 09/92 | 2.226 | B | M | 5 | 20 | 3B | → T: F88-M-033.000 | 81700 |
| | 169 | 10/92 → 12/96 | 2.226 | B | M | 5 | 20 | ABY | | 81700 |
| Q3 | | | | | | | | | | |
| 1.4 TFSI | 110 | 10/13 → | 1.395 | B | M | 4 | 16 | CHPB, CZDA, CZEA | | 84062 NEW |
| 2.0 TDI | 100 | 09/11 → | 1.968 | D | M | 4 | 16 | CFFA | | 84001 |
| | 103 | 09/11 → | 1.968 | D | M | 4 | 16 | CFFB, CLJA | | 84001 |
| | 130 | 05/13 → | 1.968 | D | M | 4 | 16 | CFGC | | 84001 |
| 2.0 TDI quattro | 103 | 01/12 → | 1.968 | D | M | 4 | 16 | CFFB | | 84001 |
| | 120 | 06/11 → | 1.968 | D | M | 4 | 16 | CFGD | | 84001 |
| | 130 | 06/11 → | 1.968 | D | M | 4 | 16 | CFGC, CLLB | | 84001 |
| 2.0 TFSI | 132 | 05/15 → | 1.984 | B | M | 4 | 16 | CULB | | 84037 NEW |

KW

cm³

NO. OF VALVES

AUDI
Q3

| | | | | | | | | | | | |
|------------------|-----|---------|-------|---|---|---|----|------|--|-------|------------|
| 2.0 TFSI quattro | 125 | 06/11 → | 1.984 | B | M | 4 | 16 | CCZC | | 84016 | NEW |
| | 132 | 11/14 → | 1.984 | B | M | 4 | 16 | CULB | | 84037 | NEW |
| | 155 | 06/11 → | 1.984 | B | M | 4 | 16 | CPSA | | 84016 | NEW |
| | 162 | 11/14 → | 1.984 | B | M | 4 | 16 | | | 84016 | NEW |

Q5

| | | | | | | | | | | | |
|-------------------------|---------|---------|-------|---|---|----|------------|------------------------|--------------------|-------|------------|
| 2.0 TDI | 100 | 11/10 → | 1.968 | D | M | 4 | 16 | CJCB, CSUB | | 84001 | |
| | 105 | 11/10 → | 1.968 | D | M | 4 | 16 | CJCA | | 84001 | |
| | 110 | 05/13 → | 1.968 | D | M | 4 | 16 | CJCD, CSUA | | 84001 | |
| 2.0 TDI quattro | 100 | 08/09 → | 1.968 | D | M | 4 | 16 | CAGB, CJCB, CSUB | M: 20598 | 84011 | NEW |
| | 100 | 08/09 → | 1.968 | D | M | 4 | 16 | CAGB, CJCB, CSUB | M: 24941 | 84001 | |
| | 100 | 08/09 → | 1.968 | D | M | 4 | 16 | CAGB, CJCB, CSUB | | 84001 | |
| | 105 | 08/09 → | 1.968 | D | M | 4 | 16 | CAGA, CJCA | M: 20597 | 84011 | NEW |
| | 105 | 08/09 → | 1.968 | D | M | 4 | 16 | CAGA, CJCA | M: 24949 | 84001 | |
| | 105 | 08/09 → | 1.968 | D | M | 4 | 16 | CAGA, CJCA | | 84001 | |
| | 110 | 05/13 → | 1.968 | D | M | 4 | 16 | CJCD, CSUA | | 84001 | |
| | 120 | 11/08 → | 1.968 | D | M | 4 | 16 | CAHB, CGLA, CGLD, CNHC | M: 20864 | 84011 | NEW |
| | 120 | 11/08 → | 1.968 | D | M | 4 | 16 | CAHB, CGLA, CGLD, CNHC | M: 24943, M: 24406 | 84001 | |
| | 120 | 11/08 → | 1.968 | D | M | 4 | 16 | CAHB, CGLA, CGLD, CNHC | | 84001 | |
| | 125 | 11/08 → | 1.968 | D | M | 4 | 16 | CAHA, CGLB, CMGA | M: 20602 | 84011 | NEW |
| | 125 | 11/08 → | 1.968 | D | M | 4 | 16 | CAHA, CGLB, CMGA | M: 25767, M: 24948 | 84001 | |
| | 125 | 11/08 → | 1.968 | D | M | 4 | 16 | CAHA, CGLB, CMGA | | 84001 | |
| 130 | 06/12 → | 1.968 | D | M | 4 | 16 | CGLC, CMGB | | 84001 | | |
| 2.0 TFSI hybrid quattro | 155 | 06/11 → | 1.984 | | M | 4 | 16 | CHJA | | 84016 | NEW |
| 2.0 TFSI quattro | 132 | 08/09 → | 1.984 | B | M | 4 | 16 | CDNB, CNCB | | 84016 | NEW |
| | 155 | 11/08 → | 1.984 | B | M | 4 | 16 | CAEB, CDNC, CPMA | | 84016 | NEW |
| | 162 | 05/13 → | 1.984 | B | M | 4 | 16 | CPMB | | 84016 | NEW |
| | 165 | 06/12 → | 1.984 | B | M | 4 | 16 | CNCD | | 84037 | NEW |
| 3.0 TDI quattro | 155 | 11/08 → | 2.967 | D | M | 6 | 24 | CCWB | | 82015 | |
| | 176 | 11/08 → | 2.967 | D | M | 6 | 24 | CCWA, CPNB | | 82015 | |
| SQ5 TDI quattro | 240 | 04/15 → | 2.967 | D | M | 6 | 24 | CVUB | | 84021 | NEW |

Q7 I

| | | | | | | | | | | | |
|---------|-----|---------------|-------|---|---|---|----|------------------------|--|-------|------------|
| 3.0 TDI | 150 | 05/10 → 08/15 | 2.967 | D | M | 6 | 24 | CJGC, CJMA | | 84021 | NEW |
| | 155 | 03/06 → 05/10 | 2.967 | D | M | 6 | 24 | BUN, CASB | | 82015 | |
| | 165 | 06/09 → 05/12 | 2.967 | D | M | 6 | 24 | CATA | | 82015 | |
| | 171 | 03/06 → 05/08 | 2.967 | D | M | 6 | 24 | BUG | | 82015 | |
| | 176 | 11/07 → 08/15 | 2.967 | D | M | 6 | 24 | CASA, CCMA, CJGA, CNRB | | 82015 | |
| | 180 | 05/11 → 08/15 | 2.967 | D | M | 6 | 24 | CJGD, CLZB, CRCA | | 84021 | NEW |

KW

cm³

NO. OF VALVES

MAGNETI MARELLI
AUDI
Q7 I

| | | | | | | | | | |
|----------|-----|---------------|-------|---|---|---|----|------------------------|-------|
| 3.0 TFSI | 200 | 05/10 → 08/15 | 2.995 | B | M | 6 | 24 | CJTC, CJWC | 82015 |
| | 206 | 05/11 → 08/15 | 2.995 | B | M | 6 | 24 | CJWE, CTWB | 82015 |
| | 245 | 05/10 → 08/15 | 2.995 | B | M | 6 | 24 | CJTB, CJWB, CNAA, CTWA | 82015 |
| 3.6 FSI | 206 | 08/06 → 05/10 | 3.597 | B | M | 6 | 24 | BHK | 81866 |
| 4.2 TDI | 240 | 03/07 → 06/09 | 4.134 | D | M | 8 | 32 | BTR | 82046 |

Quattro

| | | | | | | | | | |
|---------------|-----|---------------|-------|---|---|---|----|----|-------|
| 2.2 20V Turbo | 162 | 08/89 → 07/91 | 2.226 | B | M | 5 | 20 | RR | 81683 |
|---------------|-----|---------------|-------|---|---|---|----|----|-------|

TT I, Roadster

| | | | | | | | | | |
|-----------------|-----|---------------|-------|---|---|---|----|-------------------------|-------|
| 1.8 T | 110 | 09/02 → 06/06 | 1.781 | B | M | 4 | 20 | AUM | 81703 |
| | 120 | 09/05 → 06/06 | 1.781 | B | M | 4 | 20 | BVP | 81703 |
| | 132 | 10/99 → 06/06 | 1.781 | B | M | 4 | 20 | AJQ, APP, ATC, AUQ | 81703 |
| | 132 | 10/98 → 06/06 | 1.781 | B | M | 4 | 20 | AJQ, APP, ATC, AUQ, AWP | 81703 |
| | 140 | 09/05 → 06/06 | 1.781 | B | M | 4 | 20 | BVR | 81703 |
| 1.8 T quattro | 132 | 10/98 → 06/06 | 1.781 | B | M | 4 | 20 | AJQ, ARY, AUQ, AWP | 81703 |
| | 140 | 09/05 → 06/06 | 1.781 | B | M | 4 | 20 | BVR | 81703 |
| | 165 | 10/98 → 06/06 | 1.781 | B | M | 4 | 20 | APX, BAM | 81703 |
| | 176 | 03/05 → 06/06 | 1.781 | B | M | 4 | 20 | BFV | 81703 |
| 3.2 VR6 quattro | 184 | 07/03 → 06/06 | 3.189 | B | M | 6 | 24 | BHE, BPF | 81866 |

TT II, Roadster

| | | | | | | | | | | |
|------------------|-----|---------------|-------|---|---|---|----|----------------|-------|------------|
| 1.8 TFSI | 118 | 06/08 → 06/14 | 1.798 | B | M | 4 | 16 | CDAA | 84016 | NEW |
| 2.0 TDI quattro | 125 | 06/08 → 06/14 | 1.968 | D | M | 4 | 16 | CBBB, CFGB | 81816 | |
| | 125 | 06/08 → 06/14 | 1.968 | D | M | 4 | 16 | CBBB, CFGB | 84011 | NEW |
| 2.0 TFSI | 147 | 08/06 → 06/10 | 1.984 | B | M | 4 | 16 | BPY, BWA, CCTA | 82025 | |
| | 155 | 05/10 → 06/14 | 1.984 | B | M | 4 | 16 | CESA | 84016 | NEW |
| 2.0 TFSI quattro | 147 | 06/08 → 06/10 | 1.984 | B | M | 4 | 16 | BWA, CCZA | 82025 | |
| | 147 | 06/08 → 06/10 | 1.984 | B | M | 4 | 16 | CCZA | 82025 | |
| | 155 | 05/10 → 06/14 | 1.984 | B | M | 4 | 16 | CESA, CETA | 84016 | NEW |
| 2.0 TTS quattro | 195 | 05/08 → 06/14 | 1.984 | B | M | 4 | 16 | CDLA, CDMA | 82025 | |
| | 200 | 05/08 → 06/14 | 1.984 | B | M | 4 | 16 | CDLB | 82025 | |
| 3.2 V6 quattro | 184 | 08/06 → 06/10 | 3.189 | B | M | 6 | 24 | BUB | 81866 | |

TT III, Roadster

| | | | | | | | | | | |
|------------------|-----|---------|-------|---|---|---|----|------|-------|------------|
| 1.8 TFSI | 132 | 08/15 → | 1.798 | B | M | 4 | 16 | CJSA | 84037 | NEW |
| 2.0 TFSI | 169 | 07/14 → | 1.984 | B | M | 4 | 16 | CHHC | 84037 | NEW |
| 2.0 TFSI quattro | 169 | 07/14 → | 1.984 | B | M | 4 | 16 | CHHC | 84037 | NEW |
| | 215 | 07/15 → | 1.984 | B | M | 4 | 16 | CYFB | 84037 | NEW |
| 2.0 TTS quattro | 210 | 02/15 → | 1.984 | B | M | 4 | 16 | CJXF | 84037 | NEW |
| | 228 | 11/14 → | 1.984 | B | M | 4 | 16 | CJXG | 84037 | NEW |

KW

cm³

NO. OF VALVES

AUSTIN

Metro

| | | | | | | | | | | |
|--------------|----|---------------|-------|---|---|---|---|----------|----|-------|
| 1.0 | 30 | 10/80 → 04/90 | 999 | B | M | 4 | 8 | 99H | BC | 81419 |
| | 33 | 10/80 → 04/90 | 999 | B | M | 4 | 8 | 99H | BC | 81419 |
| 1.0 Surf HLE | 35 | 10/80 → 04/90 | 999 | B | M | 4 | 8 | 99HA65P | BC | 81419 |
| 1.3 | 51 | 10/80 → 04/90 | 1.275 | B | M | 4 | 8 | 12HA83AA | BC | 81419 |
| 1.3 L,HLE,S | 44 | 10/80 → 04/90 | 1.275 | B | M | 4 | 8 | 12H | BC | 81419 |
| 1.3 Surf | 44 | 11/85 → 04/90 | 1.273 | B | M | 4 | 8 | 12HC21AA | BC | 81419 |
| 1.3 Turbo | 66 | 10/83 → 04/90 | 1.275 | B | M | 4 | 8 | 12HA85AA | BC | 81419 |

Mini

| | | | | | | | | | | |
|--------------------|----|---------------|-----|---|---|---|---|---------------------------|----|-------|
| 1000 Mayfair | 31 | 08/82 → 06/93 | 998 | B | M | 4 | 8 | 99H997P, 99HA53P, 99HC20P | BC | 81419 |
| 1000 Mayfair Sport | 30 | 09/88 → 06/93 | 999 | B | M | 4 | 8 | 99HD81 | BC | 81419 |

AUTOBIANCHI

Y10

| | | | | | | | | | | |
|---------------|----|---------------|-------|---|---|---|---|-----------|--|-------|
| 1.0 | 33 | 03/85 → 10/95 | 999 | B | M | 4 | 8 | 156A2.000 | | 81801 |
| | 41 | 03/85 → 10/95 | 1.049 | B | M | 4 | 8 | 156A.000 | | 81434 |
| 1.0 4WD | 37 | 12/86 → 10/95 | 999 | B | M | 4 | 8 | 156A3.000 | | 81801 |
| 1.0 Cat. | 33 | 10/87 → 10/95 | 999 | B | M | 4 | 8 | 156A2.246 | | 81801 |
| 1.0 Turbo | 63 | 03/85 → 10/95 | 1.049 | B | M | 4 | 8 | 156A1.000 | | 81434 |
| 1.1 | 42 | 06/89 → 10/95 | 1.108 | B | M | 4 | 8 | 156C.000 | | 81801 |
| 1.1 4WD | 42 | 06/89 → 10/95 | 1.108 | B | M | 4 | 8 | 156C.000 | | 81801 |
| 1.1 i.e. Cat. | 42 | 09/90 → 10/95 | 1.108 | B | M | 4 | 8 | 156C.046 | | 81801 |
| 1.3 i.e. GT | 54 | 06/89 → 10/95 | 1.297 | B | M | 4 | 8 | 146A5.046 | | 81434 |
| | 57 | 06/89 → 10/95 | 1.301 | B | M | 4 | 8 | 156B.000 | | 81434 |

BMW

1 I (E81, E87), Coupé (E82), Cabrio (E88)

| | | | | | | | | | | |
|-------|-----|---------------|-------|---|---|---|----|----------------------------------|--|-------|
| 116 d | 66 | 01/11 → 12/11 | 1.995 | D | M | 4 | 16 | N47D20A, N47D20C | | 84000 |
| | 66 | 01/11 → 12/11 | 1.995 | D | M | 4 | 16 | N47D20C | | 84000 |
| | 85 | 12/08 → 09/12 | 1.995 | D | M | 4 | 16 | N47D20A | | 84000 |
| | 85 | 11/08 → 09/12 | 1.995 | D | M | 4 | 16 | N47D20A, N47D20C | | 84000 |
| 116 i | 85 | 11/03 → 09/12 | 1.596 | B | M | 4 | 16 | N43B16A, N45B16A | | 82010 |
| | 85 | 03/07 → 09/12 | 1.596 | B | M | 4 | 16 | N45B16A | | 82010 |
| | 90 | 03/07 → 09/12 | 1.599 | B | M | 4 | 16 | N43B16A, N45B16A | | 82010 |
| 118 d | 90 | 11/03 → 09/12 | 1.995 | D | M | 4 | 16 | M47D20 (204D4), N47D20A, N47D20C | | 82040 |
| | 100 | 11/03 → 09/12 | 1.995 | D | M | 4 | 16 | M47D20 (204D4), N47D20A, N47D20C | | 84000 |
| | 100 | 09/06 → 09/12 | 1.995 | D | M | 4 | 16 | N47D20A, N47D20C | | 84000 |
| | 100 | 09/09 → 10/13 | 1.995 | D | M | 4 | 16 | N47D20C | | 84000 |
| | 105 | 11/03 → 09/12 | 1.995 | D | M | 4 | 16 | M47D20 (204D4), N47D20A, N47D20C | | 84000 |
| | 105 | 09/06 → 09/12 | 1.995 | D | M | 4 | 16 | N47D20A, N47D20C | | 84000 |
| | 105 | 09/09 → 10/13 | 1.995 | D | M | 4 | 16 | N47D20C | | 84000 |

KW

cm³

NO. OF VALVES

MAGNETI MARELLI
BMW
1 I (E81, E87), Coupé (E82), Cabrio (E88)

| | | | | | | | | | | |
|-------|-----|---------------|-------|---|---|---|----|---|-------------|-------|
| 118 i | 95 | 07/04 → 09/12 | 1.995 | B | M | 4 | 16 | N43B20A, N46B20B | | 82010 |
| | 100 | 07/04 → 09/12 | 1.995 | B | M | 4 | 16 | N43B20A, N46B20B | M: N46NB20B | 82010 |
| | 100 | 09/08 → 12/13 | 1.995 | B | M | 4 | 16 | N46B20B | | 82010 |
| | 105 | 03/08 → 12/13 | 1.995 | B | M | 4 | 16 | N43B20A | | 82010 |
| | 105 | 09/06 → 09/12 | 1.995 | B | M | 4 | 16 | N43B20A, N46B20B | | 82010 |
| 120 d | 120 | 03/07 → 09/12 | 1.995 | D | M | 4 | 16 | M47D20 (204D4), N47D20A, N47D20C | | 82040 |
| | 120 | 03/08 → 12/13 | 1.995 | D | M | 4 | 16 | N47D20A, N47D20C | | 84000 |
| | 130 | 11/03 → 09/12 | 1.995 | D | M | 4 | 16 | M47D20 (204D4), N47D20A, N47D20C | | 84000 |
| | 130 | 09/06 → 09/12 | 1.995 | D | M | 4 | 16 | N47D20A, N47D20C | | 84000 |
| | 145 | 03/08 → 12/13 | 1.995 | D | M | 4 | 16 | N47D20C | | 84000 |
| 120 i | 110 | 11/03 → 09/12 | 1.995 | B | M | 4 | 16 | N46B20B, N46B20BD, N46B20C, N46B20CC, N46B20CD | | 82010 |
| | 115 | 11/03 → 09/12 | 1.995 | B | M | 4 | 16 | N46B20A, N46B20B, N46B20BD, N46B20C, N46B20CC, N46B20CD | | 82010 |
| | 115 | 09/09 → 10/13 | 1.995 | B | M | 4 | 16 | N46B20B | | 82010 |
| | 115 | 09/06 → 09/12 | 1.995 | B | M | 4 | 16 | N46B20B, N46B20C | | 82010 |
| | 115 | 03/08 → 12/13 | 1.995 | B | M | 4 | 16 | N46B20B, N46B20C, N46B20E | | 82010 |
| | 125 | 03/08 → 12/13 | 1.995 | B | M | 4 | 16 | N43B20A | | 82010 |
| | 125 | 02/07 → 09/12 | 1.995 | B | M | 4 | 16 | N43B20A, N46B20B, N46B20BD, N46B20C, N46B20CC, N46B20CD | | 82010 |
| 123 d | 125 | 09/06 → 09/12 | 1.995 | B | M | 4 | 16 | N43B20A, N46B20B, N46B20C | | 82010 |
| | 150 | 03/07 → 09/12 | 1.995 | D | M | 4 | 16 | N47D20B, N47D20C, N47D20D | | 84000 |
| | 150 | 03/07 → 09/12 | 1.995 | D | M | 4 | 16 | N47D20B, N47D20D | | 84000 |

1 II (F20, F21)

| | | | | | | | | | | |
|-------|-----|---------|-------|---|---|---|----|---------|-----------|-------|
| 114 i | 75 | 11/11 → | 1.598 | B | M | 4 | 16 | N13B16A | → 11-2012 | 82032 |
| 116 i | 100 | 12/10 → | 1.598 | B | M | 4 | 16 | N13B16A | → 11-2012 | 82032 |
| 118 i | 100 | 03/15 → | 1.598 | B | M | 4 | 16 | N13B16A | → 11-2012 | 82032 |
| | 125 | 11/10 → | 1.598 | B | M | 4 | 16 | N13B16A | → 11-2012 | 82032 |
| 120 i | 130 | 03/15 → | 1.598 | B | M | 4 | 16 | N13B16A | → 11-2012 | 82032 |

2 Coupé (F22, F87), Cabrio (F23), Active Tourer (F45), Gran Tourer (F46)

| | | | | | | | | | | | |
|--------------|-----|---------|-------|---|---|---|----|---------|--|-------|------------|
| 216 i | 75 | 11/15 → | 1.499 | B | M | 3 | 12 | B38A15A | | 84049 | NEW |
| 218 d | 100 | 03/15 → | 1.995 | D | M | 4 | 16 | B47C20A | | 84051 | NEW |
| 218 d xDrive | 100 | 03/15 → | 1.995 | D | M | 4 | 16 | B47C20A | | 84051 | NEW |
| | 100 | 11/15 → | 1.995 | D | M | 4 | 16 | | | 84051 | NEW |
| | 110 | 11/15 → | 1.995 | D | M | 4 | 16 | B47C20A | | 84051 | NEW |

KW

cm³

NO. OF VALVES

BMW
2 Coupè (F22, F87), Cabrio (F23), Active Tourer (F45), Gran Tourer (F46)

| | | | | | | | | | | | |
|--------------|-----|---------|-------|---|---|---|----|-------------------|--|-------|------------|
| 218 i | 100 | 03/15 → | 1.499 | B | M | 3 | 12 | B38A15A | | 84049 | NEW |
| | 100 | 09/14 → | 1.499 | B | M | 3 | 12 | B38A15A, B38A15MO | | 84049 | NEW |
| 220 d | 140 | 07/15 → | 1.995 | D | M | 4 | 16 | B47C20A | | 84051 | NEW |
| 220 i | 120 | 11/14 → | 1.998 | B | M | 4 | 16 | B48A20A | | 84049 | NEW |
| | 141 | 11/14 → | 1.998 | B | M | 4 | 16 | B48A20A | | 84049 | NEW |
| 225 i | 170 | 09/14 → | 1.998 | B | M | 4 | 16 | B48A20B | | 84049 | NEW |
| 225 i xDrive | 170 | 11/14 → | 1.998 | B | M | 4 | 16 | B48A20B | | 84049 | NEW |

3 II (E30), Touring, Cabrio

| | | | | | | | | | | |
|--------|-----|---------------|-------|---|---|---|----|-------------------------------------|-----------|-------|
| 316 | 66 | 09/82 → 12/90 | 1.766 | B | M | 4 | 8 | M10B18 (184VC), M10B18 (184VD) | → 09-1987 | 81584 |
| | 66 | 09/82 → 12/90 | 1.766 | B | M | 4 | 8 | M10B18 (184VC), M10B18 (184VD) | 10-1987 → | 81587 |
| 316 i | 73 | 09/87 → 06/91 | 1.596 | B | M | 4 | 8 | M40B16 (164E1) | → 09-1988 | 81584 |
| | 73 | 09/87 → 06/91 | 1.596 | B | M | 4 | 8 | M40B16 (164E1) | 10-1988 → | 81587 |
| | 73 | 09/91 → 06/94 | 1.596 | B | M | 4 | 8 | M40B16 (164E1) | | 81587 |
| | 75 | 07/88 → 06/91 | 1.596 | B | M | 4 | 8 | M40B16 (164E1) | → 09-1988 | 81584 |
| | 75 | 07/88 → 06/91 | 1.596 | B | M | 4 | 8 | M40B16 (164E1) | 10-1988 → | 81587 |
| | 75 | 09/91 → 06/94 | 1.596 | B | M | 4 | 8 | M40B16 (164E1) | | 81587 |
| 318 i | 83 | 09/87 → 06/91 | 1.796 | B | M | 4 | 8 | M40B18 (184E1) | | 81587 |
| | 83 | 04/89 → 06/94 | 1.796 | B | M | 4 | 8 | M40B18 (184E1) | M: M40B16 | 81587 |
| | 85 | 09/87 → 06/91 | 1.796 | B | M | 4 | 8 | M40B18 (184E1) | | 81587 |
| | 103 | 06/88 → 02/92 | 1.796 | B | M | 4 | 8 | M40B18C | | 81587 |
| 318 is | 100 | 09/89 → 08/91 | 1.796 | B | M | 4 | 16 | M42B18 (184S1) | | 81590 |
| 320 i | 95 | 04/86 → 10/93 | 1.990 | B | M | 6 | 12 | M20B20 (206KA) | → 09-1987 | 81586 |
| | 95 | 04/86 → 10/93 | 1.990 | B | M | 6 | 12 | M20B20 (206KA) | 10-1987 → | 81616 |
| | 110 | 12/85 → 06/90 | 1.990 | B | M | 6 | 12 | M20B20 (206KA) | → 09-1987 | 81586 |
| | 110 | 12/85 → 06/90 | 1.990 | B | M | 6 | 12 | M20B20 (206KA) | 10-1987 → | 81616 |
| | 95 | 01/88 → 12/91 | 1.991 | B | M | 6 | 12 | M20B20 (206KA) | | 81616 |
| | 95 | 12/85 → 06/91 | 1.991 | B | M | 6 | 12 | M20B20 (206KA), M20B20 (L-Jetronic) | → 09-1987 | 81586 |
| | 95 | 12/85 → 06/91 | 1.991 | B | M | 6 | 12 | M20B20 (206KA), M20B20 (L-Jetronic) | 10-1987 → | 81616 |
| 320 is | 141 | 05/88 → 12/90 | 1.990 | B | M | 4 | 16 | S14B20 (204EA) | | 81616 |

KW

cm³

NO. OF VALVES

BMW
3 II (E30), Touring, Cabrio

| | | | | | | | | | | |
|---------|-----|---------------|-------|---|---|---|----|---|-----------|-------|
| 325 i | 125 | 12/86 → 06/91 | 2.494 | B | M | 6 | 12 | M20B25 (256E1), M20B25 (256E2), M20B25 (256EX), M20B25 (256K1) | → 09-1987 | 81586 |
| | 125 | 12/86 → 06/91 | 2.494 | B | M | 6 | 12 | M20B25 (256E1), M20B25 (256E2), M20B25 (256EX), M20B25 (256K1) | 10-1987 → | 81616 |
| | 125 | 09/87 → 10/93 | 2.494 | B | M | 6 | 12 | M20B25 (256E2), M20B25 (256EX), M20B25 (256K1) | | 81616 |
| | 125 | 07/87 → 03/93 | 2.494 | B | M | 6 | 12 | M20B25 (256K1) | | 81616 |
| 325 i X | 125 | 12/86 → 08/91 | 2.494 | B | M | 6 | 12 | M20B25 (256E1), M20B25 (256E2), M20B25 (256EX), M20B25 (256K1) | → 09-1987 | 81586 |
| | 125 | 12/86 → 08/91 | 2.494 | B | M | 6 | 12 | M20B25 (256E1), M20B25 (256E2), M20B25 (256EX), M20B25 (256K1) | 10-1987 → | 81616 |
| | 125 | 06/88 → 10/93 | 2.494 | B | M | 6 | 12 | M20B25 (256K1) | | 81616 |
| M3 2.3 | 143 | 06/88 → 06/91 | 2.303 | B | M | 4 | 16 | S14B23 (234EA) | | 81586 |
| | 143 | 07/86 → 06/91 | 2.303 | B | M | 4 | 16 | S14B23 (234EA), S14B23 (234S1), S14B23 (234S2) | | 81586 |
| | 158 | 06/89 → 06/91 | 2.303 | B | M | 4 | 16 | S14B23 (234EA) | | 81586 |

3 III (E36), Touring, Cabrio, Coupé, Compact

| | | | | | | | | | | |
|---------|-----|---------------|-------|----|---|---|----|---------------------------|-------------------|-------|
| 316 g | 75 | 03/94 → 08/00 | 1.596 | BF | M | 4 | 8 | M43B16 (164E2) | | 81590 |
| 316 i | 73 | 09/90 → 09/93 | 1.596 | B | M | 4 | 8 | M40B16 (164E1) | M: M40B16 | 81589 |
| | 73 | 09/90 → 09/93 | 1.596 | B | M | 4 | 8 | M40B16 (164E1) | M: M43B16 / C / K | 81590 |
| | 75 | 07/93 → 02/98 | 1.596 | B | M | 4 | 8 | M43B16 (164E2) | | 81590 |
| | 75 | 03/94 → 08/00 | 1.596 | B | M | 4 | 8 | M43B16 (164E2) | M: M43B16 / C / K | 81590 |
| | 75 | 09/90 → 09/93 | 1.596 | B | M | 4 | 8 | M43B16, M43B16 (164E2) | | 81589 |
| | 77 | 12/98 → 08/00 | 1.895 | B | M | 4 | 8 | M43B19 (194E1) | | 81590 |
| 318 i | 83 | 12/90 → 10/93 | 1.796 | B | M | 4 | 8 | M40B18 (184E1) | M: M40B16 | 81589 |
| | 85 | 10/93 → 02/98 | 1.796 | B | M | 4 | 8 | M43B18 (184E2) | M: M40B16 | 81590 |
| | 85 | 01/94 → 04/99 | 1.796 | B | M | 4 | 8 | M43B18 (184E2) | M: M43B19C | 81590 |
| | 85 | 07/95 → 10/99 | 1.796 | B | M | 4 | 8 | M43B18 (184E2) | M: M43B18 / C | 81590 |
| 318 is | 103 | 03/93 → 02/98 | 1.796 | B | M | 4 | 16 | M42B18 (184S1) | | 81590 |
| | 103 | 09/95 → 02/98 | 1.895 | B | M | 4 | 16 | M44B19 (194S1) | | 81590 |
| 318 tds | 66 | 01/95 → 02/98 | 1.665 | D | M | 4 | 8 | M41D17 (174T1) | | 81597 |
| 318 ti | 103 | 11/94 → 08/95 | 1.796 | B | M | 4 | 16 | M42B18 (184S1) | | 81590 |
| | 103 | 07/95 → 08/00 | 1.895 | B | M | 4 | 16 | M44B19 (194S1) | M: M44B19 / C | 81590 |

KW

cm³

NO. OF VALVES

BMW
3 III (E36), Touring, Cabrio, Coupé, Compact

| | | | | | | | | | | |
|-----------|-----|---------------|-------|---|---|---|----|--|-----------|-------|
| 320 i | 110 | 09/90 → 02/98 | 1.991 | B | M | 6 | 24 | M50B20, M50B20 (206S1), M50B20 (206S2), M50B20TU, M52B20, M52B20 (206S3) | | 81588 |
| | 110 | 12/93 → 04/99 | 1.991 | B | M | 6 | 24 | M50B20, M50B20 (206S2), M50B20TU, M52B20, M52B20 (206S3) | | 81588 |
| | 110 | 01/95 → 10/99 | 1.991 | B | M | 6 | 24 | M50B20, M50B20TU, M52B20, M52B20 (206S3) | | 81588 |
| 323 i | 125 | 03/95 → 04/99 | 2.494 | B | M | 6 | 24 | M52B25 (256S3) | 04-1995 → | 81588 |
| | 125 | 06/95 → 04/99 | 2.494 | B | M | 6 | 24 | M52B25 (256S3) | | 81588 |
| 323 i 2.5 | 125 | 03/95 → 02/98 | 2.494 | B | M | 6 | 24 | M52B25 (256S3) | 04-1995 → | 81588 |
| 323 ti | 125 | 08/97 → 08/00 | 2.494 | B | M | 6 | 24 | M52B25 (256S3) | | 81588 |
| 325 i | 141 | 09/90 → 09/95 | 2.494 | B | M | 6 | 24 | M50B25 (256S1), M50B25 (256S2), M50B25TU | | 81588 |
| | 141 | 03/93 → 03/95 | 2.494 | B | M | 6 | 24 | M50B25 (256S2), M50B25TU | | 81588 |
| 325 td | 85 | 09/91 → 02/98 | 2.497 | D | M | 6 | 12 | M51D25 (256T1) | | 81597 |
| 325 tds | 105 | 05/93 → 02/98 | 2.503 | D | M | 6 | 12 | M51D25 (256T1) | | 81597 |
| 328 i | 142 | 01/95 → 02/98 | 2.793 | B | M | 6 | 24 | M52B28 (286S1), M52B28TU | | 81588 |

3 IV (E46), Touring, Cabrio, Coupé, Compact

| | | | | | | | | | | |
|--------|-----|---------------|-------|---|---|---|----|--------------------------|-----------|-------|
| 316 Ci | 77 | 04/00 → 07/06 | 1.596 | B | M | 4 | 8 | M43B16 (164E3) | → 06-2001 | 81590 |
| | 77 | 04/00 → 07/06 | 1.596 | B | M | 4 | 8 | M43B16 (164E3) | 06-2001 → | 82010 |
| | 85 | 06/02 → 07/06 | 1.596 | B | M | 4 | 16 | N45B16A | | 82010 |
| 316 i | 77 | 04/00 → 02/05 | 1.596 | B | M | 4 | 8 | M43B16, M43B16 (164E3) | 06-2002 → | 82010 |
| | 77 | 04/00 → 02/05 | 1.596 | B | M | 4 | 8 | M43B16, M43B16 (164E3) | | 81590 |
| | 85 | 06/02 → 02/05 | 1.596 | B | M | 4 | 16 | N40B16A, N45B16A | | 82010 |
| | 85 | 06/02 → 02/05 | 1.596 | B | M | 4 | 16 | N45B16, N45B16A | | 82010 |
| | 85 | 02/02 → 02/05 | 1.796 | B | M | 4 | 16 | N42B18A, N46B18, N46B18A | | 82010 |
| | 77 | 09/98 → 02/05 | 1.895 | B | M | 4 | 8 | M43B19 (194E1), M43B19TU | | 81590 |
| 316 ti | 85 | 06/02 → 02/05 | 1.596 | B | M | 4 | 16 | N40B16A, N45B16A | | 82010 |
| | 85 | 06/01 → 02/05 | 1.796 | B | M | 4 | 16 | N42B18A, N46B18A | | 82010 |
| 318 Ci | 87 | 11/99 → 09/01 | 1.895 | B | M | 4 | 8 | M43B19 (194E1) | | 81590 |
| | 105 | 09/01 → 12/07 | 1.995 | B | M | 4 | 16 | N42B20A, N46B20A | | 82010 |
| | 110 | 03/05 → 07/06 | 1.995 | B | M | 4 | 16 | N46B20A | | 82010 |
| | 110 | 02/05 → 12/07 | 1.995 | B | M | 4 | 16 | N46B20A, N46B20B | | 82010 |

KW

cm³

NO. OF VALVES

BMW
3 IV (E46), Touring, Cabrio, Coupé, Compact

| | | | | | | | | | | |
|--------|-----|---------------|-------|---|----|---|----|---------------------------|-------------|-------|
| 318 d | 85 | 09/01 → 03/03 | 1.951 | D | M | 4 | 16 | M47D20, M47D20 (204D1) | | 81793 |
| | 85 | 03/03 → 02/05 | 1.995 | D | M | 4 | 16 | M47D20 (204D4), M47N204D4 | → 03-2004 | 82040 |
| | 85 | 03/03 → 02/05 | 1.995 | D | M | 4 | 16 | M47D20 (204D4), M47N204D4 | 04-2004 → | 82040 |
| 318 i | 85 | 10/99 → 09/01 | 1.895 | B | M | 4 | 8 | M43B19 (194E1) | | 81590 |
| | 87 | 02/98 → 09/01 | 1.895 | B | M | 4 | 8 | M43B19 (194E1), M43B19TU | | 81590 |
| | 105 | 09/01 → 02/05 | 1.995 | B | M | 4 | 16 | N42B20A, N46B20, N46B20A | | 82010 |
| 318 td | 85 | 03/03 → 02/05 | 1.995 | D | M | 4 | 16 | M47D20 (204D4), M47N204D4 | → 03-2004 | 82040 |
| | 85 | 03/03 → 02/05 | 1.995 | D | M | 4 | 16 | M47D20 (204D4), M47N204D4 | 04-2004 → | 82040 |
| 318 ti | 105 | 09/01 → 02/05 | 1.995 | B | M | 4 | 16 | N42B20A, N46B20A | | 82010 |
| 320 Cd | 110 | 02/05 → 12/07 | 1.995 | D | M | 4 | 16 | M47D20 (204D4) | C: A | 82034 |
| | 110 | 02/05 → 12/07 | 1.995 | D | M | 4 | 16 | M47D20 (204D4) | | 82040 |
| | 110 | 11/03 → 07/06 | 1.995 | D | M | 4 | 16 | M47D20 (204D4), M47N204D4 | → 03-2004 | 82040 |
| | 110 | 11/03 → 07/06 | 1.995 | D | M | 4 | 16 | M47D20 (204D4), M47N204D4 | 04-2004 → | 82040 |
| | 110 | 11/03 → 07/06 | 1.995 | D | M | 4 | 16 | M47D20 (204D4), M47N204D4 | C: A | 82034 |
| 320 Ci | 110 | 08/99 → 09/00 | 1.991 | B | M | 6 | 24 | M52B20, M52B20 (206S4) | C: M | 81588 |
| | 120 | 01/06 → 12/07 | 2.171 | B | M | 6 | 24 | M54B22 (226S1) | | 81588 |
| | 125 | 09/00 → 12/07 | 2.171 | B | AM | 6 | 24 | M54226S1, M54B22 (226S1) | | 81588 |
| | 125 | 09/00 → 07/06 | 2.171 | B | M | 6 | 24 | M54B22, M54B22 (226S1) | | 81588 |
| 320 d | 95 | 02/98 → 04/05 | 1.951 | D | M | 4 | 16 | M47D20 (204D1) | | 81793 |
| | 100 | 04/98 → 09/01 | 1.951 | D | M | 4 | 16 | M47204D1, M47D20 (204D1) | M: M47204D1 | 81793 |
| | 100 | 04/98 → 09/01 | 1.951 | D | M | 4 | 16 | M47204D1, M47D20 (204D1) | M: M47D20 | 81794 |
| | 100 | 03/00 → 09/01 | 1.951 | D | M | 4 | 16 | M47204D1, M47D20 (204D1) | | 81793 |
| | 100 | 03/00 → 09/01 | 1.951 | D | M | 4 | 16 | M47204D1, M47D20 (204D1) | | 81794 |
| | 110 | 09/01 → 02/05 | 1.995 | D | M | 4 | 16 | M47D20 (204D4) | → 03-2004 | 82040 |
| | 110 | 09/01 → 02/05 | 1.995 | D | M | 4 | 16 | M47D20 (204D4) | 04-2004 → | 82040 |
| | 110 | 09/01 → 02/05 | 1.995 | D | M | 4 | 16 | M47D20 (204D4) | C: A | 82034 |

KW

cm³

NO. OF VALVES

MAGNETI MARELLI
BMW
3 IV (E46), Touring, Cabrio, Coupé, Compact

| | | | | | | | | | | |
|--|-----|---------------|-------|---|----|---|----|-------------------------------|-----------|-------|
| 320 i | 110 | 03/98 → 09/00 | 1.991 | B | M | 6 | 24 | M52B20, M52B20 (206S4) | | 81588 |
| | 125 | 09/00 → 02/05 | 2.171 | B | M | 6 | 24 | M54B22, M54B22 (226S1) | | 81588 |
| 320 td | 110 | 09/01 → 02/05 | 1.995 | D | M | 4 | 16 | M47D20 (204D4), M47N204D4 | → 03-2004 | 82040 |
| | 110 | 09/01 → 02/05 | 1.995 | D | M | 4 | 16 | M47D20 (204D4), M47N204D4 | 04-2004 → | 82040 |
| 323 Ci | 125 | 04/00 → 09/00 | 2.494 | B | M | 6 | 24 | M52B25 (256S4) | | 81588 |
| 323 i | 125 | 03/98 → 09/00 | 2.494 | B | M | 6 | 24 | M52B25 (256S4), M52B25TU | | 81588 |
| 325 Ci | 141 | 09/00 → 07/06 | 2.494 | B | M | 6 | 24 | M54256S5, M54B25 (256S5) | | 81588 |
| | 141 | 09/00 → 12/07 | 2.494 | B | AM | 6 | 24 | M54256S5, M54B25 (256S5) | | 81588 |
| 325 i | 141 | 09/00 → 02/05 | 2.494 | B | M | 6 | 24 | M54B25, M54B25 (256S5) | | 81588 |
| 325 ti | 141 | 06/01 → 02/05 | 2.494 | B | M | 6 | 24 | M54B25, M54B25 (256S5) | | 81588 |
| 325 xi | 141 | 09/00 → 02/05 | 2.494 | B | M | 6 | 24 | M54256S5, M54B25 (256S5) | | 81588 |
| 328 Ci | 142 | 04/99 → 06/00 | 2.793 | B | M | 6 | 24 | M52B28 (286S2) | | 81588 |
| 328 i | 142 | 02/98 → 06/00 | 2.793 | B | M | 6 | 24 | M52B28 (286S2) | | 81588 |
| 330 Cd | 150 | 08/05 → 12/07 | 2.993 | D | M | 6 | 24 | M57D30 (306D2), M57N306D2 | | 82034 |
| 330 Ci | 170 | 06/00 → 12/07 | 2.979 | B | AM | 6 | 24 | M54306S3, M54B30 (306S3) | | 81588 |
| | 170 | 06/00 → 07/06 | 2.979 | B | M | 6 | 24 | M54B30 (306S3) | | 81588 |
| 330 d | 135 | 10/99 → 02/05 | 2.926 | D | M | 6 | 24 | M57D30 (306D1) | | 81795 |
| | 150 | 03/03 → 02/05 | 2.993 | D | M | 6 | 24 | M57D30 (306D2), M57N306D2 | | 82034 |
| 330 i | 170 | 06/00 → 02/05 | 2.979 | B | M | 6 | 24 | M54B30, M54B30 (306S3) | | 81588 |
| 330 xd | 135 | 06/00 → 02/05 | 2.926 | D | M | 6 | 24 | M57D30 (306D1) | | 81795 |
| | 150 | 03/03 → 02/05 | 2.993 | D | M | 6 | 24 | M57D30 (306D2), M57N306D2 | | 82034 |
| 330 xi | 170 | 06/00 → 02/05 | 2.979 | B | M | 6 | 24 | M54B30 (306S3) | | 81588 |
| 3 V (E90), Touring (E91), Cabrio (E93), Coupé (E92) | | | | | | | | | | |
| 316 d | 85 | 07/09 → 12/11 | 1.995 | D | M | 4 | 16 | N47D20C | | 84000 |
| 316 i | 85 | 02/06 → 12/11 | 1.596 | B | M | 4 | 16 | N45B16, N45B16A, N45B16TU2 | | 82010 |

KW

cm³

NO. OF VALVES

MAGNETI MARELLI
BMW
3 V (E90), Touring (E91), Cabrio (E93), Coupé (E92)

| | | | | | | | | | | |
|--------------|-----|---------------|-------|---|---|---|----|---|-----------|-------|
| 318 d | 90 | 09/05 → 12/11 | 1.995 | D | M | 4 | 16 | M47D20 (204D4) | | 82040 |
| | 100 | 07/07 → 12/11 | 1.995 | D | M | 4 | 16 | N47D20C | | 84000 |
| | 105 | 09/05 → 12/11 | 1.995 | D | M | 4 | 16 | N47D20A, N47D20C | | 82040 |
| | 105 | 09/07 → 06/12 | 1.995 | D | M | 4 | 16 | N47D20A, N47D20C | | 84000 |
| 318 i | 95 | 09/05 → 03/07 | 1.995 | B | M | 4 | 16 | N46B20, N46B20B | | 82010 |
| | 100 | 06/07 → 12/11 | 1.995 | B | M | 4 | 16 | N46B20B, N46B20E | | 82010 |
| 320 d | 110 | 09/05 → 06/12 | 1.995 | D | M | 4 | 16 | M47D20 (204D4), M47D20TU | | 82040 |
| | 110 | 09/05 → 12/11 | 1.995 | D | M | 4 | 16 | M47D20 (204D4), M47N204D4 | | 82040 |
| | 120 | 01/05 → 12/11 | 1.995 | D | M | 4 | 16 | M47D20 (204D4), N47D20C | | 82040 |
| | 120 | 01/07 → 12/13 | 1.995 | D | M | 4 | 16 | N47D20C | → 02-2010 | 84000 |
| | 130 | 03/07 → 12/13 | 1.995 | D | M | 4 | 16 | N47D20A | → 02-2010 | 84000 |
| | 130 | 09/07 → 12/11 | 1.995 | D | M | 4 | 16 | N47D20A, N47D20C | | 84000 |
| | 135 | 01/10 → 06/12 | 1.995 | D | M | 4 | 16 | N47D20C | | 84000 |
| 320 d xDrive | 120 | 07/08 → 12/11 | 1.995 | D | M | 4 | 16 | N47D20C | | 84000 |
| | 130 | 09/08 → 12/11 | 1.995 | D | M | 4 | 16 | N47D20C | | 84000 |
| | 130 | 09/08 → 12/13 | 1.995 | D | M | 4 | 16 | N47D20C | → 02-2010 | 84000 |
| | 135 | 01/10 → 06/12 | 1.995 | D | M | 4 | 16 | N47D20C | | 84000 |
| 320 i | 110 | 03/07 → 08/07 | 1.995 | B | M | 4 | 16 | N46B20, N46B20A | | 82010 |
| | 110 | 01/05 → 03/07 | 1.995 | B | M | 4 | 16 | N46B20, N46B20A, N46B20B, N46B20C | | 82010 |
| | 110 | 09/05 → 06/12 | 1.995 | B | M | 4 | 16 | N46B20, N46B20A, N46B20C | | 82010 |
| | 110 | 11/06 → 06/07 | 1.995 | B | M | 4 | 16 | N46B20A | | 82010 |
| | 115 | 03/07 → 12/13 | 1.995 | B | M | 4 | 16 | N46B20B | | 82010 |
| | 115 | 03/07 → 12/11 | 1.995 | B | M | 4 | 16 | N46B20B, N46B20C, N46B20CC, N46B20CD, N46B20E | | 82010 |
| | 125 | 03/07 → 12/13 | 1.995 | B | M | 4 | 16 | N43B20A | | 82010 |
| 320 si | 127 | 05/06 → 12/11 | 1.997 | B | M | 4 | 16 | N45B20A | | 82010 |
| 320 xd | 130 | 03/07 → 12/13 | 1.995 | D | M | 4 | 16 | N47D20A | | 84000 |
| | 130 | 09/07 → 12/11 | 1.995 | D | M | 4 | 16 | N47D20C | | 84000 |

KW

cm³

NO. OF VALVES

MAGNETI MARELLI
BMW
3 V (E90), Touring (E91), Cabrio (E93), Coupé (E92)

| | | | | | | | | | | |
|--------------|-----|---------------|-------|---|---|---|----|---|-----------|------------------|
| 325 d | 145 | 09/06 → 12/11 | 2.993 | D | M | 6 | 24 | M57306D3, M57D30 (306D3) | | 82040 |
| | 145 | 09/06 → 06/12 | 2.993 | D | M | 6 | 24 | M57306D3, M57D30 (306D3), M57D30TU2 | | 82040 |
| | 145 | 03/07 → 12/13 | 2.993 | D | M | 6 | 24 | M57D30 (306D3) | | 82040 |
| | 145 | 03/07 → 12/13 | 2.993 | D | M | 6 | 24 | M57D30 (306D3), M57D30TU2 | | 82040 |
| | 150 | 04/10 → 12/13 | 2.993 | D | M | 6 | 24 | M57N2306D3, N57D30A | | 84022 NEW |
| | 150 | 01/10 → 12/11 | 2.993 | D | M | 6 | 24 | N57D30A | | 84022 NEW |
| | 155 | 01/07 → 12/09 | 2.993 | D | M | 6 | 24 | M57D30 (306D3) | | 82040 |
| 330 d | 170 | 03/07 → 12/13 | 2.993 | D | M | 6 | 24 | M57D30 (306D3) | | 82040 |
| | 170 | 09/05 → 12/11 | 2.993 | D | M | 6 | 24 | M57D30 (306D3), M57D30TU2 | | 82040 |
| | 180 | 01/09 → 12/11 | 2.993 | D | M | 6 | 24 | M57N2306D3, N57D30A | | 84022 NEW |
| 330 d xDrive | 180 | 01/09 → 12/11 | 2.993 | D | M | 6 | 24 | N57D30A | | 84022 NEW |
| 330 xd | 170 | 09/05 → 12/11 | 2.993 | D | M | 6 | 24 | M57D30 (306D3), M57D30TU2 | | 82040 |
| | 180 | 01/09 → 12/13 | 2.993 | D | M | 6 | 24 | M57N2306D3, N57D30A | | 84022 NEW |
| 335 d | 210 | 09/06 → 12/11 | 2.993 | D | M | 6 | 24 | M57D30 (306D5), M57N306D5 | → 03-2010 | 82040 |
| | 210 | 09/06 → 12/13 | 2.993 | D | M | 6 | 24 | M57D30 (306D5), M57N306D5 | | 82040 |

3 VI (F30, F35, F80), Touring (F31), GT (F34)

| | | | | | | | | | | |
|-------|-----|---------|-------|---|---|---|----|---------|-----------|-------|
| 316 i | 100 | 10/12 → | 1.598 | B | M | 4 | 16 | N13B16A | → 11-2012 | 82032 |
| 320 i | 125 | 02/12 → | 1.598 | B | M | 4 | 16 | N13B16A | → 11-2012 | 82032 |

5 III (E34), Touring

| | | | | | | | | | | |
|-------|-----|---------------|-------|----|---|---|----|---|-------------------------|-------|
| 518 g | 85 | 11/95 → 06/96 | 1.796 | BF | M | 4 | 8 | M43B18 (184E2) | | 81589 |
| 518 i | 83 | 08/89 → 09/95 | 1.796 | B | M | 4 | 8 | M40B18 (184E1) | 04-1989 →, → 08-1991 | 81587 |
| | 83 | 03/93 → 09/94 | 1.796 | B | M | 4 | 8 | M43B18 (184E2) | | 81589 |
| | 85 | 08/89 → 09/95 | 1.796 | B | M | 4 | 8 | M43B18 (184E2) | → 09-1991, DST:CND | 81587 |
| | 85 | 08/89 → 09/95 | 1.796 | B | M | 4 | 8 | M43B18 (184E2) | 01-1993 →, DST:CTN | 81590 |
| | 85 | 08/89 → 09/95 | 1.796 | B | M | 4 | 8 | M43B18 (184E2) | 10-1991 →, DST:CND | 81589 |
| | 85 | 09/94 → 01/97 | 1.796 | B | M | 4 | 8 | M43B18 (184E2) | → 12-1995 | 81589 |
| 520 i | 95 | 01/88 → 08/91 | 1.990 | B | M | 6 | 12 | M20B20 (206KA) | | 81616 |
| | 110 | 11/91 → 01/97 | 1.991 | B | M | 6 | 24 | M50B20, M50B20 (206S1), M50B20 (206S2), M50B20TU | | 81588 |

KW

cm³

NO. OF VALVES

BMW
5 III (E34), Touring

| | | | | | | | | | | |
|------------|-----|---------------|-------|---|---|---|----|---|-------------------------|-------|
| 520 i 24V | 110 | 09/89 → 09/95 | 1.991 | B | M | 6 | 24 | M50B20, M50B20 (206S1), M50B20 (206S2), M50B20TU | | 81588 |
| 524 td | 85 | 03/88 → 09/95 | 2.443 | D | M | 6 | 12 | M21D24, M21D24 (246TB) | 03-1988 →, → 09-1991 | 81617 |
| 525 i | 125 | 01/88 → 08/91 | 2.494 | B | M | 6 | 12 | M20B25 (256K1) | | 81616 |
| | 141 | 11/91 → 01/97 | 2.494 | B | M | 6 | 24 | M50B25 (256S1), M50B25 (256S2) | | 81588 |
| 525 i 24V | 141 | 09/89 → 09/95 | 2.494 | B | M | 6 | 24 | M50B25 (256S2), M50B25TU, M52B25 (Vanos) | | 81588 |
| 525 ix | 141 | 02/92 → 01/97 | 2.494 | B | M | 6 | 24 | M50B25 (256S1), M50B25 (256S2) | | 81588 |
| 525 iX 24V | 141 | 10/91 → 09/95 | 2.494 | B | M | 6 | 24 | M50B25 (256S1), M50B25 (256S2) | | 81588 |
| 525 td | 85 | 04/93 → 09/95 | 2.497 | D | M | 6 | 12 | M51D25 (256T1) | | 81597 |
| 525 tds | 105 | 09/91 → 09/95 | 2.503 | D | M | 6 | 12 | M51D25 (256T1) | | 81597 |
| 530 i | 138 | 01/88 → 08/91 | 2.986 | B | M | 6 | 12 | M30B30 (306KA) | 03-1988 →, → 08-1990 | 81618 |
| 535 i | 155 | 01/88 → 09/95 | 3.430 | B | M | 6 | 12 | M30B34 (346KB) | | 81618 |
| M5 | 232 | 10/88 → 05/92 | 3.535 | B | M | 6 | 24 | S38B36 (366S1) | | 81618 |
| M5 Cat. | 232 | 10/88 → 05/92 | 3.535 | B | M | 6 | 24 | S38B36 (366S1) | 03-1988 →, → 06-1994 | 81618 |

5 IV (E39), Touring

| | | | | | | | | | | |
|---------|-----|---------------|-------|---|---|---|----|---|--|-------|
| 520 d | 100 | 02/00 → 06/03 | 1.951 | D | M | 4 | 16 | M47204D1, M47D20 (204D1) | | 81794 |
| 520 i | 100 | 04/99 → 06/03 | 1.991 | B | M | 6 | 24 | M52B20 (206S3) | | 81588 |
| | 110 | 01/96 → 09/00 | 1.991 | B | M | 6 | 24 | M52B (206S4), M52B20, M52B20 (206S3) | | 81588 |
| | 125 | 09/00 → 06/03 | 2.171 | B | M | 6 | 24 | M54B22 (226S1) | | 81588 |
| | 125 | 09/00 → 05/04 | 2.171 | B | M | 6 | 24 | M54B22, M54B22 (226S1) | | 81588 |
| 523 i | 125 | 11/95 → 09/00 | 2.494 | B | M | 6 | 24 | M52B25 (256S3), M52B25TU | | 81588 |
| 525 d | 120 | 02/00 → 06/03 | 2.497 | D | M | 6 | 24 | M57D25 (256D1) | | 81795 |
| 525 i | 141 | 09/00 → 05/04 | 2.494 | B | M | 6 | 24 | M54256S5, M54B25, M54B25 (256S5) | | 81588 |
| | 141 | 09/00 → 06/03 | 2.494 | B | M | 6 | 24 | M54B25, M54B25 (256S5) | | 81588 |
| 525 td | 85 | 01/97 → 06/03 | 2.497 | D | M | 6 | 12 | M51D25 (256T1) | | 81597 |
| 525 tds | 105 | 01/96 → 06/03 | 2.503 | D | M | 6 | 12 | M51D25 (256T1) | | 81597 |
| 528 i | 142 | 11/95 → 09/00 | 2.793 | B | M | 6 | 24 | M52B28 (286S1), M52B28 (286S2) | | 81588 |

KW

cm³

NO. OF VALVES

BMW
5 IV (E39), Touring

| | | | | | | | | | | |
|-------|-----|---------------|-------|---|---|---|----|---|-------------------------|-------|
| 530 d | 135 | 08/98 → 09/00 | 2.926 | D | M | 6 | 24 | M57D30 (306D1) | 08-1998 →, → 08-1999 | 81796 |
| | 135 | 08/98 → 09/00 | 2.926 | D | M | 6 | 24 | M57D30 (306D1) | 09-1999 →, → 09-2000 | 81795 |
| | 142 | 09/00 → 06/03 | 2.926 | D | M | 6 | 24 | M57D30 (306D1) | | 81795 |
| | 142 | 09/00 → 05/04 | 2.926 | D | M | 6 | 24 | M57D30, M57D30 (306D1) | | 81795 |
| 530 i | 170 | 09/00 → 05/04 | 2.979 | B | M | 6 | 24 | M54B30 (306S3) | | 81588 |
| | 170 | 09/00 → 06/03 | 2.979 | B | M | 6 | 24 | M54B30, M54B30 (306S3) | | 81588 |
| 540 i | 210 | 01/97 → 05/04 | 4.398 | B | M | 8 | 32 | M62448S2, M62B44 (448S1), M62B44 (448S2), M62B44TU | 09-1998 →, → 05-2004 | 81796 |

5 V (E60), Touring (E61)

| | | | | | | | | | | |
|--------------|-----|---------------|-------|---|---|---|----|-------------------------------------|--|-------|
| 520 d | 110 | 09/05 → 03/10 | 1.995 | D | M | 4 | 16 | M47D20 (204D4) | | 82040 |
| | 110 | 09/05 → 12/10 | 1.995 | D | M | 4 | 16 | M47D20 (204D4), N47D20A, N47D20C | | 82040 |
| | 120 | 07/05 → 03/10 | 1.995 | D | M | 4 | 16 | M47D20 (204D4), N47D20A, N47D20C | | 82040 |
| | 130 | 09/07 → 03/10 | 1.995 | D | M | 4 | 16 | N47D20A, N47D20C | | 84000 |
| 520 i | 115 | 04/06 → 12/09 | 1.995 | B | M | 4 | 16 | N46B20B | | 82010 |
| | 125 | 09/07 → 03/10 | 1.995 | B | M | 4 | 16 | N43B20A | | 82010 |
| | 125 | 07/03 → 03/10 | 2.171 | B | M | 6 | 24 | M54B22, M54B22 (226S1) | | 81588 |
| 525 d | 120 | 12/04 → 03/10 | 2.497 | D | M | 6 | 24 | M57D25 (256D1) | | 82040 |
| | 120 | 12/04 → 12/10 | 2.497 | D | M | 6 | 24 | M57N256D4 | | 82040 |
| | 130 | 06/04 → 03/10 | 2.497 | D | M | 6 | 24 | M57D25 (256D2), M57D25TU | | 82040 |
| | 145 | 01/07 → 03/10 | 2.993 | D | M | 6 | 24 | M57D30 (306D3) | | 82040 |
| 525 d xDrive | 145 | 09/08 → 03/10 | 2.993 | D | M | 6 | 24 | M57D30 (306D3) | | 82040 |
| 525 i | 141 | 09/03 → 03/10 | 2.494 | B | M | 6 | 24 | M54256S5, M54B25, M54B25 (256S5) | | 81588 |
| | 141 | 06/04 → 12/10 | 2.494 | B | M | 6 | 24 | M54B25, M54B25 (256S5) | | 81588 |
| 525 xd | 145 | 01/07 → 03/10 | 2.993 | D | M | 6 | 24 | M57D30 (306D3) | | 82040 |

KW

cm³

NO. OF VALVES

BMW
5 V (E60), Touring (E61)

| | | | | | | | | | | |
|--------------|-----|---------------|-------|---|---|---|----|-------------------------------------|-----------|-------|
| 530 d | 155 | 07/03 → 03/10 | 2.993 | D | M | 6 | 24 | M57D30 (306D2), M57D30 (306D3) | | 82040 |
| | 155 | 11/05 → 12/10 | 2.993 | D | M | 6 | 24 | M57D30 (306D3) | | 82040 |
| | 160 | 07/03 → 03/10 | 2.993 | D | M | 6 | 24 | M57D30 (306D2) | → 03-2004 | 82040 |
| | 160 | 07/03 → 03/10 | 2.993 | D | M | 6 | 24 | M57D30 (306D2) | 04-2004 → | 82040 |
| | 160 | 06/04 → 12/10 | 2.993 | D | M | 6 | 24 | M57D30 (306D2), N57306D2 | | 82040 |
| | 170 | 07/03 → 03/10 | 2.993 | D | M | 6 | 24 | M57D30 (306D3) | → 03-2004 | 82040 |
| | 170 | 07/03 → 03/10 | 2.993 | D | M | 6 | 24 | M57D30 (306D3) | 04-2004 → | 82040 |
| | 170 | 07/05 → 12/10 | 2.993 | D | M | 6 | 24 | M57D30 (306D3) | | 82040 |
| 530 d xDrive | 173 | 01/07 → 03/10 | 2.993 | D | M | 6 | 24 | M57306D3, M57D30 (306D3) | | 82040 |
| | 173 | 09/08 → 03/10 | 2.993 | D | M | 6 | 24 | M57D30 (306D3), M57N2306D3 | | 82040 |
| 530 i | 170 | 07/03 → 03/10 | 2.979 | B | M | 6 | 24 | M54306S3, M54B30, M54B30 (306S3) | | 81588 |
| 530 xd | 170 | 07/05 → 03/10 | 2.993 | D | M | 6 | 24 | M57D30 (306D3) | | 82040 |
| | 173 | 01/07 → 03/10 | 2.993 | D | M | 6 | 24 | M57306D3, M57D30 (306D3) | | 82040 |
| | 173 | 01/07 → 12/10 | 2.993 | D | M | 6 | 24 | M57D30 (306D3) | | 82040 |
| 535 d | 200 | 09/04 → 03/10 | 2.993 | D | M | 6 | 24 | M57D30 (306D4) | | 82040 |
| | 210 | 01/07 → 03/10 | 2.993 | D | M | 6 | 24 | M57D30 (306D5), M57N306D5 | | 82040 |

5 VI (F10), Touring (F11), GT (F07)

| | | | | | | | | | | | |
|--------------|-----|---------|-------|---|---|---|----|---------|--|-------|------------|
| 525 d | 150 | 02/10 → | 2.993 | D | M | 6 | 24 | N57D30A | | 84023 | NEW |
| 530 d | 155 | 07/10 → | 2.993 | D | M | 6 | 24 | N57D30A | | 84023 | NEW |
| | 180 | 12/09 → | 2.993 | D | M | 6 | 24 | N57D30A | | 84023 | NEW |
| | 190 | 10/09 → | 2.993 | D | M | 6 | 24 | N57D30A | | 84023 | NEW |
| 530 d xDrive | 180 | 09/10 → | 2.993 | D | M | 6 | 24 | N57D30A | | 84023 | NEW |
| | 190 | 10/09 → | 2.993 | D | M | 6 | 24 | N57D30A | | 84023 | NEW |
| 535 d | 220 | 08/10 → | 2.993 | D | M | 6 | 24 | N57D30B | | 84023 | NEW |
| 535 d xDrive | 220 | 09/10 → | 2.993 | D | M | 6 | 24 | N57D30B | | 84023 | NEW |

6 I (E24)

| | | | | | | | | | | |
|---------|-----|---------------|-------|---|---|---|----|--------|-------------------------|-------|
| 635 CSi | 141 | 04/85 → 09/90 | 3.430 | B | M | 6 | 12 | M30B35 | 09-1979 →, → 12-1988 | 81618 |
|---------|-----|---------------|-------|---|---|---|----|--------|-------------------------|-------|

6 II (E63), Cabrio (E64)

| | | | | | | | | | | |
|-------|-----|---------------|-------|---|---|---|----|------------------------------|--|-------|
| 635 d | 210 | 07/07 → 07/10 | 2.993 | D | M | 6 | 24 | M57D30 (306D5), M57N306D5 | | 82040 |
| | 210 | 07/07 → 07/10 | 2.993 | D | M | 6 | 24 | M57D30 (306D5), N57N306D5 | | 82040 |

7 II (E32)

| | | | | | | | | | | |
|----------|-----|---------------|-------|---|---|---|----|----------------|--|-------|
| 730 i,iL | 138 | 12/86 → 09/94 | 2.986 | B | M | 6 | 12 | M30B30 (306KA) | | 81618 |
| | 145 | 12/86 → 09/94 | 2.986 | B | M | 6 | 12 | M30B30 (306EA) | | 81618 |
| 735 i,iL | 155 | 09/86 → 09/92 | 3.430 | B | M | 6 | 12 | M30B34 (346KB) | | 81618 |

| | | | | | | | | | | |
|--|--|--|--|--|--|--|---------------|--|--|--|
| | | | | | | | NO. OF VALVES | | | |
|--|--|--|--|--|--|--|---------------|--|--|--|

BMW

7 III (E38)

| | | | | | | | | | | |
|----------|-----|---------------|-------|---|---|---|----|-----------------------------------|-----------|-------|
| 725 tds | 105 | 04/96 → 11/01 | 2.503 | D | M | 6 | 12 | M51D25 (256T1) | | 81597 |
| 728 i,iL | 142 | 08/95 → 11/01 | 2.793 | B | M | 6 | 24 | M52B28 (286S1), M52B28 (286S2) | | 81588 |
| 728i X | 142 | 11/95 → 09/01 | 2.793 | B | M | 6 | 24 | M52B28 (286S1), M52B28TU | | 81588 |
| 730 d | 135 | 08/98 → 04/00 | 2.926 | D | A | 6 | 24 | M57D30 (306D1) | → 09-1999 | 81796 |
| | 135 | 08/98 → 04/00 | 2.926 | D | A | 6 | 24 | M57D30 (306D1) | 10-1999 → | 81795 |
| | 142 | 04/00 → 11/01 | 2.926 | D | A | 6 | 24 | M57D30 (306D1) | | 81795 |

7 IV (E65, E66)

| | | | | | | | | | | |
|----------|-----|---------------|-------|---|---|---|----|------------------------------|--|-------|
| 730 d | 155 | 10/02 → 07/08 | 2.993 | D | M | 6 | 24 | M57D30 (306D3), M57N306D2 | | 82034 |
| | 160 | 10/02 → 07/08 | 2.993 | D | M | 6 | 24 | M57D30 (306D2) | | 82034 |
| 730 i,Li | 170 | 03/03 → 07/08 | 2.979 | B | M | 6 | 24 | M54B30, M54B30 (306S3) | | 81588 |
| 730 Ld | 170 | 07/05 → 12/09 | 2.993 | D | M | 6 | 24 | M57306D3, M57D30 (306D3) | | 82034 |

7 V (F01, F02, F03, F04)

| | | | | | | | | | | |
|--------------|-----|---------------|-------|---|---|---|----|---------|--|-------|
| 730 d | 180 | 10/08 → 12/15 | 2.993 | D | M | 6 | 24 | N57D30A | | 84023 |
| 740 d | 225 | 09/09 → 12/15 | 2.993 | D | M | 6 | 24 | N57D30B | | 84023 |
| 740 d xDrive | 225 | 09/09 → 12/15 | 2.993 | D | M | 6 | 24 | N57D30B | | 84023 |

X1 I (E84)

| | | | | | | | | | | |
|-------------|-----|---------------|-------|---|---|---|----|-------------------|--|-------|
| sDrive 18 d | 100 | 03/09 → 06/15 | 1.995 | D | M | 4 | 16 | N47D20C | | 84000 |
| | 105 | 10/09 → 06/15 | 1.995 | D | M | 4 | 16 | N47D20C | | 84000 |
| sDrive 18 i | 100 | 03/09 → 06/15 | 1.995 | B | M | 4 | 16 | N46B20B | | 82010 |
| | 110 | 01/10 → 06/15 | 1.995 | B | M | 4 | 16 | N46B20B | | 82010 |
| sDrive 20 d | 120 | 03/10 → 06/15 | 1.995 | D | M | 4 | 16 | N47D20C | | 84000 |
| | 130 | 10/09 → 06/15 | 1.995 | D | M | 4 | 16 | N47D20C | | 84000 |
| xDrive 18 d | 100 | 03/09 → 06/15 | 1.995 | D | M | 4 | 16 | N47D20C | | 84000 |
| | 105 | 10/09 → 06/15 | 1.995 | D | M | 4 | 16 | N47D20C | | 84000 |
| xDrive 20 d | 120 | 03/10 → 06/15 | 1.995 | D | M | 4 | 16 | N47D20C | | 84000 |
| | 130 | 10/09 → 06/15 | 1.995 | D | M | 4 | 16 | N47D20C | | 84000 |
| xDrive 23 d | 150 | 10/09 → 06/15 | 1.995 | D | M | 4 | 16 | N47D20C, N47SD20D | | 84000 |

X1 II (F48)

| | | | | | | | | | | |
|-------------|-----|---------|-------|---|---|---|----|---------|--|-------|
| sDrive 18 i | 100 | 11/15 → | 1.499 | B | M | 3 | 12 | B38A15A | | 84049 |
| sDrive 20 i | 141 | 09/15 → | 1.998 | B | M | 4 | 16 | B48A20A | | 84049 |
| | 141 | 09/15 → | 1.998 | B | M | 4 | 16 | B48A20A | | 84049 |
| xDrive 25 i | 170 | 09/15 → | 1.998 | B | M | 4 | 16 | B48A20B | | 84049 |

X3 I (E83)

| | | | | | | | | | | |
|-------|-----|---------------|-------|---|---|---|----|-------------------------------------|--|-------|
| 2.0 d | 110 | 10/04 → 12/10 | 1.995 | D | M | 4 | 16 | M47D20 (204D4) | | 82040 |
| | 130 | 09/07 → 03/09 | 1.995 | D | M | 4 | 16 | N47D20A, N47D20C | | 84000 |
| 2.0 i | 110 | 07/05 → 08/08 | 1.995 | B | M | 4 | 16 | N46B20, N46B20B | | 82010 |
| 2.5 i | 141 | 01/04 → 08/06 | 2.494 | B | M | 6 | 24 | M54256S5, M54B25, M54B25 (256S5) | | 81588 |

KW

cm³

NO. OF VALVES

BMW
X3 I (E83)

| | | | | | | | | | | |
|--------------|-----|---------------|-------|---|---|---|----|-------------------------------------|-----------|-------|
| 3.0 d | 150 | 01/04 → 08/05 | 2.993 | D | M | 6 | 24 | M57D30 (306D2), M57N2306D2 | | 82040 |
| | 160 | 01/04 → 08/08 | 2.993 | D | M | 6 | 24 | M57D30 (306D3) | → 03-2010 | 82040 |
| 3.0 i xDrive | 170 | 01/04 → 08/06 | 2.979 | B | M | 6 | 24 | M54306S3, M54B30, M54B30 (306S3) | | 81588 |
| 3.0 sd | 210 | 09/06 → 08/08 | 2.993 | D | M | 6 | 24 | M57D30 (306D5) | | 82040 |
| xDrive 18 d | 105 | 09/08 → 12/11 | 1.995 | D | M | 4 | 16 | N47D20C | | 84000 |
| xDrive 20 d | 120 | 09/08 → 08/10 | 1.995 | D | M | 4 | 16 | N47D20C | | 84000 |
| | 130 | 09/08 → 08/10 | 1.995 | D | M | 4 | 16 | N47D20C | | 84000 |
| xDrive 20 i | 110 | 09/08 → 08/11 | 1.995 | B | M | 4 | 16 | N46B20B | | 82010 |
| xDrive 30 d | 160 | 09/08 → 04/11 | 2.993 | D | M | 6 | 24 | M57D30 (306D3), M57N2306D3 | → 03-2010 | 82040 |
| xDrive 35 d | 210 | 09/08 → 08/11 | 2.993 | D | M | 6 | 24 | M57D30 (306D5) | | 82040 |

X5 I (E53)

| | | | | | | | | | | |
|-------|-----|---------------|-------|---|---|---|----|-------------------------------------|--|-------|
| 3.0 d | 135 | 05/01 → 12/03 | 2.925 | D | A | 6 | 24 | M57D30 (306D1) | | 81795 |
| | 155 | 09/03 → 12/06 | 2.993 | D | M | 6 | 24 | M57D30 (306D2), M57N306D2 | | 82034 |
| | 160 | 12/03 → 12/06 | 2.993 | D | M | 6 | 24 | M57D30 (306D2) | | 82034 |
| 3.0 i | 163 | 05/00 → 12/06 | 2.979 | B | M | 6 | 24 | M54B30 (306S3) | | 81588 |
| | 170 | 05/00 → 12/06 | 2.979 | B | M | 6 | 24 | M54306S3, M54B30, M54B30 (306S3) | | 81588 |

X5 II (E70)

| | | | | | | | | | | |
|-------------|-----|---------------|-------|---|---|---|----|------------------------------|--|------------------|
| 3.0 d | 155 | 02/07 → 09/08 | 2.993 | D | M | 6 | 24 | M57D30 (306D3) | | 82040 |
| | 173 | 02/07 → 09/08 | 2.993 | D | M | 6 | 24 | M57306D3, M57D30 (306D3) | | 82040 |
| 3.0 sd | 210 | 09/07 → 02/09 | 2.993 | D | M | 6 | 24 | M57D30 (306D5), M57N306D5 | | 82040 |
| xDrive 30 d | 155 | 09/08 → 06/13 | 2.993 | D | M | 6 | 24 | N57D30A | | 84023 NEW |
| | 173 | 09/08 → 06/13 | 2.993 | D | M | 6 | 24 | N57D30A | | 82040 |
| | 180 | 09/10 → 06/13 | 2.993 | D | M | 6 | 24 | N57D30A | | 84023 NEW |
| xDrive 35 d | 210 | 09/08 → 06/13 | 2.993 | D | M | 6 | 24 | M57D30 (306D5) | | 82040 |
| xDrive 40 d | 225 | 09/10 → 06/13 | 2.993 | D | M | 6 | 24 | N57D30B | | 84023 NEW |

X6 I (E71, E72)

| | | | | | | | | | | |
|-------------|-----|---------------|-------|---|---|---|----|---|--|------------------|
| 30 d | 173 | 05/08 → 08/08 | 2.993 | D | M | 6 | 24 | M57D30 (306D3) | | 82040 |
| 35 d | 210 | 05/08 → 08/08 | 2.993 | D | M | 6 | 24 | M57D30 (306D5) | | 82040 |
| xDrive 30 d | 155 | 09/10 → 06/14 | 2.993 | D | M | 6 | 24 | N57D30A | | 84023 NEW |
| xDrive 30 d | 173 | 09/08 → 06/14 | 2.993 | D | M | 6 | 24 | N57D30A | | 82040 |
| | 180 | 09/10 → 06/14 | 2.993 | D | M | 6 | 24 | M57D30 (306D3), M57N2306D3, N57D30A | | 84023 NEW |
| xDrive 35 d | 210 | 09/08 → 06/14 | 2.993 | D | M | 6 | 24 | M57D30 (306D5), N57N306D5 | | 82040 |
| xDrive 40 d | 225 | 10/10 → 06/14 | 2.993 | D | M | 6 | 24 | N57D30B | | 84023 NEW |

| | | | | | | | | | | |
|--|--|-----------|--|-----------------------|--|--|--|----------------------|--|--|
| | | KW | | cm³ | | | | NO. OF VALVES | | |
|--|--|-----------|--|-----------------------|--|--|--|----------------------|--|--|

BMW

Z1

| | | | | | | | | | | |
|-----|-----|---------------|-------|---|---|---|----|----------------|-------------------------|-------|
| 2.5 | 125 | 06/88 → 06/91 | 2.494 | B | M | 6 | 12 | M20B25 (256K1) | 11-1988 →, → 10-1991 | 81616 |
|-----|-----|---------------|-------|---|---|---|----|----------------|-------------------------|-------|

Z3 (E36), Coupé

| | | | | | | | | | | |
|-----|----|---------------|-------|---|---|---|---|----------------|-----------|-------|
| 1.8 | 85 | 10/95 → 10/98 | 1.796 | B | M | 4 | 8 | M43B18 (184E2) | M: M42B18 | 81590 |
|-----|----|---------------|-------|---|---|---|---|----------------|-----------|-------|

| | | | | | | | | | | |
|-----|----|---------------|-------|---|---|---|---|-----------------------------|-------------|-------|
| 1.9 | 85 | 01/99 → 01/03 | 1.895 | B | M | 4 | 8 | M43194E1, M43B19 (194E1) | M: M44B19 C | 81590 |
|-----|----|---------------|-------|---|---|---|---|-----------------------------|-------------|-------|

| | | | | | | | | | | |
|-----|----|---------------|-------|---|---|---|---|--|--|-------|
| 1.9 | 87 | 07/98 → 01/03 | 1.895 | B | M | 4 | 8 | M43194E1, M43B19 (194E1), M43B19TU | | 81590 |
|-----|----|---------------|-------|---|---|---|---|--|--|-------|

| | | | | | | | | | | |
|--|-----|---------------|-------|---|---|---|----|----------------|-------------|-------|
| | 103 | 10/95 → 03/99 | 1.895 | B | M | 4 | 16 | M44B19 (194S1) | M: M44B19 C | 81590 |
|--|-----|---------------|-------|---|---|---|----|----------------|-------------|-------|

| | | | | | | | | | | |
|-----|-----|---------------|-------|---|---|---|----|---------------------------|-----------|-------|
| 2.0 | 110 | 04/99 → 01/03 | 1.991 | B | M | 6 | 24 | M52B20, M52B20 (206S4) | 04-1999 → | 81588 |
|-----|-----|---------------|-------|---|---|---|----|---------------------------|-----------|-------|

| | | | | | | | | | | |
|-----|-----|---------------|-------|---|---|---|----|-------------------------------------|--|-------|
| 2.2 | 125 | 08/00 → 01/03 | 2.171 | B | M | 6 | 24 | M54226S1, M54B22, M54B22 (226S1) | | 81588 |
|-----|-----|---------------|-------|---|---|---|----|-------------------------------------|--|-------|

| | | | | | | | | | | |
|-----|-----|---------------|-------|---|---|---|----|----------------|--|-------|
| 2.8 | 141 | 07/97 → 06/00 | 2.793 | B | M | 6 | 24 | M52B28 (286S1) | | 81588 |
|-----|-----|---------------|-------|---|---|---|----|----------------|--|-------|

| | | | | | | | | | | |
|-----|-----|---------------|-------|---|---|---|----|-----------------------------|--|-------|
| 2.8 | 141 | 04/97 → 06/00 | 2.793 | B | M | 6 | 24 | M52B28 (286S1), M52B28TU | | 81588 |
|-----|-----|---------------|-------|---|---|---|----|-----------------------------|--|-------|

| | | | | | | | | | | |
|-----|-----|---------------|-------|---|---|---|----|-----------------------------|--|-------|
| 3.0 | 170 | 06/00 → 06/03 | 2.979 | B | M | 6 | 24 | M54306S3, M54B30 (306S3) | | 81588 |
|-----|-----|---------------|-------|---|---|---|----|-----------------------------|--|-------|

| | | | | | | | | | | |
|-----|-----|---------------|-------|---|---|---|----|---------------------------|--|-------|
| 3.0 | 170 | 06/00 → 01/03 | 2.979 | B | M | 6 | 24 | M54B30, M54B30 (306S3) | | 81588 |
|-----|-----|---------------|-------|---|---|---|----|---------------------------|--|-------|

Z4 I (E85), Coupé (E86)

| | | | | | | | | | | |
|-------|-----|---------------|-------|---|---|---|----|-----------------------------|--|-------|
| 2.0 i | 110 | 03/05 → 02/09 | 1.995 | B | M | 4 | 16 | N46B20, N46B20A, N46B20B | | 82010 |
|-------|-----|---------------|-------|---|---|---|----|-----------------------------|--|-------|

| | | | | | | | | | | |
|-------|-----|---------------|-------|---|---|---|----|---------------------------|--|-------|
| 2.2 i | 125 | 10/03 → 10/05 | 2.171 | B | M | 6 | 24 | M54B22, M54B22 (226S1) | | 81588 |
|-------|-----|---------------|-------|---|---|---|----|---------------------------|--|-------|

| | | | | | | | | | | |
|-------|-----|---------------|-------|---|---|---|----|---------------------------|--|-------|
| 2.5 i | 141 | 02/03 → 12/05 | 2.494 | B | M | 6 | 24 | M54B25, M54B25 (256S5) | | 81588 |
|-------|-----|---------------|-------|---|---|---|----|---------------------------|--|-------|

| | | | | | | | | | | |
|-------|-----|---------------|-------|---|---|---|----|---------------------------|--|-------|
| 3.0 i | 170 | 02/03 → 10/05 | 2.979 | B | M | 6 | 24 | M54B30, M54B30 (306S3) | | 81588 |
|-------|-----|---------------|-------|---|---|---|----|---------------------------|--|-------|

CADILLAC

BLS, Station Wagon

| | | | | | | | | | | |
|-------|-----|---------|-------|---|---|---|----|--------|--|-------|
| 1.9 D | 110 | 04/06 → | 1.910 | D | M | 4 | 16 | Z19DTH | | 81872 |
|-------|-----|---------|-------|---|---|---|----|--------|--|-------|

| | | | | | | | | | | |
|-------|-----|---------|-------|---|---|---|----|--------|--|-------|
| 1.9 D | 132 | 12/07 → | 1.910 | D | M | 4 | 16 | Z19DTR | | 81872 |
|-------|-----|---------|-------|---|---|---|----|--------|--|-------|

CTS I

| | | | | | | | | | | |
|-----|-----|---------------|-------|---|---|---|----|-----|--|-------|
| 2.8 | 158 | 03/05 → 09/07 | 2.792 | B | M | 6 | 24 | LP1 | | 84057 |
|-----|-----|---------------|-------|---|---|---|----|-----|--|-------|

| | | | | | | | | | | |
|-----|-----|---------------|-------|---|---|---|----|-----|--|-------|
| 3.6 | 189 | 03/05 → 09/07 | 3.564 | B | M | 6 | 24 | LY7 | | 84057 |
|-----|-----|---------------|-------|---|---|---|----|-----|--|-------|

CTS II, Station Wagon, Coupé

| | | | | | | | | | | |
|-----|-----|---------|-------|---|---|---|----|-----|--|-------|
| 2.8 | 155 | 01/08 → | 2.792 | B | M | 6 | 24 | LP1 | | 84057 |
|-----|-----|---------|-------|---|---|---|----|-----|--|-------|

| | | | | | | | | | | |
|-----|-----|---------|-------|---|---|---|----|-----|--|-------|
| 3.6 | 229 | 01/08 → | 3.564 | B | M | 6 | 24 | LLT | | 84057 |
|-----|-----|---------|-------|---|---|---|----|-----|--|-------|

| | | | | | | | | | | |
|---------|-----|---------|-------|---|---|---|----|-----|--|-------|
| 3.6 AWD | 229 | 01/08 → | 3.564 | B | M | 6 | 24 | LLT | | 84057 |
|---------|-----|---------|-------|---|---|---|----|-----|--|-------|

SRX I

| | | | | | | | | | | |
|---------|-----|---------------|-------|---|---|---|----|-----|--|-------|
| 3.6 AWD | 190 | 07/04 → 12/08 | 3.564 | B | M | 6 | 24 | LY7 | | 84057 |
|---------|-----|---------------|-------|---|---|---|----|-----|--|-------|

KW

cm³

NO. OF VALVES

CADILLAC

STS

| | | | | | | | | | | | |
|-----|-----|---------------|-------|---|---|---|----|-----|--|-------|------------|
| 3.6 | 189 | 05/05 → 12/07 | 3.564 | B | M | 6 | 24 | LY7 | | 84057 | NEW |
|-----|-----|---------------|-------|---|---|---|----|-----|--|-------|------------|

CHEVROLET

Aveo I

| | | | | | | | | | | | |
|-----|----|---------------|-------|---|---|---|----|-------------------|--|-------|--|
| 1.2 | 53 | 03/06 → 12/07 | 1.150 | B | M | 4 | 8 | B12S1, F12S3, LY4 | | 81783 | |
| 1.5 | 62 | 01/05 → 05/08 | 1.498 | B | M | 4 | 8 | F15S3 | | 81781 | |
| | 62 | 05/05 → | 1.498 | B | M | 4 | 8 | F15S3, LX6 | | 81781 | |
| 1.6 | 77 | 09/03 → | 1.598 | B | M | 4 | 16 | A16DMS, LXT, LXV | | 81782 | |

Aveo II

| | | | | | | | | | | | |
|-----------|-----|---------|-------|---|---|---|----|----------|--|-------|------------|
| 1.2 | 51 | 03/11 → | 1.229 | B | M | 4 | 16 | A12XEL | | 84027 | NEW |
| | 63 | 03/11 → | 1.229 | B | M | 4 | 16 | A12XER | | 84027 | NEW |
| 1.2 LPG | 63 | 11/12 → | 1.229 | | M | 4 | 16 | A12XER | | 84027 | NEW |
| 1.4 | 74 | 03/11 → | 1.398 | B | M | 4 | 16 | A14XER | | 84027 | NEW |
| 1.4 Turbo | 103 | 08/13 → | 1.364 | B | M | 4 | 16 | LUJ, LUV | | 84027 | NEW |
| 1.6 | 85 | 03/11 → | 1.598 | B | M | 4 | 16 | F16D4 | | 82083 | |

Captiva

| | | | | | | | | | | | |
|-------------|-----|---------|-------|---|---|---|----|--------------|--|-------|------------|
| 2.0 D | 93 | 10/06 → | 1.991 | D | M | 4 | 16 | Z20S | | 84014 | NEW |
| | 110 | 09/07 → | 1.991 | D | M | 4 | 16 | Z20DMH, Z20S | | 84014 | NEW |
| 2.0 D 4WD | 93 | 10/06 → | 1.991 | D | M | 4 | 16 | Z20S | | 84014 | NEW |
| | 110 | 10/06 → | 1.991 | D | M | 4 | 16 | Z20DMH, Z20S | | 84014 | NEW |
| 2.4 | 123 | 03/11 → | 2.384 | B | M | 4 | 16 | A24XE, LE5 | | 81812 | |
| | 100 | 06/06 → | 2.405 | B | M | 4 | 16 | Z24SED | | 81550 | |
| 2.4 4WD | 123 | 03/11 → | 2.384 | B | M | 4 | 16 | A24XE, LE5 | | 81812 | |
| | 100 | 06/06 → | 2.405 | B | M | 4 | 16 | Z24SED | | 81550 | |
| 2.4 LPG | 100 | 01/07 → | 2.405 | | M | 4 | 16 | Z24SED | | 81550 | |
| 2.4 LPG 4WD | 100 | 01/07 → | 2.405 | | M | 4 | 16 | Z24SED | | 81550 | |
| 3.2 4WD | 169 | 06/06 → | 3.195 | B | M | 6 | 24 | 10HM | | 84057 | NEW |

Cruze II, Hatchback, Station Wagon

| | | | | | | | | | | | |
|--------|-----|---------|-------|---|---|---|----|------------------|--|-------|------------|
| 1.4 | 103 | 06/12 → | 1.362 | B | M | 4 | 16 | LUJ | | 84027 | NEW |
| | 103 | 09/10 → | 1.364 | B | M | 4 | 16 | A14NET, LUJ, LUV | | 84027 | NEW |
| | 74 | 07/13 → | 1.398 | B | M | 4 | 16 | A14XER, LDD | | 84027 | NEW |
| | 103 | 10/13 → | 1.398 | B | M | 4 | 16 | A14NET | | 84027 | NEW |
| 1.6 | 80 | 05/09 → | 1.598 | B | M | 4 | 16 | F16D3, LXT, LXV | | 82083 | |
| | 80 | 01/12 → | 1.598 | B | M | 4 | 16 | LXT | | 82083 | |
| | 83 | 05/09 → | 1.598 | B | M | 4 | 16 | F16D4 | | 82083 | |
| | 86 | 12/12 → | 1.598 | B | M | 4 | 16 | F16D4 | | 82083 | |
| | 86 | 12/12 → | 1.598 | B | M | 4 | 16 | LDE | | 81782 | |
| | 86 | 12/12 → | 1.598 | B | M | 4 | 16 | LDE | | 82083 | |
| | 91 | 06/11 → | 1.598 | B | M | 4 | 16 | F16D4 | | 82083 | |
| | 91 | 05/09 → | 1.598 | B | M | 4 | 16 | F16D4, LDE | | 82083 | |
| | 91 | 08/12 → | 1.598 | B | M | 4 | 16 | LDE | | 82083 | |
| 1.7 D | 96 | 01/12 → | 1.686 | D | M | 4 | 16 | LUD | | 84005 | |
| 1.7 TD | 96 | 08/12 → | 1.686 | D | M | 4 | 16 | LUD | | 84005 | |

KW

cm³

NO. OF VALVES

CHEVROLET
Cruze II, Hatchback, Station Wagon

| | | | | | | | | | | |
|---------|-----|---------|-------|---|---|---|----|---------------|--|------------------|
| 1.8 | 104 | 08/12 → | 1.796 | B | M | 4 | 16 | 2H0 | | 82083 |
| | 104 | 05/09 → | 1.796 | B | M | 4 | 16 | 2H0, F18D4 | | 82083 |
| | 104 | 06/11 → | 1.796 | B | M | 4 | 16 | F18D4 | | 82083 |
| 1.8 LPG | 104 | 06/11 → | 1.796 | | M | 4 | 16 | 2H0, F18D4 | | 82083 |
| | 104 | 06/11 → | 1.796 | | M | 4 | 16 | F18D4 | | 82083 |
| 2.0 CDI | 90 | 05/09 → | 1.991 | D | M | 4 | 16 | Z20S1 | | 84014 NEW |
| | 92 | 05/09 → | 1.991 | D | M | 4 | 16 | Z20S1 | | 84014 NEW |
| | 110 | 05/09 → | 1.991 | D | M | 4 | 16 | Z20DMH, Z20S1 | | 84014 NEW |

Epica

| | | | | | | | | | | |
|-------|-----|---------------|-------|---|---|---|----|--------|--|------------------|
| 2.0 | 94 | 01/05 → 12/06 | 1.998 | B | M | 4 | 16 | C20SED | | 81550 |
| | 98 | 01/05 → 12/06 | 1.998 | B | M | 4 | 16 | T20SED | | 81550 |
| 2.0 D | 110 | 01/07 → | 1.991 | D | M | 4 | 16 | Z20S | | 84014 NEW |

Evanda

| | | | | | | | | | | |
|-----|----|---------|-------|---|---|---|----|--------|--|-------|
| 2.0 | 96 | 03/05 → | 1.998 | B | M | 4 | 16 | X20SED | | 81550 |
|-----|----|---------|-------|---|---|---|----|--------|--|-------|

HHR

| | | | | | | | | | | |
|-----|-----|---------------|-------|---|---|---|----|-----|--|-------|
| 2.4 | 125 | 10/07 → 12/11 | 2.384 | B | M | 4 | 16 | LE5 | | 81812 |
|-----|-----|---------------|-------|---|---|---|----|-----|--|-------|

Kalos

| | | | | | | | | | | |
|---------|----|---------|-------|---|---|---|----|-------|--|-------|
| 1.2 | 53 | 03/05 → | 1.150 | B | M | 4 | 8 | B12S1 | | 81781 |
| | 53 | 03/05 → | 1.150 | B | M | 4 | 8 | F12S3 | | 81783 |
| 1.4 | 61 | 03/05 → | 1.399 | B | M | 4 | 8 | F14S3 | | 81782 |
| 1.4 16V | 69 | 03/05 → | 1.399 | B | M | 4 | 16 | F14D3 | | 81782 |

Lacetti

| | | | | | | | | | | |
|---------|----|---------------|-------|---|---|---|----|--------|--|------------------|
| 1.4 16V | 70 | 03/05 → | 1.399 | B | M | 4 | 16 | F14D3 | | 81782 |
| 1.6 | 80 | 03/05 → | 1.598 | B | M | 4 | 16 | F16D3 | | 81782 |
| 1.8 | 67 | 03/05 → 12/09 | 1.796 | B | M | 4 | 8 | F18D2 | | 81550 |
| | 89 | 08/05 → | 1.796 | B | M | 4 | 16 | F18D3 | | 81782 |
| | 89 | 08/05 → | 1.799 | B | M | 4 | 16 | T18SED | | 81550 |
| | 90 | 03/05 → | 1.799 | B | M | 4 | 16 | T18SED | | 81782 |
| 2.0 D | 89 | 01/07 → | 1.991 | D | M | 4 | 16 | Z20DM | | 84014 NEW |

Malibu

| | | | | | | | | | | |
|-------|-----|---------|-------|---|---|---|----|-----|--|-------|
| 2.0 D | 118 | 04/12 → | 1.956 | D | M | 4 | 16 | LBS | | 81872 |
| 2.4 | 123 | 01/12 → | 2.384 | B | M | 4 | 16 | LE9 | | 81812 |
| | 125 | 01/12 → | 2.384 | B | M | 4 | 16 | LE9 | | 81812 |

Matiz

| | | | | | | | | | | |
|---------|----|---------|-----|---|---|---|---|-------|--|-------|
| 0.8 | 38 | 03/05 → | 796 | B | M | 3 | 6 | F8CV | | 81783 |
| 0.8 LPG | 38 | 03/05 → | 796 | | M | 3 | 6 | F8CV | | 81783 |
| 1.0 | 47 | 03/05 → | 995 | B | M | 4 | 8 | B10S | | 81783 |
| | 49 | 03/05 → | 995 | B | M | 4 | 8 | B10S1 | | 81783 |
| 1.0 LPG | 49 | 03/05 → | 995 | | M | 4 | 8 | B10S1 | | 81783 |

Nubira, Station Wagon

| | | | | | | | | | | |
|-----|----|---------|-------|---|---|---|----|-------|--|-------|
| 1.4 | 69 | 01/05 → | 1.399 | B | M | 4 | 16 | F14D3 | | 81782 |
| | 70 | 01/06 → | 1.399 | B | M | 4 | 16 | F14D3 | | 81782 |
| 1.6 | 80 | 03/05 → | 1.598 | B | M | 4 | 16 | F16D3 | | 81782 |

KW

cm³

NO. OF VALVES

MAGNETI MARELLI

CHEVROLET

Nubira, Station Wagon

| | | | | | | | | | | |
|-------|----|---------|-------|---|---|---|----|-------------|--|------------------|
| 1.8 | 89 | 08/05 → | 1.796 | B | M | 4 | 16 | F18D3 | | 81782 |
| | 90 | 03/05 → | 1.799 | B | M | 4 | 16 | T18SED | | 81782 |
| 2.0 D | 89 | 01/07 → | 1.991 | D | M | 4 | 16 | Z20DM, Z20S | | 84014 NEW |
| | 89 | 01/05 → | 1.991 | D | M | 4 | 16 | Z20S | | 84014 NEW |

Orlando

| | | | | | | | | | | |
|-----|-----|---------|-------|---|---|---|----|-----|--|------------------|
| 1.4 | 103 | 06/12 → | 1.362 | B | M | 4 | 16 | LUJ | | 84027 NEW |
|-----|-----|---------|-------|---|---|---|----|-----|--|------------------|

Rezzo

| | | | | | | | | | | |
|-----|----|---------|-------|---|---|---|----|--------|--|-------|
| 1.6 | 77 | 03/05 → | 1.598 | B | M | 4 | 16 | A16DMS | | 81782 |
| | 79 | 08/05 → | 1.598 | B | M | 4 | 16 | A16DMS | | 81782 |
| 2.0 | 89 | 03/05 → | 1.998 | B | M | 4 | 16 | T20SED | | 81550 |
| | 90 | 08/05 → | 1.998 | B | M | 4 | 16 | T20SED | | 81550 |

Spark I

| | | | | | | | | | | |
|-----|----|---------------|-----|---|---|---|---|-------|--|-------|
| 0.8 | 38 | 09/00 → 12/04 | 796 | B | M | 3 | 6 | F8CV | | 81783 |
| 1.0 | 47 | 11/02 → 12/04 | 993 | B | M | 4 | 8 | G10CV | | 81783 |

Spark II

| | | | | | | | | | | |
|--------|----|---------|-----|---|---|---|---|-----------|--|-------|
| 0.8 | 37 | 05/05 → | 796 | B | M | 3 | 6 | F8CV | | 81783 |
| 1.0 SX | 46 | 05/05 → | 995 | B | M | 4 | 8 | B10S, LA2 | | 81783 |
| | 49 | 05/05 → | 995 | B | M | 4 | 8 | B10S1 | | 81783 |

Trax

| | | | | | | | | | | |
|------------|-----|---------|-------|---|---|---|----|----------------|--|------------------|
| 1.4 | 103 | 12/12 → | 1.364 | B | M | 4 | 16 | LUJ, LUV | | 84027 NEW |
| 1.4 AWD | 103 | 12/12 → | 1.364 | B | M | 4 | 16 | LUJ | | 84027 NEW |
| 1.4 LPG | 103 | 04/13 → | 1.364 | | M | 4 | 16 | A14NET, B14NET | | 84027 NEW |
| 1.6 | 85 | 12/12 → | 1.598 | B | M | 4 | 16 | F16D4, LDE | | 82083 |
| 1.7 TD | 96 | 12/12 → | 1.686 | D | M | 4 | 16 | LUD | | 84005 |
| 1.7 TD AWD | 96 | 12/12 → | 1.686 | D | M | 4 | 16 | LUD | | 84005 |

CHRYSLER

300 C, Touring

| | | | | | | | | | | |
|---------|-----|---------------|-------|---|---|---|----|-----|--|-------|
| 3.0 CRD | 160 | 09/05 → 11/12 | 2.987 | D | M | 6 | 24 | EXL | | 82058 |
|---------|-----|---------------|-------|---|---|---|----|-----|--|-------|

Delta

| | | | | | | | | | | |
|----------------|-----|---------|-------|---|---|---|----|-----------|----------|-------|
| 1.4 | 88 | 08/11 → | 1.368 | B | M | 4 | 16 | 198A4.000 | PIERBURG | 81369 |
| | 88 | 08/11 → | 1.368 | B | M | 4 | 16 | 198A4.000 | TESMA | 82070 |
| 1.4 16V | 103 | 08/11 → | 1.368 | B | M | 4 | 16 | 198A7.000 | PIERBURG | 81369 |
| | 103 | 08/11 → | 1.368 | B | M | 4 | 16 | 198A7.000 | TESMA | 82070 |
| 1.6 D Multijet | 88 | 08/11 → | 1.598 | D | M | 4 | 16 | 198A2.000 | | 81872 |
| 2.0 D Multijet | 121 | 08/11 → | 1.956 | D | M | 4 | 16 | 198A5.000 | | 81872 |

Grand Voyager V

| | | | | | | | | | | |
|---------|-----|---------|-------|---|---|---|----|-----|--|------------------|
| 2.8 CRD | 120 | 10/07 → | 2.768 | D | M | 4 | 16 | | | 84033 NEW |
| | 120 | 10/07 → | 2.777 | D | M | 4 | 16 | ENS | | 84033 NEW |
| | 132 | 09/12 → | 2.777 | D | M | 4 | 16 | ENS | | 84043 NEW |

| | | | | | | | | | |
|--|----|--|-----------------|--|--|--|---------------|--|--|
| | KW | | cm ³ | | | | NO. OF VALVES | | |
|--|----|--|-----------------|--|--|--|---------------|--|--|

CHRYSLER

Neon I

| | | | | | | | | | | |
|---------|-----|---------------|-------|---|---|---|----|------|--|-------|
| 1.8 16V | 85 | 09/97 → 08/99 | 1.796 | B | M | 4 | 16 | EBD | | 81733 |
| 2.0 16V | 98 | 05/94 → 08/99 | 1.996 | B | M | 4 | 16 | 420H | | 81733 |
| | 107 | 06/94 → 08/99 | 1.996 | B | M | 4 | 16 | ECC | | 81733 |
| | 109 | 04/96 → 08/99 | 1.996 | B | M | 4 | 16 | 420T | | 81733 |

Neon II

| | | | | | | | | | | |
|-------------|-----|---------------|-------|---|---|---|----|-----------|--|-------|
| 1.6 | 85 | 11/01 → 12/06 | 1.598 | B | M | 4 | 16 | EJD | | 81733 |
| 2.0 16V | 98 | 08/99 → 12/06 | 1.996 | B | M | 4 | 16 | 420H, ECB | | 81733 |
| 2.0 16V R/T | 110 | 10/01 → 12/06 | 1.996 | B | M | 4 | 16 | ECH | | 81733 |

PT Cruiser, Cabrio

| | | | | | | | | | | |
|-----|-----|---------------|-------|---|----|---|----|-----|--|-------|
| 1.6 | 85 | 11/01 → 12/10 | 1.598 | B | M | 4 | 16 | EJD | | 81733 |
| 2.0 | 100 | 10/04 → 12/10 | 1.996 | B | M | 4 | 16 | ECC | | 81733 |
| | 104 | 06/00 → 12/10 | 1.996 | B | AM | 4 | 16 | ECC | | 81733 |

Sebring II, Cabrio

| | | | | | | | | | | |
|-----|-----|---------------|-------|---|---|---|----|-----|--|-------|
| 2.0 | 104 | 04/01 → 06/07 | 1.996 | B | M | 4 | 16 | ECC | | 81733 |
|-----|-----|---------------|-------|---|---|---|----|-----|--|-------|

Sebring III, Cabrio

| | | | | | | | | | | |
|---------|-----|---------------|-------|---|---|---|----|-----|--|------------------|
| 2.0 CRD | 103 | 07/07 → 12/10 | 1.968 | D | M | 4 | 16 | ECD | | 81816 |
| | 103 | 07/07 → 12/10 | 1.968 | D | M | 4 | 16 | ECD | | 84011 NEW |

Stratus, Cabrio

| | | | | | | | | | | |
|---------|----|---------------|-------|---|---|---|----|------|--|-------|
| 2.0 16V | 98 | 12/95 → 04/01 | 1.996 | B | M | 4 | 16 | ECB | | 81733 |
| 2.0 LE | 96 | 06/96 → 04/01 | 1.996 | B | M | 4 | 16 | 420X | | 81733 |
| | 96 | 12/95 → 04/01 | 1.996 | B | M | 4 | 16 | C00 | | 81733 |

Voyager II

| | | | | | | | | | | |
|--------|----|---------------|-------|---|---|---|---|----------|--|-------|
| 2.5 i | 72 | 01/91 → 09/95 | 2.501 | B | M | 4 | 8 | K00 | | 81302 |
| | 74 | 08/90 → 09/95 | 2.501 | B | M | 4 | 8 | K | | 81302 |
| 2.5 TD | 87 | 01/92 → 09/95 | 2.500 | D | M | 4 | 8 | 09B, M00 | | 81302 |

Voyager III

| | | | | | | | | | | |
|--------|----|---------------|-------|---|---|---|----|-----------------|--------|-------|
| 2.0 i | 98 | 01/95 → 03/01 | 1.995 | B | M | 4 | 16 | C00 | | 81733 |
| 2.5 TD | 85 | 01/95 → 03/01 | 2.499 | D | M | 4 | 8 | 425CLIRS/X, ENC | (-)COP | 81362 |

Voyager IV

| | | | | | | | | | | |
|---------|-----|---------------|-------|---|---|---|----|-----|--|------------------|
| 2.5 CRD | 88 | 08/05 → 12/08 | 2.499 | D | M | 4 | 16 | EDK | | 84033 NEW |
| | 105 | 02/00 → 12/08 | 2.499 | D | M | 4 | 16 | ENJ | | 84033 NEW |
| 2.8 CRD | 110 | 06/04 → 12/08 | 2.776 | D | M | 4 | 16 | ENR | | 84033 NEW |

Ypsilon

| | | | | | | | | | | |
|--------------|----|---------|-------|---|---|---|----|-----------|----------|-------|
| 0.9 Twinair | 63 | 05/11 → | 875 | B | M | 2 | 8 | 312A2.000 | | 84008 |
| 1.2 | 51 | 05/11 → | 1.242 | B | M | 4 | 8 | 169A4.000 | PIERBURG | 81369 |
| | 51 | 05/11 → | 1.242 | B | M | 4 | 8 | 169A4.000 | TESMA | 82070 |
| 1.3 Multijet | 70 | 05/11 → | 1.248 | D | M | 4 | 16 | 199B1.000 | | 81862 |

CITROËN

AX

| | | | | | | | | | | |
|------------|----|---------------|-------|---|---|---|---|------------|--|-------|
| 1.4 4x4 | 62 | 09/86 → 07/92 | 1.360 | B | M | 4 | 8 | K2A | | 81556 |
| 1.4 Allure | 48 | 08/92 → 04/94 | 1.360 | B | M | 4 | 8 | K1F | | 81513 |
| 1.4 D 4x4 | 39 | 06/91 → 07/92 | 1.360 | D | M | 4 | 8 | K9A (TUD3) | | 81556 |

KW

cm³

NO. OF VALVES

CITROËN
AX

| | | | | | | | | | | |
|---------|----|---------------|-------|---|---|---|---|--|---------------|-------|
| 1.4 GTi | 66 | 08/91 → 12/96 | 1.360 | B | M | 4 | 8 | KFY (TU3FJ2) | 08-1992 → | 81513 |
| | 69 | 06/91 → 12/96 | 1.360 | B | M | 4 | 8 | KFZ (TU3FJ2) | 08-1992 → | 81513 |
| | 74 | 06/91 → 12/92 | 1.360 | B | M | 4 | 8 | KFZ (TU3FJ2) | → PROD: 5.278 | 81556 |
| | 74 | 06/91 → 12/92 | 1.360 | B | M | 4 | 8 | KFZ (TU3FJ2) | PROD →: 5.279 | 81513 |
| 10 | 32 | 09/86 → 06/92 | 954 | B | M | 4 | 8 | C1A | | 81556 |
| | 33 | 07/86 → 12/98 | 954 | B | M | 4 | 8 | CDY (TU9M) | | 81556 |
| | 37 | 02/87 → 12/98 | 954 | B | M | 4 | 8 | CDZ (TU9M) | | 81556 |
| 11 | 40 | 12/86 → 04/94 | 1.124 | B | M | 4 | 8 | H1A, H1B | 12-1986 → | 81556 |
| | 44 | 09/86 → 12/97 | 1.124 | B | M | 4 | 8 | H1B, HDZ (TU1M) | | 81556 |
| 11 4x4 | 40 | 06/91 → 07/92 | 1.124 | B | M | 4 | 8 | H1A | | 81556 |
| 14 | 55 | 04/87 → 04/97 | 1.360 | B | M | 4 | 8 | KDX (TU3M/Z), KDY (TU3FM), KDY (TU3M), KDZ (TU3M/Z) | → 12-1993 | 81556 |
| | 55 | 04/87 → 04/97 | 1.360 | B | M | 4 | 8 | KDX (TU3M/Z), KDY (TU3FM), KDY (TU3M), KDZ (TU3M/Z) | 08-1992 → | 81513 |
| | 62 | 01/88 → 12/92 | 1.360 | B | M | 4 | 8 | K2A, K2B | | 81556 |
| 14 4x4 | 55 | 08/91 → 12/96 | 1.360 | B | M | 4 | 8 | KDX (TU3M/Z), KDY (TU3FM), KDY (TU3M), KDZ (TU3M/Z) | 08-1992 → | 81513 |
| 14 D | 37 | 08/91 → 12/97 | 1.360 | D | M | 4 | 8 | K9Y (TUD3Y) | 01-1993 → | 81556 |
| | 38 | 09/88 → 06/92 | 1.360 | D | M | 4 | 8 | K9A (TUD3) | | 81556 |
| 15 D | 40 | 08/94 → 12/97 | 1.527 | D | M | 4 | 8 | VJY (TUD5) | 05-1994 → | 81513 |
| | 43 | 08/94 → 12/97 | 1.527 | D | M | 4 | 8 | VJY (TUD5), VJZ (TUD5) | | 81513 |

Berlingo I, Van

| | | | | | | | | | | |
|----------------|----|---------------|-------|----|---|---|---|-----------------------------|----------------|-------|
| 1.1 i | 44 | 07/96 → | 1.124 | B | M | 4 | 8 | HDZ (TU1M), HFX (TU1JP) | → M: 3.762.433 | 81556 |
| | 44 | 07/96 → | 1.124 | B | M | 4 | 8 | HDZ (TU1M), HFX (TU1JP) | M →: 3.762.434 | 81797 |
| 1.4 | 48 | 11/02 → | 1.360 | G | M | 4 | 8 | KFW (TU3JP) | | 81797 |
| | 53 | 11/02 → 10/05 | 1.360 | B | M | 4 | 8 | KFW (TU3JP) | | 81797 |
| 1.4 bivalent | 48 | 11/02 → | 1.360 | | M | 4 | 8 | KFW (TU3JP) | | 81797 |
| 1.4 GNC | 48 | 11/02 → | 1.360 | G | M | 4 | 8 | KFW (TU3JP) | | 81797 |
| 1.4 Hybrid | 54 | 05/05 → | 1.360 | | M | 4 | 8 | KFW (TU3JP) | | 81797 |
| 1.4 i | 55 | 07/96 → | 1.360 | B | M | 4 | 8 | KFW (TU3JP), KFX (TU3JP) | → M: 3.666.765 | 81556 |
| | 55 | 07/96 → | 1.360 | B | M | 4 | 8 | KFW (TU3JP), KFX (TU3JP) | M →: 3.666.766 | 81797 |
| 1.4 i bivalent | 55 | 04/03 → | 1.360 | BF | M | 4 | 8 | KFW (TU3JP) | | 81797 |

KW

cm³

NO. OF VALVES

MAGNETI MARELLI
CITROËN
Berlingo I, Van

| | | | | | | | | | | |
|----------------|----|---------------|-------|---|---|---|----|----------------------------|-----------|-------|
| 1.6 16V | 80 | 10/00 → | 1.587 | B | M | 4 | 16 | NFU (TU5JP4) | | 81753 |
| | 81 | 11/02 → | 1.587 | B | M | 4 | 16 | NFU (TU5JP4) | | 81753 |
| 1.6 HDI 110 | 80 | 08/05 → | 1.560 | D | M | 4 | 16 | 9HZ (DV6TED4) | | 81869 |
| 1.6 HDI 75 | 55 | 07/05 → | 1.560 | D | M | 4 | 16 | 9HW (DV6BTED4), DV6B | | 81869 |
| 1.6 HDI 90 | 66 | 07/05 → | 1.560 | D | M | 4 | 16 | 9HX (DV6ATED4) | | 81869 |
| 1.8 D | 43 | 07/96 → | 1.769 | D | M | 4 | 8 | A9A (XUD7) | 07-1996 → | 81642 |
| | 43 | 07/98 → | 1.769 | D | M | 4 | 8 | A9A (XUD7) | | 81642 |
| 1.8 i | 66 | 08/99 → 10/02 | 1.761 | B | M | 4 | 8 | LFX (XU7JB) | | 81512 |
| | 66 | 05/97 → | 1.761 | B | M | 4 | 8 | LFX (XU7JB) | 01-1998 → | 81512 |
| 1.8 i 4WD | 66 | 04/97 → | 1.761 | B | M | 4 | 8 | LFX (XU7JB) | 01-1998 → | 81512 |
| 1.9 D | 51 | 07/98 → 10/05 | 1.868 | D | M | 4 | 8 | WJY (DW8B), WJZ (DW8) | | 81713 |
| | 50 | 07/96 → | 1.905 | D | M | 4 | 8 | D9B (XUD9A/L), DJY (XUD9A) | 07-1996 → | 81642 |
| | 51 | 07/96 → 10/99 | 1.905 | D | M | 4 | 8 | DJY (XUD9A) | | 81642 |
| | 51 | 07/96 → | 1.905 | D | M | 4 | 8 | DJY (XUD9A) | 07-1996 → | 81642 |
| 1.9 D 4WD | 51 | 07/98 → | 1.868 | D | M | 4 | 8 | WJY (DW8B), WJZ (DW8) | | 81713 |
| 1.9 D 70 | 51 | 04/99 → | 1.868 | D | M | 4 | 8 | WJY (DW8B), WJZ (DW8) | | 81713 |
| 1.9 D 70 4WD | 51 | 07/98 → | 1.868 | D | M | 4 | 8 | WJY (DW8B), WJZ (DW8) | | 81713 |
| 2.0 HDi 4x4 | 66 | 11/02 → 10/05 | 1.997 | D | M | 4 | 8 | RHY (DW10TD) | | 81713 |
| 2.0 HDi 90 | 66 | 12/99 → | 1.997 | D | M | 4 | 8 | RHY (DW10TD) | | 81713 |
| 2.0 HDi 90 4WD | 66 | 11/00 → | 1.997 | D | M | 4 | 8 | RHY (DW10TD) | | 81713 |

Berlingo II, Van

| | | | | | | | | | | |
|-----------------|----|---------|-------|---|---|---|----|---------------------------------|--|-------|
| 1.6 | 66 | 04/08 → | 1.587 | B | M | 4 | 16 | NFR (TU5JP4B) | | 81753 |
| | 80 | 04/08 → | 1.587 | B | M | 4 | 16 | NFU (TU5JP4) | | 81753 |
| 1.6 BlueHdi 100 | 73 | 12/14 → | 1.560 | D | M | 4 | 8 | BHY (DV6FD) | | 81869 |
| 1.6 BlueHdi 120 | 88 | 12/14 → | 1.560 | D | M | 4 | 8 | BHZ (DV6FC) | | 81869 |
| 1.6 BlueHdi 75 | 55 | 04/15 → | 1.560 | D | M | 4 | 8 | 9HN (DV6ETED), BHW (DV6FE) | | 81869 |
| 1.6 HDi 110 | 80 | 04/08 → | 1.560 | D | M | 4 | 16 | 9HZ (DV6TED4) | | 81869 |
| | 82 | 07/10 → | 1.560 | D | M | 4 | 8 | 9HL (DV6C), 9HR (DV6C) | | 81869 |
| 1.6 HDi 115 | 84 | 07/10 → | 1.560 | D | M | 4 | 8 | 9HL (DV6C) | | 81869 |
| | 84 | 07/10 → | 1.560 | D | M | 4 | 8 | 9HR (DV6C) | | 81869 |
| 1.6 HDi 75 | 55 | 04/08 → | 1.560 | D | M | 4 | 16 | 9HT (DV6BTED4) | | 81869 |
| | 55 | 04/08 → | 1.560 | D | M | 4 | 16 | 9HT (DV6BUTED4) | | 81869 |
| 1.6 HDi 90 | 66 | 07/10 → | 1.560 | D | M | 4 | 8 | 9HF (DV6DTED) | | 81869 |
| | 66 | 04/08 → | 1.560 | D | M | 4 | 16 | 9HX (DV6ATED4) | | 81869 |
| | 68 | 07/10 → | 1.560 | D | M | 4 | 8 | 9HP (DV6DTED) | | 81869 |
| | 68 | 07/10 → | 1.560 | D | M | 4 | 16 | 9HP (DV6DTED), 9HX (DV6ATED4) | | 81869 |
| 1.6 HDi 90 16V | 66 | 04/08 → | 1.560 | D | M | 4 | 16 | 9HS (DV6TED4BU), 9HX (DV6ATED4) | | 81869 |
| 1.6 VTi 120 | 88 | 11/09 → | 1.598 | B | M | 4 | 16 | 5FS (EP6C) | | 82032 |
| | 88 | 11/09 → | 1.598 | B | M | 4 | 16 | 5FS (EP6C) | | 81753 |

KW

cm³

NO. OF VALVES

MAGNETI MARELLI
CITROËN
Berlingo II, Van

| | | | | | | | | | | |
|------------|----|---------|-------|---|---|---|----|-------------|--|-------|
| 1.6 VTi 95 | 72 | 07/10 → | 1.598 | B | M | 4 | 16 | 5FK (EP6CB) | | 82032 |
|------------|----|---------|-------|---|---|---|----|-------------|--|-------|

BX, Break

| | | | | | | | | | | |
|-----|----|---------------|-------|---|---|---|---|----------|--|-------|
| 1.6 | 85 | 01/87 → 01/92 | 1.580 | B | M | 4 | 8 | B6D, B6E | | 81554 |
|-----|----|---------------|-------|---|---|---|---|----------|--|-------|

| | | | | | | | | | | |
|-------|----|---------------|-------|---|---|---|---|------------|----------------------------|-------|
| 1.8 D | 44 | 10/85 → 09/93 | 1.769 | D | M | 4 | 8 | 161 (XUD7) | → 12-1986, → PROD: 3583 | 81554 |
|-------|----|---------------|-------|---|---|---|---|------------|----------------------------|-------|

| | | | | | | | | | | |
|--|----|---------------|-------|---|---|---|---|------------|----------------------------|-------|
| | 44 | 10/85 → 09/93 | 1.769 | D | M | 4 | 8 | 161 (XUD7) | 01-1987 →, PROD →: 3584 | 81672 |
|--|----|---------------|-------|---|---|---|---|------------|----------------------------|-------|

| | | | | | | | | | | |
|------------|----|---------------|-------|---|---|---|---|--|--|-------|
| 1.9 DT TXD | 66 | 02/92 → 12/94 | 1.905 | D | M | 4 | 8 | | | 81672 |
|------------|----|---------------|-------|---|---|---|---|--|--|-------|

| | | | | | | | | | | |
|---------|-----|---------------|-------|---|---|---|---|--|--------------|-------|
| 1.9 GTi | 117 | 01/90 → 01/92 | 1.905 | B | M | 4 | 8 | | → PROD: 5409 | 81554 |
|---------|-----|---------------|-------|---|---|---|---|--|--------------|-------|

| | | | | | | | | | | |
|-------------|----|---------------|-------|---|---|---|---|--|--------------|-------|
| 1.9 GTi 4x4 | 92 | 02/92 → 06/94 | 1.905 | B | M | 4 | 8 | | PROD →: 5410 | 81512 |
|-------------|----|---------------|-------|---|---|---|---|--|--------------|-------|

| | | | | | | | | | | |
|------------|----|---------------|-------|---|---|---|---|--|--------------|-------|
| 1.9 RD 4x4 | 52 | 01/87 → 01/92 | 1.905 | D | M | 4 | 8 | | PROD →: 3584 | 81672 |
|------------|----|---------------|-------|---|---|---|---|--|--------------|-------|

| | | | | | | | | | | |
|---------|----|---------------|-------|---|---|---|---|-------------|--------------|-------|
| 1.9 Tzi | 92 | 02/92 → 12/94 | 1.905 | B | M | 4 | 8 | D6A (XU9J2) | PROD →: 5410 | 81512 |
|---------|----|---------------|-------|---|---|---|---|-------------|--------------|-------|

| | | | | | | | | | | |
|----|----|---------------|-------|---|---|---|---|------------|----------------------------|-------|
| 11 | 40 | 10/88 → 06/92 | 1.124 | B | M | 4 | 8 | HDZ (TU1M) | → 09-1989, → PROD: 4192 | 81572 |
|----|----|---------------|-------|---|---|---|---|------------|----------------------------|-------|

| | | | | | | | | | | |
|--|----|---------------|-------|---|---|---|---|------------|----------------------------|-------|
| | 40 | 10/88 → 06/92 | 1.124 | B | M | 4 | 8 | HDZ (TU1M) | 10-1989 →, PROD →: 4193 | 81556 |
|--|----|---------------|-------|---|---|---|---|------------|----------------------------|-------|

| | | | | | | | | | | |
|--|----|---------------|-------|---|---|---|---|-----|----------------------------|-------|
| | 42 | 10/86 → 06/92 | 1.124 | B | M | 4 | 8 | H1A | → 09-1989, → PROD: 4192 | 81572 |
|--|----|---------------|-------|---|---|---|---|-----|----------------------------|-------|

| | | | | | | | | | | |
|--|----|---------------|-------|---|---|---|---|-----|----------------------------|-------|
| | 42 | 10/86 → 06/92 | 1.124 | B | M | 4 | 8 | H1A | 10-1989 →, PROD →: 4193 | 81556 |
|--|----|---------------|-------|---|---|---|---|-----|----------------------------|-------|

| | | | | | | | | | | |
|----|----|---------------|-------|---|---|---|---|------|----------------------------|-------|
| 14 | 53 | 01/86 → 02/93 | 1.360 | B | M | 4 | 8 | 150C | → 09-1989, → PROD: 4192 | 81572 |
|----|----|---------------|-------|---|---|---|---|------|----------------------------|-------|

| | | | | | | | | | | |
|--|----|---------------|-------|---|---|---|---|------|----------------------------|-------|
| | 53 | 01/86 → 02/93 | 1.360 | B | M | 4 | 8 | 150C | 02-1992 →, PROD →: 5440 | 81513 |
|--|----|---------------|-------|---|---|---|---|------|----------------------------|-------|

| | | | | | | | | | | |
|--|----|---------------|-------|---|---|---|---|------|---|-------|
| | 53 | 01/86 → 02/93 | 1.360 | B | M | 4 | 8 | 150C | 10-1989 →, → 01-1992, PROD →: 4193, → PROD: 5440 | 81556 |
|--|----|---------------|-------|---|---|---|---|------|---|-------|

| | | | | | | | | | | |
|--|----|---------------|-------|---|---|---|---|------------|----------------------------|-------|
| | 55 | 01/89 → 02/93 | 1.360 | B | M | 4 | 8 | KDY (TU3M) | → 09-1989, → PROD: 4192 | 81572 |
|--|----|---------------|-------|---|---|---|---|------------|----------------------------|-------|

| | | | | | | | | | | |
|--|----|---------------|-------|---|---|---|---|------------|----------------------------|-------|
| | 55 | 01/89 → 02/93 | 1.360 | B | M | 4 | 8 | KDY (TU3M) | 02-1992 →, PROD →: 5440 | 81513 |
|--|----|---------------|-------|---|---|---|---|------------|----------------------------|-------|

| | | | | | | | | | | |
|--|----|---------------|-------|---|---|---|---|------------|---|-------|
| | 55 | 01/89 → 02/93 | 1.360 | B | M | 4 | 8 | KDY (TU3M) | 10-1989 →, → 01-1992, PROD →: 4193, → PROD: 5440 | 81556 |
|--|----|---------------|-------|---|---|---|---|------------|---|-------|

| | | | | | | | | | | |
|--|----|---------------|-------|---|---|---|---|-----------------------------|----------------------------|-------|
| | 55 | 01/89 → 02/93 | 1.360 | B | M | 4 | 8 | KDY (TU3M), KDZ (TU3M/Z) | → 09-1989, → PROD: 4192 | 81572 |
|--|----|---------------|-------|---|---|---|---|-----------------------------|----------------------------|-------|

| | | | | | | | | | | |
|--|----|---------------|-------|---|---|---|---|-----------------------------|----------------------------|-------|
| | 55 | 01/89 → 02/93 | 1.360 | B | M | 4 | 8 | KDY (TU3M), KDZ (TU3M/Z) | 02-1992 →, PROD →: 5440 | 81513 |
|--|----|---------------|-------|---|---|---|---|-----------------------------|----------------------------|-------|

| | | | | | | | | | | |
|--|----|---------------|-------|---|---|---|---|-----------------------------|---|-------|
| | 55 | 01/89 → 02/93 | 1.360 | B | M | 4 | 8 | KDY (TU3M), KDZ (TU3M/Z) | 10-1989 →, → 01-1992, PROD →: 4193, → PROD: 5440 | 81556 |
|--|----|---------------|-------|---|---|---|---|-----------------------------|---|-------|

KW

cm³

NO. OF VALVES

CITROËN
BX, Break

| | | | | | | | | | | |
|------|---------------|---------------|-------|---|---|---|------|-----------------------------|---|-------|
| 14 E | 49 | 09/85 → 02/93 | 1.360 | B | M | 4 | 8 | 150F | → 09-1989, → PROD: 4192 | 81572 |
| | 49 | 09/85 → 02/93 | 1.360 | B | M | 4 | 8 | 150F | 02-1992 →, PROD →: 5440 | 81513 |
| | 49 | 09/85 → 02/93 | 1.360 | B | M | 4 | 8 | 150F | 10-1989 →, → 01-1992, PROD →: 4193, → PROD: 5440 | 81556 |
| | 53 | 04/83 → 02/93 | 1.360 | B | M | 4 | 8 | 150C | → 09-1989, → PROD: 4192 | 81572 |
| | 53 | 04/83 → 02/93 | 1.360 | B | M | 4 | 8 | 150C | 02-1992 →, PROD →: 5440 | 81513 |
| | 53 | 04/83 → 02/93 | 1.360 | B | M | 4 | 8 | 150C | 10-1989 →, → 01-1992, PROD →: 4193, → PROD: 5440 | 81556 |
| 15 | 59 | 10/87 → 05/92 | 1.580 | B | M | 4 | 8 | B1E (XU51C) | | 81512 |
| 16 | 53 | 01/87 → 02/93 | 1.580 | B | M | 4 | 8 | B1E (XU51C) | → 01-1992, → PROD: 5409 | 81554 |
| | 53 | 01/87 → 02/93 | 1.580 | B | M | 4 | 8 | B1E (XU51C) | 02-1992 →, PROD →: 5410 | 81512 |
| | 55 | 09/88 → 02/93 | 1.580 | B | M | 4 | 8 | BAY (XU5CP), BAZ (XU5CP) | → 01-1992, → PROD: 5409 | 81554 |
| | 55 | 09/88 → 02/93 | 1.580 | B | M | 4 | 8 | BAY (XU5CP), BAZ (XU5CP) | 02-1992 →, PROD →: 5410 | 81512 |
| | 58 | 09/87 → 02/93 | 1.580 | B | M | 4 | 8 | B1A (XU51C/K) | → 01-1992, → PROD: 5409 | 81554 |
| | 58 | 09/87 → 02/93 | 1.580 | B | M | 4 | 8 | B1A (XU51C/K) | 02-1992 →, PROD →: 5410 | 81512 |
| | 64 | 07/85 → 02/93 | 1.580 | B | M | 4 | 8 | 171D | → 01-1992, → PROD: 5409 | 81554 |
| | 64 | 07/85 → 02/93 | 1.580 | B | M | 4 | 8 | 171D | 02-1992 →, PROD →: 5410 | 81512 |
| | 65 | 05/89 → 12/94 | 1.580 | B | M | 4 | 8 | BDY (XU5M), BDZ (XU5M) | → 01-1992, → PROD: 5409 | 81554 |
| | 65 | 05/89 → 12/94 | 1.580 | B | M | 4 | 8 | BDY (XU5M), BDZ (XU5M) | 02-1992 →, PROD →: 5410 | 81512 |
| | 68 | 10/82 → 12/92 | 1.580 | B | M | 4 | 8 | XU52C | → 01-1992, → PROD: 5409 | 81554 |
| | 68 | 10/82 → 12/92 | 1.580 | B | M | 4 | 8 | XU52C | 02-1992 →, PROD →: 5410 | 81512 |
| 76 | 03/86 → 02/93 | 1.580 | B | M | 4 | 8 | 180Z | → 01-1992, → PROD: 5409 | 81554 | |
| 76 | 03/86 → 02/93 | 1.580 | B | M | 4 | 8 | 180Z | 02-1992 →, PROD →: 5410 | 81512 | |

KW

cm³

NO. OF VALVES

CITROËN
BX, Break

| | | | | | | | | | | |
|----------|----|---------------|-------|---|---|---|---|--|----------------------------|--------------|
| 16 E | 65 | 05/89 → 02/93 | 1.580 | B | M | 4 | 8 | BDY (XU5M), BDZ (XU5M) | → 01-1992, → PROD: 5409 | 81554 |
| | 65 | 05/89 → 02/93 | 1.580 | B | M | 4 | 8 | BDY (XU5M), BDZ (XU5M) | 02-1992 →, PROD →: 5410 | 81512 |
| 18 D | 44 | 10/85 → 09/93 | 1.769 | D | M | 4 | 8 | 161A (XUD7) | → 12-1986, → PROD: 3583 | 81554 |
| | 44 | 10/85 → 09/93 | 1.769 | D | M | 4 | 8 | 161A (XUD7) | 01-1987 →, PROD →: 3584 | 81672 |
| 19 | 75 | 07/86 → 12/94 | 1.905 | B | M | 4 | 8 | D2A (XU92C) | → 01-1992, → PROD: 5409 | 81554 |
| | 75 | 07/86 → 12/94 | 1.905 | B | M | 4 | 8 | D2A (XU92C) | 02-1992 →, PROD →: 5410 | 81512 |
| | 80 | 06/88 → 12/94 | 1.905 | B | M | 4 | 8 | DDZ (XU9M) | → 01-1992, → PROD: 5409 | 81554 |
| | 80 | 06/88 → 12/94 | 1.905 | B | M | 4 | 8 | DDZ (XU9M) | 02-1992 →, PROD →: 5410 | 81512 |
| | 88 | 06/88 → 12/94 | 1.905 | B | M | 4 | 8 | DKZ (XU9JA) | → 01-1992, → PROD: 5409 | 81554 |
| | 88 | 06/88 → 12/94 | 1.905 | B | M | 4 | 8 | DKZ (XU9JA) | 02-1992 →, PROD →: 5410 | 81512 |
| 19 4x4 | 80 | 10/90 → 05/91 | 1.905 | B | M | 4 | 8 | DDZ (XU9M) | → PROD: 5.409 | 81554 |
| 19 Cat. | 75 | 07/86 → 12/94 | 1.905 | B | M | 4 | 8 | DFZ (XU9J1) | → 01-1992, → PROD: 5409 | 81554 |
| | 75 | 07/86 → 12/94 | 1.905 | B | M | 4 | 8 | DFZ (XU9J1) | 02-1992 →, PROD →: 5410 | 81512 |
| 19 D | 47 | 09/83 → 09/93 | 1.905 | D | M | 4 | 8 | 162 (XUD9), D9A (XUD9), DJZ (XUD9Y) | → 12-1986, → PROD: 3583 | 81554 |
| | 47 | 09/83 → 09/93 | 1.905 | D | M | 4 | 8 | 162 (XUD9), D9A (XUD9), DJZ (XUD9Y) | 01-1987 →, PROD →: 3584 | 81672 |
| | 51 | 03/87 → 02/93 | 1.905 | D | M | 4 | 8 | D9B (XUD9A/U) | PROD →: 3584 | 81672 |
| 19 E | 80 | 06/88 → 02/93 | 1.905 | B | M | 4 | 8 | DDZ (XU9M) | → 01-1992, → PROD: 5409 | 81554 |
| | 80 | 06/88 → 02/93 | 1.905 | B | M | 4 | 8 | DDZ (XU9M) | 02-1992 →, PROD →: 5410 | 81512 |
| 19 E 4x4 | 80 | 04/89 → 02/93 | 1.905 | B | M | 4 | 8 | D2F | → 01-1992, → PROD: 5409 | 81554 |
| | 80 | 04/89 → 02/93 | 1.905 | B | M | 4 | 8 | D2F | 02-1992 →, PROD →: 5410 | 81512 |

KW

cm³

NO. OF VALVES

CITROËN
BX, Break

| | | | | | | | | | | |
|---------------|-----|---------------|-------|---|---|---|----|-------------------------------|----------------------------|-------|
| 19 GTi | 88 | 06/88 → 02/93 | 1.905 | B | M | 4 | 8 | DKZ (XU9JA) | → 01-1992, → PROD: 5409 | 81554 |
| | 88 | 06/88 → 02/93 | 1.905 | B | M | 4 | 8 | DKZ (XU9JA) | 02-1992 →, PROD →: 5410 | 81512 |
| | 90 | 07/86 → 02/93 | 1.905 | B | M | 4 | 8 | D6A (XU9J2) | → 01-1992, → PROD: 5409 | 81554 |
| | 90 | 07/86 → 02/93 | 1.905 | B | M | 4 | 8 | D6A (XU9J2) | 02-1992 →, PROD →: 5410 | 81512 |
| 19 GTi 16V | 108 | 03/88 → 02/93 | 1.905 | B | M | 4 | 16 | DFW (XU9J4) | → 01-1992, → PROD: 5409 | 81554 |
| | 108 | 03/88 → 02/93 | 1.905 | B | M | 4 | 16 | DFW (XU9J4) | 02-1992 →, PROD →: 5410 | 81512 |
| 19 GTi 4x4 | 88 | 06/88 → 02/93 | 1.905 | B | M | 4 | 8 | DKZ (XU9JA) | → 01-1992, → PROD: 5409 | 81554 |
| | 88 | 06/88 → 02/93 | 1.905 | B | M | 4 | 8 | DKZ (XU9JA) | 02-1992 →, PROD →: 5410 | 81512 |
| TRD Turbo | 66 | 03/88 → 02/93 | 1.769 | D | M | 4 | 8 | A8A (XUD7TE), AJZ (XUD7TE) | | 81672 |
| | 66 | 03/88 → 12/94 | 1.769 | D | M | 4 | 8 | A8A (XUD7TE), AJZ (XUD7TE) | PROD →: 3584 | 81672 |
| C 1 I | | | | | | | | | | |
| 1.0 | 50 | 06/05 → | 998 | B | M | 3 | 12 | 1KR-FE | | 82063 |
| 1.4 HDi | 40 | 06/05 → | 1.398 | D | M | 4 | 8 | 8HT (DV4TD) | | 81798 |
| C 1 II | | | | | | | | | | |
| 1.0 VTi 68 | 51 | 04/14 → | 998 | B | M | 3 | 12 | 1KR-FE | | 84054 |
| 1.2 VTi 82 | 60 | 04/14 → | 1.199 | B | M | 3 | 12 | HMT (EB2D) | | 84066 |
| C 15 | | | | | | | | | | |
| 1.0 | 33 | 10/84 → 12/97 | 954 | B | M | 4 | 8 | TU9, XV8 | → 12-1988, → PROD: 4192 | 81572 |
| | 33 | 10/84 → 12/97 | 954 | B | M | 4 | 8 | TU9, XV8 | 01-1989 →, PROD →: 4193 | 81556 |
| 1.0 E | 37 | 11/92 → 07/96 | 954 | B | M | 4 | 8 | TU9K | → PROD: 4192 | 81572 |
| | 37 | 11/92 → 07/96 | 954 | B | M | 4 | 8 | TU9K | PROD →: 4193 | 81556 |
| 1.1 | 35 | 10/84 → 12/96 | 1.124 | B | M | 4 | 8 | 109K, E1A | → 12-1988, → PROD: 4237 | 81560 |
| | 35 | 10/84 → 12/96 | 1.124 | B | M | 4 | 8 | 109K, E1A | → PROD: 4192 | 81572 |
| | 35 | 10/84 → 12/96 | 1.124 | B | M | 4 | 8 | 109K, E1A | 01-1989 →, PROD →: 4193 | 81556 |
| | 40 | 11/88 → 07/96 | 1.124 | B | M | 4 | 8 | H1A | | 81556 |
| 1.1 i | 44 | 07/88 → 12/96 | 1.124 | B | M | 4 | 8 | HDZ (TU1M) | | 81556 |
| 1.4 | 49 | 07/87 → 12/96 | 1.360 | B | M | 4 | 8 | K1H (TU3A) | → PROD: 4192 | 81572 |
| | 49 | 07/87 → 12/96 | 1.360 | B | M | 4 | 8 | K1H (TU3A) | PROD →: 4193 | 81556 |

KW

cm³

NO. OF VALVES

CITROËN
C 15

| | | | | | | | | | | |
|-------|----|---------------|-------|---|---|---|---|----------------------------|-------------------------------|-------|
| 1.4 E | 40 | 07/87 → 12/96 | 1.360 | B | M | 4 | 8 | K3A | → PROD: 4192 | 81572 |
| | 40 | 07/87 → 12/96 | 1.360 | B | M | 4 | 8 | K3A | PROD →: 4193 | 81556 |
| | 44 | 05/87 → 12/96 | 1.360 | B | M | 4 | 8 | 150D (XY7) | → PROD: 4192 | 81572 |
| | 44 | 05/87 → 12/96 | 1.360 | B | M | 4 | 8 | 150D (XY7) | PROD →: 4193 | 81556 |
| 1.4 i | 55 | 05/91 → 12/96 | 1.360 | B | M | 4 | 8 | KDY (TU3FM), KDY (TU3M) | → PROD: 4192 | 81572 |
| | 55 | 05/91 → 12/96 | 1.360 | B | M | 4 | 8 | KDY (TU3FM), KDY (TU3M) | PROD →: 4193 | 81556 |
| 1.8 D | 44 | 07/86 → 12/00 | 1.769 | D | M | 4 | 8 | 161A (XUD7) | → PROD: 3583 | 81554 |
| | 44 | 07/86 → 12/00 | 1.769 | D | M | 4 | 8 | 161A (XUD7) | PROD →: 3584, → PROD: 6264 | 81672 |
| | 44 | 07/86 → 12/00 | 1.769 | D | M | 4 | 8 | 161A (XUD7) | PROD →: 6265 | 81642 |
| 1.9 D | 44 | 12/00 → 12/05 | 1.868 | D | M | 4 | 8 | WJX (DW8B) | | 81713 |

C 2, Van

| | | | | | | | | | | |
|---------|----|---------|-------|---|---|---|----|-----------------------------|--|-------|
| 1.1 | 44 | 09/03 → | 1.124 | B | M | 4 | 8 | HFX (TU1JP) | | 81797 |
| 1.4 | 54 | 09/03 → | 1.360 | B | M | 4 | 8 | KFV (TU3JP) | | 81797 |
| | 55 | 10/06 → | 1.360 | B | M | 4 | 8 | KFV (TU3JP) | | 81797 |
| 1.4 16V | 65 | 06/06 → | 1.360 | B | M | 4 | 16 | KFU (ET3J4) | | 82016 |
| 1.4 HDi | 50 | 04/09 → | 1.398 | D | M | 4 | 8 | 8HX (DV4TD) | | 81798 |
| | 50 | 09/03 → | 1.398 | D | M | 4 | 8 | 8HX (DV4TD), 8HZ (DV4TD) | | 81798 |
| 1.6 | 80 | 09/03 → | 1.587 | B | M | 4 | 16 | NFU (TU5JP4) | | 81753 |
| 1.6 HDi | 80 | 09/05 → | 1.560 | D | M | 4 | 16 | 9HZ (DV6TED4) | | 81869 |
| 1.6 VTS | 90 | 01/05 → | 1.587 | B | M | 4 | 16 | NFS (TU5JP4S) | | 81753 |

C 25

| | | | | | | | | | | |
|-----------------|----|---------------|-------|---|---|---|---|-----------------------------|-------|-------|
| 1.8 | 50 | 11/81 → 01/94 | 1.796 | B | M | 4 | 8 | 169 (XM7T) | | 81367 |
| 1.8 E | 51 | 07/87 → 02/94 | 1.796 | B | M | 4 | 8 | 169 (XM7T) | | 81367 |
| 1.9 D | 51 | 07/87 → 02/94 | 1.905 | D | M | 4 | 8 | D9B (XUD9A/U) | (-)AC | 81822 |
| 1.9 D 1400 | 51 | 01/88 → 01/94 | 1.905 | D | M | 4 | 8 | DJY (XUD9A) | (-)AC | 81822 |
| 1.9 TD | 60 | 04/92 → 02/94 | 1.930 | D | M | 4 | 8 | M705 | (-)AC | 81822 |
| 2.0 | 62 | 02/91 → 02/94 | 1.971 | B | M | 4 | 8 | 170C (XN1T) | | 81367 |
| 2.0 4x4 | 62 | 01/90 → 01/94 | 1.971 | B | M | 4 | 8 | | | 81367 |
| 2.0 E | 58 | 09/81 → 02/94 | 1.971 | B | M | 4 | 8 | 170A (XN1T), 170B (XN1T) | | 81367 |
| 2.5 D | 54 | 10/85 → 02/94 | 2.500 | D | M | 4 | 8 | CRD93L (U25-661) | (-)AC | 81822 |
| 2.5 D 4x4 | 54 | 01/87 → 02/94 | 2.500 | D | M | 4 | 8 | CRD93L (U25-661) | (-)AC | 81822 |
| 2.5 D Turbo | 70 | 08/87 → 02/94 | 2.500 | D | M | 4 | 8 | CRD93LS (U25-673) | (-)AC | 81822 |
| 2.5 D Turbo 4x4 | 70 | 08/87 → 02/94 | 2.500 | D | M | 4 | 8 | CRD93LS (U25-673) | (-)AC | 81822 |
| 2.5 DT | 70 | 01/87 → 01/94 | 2.498 | D | M | 4 | 8 | CRD93LS (U25-673) | (-)AC | 81822 |

C 3 I, Pluriel

| | | | | | | | | | | |
|---------|----|---------|-------|---|---|---|----|----------------------------|--|-------|
| 1.1 i | 44 | 02/02 → | 1.124 | B | M | 4 | 8 | HFX (TU1A), HFX (TU1JP) | | 81797 |
| 1.4 | 54 | 05/03 → | 1.360 | B | M | 4 | 8 | KFV (TU3JP) | | 81797 |
| 1.4 16V | 65 | 12/03 → | 1.360 | B | M | 4 | 16 | KFU (ET3J4) | | 82016 |

KW

cm³

NO. OF VALVES

CITROËN
C 3 I, Pluriel

| | | | | | | | | | |
|----------------|----|---------------|-------|---|----|---|----|----------------------------|-------|
| 1.4 16V HDi | 66 | 02/02 → | 1.398 | D | M | 4 | 16 | 8HY (DV4TED4) | 81798 |
| 1.4 HDi | 50 | 02/02 → | 1.398 | D | M | 4 | 8 | 8HX (DV4TD) | 81798 |
| 1.4 HDi | 55 | 05/05 → | 1.398 | D | M | 4 | 8 | 8HX (DV4TD) | 81798 |
| 1.4 Hybrid | 54 | 05/05 → | 1.360 | | M | 4 | 8 | KFV (TU3JP) | 81797 |
| 1.4 i | 54 | 02/02 → | 1.360 | B | AM | 4 | 8 | KFV (TU3A), KFV (TU3JP) | 81797 |
| 1.4 i Bivalent | 54 | 02/02 → | 1.360 | | AM | 4 | 8 | KFV (TU3JP) | 81797 |
| 1.6 | 80 | 05/03 → | 1.587 | B | M | 4 | 16 | NFU (TU5JP4) | 81753 |
| 1.6 16V | 80 | 02/02 → | 1.587 | B | M | 4 | 16 | NFU (TU5JP4) | 81753 |
| | 81 | 05/03 → 09/05 | 1.587 | B | M | 4 | 16 | NFU (TU5JP4) | 81753 |
| 1.6 16V HDi | 66 | 10/05 → | 1.560 | D | M | 4 | 16 | 9HX (DV6ATED4) | 81869 |
| | 80 | 09/05 → | 1.560 | D | M | 4 | 16 | 9HZ (DV6TED4) | 81869 |

C 3 II, Picasso

| | | | | | | | | | | |
|-----------------|----|---------|-------|----|---|---|----|------------------------------------|-------|------------|
| 1.0 VTi 68 | 50 | 08/12 → | 999 | B | M | 3 | 12 | ZMZ (EB0) | 84066 | NEW |
| 1.1 | 44 | 11/09 → | 1.124 | B | M | 4 | 8 | HFX (TU1JP) | 81797 | |
| 1.1 BiFuel | 44 | 11/10 → | 1.124 | BF | M | 4 | 8 | HFX (TU1A) | 81797 | |
| 1.2 THP 110 | 81 | 10/14 → | 1.199 | B | M | 3 | 12 | HNZ (EB2DT) | 84066 | NEW |
| 1.2 VTi 82 | 60 | 06/12 → | 1.199 | B | M | 3 | 12 | HMZ (EB2F) | 84066 | NEW |
| 1.4 | 54 | 11/09 → | 1.360 | B | M | 4 | 8 | KFT (TU3A), KFV (TU3A) | 81797 | |
| 1.4 HDi 70 | 50 | 11/09 → | 1.398 | D | M | 4 | 8 | 8HR (DV4C), 8HZ (DV4TD) | 81798 | |
| 1.4 LPG | 70 | 06/13 → | 1.397 | | M | 4 | 16 | 8FN (EP3) | 82032 | |
| 1.4 VTi | 72 | 11/09 → | 1.397 | B | M | 4 | 16 | 8FR (EP3) | 82032 | |
| 1.4 VTi 95 | 70 | 02/09 → | 1.397 | B | M | 4 | 16 | 8FN (EP3), 8FP (EP3), 8FS (EP3) | 82032 | |
| | 70 | 11/09 → | 1.397 | B | M | 4 | 16 | 8FP (EP3) | 82032 | |
| 1.4 VTi 95 LPG | 70 | 01/12 → | 1.397 | | M | 4 | 16 | 8FN (EP3) | 82032 | |
| 1.6 BlueHDi 100 | 73 | 07/14 → | 1.560 | D | M | 4 | 8 | BHY (DV6FD) | 81869 | |
| 1.6 BlueHDi 75 | 55 | 04/15 → | 1.560 | D | M | 4 | 8 | BHW (DV6FE) | 81869 | |
| 1.6 HDi | 66 | 02/09 → | 1.560 | D | M | 4 | 16 | 9HX (DV6ATED4) | 81869 | |
| | 68 | 11/09 → | 1.560 | D | M | 4 | 8 | 9HP (DV6DTED) | 81869 | |
| | 80 | 02/09 → | 1.560 | D | M | 4 | 16 | 9HZ (DV6TED4) | 81869 | |
| 1.6 HDi 110 | 82 | 11/09 → | 1.560 | D | M | 4 | 8 | 9HR (DV6C) | 81869 | |
| 1.6 HDi 115 | 84 | 09/12 → | 1.560 | D | M | 4 | 8 | 9HD (DV6C) | 81869 | |
| 1.6 HDi 90 | 66 | 11/09 → | 1.560 | D | M | 4 | 16 | 9HX (DV6ATED4) | 81869 | |
| | 68 | 07/10 → | 1.560 | D | M | 4 | 8 | 9HP (DV6DTED) | 81869 | |
| 1.6 VTi 120 | 88 | 11/09 → | 1.598 | B | M | 4 | 16 | 5FS (EP6C) | 82032 | |
| | 88 | 02/09 → | 1.598 | B | M | 4 | 16 | 5FS (EP6C), 5FW (EP6) | 82032 | |

C 4 Cactus

| | | | | | | | | | | |
|-----------------|----|---------|-------|---|---|---|----|---------------|-------|------------|
| 1.2 THP 110 | 81 | 09/14 → | 1.199 | B | M | 3 | 12 | HNZ (EB2DT) | 84066 | NEW |
| 1.2 VTi 75 | 55 | 09/14 → | 1.199 | B | M | 3 | 12 | HMU (EB2D) | 84066 | NEW |
| 1.2 VTi 82 | 60 | 09/14 → | 1.199 | B | M | 3 | 12 | HMZ (EB2F) | 84066 | NEW |
| 1.6 BlueHDi 100 | 73 | 09/14 → | 1.560 | D | M | 4 | 8 | BHY (DV6FD) | 81869 | |
| 1.6 HDi 90 | 68 | 09/14 → | 1.560 | D | M | 4 | 8 | 9HP (DV6DTED) | 81869 | |

KW

cm³

NO. OF VALVES

MAGNETI MARELLI
CITROËN
C 4 Aircross

| | | | | | | | | | | |
|-----------------|-----|---------|-------|---|---|---|----|------------|--|------------------|
| 1.6 | 86 | 04/12 → | 1.590 | B | M | 4 | 16 | 4A92 | | 82049 |
| 1.6 HDi 115 | 84 | 04/12 → | 1.560 | D | M | 4 | 8 | 9HL (DV6C) | | 81869 |
| 1.6 HDi 115 AWC | 84 | 05/12 → | 1.560 | D | M | 4 | 8 | 9HL (DV6C) | | 81869 |
| 1.8 HDi 150 | 110 | 04/12 → | 1.798 | D | M | 4 | 16 | 4N13 | | 84042 NEW |
| 1.8 HDi 150 AWC | 110 | 04/12 → | 1.798 | D | M | 4 | 16 | 4N13 | | 84042 NEW |

C 4 I, Coupé, Picasso, Grand Picasso

| | | | | | | | | | | |
|------------------|-----|---------------|-------|----|---|---|----|---------------------------------|--------|------------------|
| 1.4 16V | 65 | 11/04 → 07/11 | 1.360 | B | M | 4 | 16 | KFU (ET3J4) | | 82016 |
| 1.6 16V | 80 | 11/04 → 07/11 | 1.587 | B | M | 4 | 16 | NFU (TU5JP4) | | 81753 |
| | 103 | 07/08 → | 1.598 | B | M | 4 | 16 | 5FT (EP6DT) | | 82032 |
| | 110 | 10/08 → | 1.598 | B | M | 4 | 16 | 5FX (EP6DT) | | 82032 |
| 1.6 16V Bio-Flex | 80 | 09/07 → 07/08 | 1.587 | | M | 4 | 16 | NFU (TU5JP4) | | 81753 |
| 1.6 HDi | 66 | 11/04 → 07/11 | 1.560 | D | M | 4 | 16 | 9HX (DV6ATED4) | | 81869 |
| | 80 | 11/04 → 07/11 | 1.560 | D | M | 4 | 16 | 9HY (DV6TED4), 9HZ (DV6TED4) | | 81869 |
| 1.6 HDi 110 | 82 | 09/10 → | 1.560 | D | M | 4 | 8 | 9HL (DV6C), 9HR (DV6C) | | 81869 |
| | 82 | 09/10 → 08/13 | 1.560 | D | M | 4 | 8 | 9HR (DV6C) | | 81869 |
| 1.6 THP 140 | 103 | 07/08 → 07/11 | 1.598 | B | M | 4 | 16 | 5FT (EP6DT) | | 82032 |
| 1.6 THP 150 | 110 | 07/08 → 07/11 | 1.598 | B | M | 4 | 16 | 5FX (EP6DT) | | 82032 |
| 1.6 THP 155 | 115 | 09/10 → | 1.598 | B | M | 4 | 16 | 5FV (EP6CDT) | | 82032 |
| 1.6 VTi 120 | 88 | 07/08 → 07/11 | 1.598 | B | M | 4 | 16 | 5FW (EP6) | | 82032 |
| 1.8 Bifuel | 92 | 01/09 → 10/12 | 1.749 | BF | M | 4 | 16 | 6FY (EW7A) | (-)COP | 84038 NEW |
| | 92 | 01/09 → 10/12 | 1.749 | BF | M | 4 | 16 | 6FY (EW7A) | (+)COP | 82089 |
| | 92 | 01/09 → 10/12 | 1.749 | BF | M | 4 | 16 | 6FY (EW7A) | | 82089 |
| | 92 | 01/09 → 10/12 | 1.749 | BF | M | 4 | 16 | 6FY (EW7A) | | 81799 |
| 1.8 i 16V | 92 | 10/06 → | 1.749 | B | M | 4 | 16 | 6FY (EW7A) | (-)COP | 84038 NEW |
| | 92 | 10/06 → | 1.749 | B | M | 4 | 16 | 6FY (EW7A) | (+)COP | 82089 |
| | 92 | 10/06 → | 1.749 | B | M | 4 | 16 | 6FY (EW7A) | | 82089 |
| | 92 | 10/06 → | 1.749 | B | M | 4 | 16 | 6FY (EW7A) | | 81799 |
| 2.0 16V | 100 | 11/04 → 07/07 | 1.997 | B | M | 4 | 16 | RFN (EW10J4) | (-)COP | 84038 NEW |
| | 100 | 11/04 → 07/07 | 1.997 | B | M | 4 | 16 | RFN (EW10J4) | (+)COP | 82089 |
| | 100 | 11/04 → 07/07 | 1.997 | B | M | 4 | 16 | RFN (EW10J4) | | 82089 |
| | 100 | 11/04 → 07/07 | 1.997 | B | M | 4 | 16 | RFN (EW10J4) | | 81799 |
| | 103 | 11/04 → 07/11 | 1.997 | B | M | 4 | 16 | RFJ (EW10A) | (-)COP | 84038 NEW |
| | 103 | 11/04 → 07/11 | 1.997 | B | M | 4 | 16 | RFJ (EW10A) | (+)COP | 82089 |
| | 103 | 11/04 → 07/11 | 1.997 | B | M | 4 | 16 | RFJ (EW10A) | | 82089 |
| | 103 | 11/04 → 07/11 | 1.997 | B | M | 4 | 16 | RFJ (EW10A) | | 81799 |
| | 130 | 11/04 → 12/10 | 1.997 | B | M | 4 | 16 | RFK (EW10J4S) | (-)COP | 84038 NEW |
| | 130 | 11/04 → 12/10 | 1.997 | B | M | 4 | 16 | RFK (EW10J4S) | (+)COP | 82089 |
| | 130 | 11/04 → 12/10 | 1.997 | B | M | 4 | 16 | RFK (EW10J4S) | | 82089 |
| 2.0 HDi | 81 | 04/07 → 07/08 | 1.997 | D | M | 4 | 8 | RHZ (DW10ATED) | | 81713 |
| | 100 | 11/04 → 12/10 | 1.997 | D | M | 4 | 16 | RHR (DW10BTED4) | | 81800 |
| | 103 | 07/08 → 07/11 | 1.997 | D | M | 4 | 16 | RHF (DW10BTED4) | | 81800 |

KW

cm³

NO. OF VALVES

CITROËN
C 4 I, Coupé, Picasso, Grand Picasso

| | | | | | | | | | | | |
|-------------|-----|---------------|-------|---|---|---|----|-------------------------------------|--------|-------|------------|
| 2.0 HDi 138 | 100 | 10/06 → | 1.997 | D | M | 4 | 16 | RHJ (DW10BTED4), RHR (DW10BTED4) | | 81800 | |
| 2.0 HDi 150 | 110 | 07/09 → | 1.997 | D | M | 4 | 16 | RHE (DW10CTED4) | | 84020 | NEW |
| 2.0 HDi 165 | 120 | 09/10 → | 1.997 | D | M | 4 | 16 | RHH (DW10CTED4) | | 84020 | NEW |
| 2.0 i 16V | 103 | 10/06 → | 1.997 | B | M | 4 | 16 | RFJ (EW10A) | (-)COP | 84038 | NEW |
| | 103 | 10/06 → | 1.997 | B | M | 4 | 16 | RFJ (EW10A) | (+)COP | 82089 | |
| | 103 | 10/06 → | 1.997 | B | M | 4 | 16 | RFJ (EW10A) | | 82089 | |
| | 103 | 10/06 → | 1.997 | B | M | 4 | 16 | RFJ (EW10A) | | 81799 | |
| 2.0 VTR | 103 | 10/06 → 12/07 | 1.997 | B | M | 4 | 16 | RFJ (EW10A) | (-)COP | 84038 | NEW |
| | 103 | 10/06 → 12/07 | 1.997 | B | M | 4 | 16 | RFJ (EW10A) | (+)COP | 82089 | |

C 4 II, Picasso, Grand Picasso

| | | | | | | | | | | | |
|-----------------------|-----|---------|-------|---|---|---|----|----------------------------|--|-------|------------|
| 1.2 THP 110 | 81 | 02/15 → | 1.199 | B | M | 3 | 12 | HNZ (EB2DT) | | 84066 | NEW |
| 1.2 THP 130 | 96 | 04/14 → | 1.199 | B | M | 3 | 12 | HNY (EB2DTS) | | 84066 | NEW |
| 1.4 VTi 95 | 70 | 11/09 → | 1.397 | B | M | 4 | 16 | 8FP (EP3) | | 82032 | |
| 1.6 BlueHDi 100 | 73 | 01/15 → | 1.560 | D | M | 4 | 8 | BHY (DV6FD) | | 81869 | |
| 1.6 BlueHDi 115 | 85 | 08/14 → | 1.560 | D | M | 4 | 8 | BHX (DV6FC) | | 81869 | |
| 1.6 BlueHDi 120 | 88 | 07/14 → | 1.560 | D | M | 4 | 8 | BHZ (DV6FC) | | 81869 | |
| 1.6 HDi / BlueHDi 115 | 85 | 09/13 → | 1.560 | D | M | 4 | 8 | 9HC (DV6C), BHX (DV6FC) | | 81869 | |
| 1.6 HDi 110 | 82 | 11/09 → | 1.560 | D | M | 4 | 8 | 9HR (DV6C) | | 81869 | |
| 1.6 HDi 115 | 84 | 07/12 → | 1.560 | D | M | 4 | 8 | 9HD (DV6C), 9HR (DV6C) | | 81869 | |
| 1.6 HDi 90 | 68 | 09/13 → | 1.560 | D | M | 4 | 8 | 9HP (DV6DTED) | | 81869 | |
| 1.6 THP 155 | 115 | 09/13 → | 1.598 | B | M | 4 | 16 | 5FV (EP6CDT) | | 82032 | |
| 1.6 THP 165 | 121 | 07/14 → | 1.598 | B | M | 4 | 16 | 5GZ (EP6FDT) | | 82032 | |
| 1.6 VTi 120 | 88 | 09/13 → | 1.598 | B | M | 4 | 16 | 5FS (EP6C) | | 82032 | |
| 1.6 VTi 120 LPG | 88 | 09/11 → | 1.598 | | M | 4 | 16 | 5FS (EP6C) | | 82032 | |
| 2.0 BlueHDi 135 | 100 | 09/13 → | 1.997 | D | M | 4 | 16 | AHV (DW10FDD) | | 82068 | |
| 2.0 BlueHDi 150 | 110 | 09/13 → | 1.997 | D | M | 4 | 16 | AHX (DW10FD) | | 82068 | |
| | 110 | 11/09 → | 1.997 | D | M | 4 | 16 | RHE (DW10CTED4) | | 84020 | NEW |

C 5 I, Break

| | | | | | | | | | | | |
|-------------|-----|---------------|-------|---|---|---|----|--------------|--------|-------|------------|
| 1.8 16V | 85 | 03/01 → 08/04 | 1.749 | B | M | 4 | 16 | 6FZ (EW7J4) | (-)COP | 84038 | NEW |
| | 85 | 03/01 → 08/04 | 1.749 | B | M | 4 | 16 | 6FZ (EW7J4) | (+)COP | 82089 | |
| | 85 | 03/01 → 08/04 | 1.749 | B | M | 4 | 16 | 6FZ (EW7J4) | | 82089 | |
| | 85 | 03/01 → 08/04 | 1.749 | B | M | 4 | 16 | 6FZ (EW7J4) | | 81799 | |
| 2.0 16V | 100 | 03/01 → 08/04 | 1.997 | B | M | 4 | 16 | RFN (EW10J4) | (-)COP | 84038 | NEW |
| | 100 | 03/01 → 08/04 | 1.997 | B | M | 4 | 16 | RFN (EW10J4) | (+)COP | 82089 | |
| | 100 | 03/01 → 08/04 | 1.997 | B | M | 4 | 16 | RFN (EW10J4) | | 82089 | |
| | 100 | 03/01 → 08/04 | 1.997 | B | M | 4 | 16 | RFN (EW10J4) | | 81799 | |
| 2.0 16V HPi | 103 | 03/01 → 08/04 | 1.997 | B | M | 4 | 16 | RLZ (EW10D) | (-)COP | 84038 | NEW |
| | 103 | 03/01 → 08/04 | 1.997 | B | M | 4 | 16 | RLZ (EW10D) | (+)COP | 82089 | |
| | 103 | 03/01 → 08/04 | 1.997 | B | M | 4 | 16 | RLZ (EW10D) | | 82089 | |
| | 103 | 03/01 → 08/04 | 1.997 | B | M | 4 | 16 | RLZ (EW10D) | | 81799 | |

KW

cm³

NO. OF VALVES

CITROËN
C 5 I, Break

| | | | | | | | | | | |
|--------------|-----|---------------|-------|---|----|---|----|-----------------------------------|--|-------|
| 2.0 HDi | 79 | 03/01 → 08/04 | 1.997 | D | M | 4 | 8 | RHS (DW10ATED), RHZ (DW10ATED) | | 81713 |
| | 80 | 06/01 → 08/04 | 1.997 | D | M | 4 | 8 | RHZ (DW10ATED) | | 81713 |
| | 66 | 03/01 → 08/04 | 1.997 | D | M | 4 | 8 | RHY (DW10TD) | | 81713 |
| | 79 | 06/01 → 08/04 | 1.997 | D | M | 4 | 8 | RHS (DW10ATED), RHZ (DW10ATED) | | 81713 |
| | 80 | 03/01 → 08/04 | 1.997 | D | M | 4 | 8 | RHZ (DW10ATED) | | 81713 |
| 2.2 HDi | 98 | 03/01 → 08/04 | 2.179 | D | M | 4 | 16 | 4HX (DW12TED4/FAP) | | 81800 |
| 3.0 Carlsson | 173 | 09/03 → 08/04 | 2.946 | B | M | 6 | 24 | XFJ (ES9J4S) | | 81813 |
| 3.0 V6 | 152 | 03/01 → 08/04 | 2.946 | B | AM | 6 | 24 | XFJ (ES9J4S) | | 81813 |

C 5 II, Break

| | | | | | | | | | | |
|---------|-----|---------------|-------|---|---|---|----|-------------------------------------|--------|------------------|
| 1.6 HDi | 80 | 09/04 → | 1.560 | D | M | 4 | 16 | 9HY (DV6TED4), 9HZ (DV6TED4) | | 81869 |
| 1.8 16V | 92 | 09/05 → | 1.749 | B | M | 4 | 16 | 6FY (EW7A) | (-)COP | 84038 NEW |
| | 92 | 09/05 → | 1.749 | B | M | 4 | 16 | 6FY (EW7A) | (+)COP | 82089 |
| | 92 | 09/05 → | 1.749 | B | M | 4 | 16 | 6FY (EW7A) | | 82089 |
| | 92 | 09/05 → | 1.749 | B | M | 4 | 16 | 6FY (EW7A) | | 81799 |
| | 85 | 09/04 → | 1.749 | B | M | 4 | 16 | 6FZ (EW7J4) | (-)COP | 84038 NEW |
| | 85 | 09/04 → | 1.749 | B | M | 4 | 16 | 6FZ (EW7J4) | (+)COP | 82089 |
| | 85 | 09/04 → | 1.749 | B | M | 4 | 16 | 6FZ (EW7J4) | | 82089 |
| 2.0 16V | 103 | 09/04 → | 1.997 | B | M | 4 | 16 | RFJ (EW10A) | (-)COP | 84038 NEW |
| | 103 | 09/04 → | 1.997 | B | M | 4 | 16 | RFJ (EW10A) | (+)COP | 82089 |
| | 103 | 09/04 → | 1.997 | B | M | 4 | 16 | RFJ (EW10A) | | 82089 |
| | 103 | 09/04 → | 1.997 | B | M | 4 | 16 | RFJ (EW10A) | | 81799 |
| 2.0 HDi | 100 | 09/04 → | 1.997 | D | M | 4 | 16 | RHR (DW10BTED4) | | 81800 |
| 2.2 HDi | 120 | 05/06 → | 2.179 | D | M | 4 | 16 | 4HP (DW12BTED4), 4HR (DW12BTED4) | | 82068 |
| | 125 | 04/06 → | 2.179 | D | M | 4 | 16 | 4HT (DW12BTED4) | | 82068 |
| | 98 | 09/04 → | 2.179 | D | M | 4 | 16 | 4HX (DW12TED4/FAP) | | 81800 |
| 3.0 | 173 | 09/04 → | 2.946 | B | M | 6 | 24 | XFJ (ES9J4S) | | 81813 |
| 3.0 V6 | 155 | 10/04 → 04/07 | 2.946 | B | M | 6 | 24 | XFU (ES9A) | | 81813 |
| | 152 | 09/04 → | 2.946 | B | M | 6 | 24 | XFU (ES9A) | | 81813 |
| | 152 | 09/04 → | 2.946 | B | M | 6 | 24 | XFU (ES9A), XFJ (ES9J4S) | | 81813 |

C 5 III, Break

| | | | | | | | | | | |
|-------------|-----|---------|-------|---|---|---|----|------------------------|--|-------|
| 1.6 HDi | 80 | 02/08 → | 1.560 | D | M | 4 | 16 | 9HZ (DV6TED4) | | 81869 |
| 1.6 HDi 110 | 82 | 07/10 → | 1.560 | D | M | 4 | 8 | 9HL (DV6C), 9HR (DV6C) | | 81869 |
| 1.6 HDi 115 | 84 | 01/12 → | 1.560 | D | M | 4 | 8 | 9HL (DV6C), 9HR (DV6C) | | 81869 |
| 1.6 THP 150 | 110 | 07/10 → | 1.598 | B | M | 4 | 16 | 5FN (EP6CDT) | | 82032 |
| 1.6 THP 155 | 115 | 04/09 → | 1.598 | B | M | 4 | 16 | 5FV (EP6CDT) | | 82032 |
| 1.6 VTi 120 | 88 | 07/10 → | 1.598 | B | M | 4 | 16 | 5FS (EP6C) | | 82032 |

| | | | | | | | | |
|----|-----|--|--|--|---------------|--|--|--|
| | | | | | | | | |
| KW | cm³ | | | | NO. OF VALVES | | | |

CITROËN

C 5 III, Break

| | | | | | | | | | | | |
|---------------------------|-----|---------|-------|---|---|---|----|-------------------------------------|--------------|-------|------------|
| 1.8 16V | 92 | 02/08 → | 1.749 | B | M | 4 | 16 | 6FY (EW7A) | (-)COP | 84038 | NEW |
| | 92 | 02/08 → | 1.749 | B | M | 4 | 16 | 6FY (EW7A) | (+)COP | 82089 | |
| | 92 | 02/08 → | 1.749 | B | M | 4 | 16 | 6FY (EW7A) | | 82089 | |
| | 92 | 02/08 → | 1.749 | B | M | 4 | 16 | 6FY (EW7A) | | 81799 | |
| 2.0 16V | 103 | 02/08 → | 1.997 | B | M | 4 | 16 | RFJ (EW10A) | (-)COP | 84038 | NEW |
| | 103 | 02/08 → | 1.997 | B | M | 4 | 16 | RFJ (EW10A) | (+)COP | 82089 | |
| | 103 | 02/08 → | 1.997 | B | M | 4 | 16 | RFJ (EW10A) | | 82089 | |
| | 103 | 02/08 → | 1.997 | B | M | 4 | 16 | RFJ (EW10A) | | 81799 | |
| 2.0 16V BioFlex | 103 | 02/08 → | 1.997 | | M | 4 | 16 | RFJ (EW10A) | (-)COP | 84038 | NEW |
| | 103 | 02/08 → | 1.997 | | M | 4 | 16 | RFJ (EW10A) | (+)COP | 82089 | |
| | 103 | 02/08 → | 1.997 | | M | 4 | 16 | RFJ (EW10A) | | 82089 | |
| | 103 | 02/08 → | 1.997 | | M | 4 | 16 | RFJ (EW10A) | | 81799 | |
| 2.0 HDi | 100 | 02/08 → | 1.997 | D | M | 4 | 16 | RHF (DW10BTED4), RHR (DW10BTED4) | | 81800 | |
| | 100 | 02/08 → | 1.997 | D | M | 4 | 16 | RHR (DW10BTED4) | | 81800 | |
| 2.0 HDi 140 | 103 | 04/09 → | 1.997 | D | M | 4 | 16 | RHF (DW10BTED4) | | 81800 | |
| 2.0 HDi 150 / BlueHDi 150 | 110 | 04/09 → | 1.997 | D | M | 4 | 16 | AHR (DW10FD), RHE (DW10CTED4) | M: DW10CTED4 | 84020 | NEW |
| | 110 | 04/09 → | 1.997 | D | M | 4 | 16 | AHR (DW10FD), RHE (DW10CTED4) | | 82068 | |
| 2.0 HDi 165 | 120 | 04/09 → | 1.997 | D | M | 4 | 16 | RHH (DW10CTED4) | | 84020 | NEW |
| | 120 | 04/09 → | 1.997 | D | M | 4 | 16 | RHH (DW10CTED4) | | 81800 | |
| 2.0 HDi 180 | 133 | 03/15 → | 1.997 | D | M | 4 | 16 | AHW (DW10FC) | | 82068 | |
| 2.2 HDi | 125 | 02/08 → | 2.179 | D | M | 4 | 16 | 4HT (DW12BTED4) | | 82068 | |
| 2.2 HDi 165 | 120 | 02/08 → | 2.179 | D | M | 4 | 16 | 4HP (DW12BTED4) | | 82068 | |
| 2.2 HDi 200 | 150 | 07/10 → | 2.179 | D | M | 4 | 16 | 4HL (DW12C) | | 82068 | |
| 2.7 HDi | 150 | 02/08 → | 2.720 | D | M | 6 | 24 | DT17ED4 | | 82067 | |
| | 150 | 02/08 → | 2.720 | D | M | 6 | 24 | DT17ED4, UHZ (DT17BTED4) | | 82067 | |
| 3.0 HDi 240 | 177 | 04/09 → | 2.992 | D | M | 6 | 24 | DT20C | | 84019 | NEW |
| 3.0 V6 | 155 | 02/08 → | 2.946 | B | M | 6 | 24 | XFU (ES9A) | | 81813 | |

C 6

| | | | | | | | | | | | |
|---------|-----|---------|-------|---|---|---|----|-----------------------------|--|-------|------------|
| 2.2 HDi | 120 | 06/06 → | 2.179 | D | M | 4 | 16 | 4HP (DW12BTED4) | | 82068 | |
| | 125 | 06/06 → | 2.179 | D | M | 4 | 16 | 4HT (DW12BTED4) | | 82068 | |
| 2.7 HDi | 150 | 09/05 → | 2.720 | D | M | 6 | 24 | DT17ED4, UHZ (DT17BTED4) | | 82067 | |
| 3.0 HDi | 177 | 04/09 → | 2.992 | D | M | 6 | 24 | DT20C | | 84019 | NEW |
| 3.0 V6 | 155 | 09/05 → | 2.946 | B | M | 6 | 24 | XFV (ES9A), XFX (ES9J4S) | | 81813 | |

C 8

| | | | | | | | | | | | |
|-----|-----|---------|-------|---|---|---|----|--------------|--------|-------|------------|
| 2.0 | 100 | 07/02 → | 1.997 | B | M | 4 | 16 | RFN (EW10J4) | (-)COP | 84038 | NEW |
| | 100 | 07/02 → | 1.997 | B | M | 4 | 16 | RFN (EW10J4) | (+)COP | 82089 | |
| | 100 | 07/02 → | 1.997 | B | M | 4 | 16 | RFN (EW10J4) | | 82089 | |
| | 100 | 07/02 → | 1.997 | B | M | 4 | 16 | RFN (EW10J4) | | 81799 | |

KW

cm³

NO. OF VALVES

MAGNETI MARELLI
CITROËN
C 8

| | | | | | | | | | | | |
|-------------|-----|---------|-------|---|---|---|----|--|--------|-------|------------|
| 2.0 16V | 103 | 09/05 → | 1.997 | B | M | 4 | 16 | RFJ (EW10A) | (-)COP | 84038 | NEW |
| | 103 | 09/05 → | 1.997 | B | M | 4 | 16 | RFJ (EW10A) | (+)COP | 82089 | |
| | 103 | 09/05 → | 1.997 | B | M | 4 | 16 | RFJ (EW10A) | | 82089 | |
| | 103 | 09/05 → | 1.997 | B | M | 4 | 16 | RFJ (EW10A) | | 81799 | |
| | 104 | 09/05 → | 1.997 | B | M | 4 | 16 | RFJ (EW10A) | (-)COP | 84038 | NEW |
| | 104 | 09/05 → | 1.997 | B | M | 4 | 16 | RFJ (EW10A) | (+)COP | 82089 | |
| | 104 | 09/05 → | 1.997 | B | M | 4 | 16 | RFJ (EW10A) | | 82089 | |
| | 104 | 09/05 → | 1.997 | B | M | 4 | 16 | RFJ (EW10A) | | 81799 | |
| 2.0 HDi | 79 | 07/02 → | 1.997 | D | M | 4 | 16 | RHM (DW10ATED4), RHT (DW10ATED4) | | 81713 | |
| | 80 | 07/02 → | 1.997 | D | M | 4 | 16 | RHW (DW10ATED4) | | 81800 | |
| | 88 | 02/07 → | 1.997 | D | M | 4 | 16 | RHK (DW10UTED4) | | 81800 | |
| 2.0 HDi 135 | 100 | 03/06 → | 1.997 | D | M | 4 | 16 | RHD (DW10CB), RHD (DW10CTED4), RHR (DW10BTED4) | | 81800 | |
| 2.0 HDi 165 | 120 | 03/06 → | 1.997 | D | M | 4 | 16 | RHE (DW10CTED4), RHH (DW10CTED4) | | 81800 | |
| 2.2 | 116 | 07/02 → | 2.230 | B | M | 4 | 16 | 3FZ (EW12J4) | (-)COP | 84038 | NEW |
| | 116 | 07/02 → | 2.230 | B | M | 4 | 16 | 3FZ (EW12J4) | (+)COP | 82089 | |
| | 116 | 07/02 → | 2.230 | B | M | 4 | 16 | 3FZ (EW12J4) | | 82089 | |
| | 116 | 07/02 → | 2.230 | B | M | 4 | 16 | 3FZ (EW12J4) | | 81799 | |
| 2.2 HDi | 94 | 07/02 → | 2.179 | D | M | 4 | 16 | 4HW (DW12TED4) | | 81800 | |
| | 120 | 06/07 → | 2.179 | D | M | 4 | 16 | 4HP (DW12BTED4), 4HR (DW12BTED4) | | 82068 | |
| | 125 | 06/06 → | 2.179 | D | M | 4 | 16 | 4HT (DW12BTED4) | | 82068 | |
| 3.0 V6 | 150 | 07/02 → | 2.946 | B | M | 6 | 24 | XFX (ES9J4S) | | 81813 | |

C-Crosser

| | | | | | | | | | | | |
|---------|-----|---------|-------|---|---|---|----|-----------------|--|-------|--|
| 2.2 HDi | 115 | 02/07 → | 2.179 | D | M | 4 | 16 | 4HN (DW12MTED4) | | 82068 | |
|---------|-----|---------|-------|---|---|---|----|-----------------|--|-------|--|

C-Elysee

| | | | | | | | | | | | |
|-----------------|----|---------|-------|---|---|---|----|-----------------------------------|--|-------|------------|
| 1.2 VTi 72 | 53 | 11/12 → | 1.199 | B | M | 3 | 12 | HMY (EB2M) | | 84066 | NEW |
| 1.2 VTi 82 | 60 | 12/14 → | 1.199 | B | M | 3 | 12 | | | 84066 | NEW |
| 1.6 BlueHDi 100 | 73 | 11/14 → | 1.560 | D | M | 4 | 8 | BHY (DV6FD) | | 81869 | |
| 1.6 HDi 92 | 68 | 11/12 → | 1.560 | D | M | 4 | 8 | 9HJ (DV6DTEDM), 9HP (DV6DTEDE) | | 81869 | |
| 1.6 VTi 115 | 85 | 11/12 → | 1.587 | B | M | 4 | 16 | NFP (EC5) | | 81753 | |

CX II, Break

| | | | | | | | | | | | |
|----------------|-----|---------------|-------|---|---|---|---|---------|-------|-------|--|
| 25 D | 54 | 08/85 → 12/92 | 2.500 | D | M | 4 | 8 | M25-660 | | 81822 | |
| 25 D Turbo | 88 | 01/87 → 12/92 | 2.500 | D | M | 4 | 8 | M25-669 | | 81822 | |
| 25 D Turbo 2 | 88 | 01/87 → 12/92 | 2.500 | D | M | 4 | 8 | M25-669 | | 81822 | |
| 25 GTi | 89 | 05/86 → 12/92 | 2.500 | B | M | 4 | 8 | M25-668 | (-)AC | 81822 | |
| 25 GTi Turbo 2 | 115 | 09/86 → 12/92 | 2.500 | B | M | 4 | 8 | M25-667 | (-)AC | 81822 | |
| | 122 | 08/85 → 12/92 | 2.500 | B | M | 4 | 8 | M25-662 | (-)AC | 81822 | |
| 25 i | 89 | 05/86 → 12/92 | 2.500 | B | M | 4 | 8 | M25-668 | (-)AC | 81822 | |
| 25 TRi | 100 | 08/85 → 12/92 | 2.500 | B | M | 4 | 8 | M25-659 | (-)AC | 81822 | |

KW

cm³

NO. OF VALVES

CITROËN
DS 3, Cabrio

| | | | | | | | | | | | |
|-----------------|-----|---------------|-------|---|---|---|----|---------------------------|--|-------|------------|
| 1.2 THP 110 | 81 | 10/14 → 03/15 | 1.199 | B | M | 3 | 12 | HNZ (EB2DT) | | 84066 | NEW |
| 1.2 VTi 82 | 60 | 01/13 → 03/15 | 1.199 | B | M | 3 | 12 | HMZ (EB2F) | | 84066 | NEW |
| 1.4 HDi 70 | 50 | 04/10 → 07/15 | 1.398 | D | M | 4 | 8 | 8HR (DV4C) | | 81798 | |
| 1.4 VTi 95 | 70 | 04/10 → 07/15 | 1.397 | B | M | 4 | 16 | 8FP (EP3) | | 82032 | |
| 1.4 VTi 95 LPG | 70 | 08/12 → 07/15 | 1.397 | | M | 4 | 16 | 8FN (EP3) | | 82032 | |
| 1.4 VTi 98 | 72 | 11/09 → 07/15 | 1.397 | B | M | 4 | 16 | 8FR (EP3) | | 82032 | |
| 1.6 BlueHDi 100 | 73 | 07/14 → 07/15 | 1.560 | D | M | 4 | 8 | BHY (DV6FD) | | 81869 | |
| 1.6 BlueHDi 120 | 88 | 10/13 → 07/15 | 1.560 | D | M | 4 | 8 | BHZ (DV6FC) | | 81869 | |
| 1.6 HDi 110 | 82 | 11/09 → 07/15 | 1.560 | D | M | 4 | 8 | 9HR (DV6C) | | 81869 | |
| 1.6 HDi 115 | 84 | 08/12 → 07/15 | 1.560 | D | M | 4 | 8 | 9HD (DV6C), 9HL (DV6C) | | 81869 | |
| 1.6 HDi 115 | 85 | 10/13 → 07/15 | 1.560 | D | M | 4 | 8 | BHX (DV6FC) | | 81869 | |
| 1.6 HDi 90 | 68 | 11/09 → 07/15 | 1.560 | D | M | 4 | 8 | 9HP (DV6DTEd) | | 81869 | |
| | 69 | 01/13 → 07/15 | 1.560 | D | M | 4 | 8 | 9HP (DV6DTEd) | | 81869 | |
| 1.6 Racing | 147 | 02/11 → 07/15 | 1.598 | B | M | 4 | 16 | 5FU (EP6CDTX) | | 82032 | |
| | 152 | 02/11 → 07/15 | 1.598 | B | M | 4 | 16 | 5FD (EP6DTS) | | 82032 | |
| 1.6 THP 150 | 110 | 01/13 → 07/15 | 1.598 | B | M | 4 | 16 | 5FN (EP6CDT) | | 82032 | |
| | 110 | 01/10 → 07/15 | 1.598 | B | M | 4 | 16 | 5FN (EP6CDT), 5FX (EP6DT) | | 82032 | |
| 1.6 THP 155 | 115 | 04/10 → 07/15 | 1.598 | B | M | 4 | 16 | 5FR (EP6DT), 5FV (EP6CDT) | | 82032 | |
| | 115 | 01/13 → 07/15 | 1.598 | B | M | 4 | 16 | 5FV (EP6CDT) | | 82032 | |
| 1.6 VTi 120 | 88 | 04/10 → 07/15 | 1.598 | B | M | 4 | 16 | 5FS (EP6C) | | 82032 | |

DS 4

| | | | | | | | | | | | |
|-------------|-----|---------------|-------|---|---|---|----|---------------------------|--|-------|------------|
| 1.2 THP 130 | 96 | 07/14 → 07/15 | 1.199 | B | M | 3 | 12 | HNY (EB2DTS) | | 84066 | NEW |
| 1.6 HDi 110 | 81 | 04/11 → 07/15 | 1.560 | | M | 4 | 16 | | | 81869 | |
| | 82 | 04/11 → 07/15 | 1.560 | D | M | 4 | 8 | 9HR (DV6C) | | 81869 | |
| 1.6 HDi 115 | 84 | 08/12 → 07/15 | 1.560 | D | M | 4 | 8 | 9HD (DV6C), 9HL (DV6C) | | 81869 | |
| 1.6 HDi 90 | 68 | 05/11 → 07/15 | 1.560 | D | M | 4 | 8 | 9HP (DV6DTEd) | | 81869 | |
| 1.6 THP 155 | 115 | 04/11 → 07/15 | 1.598 | B | M | 4 | 16 | 5FV (EP6CDT) | | 82032 | |
| 1.6 THP 160 | 120 | 04/12 → 07/15 | 1.598 | B | M | 4 | 16 | 5FM (EP6DT) | | 82032 | |
| 1.6 THP 165 | 121 | 01/12 → 07/15 | 1.598 | B | M | 4 | 16 | 5FM (EP6DT), 5GZ (EP6FDT) | | 82032 | |
| 1.6 THP 200 | 147 | 04/11 → 07/15 | 1.598 | B | M | 4 | 16 | 5FU (EP6DTX) | | 82032 | |
| 1.6 VTi 120 | 88 | 04/11 → 07/15 | 1.598 | B | M | 4 | 16 | 5FS (EP6C) | | 82032 | |
| 2.0 HDi 135 | 100 | 09/11 → 07/15 | 1.997 | D | M | 4 | 16 | RHE (DW10CTED4) | | 84020 | NEW |
| 2.0 HDi 165 | 120 | 04/11 → 07/15 | 1.997 | D | M | 4 | 16 | RHH (DW10CTED4) | | 84020 | NEW |

DS 5

| | | | | | | | | | | | |
|-----------------|-----|---------------|-------|---|---|---|----|--------------|--|-------|--|
| 1.6 BlueHDi 120 | 88 | 07/14 → 07/15 | 1.560 | D | M | 4 | 8 | BHZ (DV6FC) | | 81869 | |
| 1.6 HDi | 85 | 11/13 → 07/15 | 1.560 | D | M | 4 | 8 | BHX (DV6FC) | | 81869 | |
| 1.6 HDi 110 | 82 | 11/11 → 07/15 | 1.560 | D | M | 4 | 8 | 9HR (DV6C) | | 81869 | |
| 1.6 HDi 115 | 84 | 06/12 → 07/15 | 1.560 | D | M | 4 | 8 | 9HD (DV6C) | | 81869 | |
| 1.6 THP 155 | 115 | 11/11 → 07/15 | 1.598 | B | M | 4 | 16 | 5FV (EP6CDT) | | 82032 | |
| 1.6 THP 200 | 147 | 11/11 → 07/15 | 1.598 | B | M | 4 | 16 | 5FU (EP6DTX) | | 82032 | |
| 2.0 BlueHDi 180 | 133 | 08/13 → 07/15 | 1.997 | D | M | 4 | 16 | AHW (DW10FC) | | 82068 | |

KW

cm³

NO. OF VALVES

CITROËN
DS 5

| | | | | | | | | | | | |
|-------------------------|-----|---------------|-------|---|---|---|----|-----------------|--|-------|------------|
| 2.0 HDi 135 | 100 | 11/11 → 07/15 | 1.997 | D | M | 4 | 16 | RHD (DW10CB) | | 84020 | NEW |
| 2.0 HDi 165 | 120 | 11/11 → 07/15 | 1.997 | D | M | 4 | 16 | RHH (DW10CTED4) | | 84020 | NEW |
| 2.0 HDi 165 Hybrid4 4x4 | 120 | 12/11 → 07/15 | 1.997 | | M | 4 | 16 | RHC (DW10CTED4) | | 84020 | NEW |

Evasion

| | | | | | | | | | | | |
|----------------|-----|---------------|-------|---|---|---|----|-----------------------------------|-----------|-------|------------|
| 1.8 | 73 | 05/97 → 07/02 | 1.761 | B | M | 4 | 8 | LFZ (XU7JP) | 06-1996 → | 81512 | |
| 1.9 TD | 66 | 11/94 → 07/02 | 1.905 | D | M | 4 | 8 | D8B (XUD9TF), DHX (XUD9TF/BTF) | | 81642 | |
| | 68 | 10/95 → 12/98 | 1.905 | D | M | 4 | 8 | D8B (XUD9TF) | | 81642 | |
| 2.0 | 89 | 06/94 → 07/02 | 1.998 | B | M | 4 | 8 | RFU (XU10J2/C) | 06-1994 → | 81642 | |
| 2.0 16V | 100 | 05/00 → 07/02 | 1.997 | B | M | 4 | 16 | RFN (EW10J4) | (-)COP | 84038 | NEW |
| | 100 | 05/00 → 07/02 | 1.997 | B | M | 4 | 16 | RFN (EW10J4) | (+)COP | 82089 | |
| | 100 | 05/00 → 07/02 | 1.997 | B | M | 4 | 16 | RFN (EW10J4) | | 82089 | |
| | 100 | 05/00 → 07/02 | 1.997 | B | M | 4 | 16 | RFN (EW10J4) | | 81799 | |
| | 97 | 05/98 → 04/00 | 1.998 | B | M | 4 | 16 | RFV (XU10J4R) | | 81711 | |
| 2.0 HDi | 80 | 08/99 → 07/02 | 1.997 | D | M | 4 | 8 | RHZ (DW10ATED) | | 81713 | |
| 2.0 HDi 16V | 80 | 09/99 → 07/02 | 1.997 | D | M | 4 | 16 | RHW (DW10ATED4) | | 81713 | |
| 2.0 Turbo C.T. | 108 | 06/94 → 07/02 | 1.998 | B | M | 4 | 8 | RGX (XU10J2TE) | 06-1994 → | 81642 | |
| 2.1 TD | 80 | 05/96 → 07/02 | 2.088 | D | M | 4 | 12 | P8C (XUD11BTE) | 06-1996 → | 81353 | |

Jumper I

| | | | | | | | | | | | |
|-------------|----|---------------|-------|---|---|---|----|------------------|-----------|-------|--|
| 1.9 D | 50 | 07/99 → 04/02 | 1.905 | D | M | 4 | 8 | DJY (XUD9A) | | 81642 | |
| | 51 | 01/99 → 04/02 | 1.905 | D | M | 4 | 8 | D9B (XUD9A/U) | | 81642 | |
| 1.9 TD | 66 | 08/94 → 04/02 | 1.905 | D | M | 4 | 8 | D8C (XUD9UTF) | | 81642 | |
| | 66 | 03/94 → 04/02 | 1.905 | D | M | 4 | 8 | DHX (XUD9TF/BTF) | | 81642 | |
| | 68 | 02/94 → 04/02 | 1.905 | D | M | 4 | 8 | D8C (XUD9UTF) | | 81642 | |
| 1.9 TD 4x4 | 68 | 08/96 → 04/02 | 1.905 | D | M | 4 | 8 | D8C (XUD9UTF) | | 81642 | |
| 2.0 | 80 | 02/94 → 04/02 | 1.998 | B | M | 4 | 8 | RFW (XU10J2U) | | 81642 | |
| 2.0 4x4 | 80 | 08/96 → 04/02 | 1.998 | B | M | 4 | 8 | RFW (XU10J2U) | | 81642 | |
| 2.0 HDi | 62 | 11/01 → 04/02 | 1.997 | D | M | 4 | 8 | RHV (DW10UTD) | | 81713 | |
| 2.5 D | 63 | 08/94 → 04/02 | 2.446 | D | M | 4 | 8 | T9A (DJ5) | → 04-1996 | 81752 | |
| | 63 | 08/94 → 04/02 | 2.446 | D | M | 4 | 8 | T9A (DJ5) | 05-1996 → | 81712 | |
| 2.5 D 4x4 | 63 | 08/96 → 04/02 | 2.446 | D | M | 4 | 8 | T9A (DJ5) | | 81712 | |
| 2.5 DT 4x4 | 76 | 10/96 → 08/97 | 2.446 | D | M | 4 | 12 | THZ (DJ5T) | | 81712 | |
| 2.5 TD | 76 | 08/94 → 04/02 | 2.446 | D | M | 4 | 12 | T8A (DJ5T) | → 04-1996 | 81752 | |
| | 76 | 08/94 → 04/02 | 2.446 | D | M | 4 | 12 | T8A (DJ5T) | 05-1996 → | 81712 | |
| 2.5 TD 4x4 | 76 | 08/96 → 04/02 | 2.446 | D | M | 4 | 12 | T8A (DJ5T) | | 81712 | |
| 2.5 TDi | 79 | 12/96 → 11/00 | 2.446 | D | M | 4 | 8 | THX (DJ5TED) | | 81712 | |
| 2.5 TDi 4x4 | 79 | 12/96 → 11/00 | 2.446 | D | M | 4 | 8 | THX (DJ5TED) | | 81712 | |
| 2.8 D | 64 | 01/99 → 02/02 | 2.798 | D | M | 4 | 8 | 8140.63 (F28D) | | 81316 | |
| 2.8 HDi | 93 | 10/00 → 01/02 | 2.798 | D | M | 4 | 8 | 8140.43S | | 81316 | |
| | 94 | 09/00 → 04/02 | 2.798 | D | M | 4 | 8 | 8140.43S | | 81316 | |
| 2.8 HDi 4x4 | 94 | 09/00 → 04/02 | 2.798 | D | M | 4 | 8 | 8140.43S | | 81316 | |

| | | | | | | | | | |
|--|--|--|--|--|--|--|--|--|--|
| | | | | | | | | | |
|--|--|--|--|--|--|--|--|--|--|

CITROËN

Jumper II

| | | | | | | | | | | |
|----------------------------|-----|---------------|-------|---|----|---|---|--------------------------------|--|-------|
| 2.0 | 81 | 04/02 → | 1.998 | B | M | 4 | 8 | XU10J2 | | 81642 |
| 2.0 bivalent | 81 | 02/03 → | 1.998 | | M | 4 | 8 | XU10J2 | | 81642 |
| 2.0 HDi | 62 | 04/02 → | 1.997 | D | M | 4 | 8 | RHV (DW10TD), RHV (DW10UTD) | | 81713 |
| | 62 | 04/02 → | 1.997 | D | M | 4 | 8 | RHV (DW10UTD) | | 81713 |
| 2.2 HDi | 74 | 04/02 → | 2.179 | D | M | 4 | 8 | 4HY (DW12UTED) | | 81800 |
| 2.8 HDi | 94 | 04/02 → | 2.798 | D | AM | 4 | 8 | 8140.43S | | 81316 |
| | 107 | 05/04 → | 2.798 | D | M | 4 | 8 | 8140.43N | | 81316 |
| | 107 | 05/04 → | 2.800 | D | M | 4 | 8 | 8140.43N | | 81316 |
| 2.8 HDi 4x4 | 94 | 04/02 → | 2.798 | D | M | 4 | 8 | 8140.43S | | 81316 |
| | 94 | 02/02 → 06/06 | 2.798 | D | M | 4 | 8 | F28TDCR | | 81316 |
| 2.8 HDi Trazione integrale | 94 | 04/02 → | 2.798 | D | AM | 4 | 8 | 8140.43S | | 81316 |

Jumper III

| | | | | | | | | | | |
|-------------|-----|---------|-------|---|---|---|----|-------------------|--|-------|
| 2.2 HDi 100 | 74 | 04/06 → | 2.198 | D | M | 4 | 16 | 4HV (P22DTE) | | 82066 |
| 2.2 HDi 120 | 88 | 04/06 → | 2.198 | D | M | 4 | 16 | 4HU (P22DTE) | | 82066 |
| 2.2 HDi 150 | 110 | 07/11 → | 2.198 | D | M | 4 | 16 | 4HJ (P22DTE) | | 82066 |
| 3.0 HDi 145 | 107 | 07/10 → | 2.999 | D | M | 4 | 16 | F1CE3481N | | 82094 |
| 3.0 HDi 155 | 115 | 07/10 → | 2.999 | D | M | 4 | 16 | F1CE0481D (F30DT) | | 82094 |
| 3.0 HDi 160 | 116 | 09/06 → | 2.999 | D | M | 4 | 16 | F1CE0481D (F30DT) | | 82094 |
| 3.0 HDi 180 | 130 | 07/11 → | 2.999 | D | M | 4 | 16 | F1CE0481D (F30DT) | | 82094 |

Jumpy I

| | | | | | | | | | | |
|-------------|-----|---------------|-------|---|---|---|----|--------------------------|-------------------|-------|
| 1.6 | 58 | 10/95 → | 1.581 | B | M | 4 | 8 | 1580SPI, 220A2.000 | (-)COP | 81368 |
| | 58 | 10/95 → | 1.581 | B | M | 4 | 8 | 1580SPI, 220A2.000 | (+)COP | 81346 |
| | 59 | 10/95 → 08/00 | 1.581 | B | M | 4 | 8 | 220A2.000 | (-)COP | 81368 |
| | 59 | 10/95 → 08/00 | 1.581 | B | M | 4 | 8 | 220A2.000 | (+)COP | 81346 |
| 1.6 i | 58 | 10/95 → | 1.581 | B | M | 4 | 8 | 1580SPI, 220A2.000 | (-)COP | 81368 |
| | 58 | 10/95 → | 1.581 | B | M | 4 | 8 | 1580SPI, 220A2.000 | (+)COP, 10-1995 → | 81346 |
| 1.9 D | 51 | 10/95 → 04/98 | 1.905 | D | M | 4 | 8 | D9B (XUD9A/U) | 10-1995 → | 81642 |
| | 51 | 10/95 → 08/98 | 1.905 | D | M | 4 | 8 | D9B (XUD9A/U) | | 81642 |
| 1.9 D 70 | 51 | 04/98 → | 1.868 | D | M | 4 | 8 | WJY (DW8B), WJZ (DW8) | | 81713 |
| 1.9 DT | 65 | 10/95 → 08/00 | 1.905 | D | M | 4 | 8 | | | 81642 |
| 1.9 TD | 66 | 10/95 → | 1.905 | D | M | 4 | 8 | DHX (XUD9TF/BTF) | 10-1995 → | 81642 |
| | 66 | 10/95 → | 1.905 | D | M | 4 | 8 | DHX (XUD9TF/BTF) | | 81642 |
| | 68 | 04/96 → | 1.905 | D | M | 4 | 8 | D8B (XUD9TF) | | 81642 |
| 2.0 | 100 | 04/00 → 12/06 | 1.997 | B | M | 4 | 16 | RFN (EW10J4) | (-)COP | 84038 |
| | 100 | 04/00 → 12/06 | 1.997 | B | M | 4 | 16 | RFN (EW10J4) | (+)COP | 82089 |
| | 100 | 04/00 → 12/06 | 1.997 | B | M | 4 | 16 | RFN (EW10J4) | | 82089 |
| | 100 | 04/00 → 12/06 | 1.997 | B | M | 4 | 16 | RFN (EW10J4) | | 81799 |
| 2.0 HDi 110 | 80 | 03/00 → | 1.997 | D | M | 4 | 16 | RHW (DW10ATED4) | | 81713 |
| | 80 | 03/00 → | 1.997 | D | M | 4 | 8 | RHZ (DW10ATED) | | 81713 |
| 2.0 HDi 95 | 69 | 10/99 → | 1.997 | D | M | 4 | 8 | RHX (DW10BTED) | | 81713 |

KW

cm³

NO. OF VALVES

MAGNETI MARELLI
CITROËN
Jumpy I

| | | | | | | | | | | | |
|-----------|-----|---------|-------|---|---|---|----|--------------|--------|-------|------------|
| 2.0 i 16V | 102 | 03/00 → | 1.997 | B | M | 4 | 16 | RFN (EW10J4) | (-)COP | 84038 | NEW |
| | 102 | 03/00 → | 1.997 | B | M | 4 | 16 | RFN (EW10J4) | (+)COP | 82089 | |
| | 102 | 03/00 → | 1.997 | B | M | 4 | 16 | RFN (EW10J4) | | 82089 | |
| | 102 | 03/00 → | 1.997 | B | M | 4 | 16 | RFN (EW10J4) | | 81799 | |

Jumpy II

| | | | | | | | | | | | |
|-----------------|-----|---------------|-------|---|---|---|----|-----------------|--------|-------|------------|
| 1.9 TD | 68 | 10/99 → | 1.905 | D | M | 4 | 8 | D8B (XUD9TF) | | 81642 | |
| 2.0 | 100 | 12/03 → 10/06 | 1.997 | B | M | 4 | 16 | RFN (EW10J4) | (-)COP | 84038 | NEW |
| | 100 | 12/03 → 10/06 | 1.997 | B | M | 4 | 16 | RFN (EW10J4) | (+)COP | 82089 | |
| | 100 | 12/03 → 10/06 | 1.997 | B | M | 4 | 16 | RFN (EW10J4) | | 82089 | |
| | 100 | 12/03 → 10/06 | 1.997 | B | M | 4 | 16 | RFN (EW10J4) | | 81799 | |
| 2.0 HDi 110 | 80 | 12/03 → 10/06 | 1.997 | D | M | 4 | 8 | RHZ (DW10ATED) | | 81713 | |
| 2.0 HDi 110 16V | 80 | 12/03 → 10/06 | 1.997 | D | M | 4 | 16 | RHW (DW10ATED4) | | 81713 | |
| 2.0 HDi 95 | 69 | 10/99 → | 1.997 | D | M | 4 | 8 | RHX (DW10BTED) | | 81713 | |

Jumpy III

| | | | | | | | | | | | |
|----------------|-----|---------|-------|---|---|---|----|------------------------------|--------|-------|------------|
| 1.6 HDi 90 16V | 66 | 01/07 → | 1.560 | D | M | 4 | 16 | 9HU (DV6UTED4) | | 81869 | |
| 1.6 HDi 90 8V | 66 | 01/07 → | 1.560 | D | M | 4 | 8 | 9HH (DV6DUM), 9HM (DV6UC) | | 81869 | |
| 2.0 HDi 120 | 88 | 01/07 → | 1.997 | D | M | 4 | 16 | RHK (DW10UTED4) | | 81800 | |
| 2.0 HDi 125 | 94 | 07/11 → | 1.997 | D | M | 4 | 16 | AHZ (DW10CD) | | 84020 | NEW |
| 2.0 HDi 140 | 100 | 01/07 → | 1.997 | D | M | 4 | 16 | RHR (DW10BTED4) | | 81800 | |
| 2.0 HDi 165 | 120 | 07/10 → | 1.997 | D | M | 4 | 16 | RHH (DW10CTED4) | | 84020 | NEW |
| 2.0 HDi 95 | 72 | 07/11 → | 1.997 | D | M | 4 | 16 | AHY (DW10CE) | | 84020 | NEW |
| 2.0 i | 103 | 01/07 → | 1.997 | B | M | 4 | 16 | RFH (EW10A) | (-)COP | 84038 | NEW |
| | 103 | 01/07 → | 1.997 | B | M | 4 | 16 | RFH (EW10A) | (+)COP | 82089 | |
| | 103 | 01/07 → | 1.997 | B | M | 4 | 16 | RFH (EW10A) | | 82089 | |
| | 103 | 01/07 → | 1.997 | B | M | 4 | 16 | RFH (EW10A) | | 81799 | |

Nemo, Van

| | | | | | | | | | | | |
|------------|----|---------|-------|---|---|---|----|------------------------|--|-------|--|
| 1.3 HDi 75 | 55 | 10/10 → | 1.248 | D | M | 4 | 16 | FHZ (F13DTE5) | | 81862 | |
| 1.4 | 54 | 04/09 → | 1.360 | B | M | 4 | 8 | KFT (TU3A), KFV (TU3A) | | 81797 | |
| | 54 | 02/08 → | 1.360 | B | M | 4 | 8 | KFV (TU3A) | | 81797 | |
| 1.4 HDi | 50 | 02/08 → | 1.398 | D | M | 4 | 8 | 8HS (DV4TED) | | 81798 | |
| | 50 | 04/09 → | 1.399 | D | M | 4 | 8 | 8HS (DV4TED) | | 81798 | |

Saxo

| | | | | | | | | | | | |
|-----------|----|---------------|-------|---|---|---|---|----------------------------|------------------------------|-------|--|
| 1.0 X | 33 | 05/96 → 11/98 | 954 | B | M | 4 | 8 | CDZ (TU9M) | | 81556 | |
| | 37 | 05/98 → 06/03 | 954 | B | M | 4 | 8 | CDZ (TU9M) | | 81556 | |
| 1.1 X, SX | 40 | 05/96 → 09/03 | 1.124 | B | M | 4 | 8 | HDZ (TU1M) | → 07-2000, → M: 3.666.765 | 81556 | |
| | 40 | 05/96 → 09/03 | 1.124 | B | M | 4 | 8 | HDZ (TU1M) | 08-2000 →, M →: 3.666.766 | 81797 | |
| | 44 | 05/96 → 09/03 | 1.124 | B | M | 4 | 8 | HDZ (TU1M), HFX (TU1JP) | → 07-2000, → M: 3.666.765 | 81556 | |
| | 44 | 05/96 → 09/03 | 1.124 | B | M | 4 | 8 | HDZ (TU1M), HFX (TU1JP) | 08-2000 →, M →: 3.666.766 | 81797 | |

KW

cm³

NO. OF VALVES

CITROËN
Saxo

| | | | | | | | | | | |
|-------------|----|---------------|-------|---|---|---|----|-----------------------------|------------------------------|-------|
| 1.4 VTS | 55 | 05/96 → 06/03 | 1.360 | B | M | 4 | 8 | KFW (TU3JP), KFX (TU3JP) | → 07-2000, → M: 3.666.765 | 81556 |
| | 55 | 05/96 → 06/03 | 1.360 | B | M | 4 | 8 | KFW (TU3JP), KFX (TU3JP) | 08-2000 →, M →: 3.666.766 | 81797 |
| 1.5 D | 40 | 09/96 → 09/03 | 1.527 | D | M | 4 | 8 | VJY (TUD5) | | 81513 |
| | 42 | 09/96 → 06/01 | 1.527 | D | M | 4 | 8 | VJZ (TUD5) | | 81513 |
| | 43 | 07/01 → 04/04 | 1.527 | D | M | 4 | 8 | | | 81753 |
| 1.6 | 66 | 02/96 → 06/03 | 1.587 | B | M | 4 | 8 | NFZ (TU5JP) | | 81513 |
| | 74 | 02/01 → 04/04 | 1.587 | B | M | 4 | 8 | NFT (TU5JP) | | 81513 |
| | 88 | 02/96 → 04/04 | 1.587 | B | M | 4 | 16 | NFX (TU5JP4) | | 81753 |
| 1.6 VTL,VTR | 65 | 05/96 → 06/03 | 1.587 | B | M | 4 | 8 | NFZ (TU5JP) | | 81513 |
| 1.6 VTS | 72 | 09/00 → 09/03 | 1.587 | B | M | 4 | 8 | NFT (TU5JP) | | 81513 |
| | 87 | 06/96 → 09/03 | 1.587 | B | M | 4 | 16 | NFX (TU5JP4) | | 81753 |

Visa, Cabrio

| | | | | | | | | | | |
|--------|----|---------------|-------|---|---|---|---|-------------|----------------------------|-------|
| 11 E | 37 | 07/82 → 03/91 | 1.124 | B | M | 4 | 8 | 109/5F | | 81572 |
| 14 | 44 | 07/84 → 03/91 | 1.360 | B | M | 4 | 8 | 150D (XY7) | | 81572 |
| 14 GT | 58 | 03/82 → 03/91 | 1.360 | B | M | 4 | 8 | 150B (XY8) | | 81572 |
| 16 GTI | 83 | 06/86 → 03/91 | 1.580 | B | M | 4 | 8 | B6D | PROD →: 3584 | 81512 |
| 17 D | 44 | 04/84 → 03/91 | 1.769 | D | M | 4 | 8 | 161A (XUD7) | → 12-1986, → PROD: 3583 | 81554 |
| | 44 | 04/84 → 03/91 | 1.769 | D | M | 4 | 8 | 161A (XUD7) | 01-1987 →, PROD →: 3584 | 81512 |

Xantia I, Break

| | | | | | | | | | | |
|-------------|----|---------------|-------|---|---|---|----|--|-------------------------|-------|
| 1.6 i | 65 | 03/93 → 01/98 | 1.580 | B | M | 4 | 8 | BFZ (XU5JP) | 11-1996 → | 81512 |
| | 66 | 04/97 → 01/98 | 1.761 | B | M | 4 | 8 | LFX (XU7JB) | | 81512 |
| 1.8 i | 74 | 03/93 → 01/98 | 1.761 | B | M | 4 | 8 | LFZ (XU7JP) | 03-1993 →, → 10-1996 | 81512 |
| | 74 | 06/95 → 01/98 | 1.761 | B | M | 4 | 8 | LFZ (XU7JP) | 11-1996 → | 81512 |
| 1.8 i 16V | 81 | 06/95 → 01/98 | 1.761 | B | M | 4 | 16 | LFY (XU7JP4) | 11-1996 → | 81710 |
| 1.9 D | 50 | 06/94 → 01/98 | 1.905 | D | M | 4 | 8 | DJZ (XUD9Y) | → PROD: 6264 | 81672 |
| | 50 | 06/94 → 01/98 | 1.905 | D | M | 4 | 8 | DJZ (XUD9Y) | PROD →: 6265 | 81642 |
| | 51 | 06/94 → 01/98 | 1.905 | D | M | 4 | 8 | D9B (XUD9A/L) | → PROD: 6264 | 81672 |
| | 51 | 06/94 → 01/98 | 1.905 | D | M | 4 | 8 | D9B (XUD9A/L) | PROD →: 6265 | 81642 |
| 1.9 SD | 55 | 02/96 → 01/98 | 1.905 | D | M | 4 | 8 | DHW (XUD9SD) | → PROD: 6264 | 81672 |
| | 55 | 02/96 → 01/98 | 1.905 | D | M | 4 | 8 | DHW (XUD9SD) | PROD →: 6265 | 81642 |
| 1.9 Turbo D | 66 | 06/95 → 01/98 | 1.905 | D | M | 4 | 8 | D8B (XUD9TF), DHX (XUD9TF/BTF), DHY (XUD9TE/Y) | → PROD: 6264 | 81672 |
| | 66 | 06/95 → 01/98 | 1.905 | D | M | 4 | 8 | D8B (XUD9TF), DHX (XUD9TF/BTF), DHY (XUD9TE/Y) | PROD →: 6265 | 81642 |
| | 66 | 10/94 → 01/98 | 1.905 | D | M | 4 | 8 | DHX (XUD9TF/BTF), DHY (XUD9TE/Y) | → PROD: 6264 | 81672 |
| | 66 | 10/94 → 01/98 | 1.905 | D | M | 4 | 8 | DHX (XUD9TF/BTF), DHY (XUD9TE/Y) | PROD →: 6265 | 81642 |

KW

cm³

NO. OF VALVES

CITROËN
Xantia I, Break

| | | | | | | | | | | |
|-----------------|-----|---------------|-------|---|---|---|----|----------------|-------------------------|-------|
| 2.0 i | 89 | 03/93 → 01/98 | 1.998 | B | M | 4 | 8 | RFX (XU10J2C) | 03-1993 →, → 05-1995 | 81642 |
| | 89 | 06/95 → 01/98 | 1.998 | B | M | 4 | 8 | RFX (XU10J2C) | | 81642 |
| 2.0 i 16V | 97 | 06/95 → 01/98 | 1.998 | B | M | 4 | 16 | RFV (XU10J4R) | → 10-1996 | 81642 |
| | 97 | 06/95 → 01/98 | 1.998 | B | M | 4 | 16 | RFV (XU10J4R) | 11-1996 → | 81711 |
| | 110 | 06/94 → 01/98 | 1.998 | B | M | 4 | 16 | RFT (XU10J4/Z) | 06-1995 →, → 10-1996 | 81642 |
| 2.0 Turbo | 108 | 06/95 → 01/98 | 1.998 | B | M | 4 | 8 | RGX (XU10J2TE) | 06-1995 → | 81642 |
| 2.1 Turbo D 12V | 80 | 06/95 → 01/98 | 2.088 | D | M | 4 | 12 | P8C (XUD11BTE) | 06-1995 → | 81353 |
| | 80 | 06/96 → 01/98 | 2.088 | D | M | 4 | 12 | P8C (XUD11BTE) | 11-1996 → | 81353 |
| 3.0 i 24V | 140 | 01/97 → 01/98 | 2.946 | B | M | 6 | 24 | XFZ (ES9J4) | → T: 08441 | 81844 |
| | 140 | 01/97 → 01/98 | 2.946 | B | M | 6 | 24 | XFZ (ES9J4) | T →: 08442 | 82042 |

Xantia II, Break

| | | | | | | | | | | |
|-----------------|-----|---------------|-------|---|---|---|----|-------------------------------------|------------|-------|
| 1.6 i SX | 65 | 01/98 → 03/01 | 1.580 | B | M | 4 | 8 | BFZ (XU5JP) | | 81512 |
| 1.8 i | 66 | 01/98 → 04/03 | 1.761 | B | M | 4 | 8 | LFX (XU7JB) | | 81512 |
| 1.8 i 16V | 81 | 01/98 → 04/03 | 1.761 | B | M | 4 | 16 | LFY (XU7JP4) | | 81710 |
| 1.9 SD | 55 | 01/98 → 04/03 | 1.905 | D | M | 4 | 8 | DHW (XUD9SD) | | 81642 |
| 1.9 Turbo D | 66 | 01/98 → 04/03 | 1.905 | D | M | 4 | 8 | D8B (XUD9TF), DHX (XUD9TF/BTF) | | 81642 |
| | 66 | 01/98 → 04/03 | 1.905 | D | M | 4 | 8 | DHX (XUD9TF/BTF), DHY (XUD9TE/Y) | | 81642 |
| 2.0 HDI 109 | 80 | 02/99 → 04/03 | 1.997 | D | M | 4 | 8 | RHZ (DW10ATED) | | 81713 |
| 2.0 HDI 90 | 66 | 03/99 → 04/03 | 1.997 | D | M | 4 | 8 | RHY (DW10TD) | | 81713 |
| 2.0 i | 89 | 01/98 → 04/03 | 1.998 | B | M | 4 | 8 | RFX (XU10J2C) | | 81642 |
| 2.0 i 16V | 97 | 01/98 → 04/03 | 1.998 | B | M | 4 | 16 | RFV (XU10J4R) | | 81711 |
| 2.0 Turbo | 108 | 01/98 → 04/03 | 1.998 | B | M | 4 | 8 | RGX (XU10J2TE) | | 81642 |
| 2.1 Turbo D 12V | 80 | 01/98 → 02/99 | 2.088 | D | M | 4 | 12 | P8C (XUD11BTE) | 11-1996 → | 81353 |
| 3.0 V6 | 140 | 01/98 → 04/03 | 2.946 | B | M | 6 | 24 | XFZ (ES9J4) | → T: 08441 | 81844 |
| | 140 | 01/98 → 04/03 | 2.946 | B | M | 6 | 24 | XFZ (ES9J4) | T →: 08442 | 82042 |

XM I, Break

| | | | | | | | | | | |
|-------------|-----|---------------|-------|---|---|---|----|---|----------------------------|-------|
| 2.0 | 84 | 05/89 → 04/94 | 1.998 | B | M | 4 | 8 | | | 81642 |
| 2.0 i | 79 | 05/89 → 04/94 | 1.998 | B | M | 4 | 8 | RDZ (XU10MZ) | | 81642 |
| | 89 | 05/89 → 06/94 | 1.998 | B | M | 4 | 8 | RFZ (XU10J2) | | 81642 |
| 2.0 i Turbo | 104 | 09/92 → 06/94 | 1.998 | B | M | 4 | 8 | RGY (XU10J2TE/Z) | 01-1109310 →, → 05-1994 | 81642 |
| 2.0 Turbo | 104 | 09/92 → 04/94 | 1.998 | B | M | 4 | 8 | RGY (XU10J2TE/Z) | | 81642 |
| 2.1 D 12V | 60 | 05/89 → 06/94 | 2.138 | D | M | 4 | 12 | P9A (XUD11A) | | 81642 |
| 2.1 TD 12V | 80 | 11/91 → 04/94 | 2.088 | D | M | 4 | 12 | P8A (XUD11ATE), P8C (XUD11BTE), PHZ (XUD11ATE), PJZ (XUD11ATE) | 01-1991 →, → 07-1994 | 81353 |
| | 80 | 05/89 → 06/94 | 2.088 | D | M | 4 | 12 | P8A (XUD11ATE), PHZ (XUD11ATE), PJZ (XUD11ATE) | 05-1989 →, → 07-1994 | 81353 |

| | | | | | | | | |
|----|-----|--|--|--|--|---------------|--|--|
| | | | | | | | | |
| KW | cm³ | | | | | NO. OF VALVES | | |

CITROËN

XM II, Break

| | | | | | | | | | | |
|-------------|-----|---------------|-------|---|---|---|----|--|--------------|-------|
| 2.0 i 16V | 97 | 05/94 → 10/00 | 1.998 | B | M | 4 | 16 | RFV (XU10J4R) | 08-1994 → | 81711 |
| 2.0 Turbo | 108 | 05/94 → 10/00 | 1.998 | B | M | 4 | 8 | RGX (XU10J2TE) | | 81642 |
| | 108 | 05/94 → 10/00 | 1.998 | B | M | 4 | 8 | RGX (XU10J2TE), RGY (XU10J2TE/Z) | | 81642 |
| 2.1 D12 | 60 | 07/94 → 06/96 | 2.138 | D | M | 4 | 12 | P9A (XUD11A) | | 81642 |
| 2.1 D12 VSX | 60 | 03/96 → 08/96 | 2.138 | D | M | 4 | 12 | P9A (XUD11A) | | 81642 |
| 2.1 TD 12V | 80 | 05/94 → 10/00 | 2.088 | D | M | 4 | 12 | P8A (XUD11ATE), P8C (XUD120BTE), PHZ (XUD11ATE), PJZ (XUD11ATE) | 01-1994 → | 81353 |
| | 80 | 05/94 → 10/00 | 2.088 | D | M | 4 | 12 | P8C (XUD11BTE), PHZ (XUD11ATE), PJZ (XUD11ATE) | 01-1993 → | 81353 |
| 2.5 TD | 95 | 05/94 → 10/00 | 2.446 | D | M | 4 | 12 | THY (DK5ATE) | → PROD: 7143 | 81752 |
| | 95 | 05/94 → 10/00 | 2.446 | D | M | 4 | 12 | THY (DK5ATE) | PROD →: 7144 | 81712 |
| 3.0 V6 | 140 | 04/97 → 10/00 | 2.946 | B | M | 6 | 24 | XFZ (ES9J4) | → T: 08441 | 81844 |
| | 140 | 04/97 → 10/00 | 2.946 | B | M | 6 | 24 | XFZ (ES9J4) | T →: 08442 | 82042 |

Xsara, Break, Coupé, Picasso, Van

| | | | | | | | | | | |
|------------|----|---------------|-------|---|----|---|----|---------------------------------|------------------------------|-------|
| 1.4 HDi | 50 | 01/03 → 03/05 | 1.398 | D | M | 4 | 8 | 8HX (DV4TD) | | 81798 |
| 1.4 i | 55 | 04/97 → 03/05 | 1.360 | B | M | 4 | 8 | KFW (TU3JP), KFX (TU3JP) | → 08-2000, → M: 3.666.765 | 81556 |
| | 55 | 04/97 → 03/05 | 1.360 | B | M | 4 | 8 | KFW (TU3JP), KFX (TU3JP) | 09-2000 →, M →: 3.666.766 | 81797 |
| | 55 | 10/97 → 08/05 | 1.360 | B | M | 4 | 8 | KFW (TU3JP), KFX (TU3JP) | → M: 3.666.765 | 81556 |
| | 55 | 10/97 → 08/05 | 1.360 | B | M | 4 | 8 | KFW (TU3JP), KFX (TU3JP) | M →: 3.666.766 | 81797 |
| 1.5 D | 42 | 04/97 → 09/00 | 1.527 | D | M | 4 | 8 | VJZ (TUD5) | | 81513 |
| | 42 | 10/97 → 09/00 | 1.527 | D | M | 4 | 8 | VJZ (TUD5) | → PROD: 8385 | 81513 |
| 1.6 | 65 | 12/99 → | 1.587 | B | M | 4 | 8 | NFZ (TU5JP) | | 81513 |
| | 67 | 06/02 → | 1.587 | B | M | 4 | 8 | NFZ (TU5JP) | | 81513 |
| | 70 | 12/99 → | 1.587 | B | M | 4 | 8 | NFV (TU5JP) | | 81513 |
| 1.6 16V | 80 | 09/05 → | 1.587 | B | M | 4 | 16 | NFU (TU5JP4) | | 81513 |
| | 80 | 09/00 → 03/05 | 1.587 | B | AM | 4 | 16 | NFU (TU5JP4) | | 81753 |
| | 80 | 09/00 → 03/05 | 1.587 | B | M | 4 | 16 | NFU (TU5JP4) | | 81753 |
| | 81 | 06/05 → 09/06 | 1.587 | B | M | 4 | 16 | NFU (TU5JP4) | | 81753 |
| 1.6 Chrono | 74 | 04/01 → 10/04 | 1.587 | B | M | 4 | 8 | | | 81513 |
| 1.6 HDi | 66 | 09/05 → | 1.560 | D | M | 4 | 16 | 9HX (DV6ATED4) | | 81869 |
| | 80 | 05/04 → | 1.560 | D | M | 4 | 16 | 9HY (DV6TED4), 9HZ (DV6TED4) | | 81869 |
| 1.6 i | 65 | 04/97 → 09/00 | 1.587 | B | M | 4 | 8 | NFZ (TU5JP) | 07-1997 → | 81513 |
| | 65 | 02/98 → 09/00 | 1.587 | B | M | 4 | 8 | NFZ (TU5JP) | | 81513 |

KW

cm³

NO. OF VALVES

MAGNETI MARELLI
CITROËN
Xsara, Break, Coupé, Picasso, Van

| | | | | | | | | | | | |
|------------------|-----|---------------|-------|---|----|---|----|----------------------------|-----------|-------|------------|
| 1.8 16V | 85 | 02/00 → | 1.749 | B | M | 4 | 16 | 6FZ (EW7J4) | (-)COP | 84038 | NEW |
| | 85 | 02/00 → | 1.749 | B | M | 4 | 16 | 6FZ (EW7J4) | (+)COP | 82089 | |
| | 85 | 02/00 → | 1.749 | B | M | 4 | 16 | 6FZ (EW7J4) | | 82089 | |
| | 85 | 02/00 → | 1.749 | B | M | 4 | 16 | 6FZ (EW7J4) | | 81799 | |
| 1.8 D | 43 | 04/97 → 09/00 | 1.769 | D | M | 4 | 8 | 161A (XUD7), A9A (XUD7) | | 81642 | |
| | 43 | 10/97 → 09/00 | 1.769 | D | M | 4 | 8 | A9A (XUD7) | | 81642 | |
| 1.8 i | 66 | 04/97 → 09/00 | 1.761 | B | M | 4 | 8 | LFX (XU7JB) | | 81512 | |
| | 66 | 10/97 → 09/00 | 1.761 | B | M | 4 | 8 | LFX (XU7JB) | 07-1997 → | 81512 | |
| | 74 | 02/98 → 09/00 | 1.761 | B | M | 4 | 8 | LFZ (XU7JP) | | 81512 | |
| 1.8 i 16V | 81 | 04/97 → 09/00 | 1.761 | B | M | 4 | 16 | LFY (XU7JP4) | 07-1997 → | 81710 | |
| | 81 | 10/97 → 09/00 | 1.761 | B | M | 4 | 16 | LFY (XU7JP4) | | 81710 | |
| 1.8 i Aut. | 74 | 04/97 → 09/00 | 1.761 | B | A | 4 | 8 | LFZ (XU7JP) | 07-1997 → | 81512 | |
| 1.8 LPG | 81 | 05/98 → 08/00 | 1.761 | | M | 4 | 16 | LFY (XU7JP4) | | 81710 | |
| 1.8 SX | 76 | 06/00 → 08/05 | 1.761 | B | M | 4 | 8 | | | 81512 | |
| 1.8 TD | 66 | 10/97 → 09/00 | 1.761 | D | M | 4 | 8 | | | 81642 | |
| 1.8 VTS | 85 | 09/00 → 10/04 | 1.749 | B | M | 4 | 16 | 6FZ (EW7J4) | (-)COP | 84038 | NEW |
| | 85 | 09/00 → 10/04 | 1.749 | B | M | 4 | 16 | 6FZ (EW7J4) | (+)COP | 82089 | |
| | 85 | 09/00 → 10/04 | 1.749 | B | M | 4 | 16 | 6FZ (EW7J4) | | 82089 | |
| | 85 | 09/00 → 10/04 | 1.749 | B | M | 4 | 16 | 6FZ (EW7J4) | | 81799 | |
| 1.9 D | 51 | 07/98 → 03/05 | 1.868 | D | M | 4 | 8 | WJY (DW8B), WJZ (DW8) | | 81713 | |
| | 50 | 04/97 → 09/00 | 1.905 | D | M | 4 | 8 | DJY (XUD9A) | | 81642 | |
| | 55 | 01/98 → 09/00 | 1.905 | D | M | 4 | 8 | DHV (XUD9BSD) | | 81642 | |
| 1.9 SD | 55 | 01/98 → 09/00 | 1.905 | D | M | 4 | 8 | DHV (XUD9BSD) | | 81642 | |
| 1.9 TD | 66 | 04/97 → 09/00 | 1.905 | D | M | 4 | 8 | DHY (XUD9TE/Y) | | 81642 | |
| 2.0 16V | 100 | 09/00 → 03/05 | 1.997 | B | M | 4 | 16 | RFN (EW10J4) | (-)COP | 84038 | NEW |
| | 100 | 09/00 → 03/05 | 1.997 | B | M | 4 | 16 | RFN (EW10J4) | (+)COP | 82089 | |
| | 100 | 09/00 → 03/05 | 1.997 | B | M | 4 | 16 | RFN (EW10J4) | | 82089 | |
| | 100 | 09/00 → 03/05 | 1.997 | B | M | 4 | 16 | RFN (EW10J4) | | 81799 | |
| | 97 | 07/98 → 09/00 | 1.998 | B | M | 4 | 16 | RFV (XU10J4R) | | 81711 | |
| | 120 | 04/97 → 09/00 | 1.998 | B | M | 4 | 16 | RFS (XU10J4RS) | 01-1998 → | 81711 | |
| 2.0 HDi | 66 | 09/00 → 03/05 | 1.997 | D | M | 4 | 8 | RHY (DW10TD) | | 81713 | |
| 2.0 HDi 109 | 80 | 05/01 → 03/05 | 1.997 | D | AM | 4 | 8 | RHZ (DW10ATED) | | 81713 | |
| 2.0 HDi 90 | 66 | 02/99 → 03/05 | 1.997 | D | M | 4 | 8 | RHY (DW10TD) | | 81713 | |
| 2.0 i 16V | 120 | 02/98 → 03/05 | 1.998 | B | M | 4 | 16 | RFS (XU10J4RS) | | 81711 | |
| ZX, Break | | | | | | | | | | | |
| 1,1 | 40 | 03/91 → 08/93 | 1.124 | B | M | 4 | 8 | H1A, H1B | | 81556 | |
| | 44 | 03/91 → 06/97 | 1.124 | B | M | 4 | 8 | HDZ (TU1M) | | 81556 | |
| 1.4 | 55 | 03/91 → 06/97 | 1.360 | B | M | 4 | 8 | KDZ (TU3M/Z) | | 81556 | |
| 1.4 D | 37 | 07/94 → 10/97 | 1.360 | D | M | 4 | 8 | K9Y (TUD3Y) | | 81556 | |

KW

cm³

NO. OF VALVES

CITROËN
ZX, Break

| | | | | | | | | | | |
|-----------|-----|---------------|-------|---|---|---|----|---|-----------------------------|-------|
| 1.4 i | 55 | 10/93 → 10/97 | 1.360 | B | M | 4 | 8 | KDX (TU3M/Z), KDY (TU3M), KFX (TU3JP) | 07-1994 →, → 07-1995 | 81556 |
| | 55 | 03/91 → 06/97 | 1.360 | B | M | 4 | 8 | KDX (TU3M/Z), KDZ (TU3M/Z), KFX (TU3JP) | | 81556 |
| 1.6 i | 65 | 03/91 → 06/97 | 1.580 | B | M | 4 | 8 | BDY (XU5M), BFZ (XU5JP) | → 08-1992, → PROD: 5409 | 81554 |
| | 65 | 03/91 → 06/97 | 1.580 | B | M | 4 | 8 | BDY (XU5M), BFZ (XU5JP) | 09-1992 →, PROD →: 5410 | 81512 |
| | 65 | 10/93 → 10/97 | 1.580 | B | M | 4 | 8 | BDY (XU5M), BFZ (XU5JP) | 09-1992 →, PROD →: 5.410 | 81512 |
| 1.8 D | 44 | 06/93 → 06/97 | 1.769 | D | M | 4 | 8 | 161A (XUD7) | | 81642 |
| 1.8 i | 74 | 07/92 → 06/97 | 1.761 | B | M | 4 | 8 | LFZ (XU7JP) | → PROD: 5409 | 81554 |
| | 74 | 07/92 → 06/97 | 1.761 | B | M | 4 | 8 | LFZ (XU7JP) | PROD →: 5410 | 81512 |
| 1.8 i 16V | 81 | 01/96 → 06/97 | 1.761 | B | M | 4 | 16 | LFY (XU7JP4) | | 81710 |
| 1.9 D | 47 | 03/91 → 06/97 | 1.905 | D | M | 4 | 8 | DJZ (XUD9Y) | → 06-1994, → PROD: 6170 | 81672 |
| | 47 | 03/91 → 06/97 | 1.905 | D | M | 4 | 8 | DJZ (XUD9Y) | 07-1994 →, PROD →: 6171 | 81642 |
| | 50 | 06/94 → 10/97 | 1.905 | D | M | 4 | 8 | D9B (XUD9A/U) | 07-1994 →, PROD →: 6.171 | 81642 |
| | 50 | 07/93 → 06/97 | 1.905 | D | M | 4 | 8 | D9B (XUD9A/U), DJY (XUD9A) | 07-1994 →, PROD →: 6.171 | 81642 |
| 1.9 i | 88 | 03/91 → 06/97 | 1.905 | B | M | 4 | 8 | DKZ (XU9JA) | → 08-1992, → PROD: 5409 | 81554 |
| | 88 | 03/91 → 06/97 | 1.905 | B | M | 4 | 8 | DKZ (XU9JA) | 09-1992 →, PROD →: 5410 | 81512 |
| 1.9 TD | 66 | 07/92 → 06/97 | 1.905 | D | M | 4 | 8 | DHY (XUD9TE/Y) | → 06-1994, → PROD: 6170 | 81672 |
| | 66 | 07/92 → 06/97 | 1.905 | D | M | 4 | 8 | DHY (XUD9TE/Y) | 07-1994 →, PROD →: 6171 | 81642 |
| 2.0 i | 89 | 07/92 → 06/97 | 1.998 | B | M | 4 | 8 | RFX (XU10J2C) | | 81642 |
| 2.0 i 16V | 110 | 06/94 → 06/97 | 1.998 | B | M | 4 | 16 | RFT (XU10J4/Z) | | 81672 |
| | 112 | 07/92 → 10/94 | 1.998 | B | M | 4 | 16 | RFT (XU10J4/Z), RFY (XU10J4/Z) | | 81672 |
| | 120 | 05/96 → 06/97 | 1.998 | B | M | 4 | 16 | RFS (XU10J4RS) | | 81672 |

DACIA
Dokker

| | | | | | | | | | | |
|---------|----|---------|-------|---|---|---|----|----------------|--|-------|
| 1.2 TCe | 85 | 11/12 → | 1.197 | B | M | 4 | 16 | H5F402 | | 84003 |
| 1.5 dCi | 55 | 11/12 → | 1.461 | D | M | 4 | 8 | K9K612 | | 82098 |
| | 66 | 11/12 → | 1.461 | D | M | 4 | 8 | K9K612 | | 82098 |
| 1.6 | 61 | 11/12 → | 1.598 | B | M | 4 | 8 | K7M812, K7M828 | | 84003 |

KW

cm³

NO. OF VALVES

MAGNETI MARELLI
DACIA
Dokker Express

| | | | | | | | | | | |
|-------------|----|---------|-------|---|---|---|----|----------------|--|-------|
| 1.2 TCe 115 | 84 | 12/12 → | 1.198 | B | M | 4 | 16 | H5F402 | | 84003 |
| 1.5 dCi | 55 | 12/12 → | 1.461 | D | M | 4 | 8 | K9K612 | | 82098 |
| | 66 | 12/12 → | 1.461 | D | M | 4 | 8 | K9K612 | | 82098 |
| 1.6 | 61 | 12/12 → | 1.598 | B | M | 4 | 8 | K7M812, K7M828 | | 84003 |

Duster

| | | | | | | | | | | |
|-----------------|----|---------|-------|---|---|---|----|----------------|--|------------------|
| 1.2 TCe 125 | 92 | 10/13 → | 1.197 | B | M | 4 | 16 | H5F404 | | 84003 |
| 1.2 TCe 125 4x4 | 92 | 06/15 → | 1.197 | B | M | 4 | 16 | H5F404 | | 84003 |
| 1.5 dCi | 63 | 04/10 → | 1.461 | D | M | 4 | 8 | K9K796, K9K830 | | 84007 |
| | 66 | 10/10 → | 1.461 | D | M | 4 | 8 | K9K884, K9K892 | | 82098 |
| | 79 | 06/10 → | 1.461 | D | M | 4 | 8 | K9K896 | | 84007 |
| | 80 | 08/13 → | 1.461 | D | M | 4 | 8 | K9K856 | | 82098 |
| 1.5 dCi 4x4 | 66 | 10/10 → | 1.461 | D | M | 4 | 8 | K9K884, K9K894 | | 82098 |
| | 79 | 06/10 → | 1.461 | D | M | 4 | 8 | K9K898 | | 84007 |
| | 80 | 08/13 → | 1.461 | D | M | 4 | 8 | K9K858 | | 82098 |
| 1.6 16V | 77 | 04/10 → | 1.598 | B | M | 4 | 16 | K4M690, K4M696 | | 84039 NEW |
| | 77 | 04/10 → | 1.598 | B | M | 4 | 16 | K4M690, K4M696 | | 81806 |
| 1.6 16V 4x4 | 77 | 06/10 → | 1.598 | B | M | 4 | 16 | K4M606 | | 84039 NEW |
| | 77 | 06/10 → | 1.598 | B | M | 4 | 16 | K4M606 | | 81806 |
| 1.6 16V Hi-Flex | 77 | 08/10 → | 1.598 | | M | 4 | 16 | K4M696 | | 84039 NEW |
| | 77 | 08/10 → | 1.598 | | M | 4 | 16 | K4M696 | | 81806 |
| 1.6 16V LPG | 77 | 04/11 → | 1.598 | | M | 4 | 16 | K4M696 | | 84039 NEW |
| | 77 | 04/11 → | 1.598 | | M | 4 | 16 | K4M696 | | 81806 |

Lodgy

| | | | | | | | | | | |
|---------|----|---------|-------|---|---|---|----|----------------|--|------------------|
| 1.2 TCe | 85 | 03/12 → | 1.197 | B | M | 4 | 16 | H5F402 | | 84003 |
| 1.5 dCi | 66 | 03/12 → | 1.461 | D | M | 4 | 8 | K9K612 | | 82098 |
| | 79 | 01/13 → | 1.461 | D | M | 4 | 8 | K9K846 | | 82098 |
| | 80 | 06/15 → | 1.461 | D | M | 4 | 8 | | | 82098 |
| 1.6 | 61 | 03/12 → | 1.598 | B | M | 4 | 8 | K7M812, K7M828 | | 84003 |
| 1.6 LPG | 61 | 11/13 → | 1.598 | | M | 4 | 8 | K7M812, K7M828 | | 84039 NEW |

Logan

| | | | | | | | | | | |
|---------|----|---------|-------|---|---|---|----|--------|--|------------------|
| 1.2 | 54 | 05/15 → | 1.149 | B | M | 4 | 16 | | | 82090 |
| | 55 | 10/12 → | 1.149 | B | M | 4 | 16 | D4F732 | | 82090 |
| 1.2 LPG | 55 | 10/12 → | 1.149 | | M | 4 | 16 | D4F734 | | 82090 |
| 1.5 dCi | 55 | 10/12 → | 1.461 | D | M | 4 | 8 | K9K612 | | 81810 |
| | 55 | 10/12 → | 1.461 | D | M | 4 | 8 | K9K612 | | 84007 |
| | 63 | 01/13 → | 1.461 | D | M | 4 | 8 | K9K830 | | 81810 |
| | 63 | 01/13 → | 1.461 | D | M | 4 | 8 | K9K830 | | 84007 |
| | 66 | 10/12 → | 1.461 | D | M | 4 | 8 | K9K612 | | 82098 |
| 1.6 16V | 77 | 01/13 → | 1.598 | B | M | 4 | 16 | K4M842 | | 84039 NEW |
| | 77 | 01/13 → | 1.598 | B | M | 4 | 16 | K4M842 | | 81806 |
| TCe 90 | 66 | 10/12 → | 898 | B | M | 3 | 12 | H4B400 | | 84003 |



KW



cm³



NO. OF VALVES



DACIA

Logan MCV

| | | | | | | | | | | |
|-----------------|----|---------|-------|----|---|---|----|----------------|--|------------------|
| 1.2 | 54 | 05/15 → | 1.149 | B | M | 4 | 16 | D4F732 | | 82090 |
| | 55 | 02/13 → | 1.149 | B | M | 4 | 16 | D4F732 | | 82090 |
| 1.2 LPG | 55 | 02/13 → | 1.149 | | M | 4 | 16 | D4F734 | | 82090 |
| 1.4 | 55 | 02/07 → | 1.390 | B | M | 4 | 8 | K7J710 | | 81579 |
| 1.5 dCi | 55 | 02/13 → | 1.461 | D | M | 4 | 8 | K9K612 | | 81810 |
| | 55 | 02/13 → | 1.461 | D | M | 4 | 8 | K9K612 | | 84007 |
| | 63 | 02/13 → | 1.461 | D | M | 4 | 8 | K9K830 | | 81810 |
| | 63 | 02/13 → | 1.461 | D | M | 4 | 8 | K9K830 | | 84007 |
| | 66 | 02/13 → | 1.461 | D | M | 4 | 8 | K9K612 | | 81810 |
| | 66 | 02/13 → | 1.461 | D | M | 4 | 8 | K9K612 | | 84007 |
| | 50 | 02/07 → | 1.461 | D | M | 4 | 8 | K9K792 | | 84007 |
| | 55 | 05/10 → | 1.461 | D | M | 4 | 8 | K9K892 | | 82098 |
| | 63 | 09/07 → | 1.461 | D | M | 4 | 8 | K9K796 | | 84007 |
| 1.6 | 65 | 05/10 → | 1.461 | D | M | 4 | 8 | K9K892 | | 82098 |
| | 64 | 02/07 → | 1.598 | B | M | 4 | 8 | K7M710 | | 81579 |
| 1.6 16V | 77 | 02/07 → | 1.598 | B | M | 4 | 16 | K4M690, K4M696 | | 84039 NEW |
| | 77 | 02/07 → | 1.598 | B | M | 4 | 16 | K4M690, K4M696 | | 81806 |
| 1.6 16V Hi-Flex | 77 | 11/09 → | 1.598 | | M | 4 | 16 | K4M690, K4M694 | | 84039 NEW |
| | 77 | 11/09 → | 1.598 | | M | 4 | 16 | K4M690, K4M694 | | 81806 |
| 1.6 Bifuel | 64 | 11/08 → | 1.598 | BF | M | 4 | 8 | K7M710 | | 81579 |
| 1.6 MPI 85 | 62 | 05/10 → | 1.598 | B | M | 4 | 8 | K7M800 | | 84039 NEW |
| TCe 90 | 66 | 02/13 → | 898 | B | M | 3 | 12 | H4B400 | | 84003 |

Logan, Station Wagon, Van

| | | | | | | | | | | |
|-------------------|----|---------|-------|----|---|---|----|----------------|--|------------------|
| 1.2 16V | 55 | 02/06 → | 1.149 | B | M | 4 | 16 | D4F732 | | 82090 |
| 1.2 16V LPG | 55 | 02/06 → | 1.149 | | M | 4 | 16 | D4F734 | | 82090 |
| 1.4 | 55 | 03/09 → | 1.390 | B | M | 4 | 8 | K7J710 | | 81579 |
| | 55 | 09/04 → | 1.390 | B | M | 4 | 8 | K7J710 | | 81579 |
| 1.4 MPI LPG | 55 | 02/06 → | 1.390 | | M | 4 | 8 | K7J710, K7J714 | | 81579 |
| 1.5 dCi | 55 | 05/10 → | 1.461 | D | M | 4 | 8 | K9K892 | | 82098 |
| | 65 | 05/10 → | 1.461 | D | M | 4 | 8 | K9K892 | | 82098 |
| | 48 | 09/05 → | 1.461 | D | M | 4 | 8 | K9K790 | | 84007 |
| | 50 | 01/06 → | 1.461 | D | M | 4 | 8 | K9K792 | | 84007 |
| | 55 | 05/10 → | 1.461 | D | M | 4 | 8 | K9K892 | | 82098 |
| | 63 | 09/07 → | 1.461 | D | M | 4 | 8 | K9K796 | | 84007 |
| | 65 | 05/10 → | 1.461 | D | M | 4 | 8 | K9K892 | | 82098 |
| 1.6 | 64 | 03/09 → | 1.598 | B | M | 4 | 8 | K7M710 | | 81579 |
| | 64 | 09/04 → | 1.598 | B | M | 4 | 8 | K7M710 | | 81579 |
| 1.6 16V | 77 | 02/06 → | 1.598 | B | M | 4 | 16 | K4M690, K4M696 | | 84039 NEW |
| | 77 | 02/06 → | 1.598 | B | M | 4 | 16 | K4M690, K4M696 | | 81806 |
| 1.6 16V Flexifuel | 77 | 07/10 → | 1.598 | | M | 4 | 16 | K4M696 | | 84039 NEW |
| | 77 | 07/10 → | 1.598 | | M | 4 | 16 | K4M696 | | 81806 |
| 1.6 Bifuel | 62 | 05/10 → | 1.598 | BF | M | 4 | 8 | K7M718 | | 81579 |
| | 62 | 05/10 → | 1.598 | BF | M | 4 | 8 | K7M800 | | 84039 NEW |
| 1.6 MPI 85 | 62 | 05/10 → | 1.598 | B | M | 4 | 8 | K7M800 | | 84039 NEW |

KW

cm³

NO. OF VALVES

MAGNETI MARELLI
DACIA
Sandero I

| | | | | | | | | | | |
|----------------|----|---------|-------|----|---|---|----|------------------------|--|------------------|
| 1.2 16V | 55 | 11/08 → | 1.149 | B | M | 4 | 16 | D4F732 | | 81820 |
| 1.2 16V LPG | 55 | 11/08 → | 1.149 | | M | 4 | 16 | D4F732 | | 82090 |
| 1.4 | 55 | 06/08 → | 1.390 | B | M | 4 | 8 | K7J710 | | 81579 |
| 1.4 MPI LPG | 53 | 01/09 → | 1.390 | | M | 4 | 8 | K7J714 | | 81579 |
| 1.5 dCi | 50 | 11/08 → | 1.461 | D | M | 4 | 8 | K9K792 | | 84007 |
| | 55 | 05/10 → | 1.461 | D | M | 4 | 8 | K9K892 | | 82098 |
| | 63 | 11/08 → | 1.461 | D | M | 4 | 8 | K9K796 | | 84007 |
| | 65 | 05/10 → | 1.461 | D | M | 4 | 8 | K9K892 | | 82098 |
| 1.6 | 64 | 06/08 → | 1.598 | B | M | 4 | 8 | K7M710 | | 81579 |
| 1.6 16V | 77 | 07/11 → | 1.598 | B | M | 4 | 16 | K4M690 | | 84039 NEW |
| | 77 | 07/11 → | 1.598 | B | M | 4 | 16 | K4M690 | | 81806 |
| 1.6 16V Bifuel | 77 | 01/11 → | 1.598 | BF | M | 4 | 16 | K4M690, K4M694, K4M696 | | 84039 NEW |
| | 77 | 01/11 → | 1.598 | BF | M | 4 | 16 | K4M690, K4M694, K4M696 | | 81806 |
| 1.6 MPI 85 | 62 | 05/10 → | 1.598 | B | M | 4 | 8 | K7M800 | | 84039 NEW |

Sandero II

| | | | | | | | | | | |
|---------|----|---------|-------|---|---|---|----|----------------|--|------------------|
| 1.2 | 54 | 05/15 → | 1.149 | B | M | 4 | 16 | D4F732 | | 82090 |
| | 55 | 10/12 → | 1.149 | B | M | 4 | 16 | D4F732 | | 82090 |
| 1.2 LPG | 55 | 10/12 → | 1.149 | | M | 4 | 16 | D4F732 | | 82090 |
| 1.5 dCi | 55 | 10/12 → | 1.461 | D | M | 4 | 8 | K9K612 | | 81810 |
| | 55 | 10/12 → | 1.461 | D | M | 4 | 8 | K9K612 | | 84007 |
| | 63 | 01/13 → | 1.461 | D | M | 4 | 8 | K9K830 | | 84007 |
| | 66 | 10/12 → | 1.461 | D | M | 4 | 8 | K9K612 | | 81810 |
| | 66 | 10/12 → | 1.461 | D | M | 4 | 8 | K9K612 | | 84007 |
| 1.6 | 61 | 11/12 → | 1.598 | B | M | 4 | 8 | K7M812 | | 84039 NEW |
| | 61 | 11/12 → | 1.598 | B | M | 4 | 8 | K7M812 | | 81806 |
| 1.6 16V | 77 | 01/13 → | 1.598 | B | M | 4 | 16 | K4M842, K4M845 | | 84039 NEW |
| | 77 | 01/13 → | 1.598 | B | M | 4 | 16 | K4M842, K4M845 | | 81806 |
| TCe 90 | 66 | 10/12 → | 898 | B | M | 3 | 12 | H4B400 | | 84003 |

Solenza

| | | | | | | | | | | |
|-------|----|---------|-------|---|---|---|---|--------|--|-------|
| 1.4 | 55 | 02/03 → | 1.390 | B | M | 4 | 8 | K7J710 | | 81578 |
| 1.9 D | 46 | 02/03 → | 1.870 | D | M | 4 | 8 | F8Q630 | | 81574 |

DAEWOO
Cielo

| | | | | | | | | | | |
|-----|----|---------------|-------|---|---|---|----|------|--|-------|
| 1.5 | 66 | 06/94 → 07/98 | 1.498 | B | M | 4 | 16 | V15L | | 81549 |
|-----|----|---------------|-------|---|---|---|----|------|--|-------|

Espero

| | | | | | | | | | | |
|---------|----|---------------|-------|---|---|---|----|-------|-----------|-------|
| 1.5 16V | 65 | 10/93 → 09/94 | 1.498 | B | M | 4 | 16 | A15MF | | 81780 |
| | 66 | 02/95 → 06/99 | 1.498 | B | M | 4 | 16 | A15MF | | 81780 |
| 1.8 | 66 | 02/95 → 09/99 | 1.796 | B | M | 4 | 8 | C18LE | → 10-1995 | 81606 |
| | 70 | 02/95 → 06/99 | 1.796 | B | M | 4 | 8 | C18LE | → 10-1995 | 81606 |

KW

cm³

NO. OF VALVES

DAEWOO
Espero

| | | | | | | | | | | |
|-----|----|---------------|-------|---|---|---|---|-------|-----------|-------|
| 2.0 | 74 | 10/91 → 09/93 | 1.998 | B | M | 4 | 8 | C20LZ | | 81606 |
| | 77 | 02/95 → 06/99 | 1.998 | B | M | 4 | 8 | C20LE | → 10-1995 | 81606 |
| | 81 | 10/93 → 09/94 | 1.998 | B | M | 4 | 8 | C20LE | | 81606 |

Evanda

| | | | | | | | | | | |
|-----|----|---------|-------|---|---|---|----|-------------|--|-------|
| 2.0 | 96 | 08/02 → | 1.998 | B | M | 4 | 16 | L88, X20SED | | 81550 |
|-----|----|---------|-------|---|---|---|----|-------------|--|-------|

Kalos

| | | | | | | | | | | |
|---------|----|---------------|-------|---|---|---|----|--------------|--|-------|
| 1.2 | 53 | 04/03 → | 1.150 | B | M | 4 | 8 | B12S1, F12S3 | | 81781 |
| 1.4 | 61 | 09/02 → | 1.399 | B | M | 4 | 8 | F14S3 | | 81781 |
| | 69 | 05/03 → 12/04 | 1.399 | B | M | 4 | 16 | F14D3 | | 81782 |
| 1.4 16V | 69 | 04/03 → | 1.399 | B | M | 4 | 16 | F14D3 | | 81782 |
| 1.5 | 62 | 11/02 → 12/04 | 1.498 | B | M | 4 | 8 | F15S | | 81781 |

Korando, Cabrio

| | | | | | | | | | | |
|---------|-----|---------|-------|---|---|---|----|--------------|--|-------|
| 2.3 | 105 | 01/99 → | 2.295 | B | M | 4 | 16 | M161.970 | | 81509 |
| 2.9 D | 72 | 01/99 → | 2.874 | D | M | 5 | 10 | MB-OM662 | | 81506 |
| 2.9 TD | 88 | 01/99 → | 2.874 | D | M | 5 | 10 | MB-OM60129TD | | 81506 |
| 3.2 4x4 | 156 | 01/99 → | 3.199 | B | M | 6 | 24 | M104.995 | | 81722 |

Lacetti II

| | | | | | | | | | | |
|-----|----|---------------|-------|---|---|---|----|--------|--|-------|
| 1.6 | 78 | 06/99 → 07/03 | 1.598 | B | M | 4 | 16 | A16DMS | | 81782 |
|-----|----|---------------|-------|---|---|---|----|--------|--|-------|

Lacetti III, Hatchback

| | | | | | | | | | | |
|---------|----|---------------|-------|---|---|---|----|--------|--|-------|
| 1.4 | 70 | 02/04 → | 1.399 | B | M | 4 | 16 | F14D3 | | 81782 |
| 1.6 | 80 | 02/04 → | 1.598 | B | M | 4 | 16 | F16D3 | | 81782 |
| 1.8 | 90 | 02/04 → | 1.799 | B | M | 4 | 16 | T18SED | | 81550 |
| 1.8 CDX | 90 | 08/03 → 12/04 | 1.799 | B | M | 4 | 16 | T18SED | | 81550 |

Lanos

| | | | | | | | | | | |
|---------|----|---------|-------|---|---|---|----|--------|-----------|-------|
| 1.4 | 55 | 05/97 → | 1.349 | B | M | 4 | 8 | A14SMS | | 81781 |
| 1.5 | 63 | 05/97 → | 1.498 | B | M | 4 | 8 | A15SMS | 01-1997 → | 81781 |
| | 63 | 05/97 → | 1.498 | B | M | 4 | 8 | A15SMS | | 81781 |
| 1.6 16V | 78 | 05/97 → | 1.598 | B | M | 4 | 16 | A16DMS | | 81780 |

Leganza

| | | | | | | | | | | |
|---------|-----|---------------|-------|---|---|---|----|--------|--|-------|
| 2.0 16V | 93 | 07/00 → 04/04 | 1.998 | B | M | 4 | 16 | T20SED | | 81550 |
| | 98 | 06/97 → 12/02 | 1.998 | B | M | 4 | 16 | X20SED | | 81550 |
| 2.2 16V | 100 | 04/99 → 12/02 | 2.198 | B | M | 4 | 16 | T22SED | | 81550 |

Magnus

| | | | | | | | | | | |
|-----|----|---------|-------|---|---|---|----|--------|--|-------|
| 2.0 | 96 | 07/99 → | 1.998 | B | M | 4 | 16 | X20SED | | 81550 |
|-----|----|---------|-------|---|---|---|----|--------|--|-------|

Matiz

| | | | | | | | | | | |
|-----|----|---------|-----|---|---|---|---|------|--|-------|
| 0.8 | 38 | 09/98 → | 796 | B | M | 3 | 6 | F8CV | | 81783 |
| 1.0 | 47 | 01/03 → | 995 | B | M | 4 | 8 | B10S | | 81783 |

Musso

| | | | | | | | | | | |
|------------|-----|---------------|-------|---|---|---|----|--------------|--|-------|
| 2.2 TD | 74 | 09/99 → | 2.299 | D | M | 4 | 8 | MBOM601 | | 81506 |
| 2.3 | 103 | 01/99 → | 2.295 | B | M | 4 | 16 | M111.970 | | 81509 |
| 2.9 D 4x4 | 73 | 01/99 → 09/99 | 2.874 | D | M | 5 | 10 | MB-OM662 | | 81506 |
| 2.9 TD 4x4 | 88 | 01/99 → | 2.874 | D | M | 5 | 10 | MB-OM60129TD | | 81506 |
| 3.2 4x4 | 162 | 01/99 → | 3.199 | B | M | 6 | 24 | M104.992 | | 81722 |

KW

cm³

NO. OF VALVES

DAEWOO
Nexia I

| | | | | | | | | | | |
|---------|----|---------------|-------|---|---|---|----|-------|--|-------|
| 1.5 | 44 | 08/96 → 08/97 | 1.498 | B | M | 4 | 8 | G15MF | | 81549 |
| | 52 | 02/95 → 08/97 | 1.498 | B | M | 4 | 8 | G15MF | | 81549 |
| | 55 | 02/95 → 08/97 | 1.498 | B | M | 4 | 8 | G15MF | | 81549 |
| 1.5 16V | 66 | 02/95 → 08/97 | 1.498 | B | M | 4 | 16 | A15MF | | 81780 |

Nubira I, Station Wagon

| | | | | | | | | | | |
|---------|----|---------------|-------|---|---|---|----|--------------|--|-------|
| 1.6 | 76 | 08/02 → 07/03 | 1.598 | B | M | 4 | 16 | A16DMS | | 81782 |
| 1.6 16V | 66 | 06/97 → | 1.598 | B | M | 4 | 16 | A16SMS | | 81782 |
| | 76 | 07/00 → | 1.598 | B | M | 4 | 16 | A16DMS | | 81782 |
| | 78 | 05/97 → | 1.598 | B | M | 4 | 16 | A16DMS | | 81782 |
| 2.0 | 81 | 06/99 → 07/03 | 1.998 | B | M | 4 | 16 | C20SED | | 81550 |
| 2.0 16V | 93 | 12/00 → | 1.998 | B | M | 4 | 16 | T20SED | | 81550 |
| | 98 | 05/97 → | 1.998 | B | M | 4 | 16 | X20SED | | 81550 |
| | 98 | 05/97 → | 1.998 | B | M | 4 | 16 | X20SED, Z20L | | 81550 |

Nubira II, Station Wagon

| | | | | | | | | | | |
|-----|----|---------------|-------|---|---|---|----|--------|--|-------|
| 1.4 | 69 | 10/03 → 12/04 | 1.399 | B | M | 4 | 16 | F14D3 | | 81782 |
| 1.6 | 80 | 07/03 → | 1.598 | B | M | 4 | 16 | F16D3 | | 81782 |
| 1.8 | 90 | 07/03 → | 1.799 | B | M | 4 | 16 | T18SED | | 81782 |

Rezzo

| | | | | | | | | | | |
|--------|----|---------------|-------|---|---|---|----|--------|--|-------|
| 1.6 | 77 | 09/00 → | 1.598 | B | M | 4 | 16 | A16DMS | | 81782 |
| 1.6 SX | 66 | 08/01 → 12/04 | 1.598 | B | M | 4 | 16 | A16SMS | | 81782 |
| 2.0 | 89 | 09/01 → | 1.998 | B | M | 4 | 16 | X20SED | | 81550 |
| | 94 | 09/00 → | 1.998 | B | M | 4 | 16 | T20SED | | 81550 |

Tico II

| | | | | | | | | | | |
|-----|----|---------------|-----|---|---|---|---|------|--|-------|
| 0.8 | 35 | 02/95 → 12/00 | 796 | B | M | 3 | 6 | F8C | | 81783 |
| | 38 | 01/96 → 12/00 | 796 | B | M | 3 | 6 | F8CV | | 81783 |

Tosca

| | | | | | | | | | | |
|----------|-----|---------|-------|---|---|---|----|--------|--|------------------|
| 2.0 TDCi | 110 | 02/06 → | 1.991 | D | M | 4 | 16 | Z20DMH | | 84014 NEW |
|----------|-----|---------|-------|---|---|---|----|--------|--|------------------|

DAIHATSU
Applause I

| | | | | | | | | | | |
|-------------|----|---------------|-------|---|---|---|----|------|--|-------|
| 1.6 16V | 66 | 06/89 → 07/97 | 1.590 | B | M | 4 | 16 | HD | | 81714 |
| | 77 | 06/89 → 07/97 | 1.590 | B | M | 4 | 16 | HD-E | | 81714 |
| 1.6 16V 4WD | 77 | 06/89 → 07/97 | 1.590 | B | M | 4 | 16 | HD-E | | 81714 |

Applause II

| | | | | | | | | | | |
|---------|----|---------------|-------|---|---|---|----|------|--|-------|
| 1.6 16V | 73 | 07/97 → 05/00 | 1.590 | B | M | 4 | 16 | HD-E | | 81714 |
|---------|----|---------------|-------|---|---|---|----|------|--|-------|

Charade III

| | | | | | | | | | | |
|-----------|----|---------------|-------|---|---|---|----|------|--|-------|
| 1.3 | 56 | 09/88 → 01/92 | 1.295 | B | M | 4 | 16 | HC-C | | 81714 |
| | 66 | 11/90 → 02/93 | 1.296 | B | M | 4 | 16 | HCE | | 81714 |
| 1.3 i | 66 | 06/88 → 12/92 | 1.296 | B | M | 4 | 16 | HCE | | 81714 |
| 1.3 i 4WD | 66 | 06/88 → 01/93 | 1.296 | B | M | 4 | 16 | HCE | | 81714 |

KW

cm³

NO. OF VALVES

DAIHATSU
Charade IV

| | | | | | | | | | | |
|-----------|----|---------------|-------|---|---|---|----|-----------|--|-------|
| 1.0 | 38 | 09/94 → 03/96 | 993 | B | M | 3 | 6 | CB22 | | 81714 |
| 1.3 | 44 | 09/96 → 11/99 | 1.296 | B | M | 4 | 16 | HC | | 81714 |
| 1.3 16V | 55 | 05/96 → 11/99 | 1.296 | B | M | 4 | 16 | HCE | | 81714 |
| 1.3 i 16V | 62 | 01/93 → 09/00 | 1.296 | B | M | 4 | 16 | HC, HCE | | 81714 |
| 1.5 16V | 55 | 10/94 → | 1.499 | B | M | 4 | 16 | HEE | | 81714 |
| 1.5 HG | 55 | 06/94 → 03/96 | 1.499 | B | M | 4 | 16 | HEE, HEEG | | 81714 |
| 1.5 i 16V | 66 | 08/94 → | 1.499 | B | M | 4 | 16 | HEE | | 81714 |
| | 66 | 01/97 → 11/99 | 1.499 | B | M | 4 | 16 | HEE, HEEG | | 81714 |
| 1.6 GTi | 77 | 03/93 → 11/99 | 1.590 | B | M | 4 | 16 | HD-E | | 81714 |

Charade VI

| | | | | | | | | | | |
|----------|----|---------|-------|---|---|---|----|--------|--|------------------|
| 1.33 16V | 73 | 05/11 → | 1.329 | B | M | 4 | 16 | 1NR-FE | | 84032 NEW |
|----------|----|---------|-------|---|---|---|----|--------|--|------------------|

Copen

| | | | | | | | | | | |
|-----|----|---------------|-------|---|---|---|----|-------|-----------------|-------|
| 1.3 | 64 | 03/06 → 09/12 | 1.298 | B | M | 4 | 16 | K3-VE | Flange: 3 holes | 81808 |
|-----|----|---------------|-------|---|---|---|----|-------|-----------------|-------|

Cuore XIII

| | | | | | | | | | | |
|-----|----|---------|-----|---|---|---|----|--------|--|-------|
| 1.0 | 51 | 04/07 → | 998 | B | M | 3 | 12 | 1KR-FE | | 82063 |
|-----|----|---------|-----|---|---|---|----|--------|--|-------|

Feroza Soft Top, Hard Top

| | | | | | | | | | | |
|---------------|----|---------------|-------|---|---|---|----|------|--|-------|
| 1.6 16V | 63 | 10/88 → 12/99 | 1.590 | B | M | 4 | 16 | HDC | | 81715 |
| 1.6 i 16V | 70 | 10/88 → 12/99 | 1.590 | B | M | 4 | 16 | HD-E | | 81715 |
| 1.6 i 16V 4x4 | 70 | 10/88 → 12/99 | 1.590 | B | M | 4 | 16 | HD-E | | 81715 |

Gran Move

| | | | | | | | | | | |
|---------|----|---------------|-------|---|---|---|----|------|--|-------|
| 1.5 16V | 66 | 10/96 → 07/98 | 1.499 | B | M | 4 | 16 | HEEG | | 81714 |
| 1.6 16V | 67 | 05/98 → | 1.590 | B | M | 4 | 16 | HDEP | | 81714 |
| 1.6 GLX | 77 | 06/98 → 07/02 | 1.589 | B | M | 4 | 16 | HDEP | | 81714 |
| 1.6 GX | 67 | 06/98 → 07/02 | 1.589 | B | M | 4 | 16 | HDEP | | 81714 |

Hijet IV

| | | | | | | | | | | |
|-----------|----|---------|-------|---|---|---|----|-----|--|-------|
| 1.3 i 16V | 48 | 05/98 → | 1.295 | B | M | 4 | 16 | HCE | | 81714 |
|-----------|----|---------|-------|---|---|---|----|-----|--|-------|

Materia

| | | | | | | | | | | |
|----------------|----|---------|-------|---|---|---|----|--------|-----------------|-------|
| 1.3 | 67 | 10/06 → | 1.298 | B | M | 4 | 16 | K3-VE | Flange: 3 holes | 81808 |
| 1.3 DVVT Turbo | 95 | 10/06 → | 1.298 | B | M | 4 | 16 | K3-VET | Flange: 3 holes | 81808 |
| 1.5 | 76 | 10/06 → | 1.495 | B | M | 4 | 16 | 3SZ-VE | Flange: 3 holes | 81808 |
| 1.5 ECO 4WD | 76 | 10/06 → | 1.495 | B | M | 4 | 16 | 3SZ-VE | Flange: 3 holes | 81808 |

Rocky Soft Top, Hard Top

| | | | | | | | | | | |
|--------|----|---------------|-------|---|---|---|---|-----------|--|-------|
| 2.8 TD | 67 | 12/87 → 04/93 | 2.765 | D | M | 4 | 8 | DL51 | | 81714 |
| | 75 | 09/91 → 12/98 | 2.765 | D | M | 4 | 8 | DL52, DLT | | 81714 |

Sirion I

| | | | | | | | | | | |
|---------------|----|---------------|-------|---|----|---|----|--------|-----------------|-------|
| 1.3 Sport | 75 | 08/00 → 01/05 | 1.298 | B | AM | 4 | 16 | K3-VE2 | Flange: 3 holes | 81808 |
| 1.3 Sport 4WD | 75 | 08/00 → 03/05 | 1.298 | B | M | 4 | 16 | K3-VE2 | Flange: 3 holes | 81808 |

Sirion II

| | | | | | | | | | | |
|--------------|----|---------|-------|---|---|---|----|--------|-----------------|-------|
| 1.0 | 51 | 01/05 → | 998 | B | M | 3 | 12 | 1KR-FE | | 82063 |
| 1.0 DVVT 4WD | 51 | 04/05 → | 998 | B | M | 3 | 12 | 1KR-FE | | 82063 |
| 1.3 | 64 | 01/05 → | 1.298 | B | M | 4 | 16 | K3-VE | Flange: 3 holes | 81808 |
| | 67 | 03/08 → | 1.298 | B | M | 4 | 16 | K3-VE | Flange: 3 holes | 81808 |
| 1.3 4WD | 64 | 04/05 → | 1.298 | B | M | 4 | 16 | K3-VE | Flange: 3 holes | 81808 |
| | 67 | 03/08 → | 1.298 | B | M | 4 | 16 | K3-VE | Flange: 3 holes | 81808 |

KW

cm³

NO. OF VALVES

DAIHATSU

Sirion II

| | | | | | | | | | | |
|---------|----|---------------|-------|---|---|---|----|--------|-----------------|-------|
| 1.5 | 76 | 03/08 → | 1.495 | B | M | 4 | 16 | 3SZ-VE | Flange: 3 holes | 81808 |
| 1.5 4WD | 76 | 05/06 → 10/08 | 1.495 | B | M | 4 | 16 | 3SZ-VE | Flange: 3 holes | 81808 |

Storia

| | | | | | | | | | | |
|-----|----|---------|-----|---|---|---|----|--------|--|-------|
| 1.0 | 51 | 04/05 → | 998 | B | M | 3 | 12 | 1KR-FE | | 82063 |
|-----|----|---------|-----|---|---|---|----|--------|--|-------|

Terios I

| | | | | | | | | | | |
|---------|----|---------------|-------|---|---|---|----|-------|--|-------|
| 1.3 4WD | 61 | 10/97 → 10/00 | 1.296 | B | M | 4 | 16 | HC-EJ | | 81715 |
|---------|----|---------------|-------|---|---|---|----|-------|--|-------|

Terios II

| | | | | | | | | | | |
|---------------|----|---------|-------|---|---|---|----|--------|-----------------|-------|
| 1.3 VVT-i | 63 | 11/05 → | 1.298 | B | M | 4 | 16 | K3-VE | Flange: 3 holes | 81808 |
| 1.3 VVT-i 4x4 | 63 | 11/05 → | 1.298 | B | M | 4 | 16 | K3-VE | Flange: 3 holes | 81808 |
| 1.5 4x4 | 77 | 05/06 → | 1.495 | B | M | 4 | 16 | 3SZ-VE | Flange: 3 holes | 81808 |
| 1.5 VVT-i | 75 | 09/10 → | 1.495 | B | M | 4 | 16 | 3SZ-VE | Flange: 3 holes | 81808 |
| | 77 | 11/05 → | 1.495 | B | M | 4 | 16 | 3SZ-VE | Flange: 3 holes | 81808 |
| 1.5 VVT-i 4x4 | 75 | 09/10 → | 1.495 | B | M | 4 | 16 | | Flange: 3 holes | 81808 |

YRV

| | | | | | | | | | | |
|---------|----|---------|-------|---|----|---|----|--------|-----------------|-------|
| 1.3 | 64 | 02/01 → | 1.298 | B | AM | 4 | 16 | K3-VE | Flange: 3 holes | 81808 |
| 1.3 4WD | 64 | 02/01 → | 1.298 | B | AM | 4 | 16 | K3-VE | Flange: 3 holes | 81808 |
| 1.3 GTi | 95 | 07/02 → | 1.298 | B | A | 4 | 16 | K3-VET | Flange: 3 holes | 81808 |

DODGE

Avenger

| | | | | | | | | | | |
|---------|-----|---------|-------|---|---|---|----|-----|--|------------------|
| 2.0 CRD | 103 | 06/07 → | 1.968 | D | M | 4 | 16 | ECD | | 81816 |
| | 103 | 06/07 → | 1.968 | D | M | 4 | 16 | ECD | | 84011 NEW |

Caliber

| | | | | | | | | | | |
|---------|-----|---------|-------|---|---|---|----|----------|--|------------------|
| 2.0 CRD | 103 | 06/06 → | 1.968 | D | M | 4 | 16 | ECD, ECE | | 81816 |
| | 103 | 06/06 → | 1.968 | D | M | 4 | 16 | ECD, ECE | | 84011 NEW |

Journey

| | | | | | | | | | | |
|---------|-----|---------|-------|---|---|---|----|-----|--|------------------|
| 2.0 CRD | 103 | 06/08 → | 1.968 | D | M | 4 | 16 | ECE | | 81816 |
| | 103 | 06/08 → | 1.968 | D | M | 4 | 16 | ECE | | 84011 NEW |

DS

DS 3

| | | | | | | | | | | |
|-----------------|-----|---------|-------|---|---|---|----|--|--|------------------|
| 1.2 VTi 110 | 81 | 04/15 → | 1.199 | B | M | 3 | 12 | | | 84066 NEW |
| 1.2 VTi 82 | 60 | 04/15 → | 1.199 | B | M | 3 | 12 | | | 84066 NEW |
| 1.6 BlueHDi 100 | 73 | 04/15 → | 1.560 | D | M | 4 | 8 | | | 81869 |
| 1.6 BlueHDi 120 | 88 | 07/15 → | 1.560 | D | M | 4 | 8 | | | 81869 |
| 1.6 THP 165 | 121 | 07/15 → | 1.598 | B | M | 4 | 16 | | | 82032 |

DS 4 / DS 4 CROSSBACK

| | | | | | | | | | | |
|-----------------|-----|---------|-------|---|---|---|----|--|--|------------------|
| 1.2 VTi | 96 | 07/15 → | 1.199 | B | M | 3 | 12 | | | 84066 NEW |
| 1.6 BlueHDi 120 | 88 | 07/15 → | 1.560 | D | M | 4 | 8 | | | 81869 |
| 1.6 THP 165 | 121 | 07/15 → | 1.598 | B | M | 4 | 16 | | | 82032 |
| 2.0 BlueHDi 150 | 110 | 07/15 → | 1.997 | D | M | 4 | 16 | | | 82068 |
| 2.0 BlueHDi 180 | 133 | 07/15 → | 1.997 | D | M | 4 | 16 | | | 82068 |

| | | | | | | | | | | |
|--|--|--|--|--|--|--|--|--|--|--|
| | | | | | | | | | | |
|--|--|--|--|--|--|--|--|--|--|--|

DS

DS5

| | | | | | | | | | | |
|-------------------------|-----|---------|-------|---|---|---|----|--|--|-------|
| 1.6 THP 210 | 155 | 04/15 → | 1.598 | B | M | 4 | 16 | | | 82032 |
| 2.0 BlueHDi 150 | 110 | 04/15 → | 1.997 | D | M | 4 | 16 | | | 82068 |
| 2.0 BlueHDi 180 | 133 | 04/15 → | 1.997 | D | M | 4 | 16 | | | 82068 |
| 2.0 HDi 165 Hybrid4 4x4 | 120 | 04/15 → | 1.997 | | M | 4 | 16 | | | 84020 |

FIAT

500 II, 500C

| | | | | | | | | | | |
|----------------|----|---------|-------|---|---|---|----|----------------------|----------|-------|
| 0.9 | 59 | 12/13 → | 875 | B | M | 2 | 8 | 312A5.000 | | 84008 |
| | 63 | 07/10 → | 875 | B | M | 2 | 8 | 312A2.000 | | 84008 |
| | 77 | 10/13 → | 875 | B | M | 2 | 8 | 199B6.000 | | 84008 |
| | 44 | 12/13 → | 964 | B | M | 2 | 8 | 312A4.000, 312A6.000 | | 84008 |
| | 48 | 09/12 → | 964 | B | M | 2 | 8 | 312A4.000 | | 84008 |
| 1.2 | 51 | 10/07 → | 1.242 | B | M | 4 | 8 | 169A4.000 | PIERBURG | 81369 |
| | 51 | 10/07 → | 1.242 | B | M | 4 | 8 | 169A4.000 | TESMA | 82070 |
| 1.2 LPG | 51 | 12/10 → | 1.242 | | M | 4 | 8 | 169A4.000 | | 84008 |
| 1.3 D Multijet | 55 | 10/07 → | 1.248 | D | M | 4 | 16 | 169A1.000 | | 81862 |
| | 70 | 12/09 → | 1.248 | D | M | 4 | 16 | 199B1.000 | | 81862 |
| 1.4 | 74 | 10/07 → | 1.368 | B | M | 4 | 16 | 169A3.000 | PIERBURG | 81369 |
| | 74 | 10/07 → | 1.368 | B | M | 4 | 16 | 169A3.000 | TESMA | 82070 |

500L

| | | | | | | | | | | |
|-------------------|----|---------|-------|---|---|---|----|----------------------|-------|-------|
| 0.9 | 77 | 09/12 → | 875 | B | M | 2 | 8 | 199B6.000 | | 84008 |
| 0.9 Natural Power | 63 | 03/13 → | 875 | | M | 2 | 8 | 312A2.000 | | 84008 |
| 1.3 D Multijet | 62 | 09/12 → | 1.248 | D | M | 4 | 16 | 199B4.000 | | 81862 |
| | 70 | 06/14 → | 1.248 | D | M | 4 | 16 | 330A1.000 | | 81862 |
| 1.4 | 70 | 09/12 → | 1.368 | B | M | 4 | 16 | 843A1.000 | TESMA | 82070 |
| | 88 | 10/13 → | 1.368 | B | M | 4 | 16 | 940B7.000 | TESMA | 82070 |
| 1.4 LPG | 88 | 02/14 → | 1.368 | | M | 4 | 16 | 940B7.000 | TESMA | 82070 |
| 1.6 D Multijet | 77 | 09/12 → | 1.598 | D | M | 4 | 16 | 199B5.000 | | 81872 |
| | 88 | 09/13 → | 1.598 | D | M | 4 | 16 | 940C1.000, 955A3.000 | | 81872 |

500X

| | | | | | | | | | | |
|----------------|-----|---------|-------|---|---|---|----|----------|-------|-------|
| 1.3 D Multijet | 70 | 06/15 → | 1.248 | D | M | 4 | 16 | 55266963 | | 81862 |
| 1.4 | 100 | 09/14 → | 1.368 | B | M | 4 | 16 | 55263624 | TESMA | 82070 |
| | 103 | 09/14 → | 1.368 | B | M | 4 | 16 | 55263624 | TESMA | 82070 |
| 1.4 4x4 | 120 | 02/15 → | 1.368 | B | M | 4 | 16 | 55263623 | TESMA | 82070 |
| | 125 | 02/15 → | 1.368 | B | M | 4 | 16 | 55263623 | TESMA | 82070 |
| 1.6 | 81 | 11/14 → | 1.598 | B | M | 4 | 16 | 55263842 | | 81861 |
| | 82 | 09/14 → | 1.598 | B | M | 4 | 16 | 55263842 | | 81861 |
| 1.6 D Multijet | 84 | 09/14 → | 1.598 | D | M | 4 | 16 | 55260384 | | 81872 |
| | 88 | 09/14 → | 1.598 | D | M | 4 | 16 | 55260384 | | 81872 |

KW

cm³

NO. OF VALVES

FIAT
Barchetta

| | | | | | | | | | | |
|---------|----|---------------|-------|---|---|---|----|----------------------|-----------|-------|
| 1.8 16V | 96 | 04/95 → 05/05 | 1.747 | B | M | 4 | 16 | 183A1.000, 188A6.000 | → 08-2000 | 81331 |
| | 96 | 04/95 → 05/05 | 1.747 | B | M | 4 | 16 | 183A1.000, 188A6.000 | 09-2000 → | 81348 |

Brava

| | | | | | | | | | | |
|--------------|-----|---------------|-------|---|---|---|----|-----------|----------------------------|-------|
| 1.2 16V | 64 | 12/98 → 12/02 | 1.242 | B | M | 4 | 16 | 182B2.000 | PIERBURG | 81369 |
| 1.2 16V 80 | 59 | 10/00 → 10/01 | 1.242 | B | M | 4 | 16 | 188A5.000 | PIERBURG | 81369 |
| | 60 | 12/98 → 12/02 | 1.242 | B | M | 4 | 16 | 182B2.000 | → 03-1999 | 81369 |
| | 60 | 12/98 → 12/02 | 1.242 | B | M | 4 | 16 | 182B2.000 | 04-1999 →, PIERBURG | 81369 |
| 1.4 | 55 | 10/95 → 10/01 | 1.370 | B | M | 4 | 12 | 182A5.000 | → 12-1997, → M: 705.144 | 81340 |
| | 55 | 10/95 → 10/01 | 1.370 | B | M | 4 | 12 | 182A5.000 | 01-1998 →, M →: 705.145 | 81351 |
| 1.4 12 V | 59 | 10/95 → 08/98 | 1.370 | B | M | 4 | 12 | 182A3.000 | → 12-1997, → M: 705.144 | 81340 |
| | 59 | 10/95 → 08/98 | 1.370 | B | M | 4 | 12 | 182A3.000 | 01-1998 →, M →: 705.145 | 81351 |
| 1.6 16V | 66 | 10/95 → 10/01 | 1.581 | B | M | 4 | 16 | 182A6.000 | (-)COP | 81364 |
| | 66 | 10/95 → 10/01 | 1.581 | B | M | 4 | 16 | 182A6.000 | (+)COP | 81341 |
| | 76 | 02/96 → 10/01 | 1.581 | B | M | 4 | 16 | 182A4.000 | (-)COP | 81364 |
| | 76 | 02/96 → 10/01 | 1.581 | B | M | 4 | 16 | 182A4.000 | (+)COP | 81341 |
| | 76 | 01/99 → 12/02 | 1.596 | B | M | 4 | 16 | 182B6.000 | (-)COP | 81364 |
| | 76 | 01/99 → 12/02 | 1.596 | B | M | 4 | 16 | 182B6.000 | (+)COP | 81341 |
| 1.8 GT 16V | 83 | 10/95 → 10/01 | 1.747 | B | M | 4 | 16 | 182A2.000 | 10-1995 → | 81331 |
| 1.9 D | 48 | 10/95 → 10/01 | 1.929 | D | M | 4 | 8 | 160A7.000 | (-)COP | 81372 |
| | 48 | 10/95 → 10/01 | 1.929 | D | M | 4 | 8 | 160A7.000 | (+)COP | 81342 |
| 1.9 JTD | 74 | 09/00 → 10/01 | 1.910 | D | M | 4 | 8 | 182B9.000 | | 81330 |
| 1.9 JTD 105 | 77 | 12/98 → 10/01 | 1.910 | D | M | 4 | 8 | 182B4.000 | | 81352 |
| 1.9 TD 100 S | 74 | 03/96 → 10/01 | 1.910 | D | M | 4 | 8 | 182A7.000 | 09-1996 → | 81330 |
| 1.9 TD 75 S | 55 | 03/96 → 10/01 | 1.910 | D | M | 4 | 8 | 182A8.000 | 09-1996 → | 81352 |
| 2.0 | 113 | 09/98 → 08/00 | 1.998 | B | M | 5 | 20 | 182B7.000 | | 81329 |

Bravo I

| | | | | | | | | | | |
|------------|----|---------------|-------|---|---|---|----|-----------|----------------------------|-------|
| 1.2 16V 80 | 59 | 10/00 → 10/01 | 1.242 | B | M | 4 | 16 | 188A5.000 | PIERBURG | 81369 |
| | 60 | 12/98 → 10/00 | 1.242 | B | M | 4 | 16 | 182B2.000 | → 03-1999 | 81369 |
| | 60 | 12/98 → 10/00 | 1.242 | B | M | 4 | 16 | 182B2.000 | 04-1999 →, PIERBURG | 81369 |
| | 64 | 12/98 → 10/01 | 1.242 | B | M | 4 | 16 | 182B2.000 | PIERBURG | 81369 |
| 1.4 | 55 | 10/95 → 10/01 | 1.370 | B | M | 4 | 12 | 182A5.000 | → 12-1997, → M: 705.144 | 81340 |
| | 55 | 10/95 → 10/01 | 1.370 | B | M | 4 | 12 | 182A5.000 | 01-1998 →, M →: 705.145 | 81351 |
| | 59 | 10/95 → 10/01 | 1.370 | B | M | 4 | 12 | 182A3.000 | → 12-1997, → M: 705.144 | 81340 |
| | 59 | 10/95 → 10/01 | 1.370 | B | M | 4 | 12 | 182A3.000 | 01-1998 →, M →: 705.145 | 81351 |

KW

cm³

NO. OF VALVES

FIAT
Bravo I

| | | | | | | | | | | |
|--------------|-----|---------------|-------|---|---|---|----|-----------|-------------------|-------|
| 1.6 | 76 | 09/00 → 10/01 | 1.596 | B | M | 4 | 16 | 182B6.000 | (-)COP | 81364 |
| | 76 | 09/00 → 10/01 | 1.596 | B | M | 4 | 16 | 182B6.000 | (+)COP | 81341 |
| 1.6 16V | 66 | 10/95 → 10/01 | 1.581 | B | M | 4 | 16 | 182A6.000 | (-)COP, 10-1995 → | 81364 |
| | 66 | 10/95 → 10/01 | 1.581 | B | M | 4 | 16 | 182A6.000 | (+)COP, 10-1995 → | 81341 |
| | 76 | 03/96 → 10/01 | 1.581 | B | M | 4 | 16 | 182A4.000 | (-)COP | 81364 |
| | 76 | 03/96 → 10/01 | 1.581 | B | M | 4 | 16 | 182A4.000 | (+)COP | 81341 |
| 1.8 GT | 83 | 10/95 → 10/01 | 1.747 | B | M | 4 | 16 | 182A2.000 | 10-1995 → | 81331 |
| 1.9 D | 48 | 10/95 → 10/01 | 1.929 | D | M | 4 | 8 | 160A7.000 | (-)COP | 81372 |
| | 48 | 10/95 → 10/01 | 1.929 | D | M | 4 | 8 | 160A7.000 | (+)COP | 81342 |
| 1.9 JTD | 74 | 09/00 → 10/01 | 1.910 | D | M | 4 | 8 | 182B9.000 | | 81330 |
| 1.9 JTD 105 | 77 | 12/98 → 10/01 | 1.910 | D | M | 4 | 8 | 182B4.000 | | 81352 |
| 1.9 TD 100 S | 74 | 03/96 → 10/01 | 1.910 | D | M | 4 | 8 | 182A7.000 | 09-1996 → | 81330 |
| 1.9 TD 75 S | 55 | 03/96 → 10/01 | 1.910 | D | M | 4 | 8 | 182A8.000 | 09-1996 → | 81352 |
| 2.0 HGT 20V | 108 | 10/95 → 07/98 | 1.998 | B | M | 5 | 20 | 182A1.000 | 10-1995 → | 81329 |
| | 113 | 07/98 → 10/01 | 1.998 | B | M | 5 | 20 | 182B7.000 | | 81329 |

Bravo II, Van

| | | | | | | | | | | |
|----------------|-----|---------------|-------|---|---|---|----|----------------------|----------|-------|
| 1.4 | 66 | 04/07 → | 1.368 | B | M | 4 | 16 | 192B2.000 | PIERBURG | 81369 |
| | 66 | 04/07 → | 1.368 | B | M | 4 | 16 | 192B2.000 | TESMA | 82070 |
| 1.4 16V | 103 | 03/08 → | 1.368 | B | M | 4 | 16 | 198A7.000 | TESMA | 82070 |
| 1.4 LPG | 66 | 11/09 → | 1.368 | | M | 4 | 16 | 192B2.000 | TESMA | 82070 |
| 1.4 T-Jet | 88 | 09/07 → | 1.368 | B | M | 4 | 16 | 198A4.000 | PIERBURG | 81369 |
| | 88 | 09/07 → | 1.368 | B | M | 4 | 16 | 198A4.000 | TESMA | 82070 |
| | 110 | 09/07 → | 1.368 | B | M | 4 | 16 | 198A1.000 | PIERBURG | 81369 |
| | 110 | 09/07 → | 1.368 | B | M | 4 | 16 | 198A1.000 | TESMA | 82070 |
| 1.6 D Multijet | 66 | 03/08 → | 1.598 | D | M | 4 | 16 | 198A6.000 | | 81872 |
| | 77 | 03/08 → | 1.598 | D | M | 4 | 16 | 198A3.000 | | 81872 |
| | 77 | 09/07 → | 1.598 | D | M | 4 | 16 | 198A3.000, 844A3.000 | | 81872 |
| | 85 | 11/08 → | 1.598 | D | M | 4 | 16 | 955A4.000 | | 81872 |
| | 88 | 03/08 → | 1.598 | D | M | 4 | 16 | 198A2.000 | | 81872 |
| 1.9 D Multijet | 66 | 04/07 → 12/08 | 1.910 | D | M | 4 | 8 | 192B5.000 | | 81352 |
| | 85 | 11/06 → | 1.910 | D | M | 4 | 8 | 192A1.000, 192B4.000 | | 81352 |
| | 88 | 04/07 → | 1.910 | D | M | 4 | 8 | 192A8.000 | | 81352 |
| | 110 | 04/07 → | 1.910 | D | M | 4 | 16 | 937A5.000 | | 81872 |
| 2.0 D Multijet | 120 | 09/08 → | 1.956 | D | M | 4 | 16 | 198A8.000, 844A2.000 | | 81872 |
| | 121 | 09/08 → | 1.956 | D | M | 4 | 16 | 198A5.000 | | 81872 |

Cinquecento

| | | | | | | | | | | |
|--------------|----|---------------|-------|---|---|---|---|------------------------|--------|-------|
| 0.9 | 30 | 07/91 → 12/93 | 903 | B | M | 4 | 8 | 170A1.000 | (-)JAC | 81300 |
| | 30 | 07/91 → 12/93 | 903 | B | M | 4 | 8 | 170A1.000 | (+)JAC | 81301 |
| 0.9 i.e. | 30 | 07/91 → 12/93 | 903 | B | M | 4 | 8 | 170A1.046 | (-)JAC | 81300 |
| | 30 | 07/91 → 12/93 | 903 | B | M | 4 | 8 | 170A1.046 | (+)JAC | 81301 |
| 0.9 i.e. S | 29 | 07/91 → 07/99 | 899 | B | M | 4 | 8 | 1170A1.000, 1170A1.046 | | 81301 |
| 1.1 Sporting | 40 | 10/94 → 01/98 | 1.108 | B | M | 4 | 8 | 176B2.000 | | 81801 |

KW

cm³

NO. OF VALVES

FIAT
Coupé

| | | | | | | | | | | |
|---------------|-----|---------------|-------|---|---|---|----|-----------|-----------|-------|
| 1.8 16V | 96 | 03/96 → 08/00 | 1.747 | B | M | 4 | 16 | 183A1.000 | | 81331 |
| 2.0 16V | 102 | 11/93 → 08/96 | 1.995 | B | M | 4 | 16 | 836A3.000 | 02-1994 → | 81322 |
| 2.0 16V Turbo | 140 | 11/93 → 08/96 | 1.995 | B | M | 4 | 16 | 175A1.000 | 02-1994 → | 81322 |
| 2.0 20V | 108 | 08/96 → 04/98 | 1.998 | B | M | 5 | 20 | 182A1.000 | 09-1996 → | 81329 |
| | 113 | 04/98 → 08/00 | 1.998 | B | M | 5 | 20 | 182B3.000 | | 81329 |
| 2.0 20V Turbo | 162 | 08/96 → 08/00 | 1.998 | B | M | 5 | 20 | 175A3.000 | 09-1996 → | 81329 |

Croma I

| | | | | | | | | | | |
|-------------------|-----|---------------|-------|---|---|---|----|----------------------|--------------|-------|
| 1900 Turbo D i.d. | 66 | 05/89 → 10/92 | 1.929 | D | M | 4 | 8 | 154C6.000 | T →: 286.050 | 81309 |
| 2000 16V | 101 | 08/92 → 08/96 | 1.995 | B | M | 4 | 16 | 154E1.000 | | 81490 |
| 2000 CHT | 74 | 01/91 → 09/92 | 1.995 | B | M | 4 | 8 | 154A1.000, 154C5.000 | | 81443 |

| | | | | | | | | | | |
|-----------|----|---------------|-------|---|---|---|---|---------------------|--|-------|
| 2000 i.e. | 83 | 03/86 → 09/90 | 1.995 | B | M | 4 | 8 | 834B.048 | 08-1986 →, → 02-1991, → T: 285.921 | 81443 |
| | 85 | 10/87 → 08/96 | 1.995 | B | M | 4 | 8 | 154C3.046, 834B.146 | → 02-1991, → T: 285.921 | 81443 |
| | 85 | 10/87 → 08/96 | 1.995 | B | M | 4 | 8 | 154C3.046, 834B.146 | 03-1991 →, T →: 285.922 | 81460 |
| | 88 | 03/87 → 09/92 | 1.995 | B | M | 4 | 8 | 154C3.000, 834B.000 | → 02-1991, → T: 285.921 | 81443 |
| | 88 | 03/87 → 09/92 | 1.995 | B | M | 4 | 8 | 154C3.000, 834B.000 | 03-1991 →, T →: 285.922 | 81460 |

| | | | | | | | | | | |
|-----------------|-----|---------------|-------|---|---|---|---|---------------------|----------------------------|-------|
| 2000 i.e. Turbo | 110 | 06/87 → 08/96 | 1.995 | B | M | 4 | 8 | 154C4.046, 834C.146 | → 02-1991, → T: 285.921 | 81443 |
| | 110 | 06/87 → 08/96 | 1.995 | B | M | 4 | 8 | 154C4.046, 834C.146 | 04-1991 →, T →: 285.922 | 81460 |
| | 114 | 12/85 → 06/90 | 1.995 | B | M | 4 | 8 | 154A2.000 | | 81443 |

| | | | | | | | | | | |
|---------|----|---------------|-------|---|---|---|---|------------------------------------|--|-------|
| 2500 TD | 85 | 05/89 → 08/96 | 2.500 | D | M | 4 | 8 | 8144.97, 8144.97.2400, 8144.97Y | 01-1993 → | 81325 |
| | 85 | 05/89 → 08/96 | 2.500 | D | M | 4 | 8 | 8144.97, 8144.97.2400, 8144.97Y | 10-1991 →, → 12-1992, → M: 1.340.163 | 81324 |

| | | | | | | | | | | |
|----------|----|---------------|-------|---|---|---|---|----------|------------------------------|-------|
| 2500 TDE | 77 | 12/91 → 08/96 | 2.500 | D | M | 4 | 8 | 8144.97S | → 12-1992, M →: 1.340.163 | 81324 |
| | 77 | 12/91 → 08/96 | 2.500 | D | M | 4 | 8 | 8144.97S | 01-1993 → | 81325 |

| | | | | | | | | | | |
|---------|-----|---------------|-------|---|---|---|----|----------|--|---------|
| 2500 V6 | 119 | 06/93 → 08/96 | 2.492 | B | M | 6 | 12 | 834G.000 | | 19532/E |
|---------|-----|---------------|-------|---|---|---|----|----------|--|---------|

Croma II

| | | | | | | | | | | |
|----------------|-----|---------|-------|---|---|---|----|-----------|--|-------|
| 1.8 16V | 103 | 12/05 → | 1.796 | B | M | 4 | 16 | 939A4.000 | | 82083 |
| 1.9 D Multijet | 85 | 06/05 → | 1.910 | D | M | 4 | 8 | 939A7.000 | | 81352 |
| | 88 | 06/05 → | 1.910 | D | M | 4 | 8 | 939A1.000 | | 81352 |
| | 100 | 12/05 → | 1.910 | D | M | 4 | 16 | 939A8.000 | | 81872 |
| | 110 | 06/05 → | 1.910 | D | M | 4 | 16 | 939A2.000 | | 81872 |
| 2.2 16V | 108 | 06/05 → | 2.198 | B | M | 4 | 16 | 194A1.000 | | 81812 |
| 2.4 D Multijet | 147 | 06/05 → | 2.387 | D | M | 5 | 20 | 939A3.000 | | 81872 |

KW

cm³

NO. OF VALVES

MAGNETI MARELLI
FIAT
Doblò I, Cargo

| | | | | | | | | | | |
|----------------------|----|---------------|-------|---|---|---|----|----------------------|----------|-------|
| 1.2 | 48 | 03/01 → | 1.242 | B | M | 4 | 8 | 223A5.000 | MAGMA | 81370 |
| 1.3 D Multijet | 55 | 10/05 → 01/10 | 1.248 | D | M | 4 | 16 | 199A2.000 | | 81862 |
| | 62 | 10/05 → | 1.248 | D | M | 4 | 16 | 223A9.000 | | 81862 |
| 1.3 JTD | 55 | 05/05 → | 1.248 | D | M | 4 | 16 | 199A2.000 | | 81862 |
| 1.3 JTD 16V | 51 | 05/04 → 12/06 | 1.248 | D | M | 4 | 16 | 188A8.000, 188A9.000 | | 81862 |
| | 51 | 12/04 → 05/05 | 1.248 | D | M | 4 | 16 | 188A9.000 | | 81862 |
| 1.3 JTD 16V Multijet | 62 | 08/06 → | 1.248 | D | M | 4 | 16 | 223A9.000 | | 81862 |
| 1.4 | 57 | 10/05 → | 1.368 | B | M | 4 | 8 | 350A1.000 | PIERBURG | 81369 |
| | 57 | 10/05 → | 1.368 | B | M | 4 | 8 | 350A1.000 | TESMA | 82070 |
| 1.6 | 68 | 09/02 → | 1.596 | B | M | 4 | 16 | 182B6.000 | (-)COP | 81364 |
| | 68 | 09/02 → | 1.596 | B | M | 4 | 16 | 182B6.000 | (+)COP | 81341 |
| 1.6 16V | 76 | 10/01 → | 1.596 | B | M | 4 | 16 | 182B6.000 | (-)COP | 81364 |
| | 76 | 10/01 → | 1.596 | B | M | 4 | 16 | 182B6.000 | (+)COP | 81341 |
| 1.6 Natural Power | 76 | 09/02 → | 1.596 | | M | 4 | 16 | 182B6.000 | (-)COP | 81364 |
| | 76 | 09/02 → | 1.596 | | M | 4 | 16 | 182B6.000 | (+)COP | 81341 |
| 1.9 D | 46 | 03/01 → | 1.910 | D | M | 4 | 8 | 223A6.000 | | 81352 |
| 1.9 D Multijet | 88 | 10/05 → | 1.910 | D | M | 4 | 8 | 186A9.000 | | 81352 |
| 1.9 JTD | 77 | 07/03 → | 1.910 | D | M | 4 | 8 | 223A7.000, 223B1.000 | | 81352 |
| | 74 | 10/01 → | 1.910 | D | M | 4 | 8 | 182B9.000 | | 81352 |
| | 74 | 10/01 → | 1.910 | D | M | 4 | 8 | 182B9.000, 223B2.000 | | 81352 |
| 1.9 JTD Multijet | 88 | 12/06 → | 1.910 | D | M | 4 | 8 | 186A9.000 | | 81352 |

Doblò II, Cargo

| | | | | | | | | | | |
|-------------------|----|---------|-------|---|---|---|----|----------------------|--------|------------------|
| 1.3 D Multijet | 66 | 02/10 → | 1.248 | D | M | 4 | 16 | 199A3.000, 263A2.000 | | 81862 |
| 1.4 | 70 | 02/10 → | 1.368 | B | M | 4 | 16 | 843A1.000 | TESMA | 82070 |
| | 70 | 04/10 → | 1.368 | B | M | 4 | 16 | 843A1.000 | (-)COP | 84038 NEW |
| | 70 | 04/10 → | 1.368 | B | M | 4 | 16 | 843A1.000 | (+)COP | 82089 |
| | 70 | 04/10 → | 1.368 | B | M | 4 | 16 | 843A1.000 | | 82089 |
| | 88 | 10/11 → | 1.368 | B | M | 4 | 16 | 198A4.000 | TESMA | 82070 |
| 1.4 Natural Power | 88 | 06/10 → | 1.368 | | M | 4 | 16 | 198A4.000 | TESMA | 82070 |
| 1.6 D Multijet | 66 | 02/10 → | 1.598 | D | M | 4 | 16 | 263A4.000 | | 81872 |
| | 66 | 02/10 → | 1.598 | D | M | 4 | 16 | 263A4.000, 263A5.000 | | 81872 |
| | 74 | 02/10 → | 1.598 | D | M | 4 | 16 | 263A3.000 | | 81872 |
| | 77 | 02/10 → | 1.598 | D | M | 4 | 16 | 198A3.000 | | 81872 |
| 2.0 D Multijet | 99 | 02/10 → | 1.956 | D | M | 4 | 16 | 263A1.000 | | 81872 |

Ducato I

| | | | | | | | | | | |
|--------|----|---------------|-------|---|---|---|---|------------|-----------|-------|
| 1.9 D | 52 | 01/88 → 08/90 | 1.929 | D | M | 4 | 8 | 149B1.000 | | 81489 |
| 1.9 TD | 60 | 03/89 → 08/90 | 1.929 | D | M | 4 | 8 | 280A1.000 | | 81489 |
| 2.0 | 55 | 07/85 → 08/90 | 1.971 | B | M | 4 | 8 | 170B | | 81367 |
| | 55 | 07/85 → 08/90 | 1.971 | B | M | 4 | 8 | 170B, XN1T | | 81367 |
| | 58 | 01/82 → 08/90 | 1.971 | B | M | 4 | 8 | XN1T | | 81367 |
| | 62 | 03/89 → 08/90 | 1.971 | B | M | 4 | 8 | 170D | | 81367 |
| 2.4 D | 53 | 01/82 → 08/90 | 2.428 | D | M | 4 | 8 | 8144.61 | → 09-1986 | 81492 |
| | 53 | 01/82 → 08/90 | 2.428 | D | M | 4 | 8 | 8144.61 | 10-1986 → | 81488 |

KW

cm³

NO. OF VALVES

FIAT
Ducato I

| | | | | | | | | | | |
|------------|----|---------------|-------|---|---|---|---|---------------------------|--|-------|
| 2.5 D | 55 | 01/82 → 08/90 | 2.500 | D | M | 4 | 8 | 8144.67, CRD93L (U25-661) | | 81822 |
| 2.5 D 4x4 | 55 | 03/89 → 08/90 | 2.500 | D | M | 4 | 8 | 8144.67 | | 81488 |
| 2.5 TD | 68 | 01/86 → 08/90 | 2.445 | D | M | 4 | 8 | 8144.21 | | 81488 |
| | 68 | 01/87 → 08/90 | 2.445 | D | M | 4 | 8 | 8144.21, 8144.21.220 | | 81488 |
| 2.5 TD 4x4 | 68 | 01/86 → 08/90 | 2.445 | D | M | 4 | 8 | 8144.21 | | 81488 |
| | 70 | 09/86 → 05/90 | 2.499 | D | M | 4 | 8 | 8140.27 | | 81488 |

Ducato II

| | | | | | | | | | | |
|------------|----|---------------|-------|---|---|---|---|-----------|--|-------|
| 1.9 D | 52 | 07/90 → 03/94 | 1.929 | D | M | 4 | 8 | 149B1.000 | | 81489 |
| 1.9 TD | 60 | 03/89 → 03/94 | 1.929 | D | M | 4 | 8 | 280A1.000 | | 81489 |
| 2.0 | 62 | 07/90 → 03/94 | 1.971 | B | M | 4 | 8 | 170D | | 81367 |
| 2.0 4x4 | 63 | 06/90 → 05/94 | 1.971 | B | M | 4 | 8 | 170D | | 81367 |
| 2.5 D | 55 | 07/90 → 03/94 | 2.500 | D | M | 4 | 8 | 8144.67 | | 81488 |
| 2.5 D 4x4 | 55 | 07/90 → 03/94 | 2.500 | D | M | 4 | 8 | 8144.67 | | 81488 |
| 2.5 TD | 70 | 07/90 → 03/94 | 2.500 | D | M | 4 | 8 | 8140.27 | | 81488 |
| 2.5 TD 4x4 | 70 | 07/90 → 03/94 | 2.500 | D | M | 4 | 8 | 8140.27 | | 81488 |

Ducato III

| | | | | | | | | | | |
|-------------------------------|----|---------------|-------|---|---|---|---|-----------------------|-----------|-------|
| 1.9 D | 50 | 04/98 → 04/02 | 1.905 | D | M | 4 | 8 | D9B, D9B (XUD9A), DJY | | 81642 |
| | 50 | 04/98 → 04/02 | 1.905 | D | M | 4 | 8 | DJY | | 81642 |
| | 51 | 03/94 → 04/02 | 1.929 | D | M | 4 | 8 | 230A2.000 | 03-1994 → | 81320 |
| 1.9 D Combinato | 51 | 06/95 → 04/02 | 1.929 | D | M | 4 | 8 | 230A2.000 | | 81320 |
| 1.9 TD | 66 | 04/98 → 04/02 | 1.905 | D | M | 4 | 8 | DHX (XUD9TF/L) | | 81642 |
| | 60 | 03/94 → 04/02 | 1.929 | D | M | 4 | 8 | 230A3.000 | (-)AC | 81318 |
| | 60 | 03/94 → 04/02 | 1.929 | D | M | 4 | 8 | 230A3.000 | (+)AC | 81319 |
| 1.9 TD CAT | 59 | 08/94 → 04/02 | 1.929 | D | M | 4 | 8 | 230A4.000 | (-)AC | 81318 |
| | 59 | 08/94 → 04/02 | 1.929 | D | M | 4 | 8 | 230A4.000 | (+)AC | 81319 |
| 1.9 TD Combinato | 59 | 08/94 → 04/02 | 1.929 | D | M | 4 | 8 | 230A4.000 | (-)AC | 81318 |
| | 59 | 08/94 → 04/02 | 1.929 | D | M | 4 | 8 | 230A4.000 | (+)AC | 81319 |
| 1.9 TD Panorama/ Combinato | 60 | 03/94 → 04/02 | 1.929 | D | M | 4 | 8 | 230A3.000 | (-)AC | 81318 |
| | 60 | 03/94 → 04/02 | 1.929 | D | M | 4 | 8 | 230A3.000 | (+)AC | 81319 |
| 2.0 | 80 | 03/94 → 04/02 | 1.998 | B | M | 4 | 8 | RFW | | 81642 |
| 2.0 4x4 | 80 | 11/94 → 11/01 | 1.998 | B | M | 4 | 8 | RFW | | 81642 |
| 2.0 JTD | 62 | 10/01 → 04/02 | 1.997 | D | M | 4 | 8 | RHV (DW10) | | 81713 |
| 2.0 Panorama/ Combinato | 80 | 03/94 → 04/02 | 1.998 | B | M | 4 | 8 | RFW | | 81642 |
| 2.5 D | 62 | 03/94 → 04/02 | 2.500 | D | M | 4 | 8 | 8140.67 | | 81316 |
| 2.5 D 4x4 | 62 | 03/94 → 04/02 | 2.500 | D | M | 4 | 8 | 8140.67 | | 81316 |
| 2.5 D Combinato | 62 | 08/94 → 04/02 | 2.500 | D | M | 4 | 8 | 8140.67 | | 81316 |
| 2.5 TD | 80 | 06/94 → 08/98 | 2.499 | D | M | 4 | 8 | 8140.47 | | 81316 |
| | 85 | 06/94 → 04/98 | 2.499 | D | M | 4 | 8 | 8140.47 | | 81316 |
| 2.5 TD 4x4 | 80 | 11/94 → 04/98 | 2.499 | D | M | 4 | 8 | 8140.47 | | 81316 |
| | 85 | 11/94 → 04/98 | 2.499 | D | M | 4 | 8 | 8140.47 | | 81316 |

KW

cm³

NO. OF VALVES

FIAT
Ducato III

| | | | | | | | | | | |
|--------------------------------|----|---------------|-------|---|---|---|---|----------|--|-------|
| 2.5 TDI | 80 | 03/94 → 04/02 | 2.500 | D | M | 4 | 8 | 8140.47R | | 81316 |
| | 85 | 03/94 → 04/02 | 2.500 | D | M | 4 | 8 | 8140.47 | | 81316 |
| 2.5 TDI 4x4 | 85 | 04/97 → 04/02 | 2.500 | D | M | 4 | 8 | 8140.47 | | 81316 |
| 2.5 TDI Panorama/ Combinato | 80 | 07/94 → 04/02 | 2.500 | D | M | 4 | 8 | 8140.47R | | 81316 |
| | 85 | 03/94 → 04/02 | 2.500 | D | M | 4 | 8 | 8140.47 | | 81316 |
| 2.8 D | 64 | 02/98 → 04/02 | 2.800 | D | M | 4 | 8 | 8140.63 | | 81316 |
| 2.8 D 4x4 | 64 | 08/98 → 04/02 | 2.800 | D | M | 4 | 8 | 8140.63 | | 81316 |
| 2.8 IDTD 4x4 | 90 | 05/98 → 09/01 | 2.799 | D | M | 4 | 8 | 8140.43 | | 81316 |
| 2.8 JTD | 94 | 11/00 → 04/02 | 2.798 | D | M | 4 | 8 | 8140.43S | | 81316 |
| | 94 | 03/01 → 04/02 | 2.799 | D | M | 4 | 8 | 8140.43S | | 81316 |
| 2.8 JTD 4x4 | 94 | 11/00 → 04/02 | 2.798 | D | M | 4 | 8 | 8140.43S | | 81316 |
| | 94 | 10/01 → 04/02 | 2.799 | D | M | 4 | 8 | 8140.43S | | 81316 |
| 2.8 TD 4x4 | 64 | 05/98 → 11/01 | 2.799 | D | M | 4 | 8 | 8140.63 | | 81316 |
| | 90 | 05/98 → 09/01 | 2.799 | D | M | 4 | 8 | 8140.43 | | 81316 |
| 2.8 TDI | 90 | 10/97 → 04/02 | 2.800 | D | M | 4 | 8 | 8140.43 | | 81316 |
| 2.8 TDI 4x4 | 90 | 07/99 → 04/02 | 2.800 | D | M | 4 | 8 | 8140.43 | | 81316 |

Ducato IV

| | | | | | | | | | | |
|---------------|-----|---------------|-------|---|---|---|----|------------|--|-------|
| 2.0 | 81 | 04/02 → | 1.998 | B | M | 4 | 16 | RFL | | 81642 |
| 2.0 4x4 | 81 | 05/02 → 07/06 | 1.998 | B | M | 4 | 16 | RFL | | 81642 |
| 2.0 Bipower | 81 | 11/02 → | 1.998 | | M | 4 | 16 | RFL | | 81642 |
| 2.0 JTD | 62 | 04/02 → | 1.997 | D | M | 4 | 8 | RHV (DW10) | | 81713 |
| 2.3 JTD | 81 | 04/02 → | 2.286 | D | M | 4 | 16 | F1AE0481C | | 82024 |
| 2.8 JTD | 94 | 04/02 → | 2.798 | D | M | 4 | 8 | 8140.43S | | 81316 |
| | 107 | 04/04 → 07/06 | 2.800 | D | M | 4 | 8 | 8140.43N | | 81316 |
| 2.8 JTD 4x4 | 94 | 07/02 → | 2.798 | D | M | 4 | 8 | 8140.43S | | 81316 |
| 2.8 JTD Power | 107 | 05/04 → | 2.800 | D | M | 4 | 8 | 8140.43N | | 81316 |

Ducato V

| | | | | | | | | | | |
|------------------------|-----|---------|-------|---|---|---|----|---------------------------------------|--|-------|
| 100 Multijet 2,2 D | 74 | 07/06 → | 2.198 | D | M | 4 | 16 | 4HV | | 82066 |
| 110 Multijet 2,3 D | 83 | 10/11 → | 2.287 | D | M | 4 | 16 | F1AE3481G | | 82024 |
| 115 Multijet 2,0 D | 85 | 06/11 → | 1.956 | D | M | 4 | 16 | 250A1.000, 250A2.000 | | 82094 |
| | 85 | 06/11 → | 1.956 | D | M | 4 | 16 | 250A1.000, 250A2.000 | | 81872 |
| 120 Multijet 2,3 D | 88 | 07/06 → | 2.287 | D | M | 4 | 16 | F1AE0481D | | 82024 |
| | 88 | 07/06 → | 2.287 | D | M | 4 | 16 | F1AE0481D, FPT | | 82024 |
| 120 Multijet 2,3 D 4x4 | 88 | 03/10 → | 2.287 | D | M | 4 | 16 | F1AE0481D | | 82024 |
| | 88 | 03/10 → | 2.287 | D | M | 4 | 16 | F1AE0481D | | 81872 |
| 130 Multijet 2,3 D | 93 | 08/06 → | 2.287 | D | M | 4 | 16 | F1AE0481T | | 82024 |
| | 96 | 01/07 → | 2.287 | D | M | 4 | 16 | F1AE0481N, F1AE3481D, F1AGL411D | | 82024 |
| | 96 | 01/07 → | 2.287 | D | M | 4 | 16 | F1AE3481D, F1AGL411D | | 82024 |
| 140 Natural Power | 100 | 04/09 → | 2.999 | | M | 4 | 16 | F1CE0441A | | 82094 |
| | 100 | 04/09 → | 2.999 | | M | 4 | 16 | F1CE0441A, F1CFA401A | | 82094 |

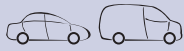
KW

cm³

NO. OF VALVES

MAGNETI MARELLI
FIAT
Ducato V

| | | | | | | | | | | |
|--------------------|-----|---------|-------|---|---|---|----|-------------------------|--|-------|
| 150 Multijet 2,3 D | 109 | 06/11 → | 2.287 | D | M | 4 | 16 | F1AE3481E | | 82024 |
| | 107 | 04/10 → | 2.999 | D | M | 4 | 16 | F1CE3481N | | 82094 |
| 160 Multijet 3,0 D | 115 | 10/06 → | 2.999 | D | M | 4 | 16 | F1CE0481D | | 82094 |
| | 115 | 07/06 → | 2.999 | D | M | 4 | 16 | F1CE3481M | | 82094 |
| | 116 | 07/06 → | 2.999 | D | M | 4 | 16 | F1CE0481D | | 82094 |
| | 116 | 07/06 → | 2.999 | D | M | 4 | 16 | F1CE0481D, F1CE3481M | | 82094 |
| 180 Multijet 3,0 D | 130 | 06/11 → | 2.999 | D | M | 4 | 16 | F1CE3481E | | 82094 |

Duna I, Weekend

| | | | | | | | | | | |
|--------|----|---------------|-------|---|---|---|---|-----------|--------|-------|
| 1.7 DS | 44 | 01/87 → 12/91 | 1.698 | D | M | 4 | 8 | 149B3.000 | (+)COP | 81456 |
| 60 1.1 | 43 | 01/87 → 12/91 | 1.116 | B | M | 4 | 8 | 146A6.000 | | 81434 |
| 70 1.3 | 49 | 01/87 → 12/91 | 1.301 | B | M | 4 | 8 | 146A5.000 | | 81434 |

Elba

| | | | | | | | | | | |
|-------|----|---------------|-------|---|---|---|---|-----------|----------------------|-------|
| 1.3 | 43 | 04/86 → 12/93 | 1.297 | B | M | 4 | 8 | 127A2.011 | | 81434 |
| 1.3 D | 33 | 04/86 → 10/92 | 1.301 | D | M | 4 | 8 | 127A5.000 | | 81434 |
| 1.5 | 52 | 04/86 → 10/92 | 1.499 | B | M | 4 | 8 | 149C1.000 | (+)COP, (+)AC | 81303 |
| 1.7 D | 43 | 04/89 → 12/96 | 1.698 | D | M | 4 | 8 | 146B2.000 | (+)COP, (-)SS, (-)AC | 81456 |
| | 43 | 04/89 → 12/96 | 1.698 | D | M | 4 | 8 | 146B2.000 | (+)SS, (+)AC | 81344 |

Fiorino II, Pick Up (147)

| | | | | | | | | | | |
|-------|----|---------------|-------|---|---|---|---|-----------|--------|-------|
| 1.3 | 49 | 12/87 → 08/93 | 1.301 | B | M | 4 | 8 | 146A5.000 | | 81434 |
| 1.7 D | 42 | 01/88 → 10/93 | 1.697 | D | M | 4 | 8 | 149B2.000 | (+)COP | 81456 |
| | 44 | 12/87 → 12/90 | 1.698 | D | M | 4 | 8 | 149B3.000 | (+)COP | 81456 |

Fiorino III, Pick Up (Uno)

| | | | | | | | | | | |
|-----|----|---------------|-------|---|---|---|---|-----------|---------------------------|-------|
| 1.3 | 49 | 01/88 → 12/94 | 1.301 | B | M | 4 | 8 | 146A5.000 | | 81434 |
| 1.4 | 49 | 05/94 → 05/01 | 1.372 | B | M | 4 | 8 | 146D5.000 | (-)COP, → M: 9.470.268 | 81314 |
| | 49 | 05/94 → 05/01 | 1.372 | B | M | 4 | 8 | 146D5.000 | (-)COP, M →: 9.470.269 | 81366 |
| | 49 | 05/94 → 05/01 | 1.372 | B | M | 4 | 8 | 146D5.000 | (+)COP, → M: 9.470.268 | 81476 |
| | 49 | 05/94 → 05/01 | 1.372 | B | M | 4 | 8 | 146D5.000 | (+)COP, M →: 9.470.269 | 81343 |
| | 52 | 11/92 → 10/96 | 1.372 | B | M | 4 | 8 | 146C5.000 | (-)COP, → M: 9.470.268 | 81314 |
| | 52 | 11/92 → 10/96 | 1.372 | B | M | 4 | 8 | 146C5.000 | (-)COP, M →: 9.470.269 | 81366 |
| | 52 | 11/92 → 10/96 | 1.372 | B | M | 4 | 8 | 146C5.000 | (+)COP, → M: 9.470.268 | 81476 |
| | 52 | 11/92 → 10/96 | 1.372 | B | M | 4 | 8 | 146C5.000 | (+)COP, M →: 9.470.269 | 81343 |

KW

cm³

NO. OF VALVES

FIAT
Fiorino III, Pick Up (Uno)

| | | | | | | | | | | |
|-------------------|----|---------------|-------|---|---|---|----|----------------------|---------------------------|-------|
| 1.6 | 55 | 01/94 → 05/01 | 1.581 | B | M | 4 | 8 | 146C6.000, 146D6.000 | (-)COP, → M: 9.470.268 | 81314 |
| | 55 | 01/94 → 05/01 | 1.581 | B | M | 4 | 8 | 146C6.000, 146D6.000 | (-)COP, M →: 9.470.269 | 81366 |
| | 55 | 01/94 → 05/01 | 1.581 | B | M | 4 | 8 | 146C6.000, 146D6.000 | (+)COP, → M: 9.470.268 | 81476 |
| | 55 | 01/94 → 05/01 | 1.581 | B | M | 4 | 8 | 146C6.000, 146D6.000 | (+)COP, M →: 9.470.269 | 81343 |
| 1.7 D | 42 | 10/93 → 10/99 | 1.697 | D | M | 4 | 8 | 146B2.000 | (+)COP, (-)SS, (-)AC | 81456 |
| | 42 | 10/93 → 10/99 | 1.697 | D | M | 4 | 8 | 146B2.000 | (+)SS, (+)AC | 81344 |
| | 44 | 01/88 → 10/99 | 1.697 | D | M | 4 | 8 | 146B2.000 | (+)COP, (-)SS, (-)AC | 81456 |
| | 44 | 01/88 → 10/99 | 1.697 | D | M | 4 | 8 | 146B2.000 | (+)SS, (+)AC | 81344 |
| | 44 | 05/88 → 10/99 | 1.698 | D | M | 4 | 8 | 149B3.000 | (+)COP, (-)SS, (-)AC | 81456 |
| | 44 | 05/88 → 10/99 | 1.698 | D | M | 4 | 8 | 149B3.000 | (+)SS, (+)AC | 81344 |
| 1.7 TD | 46 | 11/96 → 05/00 | 1.697 | D | M | 4 | 8 | 146D7.000 | | 81344 |
| | 46 | 01/97 → 05/01 | 1.698 | D | M | 4 | 8 | 146D7.000 | | 81344 |
| 60 1.1 | 40 | 05/88 → 12/93 | 1.116 | B | M | 4 | 8 | 146A9.000 | | 81434 |
| 60 1.7 D | 42 | 05/88 → 10/96 | 1.697 | D | M | 4 | 8 | 146B2.000 | (+)COP, (-)SS, (-)AC | 81456 |
| | 42 | 05/88 → 10/96 | 1.697 | D | M | 4 | 8 | 146B2.000 | (+)SS, (+)AC | 81344 |
| | 44 | 05/88 → 05/00 | 1.698 | D | M | 4 | 8 | 149B3.000 | (+)COP, (-)SS, (-)AC | 81456 |
| | 44 | 05/88 → 05/00 | 1.698 | D | M | 4 | 8 | 149B3.000 | (+)SS, (+)AC | 81344 |
| 65 1.7 TD | 46 | 01/97 → 05/01 | 1.698 | D | M | 4 | 8 | 146D7.000 | | 81344 |
| 70 1.3 | 49 | 01/88 → 12/94 | 1.301 | B | M | 4 | 8 | 146A5.000 | | 81434 |
| 70 i.e. 1.4 | 49 | 05/94 → 05/01 | 1.372 | B | M | 4 | 8 | 146C5.000, 146D5.000 | (-)COP, → M: 9.470.268 | 81314 |
| | 49 | 05/94 → 05/01 | 1.372 | B | M | 4 | 8 | 146C5.000, 146D5.000 | (-)COP, M →: 9.470.269 | 81366 |
| | 49 | 05/94 → 05/01 | 1.372 | B | M | 4 | 8 | 146C5.000, 146D5.000 | (+)COP, → M: 9.470.268 | 81476 |
| | 49 | 05/94 → 05/01 | 1.372 | B | M | 4 | 8 | 146C5.000, 146D5.000 | (+)COP, M →: 9.470.269 | 81343 |
| 75 i.e. 1.6 | 55 | 10/93 → 05/01 | 1.581 | B | M | 4 | 8 | 146C6.000, 146D6.000 | (-)COP, → M: 9.470.268 | 81314 |
| | 55 | 10/93 → 05/01 | 1.581 | B | M | 4 | 8 | 146C6.000, 146D6.000 | (-)COP, M →: 9.470.269 | 81366 |
| | 55 | 10/93 → 05/01 | 1.581 | B | M | 4 | 8 | 146C6.000, 146D6.000 | (+)COP, → M: 9.470.268 | 81476 |
| | 55 | 10/93 → 05/01 | 1.581 | B | M | 4 | 8 | 146C6.000, 146D6.000 | (+)COP, M →: 9.470.269 | 81343 |
| Fiorino IV | | | | | | | | | | |
| 1.3 D Multijet | 55 | 11/07 → | 1.248 | D | M | 4 | 16 | 199A2.000, 199A9.000 | | 81862 |
| | 70 | 07/09 → | 1.248 | D | M | 4 | 16 | 199B1.000, 330A1.000 | | 81862 |
| 1.4 | 54 | 11/07 → | 1.360 | B | M | 4 | 8 | KFT, KFV | | 81797 |
| 1.4 Natural Power | 57 | 10/09 → | 1.368 | | M | 4 | 8 | 350A1.000 | TESMA | 82070 |

KW

cm³

NO. OF VALVES

FIAT
Freemont

| | | | | | | | | | | |
|-------------|-----|---------|-------|---|---|---|----|----------------------|--|-------|
| 2.0 JTD | 100 | 08/11 → | 1.956 | D | M | 4 | 16 | 939B5.000 | | 81872 |
| | 103 | 08/11 → | 1.956 | D | M | 4 | 16 | 939B5.000, 940A5.000 | | 81872 |
| | 120 | 08/11 → | 1.956 | D | M | 4 | 16 | 939B5.000 | | 81872 |
| | 125 | 08/11 → | 1.956 | D | M | 4 | 16 | 939B5.000 | | 81872 |
| 2.0 JTD 4x4 | 120 | 08/11 → | 1.956 | D | M | 4 | 16 | 939B5.000 | | 81872 |
| | 125 | 08/11 → | 1.956 | D | M | 4 | 16 | 939B5.000 | | 81872 |

Grande Punto, Van

| | | | | | | | | | | |
|----------------------------------|-----|---------------|-------|---|---|---|----|----------------------|----------|-------|
| 1.2 | 48 | 10/05 → | 1.242 | B | M | 4 | 8 | 199A4.000 | PIERBURG | 81369 |
| | 48 | 10/05 → | 1.242 | B | M | 4 | 8 | 199A4.000 | TESMA | 82070 |
| | 51 | 09/10 → | 1.242 | B | M | 4 | 8 | 169A4.000 | TESMA | 82070 |
| 1.2 LPG | 51 | 07/08 → | 1.242 | | M | 4 | 8 | 199A4.000 | TESMA | 82070 |
| 1.3 D Multijet 1.3 D Multijet | 51 | 07/08 → | 1.248 | D | M | 4 | 16 | 199B2.000 | | 81862 |
| | 55 | 10/05 → | 1.248 | D | M | 4 | 16 | 199A2.000 | | 81862 |
| | 56 | 06/09 → | 1.248 | D | M | 4 | 16 | 199A2.000 | | 81862 |
| | 62 | 04/10 → | 1.248 | D | M | 4 | 16 | 199B4.000, 223A9.000 | | 81862 |
| | 66 | 10/05 → | 1.248 | D | M | 4 | 16 | 199A3.000 | | 81862 |
| 1.4 | 55 | 06/06 → | 1.368 | B | M | 4 | 8 | 199A7.000 | TESMA | 82070 |
| | 57 | 10/05 → | 1.368 | B | M | 4 | 8 | 350A1.000 | PIERBURG | 81369 |
| | 57 | 10/05 → | 1.368 | B | M | 4 | 8 | 350A1.000 | TESMA | 82070 |
| 1.4 16V | 70 | 10/05 → | 1.368 | B | M | 4 | 16 | 199A6.000 | PIERBURG | 81369 |
| | 70 | 10/05 → | 1.368 | B | M | 4 | 16 | 199A6.000 | TESMA | 82070 |
| | 112 | 09/07 → 07/12 | 1.368 | B | M | 4 | 16 | 198A1.000 | TESMA | 82070 |
| 1.4 LPG | 57 | 12/08 → | 1.368 | | M | 4 | 8 | 350A1.000 | TESMA | 82070 |
| 1.4 Natural Power | 57 | 07/08 → | 1.368 | | M | 4 | 8 | 350A1.000 | PIERBURG | 81369 |
| 1.4 T-Jet | 88 | 09/07 → | 1.368 | B | M | 4 | 16 | 198A4.000 | PIERBURG | 81369 |
| | 88 | 09/07 → | 1.368 | B | M | 4 | 16 | 198A4.000 | TESMA | 82070 |
| 1.6 D Multijet | 88 | 07/08 → | 1.598 | D | M | 4 | 16 | 955A3.000 | | 81872 |
| 1.9 D Multijet | 85 | 06/06 → | 1.910 | D | M | 4 | 8 | 939A7.000 | | 81872 |
| | 88 | 10/05 → | 1.910 | D | M | 4 | 8 | 939A1.000 | | 81352 |
| | 96 | 10/05 → | 1.910 | D | M | 4 | 8 | 199A5.000 | | 81352 |

Idea

| | | | | | | | | | | |
|----------------|----|---------|-------|---|---|---|----|-----------|----------|-------|
| 1.2 16V | 59 | 01/04 → | 1.242 | B | M | 4 | 16 | 188A5.000 | PIERBURG | 81369 |
| | 59 | 01/04 → | 1.242 | B | M | 4 | 16 | 188A5.000 | TESMA | 82070 |
| 1.3 D Multijet | 66 | 10/05 → | 1.248 | D | M | 4 | 16 | 199A3.000 | | 81862 |
| | 70 | 05/08 → | 1.248 | D | M | 4 | 16 | 199B1.000 | | 81862 |
| 1.3 JTD | 51 | 01/04 → | 1.248 | D | M | 4 | 16 | 188A9.000 | | 81862 |
| 1.4 | 57 | 10/05 → | 1.368 | B | M | 4 | 8 | 350A1.000 | PIERBURG | 81369 |
| | 57 | 10/05 → | 1.368 | B | M | 4 | 8 | 350A1.000 | TESMA | 82070 |
| | 66 | 12/03 → | 1.368 | B | M | 4 | 16 | 192B2.000 | PIERBURG | 81369 |
| 1.4 16V | 70 | 01/04 → | 1.368 | B | M | 4 | 16 | 843A1.000 | PIERBURG | 81369 |
| | 70 | 01/04 → | 1.368 | B | M | 4 | 16 | 843A1.000 | TESMA | 82070 |
| 1.4 LPG | 57 | 03/09 → | 1.368 | | M | 4 | 8 | 350A1.000 | TESMA | 82070 |
| 1.6 D Multijet | 88 | 05/08 → | 1.598 | D | M | 4 | 16 | 350A2.000 | | 81872 |
| 1.9 JTD | 74 | 01/04 → | 1.910 | D | M | 4 | 8 | 188B2.000 | | 81352 |

KW

cm³

NO. OF VALVES

FIAT
Linea

| | | | | | | | | | | |
|----------------|----|---------|-------|---|---|---|----|-----------|----------|-------|
| 1.3 D Multijet | 66 | 06/07 → | 1.248 | D | M | 4 | 16 | 199A3.000 | | 81862 |
| | 70 | 09/09 → | 1.248 | D | M | 4 | 16 | 199A3.000 | | 81862 |
| 1.4 | 57 | 06/07 → | 1.368 | B | M | 4 | 8 | 350A1.000 | PIERBURG | 81369 |
| 1.4 | 57 | 06/07 → | 1.368 | B | M | 4 | 8 | 350A1.000 | TESMA | 82070 |
| 1.4 T-Jet | 88 | 09/07 → | 1.368 | B | M | 4 | 16 | 198A4.000 | PIERBURG | 81369 |
| | 88 | 09/07 → | 1.368 | B | M | 4 | 16 | 198A4.000 | TESMA | 82070 |
| 1.6 D Multijet | 77 | 06/09 → | 1.598 | D | M | 4 | 16 | 198A3.000 | | 81872 |

Marea, Weekend

| | | | | | | | | | | |
|---------------------|-----|---------------|-------|---|---|---|----|----------------------|----------------------------|-------|
| 1.2 16V | 60 | 10/98 → 05/02 | 1.242 | B | M | 4 | 16 | 182B2.000 | PIERBURG | 81369 |
| 1.4 80 12V | 59 | 09/96 → 05/02 | 1.370 | B | M | 4 | 12 | 182A3.000 | → 12-1997, → M: 705.144 | 81340 |
| | 59 | 09/96 → 05/02 | 1.370 | B | M | 4 | 12 | 182A3.000 | 01-1998 →, M →: 705.145 | 81351 |
| 1.6 | 68 | 03/99 → 08/00 | 1.581 | B | M | 4 | 16 | 185A3.000 | (-)COP | 81364 |
| | 68 | 03/99 → 08/00 | 1.581 | B | M | 4 | 16 | 185A3.000 | (+)COP | 81341 |
| | 76 | 09/00 → 08/02 | 1.596 | B | M | 4 | 16 | 182B6.000 | (-)COP | 81364 |
| | 76 | 09/00 → 08/02 | 1.596 | B | M | 4 | 16 | 182B6.000 | (+)COP | 81341 |
| 1.6 100 16V | 76 | 09/96 → 05/02 | 1.581 | B | M | 4 | 16 | 182A4.000 | (-)COP | 81364 |
| | 76 | 09/96 → 05/02 | 1.581 | B | M | 4 | 16 | 182A4.000 | (+)COP | 81341 |
| 1.6 100 16V Bipower | 76 | 04/99 → 05/02 | 1.581 | | M | 4 | 16 | 185A3.000, 186A4.000 | (-)COP | 81364 |
| | 76 | 04/99 → 05/02 | 1.581 | | M | 4 | 16 | 185A3.000, 186A4.000 | (+)COP | 81341 |
| 1.6 16V | 75 | 04/97 → 02/99 | 1.581 | B | M | 4 | 16 | 185A3.000 | (-)COP | 81364 |
| | 75 | 04/97 → 02/99 | 1.581 | B | M | 4 | 16 | 185A3.000 | (+)COP | 81341 |
| 1.6 SX | 72 | 09/00 → 08/02 | 1.581 | B | M | 4 | 16 | 182B5.098 | (-)COP | 81364 |
| | 72 | 09/00 → 08/02 | 1.581 | B | M | 4 | 16 | 182B5.098 | (+)COP | 81341 |
| 1.8 115 16V | 83 | 09/96 → 05/02 | 1.747 | B | M | 4 | 16 | 182A2.000 | | 81331 |
| 1.9 JTD 105 | 77 | 04/99 → 01/01 | 1.910 | D | M | 4 | 8 | 182B4.000 | | 81352 |
| 1.9 JTD 110 | 81 | 01/01 → 05/02 | 1.910 | D | M | 4 | 8 | 186A6.000 | | 81352 |
| 1.9 TD 100 | 74 | 09/96 → 05/02 | 1.910 | D | M | 4 | 8 | 182A7.000 | | 81330 |
| | 74 | 09/96 → 05/02 | 1.910 | D | M | 4 | 8 | 182A7.000, 182B9.000 | | 81330 |
| 1.9 TD 75 | 55 | 09/96 → 05/02 | 1.910 | D | M | 4 | 8 | 182A8.000 | (+)COP, 05-1999 → | 81303 |
| | 55 | 09/96 → 05/02 | 1.910 | D | M | 4 | 8 | 182A8.000 | → 04-1999 | 81330 |
| | 55 | 09/96 → 05/02 | 1.910 | D | M | 4 | 8 | 182A8.000 | 05-1999 → | 81352 |
| 2.0 150 20V | 108 | 09/96 → 04/99 | 1.998 | B | M | 5 | 20 | 182A1.000 | 10-1996 → | 81329 |
| | 110 | 01/01 → 05/02 | 1.998 | B | M | 5 | 20 | 185A8.000 | | 81329 |
| | 113 | 04/99 → 01/01 | 1.998 | B | M | 5 | 20 | 182B7.000 | | 81329 |
| 2.4 JTD 130 | 96 | 04/99 → 05/02 | 2.387 | D | M | 5 | 10 | 185A6.000, 839A5.000 | | 81330 |
| | 96 | 04/99 → 05/02 | 2.387 | D | M | 5 | 10 | 185A6.000, 839A5.000 | | 81352 |
| 2.4 TD 125 | 91 | 09/96 → 04/99 | 2.387 | D | M | 5 | 10 | 185A2.000 | 11-1996 → | 81330 |

KW

cm³

NO. OF VALVES

FIAT
Multipla

| | | | | | | | | | | |
|------------------|----|---------------|-------|---|---|---|----|-----------|--------|-------|
| 1.6 | 68 | 05/04 → 08/05 | 1.596 | G | M | 4 | 16 | 182B6.000 | (-)COP | 81364 |
| | 68 | 05/04 → 08/05 | 1.596 | G | M | 4 | 16 | 182B6.000 | (+)COP | 81341 |
| | 74 | 03/01 → 08/05 | 1.596 | G | M | 4 | 16 | 182B6.000 | (-)COP | 81364 |
| | 74 | 03/01 → 08/05 | 1.596 | G | M | 4 | 16 | 182B6.000 | (+)COP | 81341 |
| | 76 | 09/00 → 06/10 | 1.596 | B | M | 4 | 16 | 182B6.000 | (-)COP | 81364 |
| | 76 | 09/00 → 06/10 | 1.596 | B | M | 4 | 16 | 182B6.000 | (+)COP | 81341 |
| 1.6 100 16V | 76 | 04/99 → 06/10 | 1.581 | B | M | 4 | 16 | 182A4.000 | (-)COP | 81364 |
| | 76 | 04/99 → 06/10 | 1.581 | B | M | 4 | 16 | 182A4.000 | (+)COP | 81341 |
| 1.6 16V | 70 | 04/02 → 06/10 | 1.596 | B | M | 4 | 16 | 182B6.000 | (-)COP | 81364 |
| | 70 | 04/02 → 06/10 | 1.596 | B | M | 4 | 16 | 182B6.000 | (+)COP | 81341 |
| 1.6 16V Bipower | 76 | 04/99 → 06/10 | 1.581 | | M | 4 | 16 | 186A4.000 | (-)COP | 81364 |
| | 76 | 04/99 → 06/10 | 1.581 | | M | 4 | 16 | 186A4.000 | (+)COP | 81341 |
| | 76 | 10/01 → 06/10 | 1.596 | | M | 4 | 16 | 182B6.000 | (-)COP | 81364 |
| | 76 | 10/01 → 06/10 | 1.596 | | M | 4 | 16 | 182B6.000 | (+)COP | 81341 |
| 1.6 16V Blupower | 70 | 04/99 → 06/10 | 1.581 | G | M | 4 | 16 | 186A3.000 | (-)COP | 81364 |
| | 70 | 04/99 → 06/10 | 1.581 | G | M | 4 | 16 | 186A3.000 | (+)COP | 81341 |
| 1.9 JTD | 88 | 04/02 → 06/10 | 1.910 | D | M | 4 | 8 | 186A9.000 | | 81352 |
| 1.9 JTD 105 | 77 | 04/99 → 06/10 | 1.910 | D | M | 4 | 8 | 182B4.000 | | 81352 |
| 1.9 JTD 110 | 81 | 03/01 → 07/02 | 1.910 | D | M | 4 | 8 | 186A6.000 | | 81352 |
| 1.9 JTD 115 | 85 | 07/02 → 06/10 | 1.910 | D | M | 4 | 8 | 186A8.000 | | 81352 |

Palio I, Weekend

| | | | | | | | | | | |
|----------|----|---------------|-------|---|---|---|----|---------------------------------|-----------------------|-------|
| 1.2 | 44 | 07/97 → 08/02 | 1.242 | B | M | 4 | 8 | 178B7.045, 178C4.066, 188A4.000 | MAGMA | 81370 |
| | 50 | 06/99 → 10/00 | 1.242 | B | M | 4 | 8 | 178E2.000 | → M: 9.042.882 | 81801 |
| | 50 | 06/99 → 10/00 | 1.242 | B | M | 4 | 8 | 178E2.000 | M →: 9.042.883, MAGMA | 81370 |
| | 50 | 06/99 → 10/02 | 1.242 | B | M | 4 | 8 | 178E2.000 | MAGMA | 81370 |
| | 52 | 06/04 → | 1.242 | B | M | 4 | 8 | 178E9.011 | MAGMA | 81370 |
| | 54 | 06/98 → | 1.242 | B | M | 4 | 8 | 176A8.000, 178B5.000, 178E2.000 | → M: 9.042.882 | 81801 |
| | 54 | 06/98 → | 1.242 | B | M | 4 | 8 | 176A8.000, 178B5.000, 178E2.000 | M →: 9.042.883, MAGMA | 81370 |
| | 59 | 09/01 → | 1.242 | B | M | 4 | 16 | 188A5.000 | PIERBURG | 81369 |
| | 44 | 02/01 → | 1.242 | B | M | 4 | 8 | 178C4.066, 188A4.000 | M →: 9.042.883, MAGMA | 81370 |
| | 54 | 04/96 → 02/01 | 1.242 | B | M | 4 | 8 | 178B5.000 | → M: 9.042.882 | 81801 |
| | 54 | 04/96 → 02/01 | 1.242 | B | M | 4 | 8 | 178B5.000 | M →: 9.042.883, MAGMA | 81370 |
| 1.2 Flex | 44 | 07/97 → 08/02 | 1.242 | | M | 4 | 8 | 188A4.000 | MAGMA | 81370 |
| 1.2 LPG | 44 | 07/97 → 08/02 | 1.242 | | M | 4 | 8 | 188A4.000 | MAGMA | 81370 |
| 1.4 | 51 | 04/96 → | 1.372 | B | M | 4 | 8 | 178B2.000 | (-)COP, (-)SS | 81366 |
| | 51 | 04/96 → | 1.372 | B | M | 4 | 8 | 178B2.000 | (-)COP, (+)AC | 81339 |
| | 51 | 04/96 → | 1.372 | B | M | 4 | 8 | 178B2.000 | (+)COP, (-)SS | 81343 |
| | 51 | 04/96 → | 1.372 | B | M | 4 | 8 | 178B2.000 | (+)COP, (+)AC | 81303 |

KW

cm³

NO. OF VALVES

FIAT
Palio I, Weekend

| | | | | | | | | | | |
|---------------------|----|---------------|-------|---|---|---|----|----------------------|--------------------------------------|-------|
| 1.4 Cat. | 51 | 04/96 → | 1.372 | B | M | 4 | 8 | 178B2.016 | (-)COP, (-)SS | 81366 |
| | 51 | 04/96 → | 1.372 | B | M | 4 | 8 | 178B2.016 | (-)COP, (+)AC | 81339 |
| | 51 | 04/96 → | 1.372 | B | M | 4 | 8 | 178B2.016 | (+)COP, (-)SS | 81343 |
| | 51 | 04/96 → | 1.372 | B | M | 4 | 8 | 178B2.016 | (+)COP, (+)AC | 81303 |
| 1.5 | 62 | 02/02 → | 1.461 | B | M | 4 | 8 | 178E5.022 | (-)COP | 81364 |
| | 62 | 02/02 → | 1.461 | B | M | 4 | 8 | 178E5.022 | (+)COP | 81341 |
| 1.6 | 68 | 07/97 → 10/03 | 1.581 | B | M | 4 | 16 | 178C7.098, 178D2.011 | (-)COP | 81364 |
| | 68 | 07/97 → 10/03 | 1.581 | B | M | 4 | 16 | 178C7.098, 178D2.011 | (+)COP | 81341 |
| 1.6 16V | 74 | 04/96 → | 1.581 | B | M | 4 | 16 | 178B3.000 | (-)COP | 81364 |
| | 74 | 04/96 → | 1.581 | B | M | 4 | 16 | 178B3.000 | (+)COP | 81341 |
| | 74 | 04/96 → 02/01 | 1.581 | B | M | 4 | 16 | 178B3.000 | (-)COP, 07-1997 → | 81364 |
| | 74 | 04/96 → 02/01 | 1.581 | B | M | 4 | 16 | 178B3.000 | (+)COP, 07-1997 → | 81341 |
| | 76 | 02/01 → | 1.596 | B | M | 4 | 16 | 182B6.000 | (-)COP | 81364 |
| | 76 | 02/01 → | 1.596 | B | M | 4 | 16 | 182B6.000 | (+)COP | 81341 |
| 1.7 TD | 51 | 04/96 → 03/01 | 1.698 | D | M | 4 | 8 | 176A3.000 | (-)COP, → 09-1999, → M: 2.427.906 | 81365 |
| | 51 | 04/96 → 03/01 | 1.698 | D | M | 4 | 8 | 176A3.000 | (+)COP, → 09-1999, → M: 2.427.906 | 81304 |
| | 51 | 04/96 → 03/01 | 1.698 | D | M | 4 | 8 | 176A3.000 | 10-1999 →, M →: 2.427.907 | 82086 |
| 1.9 D | 46 | 03/01 → | 1.910 | D | M | 4 | 8 | 223A6.000 | | 81352 |
| 1.9 JTD | 59 | 09/01 → | 1.910 | D | M | 4 | 8 | 188A2.000 | | 81352 |
| Panda I, Van | | | | | | | | | | |
| 1.1 | 37 | 05/91 → 03/95 | 1.108 | B | M | 4 | 8 | 156C.046 | | 81801 |
| | 40 | 09/00 → 02/04 | 1.108 | B | M | 4 | 8 | 187A1.000 | → M: 2.533.528, MAGMA | 81370 |
| | 40 | 09/00 → 02/04 | 1.108 | B | M | 4 | 8 | 187A1.000 | M →: 2.533.529, PIERBURG | 81369 |
| 1000 | 32 | 01/86 → 04/92 | 999 | B | M | 4 | 8 | 156A2.100 | | 81801 |
| | 32 | 01/86 → 02/92 | 999 | B | M | 4 | 8 | 156A2.100, 156A3.100 | | 81801 |
| | 37 | 01/85 → 12/92 | 999 | B | M | 4 | 8 | 156A3.000 | | 81801 |
| 1000 4x4 | 33 | 05/86 → 12/94 | 999 | B | M | 4 | 8 | 141C2.000, 156A2.246 | | 81801 |
| | 37 | 01/86 → 12/92 | 999 | B | M | 4 | 8 | 156A3.000 | | 81801 |
| 1000 i.e | 33 | 08/92 → 02/04 | 999 | B | M | 4 | 8 | 156A2.246 | | 81801 |
| 1000 i.e. Cat. | 33 | 10/87 → 08/98 | 999 | B | M | 4 | 8 | 141C2.000, 156A2.246 | | 81801 |
| 1100 | 37 | 05/91 → 12/99 | 1.108 | B | M | 4 | 8 | 156C.046 | | 81801 |
| | 40 | 02/95 → 09/03 | 1.108 | B | M | 4 | 8 | 176B2.000, 187A1.000 | | 81801 |
| 1100 4x4 | 40 | 02/95 → 07/04 | 1.108 | B | M | 4 | 8 | 176B2.000 | | 81801 |
| 1100 Trekking 4x4 | 37 | 10/91 → 07/04 | 1.108 | B | M | 4 | 8 | 156C.046 | | 81801 |
| 1300 D | 27 | 04/86 → 12/92 | 1.302 | D | M | 4 | 8 | 156A5.000 | | 81434 |
| 650 | 22 | 01/82 → 07/04 | 652 | B | M | 2 | 4 | 141A.000 | | 81415 |

KW

cm³

NO. OF VALVES

FIAT
Panda I, Van

| | | | | | | | | | | |
|-----|----|---------------|-----|---|---|---|---|--------------------------------|-----------|-------|
| 750 | 25 | 01/86 → 07/92 | 764 | B | M | 4 | 8 | 141B.000 | | 81458 |
| | 25 | 01/86 → 01/95 | 770 | B | M | 4 | 8 | 141B.000 | | 81458 |
| | 25 | 01/86 → 10/03 | 770 | B | M | 4 | 8 | 141B.000, 156A4.000, 156A4.048 | | 81801 |
| 900 | 29 | 04/92 → 12/96 | 899 | B | M | 4 | 8 | 1170A1.046 | | 81300 |
| | 33 | 10/80 → 06/94 | 903 | B | M | 4 | 8 | 100GL3.000, 146A.000 | → 12-1991 | 81415 |
| | 33 | 10/80 → 06/94 | 903 | B | M | 4 | 8 | 100GL3.000, 146A.000 | 01-1992 → | 81300 |

Panda II, Van

| | | | | | | | | | | |
|-------------------|----|---------------|-------|---|---|---|----|----------------------|--------------------------|-------|
| 1.1 | 40 | 09/03 → | 1.108 | B | M | 4 | 8 | 187A1.000 | → M: 2.533.528, MAGMA | 81370 |
| | 40 | 09/03 → | 1.108 | B | M | 4 | 8 | 187A1.000 | M →: 2.533.529, PIERBURG | 81369 |
| | 40 | 09/04 → | 1.108 | B | M | 4 | 8 | 187A1.000 | MAGMA | 81370 |
| | 40 | 09/04 → | 1.108 | B | M | 4 | 8 | 187A1.000 | PIERBURG | 81369 |
| 1.2 | 44 | 09/03 → | 1.242 | B | M | 4 | 8 | 188A4.000 | → M: 2.533.528, MAGMA | 81370 |
| | 44 | 09/03 → | 1.242 | B | M | 4 | 8 | 188A4.000 | M →: 2.533.529, PIERBURG | 81369 |
| | 44 | 09/03 → | 1.242 | B | M | 4 | 8 | 188A4.000 | TESMA | 82070 |
| | 44 | 09/04 → | 1.242 | B | M | 4 | 8 | 188A4.000 | → M: 2533528, MAGMA | 81370 |
| | 44 | 09/04 → | 1.242 | B | M | 4 | 8 | 188A4.000 | M →: 2533529, PIERBURG | 81369 |
| | 51 | 03/10 → | 1.242 | B | M | 4 | 8 | 169A4.000 | TESMA | 82070 |
| 1.2 4x4 | 44 | 09/04 → | 1.242 | B | M | 4 | 8 | 188A4.000 | → M: 2533528, MAGMA | 81370 |
| | 44 | 09/04 → | 1.242 | B | M | 4 | 8 | 188A4.000 | M →: 2533529, PIERBURG | 81369 |
| | 44 | 10/04 → | 1.242 | B | M | 4 | 8 | 188A4.000 | → M: 2.533.528, MAGMA | 81370 |
| | 44 | 10/04 → | 1.242 | B | M | 4 | 8 | 188A4.000 | M →: 2.533.529, PIERBURG | 81369 |
| | 44 | 10/04 → | 1.242 | B | M | 4 | 8 | 188A4.000 | TESMA | 82070 |
| | 51 | 11/09 → | 1.242 | B | M | 4 | 8 | 169A4.000 | TESMA | 82070 |
| 1.2 LPG | 44 | 04/09 → | 1.242 | | M | 4 | 8 | 188A4.000 | PIERBURG | 81369 |
| | 44 | 04/09 → | 1.242 | | M | 4 | 8 | 188A4.000 | TESMA | 82070 |
| | 51 | 11/10 → | 1.242 | | M | 4 | 8 | 169A4.000 | TESMA | 82070 |
| 1.2 Natural Power | 44 | 01/07 → 11/09 | 1.242 | | M | 4 | 8 | 188A4.000 | PIERBURG | 81369 |
| | 44 | 01/07 → 11/09 | 1.242 | | M | 4 | 8 | 188A4.000 | TESMA | 82070 |
| 1.3 D Multijet | 51 | 09/03 → | 1.248 | D | M | 4 | 16 | 188A8.000, 188A9.000 | | 81862 |
| | 55 | 01/06 → | 1.248 | D | M | 4 | 16 | 169A1.000 | | 81862 |
| | 55 | 06/06 → | 1.248 | D | M | 4 | 16 | 169A1.000, 169A5.000 | | 81862 |

KW

cm³

NO. OF VALVES

FIAT
Panda II, Van

| | | | | | | | | | | |
|--------------------|----|---------|-------|---|---|---|----|----------------------|----------|-------|
| 1.3 D Multijet 4x4 | 51 | 10/04 → | 1.248 | D | M | 4 | 16 | 188A8.000, 188A9.000 | | 81862 |
| | 55 | 01/06 → | 1.248 | D | M | 4 | 16 | 169A1.000 | | 81862 |
| | 55 | 09/10 → | 1.248 | D | M | 4 | 16 | 169A1.000, 169A5.000 | | 81862 |
| 1.4 | 74 | 10/06 → | 1.368 | B | M | 4 | 16 | 169A3.000 | PIERBURG | 81369 |
| | 74 | 10/06 → | 1.368 | B | M | 4 | 16 | 169A3.000 | TESMA | 82070 |
| 1.4 Natural Power | 51 | 01/10 → | 1.368 | | M | 4 | 8 | 350A1.000 | TESMA | 82070 |
| | 57 | 09/10 → | 1.368 | | M | 4 | 8 | 350A1.000 | TESMA | 82070 |

Panda III, Van

| | | | | | | | | | | |
|--------------------|----|---------|-------|---|---|---|----|---------------------------------|----------|-------|
| 0.9 | 57 | 02/12 → | 875 | B | M | 2 | 8 | 312A2.000, 312A7.000 | | 84008 |
| | 59 | 12/13 → | 875 | B | M | 2 | 8 | 312A5.000 | | 84008 |
| | 63 | 02/12 → | 875 | B | M | 2 | 8 | 312A2.000 | | 84008 |
| | 44 | 12/13 → | 964 | B | M | 2 | 8 | 312A4.000, 312A6.000 | | 84008 |
| | 48 | 02/12 → | 964 | B | M | 2 | 8 | 312A4.000 | | 84008 |
| 0.9 4x4 | 63 | 09/12 → | 875 | B | M | 2 | 8 | 312A2.000 | | 84008 |
| | 66 | 06/14 → | 875 | B | M | 2 | 8 | 312A7.000 | | 84008 |
| 0.9 Natural Power | 59 | 01/15 → | 875 | | M | 2 | 8 | 312A2.000 | | 84008 |
| | 63 | 07/12 → | 875 | | M | 2 | 8 | 312A2.000 | | 84008 |
| 1.2 | 51 | 02/12 → | 1.242 | B | M | 4 | 8 | 169A4.000 | TESMA | 82070 |
| 1.2 LPG | 51 | 06/12 → | 1.242 | | M | 4 | 8 | 169A4.000 | TESMA | 82070 |
| 1.3 D Multijet | 55 | 02/12 → | 1.248 | D | M | 4 | 16 | 199A1.000, 199A9.000 | | 81862 |
| | 70 | 04/15 → | 1.248 | D | M | 4 | 16 | 199B1.000, 312B1.000, 330A1.000 | | 81862 |
| 1.3 D Multijet 4x4 | 55 | 06/12 → | 1.248 | D | M | 4 | 16 | 199A1.000, 199A9.000 | | 81862 |
| | 59 | 06/14 → | 1.248 | D | M | 4 | 16 | 225A2.000, 312A8.000, 312B2.000 | | 81862 |
| | 70 | 04/15 → | 1.248 | D | M | 4 | 16 | 199B1.000, 312B1.000, 330A1.000 | | 81862 |
| 1.2 | 51 | 02/12 → | 1.242 | B | M | 4 | 8 | 169A4.000 | PIERBURG | 81369 |
| 1.2 LPG | 51 | 06/12 → | 1.242 | | M | 4 | 8 | 169A4.000 | PIERBURG | 81369 |

Punto Evo, Van

| | | | | | | | | | | |
|-------------------|----|---------------|-------|---|---|---|----|----------------------|-------|-------|
| 1.2 | 48 | 10/09 → 02/12 | 1.242 | B | M | 4 | 8 | 199A4.000 | TESMA | 82070 |
| | 51 | 10/09 → 02/12 | 1.242 | B | M | 4 | 8 | 169A4.000 | TESMA | 82070 |
| 1.3 D Multijet | 51 | 07/08 → 02/12 | 1.248 | D | M | 4 | 16 | 199B2.000 | | 81862 |
| | 55 | 10/09 → 02/12 | 1.248 | D | M | 4 | 16 | 199A2.000, 199A9.000 | | 81862 |
| | 62 | 10/09 → 02/12 | 1.248 | D | M | 4 | 16 | 199B4.000, 223A9.000 | | 81862 |
| | 66 | 10/09 → 02/12 | 1.248 | D | M | 4 | 16 | 199A3.000 | | 81862 |
| | 70 | 10/09 → 02/12 | 1.248 | D | M | 4 | 16 | 199B1.000 | | 81862 |
| 1.4 | 55 | 07/09 → 02/12 | 1.368 | B | M | 4 | 8 | 199A7.000 | TESMA | 82070 |
| | 57 | 10/09 → 02/12 | 1.368 | B | M | 4 | 8 | 350A1.000 | TESMA | 82070 |
| 1.4 16V | 77 | 10/09 → 02/12 | 1.368 | B | M | 4 | 16 | 955A6.000 | TESMA | 82070 |
| | 99 | 10/09 → 02/12 | 1.368 | B | M | 4 | 16 | 955A2.000 | TESMA | 82070 |
| 1.4 LPG | 57 | 06/09 → 02/12 | 1.368 | | M | 4 | 8 | 350A1.000 | TESMA | 82070 |
| 1.4 Natural Power | 57 | 10/09 → 02/12 | 1.368 | | M | 4 | 8 | 350A1.000 | TESMA | 82070 |
| 1.6 D Multijet | 88 | 10/09 → 02/12 | 1.598 | D | M | 4 | 16 | 955A3.000 | | 81872 |

KW

cm³

NO. OF VALVES

MAGNETI MARELLI
FIAT
Punto I, Cabrio, Van

| | | | | | | | | | | |
|--------------|----|---------------|-------|---|---|---|----|----------------------|-------------------|-------|
| 55 1.1 | 40 | 09/93 → 09/99 | 1.108 | B | M | 4 | 8 | 176A6.000, 176B2.000 | | 81801 |
| 60 1.2 | 43 | 04/94 → 06/00 | 1.242 | B | M | 4 | 8 | 176A7.000 | | 81801 |
| | 44 | 05/95 → 06/00 | 1.242 | B | M | 4 | 8 | 176B1.000, 176B4.000 | | 81801 |
| 75 1.2 | 54 | 10/93 → 09/99 | 1.242 | B | M | 4 | 8 | 176A8.000 | | 81801 |
| 85 16V 1.2 | 63 | 04/97 → 06/00 | 1.242 | B | M | 4 | 16 | 176B9.000 | PIERBURG | 81369 |
| 90 1.6 | 65 | 04/94 → 04/97 | 1.581 | B | M | 4 | 8 | 176A9.000 | (-)COP, 10-1993 → | 81339 |
| | 65 | 04/94 → 04/97 | 1.581 | B | M | 4 | 8 | 176A9.000 | (+)COP | 81303 |
| 1.1 | 40 | 04/96 → 02/00 | 1.108 | B | M | 4 | 8 | 176B2.000 | | 81801 |
| 1.2 16V | 63 | 04/97 → 09/99 | 1.242 | B | M | 4 | 16 | 176B9.000 | PIERBURG | 81369 |
| 1.4 GT Turbo | 96 | 09/96 → 09/99 | 1.372 | B | M | 4 | 8 | 176B6.000 | (-)COP | 81339 |
| | 96 | 09/96 → 09/99 | 1.372 | B | M | 4 | 8 | 176B6.000 | (+)COP | 81303 |
| | 98 | 01/94 → 09/96 | 1.372 | B | M | 4 | 8 | 176A4.000 | (-)COP | 81339 |
| | 98 | 01/94 → 09/96 | 1.372 | B | M | 4 | 8 | 176A4.000 | (+)COP | 81303 |
| 1.6 | 65 | 01/94 → 04/97 | 1.581 | B | M | 4 | 8 | 176A9.000 | (-)COP | 81339 |
| | 65 | 01/94 → 04/97 | 1.581 | B | M | 4 | 8 | 176A9.000 | (+)COP | 81303 |
| 1.7 D | 42 | 04/96 → 02/00 | 1.698 | D | M | 4 | 8 | 176B3.000 | (-)COP | 81365 |
| | 42 | 04/96 → 02/00 | 1.698 | D | M | 4 | 8 | 176B3.000 | (+)COP | 81304 |
| 1.7 TD | 46 | 09/96 → 09/99 | 1.698 | D | M | 4 | 8 | 176B7.000 | (+)COP | 81304 |
| | 52 | 04/96 → 02/00 | 1.698 | D | M | 4 | 8 | 176A5.000 | (-)COP | 81365 |
| | 52 | 04/96 → 02/00 | 1.698 | D | M | 4 | 8 | 176A5.000 | (+)COP | 81304 |
| 1.7 TD | 46 | 09/96 → 09/99 | 1.698 | D | M | 4 | 8 | 176B7.000 | | 82086 |
| | 51 | 01/94 → 09/99 | 1.698 | D | M | 4 | 8 | 176A3.000 | (-)COP, → 08-1996 | 81365 |
| | 51 | 01/94 → 09/99 | 1.698 | D | M | 4 | 8 | 176A3.000 | (+)COP, → 08-1996 | 81304 |
| | 51 | 01/94 → 09/99 | 1.698 | D | M | 4 | 8 | 176A3.000 | 08-1996 → | 82086 |
| | 52 | 01/94 → 09/99 | 1.698 | D | M | 4 | 8 | 176A5.000 | (-)COP, → 08-1996 | 81365 |
| | 52 | 01/94 → 09/99 | 1.698 | D | M | 4 | 8 | 176A5.000 | (+)COP, → 08-1996 | 81304 |
| | 52 | 01/94 → 09/99 | 1.698 | D | M | 4 | 8 | 176A5.000 | 08-1996 → | 82086 |

Punto II, Cabrio, Van

| | | | | | | | | | | |
|-------------------|----|---------------|-------|----|---|---|----|-----------|------------------------|-------|
| 1.2 16V 80 | 59 | 09/99 → | 1.242 | B | M | 4 | 16 | 188A5.000 | PIERBURG | 81369 |
| 1.2 60 | 44 | 02/00 → 10/09 | 1.242 | B | M | 4 | 8 | 188A4.000 | MAGMA | 81370 |
| | 44 | 09/99 → | 1.242 | B | M | 4 | 8 | 188A4.000 | MAGMA | 81370 |
| 1.2 Bifuel | 44 | 08/07 → | 1.242 | BF | M | 4 | 8 | 188A4.000 | PIERBURG | 81369 |
| | 44 | 08/07 → | 1.242 | BF | M | 4 | 8 | 188A4.000 | TESMA | 82070 |
| 1.2 Natural Power | 44 | 09/03 → | 1.242 | | M | 4 | 8 | 188A4.000 | → M: 2533528, MAGMA | 81370 |
| | 44 | 09/03 → | 1.242 | | M | 4 | 8 | 188A4.000 | M →: 2533529, PIERBURG | 81369 |
| | 44 | 09/03 → | 1.242 | | M | 4 | 8 | 188A4.000 | M →: 2533529, TESMA | 82070 |
| 1.3 D Multijet | 55 | 02/05 → 10/09 | 1.248 | D | M | 4 | 16 | 188A9.000 | | 81862 |
| 1.3 JTD | 51 | 06/03 → 10/05 | 1.248 | D | M | 4 | 16 | 188A9.000 | | 81862 |
| 1.3 JTD 16V | 51 | 06/03 → | 1.248 | D | M | 4 | 16 | 188A9.000 | | 81862 |

KW

cm³

NO. OF VALVES

FIAT
Punto II, Cabrio, Van

| | | | | | | | | | | |
|-------------|----|---------------|-------|---|---|---|----|----------------------|-----------------------------|-------|
| 1.4 | 70 | 09/03 → | 1.368 | B | M | 4 | 16 | 843A1.000 | PIERBURG | 81369 |
| | 71 | 11/05 → | 1.368 | B | M | 4 | 16 | 199A6.000 | PIERBURG | 81369 |
| | 71 | 11/05 → | 1.368 | B | M | 4 | 16 | 199A6.000 | TESMA | 82070 |
| 1.8 130 HGT | 96 | 09/99 → | 1.747 | B | M | 4 | 16 | 183A1.000, 188A6.000 | → 08-2000, M: 183 A1.000 | 81331 |
| | 96 | 09/99 → | 1.747 | B | M | 4 | 16 | 183A1.000, 188A6.000 | 09-2000 →, M: 188 A6.000 | 81348 |
| 1.9 D 60 | 44 | 02/00 → 10/09 | 1.910 | D | M | 4 | 8 | 188A3.000 | | 81352 |
| 1.9 DS 60 | 44 | 09/99 → | 1.910 | D | M | 4 | 8 | 188A3.000 | | 81352 |
| 1.9 JTD | 63 | 10/01 → | 1.910 | D | M | 4 | 8 | 188A7.000 | | 81352 |
| | 74 | 06/03 → | 1.910 | D | M | 4 | 8 | 188B2.000 | | 81352 |
| 1.9 JTD 80 | 59 | 09/99 → | 1.910 | D | M | 4 | 8 | 188A2.000 | | 81352 |

Punto III, Van

| | | | | | | | | | | |
|---------------------|----|---------------|-------|----|---|---|----|----------------------|----------|-------|
| 0.9 | 74 | 12/13 → | 875 | B | M | 2 | 8 | 199B6.000 | | 84008 |
| | 77 | 07/13 → | 875 | B | M | 2 | 8 | 199B6.000 | | 84008 |
| 0.9 Bifuel | 63 | 03/12 → | 875 | BF | M | 2 | 8 | 312A2.000 | | 84008 |
| 0.9 Twinair Turbo | 63 | 03/12 → | 875 | B | M | 2 | 8 | 312A2.000 | | 84008 |
| 1.2 | 49 | 02/14 → | 1.242 | B | M | 4 | 8 | 199B9.000 | PIERBURG | 81369 |
| | 49 | 02/14 → | 1.242 | B | M | 4 | 8 | 199B9.000 | TESMA | 82070 |
| | 51 | 03/12 → | 1.242 | B | M | 4 | 8 | 169A4.000 | TESMA | 82070 |
| 1.3 D Multijet | 55 | 03/12 → | 1.248 | D | M | 4 | 16 | 199A2.000, 199A9.000 | | 81862 |
| | 59 | 12/13 → | 1.248 | D | M | 4 | 16 | 199B8.000 | | 81862 |
| | 62 | 03/12 → | 1.248 | D | M | 4 | 16 | 199B4.000 | | 81862 |
| | 66 | 01/10 → 02/12 | 1.248 | D | M | 4 | 16 | 199A3.000 | | 81862 |
| | 70 | 03/12 → | 1.248 | D | M | 4 | 16 | 199B1.000 | | 81862 |
| 1.4 | 55 | 03/12 → | 1.368 | B | M | 4 | 8 | 199A7.000 | TESMA | 82070 |
| | 57 | 03/12 → | 1.368 | B | M | 4 | 8 | 350A1.000 | TESMA | 82070 |
| 1.4 Bifuel | 57 | 03/12 → | 1.368 | BF | M | 4 | 8 | 350A1.000 | TESMA | 82070 |
| 1.4 LPG | 57 | 03/09 → | 1.368 | | M | 4 | 8 | 350A1.000 | TESMA | 82070 |
| 1.4 Multi Air | 77 | 03/12 → | 1.368 | B | M | 4 | 16 | 955A6.000 | TESMA | 82070 |
| 1.4 Natural Power | 57 | 03/12 → | 1.368 | | M | 4 | 8 | 350A1.000 | TESMA | 82070 |
| 1.4 Turbo Multi Air | 99 | 03/12 → | 1.368 | B | M | 4 | 16 | 955A2.000 | TESMA | 82070 |

Qubo

| | | | | | | | | | | |
|-------------------|----|---------|-------|---|---|---|----|----------------------|----------|-------|
| 1.3 D Multijet | 55 | 02/08 → | 1.248 | D | M | 4 | 16 | 199A2.000, 199A9.000 | | 81862 |
| | 70 | 07/10 → | 1.248 | D | M | 4 | 16 | 199B1.000 | | 81862 |
| 1.4 | 54 | 02/08 → | 1.360 | B | M | 4 | 8 | KFT, KFV | | 81797 |
| 1.4 Natural Power | 57 | 10/09 → | 1.368 | | M | 4 | 8 | 350A1.000 | PIERBURG | 81369 |
| | 57 | 10/09 → | 1.368 | | M | 4 | 8 | 350A1.000 | TESMA | 82070 |

Regata, Weekend

| | | | | | | | | | | |
|---------------|----|---------------|-------|---|---|---|---|----------------------|--|-------|
| 100 Super 1.6 | 74 | 10/83 → 12/90 | 1.585 | B | M | 4 | 8 | 149A2.000, 149A4.000 | | 81436 |
|---------------|----|---------------|-------|---|---|---|---|----------------------|--|-------|

KW

cm³

NO. OF VALVES

FIAT
Scudo I

| | | | | | | | | | | |
|-------------|-----|---------------|-------|---|---|---|----|-----------------------|--------|------------------|
| 1.6 | 58 | 02/96 → 12/06 | 1.581 | B | M | 4 | 8 | 220A2.000 | (-)COP | 81368 |
| | 58 | 02/96 → 12/06 | 1.581 | B | M | 4 | 8 | 220A2.000 | (+)COP | 81346 |
| 1.9 D | 51 | 04/98 → 12/06 | 1.868 | D | M | 4 | 8 | WJY (DW8B), WJZ (DW8) | | 81642 |
| | 51 | 04/98 → 12/06 | 1.868 | D | M | 4 | 8 | WJZ (DW8) | | 81642 |
| | 51 | 02/96 → 04/98 | 1.905 | D | M | 4 | 8 | D9B | | 81642 |
| 1.9 TD | 66 | 02/96 → 12/06 | 1.905 | D | M | 4 | 8 | DHX (XUD9TF/L) | | 81642 |
| | 68 | 02/96 → 12/06 | 1.905 | D | M | 4 | 8 | D8B | | 81642 |
| 1.9 TD Eco | 66 | 02/96 → 12/06 | 1.905 | D | M | 4 | 8 | DHX (XUD9TF/L) | | 81642 |
| 2.0 | 100 | 05/00 → 12/06 | 1.997 | B | M | 4 | 16 | RFN (EW10J4) | (-)COP | 84038 NEW |
| | 100 | 05/00 → 12/06 | 1.997 | B | M | 4 | 16 | RFN (EW10J4) | (+)COP | 82089 |
| | 100 | 05/00 → 12/06 | 1.997 | B | M | 4 | 16 | RFN (EW10J4) | | 82089 |
| | 100 | 05/00 → 12/06 | 1.997 | B | M | 4 | 16 | RFN (EW10J4) | | 81799 |
| 2.0 16V | 100 | 06/00 → 12/06 | 1.997 | B | M | 4 | 16 | RFN (EW10J4) | (-)COP | 84038 NEW |
| | 100 | 06/00 → 12/06 | 1.997 | B | M | 4 | 16 | RFN (EW10J4) | (+)COP | 82089 |
| | 100 | 06/00 → 12/06 | 1.997 | B | M | 4 | 16 | RFN (EW10J4) | | 82089 |
| | 100 | 06/00 → 12/06 | 1.997 | B | M | 4 | 16 | RFN (EW10J4) | | 81799 |
| 2.0 JTD | 69 | 01/04 → 12/06 | 1.997 | D | M | 4 | 8 | RHX | | 81713 |
| | 80 | 12/99 → 12/06 | 1.997 | D | M | 4 | 8 | RHZ | | 81713 |
| 2.0 JTD 16V | 80 | 05/99 → 12/06 | 1.997 | D | M | 4 | 16 | RHW (DW10ATED4) | | 81713 |

Scudo II

| | | | | | | | | | | |
|--------------------|-----|---------|-------|---|---|---|----|----------------|--|------------------|
| 1.6 D Multijet | 66 | 01/07 → | 1.560 | D | M | 4 | 16 | 9HU | | 81869 |
| 2.0 D Multijet | 88 | 01/07 → | 1.997 | D | M | 4 | 16 | RHK | | 81800 |
| | 94 | 04/11 → | 1.997 | D | M | 4 | 16 | RH02 | | 84020 NEW |
| | 100 | 01/07 → | 1.997 | D | M | 4 | 16 | DW10BTED4, RHR | | 81800 |
| | 100 | 01/07 → | 1.997 | D | M | 4 | 16 | RHR | | 81800 |
| | 120 | 07/10 → | 1.997 | D | M | 4 | 16 | RH02, RHH | | 84020 NEW |
| 2.0 D Multijet 4x4 | 88 | 01/07 → | 1.997 | D | M | 4 | 16 | RHK | | 81800 |
| | 94 | 04/11 → | 1.997 | D | M | 4 | 16 | RH02 | | 84020 NEW |

Sedici

| | | | | | | | | | | |
|--------------------|----|---------|-------|---|---|---|----|-------|--|-------|
| 1.6 16V | 79 | 06/06 → | 1.586 | B | M | 4 | 16 | M16A | | 82026 |
| | 88 | 06/06 → | 1.586 | B | M | 4 | 16 | M16A | | 82026 |
| 1.6 16V 4x4 | 79 | 06/06 → | 1.586 | B | M | 4 | 16 | M16A | | 82026 |
| | 88 | 06/06 → | 1.586 | B | M | 4 | 16 | M16A | | 82026 |
| 1.9 D Multijet | 88 | 06/06 → | 1.910 | D | M | 4 | 8 | D19AA | | 81352 |
| 1.9 D Multijet 4x4 | 88 | 06/06 → | 1.910 | D | M | 4 | 8 | D19AA | | 81352 |
| 2.0 D Multijet | 99 | 06/06 → | 1.956 | D | M | 4 | 16 | D20AA | | 81872 |
| 2.0 D Multijet 4x4 | 99 | 06/06 → | 1.956 | D | M | 4 | 16 | D20AA | | 81872 |

Seicento, Van

| | | | | | | | | | | |
|-----|----|---------------|-----|---|---|---|---|------------|--|-------|
| 0.9 | 29 | 01/98 → 01/10 | 899 | B | M | 4 | 8 | 1170A1.046 | | 81300 |
|-----|----|---------------|-----|---|---|---|---|------------|--|-------|

KW

cm³

NO. OF VALVES

FIAT
Seicento, Van

| | | | | | | | | | | |
|-----|----|---------------|-------|---|---|---|---|----------------------|--|-------|
| 1.1 | 40 | 01/98 → 01/10 | 1.108 | B | M | 4 | 8 | 176B2.000 | → 04-1999, → M: 9.042.882 | 81801 |
| | 40 | 01/98 → 01/10 | 1.108 | B | M | 4 | 8 | 176B2.000 | 05-1999 →, M →: 9.042.883, MAGMA | 81370 |
| | 40 | 01/98 → 01/10 | 1.108 | B | M | 4 | 8 | 176B2.000, 187A1.000 | → 04-1999, → M: 9.042.882 | 81801 |
| | 40 | 01/98 → 01/10 | 1.108 | B | M | 4 | 8 | 176B2.000, 187A1.000 | 05-1999 →, M →: 9.042.883, MAGMA | 81370 |

Siena I

| | | | | | | | | | | |
|-------------|----|---------------|-------|----|---|---|----|----------------------|----------------------|-------|
| 1.2 | 44 | 09/01 → 12/09 | 1.242 | B | M | 4 | 8 | 178C4.066, 188A4.000 | MAGMA | 81370 |
| | 54 | 09/98 → 12/09 | 1.242 | B | M | 4 | 8 | 178B5.000 | → 06-1999 | 81801 |
| | 54 | 09/98 → 12/09 | 1.242 | B | M | 4 | 8 | 178B5.000 | 07-1999 →, MAGMA | 81370 |
| | 59 | 09/01 → 12/09 | 1.242 | B | M | 4 | 16 | 188A5.000 | PIERBURG | 81369 |
| 1.2 Flex | 52 | 03/04 → 05/05 | 1.242 | | M | 4 | 8 | 178E9.011 | TESMA | 82070 |
| 1.3 JTD | 51 | 09/03 → 12/09 | 1.248 | D | M | 4 | 16 | 188A9.000 | | 81862 |
| 1.4 | 57 | 01/07 → 12/09 | 1.368 | B | M | 4 | 8 | 178F3.011, 350A1.000 | TESMA | 82070 |
| | 51 | 04/96 → 12/09 | 1.372 | B | M | 4 | 8 | 178B2.000 | (-)COP, (-)AC, (-)SS | 81366 |
| | 51 | 04/96 → 12/09 | 1.372 | B | M | 4 | 8 | 178B2.000 | (-)COP, (+)SS, (+)AC | 81339 |
| | 51 | 04/96 → 12/09 | 1.372 | B | M | 4 | 8 | 178B2.000 | (+)COP, (-)AC, (-)SS | 81343 |
| | 51 | 04/96 → 12/09 | 1.372 | B | M | 4 | 8 | 178B2.000 | (+)COP, (+)SS, (+)AC | 81303 |
| 1.4 Cat. | 51 | 04/96 → 12/09 | 1.372 | B | M | 4 | 8 | 178B2.016 | (-)COP, (-)AC, (-)SS | 81366 |
| | 51 | 04/96 → 12/09 | 1.372 | B | M | 4 | 8 | 178B2.016 | (-)COP, (+)SS, (+)AC | 81339 |
| | 51 | 04/96 → 12/09 | 1.372 | B | M | 4 | 8 | 178B2.016 | (+)COP, (-)AC, (-)SS | 81343 |
| | 51 | 04/96 → 12/09 | 1.372 | B | M | 4 | 8 | 178B2.016 | (+)COP, (+)SS, (+)AC | 81303 |
| 1.5 Bipower | 57 | 09/03 → 12/05 | 1.498 | BF | M | 4 | 8 | 178A6.011 | (-)COP | 81364 |
| | 57 | 09/03 → 12/05 | 1.498 | BF | M | 4 | 8 | 178A6.011 | (+)COP | 81341 |
| 1.6 | 76 | 11/00 → 12/09 | 1.596 | B | M | 4 | 16 | 182B6.000 | (-)COP | 81364 |
| | 76 | 11/00 → 12/09 | 1.596 | B | M | 4 | 16 | 182B6.000 | (+)COP | 81341 |
| 1.6 16V | 78 | 09/98 → 12/09 | 1.581 | B | M | 4 | 16 | 178B3.000 | (-)COP | 81364 |
| | 78 | 09/98 → 12/09 | 1.581 | B | M | 4 | 16 | 178B3.000 | (+)COP | 81341 |
| 1.7 TD | 51 | 02/06 → 12/09 | 1.697 | D | M | 4 | 8 | 176A3.000 | | 82086 |
| 1.9 D | 46 | 11/00 → | 1.910 | D | M | 4 | 8 | 223A6.000 | | 81352 |

Siena II

| | | | | | | | | | | |
|---------|----|---------|-------|---|---|---|----|-----------|-------|-------|
| 1.3 JTD | 51 | 11/07 → | 1.248 | D | M | 4 | 16 | 188A9.000 | | 81862 |
| 1.4 | 57 | 11/07 → | 1.368 | B | M | 4 | 8 | 199A1.000 | TESMA | 82070 |

Stilo, Station Wagon

| | | | | | | | | | | |
|---------|----|---------------|-------|---|---|---|----|-----------|----------|-------|
| 1.2 16V | 59 | 02/02 → 11/06 | 1.242 | B | M | 4 | 16 | 188A5.000 | PIERBURG | 81369 |
| 1.4 16V | 66 | 03/05 → 11/06 | 1.368 | B | M | 4 | 16 | 192B2.000 | PIERBURG | 81369 |
| | 66 | 03/05 → 11/06 | 1.368 | B | M | 4 | 16 | 192B2.000 | TESMA | 82070 |
| | 70 | 01/04 → 11/06 | 1.368 | B | M | 4 | 16 | 843A1.000 | PIERBURG | 81369 |
| | 70 | 01/04 → 11/06 | 1.368 | B | M | 4 | 16 | 843A1.000 | TESMA | 82070 |

KW

cm³

NO. OF VALVES

FIAT
Stilo, Station Wagon

| | | | | | | | | | | |
|----------------|-----|---------------|-------|---|---|---|----|----------------------|--------|-------|
| 1.6 16V | 76 | 01/03 → 08/08 | 1.596 | B | M | 4 | 16 | 182B6.000 | (-)COP | 81364 |
| | 76 | 01/03 → 08/08 | 1.596 | B | M | 4 | 16 | 182B6.000 | (+)COP | 81341 |
| | 77 | 03/05 → 12/07 | 1.598 | B | M | 4 | 16 | 192B3.000 | | 82083 |
| | 77 | 05/05 → 11/06 | 1.598 | B | M | 4 | 16 | 192B3.000 | (-)COP | 81364 |
| | 77 | 05/05 → 11/06 | 1.598 | B | M | 4 | 16 | 192B3.000 | (+)COP | 81341 |
| | 76 | 10/01 → 11/06 | 1.596 | B | M | 4 | 16 | 182B6.000 | (-)COP | 81364 |
| | 76 | 10/01 → 11/06 | 1.596 | B | M | 4 | 16 | 182B6.000 | (+)COP | 81341 |
| 1.8 16V | 98 | 01/03 → 08/08 | 1.747 | B | M | 4 | 16 | 192A4.000 | | 81348 |
| | 98 | 10/01 → 11/06 | 1.747 | B | M | 4 | 16 | 192A4.000 | | 81348 |
| 1.9 D | 66 | 09/04 → 08/08 | 1.910 | D | M | 4 | 8 | 192B5.000 | | 81352 |
| 1.9 D Multijet | 74 | 09/05 → 11/06 | 1.910 | D | M | 4 | 8 | 192A9.000 | | 81352 |
| | 88 | 09/05 → 11/06 | 1.910 | D | M | 4 | 8 | 192A8.000 | | 81352 |
| | 110 | 09/05 → 11/06 | 1.910 | D | M | 4 | 16 | 937A5.000 | | 81872 |
| 1.9 JTD | 59 | 01/03 → 08/08 | 1.910 | D | M | 4 | 8 | 192A3.000 | | 81352 |
| | 85 | 01/03 → 08/08 | 1.910 | D | M | 4 | 8 | 192A1.000, 937A7.000 | | 81352 |
| | 93 | 09/03 → 11/06 | 1.910 | D | M | 4 | 16 | 937A4.000 | | 81872 |
| | 100 | 04/04 → 11/06 | 1.910 | D | M | 4 | 16 | 192B1.000 | | 81872 |
| | 103 | 01/04 → 11/06 | 1.910 | D | M | 4 | 16 | 192A5.000 | | 81872 |
| | 59 | 02/02 → 11/06 | 1.910 | D | M | 4 | 8 | 192A3.000 | | 81352 |
| | 66 | 09/04 → 11/06 | 1.910 | D | M | 4 | 8 | 192B5.000 | | 81352 |
| | 85 | 10/01 → 11/06 | 1.910 | D | M | 4 | 8 | 192A1.000, 937A7.000 | | 81352 |
| 2.4 20V | 125 | 10/01 → 11/06 | 2.446 | B | M | 5 | 20 | 192A2.000 | | 81329 |

Strada

| | | | | | | | | | | |
|----------------|----|---------|-------|---|---|---|----|-----------|---------------------------|-------|
| 1.2 | 44 | 04/03 → | 1.242 | B | M | 4 | 8 | 188A4.000 | MAGMA | 81370 |
| | 44 | 04/03 → | 1.242 | B | M | 4 | 8 | 188A4.000 | TESMA | 82070 |
| | 54 | 06/99 → | 1.242 | B | M | 4 | 8 | 178B5.000 | TESMA | 82070 |
| | 54 | 06/99 → | 1.242 | B | M | 4 | 8 | 178B5.000 | | 81801 |
| 1.3 D Multijet | 62 | 05/06 → | 1.248 | D | M | 4 | 16 | 223A9.000 | | 81862 |
| | 70 | 10/10 → | 1.248 | D | M | 4 | 16 | 199B1.000 | | 81862 |
| 1.7 TD | 51 | 06/99 → | 1.698 | D | M | 4 | 8 | 176A3.000 | (-)COP, → M: 2.427.906 | 81365 |
| | 51 | 06/99 → | 1.698 | D | M | 4 | 8 | 176A3.000 | (+)COP, → M: 2.427.906 | 81304 |
| | 51 | 06/99 → | 1.698 | D | M | 4 | 8 | 176A3.000 | M →: 2.427.907 | 82086 |
| 1.9 D | 46 | 12/00 → | 1.910 | D | M | 4 | 8 | 223A6.000 | | 81352 |
| 1.9 JTD | 59 | 04/03 → | 1.910 | D | M | 4 | 8 | 188A2.000 | | 81352 |

Talento

| | | | | | | | | | | |
|-------|----|---------------|-------|---|---|---|---|-----------|--|-------|
| 1.9 D | 52 | 03/89 → 03/94 | 1.929 | D | M | 4 | 8 | 149B1.000 | | 81489 |
| 2.0 | 55 | 03/89 → 03/94 | 1.971 | B | M | 4 | 8 | 170B | | 81367 |

KW

cm³

NO. OF VALVES

FIAT
Tempra, Station Wagon

| | | | | | | | | | | |
|----------|---------------|---------------|-------|---|---|---|-----------|------------------------------|--|--------------|
| 1.4 i.e. | 51 | 03/92 → 08/96 | 1.372 | B | M | 4 | 8 | 160A1.046, 836A4.000 | (-)COP, → M: 9.336.692, (+)AC | 81314 |
| | 51 | 03/92 → 08/96 | 1.372 | B | M | 4 | 8 | 160A1.046, 836A4.000 | (-)COP, 01-1993 →, M →: 9.336.693, (+)AC | 81339 |
| | 51 | 03/92 → 08/96 | 1.372 | B | M | 4 | 8 | 160A1.046, 836A4.000 | (-)COP, M →: 9.336.693, (-)SS | 81366 |
| | 51 | 03/92 → 08/96 | 1.372 | B | M | 4 | 8 | 160A1.046, 836A4.000 | (+)COP, → M: 9.336.692, (+)AC | 81476 |
| | 51 | 03/92 → 08/96 | 1.372 | B | M | 4 | 8 | 160A1.046, 836A4.000 | (+)COP, 01-1993 →, M →: 9.336.693, (+)AC | 81303 |
| | 51 | 03/92 → 08/96 | 1.372 | B | M | 4 | 8 | 160A1.046, 836A4.000 | (+)COP, M →: 9.336.693, (-)SS | 81343 |
| | 51 | 03/92 → 08/96 | 1.372 | B | M | 4 | 8 | 160A1.046, 836A4.000 | → 12-1992, → M: 9.336.692, (+)SS, (+)AC | 81333 |
| | 51 | 10/92 → 08/96 | 1.372 | B | M | 4 | 8 | 160A1.046, 836A4.000 | (-)COP, 01-1993 →, (+)AC | 81339 |
| | 51 | 10/92 → 08/96 | 1.372 | B | M | 4 | 8 | 160A1.046, 836A4.000 | (+)COP, 01-1993 →, (+)AC | 81303 |
| | 51 | 10/92 → 08/96 | 1.372 | B | M | 4 | 8 | 160A1.046, 836A4.000 | → 12-1992, → M: 9.336.692 | 81333 |
| | 57 | 03/91 → 08/96 | 1.372 | B | M | 4 | 8 | 159A2.000 | (-)COP, → M: 9.336.692, (+)AC | 81314 |
| | 57 | 03/91 → 08/96 | 1.372 | B | M | 4 | 8 | 159A2.000 | (-)COP, 01-1993 →, (+)AC | 81339 |
| | 57 | 03/91 → 08/96 | 1.372 | B | M | 4 | 8 | 159A2.000 | (-)COP, M →: 9.336.693, (-)SS | 81366 |
| | 57 | 03/91 → 08/96 | 1.372 | B | M | 4 | 8 | 159A2.000 | (+)COP, → M: 9.336.692, (+)AC | 81476 |
| | 57 | 03/91 → 08/96 | 1.372 | B | M | 4 | 8 | 159A2.000 | (+)COP, 01-1993 →, (+)AC | 81303 |
| | 57 | 03/91 → 08/96 | 1.372 | B | M | 4 | 8 | 159A2.000 | (+)COP, M →: 9.336.693, (-)SS | 81343 |
| 57 | 03/91 → 08/96 | 1.372 | B | M | 4 | 8 | 159A2.000 | → 12-1992, → M: 9.336.692 | 81333 | |



KW

cm³

NO. OF VALVES

FIAT
Tempra, Station Wagon

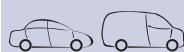
| | | | | | | | | | | |
|----------|---------------|---------------|-------|---|---|---|----------------------|----------------------|-----------------------------------|-------|
| 1.6 | 51 | 04/90 → 06/93 | 1.581 | B | M | 4 | 8 | 159A3.048 | (-)COP, (+)AC | 81314 |
| | 51 | 04/90 → 06/93 | 1.581 | B | M | 4 | 8 | 159A3.048 | (+)COP, (+)AC | 81476 |
| | 51 | 04/90 → 06/93 | 1.581 | B | M | 4 | 8 | 159A3.048 | (+)SS, (+)AC | 81333 |
| | 63 | 12/90 → 04/93 | 1.581 | B | M | 4 | 8 | 159A3.000 | (-)COP, (+)AC | 81314 |
| | 63 | 12/90 → 04/93 | 1.581 | B | M | 4 | 8 | 159A3.000 | (+)COP, (+)AC | 81476 |
| | 63 | 12/90 → 04/93 | 1.581 | B | M | 4 | 8 | 159A3.000 | (+)SS, (+)AC | 81333 |
| | 63 | 03/90 → 04/93 | 1.581 | B | M | 4 | 8 | 159A3.000, 159B9.000 | (-)COP, (+)AC | 81314 |
| | 63 | 03/90 → 04/93 | 1.581 | B | M | 4 | 8 | 159A3.000, 159B9.000 | (+)COP, (+)AC | 81476 |
| | 63 | 03/90 → 04/93 | 1.581 | B | M | 4 | 8 | 159A3.000, 159B9.000 | (+)SS, (+)AC | 81333 |
| 1.6 i.e. | 55 | 06/92 → 08/96 | 1.581 | B | M | 4 | 8 | 159A3.048, 835C1.000 | (-)COP, (+)AC | 81339 |
| | 55 | 06/92 → 08/96 | 1.581 | B | M | 4 | 8 | 159A3.048, 835C1.000 | (+)COP, (+)AC | 81303 |
| | 57 | 06/90 → 07/92 | 1.581 | B | M | 4 | 8 | 159A3.046 | (-)COP, (+)AC | 81314 |
| | 57 | 06/90 → 07/92 | 1.581 | B | M | 4 | 8 | 159A3.046 | (+)COP, (+)AC | 81476 |
| | 57 | 06/90 → 07/92 | 1.581 | B | M | 4 | 8 | 159A3.046 | (+)SS, (+)AC | 81333 |
| | 57 | 10/90 → 08/96 | 1.581 | B | M | 4 | 8 | 159A3.046, 835C1.000 | (-)COP, → 12-1992, (+)AC | 81314 |
| | 57 | 10/90 → 08/96 | 1.581 | B | M | 4 | 8 | 159A3.046, 835C1.000 | (-)COP, 01-1993 →, (+)AC | 81339 |
| | 57 | 10/90 → 08/96 | 1.581 | B | M | 4 | 8 | 159A3.046, 835C1.000 | (+)COP, → 12-1992, (+)AC | 81476 |
| | 57 | 10/90 → 08/96 | 1.581 | B | M | 4 | 8 | 159A3.046, 835C1.000 | (+)COP, 01-1993 →, (+)AC | 81303 |
| | 57 | 10/90 → 08/96 | 1.581 | B | M | 4 | 8 | 159A3.046, 835C1.000 | → 12-1992, (+)AC, (+)SS, (+)AC | 81333 |
| | 63 | 06/94 → 08/96 | 1.581 | B | M | 4 | 8 | 159B9.000 | (-)COP, (+)AC | 81339 |
| | 63 | 06/94 → 08/96 | 1.581 | B | M | 4 | 8 | 159B9.000 | (+)COP, (+)AC | 81303 |
| 1.8 i.e. | 66 | 06/94 → 08/96 | 1.581 | B | M | 4 | 8 | 159B9.000 | (-)COP, (+)AC | 81339 |
| | 66 | 06/94 → 08/96 | 1.581 | B | M | 4 | 8 | 159B9.000 | (+)COP, (+)AC | 81303 |
| | 66 | 09/93 → 08/96 | 1.756 | B | M | 4 | 8 | 835C4.000 | | 81315 |
| | 74 | 10/94 → 08/96 | 1.756 | B | M | 4 | 8 | 836A5.000 | 01-1992 →, → 07-1996 | 81315 |
| | 74 | 10/94 → 08/96 | 1.756 | B | M | 4 | 8 | 836A5.000 | | 81315 |
| | 76 | 09/93 → 08/96 | 1.756 | B | M | 4 | 8 | 835C2.000 | 01-1992 →, → 07-1996 | 81315 |
| | 76 | 09/93 → 08/96 | 1.756 | B | M | 4 | 8 | 835C2.000 | | 81315 |
| | 77 | 03/92 → 08/96 | 1.756 | B | M | 4 | 8 | 159A4.046 | 01-1992 →, → 07-1996 | 81315 |
| | 77 | 03/92 → 12/93 | 1.756 | B | M | 4 | 8 | 159A4.046 | | 81315 |
| 1.9 D | 81 | 03/90 → 08/96 | 1.756 | B | M | 4 | 8 | 159A4.000 | → 06-1992 | 81477 |
| | 81 | 03/90 → 08/96 | 1.756 | B | M | 4 | 8 | 159A4.000 | 07-1992 → | 81315 |
| | 48 | 07/91 → 08/96 | 1.929 | D | M | 4 | 8 | 149A1.000, 160A7.000 | (-)COP | 81363 |
| 48 | 07/91 → 08/96 | 1.929 | D | M | 4 | 8 | 149A1.000, 160A7.000 | (+)COP | 81347 | |

KW

cm³

NO. OF VALVES

FIAT
Tempra, Station Wagon

| | | | | | | | | | | |
|--------------|----|---------------|-------|---|---|---|---|----------------------|-------------------------------------|-------|
| 1.9 TD | 66 | 05/90 → 08/96 | 1.929 | D | M | 4 | 8 | 160A6.000, 160D1.000 | (-)COP, → M: 1.071.902, (+)AC | 81326 |
| | 66 | 05/90 → 08/96 | 1.929 | D | M | 4 | 8 | 160A6.000, 160D1.000 | (+)COP, → M: 1.071.902, (+)AC | 81464 |
| 2.0 i.e. | 83 | 10/90 → 08/96 | 1.995 | B | M | 4 | 8 | 159A6.046 | → 12-1991 | 81460 |
| | 83 | 10/90 → 08/96 | 1.995 | B | M | 4 | 8 | 159A6.046 | 01-1992 → | 81315 |
| 2.0 i.e. 4x4 | 83 | 03/92 → 03/95 | 1.995 | B | M | 4 | 8 | 159A6.046 | | 81315 |

Tipo I

| | | | | | | | | | | |
|--------------------|-----|---------------|-------|---|---|---|----|----------------------|-------------------|-------|
| 1.1 | 41 | 01/88 → 10/91 | 1.108 | B | M | 4 | 8 | 160A3.000 | | 81801 |
| 1.4 i.e. | 57 | 05/89 → 04/95 | 1.372 | B | M | 4 | 8 | 159A2.000 | (-)COP, (+)AC | 81314 |
| | 57 | 05/89 → 04/95 | 1.372 | B | M | 4 | 8 | 159A2.000 | (+)AC, (+)SS | 81333 |
| | 57 | 05/89 → 04/95 | 1.372 | B | M | 4 | 8 | 159A2.000 | (+)COP, (+)AC | 81476 |
| | 51 | 05/89 → 04/95 | 1.372 | B | M | 4 | 8 | 160A1.046, 836A4.000 | (-)COP, (+)AC | 81314 |
| | 51 | 05/89 → 04/95 | 1.372 | B | M | 4 | 8 | 160A1.046, 836A4.000 | (+)AC, (+)SS | 81333 |
| | 51 | 05/89 → 04/95 | 1.372 | B | M | 4 | 8 | 160A1.046, 836A4.000 | (+)COP, (+)AC | 81476 |
| 1.6 | 61 | 01/88 → 10/91 | 1.581 | B | M | 4 | 8 | 160A2.000 | (-)COP, (+)AC | 81314 |
| | 61 | 01/88 → 10/91 | 1.581 | B | M | 4 | 8 | 160A2.000 | (+)AC, (+)SS | 81333 |
| | 61 | 01/88 → 10/91 | 1.581 | B | M | 4 | 8 | 160A2.000 | (+)COP, (+)AC | 81476 |
| 1.6 i.e. | 66 | 02/88 → 05/91 | 1.595 | B | M | 4 | 8 | 149C2.046 | | 81477 |
| | 55 | 10/92 → 04/95 | 1.581 | B | M | 4 | 8 | 159A3.048, 835C1.000 | (-)COP, (+)AC | 81314 |
| | 55 | 10/92 → 04/95 | 1.581 | B | M | 4 | 8 | 159A3.048, 835C1.000 | (+)AC, (+)SS | 81333 |
| | 55 | 10/92 → 04/95 | 1.581 | B | M | 4 | 8 | 159A3.048, 835C1.000 | (+)COP, (+)AC | 81476 |
| | 57 | 07/90 → 01/93 | 1.581 | B | M | 4 | 8 | 159A3.046 | (-)COP, (+)AC | 81314 |
| | 57 | 07/90 → 01/93 | 1.581 | B | M | 4 | 8 | 159A3.046 | (+)AC, (+)SS | 81333 |
| | 57 | 07/90 → 01/93 | 1.581 | B | M | 4 | 8 | 159A3.046 | (+)COP, (+)AC | 81476 |
| 1.6 SX DGT | 66 | 05/89 → 10/95 | 1.581 | B | M | 4 | 8 | 159A3.000 | | 81477 |
| 1.7 D | 43 | 01/88 → 10/94 | 1.697 | D | M | 4 | 8 | 149B4.000 | (-)COP, 01-1993 → | 81363 |
| | 43 | 01/88 → 10/94 | 1.697 | D | M | 4 | 8 | 149B4.000 | (+)COP, → 12-1992 | 81463 |
| | 43 | 01/88 → 10/94 | 1.697 | D | M | 4 | 8 | 149B4.000 | (+)COP, 01-1993 → | 81347 |
| | 45 | 01/88 → 10/95 | 1.697 | D | M | 4 | 8 | 149B4.000 | (-)COP, 01-1993 → | 81363 |
| | 45 | 01/88 → 10/95 | 1.697 | D | M | 4 | 8 | 149B4.000 | (+)COP, → 12-1992 | 81463 |
| | 45 | 01/88 → 10/95 | 1.697 | D | M | 4 | 8 | 149B4.000 | (+)COP, 01-1993 → | 81347 |
| 1.8 i.e. | 71 | 03/93 → 04/95 | 1.756 | B | M | 4 | 8 | 836A5.000 | | 81315 |
| | 66 | 09/93 → 04/95 | 1.756 | B | M | 4 | 8 | 835C4.000 | | 81315 |
| | 81 | 10/90 → 06/93 | 1.756 | B | M | 4 | 8 | 159A4.000 | | 81315 |
| | 74 | 10/94 → 10/95 | 1.756 | B | M | 4 | 8 | 159A4.000, 836A5.000 | | 81315 |
| | 76 | 04/93 → 04/95 | 1.756 | B | M | 4 | 8 | 835C2.000 | | 81315 |
| | 77 | 10/90 → 06/93 | 1.756 | B | M | 4 | 8 | 159A4.046 | | 81315 |
| 1.8 i.e. 16V Sport | 100 | 11/89 → 06/92 | 1.756 | B | M | 4 | 16 | 160A5.000 | | 81477 |
| 1.9 D | 48 | 07/91 → 08/95 | 1.929 | D | M | 4 | 8 | 149A1.000, 160A7.000 | (-)COP, 01-1993 → | 81363 |
| | 48 | 07/91 → 08/95 | 1.929 | D | M | 4 | 8 | 149A1.000, 160A7.000 | (+)COP, → 12-1992 | 81463 |
| | 48 | 07/91 → 08/95 | 1.929 | D | M | 4 | 8 | 149A1.000, 160A7.000 | (+)COP, 01-1993 → | 81347 |

KW

cm³

NO. OF VALVES

FIAT
Tipo I

| | | | | | | | | | | |
|--------------------|-----|---------------|-------|---|---|---|----|---------------------------------|--|-------|
| 1.9 TD | 59 | 03/92 → 06/93 | 1.929 | D | M | 4 | 8 | 160B6.046 | (-)COP, → 12-1992, (+)SS, (+)AC | 81326 |
| | 59 | 03/92 → 06/93 | 1.929 | D | M | 4 | 8 | 160B6.046 | (+)COP, → 12-1992, (+)SS, (+)AC | 81464 |
| | 66 | 09/90 → 04/95 | 1.929 | D | M | 4 | 8 | 160A6.000, 160A6.046, 160D1.000 | (-)COP, → 12-1992, (+)AC, (+)SS, (+)AC | 81326 |
| | 66 | 09/90 → 04/95 | 1.929 | D | M | 4 | 8 | 160A6.000, 160A6.046, 160D1.000 | (+)COP, → 12-1992, (+)AC, (+)SS, (+)AC | 81464 |
| 2.0 16V | 107 | 07/91 → 04/95 | 1.995 | B | M | 4 | 16 | 160A8.046 | | 81315 |
| 2.0 i.e. | 80 | 06/90 → 03/92 | 1.995 | B | M | 4 | 8 | 159A5.046 | → 06-1991 | 81460 |
| | 80 | 06/90 → 03/92 | 1.995 | B | M | 4 | 8 | 159A5.046 | 07-1991 → | 81315 |
| | 83 | 03/90 → 04/95 | 1.995 | B | M | 4 | 8 | 159A6.046 | → 06-1991 | 81460 |
| | 83 | 03/90 → 04/95 | 1.995 | B | M | 4 | 8 | 159A6.046 | 07-1991 → | 81315 |
| 2.0 i.e. 16V Sport | 102 | 03/93 → 04/95 | 1.995 | B | M | 4 | 16 | 836A3.000 | | 81322 |

Tipo II

| | | | | | | | | | | |
|----------------|----|---------|-------|---|---|---|----|---------------------|-------|-------|
| 1.3 D Multijet | 70 | 10/15 → | 1.248 | D | M | 4 | 16 | 199B1.000, 55266963 | | 81862 |
| 1.4 | 70 | 10/15 → | 1.368 | B | M | 4 | 16 | 843A1.000 | TESMA | 82070 |

Ulysse I

| | | | | | | | | | | |
|-------------|-----|---------------|-------|---|---|---|----|-----------------|-----------|-------|
| 1.8 | 73 | 05/97 → 08/02 | 1.761 | B | M | 4 | 8 | LFW | | 81512 |
| 1.9 TD | 66 | 02/95 → 08/02 | 1.905 | D | M | 4 | 8 | DHX (XUD9TF/L) | → 04-1995 | 81672 |
| | 66 | 02/95 → 08/02 | 1.905 | D | M | 4 | 8 | DHX (XUD9TF/L) | 05-1995 → | 81642 |
| 2.0 | 89 | 06/94 → 08/02 | 1.998 | B | M | 4 | 8 | RFU (XU10J2C) | | 81642 |
| 2.0 16V | 100 | 09/00 → 08/02 | 1.997 | B | M | 4 | 16 | RFN (EW10J4) | | 81711 |
| | 97 | 05/98 → 09/00 | 1.998 | B | M | 4 | 16 | RFV | | 81711 |
| 2.0 JTD | 80 | 10/99 → 08/02 | 1.997 | D | M | 4 | 8 | RHZ | | 81713 |
| 2.0 JTD 16V | 80 | 05/99 → 08/02 | 1.997 | D | M | 4 | 16 | RHW (DW10ATED4) | | 81713 |
| 2.0 Turbo | 108 | 06/94 → 08/02 | 1.998 | B | M | 4 | 8 | RGX (XU10J2CTE) | | 81642 |
| 2.1 TD | 80 | 03/96 → 10/99 | 2.088 | D | M | 4 | 12 | P8C | 04-1996 → | 81353 |

Ulysse II

| | | | | | | | | | | | |
|----------------|-----|---------------|-------|---|---|---|----|----------------------|--------|-------|------------|
| 2.0 | 100 | 08/02 → 06/11 | 1.997 | B | M | 4 | 16 | RFN (EW10J4) | (-)COP | 84038 | NEW |
| | 100 | 08/02 → 06/11 | 1.997 | B | M | 4 | 16 | RFN (EW10J4) | (+)COP | 82089 | |
| | 100 | 08/02 → 06/11 | 1.997 | B | M | 4 | 16 | RFN (EW10J4) | | 82089 | |
| | 100 | 08/02 → 06/11 | 1.997 | B | M | 4 | 16 | RFN (EW10J4) | | 81799 | |
| 2.0 D Multijet | 88 | 05/06 → 06/11 | 1.997 | D | M | 4 | 16 | RHK | | 81800 | |
| | 100 | 05/06 → 06/11 | 1.997 | D | M | 4 | 16 | RHR | | 81800 | |
| 2.0 JTD | 79 | 05/03 → 08/06 | 1.997 | D | M | 4 | 16 | RHM (DW10ATED4) | | 81713 | |
| | 80 | 08/02 → 08/06 | 1.997 | D | M | 4 | 16 | RHW (DW10ATED4) | | 81713 | |
| 2.2 D Multijet | 125 | 03/08 → 06/11 | 2.179 | D | M | 4 | 16 | 4HS, 4HT (DW12BTED4) | | 82068 | |
| 2.2 JTD | 94 | 08/02 → 08/06 | 2.179 | D | M | 4 | 16 | 4HW (DW12ATED4) | | 81800 | |
| | 120 | 03/08 → 06/11 | 2.179 | D | M | 4 | 16 | 4HP, 4HR | | 82068 | |
| 3.0 | 150 | 08/02 → 06/11 | 2.946 | B | M | 6 | 24 | XFW | | 81813 | |

| | | | | | | | | | |
|--|--|--|--|--|--|--|--|--|--|
| | | | | | | | | | |
|--|--|--|--|--|--|--|--|--|--|

FIAT

Uno I

| | | | | | | | | | | |
|------------------|----|---------------|-------|---|---|---|---|----------------------|-----------------------------------|-------|
| 1.0 | 31 | 06/89 → 02/92 | 999 | B | M | 4 | 8 | 156A2.000 | | 81801 |
| 1.0 iE | 34 | 05/98 → 08/00 | 999 | B | M | 4 | 8 | 156A2.246 | | 81801 |
| 1.1 | 41 | 01/92 → 06/06 | 1.108 | B | M | 4 | 8 | 160A3.000 | MAGMA | 81370 |
| | 43 | 10/88 → 06/06 | 1.108 | B | M | 4 | 8 | 146A4.048, 160A3.000 | MAGMA | 81370 |
| 1.3 Super Diesel | 33 | 06/83 → 03/92 | 1.302 | D | M | 4 | 8 | 127A5.000, 146B1.000 | | 81434 |
| 1.4 | 51 | 07/91 → 07/96 | 1.372 | B | M | 4 | 8 | 160A1.046 | (-)COP | 81366 |
| | 51 | 07/91 → 07/96 | 1.372 | B | M | 4 | 8 | 160A1.046 | (+)COP | 81343 |
| | 74 | 01/89 → 12/91 | 1.372 | B | M | 4 | 8 | 146A8.000 | (-)COP | 81366 |
| | 74 | 01/89 → 12/91 | 1.372 | B | M | 4 | 8 | 146A8.000 | (+)COP | 81343 |
| 1.4 Turbo i.e. | 82 | 09/89 → 09/93 | 1.372 | B | M | 4 | 8 | 146A8.046 | (-)COP | 81481 |
| | 87 | 12/89 → 12/96 | 1.372 | B | M | 4 | 8 | 146A8.000 | (-)COP | 81481 |
| 1.7 D | 43 | 11/94 → 08/00 | 1.697 | D | M | 4 | 8 | 146B2.000 | (+)COP | 81469 |
| 1.9 D | 44 | 09/89 → 03/94 | 1.929 | D | M | 4 | 8 | 149B5.046 | (+)COP | 81469 |
| | 58 | 01/89 → 12/91 | 1.929 | D | M | 4 | 8 | | (+)COP | 81469 |
| 45 0.9 | 33 | 03/83 → 09/92 | 903 | B | M | 4 | 8 | 146A.000, 146A1.000 | | 81415 |
| 45 1.0 | 32 | 06/86 → 12/93 | 999 | B | M | 4 | 8 | 156A2.048, 156A2.100 | | 81801 |
| 45 i.e. 1.0 | 33 | 04/84 → 10/95 | 999 | B | M | 4 | 8 | 156A2.246 | | 81801 |
| 50 1.1 | 37 | 01/90 → 12/93 | 1.108 | B | M | 4 | 8 | 156C.046 | 01-1989 →, → 12-1991 | 81801 |
| 50 i.e. 1.1 | 36 | 06/92 → 12/93 | 1.116 | B | M | 4 | 8 | 146C3.000 | | 81801 |
| 55 1.0 | 41 | 11/93 → 08/00 | 996 | B | M | 4 | 8 | 146C4.011 | | 81434 |
| 60 1.1 | 42 | 04/89 → 12/92 | 1.108 | B | M | 4 | 8 | 160A3.000 | | 81801 |
| 60 Diesel 1.7 | 42 | 09/89 → 12/93 | 1.698 | D | M | 4 | 8 | 146B2.000 | (+)COP | 81469 |
| 70 i.e. 1.4 | 51 | 09/89 → 12/93 | 1.372 | B | M | 4 | 8 | 160A1.046 | (-)COP, (-)AC | 81481 |
| | 51 | 09/89 → 12/93 | 1.372 | B | M | 4 | 8 | 160A1.046 | (-)COP, (+)AC | 81314 |
| | 51 | 09/89 → 12/93 | 1.372 | B | M | 4 | 8 | 160A1.046 | (+)COP, (+)AC | 81476 |
| | 51 | 09/89 → 12/93 | 1.372 | B | M | 4 | 8 | 160A1.046 | (+)SS, (+)AC | 81333 |
| | 53 | 09/89 → 12/93 | 1.372 | B | M | 4 | 8 | 146C1.000 | (-)COP, (-)AC | 81481 |
| | 53 | 09/89 → 12/93 | 1.372 | B | M | 4 | 8 | 146C1.000 | (-)COP, (+)AC | 81314 |
| | 53 | 09/89 → 12/93 | 1.372 | B | M | 4 | 8 | 146C1.000 | (+)COP, (+)AC | 81476 |
| | 53 | 09/89 → 12/93 | 1.372 | B | M | 4 | 8 | 146C1.000 | (+)SS, (+)AC | 81333 |
| 70 TD 1.4 | 52 | 10/86 → 10/90 | 1.367 | D | M | 4 | 8 | 146B.000, 146B3.000 | (+)COP, → 12-1989, M: 146B.000 | 81450 |

FORD

B-Max, Van

| | | | | | | | | | | | |
|--------------|----|---------|-------|---|---|---|----|------------------------|--|-------|--|
| 1.0 EcoBoost | 74 | 10/12 → | 998 | B | M | 3 | 12 | SFJA, SFJB, SFJC, SFJD | | 84036 | |
| | 88 | 10/12 → | 998 | B | M | 3 | 12 | M1JA | | 84036 | |
| | 92 | 10/12 → | 998 | B | M | 3 | 12 | M1JE | | 84036 | |
| 1.4 | 66 | 10/12 → | 1.388 | B | M | 4 | 16 | SPJD | | 82027 | |
| 1.4 LPG | 63 | 08/13 → | 1.388 | | M | 4 | 16 | RTJC | | 82027 | |
| | 66 | 08/13 → | 1.388 | | M | 4 | 16 | RTJC | | 82027 | |

KW

cm³

NO. OF VALVES

MAGNETI MARELLI
FORD
B-Max, Van

| | | | | | | | | | | |
|----------|----|---------|-------|---|---|---|----|------|--|-------|
| 1.5 TDCi | 55 | 10/12 → | 1.499 | D | M | 4 | 8 | UGJC | | 81798 |
| | 55 | 10/12 → | 1.499 | D | M | 4 | 8 | UGJC | | 81869 |
| 1.6 TDCi | 70 | 10/12 → | 1.560 | D | M | 4 | 8 | T3JB | | 81798 |
| | 70 | 10/12 → | 1.560 | D | M | 4 | 8 | T3JB | | 81869 |
| 1.6 Ti | 77 | 10/12 → | 1.596 | B | M | 4 | 16 | IQJA | | 82027 |

C-Max I

| | | | | | | | | | | |
|---------------|-----|---------------|-------|---|---|---|----|------------------------------|--|-------|
| 1.6 | 74 | 02/07 → 09/10 | 1.596 | B | M | 4 | 16 | HWDA, HWDB, SHDA, SHDB, SHDC | | 82027 |
| | 85 | 04/07 → 09/10 | 1.596 | B | M | 4 | 16 | HXDA, HXDB, SIDA | | 82027 |
| 1.6 TDCi | 66 | 02/07 → 09/10 | 1.560 | D | M | 4 | 16 | GPDA, HHDA, HHDB | | 81869 |
| | 74 | 02/07 → 09/10 | 1.560 | D | M | 4 | 16 | G8DC, MTDA | | 81798 |
| | 74 | 02/07 → 09/10 | 1.560 | D | M | 4 | 16 | G8DC, MTDA | | 81869 |
| 1.8 | 90 | 02/07 → 09/10 | 1.798 | B | M | 4 | 16 | QQDC | | 81804 |
| | 92 | 02/07 → 09/10 | 1.798 | B | M | 4 | 16 | QQDA, QQDB | | 81804 |
| 1.8 Flexifuel | 92 | 02/07 → 09/10 | 1.798 | | M | 4 | 16 | Q7DA | | 81804 |
| 1.8 TDCi | 85 | 02/07 → 09/10 | 1.753 | D | M | 4 | 8 | KKDA | | 81802 |
| 2.0 | 107 | 02/07 → 09/10 | 1.999 | B | M | 4 | 16 | AODA, AODB, AODE, SYDA | | 81804 |
| 2.0 CNG | 107 | 04/09 → 09/10 | 1.999 | | M | 4 | 16 | SYDA | | 81804 |
| 2.0 LPG | 107 | 06/08 → 09/10 | 1.999 | | M | 4 | 16 | SYDA | | 81804 |
| 2.0 TDCi | 81 | 02/08 → 09/10 | 1.997 | D | M | 4 | 16 | IXDA | | 81800 |
| | 98 | 02/07 → 09/10 | 1.997 | D | M | 4 | 16 | G6DC, G6DE, G6DF | | 81800 |
| | 100 | 02/07 → 09/10 | 1.997 | D | M | 4 | 16 | G6DA, G6DB, G6DD, G6DG | | 81800 |

C-Max II, Van

| | | | | | | | | | | | |
|---------------|---------|---------|-------|---|---|----|------|------------|-------|-------|------------|
| 1.0 EcoBoost | 74 | 10/12 → | 998 | B | M | 3 | 12 | M2DA, SFDA | | 84036 | NEW |
| | 92 | 10/12 → | 998 | B | M | 3 | 12 | M1DA | | 84036 | NEW |
| 1.6 CNG | 86 | 01/13 → | 1.596 | | M | 4 | 16 | MUDA | | 82027 | |
| 1.6 EcoBoost | 110 | 12/10 → | 1.596 | B | M | 4 | 16 | JQDA, JQDB | | 82027 | |
| | 134 | 12/10 → | 1.596 | B | M | 4 | 16 | JTDA, JTDB | | 82027 | |
| 1.6 Flexifuel | 88 | 02/11 → | 1.596 | | M | 4 | 16 | MUDA | | 82027 | |
| 1.6 LPG | 86 | 02/12 → | 1.596 | | M | 4 | 16 | MUDA | | 82027 | |
| | 88 | 02/12 → | 1.596 | | M | 4 | 16 | MUDA | | 82027 | |
| 1.6 TDCi | 85 | 12/10 → | 1.560 | D | M | 4 | 8 | T1DA, T1DB | | 81869 | |
| 1.6 Ti | 63 | 12/10 → | 1.596 | B | M | 4 | 16 | XTDA | | 82027 | |
| | 77 | 12/10 → | 1.596 | B | M | 4 | 16 | IQDA, IQDB | | 82027 | |
| | 92 | 12/10 → | 1.596 | B | M | 4 | 16 | PNDA | | 82027 | |
| 2.0 TDCi | 85 | 02/11 → | 1.997 | D | M | 4 | 16 | TYDA | | 84020 | NEW |
| | 100 | 02/11 → | 1.997 | D | M | 4 | 16 | UKDB | | 84020 | NEW |
| | 103 | 02/11 → | 1.997 | D | M | 4 | 16 | UFDB | | 84020 | NEW |
| | 110 | 03/15 → | 1.997 | D | M | 4 | 16 | T7DB | | 82068 | |
| | 120 | 12/10 → | 1.997 | D | M | 4 | 16 | TXDB | | 84020 | NEW |
| 125 | 03/15 → | 1.997 | D | M | 4 | 16 | T8DE | | 82068 | | |

| | | | | | | | | | |
|--|--|--|--|--|--|--|--|--|--|
| | | | | | | | | | |
|--|--|--|--|--|--|--|--|--|--|

FORD

Cougar

| | | | | | | | | | | |
|------------|-----|---------------|-------|---|---|---|----|------------------------|--|-------|
| 2.0 16V | 96 | 08/98 → 12/01 | 1.988 | B | M | 4 | 16 | EDBA, EDBB, EDBC, EDBD | | 81803 |
| 2.5 ST 200 | 151 | 01/00 → 12/01 | 2.495 | B | M | 6 | 24 | SGA | | 81845 |
| 2.5 V6 24V | 125 | 06/00 → 12/01 | 2.495 | B | M | 6 | 24 | LCBB, LCBC, LCBE | | 81845 |
| | 125 | 08/98 → 12/01 | 2.544 | B | M | 6 | 24 | LCBA | | 81845 |

Ecosport II

| | | | | | | | | | | | |
|--------------|-----|---------|-------|---|---|---|----|------------|--|-------|--|
| 1.0 EcoBoost | 92 | 10/13 → | 998 | B | M | 3 | 12 | M1JC | | 84036 | |
| | 103 | 03/16 → | 998 | B | M | 3 | 12 | YYJD | | 84036 | |
| 1.5 TDCi | 66 | 10/13 → | 1.499 | D | M | 4 | 8 | UGJE | | 81798 | |
| | 66 | 10/13 → | 1.499 | D | M | 4 | 8 | UGJE | | 81869 | |
| 1.5 Ti | 82 | 10/13 → | 1.498 | B | M | 4 | 16 | UEJB | | 82027 | |
| 1.6 Ti-VCT | 90 | 08/12 → | 1.596 | B | M | 4 | 16 | HXJD, IQJB | | 82027 | |

Escort Classic

| | | | | | | | | | | |
|---------|----|---------------|-------|---|---|---|----|----------|--|-------|
| 1.6 16V | 66 | 10/98 → 07/00 | 1.597 | B | M | 4 | 16 | L1E | | 81803 |
| 1.8 TD | 66 | 10/98 → 07/00 | 1.753 | D | M | 4 | 8 | RFD, RFK | | 81657 |

Escort IV, Station Wagon, Cabrio, Express

| | | | | | | | | | | |
|----------|--------------|---------------|---------------|-------|---|---|---|---------------|-------------------------|-------------------------|
| 1.1 | 37 | 12/85 → 07/90 | 1.117 | B | M | 4 | 8 | GSG | → 12-1988 | 81531 |
| | 37 | 05/86 → 07/90 | 1.117 | B | M | 4 | 8 | GSG | | 81531 |
| 1.3 | 44 | 02/86 → 07/90 | 1.297 | B | M | 4 | 8 | JBB, JLA, JLB | | 81650 |
| | 46 | 07/88 → 07/90 | 1.297 | B | M | 4 | 8 | JBA | | 81650 |
| | 46 | 07/88 → 10/90 | 1.297 | B | M | 4 | 8 | JBA | 02-1986 →, → 04-1991 | 81650 |
| 1.4 | 51 | 10/85 → 10/90 | 1.392 | B | M | 4 | 8 | FUAA | | 81538 |
| | 54 | 01/86 → 07/90 | 1.392 | B | M | 4 | 8 | F6B, F6D, FUC | | 81538 |
| | 55 | 01/86 → 07/90 | 1.392 | B | M | 4 | 8 | FUA | 01-1986 → | 81538 |
| | 55 | 01/86 → 07/90 | 1.392 | B | M | 4 | 8 | FUA | | 81538 |
| 1.4 i | 54 | 02/86 → 07/90 | 1.392 | B | M | 4 | 8 | F6B, F6D, FUC | | 81538 |
| 1.6 | 58 | 01/86 → 07/90 | 1.597 | B | M | 4 | 8 | LP2 | | 81538 |
| | 60 | 02/86 → 07/90 | 1.597 | B | M | 4 | 8 | LUC | | 81538 |
| | 65 | 04/89 → 07/90 | 1.598 | B | M | 4 | 8 | LUG | 02-1982 →, → 12-1992 | 81538 |
| 1.6 D | 40 | 02/86 → 07/90 | 1.608 | D | M | 4 | 8 | LTA | | 81536 |
| 1.6 i | 66 | 01/86 → 07/90 | 1.597 | B | M | 4 | 8 | L4B | | 81538 |
| | 75 | 08/89 → 07/90 | 1.597 | B | M | 4 | 8 | LJB | 02-1982 →, → 12-1992 | 81538 |
| | 75 | 08/89 → 07/90 | 1.597 | B | M | 4 | 8 | LJB | | 81538 |
| | 66 | 01/86 → 05/90 | 1.598 | B | M | 4 | 8 | L4B | | 81538 |
| | 1.6 Turbo RS | 97 | 01/86 → 07/90 | 1.597 | B | M | 4 | 8 | LNB | 02-1982 →, → 12-1992 |
| 1.6 XR3i | 77 | 01/86 → 07/90 | 1.597 | B | M | 4 | 8 | LR2, LRB | | 81538 |
| 1.8 D | 44 | 07/88 → 07/90 | 1.753 | D | M | 4 | 8 | RTA, RTB | | 81651 |
| | 44 | 01/89 → 07/90 | 1.753 | D | M | 4 | 8 | RTA, RTB | 01-1990 → | 81651 |

KW

cm³

NO. OF VALVES

MAGNETI MARELLI
FORD
Escort V, Station Wagon, Cabrio, Express

| | | | | | | | | | | |
|--------------|-----|---------------|-------|---|---|---|----|---------------|-----------|-------|
| 1.3 | 44 | 07/90 → 09/92 | 1.299 | B | M | 4 | 8 | J4B, J6A | → 04-1991 | 81650 |
| | 44 | 07/90 → 09/92 | 1.299 | B | M | 4 | 8 | J4B, J6A | 05-1991 → | 81653 |
| | 44 | 09/91 → 09/92 | 1.299 | B | M | 4 | 8 | J4B, J6A | | 81653 |
| | 46 | 07/90 → 12/94 | 1.299 | B | M | 4 | 8 | JBD | 05-1991 → | 81653 |
| 1.4 | 52 | 07/90 → 12/94 | 1.391 | B | M | 4 | 8 | F6F, F6G | | 81538 |
| | 52 | 07/90 → 09/92 | 1.392 | B | M | 4 | 8 | F6F, F6G | | 81538 |
| 1.6 | 66 | 07/90 → 08/92 | 1.598 | B | M | 4 | 8 | LUJ, LUK | | 81538 |
| | 77 | 07/90 → 12/92 | 1.598 | B | M | 4 | 8 | LJF | | 81538 |
| 1.8 16V | 77 | 02/92 → 12/92 | 1.796 | B | M | 4 | 16 | RDA | | 81655 |
| 1.8 16V XR3i | 77 | 02/92 → 12/92 | 1.796 | B | M | 4 | 16 | RDA | | 81655 |
| | 96 | 02/92 → 12/92 | 1.796 | B | M | 4 | 16 | RQB | | 81655 |
| 1.8 D | 44 | 07/90 → 12/92 | 1.753 | D | M | 4 | 8 | RTE, RTF, RTH | | 81651 |
| | 44 | 07/90 → 12/94 | 1.753 | D | M | 4 | 8 | RTH | | 81651 |
| RS 2000 | 110 | 05/91 → 12/92 | 1.998 | B | M | 4 | 16 | N7A | → 06-1991 | 81654 |

Escort VI, Station Wagon, Cabrio

| | | | | | | | | | | |
|------------------|----|---------------|-------|---|---|---|----|---------------|-----------|-------|
| 1.3 | 44 | 09/92 → 01/95 | 1.299 | B | M | 4 | 8 | J4B, J6A | | 81653 |
| 1.4 | 52 | 09/92 → 01/95 | 1.391 | B | M | 4 | 8 | F6F, F6G | | 81538 |
| | 52 | 12/92 → 04/94 | 1.392 | B | M | 4 | 8 | F6F, F6G | | 81538 |
| | 55 | 01/94 → 01/95 | 1.392 | B | M | 4 | 8 | F4B, FUH | | 81538 |
| 1.4 i | 55 | 07/93 → 01/95 | 1.392 | B | M | 4 | 8 | F4B | | 81538 |
| 1.6 16V XR3i | 66 | 12/92 → 01/95 | 1.597 | B | M | 4 | 16 | L1E | | 81655 |
| 1.6 i 16V | 65 | 01/94 → 01/95 | 1.597 | B | M | 4 | 16 | L1H | | 81655 |
| | 66 | 09/92 → 01/95 | 1.597 | B | M | 4 | 16 | L1E | | 81655 |
| | 66 | 08/93 → 01/95 | 1.597 | B | M | 4 | 16 | L1E, L1K | | 81655 |
| 1.8 16V XR3i | 77 | 12/92 → 01/95 | 1.796 | B | M | 4 | 16 | RDA | | 81655 |
| | 96 | 09/92 → 01/95 | 1.796 | B | M | 4 | 16 | RQB | | 81655 |
| 1.8 D | 44 | 09/92 → 01/95 | 1.753 | D | M | 4 | 8 | RTE, RTF, RTH | | 81651 |
| | 44 | 08/93 → 01/95 | 1.753 | D | M | 4 | 8 | RTE, RTF, RTH | 01-1990 → | 81651 |
| | 44 | 09/92 → 01/95 | 1.753 | D | M | 4 | 8 | RTH | 01-1990 → | 81651 |
| 1.8 i 16V | 77 | 09/92 → 01/95 | 1.796 | B | M | 4 | 16 | RDA | | 81655 |
| | 77 | 01/93 → 01/95 | 1.796 | B | M | 4 | 16 | RDA | 01-1990 → | 81655 |
| | 96 | 02/93 → 01/95 | 1.796 | B | M | 4 | 16 | RQB | | 81655 |
| 1.8 TD | 66 | 02/93 → 01/95 | 1.753 | D | M | 4 | 8 | RFD, RFK | | 81657 |
| | 66 | 02/93 → 01/95 | 1.753 | D | M | 4 | 8 | RFD, RFK, RFS | | 81657 |
| 1.8 XR3i 16V 4x4 | 77 | 08/93 → 01/95 | 1.796 | B | M | 4 | 16 | RDA | | 81655 |
| | 96 | 08/93 → 01/95 | 1.796 | B | M | 4 | 16 | RQB | | 81655 |

Escort VII, Station Wagon, Cabrio, Express

| | | | | | | | | | | |
|-------------|----|---------------|-------|---|---|---|----|----------|-----------|-------|
| 1.3 | 44 | 01/95 → 10/98 | 1.299 | B | M | 4 | 8 | J4B, J6A | | 81653 |
| 1.4 | 54 | 01/95 → | 1.392 | B | M | 4 | 8 | F4B | | 81538 |
| | 55 | 01/95 → 10/98 | 1.392 | B | M | 4 | 8 | F4B | | 81538 |
| | 55 | 02/95 → 08/98 | 1.392 | B | M | 4 | 8 | F4B | 01-1986 → | 81538 |
| | 55 | 01/95 → 02/99 | 1.392 | B | M | 4 | 8 | F4B, FUH | | 81538 |
| 1.6 16V | 66 | 01/95 → 10/98 | 1.597 | B | M | 4 | 16 | L1E | | 81655 |
| 1.6 16V 4x4 | 66 | 01/95 → 10/98 | 1.597 | B | M | 4 | 16 | L1E | | 81655 |

KW

cm³

NO. OF VALVES

FORD
Escort VII, Station Wagon, Cabrio, Express

| | | | | | | | | | | |
|--------------|----|---------------|-------|---|---|---|----|---------------|--|-------|
| 1.6 16V XR3i | 65 | 02/95 → 12/96 | 1.597 | B | M | 4 | 16 | L1H | | 81655 |
| | 66 | 02/95 → 09/99 | 1.597 | B | M | 4 | 16 | L1E | | 81655 |
| 1.6 i 16V | 65 | 01/95 → 08/95 | 1.597 | B | M | 4 | 16 | L1H | | 81655 |
| | 66 | 01/95 → 02/99 | 1.597 | B | M | 4 | 16 | L1E, L1K | | 81655 |
| 1.8 16V | 77 | 01/95 → 08/95 | 1.796 | B | M | 4 | 16 | RDA | | 81655 |
| | 85 | 01/95 → 10/98 | 1.796 | B | M | 4 | 16 | RKC | | 81655 |
| 1.8 16V XR3i | 77 | 02/95 → 08/98 | 1.796 | B | M | 4 | 16 | RDA | | 81655 |
| | 85 | 10/95 → 08/98 | 1.796 | B | M | 4 | 16 | RKC | | 81655 |
| | 96 | 02/95 → 08/00 | 1.796 | B | M | 4 | 16 | RQB | | 81655 |
| 1.8 D | 44 | 01/95 → 12/96 | 1.753 | D | M | 4 | 8 | RTE, RTF, RTH | | 81651 |
| | 44 | 01/95 → | 1.753 | D | M | 4 | 8 | RTF, RTH | | 81651 |
| 1.8 TD | 66 | 01/95 → 10/98 | 1.753 | D | M | 4 | 8 | RFD, RFK | | 81657 |
| 1.8 Turbo D | 51 | 12/95 → 06/01 | 1.753 | D | M | 4 | 8 | RVA | | 81657 |

Fiesta II, Van

| | | | | | | | | | | |
|-------|----|---------------|-------|---|---|---|---|---------------|--|-------|
| 1.8 D | 43 | 03/89 → 12/95 | 1.753 | D | M | 4 | 8 | RTC, RTD, RTG | | 81651 |
|-------|----|---------------|-------|---|---|---|---|---------------|--|-------|

Fiesta III, Van

| | | | | | | | | | | |
|--------------|----|---------------|-------|---|---|---|----|---------------|-----------|-------|
| 1.0 | 33 | 03/89 → 12/95 | 1.001 | B | M | 4 | 8 | TLB | → 04-1991 | 81650 |
| | 33 | 03/89 → 12/95 | 1.001 | B | M | 4 | 8 | TLB | 05-1991 → | 81653 |
| 1.1 | 37 | 03/89 → 12/95 | 1.119 | B | M | 4 | 8 | G6A | → 04-1991 | 81650 |
| | 37 | 03/89 → 12/95 | 1.119 | B | M | 4 | 8 | G6A | 05-1991 → | 81653 |
| | 40 | 03/89 → 12/95 | 1.119 | B | M | 4 | 8 | GUD, GUE | → 04-1991 | 81650 |
| | 40 | 03/89 → 12/95 | 1.119 | B | M | 4 | 8 | GUD, GUE | 05-1991 → | 81653 |
| 1.3 | 44 | 09/91 → 02/96 | 1.299 | B | M | 4 | 8 | J6B | | 81653 |
| | 44 | 03/89 → 12/92 | 1.299 | B | M | 4 | 8 | JBC | → 04-1991 | 81650 |
| | 44 | 03/89 → 12/92 | 1.299 | B | M | 4 | 8 | JBC | 05-1991 → | 81653 |
| 1.3 Cat. | 44 | 05/91 → 01/97 | 1.299 | B | M | 4 | 8 | J6B | | 81653 |
| 1.4 | 52 | 03/89 → 12/95 | 1.391 | B | M | 4 | 8 | F6E | | 81538 |
| | 54 | 03/89 → 12/95 | 1.391 | B | M | 4 | 8 | FUG, FUJ | | 81538 |
| 1.4 Cat. | 54 | 03/89 → 12/95 | 1.391 | B | M | 4 | 8 | F4A | | 81538 |
| 1.6 | 65 | 01/89 → 01/94 | 1.597 | B | M | 4 | 8 | LUH | | 81538 |
| 1.6 i 16V | 65 | 01/94 → 12/95 | 1.597 | B | M | 4 | 16 | L1G | | 81655 |
| 1.6 Turbo | 96 | 03/90 → 10/92 | 1.598 | B | M | 4 | 8 | LHA | | 81538 |
| 1.6 XR2i | 81 | 03/89 → 01/94 | 1.597 | B | M | 4 | 8 | LJC | | 81538 |
| | 76 | 03/89 → 03/93 | 1.598 | B | M | 4 | 8 | LJD | | 81538 |
| 1.8 16V | 77 | 02/92 → 12/95 | 1.796 | B | M | 4 | 16 | RDB | | 81655 |
| 1.8 D | 44 | 09/91 → 02/96 | 1.753 | D | M | 4 | 8 | RTC, RTD, RTG | | 81651 |
| 1.8 TD | 55 | 03/93 → 12/95 | 1.753 | D | M | 4 | 8 | RFL | | 81657 |
| 1.8 XR2i 16V | 96 | 02/92 → 12/95 | 1.796 | B | M | 4 | 16 | RQC | | 81655 |

Fiesta IV, Van

| | | | | | | | | | | |
|------------|----|---------------|-------|---|---|---|----|-----------------------------------|--|-------|
| 1.25 i 16V | 55 | 08/95 → 01/02 | 1.242 | B | M | 4 | 16 | DHA, DHB, DHC, DHD, DHE, DHF, DHG | | 81598 |
| 1.3 | 44 | 02/96 → | 1.299 | B | M | 4 | 8 | J4C | | 81653 |

KW

cm³

NO. OF VALVES

FORD
Fiesta IV, Van

| | | | | | | | | | | |
|---------------|----|---------------|-------|---|---|---|----|-----------------------------------|-----------|-------|
| 1.3 i | 37 | 08/95 → 01/02 | 1.299 | B | M | 4 | 8 | JJA, JJC, JJE, JJJ, JJK, JJM | | 81716 |
| | 44 | 08/95 → 01/02 | 1.299 | B | M | 4 | 8 | J4C, J4J, J4L, J4Q, J4R, J4T, JBC | | 81716 |
| 1.4 i | 66 | 04/96 → 10/99 | 1.388 | B | M | 4 | 16 | FHA | | 81598 |
| 1.4 i 16V | 66 | 04/96 → 01/02 | 1.388 | B | M | 4 | 16 | FHA, FHE | | 81598 |
| 1.6 16V Sport | 76 | 02/00 → 01/02 | 1.596 | B | M | 4 | 16 | L1T, L1V | | 81598 |
| 1.8 D | 44 | 08/95 → 04/00 | 1.753 | D | M | 4 | 8 | RTJ, RTK | | 81651 |
| | 44 | 02/96 → 04/02 | 1.753 | D | M | 4 | 8 | RTK | 01-1989 → | 81651 |
| 1.8 Di | 55 | 09/00 → 08/03 | 1.753 | D | M | 4 | 8 | RTN, RTP | | 81802 |
| | 55 | 04/00 → 01/02 | 1.753 | D | M | 4 | 8 | RTN, RTP, RTQ | | 81802 |
| D 1.8 | 44 | 05/98 → 04/02 | 1.753 | D | M | 4 | 8 | RTJ, RTK | | 81651 |
| TD 1.8 | 55 | 03/00 → 08/03 | 1.753 | D | M | 4 | 8 | RTN, RTP, RTQ | | 81802 |

Fiesta V, Van

| | | | | | | | | | | |
|----------|-----|---------------|-------|---|---|---|----|------------|-----------|-------|
| 1.25 16V | 51 | 03/03 → 06/08 | 1.242 | B | M | 4 | 16 | M7JA, M7JB | → 04-2005 | 81598 |
| | 51 | 03/03 → 06/08 | 1.242 | B | M | 4 | 16 | M7JA, M7JB | 05-2005 → | 82027 |
| | 55 | 05/02 → 06/08 | 1.242 | B | M | 4 | 16 | FUJA, FUJB | → 04-2005 | 81598 |
| | 55 | 05/02 → 06/08 | 1.242 | B | M | 4 | 16 | FUJA, FUJB | 05-2005 → | 82027 |
| 1.3 | 44 | 11/01 → 06/08 | 1.299 | B | M | 4 | 8 | BAJA | | 82018 |
| | 51 | 11/01 → 06/08 | 1.299 | B | M | 4 | 8 | A9JA, A9JB | | 82018 |
| 1.4 16V | 59 | 11/01 → 06/08 | 1.388 | B | M | 4 | 16 | FXJA, FXJB | → 04-2005 | 81598 |
| | 59 | 11/01 → 06/08 | 1.388 | B | M | 4 | 16 | FXJA, FXJB | 05-2005 → | 82027 |
| 1.4 TDCi | 50 | 11/01 → 06/08 | 1.399 | D | M | 4 | 8 | F6JA, F6JB | | 81798 |
| 1.6 16V | 74 | 11/01 → 06/08 | 1.596 | B | M | 4 | 16 | FYJA, FYJB | → 04-2005 | 81598 |
| | 74 | 11/01 → 06/08 | 1.596 | B | M | 4 | 16 | FYJA, FYJB | 05-2005 → | 82027 |
| 1.6 TDCi | 66 | 11/04 → 06/08 | 1.560 | D | M | 4 | 16 | HHJA, HHJB | | 81869 |
| ST150 | 110 | 03/05 → 06/08 | 1.999 | B | M | 4 | 16 | N4JB | | 81804 |

Fiesta VI, Van

| | | | | | | | | | | | |
|--------------|-----|---------|-------|---|---|---|----|------------------------|--|-------|------------|
| 1.0 | 48 | 01/13 → | 998 | B | M | 3 | 12 | XMJA, XMJB | | 84036 | NEW |
| | 59 | 10/12 → | 998 | B | M | 3 | 12 | P4JA, P4JB, P4JC, P4JD | | 84036 | NEW |
| 1.0 EcoBoost | 48 | 01/13 → | 998 | B | M | 3 | 12 | XMJA, XMJB | | 84036 | NEW |
| | 59 | 10/12 → | 998 | B | M | 3 | 12 | P4JA, P4JB, P4JC, P4JD | | 84036 | NEW |
| | 74 | 01/13 → | 998 | B | M | 3 | 12 | SFJA, SFJB, SFJC, SFJD | | 84036 | NEW |
| | 92 | 09/12 → | 998 | B | M | 3 | 12 | M1JE | | 84036 | NEW |
| | 92 | 09/12 → | 998 | B | M | 3 | 12 | M1JE, M1JH | | 84036 | NEW |
| | 103 | 05/14 → | 998 | B | M | 3 | 12 | YYJA, YYJB | | 84036 | NEW |
| 1.0 Sport | 103 | 05/14 → | 998 | B | M | 3 | 12 | YYJA, YYJB | | 84036 | NEW |
| 1.25 | 44 | 06/08 → | 1.242 | B | M | 4 | 16 | STJA, STJB | | 82027 | |
| | 44 | 10/12 → | 1.242 | B | M | 4 | 16 | STJB | | 82027 | |
| | 60 | 01/09 → | 1.242 | B | M | 4 | 16 | SNJA, SNJB | | 82027 | |
| | 60 | 06/08 → | 1.242 | B | M | 4 | 16 | SNJA, SNJB, SNJC, SNJD | | 82027 | |
| 1.4 | 71 | 06/08 → | 1.388 | B | M | 4 | 16 | SPJA, SPJC | | 82027 | |

KW

cm³

NO. OF VALVES

FORD
Fiesta VI, Van

| | | | | | | | | | | |
|----------|-----|---------|-------|---|---|---|----|------------------|--|-------|
| 1.4 LPG | 68 | 01/09 → | 1.388 | | M | 4 | 16 | RTJA, RTJB | | 82027 |
| | 71 | 01/09 → | 1.388 | | M | 4 | 16 | RTJA, RTJB | | 82027 |
| 1.4 TDCi | 50 | 01/09 → | 1.399 | D | M | 4 | 8 | F6JB | | 81798 |
| | 51 | 07/10 → | 1.399 | D | M | 4 | 8 | F6JD, KVJA | | 81798 |
| | 51 | 07/10 → | 1.399 | D | M | 4 | 8 | F6JD, KVJA | | 81869 |
| 1.5 TDCi | 55 | 09/12 → | 1.499 | D | M | 4 | 8 | UGJC | | 81798 |
| | 55 | 09/12 → | 1.499 | D | M | 4 | 8 | UGJC | | 81869 |
| 1.6 ST | 134 | 03/13 → | 1.596 | B | M | 4 | 16 | JTJA | | 82027 |
| 1.6 TDCi | 55 | 06/08 → | 1.560 | D | M | 4 | 16 | HHJF, UBJA | | 81869 |
| | 66 | 06/08 → | 1.560 | D | M | 4 | 16 | HHJC, HHJD, HHJE | | 81869 |
| | 66 | 01/09 → | 1.560 | D | M | 4 | 16 | HHJC, HHJD, HHJE | | 81798 |
| | 70 | 02/10 → | 1.560 | D | M | 4 | 8 | T3JA, TZJA, TZJB | | 81869 |
| | 70 | 02/10 → | 1.560 | D | M | 4 | 8 | T3JA, TZJA, TZJB | | 81798 |
| 1.6 Ti | 77 | 09/12 → | 1.596 | B | M | 4 | 16 | IQJA | | 82027 |
| | 88 | 06/08 → | 1.596 | B | M | 4 | 16 | HXJA, HXJB | | 82027 |
| | 99 | 12/10 → | 1.596 | B | M | 4 | 16 | U5JA | | 82027 |

Focus C-Max

| | | | | | | | | | | |
|---------------|-----|---------------|-------|---|---|---|----|------------------------|-----------|-------|
| 1.6 | 74 | 10/03 → 03/07 | 1.596 | B | M | 4 | 16 | HWDA, HWDB | → 04-2005 | 81598 |
| | 74 | 10/03 → 03/07 | 1.596 | B | M | 4 | 16 | HWDA, HWDB | 05-2005 → | 82027 |
| 1.6 TDCi | 66 | 02/05 → 03/07 | 1.560 | D | M | 4 | 16 | HHDA, HHDB | | 81869 |
| | 80 | 10/03 → 03/07 | 1.560 | D | M | 4 | 16 | G8DA, G8DB | | 81869 |
| 1.6 Ti | 85 | 08/04 → 03/07 | 1.596 | B | M | 4 | 16 | HXDA, SIDA | → 04-2005 | 81598 |
| | 85 | 08/04 → 03/07 | 1.596 | B | M | 4 | 16 | HXDA, SIDA | 05-2005 → | 82027 |
| 1.8 | 88 | 10/03 → 03/07 | 1.798 | B | M | 4 | 16 | CSDA, CSDB | | 81804 |
| | 92 | 04/04 → 03/07 | 1.798 | B | M | 4 | 16 | Q7DA, QQDA, QQDB | | 81804 |
| 1.8 Flexifuel | 92 | 01/06 → 03/07 | 1.798 | | M | 4 | 16 | Q7DA | | 81804 |
| 1.8 TDCi | 85 | 01/05 → 03/07 | 1.753 | D | M | 4 | 8 | KKDA | | 81802 |
| 2.0 | 107 | 03/04 → 03/07 | 1.999 | B | M | 4 | 16 | AODA, AODB, SYDA | | 81804 |
| 2.0 TDCi | 98 | 10/03 → 03/07 | 1.997 | D | M | 4 | 16 | G6DC, G6DE, G6DF | | 81800 |
| | 100 | 10/03 → 03/07 | 1.997 | D | M | 4 | 16 | G6DA, G6DB, G6DD, G6DG | | 81800 |

Focus I, Station Wagon

| | | | | | | | | | | |
|-------------------|----|---------------|-------|---|---|---|----|--|-----------|-------|
| 1.4 16V | 55 | 10/98 → 11/04 | 1.388 | B | M | 4 | 16 | FXDA, FXDB, FXDC, FXDD | 10-1998 → | 81598 |
| | 55 | 02/99 → 11/04 | 1.388 | B | M | 4 | 16 | FXDA, FXDB, FXDC, FXDD | | 81598 |
| 1.6 16V | 74 | 10/98 → 11/04 | 1.596 | B | M | 4 | 16 | FYDA, FYDB, FYDC, FYDD, FYDH | 10-1998 → | 81598 |
| | 74 | 02/99 → 11/04 | 1.596 | B | M | 4 | 16 | FYDA, FYDB, FYDC, FYDD, FYDH | | 81598 |
| 1.6 16V Flexifuel | 75 | 01/02 → 11/04 | 1.596 | | M | 4 | 16 | FYDH | | 81598 |
| 1.8 16V | 85 | 10/98 → 11/04 | 1.796 | B | M | 4 | 16 | EYDB, EYDC, EYDD, EYDE, EYDF, EYDG, EYDI, EYDJ, EYDL | | 81803 |

KW

cm³

NO. OF VALVES

FORD
Focus I, Station Wagon

| | | | | | | | | | | |
|---------------------|-----|---------------|-------|----|---|---|----|------------------------|--|-------|
| 1.8 BiFuel | 82 | 02/03 → 01/05 | 1.796 | BF | M | 4 | 16 | | | 81803 |
| 1.8 DI / TDDi | 55 | 08/99 → 11/04 | 1.753 | D | M | 4 | 8 | BHDA, BHDB | | 81802 |
| 1.8 TDCi | 74 | 08/02 → 11/04 | 1.753 | D | M | 4 | 8 | FFDA | | 81802 |
| | 85 | 03/01 → 11/04 | 1.753 | D | M | 4 | 8 | F9DA, F9DB | | 81802 |
| 1.8 Turbo DI / TDDi | 55 | 08/01 → 03/05 | 1.753 | D | M | 4 | 8 | BHDA, BHDB | | 81802 |
| | 66 | 10/98 → 11/04 | 1.753 | D | M | 4 | 8 | C9DA, C9DB, C9DC | | 81802 |
| 2.0 16V | 96 | 10/98 → 11/04 | 1.988 | B | M | 4 | 16 | EDDB, EDDC, EDDD, EDDF | | 81803 |
| RS | 158 | 10/02 → 11/04 | 1.988 | B | M | 4 | 16 | HMDA | | 81803 |
| ST170 | 127 | 03/02 → 11/04 | 1.988 | B | M | 4 | 16 | ALDA | | 81803 |

Focus II, Station Wagon, Cabrio

| | | | | | | | | | | |
|---------------|----|---------------|-------|---|---|---|----|------------------------------|-----------|-------|
| 1.4 | 59 | 07/04 → 09/12 | 1.388 | B | M | 4 | 16 | ASDA, ASDB | → 04-2005 | 81598 |
| | 59 | 07/04 → 09/12 | 1.388 | B | M | 4 | 16 | ASDA, ASDB | 05-2005 → | 82027 |
| | 59 | 04/05 → 09/12 | 1.388 | B | M | 4 | 16 | ASDA, ASDB | | 82027 |
| 1.6 | 74 | 07/04 → 09/12 | 1.596 | B | M | 4 | 16 | HWDA, HWDB, SHDA, SHDB, SHDC | → 04-2005 | 81598 |
| | 74 | 07/04 → 09/12 | 1.596 | B | M | 4 | 16 | HWDA, HWDB, SHDA, SHDB, SHDC | 05-2005 → | 82027 |
| | 74 | 10/06 → 07/11 | 1.596 | B | M | 4 | 16 | HWDA, HWDB, SHDA, SHDB, SHDC | | 82027 |
| 1.6 LPG | 85 | 10/09 → 07/11 | 1.596 | | M | 4 | 16 | SIDA | | 82027 |
| 1.6 TDCi | 66 | 01/05 → 09/12 | 1.560 | D | M | 4 | 16 | GPDA, GPDB, GPDC, HHDA, HHDB | | 81869 |
| | 66 | 07/04 → 09/12 | 1.560 | D | M | 4 | 16 | GPDA, GPDC, HHDA, HHDB | | 81869 |
| | 66 | 04/05 → 09/12 | 1.560 | D | M | 4 | 16 | HHDA, HHDB | | 81869 |
| | 74 | 07/04 → 09/12 | 1.560 | D | M | 4 | 16 | G8DC, MTDA | | 81798 |
| | 74 | 07/04 → 09/12 | 1.560 | D | M | 4 | 16 | G8DC, MTDA | | 81869 |
| | 80 | 07/04 → 09/12 | 1.560 | D | M | 4 | 16 | G8DA, G8DB, G8DD, G8DE, G8DF | | 81869 |
| | 81 | 12/07 → 09/12 | 1.560 | D | M | 4 | 16 | G8DA | | 81798 |
| 1.6 Ti | 85 | 07/04 → 09/12 | 1.596 | B | M | 4 | 16 | HXDA, HXDB | → 04-2005 | 81598 |
| | 85 | 07/04 → 09/12 | 1.596 | B | M | 4 | 16 | HXDA, HXDB | 05-2005 → | 82027 |
| | 85 | 04/05 → 09/12 | 1.596 | B | M | 4 | 16 | HXDA, HXDB | | 82027 |
| | 85 | 07/04 → 09/12 | 1.596 | B | M | 4 | 16 | HXDA, HXDB, SIDA | → 04-2005 | 81598 |
| | 85 | 07/04 → 09/12 | 1.596 | B | M | 4 | 16 | HXDA, HXDB, SIDA | 05-2005 → | 82027 |
| 1.8 | 92 | 03/06 → 09/12 | 1.798 | B | M | 4 | 16 | Q7DA, QQDB | | 81804 |
| | 92 | 03/06 → 09/12 | 1.798 | B | M | 4 | 16 | QQDB | | 81804 |
| 1.8 Flexifuel | 92 | 01/06 → 09/12 | 1.798 | | M | 4 | 16 | Q7DA | | 81804 |
| | 96 | 12/05 → 01/08 | 1.798 | | M | 4 | 16 | QQDD | | 81804 |
| | 96 | 12/05 → 01/08 | 1.798 | | M | 4 | 16 | | | 81804 |
| | 97 | 12/05 → 01/08 | 1.798 | | M | 4 | 16 | | | 81804 |
| 1.8 TDCi | 85 | 01/05 → 09/12 | 1.753 | D | M | 4 | 8 | KKDA, KKDB | | 81802 |

KW

cm³

NO. OF VALVES

FORD
Focus II, Station Wagon, Cabrio

| | | | | | | | | | | |
|------------|-----|---------------|-------|---|---|---|----|------------------|--|-------|
| 2.0 | 107 | 10/06 → 07/11 | 1.999 | B | M | 4 | 16 | AODA, AODB | | 81804 |
| | 107 | 07/04 → 09/12 | 1.999 | B | M | 4 | 16 | AODA, AODB, AODE | | 81804 |
| 2.0 CNG | 107 | 04/09 → 07/11 | 1.999 | | M | 4 | 16 | SYDA | | 81804 |
| 2.0 LPG | 107 | 06/08 → 07/11 | 1.999 | | M | 4 | 16 | SYDA | | 81804 |
| 2.0 TDCi | 81 | 02/08 → 07/11 | 1.997 | D | M | 4 | 16 | IXDA | | 81800 |
| | 98 | 07/04 → 01/08 | 1.997 | D | M | 4 | 16 | G6DE, G6DF | | 81800 |
| | 100 | 07/04 → 09/12 | 1.997 | D | M | 4 | 16 | G6DA, G6DB, G6DD | | 81800 |
| 2.5 RS | 224 | 01/09 → 07/11 | 2.521 | B | M | 5 | 20 | JZDA | | 82056 |
| 2.5 RS 500 | 257 | 05/10 → 07/11 | 2.521 | B | M | 5 | 20 | JZDA | | 82056 |
| 2.5 ST | 166 | 10/05 → 09/12 | 2.522 | B | M | 5 | 20 | HYDA | | 82056 |

Focus III, Station Wagon, Van

| | | | | | | | | | | | |
|-------------------|-----|---------|-------|---|---|---|----|------------------|--|-------|------------|
| 1.0 EcoBoost | 74 | 02/12 → | 998 | B | M | 3 | 12 | M2DA | | 84036 | NEW |
| | 92 | 02/12 → | 998 | B | M | 3 | 12 | M1DA | | 84036 | NEW |
| 1.6 EcoBoost | 110 | 07/10 → | 1.596 | B | M | 4 | 16 | JQDA, JQDB, YUDA | | 82027 | |
| | 134 | 07/10 → | 1.596 | B | M | 4 | 16 | JTDA, JTDB | | 82027 | |
| 1.6 Flexifuel | 88 | 07/10 → | 1.596 | | M | 4 | 16 | MUDA | | 82027 | |
| | 110 | 07/13 → | 1.596 | | M | 4 | 16 | YUDA | | 82027 | |
| 1.6 LPG | 86 | 02/12 → | 1.596 | | M | 4 | 16 | MUDA | | 82027 | |
| | 88 | 02/12 → | 1.596 | | M | 4 | 16 | MUDA | | 82027 | |
| 1.6 TDCi | 70 | 07/10 → | 1.560 | D | M | 4 | 8 | T3DA, T3DB | | 81869 | |
| | 85 | 07/10 → | 1.560 | D | M | 4 | 8 | T1DA, T1DB | | 81869 | |
| 1.6 TDCi ECOnetic | 77 | 05/12 → | 1.560 | D | M | 4 | 8 | NGDA, NGDB | | 81798 | |
| | 77 | 05/12 → | 1.560 | D | M | 4 | 8 | NGDA, NGDB | | 81869 | |
| 1.6 Ti | 63 | 08/11 → | 1.596 | B | M | 4 | 16 | XTDA | | 82027 | |
| | 77 | 07/10 → | 1.596 | B | M | 4 | 16 | IQDB | | 82027 | |
| | 88 | 02/12 → | 1.596 | B | M | 4 | 16 | MUDA | | 82027 | |
| | 92 | 07/10 → | 1.596 | B | M | 4 | 16 | PNDA | | 82027 | |
| 2.0 ST | 184 | 07/12 → | 1.999 | B | M | 4 | 16 | R9DA | | 81804 | |
| 2.0 TDCi | 85 | 07/10 → | 1.997 | D | M | 4 | 16 | TYDA | | 84020 | NEW |
| | 100 | 07/10 → | 1.997 | D | M | 4 | 16 | UKDB | | 84020 | NEW |
| | 103 | 07/10 → | 1.997 | D | M | 4 | 16 | UFDB | | 84020 | NEW |
| | 110 | 11/14 → | 1.997 | D | M | 4 | 16 | T7DB | | 82068 | |
| | 120 | 07/10 → | 1.997 | D | M | 4 | 16 | TXDB | | 84020 | NEW |
| | 136 | 11/14 → | 1.997 | D | M | 4 | 16 | T8DA | | 82068 | |

Fusion

| | | | | | | | | | | |
|----------|----|---------------|-------|---|---|---|----|------------------|-----------|-------|
| 1.25 | 55 | 08/04 → 12/12 | 1.242 | B | M | 4 | 16 | FUJA, FUJB | → 04-2005 | 81598 |
| | 55 | 08/04 → 12/12 | 1.242 | B | M | 4 | 16 | FUJA, FUJB | 05-2005 → | 82027 |
| 1.4 | 59 | 08/02 → 12/12 | 1.388 | B | M | 4 | 16 | FXJA, FXJB, FXJC | → 04-2005 | 81598 |
| | 59 | 08/02 → 12/12 | 1.388 | B | M | 4 | 16 | FXJA, FXJB, FXJC | 05-2005 → | 82027 |
| 1.4 LPG | 59 | 01/10 → 12/12 | 1.388 | | M | 4 | 16 | UTJA | | 82027 |
| | 59 | 01/10 → 12/12 | 1.388 | | M | 4 | 16 | UTJA | | 81598 |
| 1.4 TDCi | 50 | 08/02 → 07/05 | 1.399 | D | M | 4 | 8 | F6JA, F6JB | | 81798 |
| 1.6 | 74 | 08/02 → 11/08 | 1.596 | B | M | 4 | 16 | FYJA, FYJB, FYJC | → 04-2005 | 81598 |
| | 74 | 08/02 → 11/08 | 1.596 | B | M | 4 | 16 | FYJA, FYJB, FYJC | 05-2005 → | 82027 |

KW

cm³

NO. OF VALVES

FORD
Fusion

| | | | | | | | | | | |
|----------|----|---------------|-------|---|---|---|----|------------|--|-------|
| 1.6 TDCi | 66 | 11/04 → 12/12 | 1.560 | D | M | 4 | 16 | HHJA, HHJB | | 81869 |
|----------|----|---------------|-------|---|---|---|----|------------|--|-------|

Galaxy I

| | | | | | | | | | | |
|--------------|-----|---------------|-------|---|---|---|----|--------------|-------------------|------------------|
| 1.9 TDI | 66 | 03/95 → 05/06 | 1.896 | D | M | 4 | 8 | 1Z, AHU, ANU | (-)COP, → 04-2000 | 81522 |
| | 66 | 03/95 → 05/06 | 1.896 | D | M | 4 | 8 | 1Z, AHU, ANU | (+)COP | 82080 |
| | 66 | 03/95 → 05/06 | 1.896 | D | M | 4 | 8 | 1Z, AHU, ANU | (+)COP, → 04-2000 | 82080 |
| | 66 | 03/95 → 05/06 | 1.896 | D | M | 4 | 8 | 1Z, AHU, ANU | 05-2000 →, M: ANU | 81816 |
| | 66 | 03/95 → 05/06 | 1.896 | D | M | 4 | 8 | 1Z, AHU, ANU | | 84011 NEW |
| | 81 | 08/97 → 04/00 | 1.896 | D | M | 4 | 8 | AFN, AVG | (-)COP, → 04-2000 | 81522 |
| | 81 | 08/97 → 04/00 | 1.896 | D | M | 4 | 8 | AFN, AVG | (+)COP | 82080 |
| | 81 | 08/97 → 04/00 | 1.896 | D | M | 4 | 8 | AFN, AVG | (+)COP, → 04-2000 | 82080 |
| | 85 | 04/00 → 05/06 | 1.896 | D | M | 4 | 8 | AUY | M: VW19NPD | 81816 |
| | 85 | 04/00 → 05/06 | 1.896 | D | M | 4 | 8 | AUY | | 84011 NEW |
| | 96 | 02/03 → 05/06 | 1.896 | D | M | 4 | 8 | ASZ | | 84010 NEW |
| | 96 | 02/03 → 05/06 | 1.896 | D | M | 4 | 8 | ASZ | | 81791 |
| | 110 | 05/05 → 05/06 | 1.896 | D | M | 4 | 8 | BTB | | 84010 NEW |
| | 110 | 05/05 → 05/06 | 1.896 | D | M | 4 | 8 | BTB | | 81791 |
| 2.8 i V6 | 128 | 11/95 → 04/00 | 2.792 | B | M | 6 | 12 | AAA, AMY | | 81773 |
| 2.8 i V6 4x4 | 128 | 04/96 → 04/00 | 2.792 | B | M | 6 | 12 | AAA, AMY | | 81773 |
| 2.8 V6 | 150 | 04/00 → 05/06 | 2.792 | B | M | 6 | 24 | AYL | | 81773 |

Galaxy II

| | | | | | | | | | | |
|---------------|-----|---------------|-------|---|---|---|----|------------------------|-----------|------------------|
| 1.6 EcoBoost | 118 | 11/10 → 06/15 | 1.596 | B | M | 4 | 16 | JTWA, JTWB | | 82027 |
| 1.6 TDCi | 85 | 02/11 → 06/15 | 1.560 | D | M | 4 | 8 | T1WA, T1WB | | 81798 |
| | 85 | 02/11 → 06/15 | 1.560 | D | M | 4 | 8 | T1WA, T1WB | | 81869 |
| 1.8 TDCi | 74 | 05/06 → 06/15 | 1.753 | D | M | 4 | 8 | FFWA | | 81802 |
| | 92 | 05/06 → 06/15 | 1.753 | D | M | 4 | 8 | QYWA | | 81802 |
| 2.0 | 107 | 05/06 → 06/15 | 1.999 | B | M | 4 | 16 | AOWA, AOWB | | 81804 |
| 2.0 EcoBoost | 149 | 03/10 → 06/15 | 1.999 | B | M | 4 | 16 | TNWA | | 81804 |
| 2.0 Flexifuel | 107 | 05/06 → 06/15 | 1.999 | | M | 4 | 16 | TBWA, TBWB | | 81804 |
| 2.0 TDCi | 85 | 11/07 → 06/15 | 1.997 | D | M | 4 | 16 | KLWA, TYWA | | 81800 |
| | 96 | 05/06 → 06/15 | 1.997 | D | M | 4 | 16 | AZWA | | 81800 |
| | 100 | 05/06 → 06/15 | 1.997 | D | M | 4 | 16 | AZWC, UKWA | → 05-2009 | 81800 |
| | 103 | 05/06 → 06/15 | 1.997 | D | M | 4 | 16 | QXWA, QXWB, QXWC, UFWA | | 81800 |
| | 120 | 03/10 → 06/15 | 1.997 | D | M | 4 | 16 | TXWA | | 84020 NEW |
| 2.2 TDCi | 129 | 03/08 → 12/12 | 2.179 | D | M | 4 | 16 | Q4BA, Q4WA | | 82068 |
| | 147 | 11/10 → 06/15 | 2.179 | D | M | 4 | 16 | KNWA | | 82068 |
| 2.3 | 118 | 09/07 → 06/15 | 2.261 | B | M | 4 | 16 | SEWA | | 81804 |

Galaxy III

| | | | | | | | | | | |
|--------------|-----|---------|-------|---|---|---|----|------------------------|--|-------|
| 2.0 EcoBoost | 176 | 01/15 → | 1.999 | B | M | 4 | 16 | R9CD, R9CI | | 81804 |
| 2.0 TDCi | 110 | 01/15 → | 1.997 | D | M | 4 | 16 | T7CI, T7CJ, T7CK, T7CL | | 82068 |
| | 132 | 01/15 → | 1.997 | D | M | 4 | 16 | T8CG, T8CH, T8CI, T8CJ | | 82068 |

| | | | | | | | | | |
|--|--|--|--|--|--|--|--|--|--|
| | | | | | | | | | |
|--|--|--|--|--|--|--|--|--|--|

FORD

Galaxy III

| | | | | | | | | | | |
|-------------------|-----|---------|-------|---|---|---|----|------------------------|--|-------|
| 2.0 TDCi 4x4 | 110 | 05/15 → | 1.997 | D | M | 4 | 16 | | | 82068 |
| | 132 | 05/15 → | 1.997 | D | M | 4 | 16 | T8CG, T8CH, T8CI, T8CJ | | 82068 |
| 2.0 TDCi Bi-Turbo | 154 | 01/15 → | 1.997 | D | M | 4 | 16 | T9CB, T9CC | | 82068 |

Grand C-Max

| | | | | | | | | | | | |
|--------------|-----|---------|-------|---|---|---|----|------------|--|-------|--|
| 1.0 EcoBoost | 74 | 10/12 → | 998 | B | M | 3 | 12 | M2DA, SFDA | | 84036 | |
| | 92 | 10/12 → | 998 | B | M | 3 | 12 | M1DA | | 84036 | |
| 1.6 EcoBoost | 110 | 12/10 → | 1.596 | B | M | 4 | 16 | JQDA, JQDB | | 82027 | |
| | 134 | 12/10 → | 1.596 | B | M | 4 | 16 | JTDA, JTDB | | 82027 | |
| 1.6 TDCi | 70 | 12/10 → | 1.560 | D | M | 4 | 8 | T3DA, T3DB | | 81798 | |
| | 85 | 12/10 → | 1.560 | D | M | 4 | 8 | T1DA, T1DB | | 81798 | |
| 1.6 Ti | 77 | 12/10 → | 1.596 | B | M | 4 | 16 | IQDA, IQDB | | 82027 | |
| | 92 | 12/10 → | 1.596 | B | M | 4 | 16 | PNDA | | 82027 | |
| 2.0 TDCi | 85 | 02/11 → | 1.997 | D | M | 4 | 16 | TYDA | | 84020 | |
| | 100 | 02/11 → | 1.997 | D | M | 4 | 16 | UKDB | | 84020 | |
| | 103 | 02/11 → | 1.997 | D | M | 4 | 16 | UFDB | | 84020 | |
| | 120 | 12/10 → | 1.997 | D | M | 4 | 16 | TXDB | | 84020 | |

KA I, StreetKa, Van

| | | | | | | | | | | | |
|-------|----|---------------|-------|---|---|---|---|-----------------------------------|--------------------------------|-------|--|
| 1.0 i | 38 | 07/97 → 09/99 | 999 | B | M | 4 | 8 | ZH10JRB | | 81716 | |
| | 48 | 09/99 → 11/08 | 999 | B | M | 4 | 8 | | | 81716 | |
| 1.3 i | 36 | 06/98 → 11/08 | 1.299 | B | M | 4 | 8 | JJD, JJF, JJG, JJH, JJJ | | 81716 | |
| | 37 | 09/96 → 10/02 | 1.299 | B | M | 4 | 8 | JJB | | 81716 | |
| | 44 | 09/96 → 11/08 | 1.299 | B | M | 4 | 8 | BAA, J4D, J4K, J4M, J4N, J4P, J4S | M: DU13BAYA, M: DU13BAA | 82018 | |
| | 44 | 09/96 → 11/08 | 1.299 | B | M | 4 | 8 | BAA, J4D, J4K, J4M, J4N, J4P, J4S | M: J4P, M: J4D, M: J4K, M: J4P | 81716 | |
| | 44 | 05/02 → 05/05 | 1.299 | B | M | 4 | 8 | BAA, J4D, J4K, J4M, J4N, J4P, J4S | | 82018 | |
| | 51 | 08/02 → 11/08 | 1.299 | B | M | 4 | 8 | A9A, A9B | | 82018 | |
| 1.6 | 70 | 09/00 → 11/08 | 1.597 | B | M | 4 | 8 | CDB, CDC | | 82018 | |
| | 70 | 05/03 → 07/05 | 1.599 | B | M | 4 | 8 | CDRA, CDRB | | 82018 | |
| 1.6 i | 71 | 11/05 → 09/08 | 1.597 | B | M | 4 | 8 | | | 82018 | |
| | 70 | 07/03 → 11/08 | 1.599 | B | M | 4 | 8 | CDB, CDC | | 82018 | |

KA II

| | | | | | | | | | | |
|----------|----|---------|-------|---|---|---|----|-----|----------|-------|
| 1.2 | 51 | 10/08 → | 1.242 | B | M | 4 | 8 | FP4 | PIERBURG | 81369 |
| 1.3 TDCi | 55 | 10/08 → | 1.248 | D | M | 4 | 16 | FD4 | | 81862 |

Kuga I

| | | | | | | | | | | | |
|--------------|-----|---------------|-------|---|---|---|----|------------|--|-------|--|
| 2.0 TDCi | 100 | 03/08 → 11/12 | 1.997 | D | M | 4 | 16 | G6DG, UKDA | | 81800 | |
| | 103 | 03/10 → 11/12 | 1.997 | D | M | 4 | 16 | UFDA | | 84020 | |
| 2.0 TDCi 4x4 | 100 | 03/08 → 11/12 | 1.997 | D | M | 4 | 16 | G6DG, UKDA | | 81800 | |
| | 103 | 03/10 → 11/12 | 1.997 | D | M | 4 | 16 | UFDA | | 84020 | |
| | 120 | 03/10 → 11/12 | 1.998 | D | M | 4 | 16 | TXDA | | 84020 | |
| 2.5 | 147 | 03/09 → 11/12 | 2.522 | B | M | 5 | 20 | HYDB, HYDC | | 82056 | |
| 2.5 4x4 | 147 | 03/09 → | 2.522 | B | M | 5 | 20 | HYDB | | 82056 | |

KW

cm³

NO. OF VALVES

MAGNETI MARELLI
FORD
Kuga II, Van

| | | | | | | | | | | |
|------------------|-----|---------|-------|---|---|---|----|------------|--|------------------|
| 1.6 EcoBoost | 110 | 03/13 → | 1.596 | B | M | 4 | 16 | JQMA, JQMB | | 82027 |
| 1.6 EcoBoost 4x4 | 110 | 03/13 → | 1.596 | B | M | 4 | 16 | JQMA, JQMB | | 82027 |
| | 134 | 03/13 → | 1.596 | B | M | 4 | 16 | JTMA | | 82027 |
| 2.0 TDCi | 100 | 03/13 → | 1.997 | D | M | 4 | 16 | UKMA | | 84020 NEW |
| | 103 | 03/13 → | 1.997 | D | M | 4 | 16 | UFMA | | 84020 NEW |
| | 88 | 09/14 → | 1.998 | D | M | 4 | 16 | XRMA, XRMB | | 84020 NEW |
| | 110 | 09/14 → | 1.998 | D | M | 4 | 16 | T7MA, T7MB | | 84020 NEW |
| 2.0 TDCi 4x4 | 100 | 03/13 → | 1.997 | D | M | 4 | 16 | UKMA | | 84020 NEW |
| | 103 | 03/13 → | 1.997 | D | M | 4 | 16 | UFMA | | 84020 NEW |
| | 110 | 09/14 → | 1.998 | D | M | 4 | 16 | T7MA, T7MB | | 84020 NEW |
| | 120 | 03/13 → | 1.998 | D | M | 4 | 16 | TXDA, TXMA | | 84020 NEW |
| | 132 | 09/14 → | 1.998 | D | M | 4 | 16 | T8MA, T8MB | | 82068 |

Maverick II

| | | | | | | | | | | |
|------------|-----|---------|-------|---|---|---|----|----|-----------|-------|
| 2.3 16V | 110 | 03/04 → | 2.261 | B | M | 4 | 16 | GZ | | 81804 |
| 3.0 V6 24V | 145 | 02/01 → | 2.967 | B | A | 6 | 24 | AJ | → 03-2004 | 81845 |
| | 145 | 02/01 → | 2.967 | B | A | 6 | 24 | AJ | 05-2003 → | 82036 |
| | 149 | 03/04 → | 2.967 | B | M | 6 | 24 | AJ | | 82036 |

Mondeo I, Station Wagon

| | | | | | | | | | | |
|---------------|-----|---------------|-------|---|---|---|----|----------|-----------|-------|
| 1.6 i 16V | 65 | 07/94 → 08/96 | 1.597 | B | M | 4 | 16 | L1J | | 82004 |
| | 66 | 02/93 → 08/96 | 1.597 | B | M | 4 | 16 | L1F | | 82004 |
| 1.8 4x4 | 85 | 02/93 → 08/96 | 1.796 | B | M | 4 | 16 | RKA | | 82004 |
| 1.8 i 16V | 82 | 07/94 → 08/96 | 1.796 | B | M | 4 | 16 | RKB | | 82004 |
| | 85 | 02/93 → 08/96 | 1.796 | B | M | 4 | 16 | RKA | | 82004 |
| 1.8 i 16V 4x4 | 85 | 02/93 → 08/96 | 1.796 | B | M | 4 | 16 | RKA | | 82004 |
| 1.8 TD | 65 | 06/93 → 08/96 | 1.753 | D | M | 4 | 8 | RFM, RFN | | 81656 |
| | 66 | 10/95 → 08/96 | 1.753 | D | M | 4 | 8 | RFM, RFN | | 81656 |
| 2.0 i 16V | 97 | 12/94 → 08/96 | 1.988 | B | M | 4 | 16 | NGA | | 82004 |
| | 100 | 02/93 → 08/96 | 1.988 | B | M | 4 | 16 | NGA | 02-1993 → | 82004 |
| | 100 | 04/93 → 08/96 | 1.988 | B | M | 4 | 16 | NGA | | 82004 |
| 2.0 i 16V 4x4 | 97 | 12/94 → 08/96 | 1.988 | B | M | 4 | 16 | NGA | | 82004 |
| | 100 | 04/93 → 08/96 | 1.988 | B | M | 4 | 16 | NGA | | 82004 |
| 2.5 i 24V | 125 | 07/94 → 08/96 | 2.544 | B | M | 6 | 24 | SEA | | 81845 |

Mondeo II, Station Wagon

| | | | | | | | | | | |
|-----------|-----|---------------|-------|---|---|---|----|-------------------------|-----------|-------|
| 1.6 i | 66 | 08/96 → 09/00 | 1.597 | B | M | 4 | 16 | L1J | | 82004 |
| 1.6 i 16V | 70 | 05/98 → 09/00 | 1.597 | B | M | 4 | 16 | L1L, L1N, L1Q | | 82004 |
| 1.8 i | 85 | 08/96 → 09/00 | 1.796 | B | M | 4 | 16 | RKB, RKF, RKH, RKJ, RKK | → 04-1998 | 82004 |
| | 85 | 08/96 → 09/00 | 1.796 | B | M | 4 | 16 | RKB, RKF, RKH, RKJ, RKK | | 82004 |
| 1.8 TD | 66 | 08/96 → 09/00 | 1.753 | D | M | 4 | 8 | RFN | | 81656 |
| 2.0 i | 96 | 08/96 → 09/00 | 1.988 | B | M | 4 | 16 | NGA, NGB, NGC, NGD | | 82004 |
| 2.5 24V | 125 | 06/00 → 09/00 | 2.495 | B | M | 6 | 24 | LCBD, SEB, SEC | | 81845 |
| | 125 | 06/00 → 09/00 | 2.495 | B | M | 6 | 24 | SEB, SEC | | 81845 |
| | 125 | 08/96 → 09/00 | 2.544 | B | M | 6 | 24 | SEA | | 81845 |

KW

cm³

NO. OF VALVES

FORD
Mondeo II, Station Wagon

| | | | | | | | | | | |
|------------|-----|---------------|-------|---|---|---|----|-----|--|-------|
| 2.5 ST 200 | 151 | 05/99 → 09/00 | 2.495 | B | M | 6 | 24 | SGA | | 81845 |
|------------|-----|---------------|-------|---|---|---|----|-----|--|-------|

Mondeo III, Station Wagon

| | | | | | | | | | | |
|--------------------------|-----|---------------|-------|---|----|---|----|------------------------|--|-------|
| 1.8 16V | 81 | 10/00 → 03/07 | 1.798 | B | M | 4 | 16 | CGBA, CGBB | | 81804 |
| | 92 | 10/00 → 03/07 | 1.798 | B | M | 4 | 16 | CHBA, CHBB | | 81804 |
| 1.8 SCi | 96 | 06/03 → 03/07 | 1.798 | B | M | 4 | 16 | CFBA | | 81804 |
| 2.0 16V | 107 | 10/00 → 03/07 | 1.999 | B | AM | 4 | 16 | CJBA, CJBB | | 81804 |
| 2.0 16V DI / TDDi / TDCi | 66 | 10/00 → 03/07 | 1.998 | D | M | 4 | 16 | D5BA, SDBA | | 81805 |
| 2.0 16V TDDi / TDCi | 85 | 10/00 → 03/07 | 1.998 | D | M | 4 | 16 | D6BA, HJBA, HJBB, HJBC | | 81805 |
| 2.0 TDCi | 96 | 10/01 → 03/07 | 1.998 | D | M | 4 | 16 | FMBA, N7BA | | 81805 |
| 2.2 TDCi | 110 | 09/04 → 03/07 | 2.198 | D | M | 4 | 16 | QJBC, QJBD | | 81805 |
| | 114 | 09/04 → 03/07 | 2.198 | D | M | 4 | 16 | QJBA, QJBB | | 81805 |
| 2.5 V6 24V | 125 | 10/00 → 03/07 | 2.495 | B | AM | 6 | 24 | LCBD | | 82036 |
| 3.0 V6 24V | 150 | 09/04 → 03/07 | 2.967 | B | M | 6 | 24 | REBA | | 82036 |
| ST220 | 166 | 04/02 → 03/07 | 2.967 | B | M | 6 | 24 | MEBA | | 82036 |

Mondeo IV, Station Wagon

| | | | | | | | | | | |
|---------------|-----|---------------|-------|---|---|---|----|------------------------|--|------------------|
| 1.6 EcoBoost | 118 | 02/11 → 09/14 | 1.596 | B | M | 4 | 16 | JTBA | | 82027 |
| | 118 | 02/11 → 09/14 | 1.596 | B | M | 4 | 16 | JTBB | | 82027 |
| 1.6 TDCi | 85 | 02/11 → 09/14 | 1.560 | D | M | 4 | 8 | T1BA, T1BB, T1BC | | 81869 |
| 1.6 Ti | 81 | 03/07 → 09/14 | 1.596 | B | M | 4 | 16 | RHBA | | 82027 |
| | 88 | 07/10 → 09/14 | 1.596 | B | M | 4 | 16 | KGBA | | 82027 |
| | 92 | 03/07 → 09/14 | 1.596 | B | M | 4 | 16 | PNBA | | 82027 |
| 1.8 TDCi | 74 | 03/07 → 09/14 | 1.753 | D | M | 4 | 8 | FFBA | | 81802 |
| | 92 | 06/07 → | 1.753 | D | M | 4 | 8 | KHBA, QYBA | | 81802 |
| 2.0 | 107 | 03/07 → 09/14 | 1.999 | B | M | 4 | 16 | AOBA, AOBC, TBBA | | 81804 |
| 2.0 EcoBoost | 176 | 07/10 → 09/14 | 1.999 | B | M | 4 | 16 | TPBA | | 81804 |
| 2.0 Flexifuel | 107 | 03/09 → 09/14 | 1.999 | | M | 4 | 16 | TBBA, TBBB | | 81804 |
| 2.0 LPG | 107 | 07/09 → 09/14 | 1.999 | | M | 4 | 16 | TBBA | | 81804 |
| 2.0 SCTi | 149 | 03/10 → 09/14 | 1.976 | B | M | 4 | 16 | TNBA | | 81804 |
| 2.0 TDCi | 85 | 11/07 → 09/14 | 1.997 | D | M | 4 | 16 | KLBA, LPBA, TYBA | | 81800 |
| | 96 | 03/07 → 09/14 | 1.997 | D | M | 4 | 16 | AZBA | | 81800 |
| | 100 | 03/07 → 09/14 | 1.997 | D | M | 4 | 16 | AZBC, UKBA, UKBB | | 81800 |
| | 103 | 03/07 → 09/14 | 1.997 | D | M | 4 | 16 | QXBA, QXBB, UFBA, UFBB | | 81800 |
| | 120 | 03/10 → 09/14 | 1.997 | D | M | 4 | 16 | TXBA, TXBB | | 84020 NEW |
| | 129 | 03/08 → 10/10 | 2.179 | D | M | 4 | 16 | Q4BA | | 82068 |
| | 147 | 07/10 → 09/14 | 2.179 | D | M | 4 | 16 | KNBA | | 82068 |
| 2.3 | 118 | 07/07 → 09/14 | 2.261 | B | M | 4 | 16 | SEBA | | 81804 |
| 2.5 | 162 | 03/07 → 09/14 | 2.521 | B | M | 5 | 20 | HUBA | | 82056 |

KW

cm³

NO. OF VALVES

FORD
Mondeo V, Station Wagon

| | | | | | | | | | | | |
|-------------------|-----|---------|-------|---|---|---|----|------------------|--|-------|------------|
| 1.0 EcoBoost | 92 | 02/15 → | 999 | B | M | 3 | 12 | M1CA, M1CB | | 84036 | NEW |
| 2.0 EcoBoost | 146 | 05/15 → | 1.999 | B | M | 4 | 16 | TNCC | | 81804 | |
| | 149 | 09/14 → | 1.999 | B | M | 4 | 16 | TNCD, TNCF | | 81804 | |
| | 176 | 09/14 → | 1.999 | B | M | 4 | 16 | R9CB, R9CF, R9CH | | 81804 | |
| 2.0 TDCi | 110 | 09/14 → | 1.998 | D | M | 4 | 16 | T7CE | | 82068 | |
| | 132 | 09/14 → | 1.998 | D | M | 4 | 16 | T8CC | | 82068 | |
| 2.0 TDCi 4x4 | 110 | 02/15 → | 1.998 | D | M | 4 | 16 | T7CE | | 82068 | |
| | 132 | 02/15 → | 1.998 | D | M | 4 | 16 | T8CC | | 82068 | |
| 2.0 TDCi Bi-Turbo | 154 | 03/15 → | 1.998 | D | M | 4 | 16 | T9CA | | 82068 | |
| | 154 | 05/15 → | 1.998 | D | M | 4 | 16 | | | 82068 | |

Orion II

| | | | | | | | | | | | |
|------------|----|---------------|-------|---|---|---|---|---------------|--|-------|--|
| 1.3 | 44 | 12/85 → 07/90 | 1.297 | B | M | 4 | 8 | JBB, JLA, JLB | | 81531 | |
| 1.4 | 52 | 03/86 → 07/90 | 1.392 | B | M | 4 | 8 | FUAA | | 81538 | |
| | 54 | 01/86 → 07/90 | 1.392 | B | M | 4 | 8 | FUC | | 81538 | |
| | 55 | 12/85 → 07/90 | 1.392 | B | M | 4 | 8 | FUA | | 81538 | |
| 1.4 Cat. | 54 | 02/87 → 07/90 | 1.392 | B | M | 4 | 8 | F6B, F6D | | 81538 | |
| 1.6 | 66 | 12/85 → 07/90 | 1.597 | B | M | 4 | 8 | LUC | | 81538 | |
| 1.6 i | 75 | 08/89 → 07/90 | 1.597 | B | M | 4 | 8 | LJB | | 81538 | |
| | 77 | 03/86 → 07/90 | 1.597 | B | M | 4 | 8 | LRB | | 81538 | |
| 1.6 i Cat. | 66 | 03/86 → 07/90 | 1.597 | B | M | 4 | 8 | L4B | | 81538 | |
| 1.8 D | 44 | 01/89 → 07/90 | 1.753 | D | M | 4 | 8 | RTA, RTB | | 81651 | |

Orion III

| | | | | | | | | | | | |
|-----------|----|---------------|-------|---|---|---|----|---------------|-----------|-------|--|
| 1.3 | 44 | 07/90 → 12/93 | 1.299 | B | M | 4 | 8 | J4B, J6A | → 04-1991 | 81650 | |
| | 44 | 07/90 → 12/93 | 1.299 | B | M | 4 | 8 | J4B, J6A | 05-1991 → | 81653 | |
| 1.4 | 52 | 07/90 → 12/93 | 1.391 | B | M | 4 | 8 | F6F, F6G | | 81538 | |
| | 54 | 07/90 → 12/93 | 1.392 | B | M | 4 | 8 | FUH | | 81538 | |
| 1.6 | 66 | 07/90 → 12/92 | 1.598 | B | M | 4 | 8 | LUJ, LUK | | 81538 | |
| 1.6 i | 77 | 07/90 → 09/92 | 1.598 | B | M | 4 | 8 | LJF | | 81538 | |
| 1.6 i 16V | 66 | 07/92 → 12/93 | 1.597 | B | M | 4 | 16 | L1E, L1K | | 81655 | |
| 1.8 D | 44 | 11/90 → 12/93 | 1.753 | D | M | 4 | 8 | RTE, RTF, RTH | | 81651 | |
| 1.8 i 16V | 77 | 02/92 → 12/93 | 1.796 | B | M | 4 | 16 | RDA | | 81655 | |
| | 96 | 01/92 → 12/93 | 1.796 | B | M | 4 | 16 | RQB | | 81655 | |
| 1.8 TD | 66 | 03/92 → 12/93 | 1.753 | D | M | 4 | 8 | RFD, RFK | | 81657 | |

P 100 II

| | | | | | | | | | | | |
|-----|----|---------------|-------|---|---|---|---|-----|--|-------|--|
| 2.0 | 57 | 10/87 → 12/92 | 1.993 | B | M | 4 | 8 | NAE | | 81602 | |
|-----|----|---------------|-------|---|---|---|---|-----|--|-------|--|

Puma

| | | | | | | | | | | | |
|---------|-----|---------------|-------|---|---|---|----|----------|--|-------|--|
| 1.4 16V | 66 | 11/97 → 10/00 | 1.388 | B | M | 4 | 16 | FHD, FHF | | 81598 | |
| 1.6 16V | 76 | 08/00 → 06/02 | 1.596 | B | M | 4 | 16 | L1W | | 81598 | |
| 1.7 16V | 92 | 03/97 → 06/02 | 1.679 | B | M | 4 | 16 | MHA, MHB | | 81598 | |
| ST 160 | 118 | 06/99 → 06/02 | 1.679 | B | M | 4 | 16 | | | 81598 | |

KW

cm³

NO. OF VALVES

FORD
Scorpio I, Station Wagon

| | | | | | | | | | | |
|--------|----|---------------|-------|---|---|---|---|----------|-----------------------------|-------|
| 1.8 | 66 | 04/85 → 02/92 | 1.796 | B | M | 4 | 8 | REC | 10-1984 →, → 12-1990, VA | 81602 |
| 2.0 | 77 | 03/90 → 08/92 | 1.998 | B | M | 4 | 8 | N8B | → 01-1991 | 81654 |
| | 80 | 11/88 → 10/92 | 1.998 | B | M | 4 | 8 | N8A | → 01-1991 | 81654 |
| | 80 | 06/89 → 03/93 | 1.998 | B | M | 4 | 8 | N8B | → 01-1991 | 81654 |
| 2.0 i | 74 | 10/85 → 12/90 | 1.993 | B | M | 4 | 8 | NRC | | 81602 |
| | 85 | 04/85 → 02/92 | 1.993 | B | M | 4 | 8 | NRA, NRI | → 12-1988 | 81602 |
| | 85 | 04/85 → 02/92 | 1.993 | B | M | 4 | 8 | NRA, NRI | 01-1989 →, → 01-1991 | 81654 |
| 2.5 TD | 88 | 05/89 → 09/94 | 1.998 | B | M | 4 | 8 | N9D | → 01-1991 | 81654 |
| | 92 | 05/89 → 02/92 | 1.998 | B | M | 4 | 8 | N9B | → 01-1991 | 81654 |
| | 85 | 08/93 → 09/94 | 2.500 | D | M | 4 | 8 | SCB | → 09-1993 | 81302 |
| | 85 | 08/93 → 09/94 | 2.500 | D | M | 4 | 8 | SCB | | 81302 |

Scorpio II, Station Wagon

| | | | | | | | | | | |
|-----------|-----|---------------|-------|---|---|---|----|-----|-----------|-------|
| 2.3 i 16V | 108 | 06/96 → 08/98 | 2.295 | B | M | 4 | 16 | Y5A | | 81654 |
| 2.5 TD | 85 | 10/94 → 08/98 | 2.500 | D | M | 4 | 8 | SCC | → 09-1996 | 81302 |
| | 85 | 10/94 → 08/98 | 2.500 | D | M | 4 | 8 | SCC | 06-1996 → | 81302 |
| | 92 | 09/96 → 08/98 | 2.500 | D | M | 4 | 8 | VM | (-)COP | 81362 |

Sierra II, Station Wagon

| | | | | | | | | | | |
|---------------------------|-----|---------------|-------|---|---|---|----|----------|-----------|-------|
| 1.6 | 53 | 01/88 → 02/93 | 1.597 | B | M | 4 | 8 | LSF | (-)SS | 81532 |
| | 53 | 01/88 → 02/93 | 1.597 | B | M | 4 | 8 | LSF | (+)SS | 81602 |
| | 53 | 01/88 → 02/93 | 1.597 | B | M | 4 | 8 | LSF | (+)SS, VA | 81602 |
| | 53 | 01/88 → 02/93 | 1.597 | B | M | 4 | 8 | LSF | | 81532 |
| | 55 | 01/87 → 02/93 | 1.597 | B | M | 4 | 8 | LSE | (+)SS | 81602 |
| | 55 | 01/87 → 02/93 | 1.597 | B | M | 4 | 8 | LSE | | 81532 |
| 1.6 i | 59 | 10/89 → 02/93 | 1.597 | B | M | 4 | 8 | L6B | (+)SS | 81602 |
| | 59 | 10/89 → 02/93 | 1.597 | B | M | 4 | 8 | L6B | | 81532 |
| | 59 | 10/89 → 02/93 | 1.598 | B | M | 4 | 8 | L6B | (+)SS | 81602 |
| | 59 | 10/89 → 02/93 | 1.598 | B | M | 4 | 8 | L6B | | 81532 |
| 2.0 | 77 | 01/87 → 02/93 | 1.993 | B | M | 4 | 8 | N8C, NES | (+)SS | 81602 |
| | 77 | 01/87 → 02/93 | 1.993 | B | M | 4 | 8 | N8C, NES | → 01-1991 | 81654 |
| | 77 | 01/87 → 02/93 | 1.993 | B | M | 4 | 8 | N8C, NES | | 81532 |
| | 80 | 07/89 → 12/92 | 1.998 | B | M | 4 | 8 | N8A | (+)SS | 81602 |
| | 80 | 07/89 → 12/92 | 1.998 | B | M | 4 | 8 | N8A | | 81532 |
| 2.0 16V Cosworth 4x4 | 162 | 01/90 → 02/93 | 1.993 | B | M | 4 | 16 | N5D | | 81602 |
| 2.0 16V Cosworth 4x4 Cat. | 162 | 01/90 → 02/93 | 1.993 | B | M | 4 | 16 | N5C | | 81602 |
| 2.0 4x4 | 88 | 01/90 → 02/93 | 1.998 | B | M | 4 | 8 | N9C | (+)SS | 81602 |
| | 88 | 01/90 → 02/93 | 1.998 | B | M | 4 | 8 | N9C | | 81532 |
| | 88 | 02/90 → 02/93 | 1.998 | B | M | 4 | 8 | N9C | → 01-1991 | 81654 |
| | 92 | 01/90 → 02/93 | 1.998 | B | M | 4 | 8 | N9C | → 01-1991 | 81654 |

KW

cm³

NO. OF VALVES

MAGNETI MARELLI
FORD
Sierra II, Station Wagon

| | | | | | | | | | | |
|-------------------|-----|---------------|-------|---|---|---|----|------------------------|-----------|------------------|
| 2.0 i | 74 | 01/87 → 02/93 | 1.993 | B | M | 4 | 8 | NE5, NEJ | (+)SS | 81602 |
| | 74 | 01/87 → 02/93 | 1.993 | B | M | 4 | 8 | NE5, NEJ | | 81532 |
| | 85 | 01/87 → 02/93 | 1.993 | B | M | 4 | 8 | N4A, N4I | (+)SS | 81602 |
| | 85 | 01/87 → 02/93 | 1.993 | B | M | 4 | 8 | N4A, N4I | → 01-1991 | 81654 |
| | 80 | 06/89 → 02/93 | 1.998 | B | M | 4 | 8 | N8A | (+)SS | 81602 |
| | 80 | 06/89 → 02/93 | 1.998 | B | M | 4 | 8 | N8A | | 81532 |
| | 88 | 01/90 → 02/93 | 1.998 | B | M | 4 | 8 | N9C | → 01-1991 | 81654 |
| | 92 | 06/89 → 02/93 | 1.998 | B | M | 4 | 8 | N9B | → 01-1991 | 81654 |
| | 92 | 01/90 → 02/93 | 1.998 | B | M | 4 | 8 | N9C | → 01-1991 | 81654 |
| 2.0 i Cat. | 74 | 01/87 → 02/93 | 1.993 | B | M | 4 | 8 | N4B | (+)SS | 81602 |
| | 74 | 01/87 → 02/93 | 1.993 | B | M | 4 | 8 | N4B | | 81532 |
| 2.0 RS Cosworth | 150 | 11/87 → 01/90 | 1.993 | B | M | 4 | 16 | N5B | | 81602 |
| S-Max | | | | | | | | | | |
| 1.6 EcoBoost | 118 | 02/11 → | 1.596 | B | M | 4 | 16 | JTWA, JTWB | | 82027 |
| 1.6 TDCi | 85 | 02/11 → | 1.560 | D | M | 4 | 8 | T1WA, T1WB | | 81798 |
| | 85 | 02/11 → | 1.560 | D | M | 4 | 8 | T1WA, T1WB | | 81869 |
| 1.8 TDCi | 74 | 01/07 → | 1.753 | D | M | 4 | 8 | FFWA | | 81802 |
| | 92 | 05/06 → | 1.753 | D | M | 4 | 8 | QYWA | | 81802 |
| 2.0 | 107 | 05/06 → | 1.999 | B | M | 4 | 16 | AOWA, AOWB | | 81804 |
| 2.0 EcoBoost | 146 | 07/10 → | 1.999 | B | M | 4 | 16 | TNWB | | 81804 |
| | 149 | 03/10 → | 1.999 | B | M | 4 | 16 | TNWA | | 81804 |
| | 176 | 02/15 → | 1.999 | B | M | 4 | 16 | R9CD, R9CI | | 81804 |
| | 176 | 07/10 → | 1.999 | B | M | 4 | 16 | TPWA | | 81804 |
| 2.0 Flexifuel | 107 | 05/06 → | 1.999 | | M | 4 | 16 | TBWA, TBWB | | 81804 |
| 2.0 TDCi | 85 | 11/07 → | 1.997 | D | M | 4 | 16 | KLWA, TYWA | | 81800 |
| | 96 | 05/06 → | 1.997 | D | M | 4 | 16 | AZWA | | 81800 |
| | 100 | 05/06 → | 1.997 | D | M | 4 | 16 | AZWC, UKWA | | 81800 |
| | 103 | 05/06 → | 1.997 | D | M | 4 | 16 | QXWA, QXWB, QXWC, UFWA | | 81800 |
| | 110 | 02/15 → | 1.997 | D | M | 4 | 16 | T7CI, T7CJ, T7CK, T7CL | | 82068 |
| | 120 | 03/10 → | 1.997 | D | M | 4 | 16 | TXWA | | 84020 NEW |
| | 132 | 02/15 → | 1.997 | D | M | 4 | 16 | T8CG, T8CH, T8CI, T8CJ | | 82068 |
| 2.0 TDCi 4x4 | 110 | 02/15 → | 1.997 | D | M | 4 | 16 | T7CI, T7CJ, T7CK, T7CL | | 82068 |
| | 132 | 02/15 → | 1.997 | D | M | 4 | 16 | T8CG, T8CH, T8CI, T8CJ | | 82068 |
| 2.0 TDCi BI-Turbo | 154 | 02/15 → | 1.997 | D | M | 4 | 16 | T9CB, T9CC | | 82068 |
| 2.2 TDCi | 129 | 03/08 → | 2.179 | D | M | 4 | 16 | Q4WA | | 82068 |
| | 147 | 07/10 → | 2.179 | D | M | 4 | 16 | KNWA | | 82068 |
| 2.3 | 118 | 07/07 → | 2.261 | B | M | 4 | 16 | SEWA | | 81804 |
| 2.5 ST | 162 | 05/06 → | 2.521 | B | M | 5 | 20 | HUWA | | 82056 |

| | | | | | | | | | |
|--|--|--|--|--|--|--|--|--|--|
| | | | | | | | | | |
|--|--|--|--|--|--|--|--|--|--|

FORD

Tourneo I Connect, Grand Tourneo Connect

| | | | | | | | | | | |
|--------------------|----|---------------|-------|---|---|---|----|--|--|-------|
| 1.8 16V | 85 | 06/02 → 12/13 | 1.796 | B | M | 4 | 16 | EYPA, EYPC, EYPD | | 81803 |
| 1.8 TDCi | 66 | 06/02 → 12/13 | 1.753 | D | M | 4 | 8 | HCPA, HCPB, P9PA, P9PB, P9PC, P9PD, R3PA, RWPE, RWPF | | 81802 |
| | 81 | 08/06 → 12/13 | 1.753 | D | M | 4 | 8 | RWPA, RWPC, RWPD | | 81802 |
| 1.8 TDCi /TDDi /DI | 55 | 06/02 → 12/13 | 1.753 | D | M | 4 | 8 | BHPA, P7PA, P7PB, R2PA | | 81802 |

Tourneo II Connect, Courier, Custom

| | | | | | | | | | | |
|--------------|-----|---------|-------|---|---|---|----|------------------|--|------------------|
| 1.0 EcoBoost | 74 | 11/13 → | 998 | B | M | 3 | 12 | M2GA, M2GB | | 84036 NEW |
| 1.6 EcoBoost | 110 | 11/13 → | 1.596 | B | M | 4 | 16 | JQGA | | 82027 |
| 1.6 TDCi | 55 | 09/13 → | 1.560 | D | M | 4 | 8 | UBGA | | 81798 |
| | 55 | 09/13 → | 1.560 | D | M | 4 | 8 | UBGA | | 81869 |
| | 70 | 09/13 → | 1.560 | D | M | 4 | 8 | TZGA, TZGB | | 81798 |
| | 70 | 09/13 → | 1.560 | D | M | 4 | 8 | TZGA, TZGB | | 81869 |
| | 85 | 09/13 → | 1.560 | D | M | 4 | 8 | T1GA | | 81798 |
| | 85 | 09/13 → | 1.560 | D | M | 4 | 8 | T1GA | | 81869 |
| 2.2 TDCi | 74 | 04/12 → | 2.198 | D | M | 4 | 16 | DRF4, DRFF, DRFG | | 82066 |
| | 92 | 04/12 → | 2.198 | D | M | 4 | 16 | CYF4, CYFF | | 82066 |
| | 114 | 04/12 → | 2.198 | D | M | 4 | 16 | CVFF | | 82066 |

Transit Connect I

| | | | | | | | | | | |
|-------------|----|---------------|-------|---|---|---|----|--|--|-------|
| 1.8 16V | 85 | 06/02 → 12/13 | 1.796 | B | M | 4 | 16 | EYPA, EYPC, EYPD | | 81803 |
| 1.8 16V LPG | 85 | 06/02 → 12/13 | 1.796 | | M | 4 | 16 | EYPC | | 81803 |
| 1.8 Di | 55 | 06/02 → 12/13 | 1.753 | D | M | 4 | 8 | BHPA, P7PA, P7PB, R2PA | | 81802 |
| 1.8 TDCi | 66 | 06/02 → 12/13 | 1.753 | D | M | 4 | 8 | HCPA, HCPB, P9PA, P9PB, P9PC, P9PD, R3PA, RWPE, RWPF | | 81802 |
| | 81 | 08/06 → 12/13 | 1.753 | D | M | 4 | 8 | RWPA, RWPC, RWPD | | 81802 |

Transit Connect II, Courier

| | | | | | | | | | | |
|--------------|-----|---------|-------|---|---|---|----|------------|--|------------------|
| 1.0 EcoBoost | 74 | 02/13 → | 998 | B | M | 3 | 12 | M2GA | | 84036 NEW |
| 1.6 EcoBoost | 110 | 11/13 → | 1.596 | B | M | 4 | 16 | JQGA | | 82027 |
| 1.6 TDCi | 55 | 02/13 → | 1.560 | D | M | 4 | 8 | UBGA | | 81798 |
| | 55 | 02/13 → | 1.560 | D | M | 4 | 8 | UBGA | | 81869 |
| | 70 | 02/13 → | 1.560 | D | M | 4 | 8 | TZGA, TZGB | | 81798 |
| | 70 | 02/13 → | 1.560 | D | M | 4 | 8 | TZGA, TZGB | | 81869 |
| | 85 | 02/13 → | 1.560 | D | M | 4 | 8 | T1GA | | 81798 |
| | 85 | 02/13 → | 1.560 | D | M | 4 | 8 | T1GA | | 81869 |

Transit Custom

| | | | | | | | | | | |
|----------|-----|---------|-------|---|---|---|----|------------------|--|-------|
| 2.2 TDCi | 74 | 04/12 → | 2.198 | D | M | 4 | 16 | DRF4, DRFF, DRFG | | 82066 |
| | 92 | 04/12 → | 2.198 | D | M | 4 | 16 | CYF4, CYFF | | 82066 |
| | 114 | 04/12 → | 2.198 | D | M | 4 | 16 | CVFF | | 82066 |

KW

cm³

NO. OF VALVES

FORD
Transit IV

| | | | | | | | | | | |
|--------|----|---------------|-------|---|---|---|---|---------------|----|-------|
| 1.6 | 46 | 09/85 → 09/92 | 1.593 | B | M | 4 | 8 | LAT | VA | 81602 |
| | 46 | 09/85 → 09/92 | 1.593 | B | M | 4 | 8 | LAT | | 81532 |
| 2.0 | 57 | 12/85 → 09/92 | 1.993 | B | M | 4 | 8 | N6T | VA | 81602 |
| | 57 | 12/85 → 09/92 | 1.993 | B | M | 4 | 8 | N6T | | 81532 |
| | 57 | 11/85 → 09/92 | 1.994 | B | M | 4 | 8 | NAT, NAV | VA | 81602 |
| | 57 | 11/85 → 09/92 | 1.994 | B | M | 4 | 8 | NAT, NAV | | 81532 |
| 2.5 D | 50 | 01/86 → 09/91 | 2.496 | D | M | 4 | 8 | 4AB | | 81559 |
| | 52 | 09/88 → 09/92 | 2.496 | D | M | 4 | 8 | 4AB, 4BA, 4CA | | 81559 |
| | 52 | 10/88 → 09/91 | 2.496 | D | M | 4 | 8 | 4BA, 4CA | | 81559 |
| 2.5 DI | 52 | 09/88 → 09/92 | 2.496 | D | M | 4 | 8 | 4BA, 4CA | | 81559 |

Transit Tourneo I

| | | | | | | | | | | |
|--------|----|---------------|-------|---|---|---|---|--------------------|--|-------|
| 2.0 | 84 | 11/94 → 12/00 | 1.998 | B | M | 4 | 8 | NSH | | 81602 |
| 2.4 D | 55 | 08/94 → 06/00 | 2.496 | D | M | 4 | 8 | 4HA | | 81559 |
| 2.5 DI | 51 | 11/94 → 12/00 | 2.496 | D | M | 4 | 8 | 4FA, 4FB, 4FC, 4FD | | 81559 |
| | 56 | 11/94 → 12/00 | 2.496 | D | M | 4 | 8 | 4HA, 4HB, 4HC | | 81559 |
| 2.5 TD | 63 | 11/94 → 12/00 | 2.496 | D | M | 4 | 8 | 4GA, 4GB, 4GC | | 81559 |
| | 74 | 04/98 → 12/00 | 2.496 | D | M | 4 | 8 | 4EB, 4EC | | 81559 |

Transit Tourneo II

| | | | | | | | | | | |
|----------|-----|---------------|-------|---|---|---|----|------------------------------|--|-------|
| 2.2 TDCi | 81 | 07/06 → 08/14 | 2.198 | D | M | 4 | 16 | QVFA | | 82066 |
| | 85 | 10/08 → 08/14 | 2.198 | D | M | 4 | 16 | SRFA, SRFB, SRFC, SRFD, SRFE | | 82066 |
| | 96 | 07/06 → 08/14 | 2.198 | D | M | 4 | 16 | QWFA | | 82066 |
| | 103 | 10/07 → 08/14 | 2.198 | D | M | 4 | 16 | PGFA, PGFB, UHFA, UHFB | | 82066 |

Transit V

| | | | | | | | | | | |
|--------|----|---------------|-------|---|---|---|---|--------------------|--|-------|
| 2.0 | 66 | 09/91 → 09/94 | 1.993 | B | M | 4 | 8 | NBA | | 81602 |
| | 72 | 09/91 → 08/94 | 1.994 | B | M | 4 | 8 | NCA | | 81602 |
| 2.0 i | 72 | 09/91 → 07/94 | 1.994 | B | M | 4 | 8 | NCA | | 81602 |
| 2.5 DI | 51 | 09/91 → 08/94 | 2.496 | D | M | 4 | 8 | 4AB, 4BC, 4CC, 4FA | | 81559 |
| | 51 | 08/91 → 07/94 | 2.496 | D | M | 4 | 8 | 4BC, 4CC, 4FA | | 81559 |
| | 59 | 09/91 → 07/94 | 2.496 | D | M | 4 | 8 | 4DA | | 81559 |
| | 63 | 10/92 → 06/94 | 2.496 | D | M | 4 | 8 | 4GA | | 81559 |
| 2.5 TD | 63 | 10/92 → 07/94 | 2.496 | D | M | 4 | 8 | 4GA, 4GB, 4GC | | 81559 |
| | 74 | 09/91 → 07/94 | 2.496 | D | M | 4 | 8 | 4EA | | 81559 |

Transit VI

| | | | | | | | | | | |
|---------|----|---------------|-------|---|---|---|---|------------------------------|--|-------|
| 2.0 | 84 | 09/95 → 03/00 | 1.998 | B | M | 4 | 8 | NSF, NSG | | 81602 |
| 2.0 CNG | 84 | 06/94 → 03/00 | 1.998 | | M | 4 | 8 | NSH | | 81602 |
| 2.5 DI | 51 | 08/94 → 03/00 | 2.496 | D | M | 4 | 8 | 4FA, 4FB, 4FC, 4FD | | 81559 |
| | 56 | 07/94 → 03/00 | 2.496 | D | M | 4 | 8 | 4HB, 4HC | | 81559 |
| | 85 | 08/97 → 03/00 | 2.496 | D | M | 4 | 8 | 4ED | | 81559 |
| 2.5 TD | 55 | 08/94 → 06/00 | 2.496 | D | M | 4 | 8 | 4HA, 4HD | | 81559 |
| | 63 | 01/95 → 03/00 | 2.496 | D | M | 4 | 8 | 4GA, 4GB, 4GC, 4GD, 4GE, 4GF | | 81559 |
| | 74 | 07/94 → 03/00 | 2.496 | D | M | 4 | 8 | 4EB, 4EC | | 81559 |

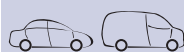
KW

cm³

NO. OF VALVES

MAGNETI MARELLI
FORD
Transit VI

| | | | | | | | | | | |
|---------|----|---------------|-------|---|---|---|---|----------|--|-------|
| 2.5 TDI | 74 | 06/94 → 03/00 | 2.496 | D | M | 4 | 8 | 4EB, 4EC | | 81559 |
|---------|----|---------------|-------|---|---|---|---|----------|--|-------|

Transit VII

| | | | | | | | | | | |
|---------------|-----|---------------|-------|---|---|---|----|------------------|--|-------|
| 2.0 DI | 55 | 08/00 → 05/06 | 1.998 | D | M | 4 | 16 | D3FA | | 81805 |
| | 63 | 08/00 → 05/06 | 1.998 | D | M | 4 | 16 | F3FA | | 81805 |
| | 74 | 08/00 → 05/06 | 1.998 | D | M | 4 | 16 | ABFA | | 81805 |
| 2.0 TDCi | 92 | 08/02 → 05/06 | 1.998 | D | M | 4 | 16 | F1FA | | 81805 |
| | 92 | 08/02 → 05/06 | 1.998 | D | M | 4 | 16 | F1FA | | 81805 |
| 2.3 | 105 | 03/01 → 03/06 | 2.295 | B | M | 4 | 16 | E5FC | | 81654 |
| | 107 | 08/00 → 03/06 | 2.295 | B | M | 4 | 16 | E5FA | | 81654 |
| 2.3 16V | 107 | 04/01 → 05/06 | 2.295 | B | M | 4 | 16 | E5FA, E5FC | | 81654 |
| 2.3 16V [RWD] | 107 | 08/00 → 05/06 | 2.295 | B | M | 4 | 16 | E5FA, E5FC | | 81654 |
| 2.4 DI | 55 | 01/00 → 05/06 | 2.402 | D | M | 4 | 16 | F4FA | | 82057 |
| | 66 | 01/00 → 05/06 | 2.402 | D | M | 4 | 16 | D2FA, D2FB, D2FE | | 82057 |
| | 88 | 01/00 → 05/06 | 2.402 | D | M | 4 | 16 | D4FA | | 82057 |
| 2.4 DI [RWD] | 55 | 01/00 → 05/06 | 2.402 | D | M | 4 | 16 | F4FA | | 82057 |
| | 88 | 01/00 → 05/06 | 2.402 | D | M | 4 | 16 | D4FA | | 82057 |
| 2.4 TD | 55 | 08/00 → 08/03 | 2.402 | D | M | 4 | 16 | F4FA | | 82057 |
| 2.4 TDCi | 101 | 03/04 → 05/06 | 2.402 | D | M | 4 | 16 | H9FA | | 82057 |
| 2.4 Tdci | 66 | 10/01 → 03/06 | 2.402 | D | M | 4 | 16 | D2FE | | 82057 |
| | 88 | 08/00 → 08/03 | 2.402 | D | M | 4 | 16 | D4FA | | 82057 |
| 2.4 TDE | 85 | 03/04 → 05/06 | 2.402 | D | M | 4 | 16 | FXFA | | 82057 |
| 2.4 TDE | 92 | 07/01 → 05/06 | 2.402 | D | M | 4 | 16 | DOFA | | 82057 |
| | 92 | 07/01 → 05/06 | 2.402 | D | M | 4 | 16 | DOFA | | 82057 |

Transit XIII

| | | | | | | | | | | |
|----------------|-----|---------------|-------|---|---|---|----|------------------------------|--|-------|
| 2.2 TDCi | 63 | 04/06 → 08/14 | 2.198 | D | M | 4 | 16 | P8FA, P8FB | | 82066 |
| | 74 | 10/11 → 08/14 | 2.198 | D | M | 4 | 16 | DRFA, DRFB, DRFC, DRFD, DRFE | | 82066 |
| | 81 | 04/06 → 08/14 | 2.198 | D | M | 4 | 16 | QVFA | | 82066 |
| | 85 | 10/08 → 08/14 | 2.198 | D | M | 4 | 16 | SRFA, SRFB, SRFC, SRFD, SRFE | | 82066 |
| | 92 | 10/11 → 08/14 | 2.198 | D | M | 4 | 16 | CYFA, CYFB, CYFC, CYFD | | 82066 |
| | 96 | 04/06 → 08/14 | 2.198 | D | M | 4 | 16 | QWFA | | 82066 |
| | 103 | 10/07 → 08/14 | 2.198 | D | M | 4 | 16 | PGFA, PGFB, UHFA, UHFB, UHFC | | 82066 |
| 2.3 16V [RWD] | 107 | 04/06 → 08/14 | 2.261 | B | M | 4 | 16 | GZFA, GZFB, GZFC | | 81654 |
| 2.4 TDCi | 74 | 04/06 → 08/14 | 2.402 | D | M | 4 | 16 | PHFA, PHFC | | 82057 |
| | 85 | 04/06 → 08/14 | 2.402 | D | M | 4 | 16 | JXFA, JXFC | | 82057 |
| | 103 | 04/06 → 08/14 | 2.402 | D | M | 4 | 16 | H9FD | | 82057 |
| 2.4 TDCi [RWD] | 74 | 04/06 → 08/14 | 2.402 | D | M | 4 | 16 | PHFA, PHFC | | 82057 |
| | 85 | 04/06 → 08/14 | 2.402 | D | M | 4 | 16 | JXFA, JXFC | | 82057 |
| | 103 | 04/06 → 08/14 | 2.402 | D | M | 4 | 16 | H9FB, H9FD | | 82057 |
| | 103 | 04/06 → 08/14 | 2.402 | D | M | 4 | 16 | H9FD | | 82057 |
| 2.4 TDCi 4x4 | 103 | 11/06 → 08/14 | 2.402 | D | M | 4 | 16 | H9FB | | 82057 |

KW

cm³

NO. OF VALVES

HONDA
Accord IV, Aerodeck, Coupé

| | | | | | | | | | | |
|---------------------|-----|---------------|-------|---|---|---|----|--------------|--|-------|
| 2.0 16V | 66 | 01/90 → 03/93 | 1.997 | B | M | 4 | 16 | F20A6 | | 81708 |
| | 81 | 01/90 → 03/93 | 1.997 | B | M | 4 | 16 | F20A2, F20A3 | | 81708 |
| 2.0 i 16V | 98 | 01/90 → 03/93 | 1.997 | B | M | 4 | 16 | F20A4, F20A8 | | 81708 |
| | 98 | 01/92 → 09/93 | 1.997 | B | M | 4 | 16 | F20A7 | | 81708 |
| | 98 | 03/93 → 12/93 | 1.997 | B | M | 4 | 16 | F20Z3 | | 81708 |
| 2.2 i 16V | 108 | 01/91 → 12/93 | 2.156 | B | M | 4 | 16 | F22A8 | | 81708 |
| | 110 | 01/90 → 03/93 | 2.156 | B | M | 4 | 16 | F22A3 | | 81708 |
| | 110 | 01/91 → 12/93 | 2.156 | B | M | 4 | 16 | F22A7 | | 81708 |
| 2.2 i 16V Automatic | 108 | 01/90 → 03/93 | 2.156 | B | M | 4 | 16 | F22A3 | | 81708 |

Accord V, Aerodeck, Coupé

| | | | | | | | | | | |
|--------------|-----|---------------|-------|---|---|---|----|-------|--|-------|
| 1.9 i | 85 | 02/96 → 10/98 | 1.850 | B | M | 4 | 16 | F18A3 | | 81708 |
| 2.0 | 100 | 09/93 → 12/97 | 1.997 | B | M | 4 | 16 | F20B3 | | 81708 |
| 2.0 i | 85 | 03/93 → 01/96 | 1.997 | B | M | 4 | 16 | F20Z2 | | 81708 |
| 2.0 i LS | 96 | 02/96 → 10/98 | 1.997 | B | M | 4 | 16 | F20Z1 | | 81708 |
| 2.0 i LS 16V | 100 | 09/93 → 02/98 | 1.997 | B | M | 4 | 16 | F20B3 | | 81708 |
| 2.0 i S | 96 | 03/93 → 01/96 | 1.997 | B | M | 4 | 16 | F20Z1 | | 81708 |
| 2.0 TDi | 77 | 04/96 → 10/98 | 1.994 | D | M | 4 | 8 | 20T2N | | 81707 |
| 2.2 i ES | 110 | 09/93 → 02/98 | 2.156 | B | M | 4 | 16 | F22B5 | | 81708 |
| 2.2 i VTEC | 110 | 02/96 → 10/98 | 2.156 | B | M | 4 | 16 | F22Z2 | | 81708 |
| 2.3 i SR | 116 | 03/93 → 01/96 | 2.259 | B | M | 4 | 16 | H23A3 | | 81709 |

Accord VI, Aerodeck, Hatchback, Coupé

| | | | | | | | | | | |
|--------------|-----|---------------|-------|---|---|---|----|--------------|--|-------|
| 1.6 | 85 | 12/99 → 12/02 | 1.590 | B | M | 4 | 16 | D16B6 | | 81838 |
| | 65 | 10/98 → 12/02 | 1.598 | B | M | 4 | 12 | A16A5 | | 81838 |
| 1.6 i | 85 | 10/98 → 12/02 | 1.590 | B | M | 4 | 16 | D16B6 | | 81838 |
| 1.6 LS | 79 | 10/98 → 12/02 | 1.590 | B | M | 4 | 16 | D16B7 | | 81838 |
| 2.0 | 108 | 12/99 → 12/02 | 1.997 | B | M | 4 | 16 | F20B6 | | 81708 |
| 2.0 i | 108 | 10/98 → 01/01 | 1.997 | B | M | 4 | 16 | F20B6 | | 81708 |
| 2.0 i 16V | 108 | 02/98 → 06/03 | 1.997 | B | M | 4 | 16 | F20B5, F20B7 | | 81708 |
| 2.0 TDi | 77 | 12/99 → 10/00 | 1.994 | D | M | 4 | 8 | 20T2N | | 81707 |
| 2.0 Turbo Di | 77 | 02/99 → 12/02 | 1.994 | D | M | 4 | 8 | 20T2N | | 81707 |
| 2.3 | 113 | 01/01 → 06/03 | 2.254 | B | M | 4 | 16 | F23A1, F23Z5 | | 81708 |
| | 113 | 11/00 → 12/02 | 2.254 | B | M | 4 | 16 | F23Z5 | | 81708 |
| 2.3 16 V | 118 | 02/98 → | 2.254 | B | M | 4 | 16 | F23A7 | | 81708 |
| 2.3 VTi | 113 | 02/98 → 10/02 | 2.254 | B | M | 4 | 16 | F23A3 | | 81708 |

Accord VII, Aerodeck, Hatchback, Coupé

| | | | | | | | | | | |
|------------------------|-----|---------------|-------|---|----|---|----|-------|--|-------|
| 2.0 | 114 | 02/03 → 05/08 | 1.998 | B | AM | 4 | 16 | K20A6 | | 81708 |
| | 114 | 04/03 → 05/08 | 1.998 | B | M | 4 | 16 | K20A6 | | 81708 |
| 2.0 Trazione integrale | 114 | 02/03 → 05/08 | 1.998 | B | AM | 4 | 16 | K20A6 | | 81708 |
| 2.2 i-CTDi | 103 | 01/04 → 05/08 | 2.204 | D | M | 4 | 16 | N22A1 | | 82093 |

Civic II Shuttle

| | | | | | | | | | | |
|---------------|----|---------------|-------|---|---|---|----|-------------|--|-------|
| 1.4 i 16V | 66 | 01/88 → 12/92 | 1.396 | B | M | 4 | 16 | D14A1 | | 81613 |
| 1.5 i 16V | 69 | 01/88 → 11/91 | 1.493 | B | M | 4 | 16 | D15B2 | | 81613 |
| 1.6 4x4 | 85 | 01/88 → 12/92 | 1.590 | B | M | 4 | 16 | D16A, D16A7 | | 81613 |
| 1.6 i 16V 4WD | 81 | 01/88 → 02/95 | 1.590 | B | M | 4 | 16 | D16A6 | | 81613 |

KW

cm³

NO. OF VALVES

HONDA
Civic IV, Hatchback

| | | | | | | | | | | |
|----------------|-----|---------------|-------|---|---|---|----|--------------|--|-------|
| 1.3 16 V | 55 | 09/89 → 09/91 | 1.343 | B | M | 4 | 16 | D13B2 | | 81611 |
| 1.5 i 16V | 66 | 10/88 → 09/91 | 1.493 | B | M | 4 | 16 | D15B2 | | 81613 |
| | 69 | 10/88 → 09/91 | 1.493 | B | M | 4 | 16 | D15B2 | | 81613 |
| 1.6 4x4 | 110 | 01/88 → 12/91 | 1.590 | B | M | 4 | 16 | D16W4 | | 81613 |
| 1.6 i 16V | 96 | 09/87 → 09/91 | 1.590 | B | M | 4 | 16 | D16A7 | | 81613 |
| | 96 | 09/87 → 09/91 | 1.590 | B | M | 4 | 16 | D16A7, D16A9 | | 81613 |
| | 80 | 10/87 → 09/91 | 1.590 | B | M | 4 | 16 | D16A6 | | 81613 |
| | 81 | 10/87 → 09/91 | 1.590 | B | M | 4 | 16 | D16Z2 | | 81613 |
| 1.6 i 16V 4x4 | 80 | 10/89 → 09/91 | 1.590 | B | M | 4 | 16 | D16A6 | | 81613 |
| 1.6 i 16V Vtec | 110 | 10/89 → 09/91 | 1.595 | B | M | 4 | 16 | B16A1 | | 81613 |

Civic IX, Hatchback, Coupé

| | | | | | | | | | | | |
|------------|----|---------|-------|---|---|---|----|-------|--|-------|------------|
| 1.4 i-VTEC | 73 | 02/12 → | 1.339 | B | M | 4 | 16 | L13Z4 | | 84065 | NEW |
|------------|----|---------|-------|---|---|---|----|-------|--|-------|------------|

Civic V, Hatchback, Coupé

| | | | | | | | | | | |
|--------------|-----|---------------|-------|---|---|---|----|--------------|--|-------|
| 1.3 16V | 55 | 10/91 → 11/95 | 1.343 | B | M | 4 | 16 | D13B2 | | 81613 |
| 1.5 | 61 | 01/92 → 12/92 | 1.493 | B | M | 4 | 16 | D15B2 | | 81613 |
| | 66 | 10/93 → 12/95 | 1.493 | B | M | 4 | 16 | D15B2 | | 81613 |
| | 74 | 10/93 → 12/95 | 1.493 | B | M | 4 | 16 | D15B2, D15Z1 | | 81613 |
| 1.5 i 16V | 66 | 10/91 → 11/95 | 1.493 | B | M | 4 | 16 | D15B2, D15Z2 | | 81613 |
| | 69 | 10/91 → 11/95 | 1.493 | B | M | 4 | 16 | D15B2, D15Z1 | | 81613 |
| 1.5 i LSi | 74 | 08/93 → 11/95 | 1.493 | B | M | 4 | 16 | D15B7 | | 81613 |
| 1.6 16V Vtec | 92 | 10/91 → 11/95 | 1.590 | B | M | 4 | 16 | D16Z6 | | 81613 |
| 1.6 4x4 | 92 | 01/92 → 10/95 | 1.590 | B | M | 4 | 16 | D16Z7 | | 81613 |
| 1.6 EX | 88 | 08/93 → 10/95 | 1.590 | B | M | 4 | 16 | D16A7 | | 81613 |
| 1.6 i | 77 | 01/94 → 11/95 | 1.590 | B | M | 4 | 16 | D16Y7 | | 81613 |
| 1.6 i Vtec | 118 | 01/94 → 11/95 | 1.595 | B | M | 4 | 16 | B16A2 | | 81839 |
| | 92 | 01/94 → 03/96 | 1.590 | B | M | 4 | 16 | D16Y6, D16Z9 | | 81613 |
| 1.6 VTi | 118 | 10/91 → 11/95 | 1.595 | B | M | 4 | 16 | B16A2 | | 81839 |
| 1.6 VTi 16V | 118 | 10/91 → 11/95 | 1.595 | B | M | 4 | 16 | B16A2 | | 81839 |

Civic VI, Hatchback, Aerodeck, Fastback, Coupé

| | | | | | | | | | | |
|--------------|----|---------------|-------|---|---|---|----|----------------------------|---------|-------|
| 1.4 | 55 | 11/95 → 10/98 | 1.396 | B | M | 4 | 16 | D14A4 | | 81613 |
| 1.4 16V | 55 | 04/98 → 02/01 | 1.396 | B | M | 4 | 16 | D14A7 | M: SOHC | 81838 |
| | 66 | 04/98 → 02/01 | 1.396 | B | M | 4 | 16 | D14A8 | M: SOHC | 81838 |
| 1.4 i | 55 | 11/95 → 02/01 | 1.396 | B | M | 4 | 16 | D14A3, D14Z1 | | 81838 |
| | 55 | 09/95 → 02/01 | 1.396 | B | M | 4 | 16 | D14A5, D14A7, D14Z3 | | 81613 |
| | 66 | 09/94 → 02/01 | 1.396 | B | M | 4 | 16 | D14A2, D14A6, D14A8, D14Z4 | | 81613 |
| | 66 | 11/95 → 02/01 | 1.396 | B | M | 4 | 16 | D14A4, D14Z2, D14Z4 | | 81613 |
| 1.4 i S | 66 | 11/95 → 02/01 | 1.396 | B | M | 4 | 16 | D14A4, D14Z2, D14Z4 | | 81613 |
| 1.5 16V | 84 | 04/98 → 02/01 | 1.493 | B | M | 4 | 16 | D15Z8 | | 81838 |
| 1.5 i | 84 | 11/95 → 02/01 | 1.493 | B | M | 4 | 16 | D15Z6 | | 81838 |
| 1.5 i Vtec-E | 66 | 09/94 → 01/97 | 1.493 | B | M | 4 | 16 | D15Z3 | | 81613 |
| 1.6 | 92 | 11/98 → 10/00 | 1.590 | B | M | 4 | 16 | D16W4 | | 81838 |
| | 93 | 10/95 → 09/00 | 1.590 | B | M | 4 | 16 | D16Y2 | | 81613 |
| 1.6 16V | 85 | 04/98 → 02/01 | 1.590 | B | M | 4 | 16 | D16B2 | | 81838 |

KW

cm³

NO. OF VALVES

HONDA
Civic VI, Hatchback, Aerodeck, Fastback, Coupé

| | | | | | | | | | | |
|------------|-----|---------------|-------|---|---|---|----|--------------|---------|-------|
| 1.6 i | 77 | 03/96 → 03/00 | 1.590 | B | M | 4 | 16 | D16Y7 | M: SOHC | 81838 |
| | 83 | 09/94 → 01/97 | 1.590 | B | M | 4 | 16 | D16Y3 | | 81613 |
| | 84 | 11/95 → 02/01 | 1.590 | B | M | 4 | 16 | D16Y5 | | 81838 |
| 1.6 i Vtec | 92 | 11/95 → 02/01 | 1.590 | B | M | 4 | 16 | D16Y6, D16Y8 | | 81838 |
| | 92 | 03/96 → 03/00 | 1.590 | B | M | 4 | 16 | D16Y8 | | 81838 |
| | 118 | 04/99 → 12/00 | 1.595 | B | M | 4 | 16 | B16A2 | | 81839 |
| 1.6 VTi | 93 | 09/94 → 01/97 | 1.590 | B | M | 4 | 16 | D16Y2 | | 81613 |
| | 118 | 01/97 → 02/01 | 1.595 | B | M | 4 | 16 | B16A2 | | 81839 |
| 1.8 16V | 118 | 11/95 → 02/01 | 1.595 | B | M | 4 | 16 | B16A2 | | 81839 |
| 2.0 i D | 124 | 04/98 → 02/01 | 1.797 | B | M | 4 | 16 | B18C4 | | 81839 |
| 2.0 i TD | 77 | 04/98 → 02/01 | 1.994 | D | M | 4 | 8 | 20T2N | | 81707 |
| 2.0 TDiC | 63 | 01/97 → 02/01 | 1.994 | D | M | 4 | 8 | 20T2R | | 81707 |
| | 77 | 11/98 → 10/00 | 1.994 | D | M | 4 | 8 | 20T2N | | 81707 |
| | 74 | 11/98 → 10/00 | 1.994 | D | M | 4 | 8 | 20T2N | | 81707 |

Civic VII, Hatchback, Coupé

| | | | | | | | | | | |
|------------|----|---------------|-------|---|----|---|----|--------------|--|-------|
| 1.4 | 66 | 12/00 → 09/05 | 1.396 | B | M | 4 | 16 | D14Z5 | | 82039 |
| 1.4 i | 55 | 02/01 → 09/05 | 1.396 | B | M | 4 | 16 | D14Z6 | | 81838 |
| 1.4 iS | 66 | 02/01 → 09/05 | 1.396 | B | AM | 4 | 16 | D14Z5, D14Z6 | | 82039 |
| 1.6 | 84 | 02/01 → 09/05 | 1.586 | B | M | 4 | 16 | R16A1 | | 82039 |
| | 81 | 02/01 → 09/05 | 1.590 | B | M | 4 | 16 | D16V1 | | 82039 |
| 1.6 i | 81 | 02/01 → 12/05 | 1.590 | B | AM | 4 | 16 | D16V1 | | 82039 |
| 1.7 | 85 | 02/01 → 09/05 | 1.668 | B | M | 4 | 16 | D17A6 | | 82039 |
| 1.7 i | 88 | 05/01 → 12/05 | 1.668 | B | M | 4 | 16 | D17A8 | | 82039 |
| 1.7 i VTEC | 92 | 05/01 → 12/05 | 1.668 | B | M | 4 | 16 | D17A5, D17A9 | | 82039 |

Civic VIII, Hatchback, Coupé

| | | | | | | | | | | |
|----------|-----|---------|-------|---|---|---|----|-------|--|------------------|
| 1.4 | 61 | 09/05 → | 1.339 | B | M | 4 | 8 | L13A7 | | 82045 |
| | 73 | 10/08 → | 1.339 | B | M | 4 | 16 | L13Z1 | | 84065 NEW |
| 2.2 CTDi | 103 | 09/05 → | 2.204 | D | M | 4 | 16 | N22A2 | | 82093 |

Concerto

| | | | | | | | | | | |
|-----------|----|---------------|-------|---|---|---|----|--------------|--|-------|
| 1.4 | 61 | 10/89 → 10/92 | 1.396 | B | M | 4 | 16 | D14A1 | | 81613 |
| | 66 | 08/89 → 10/91 | 1.396 | B | M | 4 | 16 | D14A1, D14A8 | | 81613 |
| 1.5 i 16V | 66 | 08/89 → 03/95 | 1.493 | B | M | 4 | 16 | D15B2 | | 81613 |
| 1.6 | 96 | 10/89 → 10/92 | 1.590 | B | M | 4 | 16 | D16A9 | | 81613 |
| 1.6 16V | 78 | 08/89 → 03/95 | 1.590 | B | M | 4 | 16 | D16Z2 | | 81613 |
| 1.6 i 16V | 82 | 08/89 → 03/95 | 1.590 | B | M | 4 | 16 | D16Z2 | | 81613 |
| | 90 | 08/89 → 03/95 | 1.590 | B | M | 4 | 16 | D16A8 | | 81613 |

CR-V II

| | | | | | | | | | | |
|----------|-----|---------------|-------|---|---|---|----|-------|--|-------|
| 2.2 CTDi | 103 | 02/05 → 09/06 | 2.204 | D | M | 4 | 16 | N22A2 | | 82093 |
|----------|-----|---------------|-------|---|---|---|----|-------|--|-------|

CR-V III

| | | | | | | | | | | |
|----------------|-----|---------|-------|---|---|---|----|-------|--|-------|
| 2.2 i-CTDi 4WD | 103 | 01/07 → | 2.204 | D | M | 4 | 16 | N22A2 | | 82093 |
|----------------|-----|---------|-------|---|---|---|----|-------|--|-------|

CRX II

| | | | | | | | | | | |
|----------------|-----|---------------|-------|---|---|---|----|-------|--|-------|
| 1.6 i 16V | 91 | 10/87 → 02/92 | 1.590 | B | M | 4 | 16 | D16Z5 | | 81613 |
| 1.6 i 16V Vtec | 110 | 10/89 → 02/92 | 1.595 | B | M | 4 | 16 | B16A1 | | 81613 |

KW

cm³

NO. OF VALVES

HONDA
CRX III

| | | | | | | | | | |
|-----------|-----|---------------|-------|---|---|---|----|--------------|-------|
| 1.6 ESi | 92 | 03/92 → 12/98 | 1.590 | B | M | 4 | 16 | D16Y8, D16Z6 | 81613 |
| 1.6 i VTi | 118 | 03/92 → 12/98 | 1.595 | B | M | 4 | 16 | B16A2 | 81613 |

FR-V

| | | | | | | | | | |
|------------|-----|---------|-------|---|---|---|----|-------|-------|
| 1.7 | 92 | 08/04 → | 1.668 | B | M | 4 | 16 | D17A2 | 82039 |
| 2.2 i CTDi | 103 | 07/05 → | 2.204 | D | M | 4 | 16 | N22A1 | 82093 |

HR-V

| | | | | | | | | | |
|-------------|----|---------|-------|---|---|---|----|-------|-------|
| 1.6 16V | 77 | 03/99 → | 1.590 | B | M | 4 | 16 | D16W1 | 81838 |
| 1.6 16V 4WD | 77 | 03/99 → | 1.590 | B | M | 4 | 16 | D16W1 | 81838 |
| | 91 | 10/99 → | 1.590 | B | M | 4 | 16 | D16W5 | 81838 |

Integra II

| | | | | | | | | | |
|------------|-----|---------------|-------|---|---|---|----|-------|-------|
| 1.8 Type-R | 140 | 11/97 → 10/01 | 1.797 | B | M | 4 | 16 | B18C6 | 81839 |
|------------|-----|---------------|-------|---|---|---|----|-------|-------|

Jazz II

| | | | | | | | | | |
|-----|----|---------------|-------|---|---|---|---|-------|-------|
| 1.2 | 57 | 03/02 → 07/08 | 1.243 | B | M | 4 | 8 | L12A1 | 82045 |
| 1.3 | 61 | 03/02 → 07/08 | 1.339 | B | M | 4 | 8 | L13A1 | 82045 |

Jazz III

| | | | | | | | | | |
|-------|----|---------|-------|---|---|---|----|-------|-------|
| 1.2 | 66 | 07/08 → | 1.198 | B | M | 4 | 16 | L12B1 | 82045 |
| 1.3 i | 73 | 07/08 → | 1.339 | B | M | 4 | 16 | L13Z1 | 82045 |

Prelude IV

| | | | | | | | | | |
|----------------|-----|---------------|-------|---|---|---|----|-------|-------|
| 2.0 i 16V | 98 | 02/92 → 09/96 | 1.997 | B | M | 4 | 16 | F20A4 | 81708 |
| 2.2 i 16V Vtec | 136 | 02/93 → 09/96 | 2.157 | B | M | 4 | 16 | H22A2 | 81708 |
| 2.3 i 16V | 118 | 02/92 → 09/96 | 2.259 | B | M | 4 | 16 | H23A2 | 81709 |

Prelude V

| | | | | | | | | | |
|---------|-----|---------------|-------|---|---|---|----|--------------|-------|
| 2.0 16V | 98 | 10/96 → 10/00 | 1.997 | B | M | 4 | 16 | F20A4 | 81708 |
| 2.2 16V | 147 | 10/96 → 10/00 | 2.157 | B | M | 4 | 16 | H22A5 | 81708 |
| | 136 | 10/96 → 10/00 | 2.157 | B | M | 4 | 16 | H22A2, H22A5 | 81708 |

Shuttle

| | | | | | | | | | |
|-------------|-----|---------------|-------|---|---|---|----|-------|-------|
| 2.2 16V | 110 | 10/94 → 02/98 | 2.156 | B | M | 4 | 16 | F22B8 | 81708 |
| 2.2 4x4 | 102 | 06/94 → 09/97 | 2.156 | B | M | 4 | 16 | F22B9 | 81708 |
| 2.3 16V | 110 | 10/97 → 06/04 | 2.254 | B | M | 4 | 16 | F23A7 | 81708 |
| 2.3 16V 4x4 | 110 | 10/97 → 06/02 | 2.254 | B | M | 4 | 16 | F23A | 81708 |

Stream I

| | | | | | | | | | |
|---------|-----|---------|-------|---|---|---|----|-------|-------|
| 1.7 16V | 92 | 05/01 → | 1.668 | B | M | 4 | 16 | D17A2 | 82039 |
| 2.0 16V | 115 | 05/01 → | 1.998 | B | M | 4 | 16 | K20A1 | 82039 |

HYUNDAI
Accent I

| | | | | | | | | | |
|-----------|----|---------------|-------|---|---|---|----|------|-------|
| 1.3 | 40 | 09/95 → 05/98 | 1.341 | B | M | 4 | 12 | G4EH | 82020 |
| | 44 | 10/94 → 01/00 | 1.341 | B | M | 4 | 12 | G4EH | 81784 |
| | 55 | 10/94 → 01/00 | 1.341 | B | M | 4 | 12 | G4EH | 81784 |
| 1.3 i 12V | 62 | 10/94 → 01/00 | 1.341 | B | M | 4 | 12 | G4EH | 81784 |
| 1.5 i 12V | 65 | 10/94 → 01/00 | 1.495 | B | M | 4 | 12 | G4EK | 81784 |
| 1.5 i 16V | 73 | 12/95 → 01/00 | 1.495 | B | M | 4 | 16 | G4ER | 82020 |

KW

cm³

NO. OF VALVES

HYUNDAI
Accent II

| | | | | | | | | | | |
|----------|----|---------------|-------|---|----|---|----|--------|--|-------|
| 1.3 | 55 | 01/00 → 11/05 | 1.341 | B | M | 4 | 12 | G4EA | | 81784 |
| | 61 | 01/00 → 11/05 | 1.341 | B | M | 4 | 12 | G4EA | | 81784 |
| | 62 | 08/02 → 11/05 | 1.341 | B | M | 4 | 12 | G4EH | | 81784 |
| | 63 | 01/00 → 11/05 | 1.341 | B | A | 4 | 12 | G4EA | | 81784 |
| 1.5 | 66 | 01/00 → 11/05 | 1.495 | B | M | 4 | 12 | G4EB | | 82020 |
| | 75 | 09/00 → 11/05 | 1.495 | B | AM | 4 | 16 | G4EC-G | | 82020 |
| | 75 | 09/99 → 10/02 | 1.495 | B | M | 4 | 16 | G4FK | | 82020 |
| 1.5 CRDi | 60 | 04/02 → 11/05 | 1.493 | D | M | 3 | 12 | D3EA | | 82085 |
| 1.6 | 77 | 12/02 → 11/05 | 1.599 | B | M | 4 | 16 | G4ED-G | | 82020 |

Accent III

| | | | | | | | | | | |
|--------------|----|---------------|-------|---|---|---|----|------|--|------------------|
| 1.4 GL | 71 | 11/05 → 11/10 | 1.399 | B | M | 4 | 16 | G4EE | | 82020 |
| 1.5 CRDi GLS | 81 | 11/05 → 11/10 | 1.493 | D | M | 4 | 16 | D4FA | | 84058 NEW |
| 1.6 GLS | 82 | 11/05 → 11/10 | 1.599 | B | M | 4 | 16 | G4ED | | 82020 |

Atos, Atos Prime

| | | | | | | | | | | |
|-------|----|---------------|-------|---|----|---|----|--------|--|------------------|
| 0.8 | 38 | 04/99 → 07/03 | 798 | B | M | 3 | 6 | G3HJ | | 81837 |
| 1.0 i | 40 | 02/98 → 03/02 | 999 | B | AM | 4 | 12 | G4HC | | 81837 |
| | 43 | 03/01 → | 999 | B | M | 4 | 12 | G4HC-E | | 81837 |
| 1.1 | 43 | 06/03 → | 1.086 | B | M | 4 | 12 | G4HD | | 84018 NEW |
| | 43 | 08/03 → 05/05 | 1.086 | B | M | 4 | 12 | G4HD | | 81837 |
| | 46 | 03/04 → | 1.086 | B | M | 4 | 12 | G4HG | | 84018 NEW |

Coupé I

| | | | | | | | | | | |
|-----------|-----|---------------|-------|---|---|---|----|--------|--|-------|
| 1.6 16V | 77 | 03/02 → 08/09 | 1.599 | B | M | 4 | 16 | G4ED-G | | 82020 |
| | 79 | 03/02 → 08/09 | 1.599 | B | M | 4 | 16 | G4ED-G | | 82020 |
| | 85 | 03/98 → 04/02 | 1.599 | B | M | 4 | 16 | G4GR | | 81785 |
| 1.6 i 16V | 84 | 12/96 → 04/02 | 1.599 | B | M | 4 | 16 | 4G61 | | 81785 |
| 2.0 | 100 | 08/01 → 08/09 | 1.975 | B | M | 4 | 16 | G4GC-G | | 81785 |
| | 101 | 08/99 → 01/02 | 1.975 | B | M | 4 | 16 | G4DF | | 81785 |
| | 102 | 03/02 → 08/09 | 1.975 | B | M | 4 | 16 | G4GC-G | | 81785 |
| 2.0 16V | 99 | 03/01 → 04/02 | 1.975 | B | M | 4 | 16 | G4DF | | 81785 |
| | 102 | 08/96 → 04/02 | 1.975 | B | M | 4 | 16 | G4GF | | 81785 |
| 2.0 GLS | 105 | 02/03 → 08/09 | 1.975 | B | M | 4 | 16 | G4GC-G | | 81785 |
| 2.7 V6 | 121 | 01/07 → 08/09 | 2.656 | B | M | 6 | 24 | G6BA-G | | 82021 |
| | 123 | 03/02 → 08/09 | 2.656 | B | M | 6 | 24 | G6BA-G | | 82021 |

Elantra I

| | | | | | | | | | | |
|----------|-----|---------------|-------|---|----|---|----|--------|--|-------|
| 1.6 | 66 | 06/00 → 07/06 | 1.599 | B | M | 4 | 16 | G4GR | | 82020 |
| | 77 | 05/03 → 07/06 | 1.599 | B | M | 4 | 16 | G4ED-G | | 82020 |
| | 79 | 06/00 → 07/06 | 1.599 | B | AM | 4 | 16 | G4ED-G | | 82020 |
| | 82 | 09/03 → 07/06 | 1.599 | B | M | 4 | 16 | G4GA | | 82020 |
| 1.8 | 79 | 06/00 → 07/03 | 1.795 | B | M | 4 | 16 | G4BB | | 81785 |
| | 97 | 06/00 → 07/06 | 1.795 | B | M | 4 | 16 | G4BB | | 81785 |
| 2.0 | 102 | 06/00 → 07/06 | 1.975 | B | M | 4 | 16 | G4GC-G | | 81785 |
| | 104 | 06/00 → 07/06 | 1.975 | B | AM | 4 | 16 | G4GC | | 81785 |
| | 105 | 10/03 → 07/06 | 1.975 | B | M | 4 | 16 | G4GC | | 81785 |
| 2.0 CRDi | 83 | 04/01 → 07/06 | 1.991 | D | M | 4 | 16 | D4EA | | 82085 |

KW

cm³

NO. OF VALVES

HYUNDAI
Elantra II

| | | | | | | | | | | | |
|----------|-----|---------------|-------|---|---|---|----|------|-----------|-------|------------|
| 1.6 CVVT | 90 | 06/06 → 06/11 | 1.591 | B | M | 4 | 16 | G4FC | | 84015 | NEW |
| 2.0 CVVT | 105 | 06/06 → 06/11 | 1.975 | B | M | 4 | 16 | G4GC | → 10-2006 | 84015 | NEW |
| | 105 | 06/06 → 06/11 | 1.975 | B | M | 4 | 16 | G4GC | 11-2006 → | 81785 | |

Elantra III

| | | | | | | | | | | | |
|-----|-----|---------|-------|---|---|---|----|--------|--|-------|------------|
| 1.6 | 97 | 06/11 → | 1.591 | B | M | 4 | 16 | G4FG | | 84015 | NEW |
| 1.8 | 110 | 09/10 → | 1.797 | B | M | 4 | 16 | G4NB-B | | 84064 | NEW |

Galopper I

| | | | | | | | | | | | |
|--------------------|----|---------------|-------|---|---|---|---|-------|--|-------|--|
| 2.5 Tci D | 77 | 08/98 → 12/03 | 2.476 | D | M | 4 | 8 | D4BH | | 81787 | |
| 2.5 TD | 65 | 08/98 → 12/03 | 2.476 | D | M | 4 | 8 | D4BA | | 81787 | |
| | 62 | 08/91 → 07/98 | 2.477 | D | M | 4 | 8 | 4D56T | | 81787 | |
| 2.5 TD intercooler | 70 | 08/91 → 07/98 | 2.477 | D | M | 4 | 8 | 4D56T | | 81787 | |

Getz

| | | | | | | | | | | | |
|--------------|----|---------------|-------|---|---|---|----|------------|--|-------|------------|
| 1.1 | 46 | 09/02 → 09/05 | 1.086 | B | M | 4 | 12 | G4HD | | 84018 | NEW |
| | 49 | 09/05 → 06/09 | 1.086 | B | M | 4 | 12 | G4HD, G4HG | | 82020 | |
| 1.3 | 63 | 09/03 → 09/05 | 1.341 | B | M | 4 | 12 | G4EA | | 81784 | |
| 1.3 i | 60 | 09/02 → 03/04 | 1.341 | B | M | 4 | 12 | G4EA | | 81784 | |
| 1.4 i | 71 | 08/05 → | 1.399 | B | M | 4 | 16 | G4EE | | 82020 | |
| 1.5 CRDi | 60 | 03/03 → 09/05 | 1.493 | D | M | 3 | 12 | D3EA | | 82085 | |
| | 65 | 08/05 → 06/09 | 1.493 | D | M | 4 | 16 | D4FA | | 84058 | NEW |
| 1.5 CRDi GLS | 75 | 07/04 → 08/05 | 1.493 | D | M | 4 | 16 | D4FA | | 84058 | NEW |
| | 81 | 08/05 → 06/09 | 1.493 | D | M | 4 | 16 | D4FA | | 84058 | NEW |
| 1.6 | 77 | 09/02 → 09/05 | 1.599 | B | M | 4 | 16 | G4ED-G | | 82020 | |
| | 78 | 08/05 → | 1.599 | B | M | 4 | 16 | G4ED-G | | 82020 | |

Grace

| | | | | | | | | | | | |
|--------|----|---------------|-------|---|---|---|---|------|--|-------|--|
| 2.5 TD | 59 | 06/98 → 10/01 | 2.476 | D | M | 4 | 8 | D4BF | | 81787 | |
|--------|----|---------------|-------|---|---|---|---|------|--|-------|--|

Grandeur III

| | | | | | | | | | | | |
|----------|-----|---------|-------|---|---|---|----|------|--|-------|------------|
| 2.2 CRDi | 110 | 06/06 → | 2.188 | D | M | 4 | 16 | D4EB | | 84059 | NEW |
| | 114 | 06/06 → | 2.188 | D | M | 4 | 16 | D4EB | | 84059 | NEW |

H 100

| | | | | | | | | | | | |
|----------|----|---------------|-------|---|---|---|---|------------|--|-------|--|
| 2.5 D | 55 | 07/93 → 12/94 | 2.477 | D | M | 4 | 8 | D4BA, D4BX | | 81787 | |
| | 57 | 12/94 → 03/00 | 2.477 | D | M | 4 | 8 | D4BA | | 81787 | |
| 2.5 TD | 59 | 07/93 → 03/00 | 2.476 | D | M | 4 | 8 | D4BF | | 81787 | |
| 2.5 TDiC | 59 | 06/98 → 10/03 | 2.476 | D | M | 4 | 8 | D4BF | | 81787 | |

Highway Van

| | | | | | | | | | | | |
|------------|-----|---------|-------|---|---|---|----|------|--|-------|--|
| 2.7 V6 24V | 125 | 03/00 → | 2.656 | B | A | 6 | 24 | G6BA | | 82021 | |
|------------|-----|---------|-------|---|---|---|----|------|--|-------|--|

i10 I

| | | | | | | | | | | | |
|-----|----|---------|-------|---|---|---|----|------|--|-------|------------|
| 1.1 | 48 | 12/07 → | 1.086 | B | M | 4 | 12 | G4HG | | 84018 | NEW |
| | 49 | 01/08 → | 1.086 | B | M | 4 | 12 | G4HG | | 84018 | NEW |
| | 51 | 04/11 → | 1.086 | B | M | 4 | 12 | G4HG | | 84018 | NEW |
| 1.2 | 57 | 11/08 → | 1.248 | B | M | 4 | 16 | G4LA | | 84015 | NEW |
| | 63 | 04/11 → | 1.248 | B | M | 4 | 16 | G4LA | | 84040 | NEW |

i10 II

| | | | | | | | | | | | |
|-----|----|---------|-------|---|---|---|----|------|--|-------|------------|
| 1.2 | 64 | 12/13 → | 1.248 | B | M | 4 | 16 | G4LA | | 84040 | NEW |
|-----|----|---------|-------|---|---|---|----|------|--|-------|------------|



KW



cm³



NO. OF VALVES



MAGNETI MARELLI

HYUNDAI

i20 I

| | | | | | | | | | | | |
|----------|----|---------|-------|---|---|---|----|------|--|-------|------------|
| 1.1 CRDi | 55 | 03/12 → | 1.120 | D | M | 3 | 12 | D3FA | | 84063 | NEW |
| 1.2 | 57 | 09/08 → | 1.248 | B | M | 4 | 16 | G4LA | | 84040 | NEW |
| | 63 | 03/12 → | 1.248 | B | M | 4 | 16 | G4LA | | 84040 | NEW |
| 1.4 | 74 | 09/08 → | 1.396 | B | M | 4 | 16 | G4FA | | 84015 | NEW |
| 1.6 | 93 | 09/08 → | 1.591 | B | M | 4 | 16 | G4FC | | 84015 | NEW |
| 1.6 CRDi | 94 | 01/09 → | 1.582 | D | M | 4 | 16 | D4FB | | 84063 | NEW |

i20 II, Coupé

| | | | | | | | | | | | |
|-----|----|---------|-------|---|---|---|----|------|--|-------|------------|
| 1.2 | 55 | 11/14 → | 1.248 | B | M | 4 | 16 | G4LA | | 84040 | NEW |
| | 62 | 11/14 → | 1.248 | B | M | 4 | 16 | G4LA | | 84040 | NEW |

i30 I, Station Wagon

| | | | | | | | | | | | |
|----------|-----|---------------|-------|---|---|---|----|--------------|--|-------|------------|
| 1.4 | 77 | 10/07 → 11/11 | 1.396 | B | M | 4 | 16 | G4FA | | 84015 | NEW |
| | 80 | 10/07 → 11/11 | 1.396 | B | M | 4 | 16 | G4FA | | 84015 | NEW |
| 1.6 | 85 | 10/07 → 11/11 | 1.591 | B | M | 4 | 16 | G4FC | | 84015 | NEW |
| | 90 | 10/07 → 11/11 | 1.591 | B | M | 4 | 16 | G4FC | | 84015 | NEW |
| | 93 | 02/08 → 11/11 | 1.591 | B | M | 4 | 16 | G4FC | | 84015 | NEW |
| 1.6 CRDi | 66 | 10/07 → 11/11 | 1.582 | D | M | 4 | 16 | D4FB | | 84058 | NEW |
| | 85 | 10/07 → 11/11 | 1.582 | D | M | 4 | 16 | D4FB | | 84058 | NEW |
| | 94 | 01/10 → 11/11 | 1.582 | D | M | 4 | 16 | D4FB | | 84058 | NEW |
| 2.0 | 105 | 10/07 → 11/11 | 1.975 | B | M | 4 | 16 | G4GC, G4GC-G | | 81785 | |
| 2.0 CRDi | 100 | 10/07 → 11/11 | 1.991 | D | M | 4 | 16 | D4EA | | 84059 | NEW |
| | 103 | 10/07 → 11/11 | 1.991 | D | M | 4 | 16 | D4EA | | 84059 | NEW |

i30 II, Station Wagon, Coupé

| | | | | | | | | | | | |
|-----------|-----|---------|-------|---|---|---|----|---------|-----------|-------|------------|
| 1.4 | 74 | 01/15 → | 1.368 | B | M | 4 | 16 | G4LC | → 12-2014 | 84015 | NEW |
| | 73 | 12/11 → | 1.396 | B | M | 4 | 16 | G4FA | → 12-2014 | 84015 | NEW |
| | 73 | 06/12 → | 1.396 | B | M | 4 | 16 | G4FA | | 84015 | NEW |
| 1.4 CRDi | 66 | 12/11 → | 1.396 | D | M | 4 | 16 | D4FC | | 84063 | NEW |
| 1.6 | 88 | 01/12 → | 1.591 | B | M | 4 | 16 | G4FC | | 84015 | NEW |
| | 88 | 06/12 → | 1.591 | B | M | 4 | 16 | G4FG | | 84015 | NEW |
| | 95 | 06/12 → | 1.591 | B | M | 4 | 16 | G4FG | | 84015 | NEW |
| 1.6 CRDi | 81 | 12/11 → | 1.582 | D | M | 4 | 16 | D4FB | | 84063 | NEW |
| | 94 | 12/11 → | 1.582 | D | M | 4 | 16 | D4FB | | 84063 | NEW |
| | 94 | 06/12 → | 1.582 | D | M | 4 | 16 | D4FB-5P | | 84063 | NEW |
| 1.6 GDI | 95 | 12/11 → | 1.591 | B | M | 4 | 16 | G4FG | | 84015 | NEW |
| | 99 | 12/11 → | 1.591 | B | M | 4 | 16 | G4FD | | 84015 | NEW |
| 1.6 T-GDI | 137 | 01/15 → | 1.591 | B | M | 4 | 16 | G4FJ | | 84015 | NEW |

i40

| | | | | | | | | | | | |
|---------|-----|---------|-------|---|---|---|----|------|--|-------|------------|
| 1.6 GDI | 99 | 03/12 → | 1.591 | B | M | 4 | 16 | G4FD | | 84015 | NEW |
| 2.0 GDI | 130 | 07/11 → | 1.999 | B | M | 4 | 16 | G4NC | | 84064 | NEW |
| | 131 | 03/12 → | 1.999 | B | M | 4 | 16 | G4NC | | 84064 | NEW |

ix 20

| | | | | | | | | | | | |
|-----|----|---------|-------|---|---|---|----|------|--|-------|------------|
| 1.4 | 66 | 11/10 → | 1.396 | B | M | 4 | 16 | G4FA | | 84015 | NEW |
| 1.6 | 92 | 11/10 → | 1.591 | B | M | 4 | 16 | G4FC | | 84015 | NEW |

ix 35

| | | | | | | | | | | | |
|-----|----|---------|-------|---|---|---|----|------|--|-------|------------|
| 1.6 | 99 | 11/10 → | 1.591 | B | M | 4 | 16 | G4FD | | 84015 | NEW |
|-----|----|---------|-------|---|---|---|----|------|--|-------|------------|

| | | | | | | | | | |
|--|--|--|--|--|--|--|---------------|--|--|
| | | | | | | | NO. OF VALVES | | |
|--|--|--|--|--|--|--|---------------|--|--|

HYUNDAI

Lantra I

| | | | | | | | | | |
|--------------|----|---------------|-------|---|---|---|----|------------|-------|
| 1.5 i.e. | 63 | 10/90 → 11/95 | 1.468 | B | M | 4 | 8 | G15B, G4DJ | 81784 |
| 1.6 i.e. 16V | 78 | 10/90 → 11/95 | 1.596 | B | M | 4 | 16 | G4CR | 81785 |
| | 84 | 10/90 → 11/95 | 1.596 | B | M | 4 | 16 | G4CR | 81785 |
| 1.8 i.e. 16V | 93 | 10/90 → 11/95 | 1.836 | B | M | 4 | 16 | G4CN | 81786 |

Lantra II, Station Wagon

| | | | | | | | | | |
|---------|-----|---------------|-------|---|---|---|----|------|-------|
| 1.5 12V | 65 | 12/96 → 09/00 | 1.495 | B | M | 4 | 12 | G4EK | 81784 |
| 1.6 16V | 84 | 11/95 → 09/00 | 1.599 | B | M | 4 | 16 | 4G61 | 81785 |
| 1.6 i | 66 | 11/95 → 09/00 | 1.599 | B | M | 4 | 16 | G4GR | 81785 |
| 1.8 16V | 94 | 11/95 → 09/00 | 1.795 | B | M | 4 | 16 | G4GM | 81785 |
| 1.9 D | 50 | 03/98 → 09/00 | 1.905 | D | M | 4 | 8 | DJY | 81642 |
| 2.0 16V | 102 | 08/96 → 09/00 | 1.975 | B | M | 4 | 16 | G4GF | 81785 |

Matrix

| | | | | | | | | | | |
|--------------|----|---------------|-------|---|----|---|----|--------|-------|--|
| 1.5 CRDi | 75 | 12/04 → 08/10 | 1.493 | D | M | 4 | 16 | D4FA | 84058 | |
| | 60 | 10/01 → 08/10 | 1.496 | D | M | 3 | 12 | D3EA | 82085 | |
| 1.5 CRDi VGT | 81 | 08/05 → 08/10 | 1.493 | D | M | 4 | 16 | D4FA | 84058 | |
| 1.6 | 66 | 01/02 → 12/05 | 1.599 | B | M | 4 | 16 | G4ED-L | 82020 | |
| | 76 | 06/01 → 08/10 | 1.599 | B | AM | 4 | 16 | G4ED-G | 82020 | |
| 1.8 | 90 | 06/01 → 08/10 | 1.795 | B | M | 4 | 16 | G4GB-G | 81785 | |

Pony III / Excel

| | | | | | | | | | |
|-------|----|---------------|-------|---|---|---|---|------------|-------|
| 1.3 | 43 | 10/89 → 01/95 | 1.299 | B | M | 4 | 8 | G4DG | 81784 |
| | 49 | 10/89 → 01/95 | 1.299 | B | M | 4 | 8 | G4DG | 81784 |
| 1.5 | 53 | 10/89 → 01/95 | 1.468 | B | M | 4 | 8 | G15B, G4DJ | 81784 |
| 1.5 i | 61 | 10/89 → 01/95 | 1.468 | B | M | 4 | 8 | G15B, G4DJ | 81784 |
| | 62 | 10/89 → 01/95 | 1.468 | B | M | 4 | 8 | G15B, G4DJ | 81784 |

S Coupé

| | | | | | | | | | |
|-------------|----|---------------|-------|---|---|---|----|------------|-------|
| 1.5 GS | 57 | 03/90 → 12/92 | 1.468 | B | M | 4 | 8 | G4DJ | 81784 |
| 1.5 i | 62 | 02/90 → 05/96 | 1.468 | B | M | 4 | 8 | G15B, G4DJ | 81784 |
| | 65 | 04/92 → 05/96 | 1.495 | B | M | 4 | 12 | G4EK | 81784 |
| 1.5 i Turbo | 85 | 04/91 → 05/96 | 1.495 | B | M | 4 | 12 | G4EK-TC | 81784 |

Santa Fé I

| | | | | | | | | | | |
|-----------------------------|-----|---------------|-------|---|----|---|----|--------|-------|--|
| 2.0 CRDi | 83 | 08/01 → 03/06 | 1.991 | D | M | 4 | 16 | D4EA | 82085 | |
| 2.0 CRDi 4x4 | 83 | 04/01 → 03/06 | 1.991 | D | AM | 4 | 16 | D4EA | 82085 | |
| | 92 | 08/03 → 03/06 | 1.991 | D | M | 4 | 16 | D4EA | 82085 | |
| 2.0 CRDi Trazione integrale | 107 | 11/03 → 02/06 | 1.991 | D | M | 4 | 16 | D4EA | 82085 | |
| 2.2 CRDi | 110 | 10/05 → 03/06 | 2.188 | D | M | 4 | 16 | D4EB | 84059 | |
| 2.7 V6 4x4 | 127 | 02/01 → 03/06 | 2.656 | B | A | 6 | 24 | G6BA-G | 82021 | |

Santa Fé II

| | | | | | | | | | | |
|----------|-----|---------|-------|---|---|---|----|------|-------|--|
| 2.2 CRDi | 102 | 03/06 → | 2.188 | D | M | 4 | 16 | D4EB | 84059 | |
| | 114 | 03/06 → | 2.188 | D | M | 4 | 16 | D4EB | 84059 | |
| | 145 | 01/09 → | 2.199 | D | M | 4 | 16 | D4HB | 84059 | |

KW

cm³

NO. OF VALVES

MAGNETI MARELLI
HYUNDAI
Santa Fé II

| | | | | | | | | | | | |
|------------------|-----|---------------|-------|---|---|---|----|------|--|-------|------------|
| 2.2 CRDi 4x4 | 102 | 03/06 → | 2.188 | D | M | 4 | 16 | D4EB | | 84059 | NEW |
| | 110 | 10/05 → 03/06 | 2.188 | D | M | 4 | 16 | D4EB | | 84059 | NEW |
| | 114 | 03/06 → | 2.188 | D | M | 4 | 16 | D4EB | | 84059 | NEW |
| | 145 | 01/09 → | 2.199 | D | M | 4 | 16 | D4HB | | 84059 | NEW |
| 2.2 CRDi GLS | 110 | 03/06 → | 2.188 | D | M | 4 | 16 | D4EB | | 84059 | NEW |
| 2.2 CRDi GLS 4x4 | 110 | 03/06 → | 2.188 | D | M | 4 | 16 | D4EB | | 84059 | NEW |

Sonata II

| | | | | | | | | | | | |
|-----------|----|---------------|-------|---|---|---|----|--------|--|-------|--|
| 2.0 i 16V | 96 | 01/91 → 10/93 | 1.997 | B | M | 4 | 16 | G4CP-D | | 81786 | |
|-----------|----|---------------|-------|---|---|---|----|--------|--|-------|--|

Sonata III

| | | | | | | | | | | | |
|-----------|-----|---------------|-------|---|---|---|----|---------|--|-------|--|
| 2.0 i 16V | 92 | 06/96 → 06/98 | 1.997 | B | M | 4 | 16 | G4CP-DM | | 81786 | |
| | 102 | 05/93 → 06/98 | 1.997 | B | M | 4 | 16 | G4CP-D | | 81786 | |

Sonata IV

| | | | | | | | | | | | |
|------------|-----|---------------|-------|---|----|---|----|--------|--|-------|--|
| 2.5 V6 24V | 118 | 06/98 → 10/01 | 2.493 | B | A | 6 | 24 | G6BV-G | | 82021 | |
| 2.7 V6 | 127 | 10/01 → 11/04 | 2.656 | B | AM | 6 | 24 | G6BA-G | | 82021 | |
| | 129 | 11/02 → 11/04 | 2.656 | B | M | 6 | 24 | G6BA | | 82021 | |

Sonata V

| | | | | | | | | | | | |
|----------|-----|---------------|-------|---|---|---|----|------|--|-------|------------|
| 2.0 CRDi | 100 | 02/06 → 12/10 | 1.991 | D | M | 4 | 16 | D4EA | | 84059 | NEW |
| | 103 | 02/06 → 12/10 | 1.991 | D | M | 4 | 16 | D4EA | | 84059 | NEW |
| | 110 | 03/09 → 12/10 | 1.991 | D | M | 4 | 16 | D4EA | | 84059 | NEW |

Starex

| | | | | | | | | | | | |
|------------|----|---------------|-------|---|---|---|---|------|--|-------|--|
| 2.5 D | 57 | 10/97 → 04/04 | 2.476 | D | M | 4 | 8 | D4BF | | 81787 | |
| 2.5 TD | 59 | 06/97 → 04/04 | 2.476 | D | M | 4 | 8 | D4BF | | 81787 | |
| 2.5 TD 4WD | 59 | 02/98 → 04/04 | 2.476 | D | M | 4 | 8 | D4BF | | 81787 | |

Tiburon

| | | | | | | | | | | | |
|----------|-----|---------------|-------|---|---|---|----|--------|--|-------|--|
| 1.6 CVVT | 78 | 10/06 → 12/08 | 1.599 | B | M | 4 | 16 | G4ED-G | | 82020 | |
| 2.0 CVVT | 105 | 10/06 → 12/08 | 1.975 | B | M | 4 | 16 | G4GC | | 81785 | |

Trajjet

| | | | | | | | | | | | |
|----------|-----|---------------|-------|---|----|---|----|--------|-----------|-------|--|
| 2.0 | 103 | 01/04 → 07/08 | 1.975 | B | M | 4 | 16 | G4GC-G | | 81785 | |
| | 104 | 11/03 → 07/08 | 1.975 | B | M | 4 | 16 | G4GC | 02-2004 → | 81785 | |
| 2.0 CRDi | 83 | 04/01 → 07/08 | 1.991 | D | AM | 4 | 16 | D4EA | | 82085 | |
| | 92 | 08/05 → 07/08 | 1.991 | D | M | 4 | 16 | D4EA | | 82085 | |
| 2.7 V6 | 127 | 09/00 → 07/08 | 2.656 | B | A | 6 | 24 | G6BA-G | | 82021 | |

Tucson I

| | | | | | | | | | | | |
|----------|-----|---------------|-------|---|---|---|----|--------|-----------|-------|------------|
| 2.0 | 104 | 08/04 → 03/10 | 1.975 | B | M | 4 | 16 | G4GC | | 81785 | |
| 2.0 CRDi | 83 | 08/04 → 03/10 | 1.991 | D | M | 4 | 16 | D4EA | → 12-2005 | 82085 | |
| | 83 | 08/04 → 03/10 | 1.991 | D | M | 4 | 16 | D4EA | 01-2006 → | 84059 | NEW |
| | 88 | 01/07 → 03/10 | 1.991 | D | M | 4 | 16 | D4EA | | 84059 | NEW |
| | 100 | 01/06 → 03/10 | 1.991 | D | M | 4 | 16 | D4EA | | 84059 | NEW |
| | 103 | 01/06 → 03/10 | 1.991 | D | M | 4 | 16 | D4EA-V | | 84059 | NEW |
| | 110 | 01/09 → 03/10 | 1.991 | D | M | 4 | 16 | D4EA | | 84059 | NEW |

KW

cm³

NO. OF VALVES

HYUNDAI

Tucson I

| | | | | | | | | | | | |
|-----------------------------|-----|---------------|-------|---|---|---|----|----------------|-----------|-------|------------|
| 2.0 CRDi Trazione integrale | 83 | 08/04 → 03/10 | 1.991 | D | M | 4 | 16 | D4EA | → 12-2005 | 82085 | |
| | 83 | 08/04 → 03/10 | 1.991 | D | M | 4 | 16 | D4EA | 01-2006 → | 84059 | NEW |
| | 88 | 01/07 → 03/10 | 1.991 | D | M | 4 | 16 | D4EA | | 84059 | NEW |
| | 100 | 01/06 → 03/10 | 1.991 | D | M | 4 | 16 | D4EA | | 84059 | NEW |
| | 103 | 01/06 → 03/10 | 1.991 | D | M | 4 | 16 | D4EA-F, D4EA-V | | 84059 | NEW |
| | 110 | 01/09 → 03/10 | 1.991 | D | M | 4 | 16 | D4EA | | 84059 | NEW |
| 2.0 Trazione integrale | 104 | 08/04 → 03/10 | 1.975 | B | M | 4 | 16 | G4GC | | 81785 | |
| 2.7 Trazione integrale | 129 | 08/04 → 03/10 | 2.656 | B | M | 6 | 24 | G6BA-G | | 82021 | |

Tucson III

| | | | | | | | | | | | |
|------------------------------|-----|---------|-------|---|---|---|----|------|--|-------|------------|
| 1.6 GDi | 97 | 06/15 → | 1.591 | B | M | 4 | 16 | G4FD | | 84015 | NEW |
| 1.6 T-GDI | 130 | 06/15 → | 1.591 | B | M | 4 | 16 | G4FJ | | 84015 | NEW |
| 1.6 T-GDI Trazione integrale | 130 | 06/15 → | 1.591 | B | M | 4 | 16 | G4FJ | | 84015 | NEW |

Velostar

| | | | | | | | | | | | |
|-----------|-----|---------|-------|---|---|---|----|------|--|-------|------------|
| 1.6 GDI | 103 | 03/11 → | 1.591 | B | M | 4 | 16 | G4FD | | 84015 | NEW |
| 1.6 T-GDI | 137 | 10/12 → | 1.591 | B | M | 4 | 16 | G4FJ | | 84015 | NEW |

XG

| | | | | | | | | | | | |
|-----|-----|---------------|-------|---|---|---|----|------|--|-------|--|
| 250 | 120 | 12/98 → 12/05 | 2.493 | B | M | 6 | 24 | G6AV | | 82021 | |
|-----|-----|---------------|-------|---|---|---|----|------|--|-------|--|

INFINITI

Q30

| | | | | | | | | | | | |
|-------|----|---------|-------|---|---|---|---|--|--|-------|--|
| 1.5 D | 80 | 11/15 → | 1.461 | D | M | 4 | 8 | | | 82098 | |
|-------|----|---------|-------|---|---|---|---|--|--|-------|--|

INNOCENTI

Elba

| | | | | | | | | | | | |
|----------|----|---------------|-------|---|---|---|---|----------------------|----------------------|-------|--|
| 1.3 | 49 | 08/91 → 12/96 | 1.301 | B | M | 4 | 8 | 146A5.000 | | 81434 | |
| 1.4 i.e. | 49 | 09/94 → 12/96 | 1.372 | B | M | 4 | 8 | 146C5.000, 146D5.000 | (-)COP, → 02-1995 | 81314 | |
| | 49 | 09/94 → 12/96 | 1.372 | B | M | 4 | 8 | 146C5.000, 146D5.000 | (-)COP, 03-1995 → | 81366 | |
| | 49 | 09/94 → 12/96 | 1.372 | B | M | 4 | 8 | 146C5.000, 146D5.000 | (+)COP, → 02-1995 | 81476 | |
| | 49 | 09/94 → 12/96 | 1.372 | B | M | 4 | 8 | 146C5.000, 146D5.000 | (+)COP, 03-1995 → | 81343 | |
| 1.6 i.e. | 55 | 09/94 → 12/96 | 1.580 | B | M | 4 | 8 | 146C6.000, 146D6.000 | (-)COP | 81314 | |
| | 55 | 09/94 → 12/96 | 1.580 | B | M | 4 | 8 | 146C6.000, 146D6.000 | (+)COP | 81476 | |
| 1.7 D | 42 | 08/91 → 12/96 | 1.697 | D | M | 4 | 8 | 146B2.000 | (+)COP, (-)SS, (-)AC | 81456 | |
| | 42 | 08/91 → 12/96 | 1.697 | D | M | 4 | 8 | 146B2.000 | (+)SS, (+)AC | 81344 | |

Koral

| | | | | | | | | | | | |
|----|----|---------------|-------|---|---|---|---|-----------|--------|-------|--|
| 55 | 40 | 01/90 → 12/92 | 1.116 | B | M | 4 | 8 | 146A6.000 | (-)COP | 81481 | |
|----|----|---------------|-------|---|---|---|---|-----------|--------|-------|--|

Mini

| | | | | | | | | | | | |
|-----|----|---------------|-----|---|---|---|---|-----|----|-------|--|
| 1.0 | 27 | 10/85 → 10/91 | 999 | B | M | 4 | 8 | 99H | BC | 81419 | |
|-----|----|---------------|-----|---|---|---|---|-----|----|-------|--|

KW

cm³

NO. OF VALVES

IVECO
Daily II

| | | | | | | | | | | |
|---------|----|---------------|-------|---|---|---|---|---|-------------------------|-------|
| 30-10 | 76 | 01/97 → 05/99 | 2.798 | D | M | 4 | 8 | 8140.23. | | 81332 |
| 30-10 C | 76 | 01/97 → 05/99 | 2.798 | D | M | 4 | 8 | 8140.23. | | 81332 |
| 30-8 | 55 | 01/92 → 08/98 | 2.499 | D | M | 4 | 8 | 8140.07.2700 | → 12-1995 | 81334 |
| | 55 | 01/92 → 08/98 | 2.499 | D | M | 4 | 8 | 8140.07.2700 | 01-1996 → | 81332 |
| | 55 | 01/89 → 08/98 | 2.499 | D | M | 4 | 8 | 8140.07.2700, 8140.07.2712 | | 81332 |
| | 60 | 01/92 → 08/98 | 2.499 | D | M | 4 | 8 | 8140.67F. | → 12-1995 | 81334 |
| | 60 | 01/89 → 08/98 | 2.499 | D | M | 4 | 8 | 8140.67F., 8140.67F.3710, 8140.67F.3711, 8140.67F.3713, 8140.67F.3721 | | 81332 |
| | 60 | 01/92 → 08/98 | 2.499 | D | M | 4 | 8 | 8140.67F., 8140.67F.3710, 8140.67F.3711, 8140.67F.3713, 8140.67F.3721 | 01-1996 → | 81332 |
| | 62 | 09/98 → 05/99 | 2.798 | D | M | 4 | 8 | 8140.63. | | 81332 |
| 30-8 V | 62 | 09/98 → 05/99 | 2.798 | D | M | 4 | 8 | 8140.63. | | 81332 |
| 35-10 | 68 | 01/89 → 12/96 | 2.499 | D | M | 4 | 8 | 8140.97.2781 | → 12-1990 | 81491 |
| | 68 | 01/89 → 12/96 | 2.499 | D | M | 4 | 8 | 8140.97.2781 | 01-1991 →, → 12-1995 | 81334 |
| | 76 | 01/89 → 12/96 | 2.499 | D | M | 4 | 8 | 8140.47R.2790 | → 12-1990 | 81491 |
| | 76 | 01/89 → 12/96 | 2.499 | D | M | 4 | 8 | 8140.47R.2790 | 01-1991 →, → 12-1995 | 81334 |
| | 76 | 01/96 → 05/99 | 2.798 | D | M | 4 | 8 | 8140.23. | | 81332 |
| 35-10 K | 76 | 01/97 → 05/99 | 2.798 | D | M | 4 | 8 | 8140.23. | | 81332 |
| 35-12 | 90 | 05/96 → 05/99 | 2.798 | D | M | 4 | 8 | 8140.43. | | 81332 |
| 35-12 K | 90 | 09/96 → 08/98 | 2.798 | D | M | 4 | 8 | 8140.43. | | 81332 |
| 35-8 | 62 | 09/98 → 05/99 | 2.798 | D | M | 4 | 8 | 8140.63. | | 81332 |
| 35-8 K | 62 | 09/98 → 05/99 | 2.798 | D | M | 4 | 8 | 8140.63. | | 81332 |
| 40-10 V | 76 | 01/90 → 04/96 | 2.499 | D | M | 4 | 8 | 8140.27.2720 | | 81334 |
| 45-10 | 76 | 01/89 → 04/96 | 2.499 | D | M | 4 | 8 | 8140.27.2720 | | 81334 |
| 45-10 V | 76 | 01/89 → 04/96 | 2.499 | D | M | 4 | 8 | 8140.27.2720 | | 81334 |
| 49-10 | 76 | 01/89 → 04/96 | 2.499 | D | M | 4 | 8 | 8140.27.2700, 8140.47R.2790 | | 81334 |
| | 76 | 05/96 → 05/99 | 2.798 | D | M | 4 | 8 | 8140.23. | | 81332 |
| 49-10 K | 76 | 01/89 → 04/96 | 2.499 | D | M | 4 | 8 | 8140.27.2700, 8140.47R.2790 | | 81334 |
| | 76 | 05/96 → 05/99 | 2.798 | D | M | 4 | 8 | 8140.23. | | 81332 |
| 49-10 V | 76 | 01/89 → 04/96 | 2.499 | D | M | 4 | 8 | 8140.27.2700, 8140.47R.2790 | | 81334 |
| 49-12 | 90 | 05/96 → 05/99 | 2.798 | D | M | 4 | 8 | 8140.43. | | 81332 |
| 49-12 K | 90 | 05/96 → 05/99 | 2.798 | D | M | 4 | 8 | 8140.43. | | 81332 |
| 49-12 V | 90 | 05/96 → 05/99 | 2.798 | D | M | 4 | 8 | 8140.43. | | 81332 |
| 59-12 K | 90 | 05/96 → 05/99 | 2.798 | D | M | 4 | 8 | 8140.43. | | 81332 |

KW

cm³

NO. OF VALVES

IVECO
Daily II

| | | | | | | | | | | |
|---------|----|---------------|-------|---|---|---|---|--------------|--|-------|
| 59-12 V | 90 | 05/96 → 05/99 | 2.798 | D | M | 4 | 8 | 8140.43. | | 81332 |
| A 40-10 | 76 | 01/91 → 12/96 | 2.499 | D | M | 4 | 8 | 8140.27.2720 | | 81334 |
| A 45-10 | 76 | 01/91 → 04/96 | 2.499 | D | M | 4 | 8 | 8140.27.2720 | | 81334 |

Daily III

| | | | | | | | | | | |
|------------------|-----|---------------|-------|---|---|---|----|-----------|--|-------|
| 29 L 12 | 85 | 09/02 → 04/06 | 2.287 | D | M | 4 | 16 | F1AE0481B | | 82024 |
| 29 L 12 V | 85 | 09/02 → 07/07 | 2.287 | D | M | 4 | 16 | F1AE0481B | | 82024 |
| 35 C 14 | 100 | 09/04 → 04/06 | 2.998 | D | M | 4 | 16 | F1CE0481A | | 82095 |
| 35 C 14, 35 S 14 | 100 | 01/05 → 04/06 | 2.287 | D | M | 4 | 16 | F1AE0481M | | 82095 |
| 35 C 17, 35 S 17 | 122 | 01/05 → 04/06 | 2.998 | D | M | 4 | 16 | F1CE0481B | | 82095 |
| 40 C 14 | 100 | 09/04 → 04/06 | 2.998 | D | M | 4 | 16 | F1CE0481A | | 82095 |
| 40 C 17, 40 S 17 | 122 | 01/05 → 04/06 | 2.998 | D | M | 4 | 16 | F1CE0481B | | 82095 |
| 50 C 14 | 100 | 09/04 → 04/06 | 2.998 | D | M | 4 | 16 | F1CE0481A | | 82095 |
| 50 C 17 | 122 | 09/04 → 04/06 | 2.998 | D | M | 4 | 16 | F1CE0481B | | 82095 |
| 65 C 14 | 100 | 09/04 → 04/06 | 2.998 | D | M | 4 | 16 | F1CE0481A | | 82095 |
| 65 C 17 | 122 | 09/04 → 04/06 | 2.998 | D | M | 4 | 16 | F1CE0481B | | 82095 |

Daily IV

| | | | | | | | | | | |
|---|-----|---------------|-------|---|---|---|----|------------|--|-------|
| 35C15 | 107 | 05/06 → 08/11 | 2.998 | D | M | 4 | 16 | F1CE0481FA | | 82095 |
| 35C15 V, 35C15 V/P | 107 | 05/06 → 08/11 | 2.998 | D | M | 4 | 16 | F1CE0481FA | | 82095 |
| 35C18 | 130 | 05/06 → 08/11 | 2.998 | D | M | 4 | 16 | F1CE0481HA | | 82095 |
| 35C18 V, 35C18 V/P, 35S18 V, 35S18 V/P | 130 | 05/06 → 08/11 | 2.998 | D | M | 4 | 16 | F1CE0481HA | | 82095 |
| 35C18, 35S18 | 130 | 05/06 → 08/11 | 2.998 | D | M | 4 | 16 | F1CE0481HA | | 82095 |
| 40C15 | 107 | 05/06 → 08/11 | 2.998 | D | M | 4 | 16 | F1CE0481FA | | 82095 |
| 40C15 V, 40C15 V/P | 107 | 05/06 → 08/11 | 2.998 | D | M | 4 | 16 | F1CE0481FA | | 82095 |
| 40C18 | 130 | 05/06 → 08/11 | 2.998 | D | M | 4 | 16 | F1CE0481HA | | 82095 |
| 40C18 V, 40C18 V/P | 130 | 05/06 → 08/11 | 2.998 | D | M | 4 | 16 | F1CE0481HA | | 82095 |
| 45C15 | 107 | 05/06 → 08/11 | 2.998 | D | M | 4 | 16 | F1CE0481FA | | 82095 |
| 45C15 V | 107 | 05/06 → 08/11 | 2.998 | D | M | 4 | 16 | F1CE0481FA | | 82095 |
| 45C18 | 130 | 05/06 → 08/11 | 2.998 | D | M | 4 | 16 | F1CE0481HA | | 82095 |
| 45C18, 45C18 /P, 45C18 D, 45C18 D/P | 130 | 05/06 → 08/11 | 2.998 | D | M | 4 | 16 | F1CE0481HA | | 82095 |
| 50C15 | 107 | 05/06 → 08/11 | 2.998 | D | M | 4 | 16 | F1CE0481FA | | 82095 |
| 50C15 V, 50C15 V/P | 107 | 05/06 → 08/11 | 2.998 | D | M | 4 | 16 | F1CE0481FA | | 82095 |
| 50C18 | 130 | 05/06 → 08/11 | 2.998 | D | M | 4 | 16 | F1CE0481HA | | 82095 |
| 50C18 V, 50C18 V/P | 130 | 05/06 → 08/11 | 2.998 | D | M | 4 | 16 | F1CE0481HA | | 82095 |
| 60C15 | 107 | 05/06 → 08/11 | 2.998 | D | M | 4 | 16 | F1CE0481FA | | 82095 |
| 60C15 V | 107 | 05/06 → 08/11 | 2.998 | D | M | 4 | 16 | F1CE0481FA | | 82095 |
| 60C15, 60C15 /P, 60C15 D, 60C15 D/P | 107 | 05/06 → 08/11 | 2.998 | D | M | 4 | 16 | F1CE0481FA | | 82095 |
| 60C18 | 130 | 05/06 → 08/11 | 2.998 | D | M | 4 | 16 | F1CE0481HC | | 82095 |
| 65C15 | 107 | 05/06 → 08/11 | 2.998 | D | M | 4 | 16 | F1CE0481FA | | 82095 |
| 65C15, 65C15 /P, 65C15 D, 65C15 D/P | 107 | 05/06 → 08/11 | 2.998 | D | M | 4 | 16 | F1CE0481FA | | 82095 |
| 65C18 | 130 | 05/06 → 08/11 | 2.998 | D | M | 4 | 16 | F1CE0481HC | | 82095 |

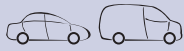
KW

cm³

NO. OF VALVES

MAGNETI MARELLI

JAGUAR

X Type, Estate

| | | | | | | | | | | |
|---------------------------|-----|---------------|-------|---|---|---|----|---------------------|--|-------|
| 2.0 D | 96 | 07/03 → 11/09 | 1.998 | D | M | 4 | 16 | FMBA, FMBB, R4-X404 | | 81805 |
| 2.0 V6 | 115 | 03/02 → 10/05 | 2.099 | B | M | 6 | 24 | | | 81845 |
| 2.2 D | 107 | 01/07 → 11/09 | 2.198 | D | M | 4 | 16 | LJ46G | | 81805 |
| | 114 | 10/05 → 11/09 | 2.198 | D | M | 4 | 16 | LJ46G | | 81805 |
| 2.5 | 144 | 02/04 → 12/09 | 2.495 | B | M | 6 | 24 | | | 81845 |
| 2.5 V6 Trazione integrale | 144 | 06/01 → 11/09 | 2.495 | B | M | 6 | 24 | | | 81845 |
| 3.0 | 169 | 02/04 → 12/09 | 2.967 | B | M | 6 | 24 | AJ-V6 | | 81845 |
| 3.0 V6 Trazione integrale | 169 | 06/01 → 11/07 | 2.967 | B | M | 6 | 24 | AJ-V6 | | 81845 |

XF I

| | | | | | | | | | | |
|-------|-----|---------------|-------|---|---|---|----|-------|--|-------|
| 2.2 D | 120 | 04/11 → 04/15 | 2.179 | D | M | 4 | 16 | 224DT | | 82068 |
| | 140 | 05/11 → 04/15 | 2.179 | D | M | 4 | 16 | 224DT | | 82068 |
| | 147 | 03/12 → 04/15 | 2.179 | D | M | 4 | 16 | 224DT | | 82068 |

XF II, Sportbrake

| | | | | | | | | | | |
|-------|-----|---------------|-------|---|---|---|----|-------|--|-------|
| 2.2 D | 120 | 09/12 → 04/14 | 2.179 | D | M | 4 | 16 | 224DT | | 82068 |
| | 147 | 09/12 → 04/14 | 2.179 | D | M | 4 | 16 | 224DT | | 82068 |

JEEP

Cherokee II (XJ)

| | | | | | | | | | | |
|--------|----|---------------|-------|---|---|---|---|-----|--------|-------|
| 2.5 | 89 | 10/95 → 09/01 | 2.469 | B | M | 4 | 8 | EPE | (-)COP | 81362 |
| 2.5 TD | 85 | 01/88 → 09/01 | 2.499 | D | M | 4 | 8 | ENC | (-)COP | 81362 |

Cherokee III (KJ)

| | | | | | | | | | | |
|-------------|-----|---------------|-------|---|---|---|----|----------|--|------------------|
| 2.5 CRD 4x4 | 105 | 09/01 → 01/08 | 2.499 | D | M | 4 | 16 | R425DOHC | | 84035 NEW |
| 2.8 CRD 4x4 | 110 | 11/02 → 01/08 | 2.776 | D | M | 4 | 16 | ENR | | 84035 NEW |
| | 120 | 11/04 → 01/08 | 2.776 | D | M | 4 | 16 | ENR | | 84035 NEW |

Cherokee IV (KK)

| | | | | | | | | | | |
|--------------|-----|---------|-------|---|---|---|----|-----|--|------------------|
| 2.8 CRD 4x4 | 130 | 05/08 → | 2.777 | D | M | 4 | 16 | ENS | | 84035 NEW |
| 2.8 CRDi 4x4 | 147 | 01/10 → | 2.777 | D | M | 4 | 16 | ENS | | 84043 NEW |

Commander

| | | | | | | | | | | |
|-------------|-----|---------------|-------|---|---|---|----|-----|--|-------|
| 3.0 CRD 4x4 | 160 | 04/06 → 12/10 | 2.987 | D | M | 6 | 24 | EXL | | 82058 |
|-------------|-----|---------------|-------|---|---|---|----|-----|--|-------|

Compass

| | | | | | | | | | | |
|-------------|-----|---------|-------|---|---|---|----|----------|--|------------------|
| 2.0 CRD | 103 | 08/06 → | 1.968 | D | M | 4 | 16 | ECD, ECE | | 81816 |
| | 103 | 08/06 → | 1.968 | D | M | 4 | 16 | ECD, ECE | | 84011 NEW |
| 2.0 CRD 4x4 | 103 | 09/06 → | 1.968 | D | M | 4 | 16 | ECE | | 81816 |
| | 103 | 09/06 → | 1.968 | D | M | 4 | 16 | ECE | | 84011 NEW |

Grand Cherokee I

| | | | | | | | | | | |
|---------------|----|---------------|-------|---|---|---|---|----------|--------|-------|
| 2.5 TD 4x4 | 85 | 10/95 → 04/99 | 2.499 | D | M | 4 | 8 | M51, M52 | (-)COP | 81362 |
| 2.5 TD Laredo | 85 | 10/96 → 09/98 | 2.498 | D | M | 4 | 8 | | (-)COP | 81362 |

Grand Cherokee II

| | | | | | | | | | | |
|------------|-----|---------------|-------|---|---|---|----|-----|--------|-------|
| 3.1 TD 4x4 | 103 | 04/99 → 12/01 | 3.125 | D | M | 5 | 10 | EXA | (-)COP | 81362 |
|------------|-----|---------------|-------|---|---|---|----|-----|--------|-------|

Grand Cherokee III

| | | | | | | | | | | |
|-------------|-----|---------------|-------|---|---|---|----|-----|--|-------|
| 3.0 CRD 4x4 | 155 | 05/06 → 12/10 | 2.987 | D | M | 6 | 24 | EXL | | 82058 |
| | 160 | 06/05 → 12/10 | 2.987 | D | M | 6 | 24 | EXL | | 82058 |

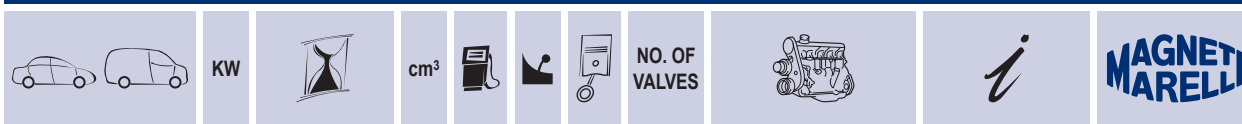

JEEP

Patriot

| | | | | | | | | | | |
|-------------|-----|---------|-------|---|---|---|----|----------|--|------------------|
| 2.0 CRD | 103 | 02/07 → | 1.968 | D | M | 4 | 16 | ECD, ECE | | 81816 |
| | 103 | 02/07 → | 1.968 | D | M | 4 | 16 | ECD, ECE | | 84011 NEW |
| 2.0 CRD 4x4 | 103 | 02/07 → | 1.968 | D | M | 4 | 16 | ECD, ECE | | 81816 |
| | 103 | 02/07 → | 1.968 | D | M | 4 | 16 | ECD, ECE | | 84011 NEW |

Renegade

| | | | | | | | | | | |
|-------------|-----|---------|-------|---|---|---|----|-----|-------|-------|
| 1.4 | 103 | 07/14 → | 1.368 | B | M | 4 | 16 | EAM | TESMA | 82070 |
| 1.4 4x4 | 125 | 07/14 → | 1.368 | B | M | 4 | 16 | EAM | TESMA | 82070 |
| 1.6 | 81 | 07/14 → | 1.598 | B | M | 4 | 16 | EJH | | 81861 |
| 1.6 CRD | 88 | 07/14 → | 1.598 | D | M | 4 | 16 | EJK | | 81872 |
| 2.0 CRD 4x4 | 88 | 07/14 → | 1.956 | D | M | 4 | 16 | EBT | | 81872 |
| | 103 | 07/14 → | 1.956 | D | M | 4 | 16 | EBT | | 81872 |
| | 125 | 07/14 → | 1.956 | D | M | 4 | 16 | EBT | | 81872 |

Wrangler II

| | | | | | | | | | | |
|----------|-----|---------------|-------|---|---|---|----|-----|--------|------------------|
| 2.4 | 105 | 11/02 → 04/07 | 2.429 | B | M | 4 | 16 | ED1 | (-)COP | 81365 |
| | 105 | 11/02 → 04/07 | 2.429 | B | M | 4 | 16 | ED1 | (+)COP | 81304 |
| 2.8 CRDi | 130 | 11/06 → 04/07 | 2.776 | D | M | 4 | 16 | ENS | | 84035 NEW |

Wrangler III

| | | | | | | | | | | |
|---------|-----|---------|-------|---|---|---|----|-----|--|------------------|
| 2.8 CRD | 147 | 11/10 → | 2.776 | D | M | 4 | 16 | ENS | | 84043 NEW |
| | 130 | 04/07 → | 2.777 | D | M | 4 | 16 | ENS | | 84043 NEW |

KIA

Carens II

| | | | | | | | | | | |
|----------|-----|---------|-------|---|---|---|----|------|--|------------------|
| 2.0 CRDi | 83 | 07/02 → | 1.991 | D | M | 4 | 16 | D4EA | | 82085 |
| | 103 | 11/05 → | 1.991 | D | M | 4 | 16 | D4EA | | 84059 NEW |
| 2.0 CVT | 102 | 08/04 → | 1.975 | B | M | 4 | 16 | G4GC | | 81785 |

Carens III

| | | | | | | | | | | |
|--------------|-----|---------|-------|---|---|---|----|------|--|------------------|
| 1.6 CVT | 93 | 10/10 → | 1.591 | B | M | 4 | 16 | G4FC | | 84015 NEW |
| | 97 | 08/09 → | 1.591 | B | M | 4 | 16 | G4FC | | 84015 NEW |
| 2.0 CRDi 115 | 85 | 05/07 → | 1.991 | D | M | 4 | 16 | D4EA | | 84059 NEW |
| 2.0 CRDi 135 | 100 | 08/09 → | 1.991 | D | M | 4 | 16 | D4EA | | 84059 NEW |
| 2.0 CRDi 140 | 103 | 09/06 → | 1.991 | D | M | 4 | 16 | D4EA | | 84059 NEW |

Carens IV

| | | | | | | | | | | |
|---------|-----|---------|-------|---|---|---|----|------|--|------------------|
| 1.6 GDi | 99 | 03/13 → | 1.591 | B | M | 4 | 16 | G4FD | | 84015 NEW |
| 2.0 GDi | 122 | 03/13 → | 1.999 | B | M | 4 | 16 | G4NC | | 84064 NEW |
| | 130 | 03/13 → | 1.999 | B | M | 4 | 16 | G4NC | | 84064 NEW |

Carnival I

| | | | | | | | | | | |
|--------|----|---------------|-------|---|---|---|----|----|--|-------|
| 2.9 TD | 93 | 08/99 → 10/01 | 2.903 | D | M | 4 | 16 | J3 | | 82038 |
|--------|----|---------------|-------|---|---|---|----|----|--|-------|

Carnival II

| | | | | | | | | | | |
|--------|----|---------|-------|---|---|---|----|----|--|-------|
| 2.9 TD | 93 | 01/99 → | 2.903 | D | M | 4 | 16 | J3 | | 82038 |
|--------|----|---------|-------|---|---|---|----|----|--|-------|

Cee'd I, Station Wagon

| | | | | | | | | | | |
|---------|----|---------------|-------|---|---|---|----|--------|--|------------------|
| 1.4 | 77 | 12/06 → 12/12 | 1.396 | B | M | 4 | 16 | G4FA | | 84015 NEW |
| | 80 | 12/06 → 12/12 | 1.396 | B | M | 4 | 16 | G4FA | | 84015 NEW |
| 1.4 CVT | 66 | 06/10 → 12/12 | 1.396 | B | M | 4 | 16 | G4FA-L | | 84015 NEW |

KW

cm³

NO. OF VALVES

KIA
Cee'd I, Station Wagon

| | | | | | | | | | | | |
|--------------|-----|---------------|-------|---|---|---|----|--------|--|-------|------------|
| 1.6 | 85 | 09/07 → 12/12 | 1.591 | B | M | 4 | 16 | G4FC | | 84015 | NEW |
| | 90 | 12/06 → 12/12 | 1.591 | B | M | 4 | 16 | G4FC | | 84015 | NEW |
| | 93 | 02/08 → 12/12 | 1.591 | B | M | 4 | 16 | G4FC | | 84015 | NEW |
| 1.6 CRDi 115 | 85 | 12/06 → 12/12 | 1.582 | D | M | 4 | 16 | D4FB | | 84058 | NEW |
| 1.6 CRDi 90 | 66 | 12/06 → 12/12 | 1.582 | D | M | 4 | 16 | D4FB-L | | 84058 | NEW |
| 1.6 CVVT | 92 | 10/10 → 12/12 | 1.591 | B | M | 4 | 16 | G4FC | | 84015 | NEW |
| 2.0 | 105 | 12/06 → 12/12 | 1.975 | B | M | 4 | 16 | G4GC | | 81785 | |
| 2.0 CRDi | 100 | 06/07 → 12/12 | 1.991 | D | M | 4 | 16 | D4EA | | 84059 | NEW |
| 2.0 CRDi 140 | 103 | 09/07 → 12/12 | 1.991 | D | M | 4 | 16 | D4EA-F | | 82085 | |

Cee'd II, Station Wagon

| | | | | | | | | | | | |
|--------------|-----|---------|-------|---|---|---|----|--------|--|-------|------------|
| 1.4 CRDi 90 | 66 | 05/12 → | 1.396 | D | M | 4 | 16 | D4FC | | 84063 | NEW |
| 1.4 CVVT | 66 | 05/12 → | 1.396 | B | M | 4 | 16 | G4FA-L | | 84015 | NEW |
| | 73 | 05/12 → | 1.396 | B | M | 4 | 16 | G4FA | | 84015 | NEW |
| 1.6 CRDi 110 | 81 | 05/12 → | 1.582 | D | M | 4 | 16 | D4FB | | 84063 | NEW |
| 1.6 CRDi 128 | 94 | 05/12 → | 1.582 | D | M | 4 | 16 | D4FB | | 84063 | NEW |
| 1.6 CVVT | 92 | 05/12 → | 1.591 | B | M | 4 | 16 | G4FC | | 84015 | NEW |
| 1.6 GDI | 99 | 05/12 → | 1.591 | B | M | 4 | 16 | G4FD | | 84015 | NEW |
| 1.6 GT | 150 | 06/13 → | 1.591 | B | M | 4 | 16 | G4FJ | | 84015 | NEW |

Cerato I

| | | | | | | | | | | | |
|----------|-----|---------|-------|---|---|---|----|------|-----------|-------|------------|
| 1.5 CRDi | 75 | 07/05 → | 1.493 | D | M | 4 | 16 | D4FA | | 84058 | NEW |
| 1.6 | 90 | 05/06 → | 1.591 | B | M | 4 | 16 | G4FC | | 84015 | NEW |
| | 90 | 05/06 → | 1.591 | B | M | 4 | 16 | G4FC | | 82020 | |
| | 77 | 07/04 → | 1.599 | B | M | 4 | 16 | G4ED | | 82020 | |
| 1.6 CRDi | 85 | 06/05 → | 1.582 | D | M | 4 | 16 | D4FB | | 84058 | NEW |
| 2.0 | 105 | 04/04 → | 1.975 | B | M | 4 | 16 | G4GC | | 81785 | |
| 2.0 CRDi | 83 | 04/04 → | 1.991 | D | M | 4 | 16 | D4EA | → 05-2005 | 82085 | |
| | 83 | 04/04 → | 1.991 | D | M | 4 | 16 | D4EA | 06-2005 → | 84059 | NEW |

Cerato II

| | | | | | | | | | | | |
|----------|----|---------|-------|---|---|---|----|------|--|-------|------------|
| 1.6 | 93 | 01/10 → | 1.591 | B | M | 4 | 16 | G4FC | | 84015 | NEW |
| 1.6 CVVT | 91 | 02/09 → | 1.591 | B | M | 4 | 16 | G4FC | | 84015 | NEW |
| 1.6 MPi | 96 | 06/13 → | 1.591 | B | M | 4 | 16 | G4FC | | 84015 | NEW |

Joice

| | | | | | | | | | | | |
|-----|-----|---------|-------|---|---|---|----|------|--|-------|--|
| 2.0 | 88 | 09/01 → | 1.997 | B | M | 4 | 16 | G4CP | | 81786 | |
| | 102 | 02/00 → | 1.997 | B | M | 4 | 16 | G4CP | | 81786 | |

Magentis I

| | | | | | | | | | | | |
|--------|-----|---------|-------|---|---|---|----|------|--|-------|--|
| 2.5 V6 | 124 | 05/01 → | 2.493 | B | A | 6 | 24 | G6BV | | 82021 | |
|--------|-----|---------|-------|---|---|---|----|------|--|-------|--|

Magentis II

| | | | | | | | | | | | |
|----------|-----|---------------|-------|---|---|---|----|------|--|-------|------------|
| 2.0 CRDi | 100 | 11/05 → 12/08 | 1.991 | D | M | 4 | 16 | D4EA | | 84059 | NEW |
| | 103 | 04/06 → | 1.991 | D | M | 4 | 16 | D4EA | | 84059 | NEW |
| | 110 | 04/06 → | 1.991 | D | M | 4 | 16 | D4EA | | 84059 | NEW |

KW

cm³

NO. OF VALVES

KIA
Picanto I

| | | | | | | | | | | | |
|----------|----|---------|-------|---|---|---|----|------|--|-------|------------|
| 1.0 | 45 | 04/04 → | 999 | B | M | 4 | 12 | G4HE | | 84018 | NEW |
| | 46 | 11/09 → | 999 | B | M | 4 | 12 | G4HE | | 84018 | NEW |
| 1.1 | 48 | 04/04 → | 1.086 | B | M | 4 | 12 | G4HG | | 84018 | NEW |
| 1.1 CRDi | 55 | 11/05 → | 1.120 | D | M | 3 | 12 | D3FA | | 84058 | NEW |

Picanto II

| | | | | | | | | | | | |
|-----|----|---------|-------|---|---|---|----|------|--|-------|------------|
| 1.2 | 63 | 09/11 → | 1.248 | B | M | 4 | 16 | G4LA | | 84040 | NEW |
|-----|----|---------|-------|---|---|---|----|------|--|-------|------------|

Pride I, Van

| | | | | | | | | | | | |
|-------------|----|---------|-------|---|---|---|----|------|--|-------|------------|
| 1.5 CRDi LX | 81 | 03/05 → | 1.493 | D | M | 4 | 16 | D4FA | | 84058 | NEW |
| 1.6 CVT LX | 82 | 03/05 → | 1.599 | B | M | 4 | 16 | G4ED | | 82020 | |

Pro Cee'd I

| | | | | | | | | | | | |
|--------------|-----|---------------|-------|---|---|---|----|--------|--|-------|------------|
| 1.4 | 77 | 02/08 → 09/12 | 1.396 | B | M | 4 | 16 | G4FA | | 84015 | NEW |
| | 80 | 02/08 → 09/12 | 1.396 | B | M | 4 | 16 | G4FA | | 84015 | NEW |
| 1.4 CVT | 66 | 06/10 → 09/12 | 1.396 | B | M | 4 | 16 | G4FA-L | | 84015 | NEW |
| 1.6 | 90 | 02/08 → 09/12 | 1.591 | B | M | 4 | 16 | G4FC | | 84015 | NEW |
| | 93 | 02/08 → 09/12 | 1.591 | B | M | 4 | 16 | G4FC | | 84015 | NEW |
| 1.6 CRDi 115 | 85 | 02/08 → 09/12 | 1.582 | D | M | 4 | 16 | D4FB | | 84058 | NEW |
| 1.6 CRDi 90 | 66 | 02/08 → 09/12 | 1.582 | D | M | 4 | 16 | D4FB-L | | 84058 | NEW |
| 1.6 CVT | 92 | 10/10 → 02/13 | 1.591 | B | M | 4 | 16 | G4FC | | 84015 | NEW |
| 2.0 | 105 | 02/08 → 09/12 | 1.975 | B | M | 4 | 16 | G4GC | | 81785 | |
| 2.0 CRDi 140 | 103 | 02/08 → 09/12 | 1.991 | D | M | 4 | 16 | D4EA-F | | 84059 | NEW |
| 2.0 LPG | 105 | 01/09 → 12/09 | 1.975 | | M | 4 | 16 | G4GC | | 81785 | |

Pro Cee'd II

| | | | | | | | | | | | |
|--------------|-----|---------|-------|---|---|---|----|------|--|-------|------------|
| 1.4 CRDi 90 | 66 | 03/13 → | 1.396 | D | M | 4 | 16 | D4FC | | 84063 | NEW |
| 1.4 CVT | 73 | 03/13 → | 1.396 | B | M | 4 | 16 | G4FA | | 84015 | NEW |
| 1.6 CRDi 110 | 81 | 03/13 → | 1.582 | D | M | 4 | 16 | D4FB | | 84063 | NEW |
| 1.6 CRDi 128 | 94 | 03/13 → | 1.582 | D | M | 4 | 16 | D4FB | | 84063 | NEW |
| 1.6 GDI | 99 | 03/13 → | 1.591 | B | M | 4 | 16 | G4FD | | 84015 | NEW |
| 1.6 GT | 150 | 06/13 → | 1.591 | B | M | 4 | 16 | G4FJ | | 84015 | NEW |

Rio II

| | | | | | | | | | | | |
|----------|----|---------|-------|---|---|---|----|------|-----------|-------|------------|
| 1.4 16V | 71 | 03/05 → | 1.399 | B | M | 4 | 16 | G4EE | | 82020 | |
| 1.5 CRDi | 65 | 06/08 → | 1.493 | D | M | 4 | 16 | D4FA | | 84063 | NEW |
| | 81 | 03/05 → | 1.493 | D | M | 4 | 16 | D4FA | → 04-2008 | 84058 | NEW |
| 1.6 16V | 82 | 03/05 → | 1.599 | B | M | 4 | 16 | G4ED | | 82020 | |
| 1.6 CVT | 82 | 03/05 → | 1.599 | B | M | 4 | 16 | G4ED | | 82020 | |

Rio III

| | | | | | | | | | | | |
|----------|----|---------|-------|---|---|---|----|------|--|-------|------------|
| 1.1 CRDi | 55 | 09/11 → | 1.120 | D | M | 3 | 12 | D3FA | | 84063 | NEW |
| 1.2 CVT | 62 | 11/14 → | 1.248 | B | M | 4 | 16 | G4LA | | 84040 | NEW |
| 1.25 CVT | 63 | 09/11 → | 1.248 | B | M | 4 | 16 | G4LA | | 84040 | NEW |
| 1.25 LPG | 63 | 09/11 → | 1.248 | | M | 4 | 16 | G4LA | | 84040 | NEW |
| 1.4 CRDi | 66 | 09/11 → | 1.396 | D | M | 4 | 16 | D4FC | | 84063 | NEW |
| 1.4 CVT | 79 | 09/11 → | 1.396 | B | M | 4 | 16 | G4FA | | 84015 | NEW |
| | 80 | 09/11 → | 1.396 | B | M | 4 | 16 | G4FA | | 84015 | NEW |
| 1.6 CVT | 90 | 06/12 → | 1.591 | B | M | 4 | 16 | G4FC | | 84015 | NEW |

KW

cm³

NO. OF VALVES

MAGNETI MARELLI
KIA
Soul I

| | | | | | | | | | | | |
|---------|-----|---------------|-------|---|---|---|----|------|--|-------|------------|
| 1.6 | 91 | 09/09 → 12/10 | 1.591 | B | M | 4 | 16 | G4FG | | 84015 | NEW |
| 1.6 CVT | 77 | 02/09 → | 1.591 | B | M | 4 | 16 | G4FC | | 84015 | NEW |
| | 93 | 02/09 → | 1.591 | B | M | 4 | 16 | G4FC | | 84015 | NEW |
| | 95 | 03/12 → | 1.591 | B | M | 4 | 16 | G4FC | | 84015 | NEW |
| 1.6 GDI | 103 | 06/11 → | 1.591 | B | M | 4 | 16 | G4FD | | 84015 | NEW |

Soul II

| | | | | | | | | | | | |
|---------|----|---------|-------|---|---|---|----|------|--|-------|------------|
| 1.6 GDI | 97 | 02/14 → | 1.591 | B | M | 4 | 16 | G4FD | | 84015 | NEW |
|---------|----|---------|-------|---|---|---|----|------|--|-------|------------|

Sportage II

| | | | | | | | | | | | |
|--------------|---------|---------|-------|---|---|----|------|----------------|-------|------------|------------|
| 2.0 16V 4WD | 104 | 09/04 → | 1.975 | B | M | 4 | 16 | G4GC | | 81785 | |
| 2.0 CRDi | 83 | 02/05 → | 1.991 | D | M | 4 | 16 | D4EA | | 82085 | |
| | 83 | 02/05 → | 1.991 | D | M | 4 | 16 | D4EA | | 84059 | NEW |
| | 100 | 01/06 → | 1.991 | D | M | 4 | 16 | D4EA | | 84059 | NEW |
| | 103 | 01/06 → | 1.991 | D | M | 4 | 16 | D4EA-V | | 82085 | |
| | 103 | 01/06 → | 1.991 | D | M | 4 | 16 | D4EA-V | | 84059 | NEW |
| | 110 | 09/08 → | 1.991 | D | M | 4 | 16 | D4EA | | 84059 | NEW |
| 2.0 CRDi 4WD | 83 | 09/04 → | 1.991 | D | M | 4 | 16 | D4EA | | 82085 | |
| | 83 | 09/04 → | 1.991 | D | M | 4 | 16 | D4EA | | 84059 | NEW |
| | 100 | 01/06 → | 1.991 | D | M | 4 | 16 | D4EA | | 84059 | NEW |
| | 103 | 01/06 → | 1.991 | D | M | 4 | 16 | D4EA-F, D4EA-V | | 82085 | |
| | 103 | 01/06 → | 1.991 | D | M | 4 | 16 | D4EA-F, D4EA-V | | 84059 | NEW |
| 110 | 09/08 → | 1.991 | D | M | 4 | 16 | D4EA | | 84059 | NEW | |
| 2.0 i 16V | 104 | 09/04 → | 1.975 | B | M | 4 | 16 | G4GC | | 81785 | |
| 2.7 V6 4WD | 129 | 09/04 → | 2.656 | B | M | 6 | 24 | G6BA | | 82021 | |

Sportage III

| | | | | | | | | | | | |
|-------------|-----|---------|-------|---|---|---|----|------|--|-------|------------|
| 1.6 GDI | 97 | 09/15 → | 1.591 | B | M | 4 | 16 | G4FD | | 84015 | NEW |
| | 99 | 02/11 → | 1.591 | B | M | 4 | 16 | G4FD | | 84015 | NEW |
| | 130 | 09/15 → | 1.591 | B | M | 4 | 16 | G4FJ | | 84015 | NEW |
| 1.6 GDI 4WD | 130 | 09/15 → | 1.591 | B | M | 4 | 16 | G4FJ | | 84015 | NEW |
| 2.0 CVT | 120 | 07/10 → | 1.998 | B | M | 4 | 16 | G4KD | | 84064 | NEW |
| | 122 | 07/10 → | 1.998 | B | M | 4 | 16 | G4KD | | 84064 | NEW |
| 2.0 CVT AWD | 120 | 07/10 → | 1.998 | B | M | 4 | 16 | G4KD | | 84064 | NEW |
| 2.0 GDI | 122 | 02/14 → | 1.998 | B | M | 4 | 16 | G4NC | | 84064 | NEW |
| 2.0 GDI AWD | 122 | 02/14 → | 1.998 | B | M | 4 | 16 | G4NC | | 84064 | NEW |

Venga

| | | | | | | | | | | | |
|---------|----|---------|-------|---|---|---|----|--------|--|-------|------------|
| 1.4 CVT | 66 | 02/10 → | 1.396 | B | M | 4 | 16 | G4FA-L | | 84015 | NEW |
| 1.6 CVT | 92 | 02/10 → | 1.591 | B | M | 4 | 16 | G4FC | | 84015 | NEW |

LADA
110

| | | | | | | | | | | | |
|-------|-----|---------|-------|---|---|---|----|----------|--|-------|--|
| 1.5 | 54 | 01/95 → | 1.499 | B | M | 4 | 8 | BA32111 | | 81717 | |
| | 56 | 10/00 → | 1.499 | B | M | 4 | 8 | VAZ-2111 | | 81717 | |
| | 57 | 01/95 → | 1.499 | B | M | 4 | 8 | VAZ-2111 | | 81717 | |
| 2.0 i | 110 | 08/96 → | 1.998 | B | M | 4 | 16 | C20XE | | 81550 | |

KW

cm³

NO. OF VALVES

MAGNETI MARELLI
LADA
Niva I

| | | | | | | | | | | |
|-------------|----|---------------|-------|---|---|---|---|----------|--|-------|
| 1600 | 54 | 01/87 → 03/95 | 1.569 | B | M | 4 | 8 | BA32121 | | 81999 |
| 1700 i | 59 | 06/96 → | 1.690 | B | M | 4 | 8 | BA321214 | | 81999 |
| 1700 i 4x4 | 60 | 10/00 → | 1.690 | B | M | 4 | 8 | BA321214 | | 81999 |
| 1900 Diesel | 47 | 01/93 → | 1.905 | D | M | 4 | 8 | XUD9A | | 81672 |
| | 55 | 01/99 → | 1.905 | D | M | 4 | 8 | XUD9SD | | 81672 |

Nova

| | | | | | | | | | | |
|----------------|----|---------------|-------|---|---|---|---|---------|--|-------|
| 1300 | 48 | 09/85 → 12/91 | 1.294 | B | M | 4 | 8 | BA32105 | | 81999 |
| 1500 | 49 | 08/94 → | 1.451 | B | M | 4 | 8 | BA32103 | | 81999 |
| | 55 | 09/85 → 02/93 | 1.458 | B | M | 4 | 8 | BA32103 | | 81999 |
| 1600 | 56 | 01/88 → 10/01 | 1.570 | B | M | 4 | 8 | BA32106 | | 81999 |
| 1700 | 62 | 08/94 → | 1.690 | B | M | 4 | 8 | B032123 | | 81999 |
| 1700 i Classic | 62 | 06/96 → | 1.690 | B | M | 4 | 8 | B032123 | | 81999 |

Samara

| | | | | | | | | | | |
|------|----|---------------|-------|---|---|---|---|----------|-----------|-------|
| 1.5 | 57 | 04/96 → | 1.499 | B | M | 4 | 8 | VAZ-2111 | | 81717 |
| 1100 | 43 | 02/96 → | 1.099 | B | M | 4 | 8 | BA321081 | | 81717 |
| | 39 | 02/88 → 12/94 | 1.100 | B | M | 4 | 8 | BA321081 | → 02-1992 | 81619 |
| | 39 | 02/88 → 12/94 | 1.100 | B | M | 4 | 8 | BA321081 | 03-1992 → | 81717 |
| | 45 | 09/91 → | 1.288 | B | M | 4 | 8 | BA32108 | → 02-1992 | 81619 |
| 1300 | 45 | 09/91 → | 1.288 | B | M | 4 | 8 | BA32108 | 03-1992 → | 81717 |
| | 48 | 01/86 → 12/94 | 1.288 | B | M | 4 | 8 | BA32108 | → 02-1992 | 81619 |
| | 48 | 01/86 → 12/94 | 1.288 | B | M | 4 | 8 | BA32108 | 03-1992 → | 81717 |
| | 50 | 02/96 → | 1.288 | B | M | 4 | 8 | BA321115 | | 81717 |
| | 52 | 02/95 → | 1.499 | B | M | 4 | 8 | BA32111 | | 81717 |
| 1500 | 50 | 09/91 → | 1.500 | B | M | 4 | 8 | BA321083 | → 02-1992 | 81619 |
| | 50 | 09/91 → | 1.500 | B | M | 4 | 8 | BA321083 | 03-1992 → | 81717 |

Samara Forma

| | | | | | | | | | | |
|------|----|---------------|-------|---|---|---|---|----------|-----------|-------|
| 1.5 | 57 | 01/00 → | 1.499 | B | M | 4 | 8 | VAZ-2111 | | 81717 |
| 1100 | 39 | 07/91 → | 1.100 | B | M | 4 | 8 | BA321081 | → 02-1992 | 81619 |
| | 39 | 07/91 → | 1.100 | B | M | 4 | 8 | BA321081 | 03-1992 → | 81717 |
| 1300 | 45 | 07/91 → | 1.288 | B | M | 4 | 8 | BA32108 | → 02-1992 | 81619 |
| | 45 | 07/91 → | 1.288 | B | M | 4 | 8 | BA32108 | 03-1992 → | 81717 |
| | 46 | 05/90 → | 1.288 | B | M | 4 | 8 | BA32108 | → 02-1992 | 81619 |
| | 46 | 05/90 → | 1.288 | B | M | 4 | 8 | BA32108 | 03-1992 → | 81717 |
| | 48 | 05/89 → 07/97 | 1.288 | B | M | 4 | 8 | BA32108 | → 02-1992 | 81619 |
| | 48 | 05/89 → 07/97 | 1.288 | B | M | 4 | 8 | BA32108 | 03-1992 → | 81717 |
| | 50 | 02/96 → | 1.288 | B | M | 4 | 8 | BA321115 | | 81717 |
| | 52 | 11/94 → | 1.499 | B | M | 4 | 8 | BA32111 | | 81717 |
| 1500 | 50 | 07/91 → | 1.500 | B | M | 4 | 8 | BA321083 | → 02-1992 | 81619 |
| | 50 | 07/91 → | 1.500 | B | M | 4 | 8 | BA321083 | 03-1992 → | 81717 |
| | 53 | 09/91 → | 1.500 | B | M | 4 | 8 | BA321083 | → 02-1992 | 81619 |
| | 53 | 09/91 → | 1.500 | B | M | 4 | 8 | BA321083 | 03-1992 → | 81717 |

Toscana

| | | | | | | | | | | |
|------|----|---------------|-------|---|---|---|---|---------|--|-------|
| 1500 | 55 | 09/83 → 02/93 | 1.458 | B | M | 4 | 8 | BA32103 | | 81999 |
|------|----|---------------|-------|---|---|---|---|---------|--|-------|

KW

cm³

NO. OF VALVES

LANCIA
Dedra, Station Wagon

| | | | | | | | | | | |
|--------------------------|-----|---------------|-------|---|---|---|----|------------------------------------|-------------------------|-------|
| 1.6 | 66 | 10/94 → 07/99 | 1.581 | B | M | 4 | 8 | 159B9.000 | (-)COP | 81339 |
| | 66 | 10/94 → 07/99 | 1.581 | B | M | 4 | 8 | 159B9.000 | (+)COP | 81303 |
| 1.6 16V | 76 | 01/96 → 07/99 | 1.581 | B | M | 4 | 16 | 182A4.000 | (-)COP | 81339 |
| | 76 | 01/96 → 07/99 | 1.581 | B | M | 4 | 16 | 182A4.000 | (+)COP | 81303 |
| 1.6 i.e. | 55 | 04/93 → 07/99 | 1.581 | B | M | 4 | 8 | 835C1.000 | (-)COP | 81339 |
| | 55 | 04/93 → 07/99 | 1.581 | B | M | 4 | 8 | 835C1.000 | (+)COP | 81303 |
| | 57 | 08/89 → 03/93 | 1.581 | B | M | 4 | 8 | 835A1.046 | (-)COP | 81314 |
| | 57 | 08/89 → 03/93 | 1.581 | B | M | 4 | 8 | 835A1.046 | (+)COP | 81476 |
| | 57 | 08/89 → 03/93 | 1.581 | B | M | 4 | 8 | 835A1.046 | (+)SS | 81333 |
| | 66 | 08/89 → 06/94 | 1.581 | B | M | 4 | 8 | 835A1.000 | (-)COP | 81314 |
| | 66 | 08/89 → 06/94 | 1.581 | B | M | 4 | 8 | 835A1.000 | (+)COP | 81476 |
| | 66 | 08/89 → 06/94 | 1.581 | B | M | 4 | 8 | 835A1.000 | (+)SS | 81333 |
| 1.6 LE | 66 | 07/94 → 07/99 | 1.581 | B | M | 4 | 8 | 159B9.000 | (-)COP | 81339 |
| | 66 | 07/94 → 07/99 | 1.581 | B | M | 4 | 8 | 159B9.000 | (+)COP | 81303 |
| 1.8 16V LE | 83 | 03/96 → 07/99 | 1.747 | B | M | 4 | 16 | 182A2.000 | | 81331 |
| 1.8 GT 16V | 96 | 03/96 → 07/99 | 1.747 | B | M | 4 | 16 | 183A1.000 | | 81331 |
| 1.8 i.e. | 66 | 08/93 → 07/99 | 1.756 | B | M | 4 | 8 | 835C5.000 | | 81315 |
| | 74 | 07/94 → 07/99 | 1.756 | B | M | 4 | 8 | 836A5.000 | | 81315 |
| | 77 | 09/89 → 07/99 | 1.756 | B | M | 4 | 8 | 835A2.046 | 05-1994 → | 81315 |
| | 77 | 09/89 → 07/99 | 1.756 | B | M | 4 | 8 | 835A2.046 | 09-1989 →, → 04-1994 | 81460 |
| | 80 | 09/89 → 06/94 | 1.756 | B | M | 4 | 8 | 835A2.000 | | 81460 |
| 1.9 TDS | 66 | 07/94 → 07/99 | 1.929 | D | M | 4 | 8 | 160D1.000, 835A4.000 | (-)COP | 81363 |
| | 66 | 07/94 → 07/99 | 1.929 | D | M | 4 | 8 | 160D1.000, 835A4.000 | (+)COP | 81347 |
| | 66 | 04/89 → 07/99 | 1.929 | D | M | 4 | 8 | 160D1.000, 835A4.000, 835A4.046 | (-)COP, → 04-1994 | 81326 |
| | 66 | 04/89 → 07/99 | 1.929 | D | M | 4 | 8 | 160D1.000, 835A4.000, 835A4.046 | (-)COP, 05-1994 → | 81363 |
| | 66 | 04/89 → 07/99 | 1.929 | D | M | 4 | 8 | 160D1.000, 835A4.000, 835A4.046 | (+)COP, → 04-1994 | 81464 |
| | 66 | 04/89 → 07/99 | 1.929 | D | M | 4 | 8 | 160D1.000, 835A4.000, 835A4.046 | (+)COP, 05-1994 → | 81347 |
| 2.0 16V | 102 | 07/94 → 07/99 | 1.995 | B | M | 4 | 16 | 836A3.000 | | 81322 |
| 2.0 HF Integrale | 124 | 11/90 → 07/94 | 1.995 | B | M | 4 | 8 | 835A7.046 | | 81315 |
| 2.0 i.e. | 83 | 09/89 → 07/99 | 1.995 | B | M | 4 | 8 | 835A5.046 | 05-1994 → | 81315 |
| | 83 | 09/89 → 07/99 | 1.995 | B | M | 4 | 8 | 835A5.046 | 09-1989 →, → 04-1994 | 81460 |
| | 86 | 09/89 → 07/92 | 1.995 | B | M | 4 | 8 | 835A5.000 | | 81460 |
| 2.0 i.e. Turbo | 119 | 04/91 → 07/99 | 1.995 | B | M | 4 | 8 | 835A8.046 | | 81315 |
| 2.0 i.e. Turbo Integrale | 121 | 05/90 → 07/94 | 1.995 | B | M | 4 | 8 | 835A7.000 | | 81315 |
| 2.0 Integrale | 102 | 07/94 → 07/99 | 1.995 | B | M | 4 | 16 | 836A3.000 | | 81322 |
| 2.0 Turbo | 130 | 11/90 → 06/94 | 1.995 | B | M | 4 | 8 | 835A8.000 | | 81315 |

KW

cm³

NO. OF VALVES

LANCIA
Delta I

| | | | | | | | | | | |
|--------------------------|-----|---------------|-------|---|---|---|----|----------------------|-------------------|-------|
| 1.1 | 47 | 01/86 → 12/90 | 1.116 | B | M | 4 | 8 | 831B8.000 | (-)COP | 81481 |
| 1.3 | 58 | 09/83 → 08/92 | 1.301 | B | M | 4 | 8 | 831A2.000 | (-)COP | 81481 |
| | 55 | 09/79 → 08/92 | 1.301 | B | M | 4 | 8 | 831A2.000, 831B.000 | (-)COP | 81481 |
| 1.5 | 63 | 09/79 → 12/92 | 1.498 | B | M | 4 | 8 | 831A1.000, 831B1.000 | (-)COP, → 03-1986 | 81481 |
| 1.6 GT i.e. | 66 | 05/87 → 08/92 | 1.585 | B | M | 4 | 8 | 149C2.000 | | 81436 |
| 1.6 HF Turbo | 122 | 08/86 → 05/93 | 1.585 | B | M | 4 | 8 | | | 81436 |
| 2.0 16V HF Evo Integrale | 155 | 06/93 → 01/94 | 1.995 | B | M | 4 | 16 | 831E5.000, 831E5.046 | | 81490 |
| 2.0 16V HF Integrale | 144 | 03/89 → 09/91 | 1.995 | B | M | 4 | 16 | 831D5.000 | | 81490 |
| 2.0 HF Integrale | 130 | 12/86 → 12/92 | 1.995 | B | M | 4 | 8 | 831C5.046 | | 81490 |

Delta II

| | | | | | | | | | | |
|-----------------|-----|---------------|-------|---|---|---|----|---------------------------------|---------------------------------|-------|
| 1.4 i.e. | 51 | 10/94 → 08/99 | 1.372 | B | M | 4 | 8 | 160A1.046, 836A4.000 | (-)COP, 04-1995 → | 81339 |
| | 51 | 10/94 → 08/99 | 1.372 | B | M | 4 | 8 | 160A1.046, 836A4.000 | (+)COP, 04-1995 → | 81303 |
| | 51 | 10/94 → 08/99 | 1.372 | B | M | 4 | 8 | 160A1.046, 836A4.000 | → 03-1995 | 81333 |
| 1.6 i.e. | 55 | 06/93 → 08/99 | 1.581 | B | M | 4 | 8 | 835C1.000 | (-)COP, 04-1995 →, (+)SS, (+)AC | 81339 |
| | 55 | 06/93 → 08/99 | 1.581 | B | M | 4 | 8 | 835C1.000 | (+)COP, 04-1995 →, (+)SS, (+)AC | 81303 |
| | 55 | 06/93 → 08/99 | 1.581 | B | M | 4 | 8 | 835C1.000 | → 03-1995 | 81333 |
| 1.6 i.e. 16V | 66 | 03/96 → 08/99 | 1.581 | B | M | 4 | 16 | 182A6.000 | (-)COP | 81364 |
| | 66 | 03/96 → 08/99 | 1.581 | B | M | 4 | 16 | 182A6.000 | (+)COP | 81341 |
| 1.6 i.e. 16V | 76 | 01/96 → 08/99 | 1.581 | B | M | 4 | 16 | 182A4.000 | (-)COP | 81364 |
| | 76 | 01/96 → 08/99 | 1.581 | B | M | 4 | 16 | 182A4.000 | (+)COP | 81341 |
| 1.8 i.e. | 66 | 07/94 → 08/99 | 1.756 | B | M | 4 | 8 | 835C4.000, 836A6.000, 836C4.000 | | 81315 |
| | 76 | 06/93 → 08/99 | 1.756 | B | M | 4 | 8 | 835C2.000 | | 81315 |
| 1.8 i.e. 16V | 83 | 03/96 → 08/99 | 1.747 | B | M | 4 | 16 | 182A2.000 | | 81331 |
| 1.8 i.e. 16V GT | 96 | 03/96 → 08/99 | 1.747 | B | M | 4 | 16 | 183A1.000 | | 81331 |
| 1.9 TD | 66 | 10/94 → 08/99 | 1.929 | D | M | 4 | 8 | 160D1.000, 835A4.000 | (-)COP | 81363 |
| | 66 | 10/94 → 08/99 | 1.929 | D | M | 4 | 8 | 160D1.000, 835A4.000 | (+)COP | 81347 |
| 2.0 16V | 102 | 06/93 → 08/99 | 1.995 | B | M | 4 | 16 | 836A3.000 | | 81322 |
| 2.0 16V Turbo | 137 | 06/93 → 08/99 | 1.995 | B | M | 4 | 16 | 836A2.000 | | 81322 |
| | 142 | 07/96 → 08/99 | 1.995 | B | M | 4 | 16 | 175A4.000 | | 81322 |

Delta III

| | | | | | | | | | | |
|----------------|-----|---------------|-------|----|---|---|----|-----------|----------|-------|
| 1.4 | 88 | 09/08 → 08/14 | 1.368 | B | M | 4 | 16 | 198A4.000 | PIERBURG | 81369 |
| | 88 | 09/08 → 08/14 | 1.368 | B | M | 4 | 16 | 198A4.000 | TESMA | 82070 |
| | 110 | 09/08 → 08/14 | 1.368 | B | M | 4 | 16 | 198A1.000 | PIERBURG | 81369 |
| | 110 | 09/08 → 08/14 | 1.368 | B | M | 4 | 16 | 198A1.000 | TESMA | 82070 |
| 1.4 16V | 103 | 07/10 → 08/14 | 1.368 | B | M | 4 | 16 | 198A7.000 | TESMA | 82070 |
| 1.4 Bifuel | 88 | 07/11 → 08/14 | 1.368 | BF | M | 4 | 16 | 198A4.000 | TESMA | 82070 |
| 1.6 D Multijet | 77 | 04/11 → 08/14 | 1.598 | D | M | 4 | 16 | 944A3.000 | | 81872 |
| | 85 | 08/08 → 08/14 | 1.598 | D | M | 4 | 16 | 955A4.000 | | 81872 |
| | 88 | 09/08 → 08/14 | 1.598 | D | M | 4 | 16 | 198A2.000 | | 81872 |
| 1.8 | 147 | 01/09 → 08/14 | 1.742 | B | M | 4 | 16 | 939B1.000 | | 81331 |

KW

cm³

NO. OF VALVES

LANCIA
Delta III

| | | | | | | | | | | |
|----------------|-----|---------------|-------|---|---|---|----|----------------------|--|-------|
| 1.9 D Multijet | 140 | 01/09 → 08/14 | 1.910 | D | M | 4 | 16 | 844A1.000 | | 81872 |
| 2.0 D Multijet | 120 | 09/08 → 08/14 | 1.956 | D | M | 4 | 16 | 844A2.000 | | 81872 |
| | 121 | 09/08 → 08/14 | 1.956 | D | M | 4 | 16 | 198A5.000, 198A8.000 | | 81872 |

Kappa, Station Wagon, Coupé

| | | | | | | | | | | |
|---------------|-----|---------------|-------|---|---|---|----|----------------------|----------------------------|-------|
| 2.0 16V Turbo | 151 | 02/95 → 10/01 | 1.995 | B | M | 4 | 16 | 838A4.000 | | 81490 |
| 2.0 20V | 114 | 07/96 → 03/01 | 1.998 | B | M | 5 | 20 | 838A6.000 | | 81329 |
| | 107 | 10/94 → 10/01 | 1.998 | B | M | 5 | 20 | 838A1.000 | | 81329 |
| | 114 | 07/96 → 10/01 | 1.998 | B | M | 5 | 20 | 838A6.000 | | 81329 |
| 2.0 20V Turbo | 162 | 06/98 → 10/01 | 1.998 | B | M | 5 | 20 | 175A3.000 | | 81329 |
| 2.4 20V | 129 | 11/96 → 03/01 | 2.446 | B | M | 5 | 20 | 838A2.000 | | 81329 |
| | 129 | 08/94 → 10/01 | 2.446 | B | M | 5 | 20 | 838A2.000, 838A2.027 | | 81329 |
| 2.4 JTD | 100 | 06/98 → 10/01 | 2.387 | D | M | 5 | 10 | 838A8.000 | | 81352 |
| 2.4 T.DS | 91 | 08/94 → 10/01 | 2.387 | D | M | 5 | 10 | 838A3.000, 838A7.000 | → 08-1997, → M: 727.390 | 81330 |
| | 91 | 08/94 → 10/01 | 2.387 | D | M | 5 | 10 | 838A3.000, 838A7.000 | 09-1997 →, M →: 727.391 | 81352 |
| 3.0 24V | 150 | 08/94 → 10/01 | 2.959 | B | M | 6 | 24 | 838B.000 | | 81355 |

Lybra, Station Wagon

| | | | | | | | | | | |
|---------|-----|---------------|-------|---|---|---|----|------------------------------------|--------|-------|
| 1.6 | 76 | 10/00 → 10/05 | 1.596 | B | M | 4 | 16 | 182B6.000 | (-)COP | 81364 |
| | 76 | 10/00 → 10/05 | 1.596 | B | M | 4 | 16 | 182B6.000 | (+)COP | 81341 |
| 1.6 16V | 76 | 07/99 → 10/05 | 1.581 | B | M | 4 | 16 | 182A4.000, 182B6.000 | (-)COP | 81364 |
| | 76 | 07/99 → 10/05 | 1.581 | B | M | 4 | 16 | 182A4.000, 182B6.000 | (+)COP | 81341 |
| 1.8 16V | 96 | 07/99 → 10/05 | 1.747 | B | M | 4 | 16 | 839A4.000, 839A7.000 | | 81331 |
| | 96 | 07/99 → 10/05 | 1.747 | B | M | 4 | 16 | 839A4.000, 839A7.000, 839A9.000 | | 81331 |
| 1.9 JTD | 85 | 05/01 → 10/05 | 1.910 | D | M | 4 | 8 | 937A2.000 | | 81352 |
| | 77 | 07/99 → 09/00 | 1.910 | D | M | 4 | 8 | AR32302 | | 81352 |
| | 81 | 09/00 → 05/01 | 1.910 | D | M | 4 | 8 | AR37101 | | 81352 |
| 2.0 20V | 110 | 09/00 → 10/05 | 1.998 | B | M | 5 | 20 | 185A8.000 | | 81329 |
| | 113 | 07/99 → 09/00 | 1.998 | B | M | 5 | 20 | 182B7.000 | | 81329 |
| 2.4 20V | 125 | 10/01 → 10/05 | 2.446 | B | M | 5 | 20 | 192A2.000 | | 81329 |
| 2.4 JTD | 110 | 05/02 → 10/05 | 2.387 | D | M | 5 | 10 | 841C.000 | | 81796 |
| | 110 | 05/02 → 10/05 | 2.387 | D | M | 5 | 10 | 841C.000 | | 81352 |
| | 99 | 07/99 → 02/01 | 2.387 | D | M | 5 | 10 | 839A5.000, AR32501 | | 81352 |
| | 103 | 09/00 → 05/02 | 2.387 | D | M | 5 | 10 | 839A6.000 | | 81352 |

Musa

| | | | | | | | | | | |
|----------------|----|---------------|-------|---|---|---|----|-----------|----------|-------|
| 1.3 D Multijet | 51 | 10/04 → 09/12 | 1.248 | D | M | 4 | 16 | 188A9.000 | | 81862 |
| | 66 | 09/06 → 09/12 | 1.248 | D | M | 4 | 16 | 199A3.000 | | 81862 |
| | 70 | 03/09 → 09/12 | 1.248 | D | M | 4 | 16 | 199B1.000 | | 81862 |
| 1.4 | 57 | 09/05 → 09/12 | 1.368 | B | M | 4 | 8 | 350A1.000 | PIERBURG | 81369 |
| | 57 | 09/05 → 09/12 | 1.368 | B | M | 4 | 8 | 350A1.000 | TESMA | 82070 |
| | 66 | 10/07 → 09/12 | 1.368 | B | M | 4 | 16 | 192B2.000 | TESMA | 82070 |
| | 70 | 10/04 → 09/12 | 1.368 | B | M | 4 | 16 | 843A1.000 | PIERBURG | 81369 |
| | 70 | 10/04 → 09/12 | 1.368 | B | M | 4 | 16 | 843A1.000 | TESMA | 82070 |

KW

cm³

NO. OF VALVES

LANCIA
Musa

| | | | | | | | | | | |
|----------------|----|---------------|-------|---|---|---|----|----------------------|-------|-------|
| 1.4 LPG | 57 | 11/10 → 09/12 | 1.368 | | M | 4 | 8 | 350A1.000 | TESMA | 82070 |
| 1.6 D Multijet | 85 | 07/08 → 09/12 | 1.598 | D | M | 4 | 16 | 350A2.000, 350A3.000 | | 81872 |
| | 88 | 07/08 → 09/12 | 1.598 | D | M | 4 | 16 | 350A2.000 | | 81872 |
| | 74 | 10/04 → 09/12 | 1.910 | D | M | 4 | 8 | 188B2.000 | | 81352 |

Phedra

| | | | | | | | | | | | |
|----------------|-----|---------------|-------|---|---|---|----|-----------------|--------|-------|------------|
| 2.0 | 100 | 09/02 → 11/10 | 1.997 | B | M | 4 | 16 | RFN (EW10J4) | (-)COP | 84038 | NEW |
| | 100 | 09/02 → 11/10 | 1.997 | B | M | 4 | 16 | RFN (EW10J4) | (+)COP | 82089 | |
| | 100 | 09/02 → 11/10 | 1.997 | B | M | 4 | 16 | RFN (EW10J4) | | 82089 | |
| | 100 | 09/02 → 11/10 | 1.997 | B | M | 4 | 16 | RFN (EW10J4) | | 81799 | |
| 2.0 D Multijet | 100 | 07/06 → 11/10 | 1.997 | D | M | 4 | 16 | RHR (DW10BTED4) | | 81800 | |
| 2.0 JTD | 79 | 07/03 → 11/10 | 1.997 | D | M | 4 | 16 | RHM (DW10ATED4) | | 81713 | |
| | 88 | 06/06 → 11/10 | 1.997 | D | M | 4 | 16 | RHK (DW10UTED4) | | 81800 | |
| | 80 | 09/02 → 11/10 | 1.997 | D | M | 4 | 16 | RHW (DW10ATED4) | | 81713 | |
| 2.2 D Multijet | 125 | 03/08 → 11/10 | 2.179 | D | M | 4 | 16 | 4HS, 4HT | | 82068 | |
| 2.2 JTD | 120 | 04/06 → 11/10 | 2.179 | D | M | 4 | 16 | 4HP, 4HR | | 82068 | |
| | 94 | 09/02 → 11/10 | 2.179 | D | M | 4 | 16 | 4HW (DW12ATED4) | | 81800 | |
| 3.0 V6 | 150 | 09/02 → 11/10 | 2.946 | B | M | 6 | 24 | ES9J4S | | 81813 | |

Prisma

| | | | | | | | | | | |
|-----|----|---------------|-------|---|---|---|---|-----------|--------|-------|
| 1.3 | 58 | 01/83 → 02/92 | 1.301 | B | M | 4 | 8 | 831A2.000 | (-)COP | 81481 |
| 1.6 | 73 | 08/86 → 02/92 | 1.585 | B | M | 4 | 8 | 831B6.000 | | 81436 |

Thema I, Station Wagon

| | | | | | | | | | | |
|---------------------|-----|---------------|-------|---|---|---|----|-----------|-------------------------|-------|
| 2000 16V | 112 | 08/92 → 12/93 | 1.995 | B | M | 4 | 16 | 834F1.000 | | 81490 |
| 2000 16V Turbo | 133 | 12/88 → 06/90 | 1.995 | B | M | 4 | 16 | 834C1.000 | | 81490 |
| | 148 | 10/92 → 07/94 | 1.995 | B | M | 4 | 16 | 834F2.000 | | 81490 |
| 2000 i.e | 86 | 09/88 → 05/92 | 1.995 | B | M | 4 | 8 | 834B1.000 | | 81460 |
| | 85 | 09/87 → 05/92 | 1.995 | B | M | 4 | 8 | 834B.146 | | 81460 |
| 2000 i.e. 16V | 104 | 02/89 → 05/92 | 1.995 | B | M | 4 | 16 | 834B2.246 | | 81490 |
| | 108 | 05/88 → 08/92 | 1.995 | B | M | 4 | 16 | 834B2.000 | | 81490 |
| 2000 i.e. 16V Turbo | 130 | 04/89 → 05/92 | 1.995 | B | M | 4 | 16 | 834C1.246 | | 81490 |
| | 133 | 12/88 → 06/90 | 1.995 | B | M | 4 | 16 | 834C1.000 | | 81490 |
| 2000 i.e.Turbo | 110 | 07/86 → 05/90 | 1.995 | B | M | 4 | 8 | 834C.146 | 12-1985 →, → 05-1990 | 81460 |
| 2000 Turbo | 110 | 01/89 → 03/92 | 1.995 | B | M | 4 | 8 | 834C.146 | | 81460 |
| 2000 Turbo 16V | 148 | 11/92 → 07/94 | 1.995 | B | M | 4 | 16 | 834F2.000 | | 81490 |
| 2500 Turbo DS | 85 | 06/88 → 05/92 | 2.499 | D | M | 4 | 8 | 8144.97 | 11-1991 → | 81324 |
| | 77 | 05/88 → 07/92 | 2.500 | D | M | 4 | 8 | 8144.97S | 11-1991 → | 81324 |
| | 85 | 05/92 → 07/94 | 2.500 | D | M | 4 | 8 | 8144.97Y | | 81325 |
| 3000 V6 | 126 | 08/92 → 07/94 | 2.959 | B | M | 6 | 12 | 834F.000 | | 81331 |

Thesis

| | | | | | | | | | | |
|----------------|-----|---------------|-------|---|---|---|----|----------|--|-------|
| 2.0 Turbo | 136 | 07/02 → 07/09 | 1.998 | B | M | 5 | 20 | 841E.000 | | 81329 |
| 2.4 | 125 | 07/02 → 07/09 | 2.446 | B | M | 5 | 20 | 841D.000 | | 81329 |
| 2.4 D Multijet | 136 | 04/06 → 07/09 | 2.387 | D | M | 5 | 20 | 841P.000 | | 81872 |

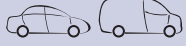
KW

cm³

NO. OF VALVES

LANCIA
Thesis

| | | | | | | | | | | |
|---------|-----|---------------|-------|---|---|---|----|--------------------|--|-------|
| 2.4 JTD | 120 | 09/03 → 07/09 | 2.387 | D | M | 5 | 20 | 841M.000, 841N.000 | | 81872 |
| | 129 | 05/03 → 07/09 | 2.387 | D | M | 5 | 20 | 841G.000 | | 81872 |
| | 110 | 07/02 → 07/09 | 2.387 | D | M | 5 | 10 | 841C.000 | | 81352 |
| 3.0 V6 | 158 | 07/02 → 07/09 | 2.959 | B | A | 6 | 24 | 841A.000 | | 81355 |
| | 169 | 05/03 → 07/09 | 3.179 | B | M | 6 | 24 | 841L.000 | | 81355 |

Y10

| | | | | | | | | | | |
|----------------------------------|----|---------------|-------|---|---|---|---|----------------------|--|-------|
| 1.0 Fire | 37 | 03/85 → 02/90 | 999 | B | M | 4 | 8 | 156A2.000 | | 81801 |
| | 32 | 06/85 → 06/91 | 999 | B | M | 4 | 8 | 156A2.100 | | 81801 |
| | 33 | 03/85 → 02/92 | 999 | B | M | 4 | 8 | 156A2.000, 156A2.246 | | 81801 |
| 1.0 Fire Trazione integrale | 37 | 12/87 → 02/90 | 999 | B | M | 4 | 8 | 156A2.000 | | 81801 |
| | 33 | 12/87 → 02/92 | 999 | B | M | 4 | 8 | 156A2.000, 156A2.246 | | 81801 |
| 1.1 Fire | 40 | 01/95 → 12/95 | 1.108 | B | M | 4 | 8 | 176B2.000 | | 81801 |
| 1.1 Fire Trazione integrale | 40 | 01/95 → 12/95 | 1.108 | B | M | 4 | 8 | 176B2.000 | | 81801 |
| 1.1 i.e Fire | 42 | 08/89 → 06/92 | 1.108 | B | M | 4 | 8 | 156C.000 | | 81801 |
| 1.1 i.e Fire Trazione integrale | 42 | 08/89 → 06/92 | 1.108 | B | M | 4 | 8 | 156C.000 | | 81801 |
| 1.1 i.e. Fire | 37 | 07/89 → 09/95 | 1.108 | B | M | 4 | 8 | 156C.046 | | 81801 |
| 1.1 i.e. Fire Trazione integrale | 37 | 09/92 → 12/95 | 1.108 | B | M | 4 | 8 | 156C.046 | | 81801 |
| 1.3 i.e. | 53 | 02/89 → 12/95 | 1.297 | B | M | 4 | 8 | 146A5.046, 156B.000 | | 81434 |
| | 56 | 11/87 → 05/93 | 1.301 | B | M | 4 | 8 | 156B.000 | | 81434 |

Y

| | | | | | | | | | | |
|---------|----|---------------|-------|---|---|---|----|----------------------|------------------|-------|
| 1.1 | 40 | 11/95 → 09/03 | 1.108 | B | M | 4 | 8 | 176B2.000 | | 81801 |
| 1.2 | 44 | 03/96 → 09/03 | 1.242 | B | M | 4 | 8 | 188A4.000, 840A3.000 | → 08-2000 | 81801 |
| | 44 | 03/96 → 09/03 | 1.242 | B | M | 4 | 8 | 188A4.000, 840A3.000 | 09-2000 →, MAGMA | 81370 |
| 1.2 16V | 59 | 10/00 → 09/03 | 1.242 | B | M | 4 | 16 | 188A5.000 | PIERBURG | 81369 |
| | 63 | 04/97 → 09/03 | 1.242 | B | M | 4 | 16 | 176B9.000 | PIERBURG | 81369 |
| 1.4 12V | 55 | 03/96 → 09/03 | 1.370 | B | M | 4 | 12 | 840A4.000 | → M: 705.144 | 81340 |
| | 55 | 03/96 → 09/03 | 1.370 | B | M | 4 | 12 | 840A4.000 | M →: 705.145 | 81351 |
| | 59 | 10/96 → 09/03 | 1.370 | B | M | 4 | 12 | 840A2.000 | → M: 705.144 | 81340 |
| 1.4 12V | 59 | 10/96 → 09/03 | 1.370 | B | M | 4 | 12 | 840A2.000 | M →: 705.145 | 81351 |

Ypsilon I

| | | | | | | | | | | |
|----------------|----|---------------|-------|---|---|---|----|-----------|----------|-------|
| 1.2 | 44 | 10/03 → 12/11 | 1.242 | B | M | 4 | 8 | 188A4.000 | MAGMA | 81370 |
| | 44 | 10/03 → 12/11 | 1.242 | B | M | 4 | 8 | 188A4.000 | TESMA | 82070 |
| | 51 | 08/10 → 12/11 | 1.242 | B | M | 4 | 8 | 169A4.000 | TESMA | 82070 |
| | 59 | 10/03 → 12/11 | 1.242 | B | M | 4 | 16 | 188A5.000 | PIERBURG | 81369 |
| | 59 | 10/03 → 12/11 | 1.242 | B | M | 4 | 16 | 188A5.000 | TESMA | 82070 |
| 1.3 D Multijet | 55 | 09/06 → 12/11 | 1.248 | D | M | 4 | 16 | 199A2.000 | | 81862 |
| | 66 | 09/06 → 12/11 | 1.248 | D | M | 4 | 16 | 199A3.000 | | 81862 |
| | 77 | 05/07 → 12/11 | 1.248 | D | M | 4 | 16 | 199A3.000 | | 81862 |
| 1.3 JTD | 51 | 10/03 → 12/11 | 1.248 | D | M | 4 | 16 | 188A9.000 | | 81862 |
| 1.4 | 57 | 02/06 → 12/11 | 1.368 | B | M | 4 | 8 | 350A1.000 | PIERBURG | 81369 |
| | 57 | 02/06 → 12/11 | 1.368 | B | M | 4 | 8 | 350A1.000 | TESMA | 82070 |

| | | | | | | | | | |
|--|--|--|--|--|--|--|--|--|--|
| | | | | | | | | | |
|--|--|--|--|--|--|--|--|--|--|

LANCIA

Ypsilon I

| | | | | | | | | | | |
|---------|----|---------------|-------|---|---|---|----|-----------|----------|-------|
| 1.4 16V | 70 | 10/03 → 12/11 | 1.368 | B | M | 4 | 16 | 843A1.000 | PIERBURG | 81369 |
| | 70 | 10/03 → 12/11 | 1.368 | B | M | 4 | 16 | 843A1.000 | TESMA | 82070 |
| 1.4 LPG | 57 | 11/10 → 12/11 | 1.368 | | M | 4 | 8 | 350A1.000 | TESMA | 82070 |

Ypsilon II

| | | | | | | | | | | |
|--------------|----|---------|-------|----|---|---|----|----------------------|-------|-------|
| 0.9 CNG | 63 | 05/11 → | 875 | | M | 2 | 8 | 312A2.000 | | 84008 |
| 0.9 Twinair | 59 | 12/13 → | 875 | B | M | 2 | 8 | 312A2.000, 312A5.000 | | 84008 |
| | 63 | 05/11 → | 875 | B | M | 2 | 8 | 312A2.000 | | 84008 |
| 1.2 | 51 | 05/11 → | 1.242 | B | M | 4 | 8 | 169A4.000 | TESMA | 82070 |
| 1.2 Bifuel | 49 | 05/11 → | 1.242 | BF | M | 4 | 8 | 169A4.000 | TESMA | 82070 |
| | 51 | 05/11 → | 1.242 | BF | M | 4 | 8 | 169A4.000 | TESMA | 82070 |
| 1.3 Multijet | 70 | 05/11 → | 1.248 | D | M | 4 | 16 | 199B1.000 | | 81862 |

Zeta

| | | | | | | | | | | | |
|-------------|-----|---------------|-------|---|---|---|----|----------------------|--------|-------|--|
| 2.0 16V | 100 | 07/00 → 09/02 | 1.997 | B | M | 4 | 16 | RFN | (-)COP | 84038 | |
| | 100 | 07/00 → 09/02 | 1.997 | B | M | 4 | 16 | RFN | (+)COP | 82089 | |
| | 100 | 07/00 → 09/02 | 1.997 | B | M | 4 | 16 | RFN | | 82089 | |
| | 100 | 07/00 → 09/02 | 1.997 | B | M | 4 | 16 | RFN | | 81799 | |
| | 97 | 05/98 → 07/00 | 1.998 | B | M | 4 | 16 | RFV (XU10J4R) | | 81711 | |
| 2.0 JTD | 80 | 04/00 → 09/02 | 1.997 | D | M | 4 | 8 | RHZ (DW10ATED) | | 81713 | |
| 2.0 JTD 16V | 80 | 09/99 → 09/02 | 1.997 | D | M | 4 | 16 | RHW, RHW (DW10ATED4) | | 81713 | |
| 2.0 Turbo | 108 | 05/95 → 09/02 | 1.998 | B | M | 4 | 8 | RGX (XU10J2TE) | | 81642 | |
| 2.1 TD | 80 | 05/96 → 09/99 | 2.088 | D | M | 4 | 12 | P8C | | 81353 | |

LAND ROVER

Defender Cabrio, Station Wagon, Pickup

| | | | | | | | | | | |
|-------------|----|---------|-------|---|---|---|----|---------|--|-------|
| 2.4 Td4 4x4 | 90 | 05/07 → | 2.402 | D | M | 4 | 16 | ZSD-424 | | 82057 |
|-------------|----|---------|-------|---|---|---|----|---------|--|-------|

Discovery I

| | | | | | | | | | | |
|--------------|----|---------------|-------|---|---|---|----|-------|--|-------|
| 2.0 16 V 4x4 | 99 | 06/89 → 10/98 | 1.994 | B | M | 4 | 16 | 20T4H | | 81707 |
|--------------|----|---------------|-------|---|---|---|----|-------|--|-------|

Discovery Sport

| | | | | | | | | | | |
|-----------|-----|---------|-------|---|---|---|----|-------|--|-------|
| 2.0 4WD | 177 | 12/14 → | 1.999 | B | M | 4 | 16 | 204PT | | 81804 |
| 2.2 D 4WD | 110 | 12/14 → | 2.179 | D | M | 4 | 16 | 224DT | | 82068 |
| | 140 | 12/14 → | 2.179 | D | M | 4 | 16 | 224DT | | 82068 |

Freelander I

| | | | | | | | | | | |
|------------|-----|---------------|-------|---|---|---|----|-------|--|-------|
| 2.0 DI 4x4 | 72 | 02/98 → 11/00 | 1.994 | D | M | 4 | 8 | 20T2N | | 81707 |
| 2.5 V6 4x4 | 130 | 11/00 → 10/06 | 2.497 | B | M | 6 | 24 | 25K4F | | 82029 |

Freelander II

| | | | | | | | | | | |
|-------------|-----|---------------|-------|---|---|---|----|------------------|--|-------|
| 2.0 Si4 4x4 | 177 | 10/11 → 10/14 | 1.999 | B | M | 4 | 16 | 204PT | | 81804 |
| 2.2 eD4 | 110 | 08/10 → 10/14 | 2.179 | D | M | 4 | 16 | 224DT, DW12BTED4 | | 82068 |
| 2.2 SD4 4x4 | 140 | 08/10 → 10/14 | 2.179 | D | M | 4 | 16 | 224DT | | 82068 |
| 2.2 TD4 4x4 | 110 | 10/06 → 10/14 | 2.179 | D | M | 4 | 16 | 224DT, DW12BTED4 | | 82068 |
| | 112 | 01/07 → 10/14 | 2.179 | D | M | 4 | 16 | 224DT | | 82068 |
| | 115 | 10/06 → 10/14 | 2.179 | D | M | 4 | 16 | 224DT | | 82068 |
| | 118 | 10/06 → 10/14 | 2.179 | D | M | 4 | 16 | 224DT, DW12BTED4 | | 82068 |



KW



cm³



NO. OF VALVES



MAGNETI MARELLI

LAND ROVER

Range Rover Evoque, Cabrio

| | | | | | | | | | | |
|-----------|-----|---------|-------|---|---|---|----|-------|--|-------|
| 2.0 4x4 | 177 | 06/11 → | 1.999 | B | M | 4 | 16 | 204PT | | 81804 |
| 2.2 D | 110 | 06/11 → | 2.179 | D | M | 4 | 16 | 224DT | | 82068 |
| 2.2 D 4x4 | 110 | 06/11 → | 2.179 | D | M | 4 | 16 | 224DT | | 82068 |
| | 140 | 06/11 → | 2.179 | D | M | 4 | 16 | 224DT | | 82068 |

Range Rover II

| | | | | | | | | | | |
|-----------|-----|---------------|-------|---|---|---|----|------------|--|-------|
| 2.5 D 4x4 | 100 | 07/94 → 03/02 | 2.497 | D | M | 6 | 12 | 256T (BMW) | | 81597 |
|-----------|-----|---------------|-------|---|---|---|----|------------|--|-------|

Range Rover III

| | | | | | | | | | | |
|-----------|-----|---------------|-------|---|---|---|----|-------|--|-------|
| 3.0 D 4x4 | 130 | 03/02 → 08/12 | 2.926 | D | M | 6 | 24 | 306D1 | | 81795 |
|-----------|-----|---------------|-------|---|---|---|----|-------|--|-------|

LEXUS

HS

| | | | | | | | | | | |
|------|-----|---------|-------|--|---|---|----|---------|--|-------|
| 250h | 110 | 07/09 → | 2.362 | | M | 4 | 16 | 2AZ-FXE | | 82055 |
|------|-----|---------|-------|--|---|---|----|---------|--|-------|

IS II

| | | | | | | | | | | |
|------|-----|---------|-------|---|---|---|----|---------|--|-------|
| 200d | 110 | 07/10 → | 2.231 | D | M | 4 | 16 | 2AD-FTV | | 82071 |
| 220d | 130 | 10/05 → | 2.231 | D | M | 4 | 16 | 2AD-FHV | | 82071 |

RX I

| | | | | | | | | | | |
|---------|-----|---------------|-------|---|---|---|----|--------|--|-------|
| 300 | 148 | 07/00 → 03/03 | 2.995 | B | M | 6 | 24 | 1MZ-FE | | 82051 |
| 300 AWD | 148 | 10/00 → 05/03 | 2.995 | B | A | 6 | 24 | 1MZ-FE | | 82051 |
| | 164 | 07/00 → 05/03 | 2.995 | B | M | 6 | 24 | 1MZ-FE | | 82051 |

RX II

| | | | | | | | | | | |
|----------|-----|---------------|-------|---|---|---|----|--------|--|-------|
| 300 | 150 | 05/03 → 12/08 | 2.995 | B | M | 6 | 24 | 1MZ-FE | | 82051 |
| 330 | 171 | 04/03 → 01/06 | 3.311 | B | M | 6 | 24 | 3MZ-FE | | 82051 |
| 330 AWD | 171 | 04/03 → 12/08 | 3.311 | B | M | 6 | 24 | 3MZ-FE | | 82051 |
| 400h | 155 | 09/05 → 12/08 | 3.311 | | M | 6 | 24 | 3MZ-FE | | 82051 |
| 400h AWD | 155 | 09/04 → 12/08 | 3.311 | | M | 6 | 24 | 3MZ-FE | | 82051 |

LOTUS

Elise I

| | | | | | | | | | | |
|-------|-----|---------------|-------|---|---|---|----|-------|--|-------|
| 1.8 | 88 | 08/95 → 11/00 | 1.796 | B | M | 4 | 16 | 18K4F | | 81615 |
| 111 S | 107 | 03/99 → 11/00 | 1.796 | B | M | 4 | 16 | 18K4K | | 81615 |

MAZDA

2 I

| | | | | | | | | | | |
|--------|----|---------------|-------|---|---|---|----|------------|--|-------|
| 1.2 | 55 | 02/03 → | 1.242 | B | M | 4 | 16 | FUJA | | 81598 |
| 1.25 | 55 | 04/03 → | 1.242 | B | M | 4 | 16 | FUJA | | 81598 |
| 1.3 L | 67 | 04/03 → 06/07 | 1.348 | B | M | 4 | 16 | ZJ04 | | 81598 |
| 1.4 | 59 | 02/03 → | 1.388 | B | M | 4 | 16 | FXJA | | 81598 |
| 1.4 CD | 50 | 04/03 → | 1.399 | D | M | 4 | 8 | F6JA, F6JB | | 81798 |
| 1.6 | 74 | 02/03 → | 1.596 | B | M | 4 | 16 | FYJA | | 81598 |

2 II, Saloon

| | | | | | | | | | | | |
|------------|----|---------------|-------|----|---|---|----|-------|--|-------|--|
| 1.3 | 55 | 10/07 → 06/15 | 1.349 | B | M | 4 | 16 | ZJ-VE | | 84060 | |
| | 63 | 10/07 → 06/15 | 1.349 | B | M | 4 | 16 | ZJ-VE | | 84060 | |
| 1.3 BiFuel | 55 | 05/11 → 11/14 | 1.349 | BF | M | 4 | 16 | ZJ46 | | 84060 | |
| | 62 | 05/11 → 11/14 | 1.349 | BF | M | 4 | 16 | ZJ46 | | 84060 | |



KW



cm³



NO. OF VALVES



MAZDA

2 II, Saloon

| | | | | | | | | | | | |
|------------|----|---------------|-------|---|---|---|----|--------------|--|-------|------------|
| 1.3 MZR | 62 | 01/10 → 06/15 | 1.349 | B | M | 4 | 16 | ZJ-VE | | 84060 | NEW |
| 1.4 MZR-CD | 50 | 01/08 → 06/15 | 1.399 | D | M | 4 | 8 | Y404 | | 81798 | |
| 1.5 | 76 | 10/07 → 06/15 | 1.498 | B | M | 4 | 16 | ZY-DE, ZY-VE | | 84060 | NEW |
| 1.5 MZR | 75 | 06/11 → 06/15 | 1.498 | B | M | 4 | 16 | ZY05, ZY66 | | 84060 | NEW |
| 1.6 MZ-CD | 66 | 10/08 → 06/15 | 1.560 | D | M | 4 | 16 | Y406, Y646 | | 81869 | |
| | 70 | 06/11 → 06/15 | 1.560 | D | M | 4 | 8 | Y655, Y661 | | 81869 | |

3 I, Saloon

| | | | | | | | | | | | |
|--------------------|-----|---------------|-------|---|---|---|----|--------------|--|-------|------------|
| 1.4 | 62 | 10/03 → 06/09 | 1.349 | B | M | 4 | 16 | ZJ-VE | | 84060 | NEW |
| | 59 | 02/04 → 06/09 | 1.388 | B | M | 4 | 16 | FXJA | | 84060 | NEW |
| 1.6 | 77 | 10/03 → 06/09 | 1.598 | B | M | 4 | 16 | B6ZE | | 84060 | NEW |
| | 77 | 02/04 → 06/09 | 1.598 | B | M | 4 | 16 | Z6 | | 84060 | NEW |
| 1.6 DI Turbo | 80 | 06/04 → 06/09 | 1.560 | D | M | 4 | 16 | Y601 | | 81869 | |
| 1.6 MZ-CD | 66 | 06/06 → 12/09 | 1.560 | D | M | 4 | 16 | Y406 | | 81869 | |
| 2.0 | 110 | 10/03 → 06/09 | 1.999 | B | M | 4 | 16 | LF17 | | 81804 | |
| 2.0 MZR-CD | 105 | 12/06 → 06/09 | 1.998 | D | M | 4 | 16 | RF7J | | 82092 | |
| 2.3 | 118 | 03/04 → 03/09 | 2.261 | B | M | 4 | 16 | L3-VE | | 81804 | |
| | 126 | 06/00 → 03/03 | 2.261 | B | M | 4 | 16 | L3-VE | | 81804 | |
| 2.3 DiSi Turbo MPS | 184 | 06/06 → 06/09 | 2.261 | B | M | 4 | 16 | L3YH | | 81804 | |
| 2.3 MPS Turbo | 191 | 12/06 → 06/09 | 2.261 | B | M | 4 | 16 | L3-VDT, L3N9 | | 81804 | |
| 2.3 MZR | 115 | 03/04 → 03/09 | 2.261 | B | M | 4 | 16 | L3-VE | | 81804 | |
| 2.3 MZR Sport | 126 | 10/03 → 06/09 | 2.261 | B | M | 4 | 16 | L3YS, L3YT | | 81804 | |

3 II, Saloon

| | | | | | | | | | | | |
|---------------|-----|---------|-------|---|---|---|----|--------------|--|-------|------------|
| 1.6 MZR | 77 | 06/09 → | 1.598 | B | M | 4 | 16 | Z6 | | 84060 | NEW |
| 1.6 MZR CD | 80 | 12/08 → | 1.560 | D | M | 4 | 16 | Y601, Y642 | | 81869 | |
| | 80 | 12/08 → | 1.560 | D | M | 4 | 16 | Y642 | | 81869 | |
| | 85 | 11/10 → | 1.560 | D | M | 4 | 8 | Y650, Y655 | | 81869 | |
| 2.0 MZR | 110 | 06/09 → | 1.999 | B | M | 4 | 16 | LF-DE, LF17 | | 81804 | |
| 2.0 MZR DISI | 111 | 06/09 → | 1.999 | B | M | 4 | 16 | LF5H, LF5W | | 81804 | |
| 2.3 MPS Turbo | 191 | 06/09 → | 2.261 | B | M | 4 | 16 | L3-VDT, L3KG | | 81804 | |

3 III, Saloon

| | | | | | | | | | | | |
|-----|----|---------|-------|---|---|---|----|------------|--|-------|------------|
| 1.6 | 77 | 09/13 → | 1.598 | B | M | 4 | 16 | Z6Y1 | | 84060 | NEW |
| | 77 | 09/13 → | 1.598 | B | M | 4 | 16 | Z6Y1, Z6Y3 | | 84060 | NEW |

5 I

| | | | | | | | | | | | |
|--------|-----|---------|-------|---|---|---|----|------|--|-------|--|
| 1.8 | 85 | 03/05 → | 1.798 | B | M | 4 | 16 | L823 | | 81804 | |
| 2.0 | 107 | 03/05 → | 1.999 | B | M | 4 | 16 | LFF7 | | 81804 | |
| 2.0 CD | 81 | 03/05 → | 1.998 | D | M | 4 | 16 | RF7J | | 82092 | |
| | 105 | 06/05 → | 1.998 | D | M | 4 | 16 | RF7J | | 82092 | |
| 2.3 | 122 | 02/05 → | 2.261 | B | M | 4 | 16 | | | 81804 | |

5 II

| | | | | | | | | | | | |
|---------|-----|---------|-------|---|---|---|----|------------|--|-------|--|
| 1.6 CD | 85 | 09/10 → | 1.560 | D | M | 4 | 8 | Y650, Y655 | | 81869 | |
| 1.8 MZR | 85 | 09/10 → | 1.798 | B | M | 4 | 16 | L850 | | 81804 | |
| 2.0 | 106 | 01/11 → | 1.999 | B | M | 4 | 16 | LFZB | | 81804 | |
| | 110 | 09/10 → | 1.999 | B | M | 4 | 16 | LF5H | | 81804 | |

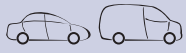
KW

cm³

NO. OF VALVES

MAZDA
6 I, Hatchback, Station Wagon

| | | | | | | | | | | |
|---------------|-----|---------------|-------|---|---|---|----|------------------|--|-------|
| 1.8 | 88 | 08/02 → 08/07 | 1.798 | B | M | 4 | 16 | L813 | | 81804 |
| | 88 | 08/02 → 08/07 | 1.798 | B | M | 4 | 16 | L813, L823, L828 | | 81804 |
| 2.0 | 104 | 06/02 → 08/07 | 1.999 | B | M | 4 | 16 | LF17, LF18 | | 81804 |
| | 108 | 03/05 → 08/07 | 1.999 | B | M | 4 | 16 | LFF7 | | 81804 |
| 2.0 CiTD 4x4 | 89 | 10/02 → 02/05 | 1.998 | D | M | 4 | 16 | RF5C | | 82092 |
| | 100 | 10/02 → 02/05 | 1.998 | D | M | 4 | 16 | RF5C | | 82092 |
| 2.0 DI | 89 | 08/02 → 08/07 | 1.998 | D | M | 4 | 16 | RF5C | | 82092 |
| | 100 | 06/02 → 08/07 | 1.998 | D | M | 4 | 16 | RF5C | | 82092 |
| | 105 | 06/05 → 08/07 | 1.998 | D | M | 4 | 16 | RF7J | | 82092 |
| 2.3 | 122 | 06/02 → 08/07 | 2.261 | B | M | 4 | 16 | L3C1 | | 81804 |
| 2.3 AWD | 119 | 11/02 → 08/07 | 2.261 | B | M | 4 | 16 | L3C1 | | 81804 |
| 2.3 MPS Turbo | 191 | 12/05 → 08/07 | 2.261 | B | M | 4 | 16 | L3KG | | 81804 |
| 2.5 | 125 | 08/07 → | 2.488 | B | M | 4 | 16 | L5-VE | | 81804 |

6 II, Hatchback, Station Wagon

| | | | | | | | | | | |
|------------|-----|---------|-------|---|---|---|----|-------|--|-------|
| 1.8 MZR | 88 | 08/07 → | 1.798 | B | M | 4 | 16 | L813 | | 81804 |
| 2.0 MZR | 108 | 08/07 → | 1.999 | B | M | 4 | 16 | LF17 | | 81804 |
| | 114 | 01/10 → | 1.999 | B | M | 4 | 16 | LF-DE | | 81804 |
| 2.0 MZR-CD | 103 | 08/07 → | 1.998 | D | M | 4 | 16 | RF7J | | 82092 |
| 2.5 MZR | 125 | 08/07 → | 2.488 | B | M | 4 | 16 | L5-VE | | 81804 |

121

| | | | | | | | | | | |
|-----------|----|---------------|-------|---|---|---|----|----------|--|-------|
| 1.25 | 55 | 03/96 → 04/03 | 1.242 | B | M | 4 | 16 | DHF, DHG | | 81598 |
| 1.3 | 37 | 03/96 → 04/03 | 1.299 | B | M | 4 | 8 | JJK, JJM | | 81716 |
| | 44 | 03/96 → 04/03 | 1.299 | B | M | 4 | 8 | J4R, J4T | | 81716 |
| 1.3 i 16V | 53 | 11/90 → 03/96 | 1.324 | B | M | 4 | 16 | B3 (16V) | | 81598 |
| 1.8 D | 44 | 03/96 → 04/03 | 1.753 | D | M | 4 | 8 | RTJ, RTK | | 81651 |

323 F VI

| | | | | | | | | | | |
|--------|----|---------------|-------|---|---|---|----|------|--|-------|
| 2.0 TD | 66 | 09/98 → 12/01 | 1.998 | D | M | 4 | 8 | | | 82092 |
| | 74 | 01/01 → 05/04 | 1.998 | D | M | 4 | 16 | RF4F | | 82092 |

323 S VI

| | | | | | | | | | | |
|----------|----|---------------|-------|---|---|---|----|------|--|-------|
| 2.0 DiTD | 74 | 10/00 → 10/02 | 1.998 | D | M | 4 | 16 | RF4F | | 82092 |
| 2.0 TD | 66 | 09/98 → 05/04 | 1.998 | D | M | 4 | 16 | RF3F | | 82092 |

626 V, Hatchback, Station Wagon

| | | | | | | | | | | |
|--------------|----|---------------|-------|---|---|---|----|------|--|-------|
| 2.0 DI TD | 66 | 04/98 → 10/02 | 1.998 | D | M | 4 | 16 | RF3F | | 82092 |
| | 66 | 04/98 → 10/02 | 1.998 | D | M | 4 | 16 | RF3F | | 82092 |
| 2.0 TD | 81 | 10/00 → 10/02 | 1.998 | D | M | 4 | 8 | RF59 | | 82092 |
| | 81 | 10/00 → 10/02 | 1.998 | D | M | 4 | 8 | | | 82092 |
| 2.0 Turbo DI | 74 | 04/98 → 10/02 | 1.998 | D | M | 4 | 16 | RF4F | | 82092 |
| | 74 | 04/98 → 10/02 | 1.998 | D | M | 4 | 8 | | | 82092 |

CX - 7

| | | | | | | | | | | |
|--------------------|-----|---------|-------|---|---|---|----|--------|--|-------|
| 2.3 MZR DISI Turbo | 190 | 10/07 → | 2.261 | B | M | 4 | 16 | L3-VDT | | 81804 |
| | 191 | 09/09 → | 2.261 | B | M | 4 | 16 | L3-VDT | | 81804 |

MPV

| | | | | | | | | | | |
|--------|-----|---------------|-------|---|---|---|----|------|--|-------|
| 2.0 DI | 100 | 07/02 → 02/06 | 1.998 | D | M | 4 | 16 | RF5C | | 82092 |
| 2.3 | 104 | 07/02 → 02/06 | 2.261 | B | M | 4 | 16 | L3 | | 81804 |

KW

cm³

NO. OF VALVES

MAZDA

MX - 5 III

| | | | | | | | | | | |
|-----|-----|---------|-------|---|---|---|----|-------------|--|-------|
| 1.8 | 93 | 03/05 → | 1.798 | B | M | 4 | 16 | L8-DE, L828 | | 81804 |
| 2.0 | 118 | 09/08 → | 1.999 | B | M | 4 | 16 | LF-DE, LF62 | | 81804 |

Premacy

| | | | | | | | | | | |
|---------|-----|---------------|-------|---|---|---|----|------|--|-------|
| 2.0 TD | 66 | 10/99 → 07/00 | 1.998 | D | M | 4 | 16 | RF3F | | 82092 |
| | 74 | 07/00 → 03/05 | 1.998 | D | M | 4 | 16 | RF4F | | 82092 |
| 2.3 SVT | 122 | 02/05 → 03/05 | 2.261 | B | M | 4 | 16 | L333 | | 81804 |

Tribute

| | | | | | | | | | | |
|---------|-----|---------------|-------|---|---|---|----|-------|--|-------|
| 2.0 | 91 | 03/00 → 05/08 | 1.989 | B | M | 4 | 16 | YF | | 81803 |
| 2.0 4WD | 91 | 03/00 → 05/08 | 1.989 | B | M | 4 | 16 | YF | | 81803 |
| 2.3 AWD | 110 | 04/04 → 05/08 | 2.261 | B | M | 4 | 16 | L3-VE | | 81804 |
| 2.3 GX | 110 | 12/03 → 10/04 | 2.261 | B | M | 4 | 16 | L3-VE | | 81804 |

MEGA

Club I

| | | | | | | | | | | |
|-----------|----|---------------|-------|---|---|---|---|-------|--|-------|
| 1.1 i | 44 | 01/92 → 06/99 | 1.124 | B | M | 4 | 8 | TU1MC | | 81556 |
| 1.4 i | 55 | 01/92 → 06/99 | 1.361 | B | M | 4 | 8 | | | 81513 |
| 1.4 i 4x4 | 55 | 01/92 → 06/99 | 1.361 | B | M | 4 | 8 | | | 81513 |
| 1.5 D | 43 | 01/94 → 06/99 | 1.527 | B | M | 4 | 8 | | | 81513 |
| 1.5 D 4x4 | 43 | 01/94 → 06/99 | 1.527 | B | M | 4 | 8 | | | 81513 |

Club II

| | | | | | | | | | | |
|-------|----|---------|-------|---|---|---|---|--|--|-------|
| 1.4 i | 55 | 06/99 → | 1.361 | B | M | 4 | 8 | | | 81513 |
|-------|----|---------|-------|---|---|---|---|--|--|-------|

MERCEDES-BENZ

100

| | | | | | | | | | | |
|---|----|---------------|-------|---|---|---|---|------------------|--|-------|
| D | 41 | 12/90 → 12/94 | 2.399 | D | M | 4 | 8 | OM616 | | 81508 |
| | 53 | 02/88 → 05/92 | 2.399 | D | M | 4 | 8 | OM616.963 | | 81508 |
| | 55 | 12/90 → 02/96 | 2.399 | D | M | 4 | 8 | OM616, OM616.963 | | 81723 |
| | 55 | 12/90 → 02/96 | 2.399 | D | M | 4 | 8 | OM616.963 | | 81508 |

190 (W201)

| | | | | | | | | | | |
|----------|-----|---------------|-------|---|---|---|----|--------------------|-------------------------|-------|
| 2.0 | 75 | 01/86 → 05/90 | 1.996 | B | M | 4 | 8 | M102.924 | | 81509 |
| | 77 | 09/84 → 05/90 | 1.996 | B | M | 4 | 8 | M102.924 | | 81509 |
| D 2.0 | 55 | 08/89 → 08/93 | 1.997 | D | M | 4 | 8 | OM601.911 | | 81504 |
| D 2.5 | 66 | 04/85 → 08/93 | 2.497 | D | M | 5 | 10 | OM602.911 | | 81506 |
| | 69 | 08/89 → 08/93 | 2.497 | D | M | 5 | 10 | OM602.911 | | 81506 |
| E 1.8 | 80 | 04/90 → 08/93 | 1.797 | B | M | 4 | 8 | M102.910 | | 81509 |
| E 2.0 | 87 | 01/85 → 08/93 | 1.996 | B | M | 4 | 8 | M102.962 | | 81509 |
| | 93 | 10/82 → 06/93 | 1.996 | B | M | 4 | 8 | M102.961 | | 81509 |
| | 90 | 10/82 → 06/93 | 1.996 | B | M | 4 | 8 | M102.961, M102.962 | | 81509 |
| E 2.3 | 97 | 09/86 → 08/91 | 2.298 | B | M | 4 | 8 | M102.985 | | 81509 |
| | 100 | 10/86 → 08/93 | 2.298 | B | M | 4 | 8 | M102.985 | | 81509 |
| E 2.5-16 | 143 | 03/89 → 08/93 | 2.498 | B | M | 4 | 16 | M102.991 | | 81509 |
| | 150 | 09/88 → 08/93 | 2.498 | B | M | 4 | 16 | M102.990 | 05-1991 →, → 05-1993 | 81509 |
| E 2.6 | 118 | 09/86 → 08/93 | 2.597 | B | M | 6 | 12 | M103.942 | | 81507 |

KW

cm³

NO. OF VALVES

MERCEDES-BENZ
190 (W201)

| | | | | | | | | | | |
|--------------------|-----|---------------|-------|---|---|---|----|-----------|-------------------------|-------|
| E Evolution II 2.5 | 173 | 05/90 → 08/93 | 2.498 | B | M | 4 | 8 | M102.992 | 05-1991 →, → 05-1993 | 81509 |
| Turbo-D 2.5 | 90 | 02/88 → 08/93 | 2.497 | D | M | 5 | 10 | OM602.961 | 01-1985 →, → 05-1993 | 81506 |
| | 93 | 02/88 → 08/93 | 2.497 | D | M | 5 | 10 | OM602.961 | 01-1985 →, → 05-1993 | 81506 |

Citan

| | | | | | | | | | | |
|---------|----|---------|-------|---|---|---|---|-----------|--|-------|
| 108 CDI | 55 | 11/12 → | 1.461 | D | M | 4 | 8 | OM607.951 | | 82098 |
| 109 CDI | 66 | 11/12 → | 1.461 | D | M | 4 | 8 | OM607.951 | | 82098 |
| | 66 | 11/12 → | 1.461 | D | M | 4 | 8 | OM607.951 | | 82098 |

CLA

| | | | | | | | | | | |
|-----------------|----|---------|-------|---|---|---|---|-----------|--|-------|
| CLA 180 CDI / d | 80 | 10/13 → | 1.461 | D | M | 4 | 8 | OM607.951 | | 82098 |
| CLA 180 d | 80 | 07/15 → | 1.461 | D | M | 4 | 8 | OM607.951 | | 82098 |

Classe A I (W168)

| | | | | | | | | | | |
|-----------|-----|---------------|-------|---|---|---|----|-----------|--|-------|
| A 140 | 60 | 07/97 → 08/04 | 1.397 | B | M | 4 | 8 | M166.940 | | 82087 |
| | 60 | 01/01 → 08/04 | 1.598 | B | A | 4 | 8 | M166.960 | | 82087 |
| A 160 | 75 | 07/97 → 08/04 | 1.598 | B | M | 4 | 8 | M166.960 | | 82087 |
| A 160 CDI | 44 | 07/98 → 02/01 | 1.689 | D | M | 4 | 16 | OM668.941 | | 82087 |
| | 55 | 02/01 → 08/04 | 1.689 | D | M | 4 | 16 | OM668.940 | | 82087 |
| A 170 CDI | 66 | 07/98 → 02/01 | 1.689 | D | M | 4 | 16 | OM668.940 | | 82087 |
| | 70 | 02/01 → 08/04 | 1.689 | D | M | 4 | 16 | OM668.942 | | 82087 |
| A 190 | 92 | 03/99 → 08/04 | 1.898 | B | M | 4 | 8 | M166.990 | | 82087 |
| A 210 | 103 | 03/02 → 08/04 | 2.084 | B | M | 4 | 8 | M166.995 | | 82087 |

Classe A II (W169)

| | | | | | | | | | | |
|-------------|-----|---------------|-------|---|---|---|----|-----------|--|-------|
| A 150 | 70 | 09/04 → 06/12 | 1.498 | B | M | 4 | 8 | M266.920 | | 82017 |
| A 160 | 70 | 04/09 → 06/12 | 1.498 | B | M | 4 | 8 | M266.920 | | 82017 |
| A 160 CDI | 60 | 09/04 → 06/12 | 1.991 | D | M | 4 | 16 | OM640.942 | | 82017 |
| A 170 | 85 | 09/04 → 06/12 | 1.699 | B | M | 4 | 8 | M266.940 | | 82017 |
| A 180 | 85 | 04/09 → 06/12 | 1.699 | B | M | 4 | 8 | M266.940 | | 82017 |
| A 180 CDI | 80 | 09/04 → 06/12 | 1.991 | D | M | 4 | 16 | OM640.940 | | 82017 |
| A 200 | 100 | 09/04 → 06/12 | 2.034 | B | M | 4 | 8 | M266.960 | | 82017 |
| A 200 CDI | 100 | 09/04 → 06/12 | 1.991 | D | M | 4 | 16 | OM640.941 | | 82017 |
| | 103 | 09/04 → 06/12 | 1.991 | D | M | 4 | 16 | OM640.941 | | 82017 |
| A 200 TURBO | 142 | 09/05 → 06/12 | 2.034 | B | M | 4 | 8 | M266.980 | | 82017 |

Classe A III (W176)

| | | | | | | | | | | |
|---------------|----|---------|-------|---|---|---|---|-----------|--|-------|
| A 160 CDI / d | 66 | 06/13 → | 1.461 | D | M | 4 | 8 | OM607.951 | | 82098 |
| A 180 CDI / d | 80 | 06/12 → | 1.461 | D | M | 4 | 8 | OM607.951 | | 82098 |

Classe B I (W245)

| | | | | | | | | | | |
|-----------|----|---------------|-------|---|---|---|----|-----------|--|-------|
| B 150 | 70 | 03/05 → 11/11 | 1.498 | B | M | 4 | 8 | M266.920 | | 82017 |
| B 160 | 70 | 04/09 → 11/11 | 1.498 | B | M | 4 | 8 | M266.920 | | 82017 |
| B 170 | 85 | 03/05 → 11/11 | 1.699 | B | M | 4 | 8 | M266.940 | | 82017 |
| B 170 NGT | 85 | 04/08 → 11/11 | 2.034 | | M | 4 | 8 | M266.960 | | 82017 |
| B 180 | 85 | 04/09 → 11/11 | 1.699 | B | M | 4 | 8 | M266.940 | | 82017 |
| B 180 CDI | 80 | 03/05 → 11/11 | 1.991 | D | M | 4 | 16 | OM640.940 | | 82017 |

| | | | | | | | | | |
|--|--|--|--|--|--|--|--|--|--|
| | | | | | | | | | |
|--|--|--|--|--|--|--|--|--|--|

MERCEDES-BENZ

Classe B I (W245)

| | | | | | | | | | | |
|-------------|-----|---------------|-------|---|---|---|----|-----------|--|-------|
| B 180 NGT | 85 | 04/08 → 11/11 | 2.034 | | M | 4 | 8 | M266.960 | | 82017 |
| B 200 | 100 | 03/05 → 11/11 | 2.034 | B | M | 4 | 8 | M266.960 | | 82017 |
| B 200 CDI | 100 | 03/05 → 11/11 | 1.991 | D | M | 4 | 16 | OM640.941 | | 82017 |
| | 103 | 03/05 → 11/11 | 1.991 | D | M | 4 | 16 | OM640.941 | | 82017 |
| B 200 TURBO | 142 | 03/05 → 11/11 | 2.034 | B | M | 4 | 8 | M266.980 | | 82017 |

Classe B II (W246)

| | | | | | | | | | | |
|---------------|----|---------|-------|---|---|---|---|-----------|--|-------|
| B 160 CDI / d | 66 | 05/13 → | 1.461 | D | M | 4 | 8 | OM607.951 | | 82098 |
| B 180 CDI / d | 80 | 02/13 → | 1.461 | D | M | 4 | 8 | OM607.951 | | 82098 |

Classe C I (W202), Station Wagon (S202)

| | | | | | | | | | | |
|--------------------|-----|---------------|-------|---|---|---|----|--------------------|-----------|-------|
| C 180 | 89 | 11/94 → 05/00 | 1.799 | B | M | 4 | 16 | M111.921 | | 81499 |
| | 90 | 03/93 → 05/00 | 1.799 | B | M | 4 | 16 | M111.920, M111.921 | | 81499 |
| C 180 T | 90 | 06/96 → 09/00 | 1.799 | B | M | 4 | 16 | M111.920, M111.921 | | 81499 |
| | 95 | 09/00 → 03/01 | 1.998 | B | M | 4 | 16 | M111.952 | | 81499 |
| C 200 | 100 | 01/94 → 05/00 | 1.998 | B | M | 4 | 16 | M111.941, M111.945 | | 81499 |
| C 200 CDI | 75 | 03/98 → 05/00 | 2.151 | D | M | 4 | 16 | OM611.960 | | 81499 |
| C 200 D | 55 | 03/93 → 05/00 | 1.997 | D | M | 4 | 8 | OM601.913 | | 81722 |
| | 65 | 10/96 → 05/00 | 1.997 | D | M | 4 | 16 | OM604.915 | 06-1993 → | 81504 |
| C 200 Kompressor | 132 | 10/95 → 05/00 | 1.998 | B | M | 4 | 16 | M111.944 | | 81499 |
| | 141 | 11/96 → 05/00 | 1.998 | B | M | 4 | 16 | M111.944 | | 81499 |
| C 200 T | 100 | 06/96 → 03/01 | 1.998 | B | M | 4 | 16 | M111.941, M111.945 | | 81499 |
| C 200 T CDI | 75 | 03/98 → 03/01 | 2.151 | D | M | 4 | 16 | OM611.960 | | 82088 |
| C 200 T D | 65 | 10/96 → 03/01 | 1.997 | D | M | 4 | 16 | OM604.915 | | 81723 |
| C 200 T Kompressor | 120 | 09/00 → 03/01 | 1.998 | B | M | 4 | 16 | M111.956 | | 81499 |
| | 141 | 11/96 → 03/01 | 1.998 | B | M | 4 | 16 | M111.944 | | 81499 |
| C 220 | 110 | 03/93 → 05/00 | 2.199 | B | M | 4 | 16 | M111.961 | | 81499 |
| C 220 CDI | 92 | 09/97 → 05/00 | 2.151 | D | M | 4 | 16 | OM611.960 | | 82088 |
| C 220 D | 55 | 07/96 → 05/00 | 2.155 | D | M | 4 | 16 | OM604.910 | | 81723 |
| | 70 | 08/93 → 05/00 | 2.155 | D | M | 4 | 16 | OM604.910 | | 81723 |
| C 220 T CDI | 92 | 09/97 → 03/01 | 2.151 | D | M | 4 | 16 | OM611.960 | | 82088 |
| C 220 T D | 55 | 06/96 → 03/01 | 2.155 | D | M | 4 | 16 | OM604.910 | | 82088 |
| | 70 | 06/96 → 09/98 | 2.155 | D | M | 4 | 16 | OM604.910 | | 81499 |
| C 230 | 110 | 06/96 → 06/97 | 2.295 | B | M | 4 | 16 | M111.974 | | 81499 |
| C 230 Kompressor | 142 | 10/95 → 05/00 | 2.295 | B | M | 4 | 16 | M111.975 | | 81725 |
| C 230 T | 110 | 06/96 → 06/98 | 2.295 | B | M | 4 | 16 | M111.974 | | 81499 |
| C 230 T Kompressor | 142 | 06/97 → 09/00 | 2.295 | B | M | 4 | 16 | M111.975 | | 81725 |
| C 240 | 125 | 06/97 → 05/00 | 2.398 | B | M | 6 | 18 | M112.910 | | 81730 |
| C 240 T | 125 | 06/97 → 09/00 | 2.398 | B | M | 6 | 18 | M112.910 | | 81730 |
| | 125 | 09/00 → 03/01 | 2.597 | B | M | 6 | 18 | M112.915 | | 81730 |
| C 250 D | 83 | 05/93 → 05/00 | 2.497 | D | M | 5 | 20 | OM605.910 | | 81506 |
| C 250 T Turbo-D | 110 | 06/96 → 03/01 | 2.497 | D | M | 5 | 20 | OM605.960 | | 82088 |
| C 250 Turbo-D | 110 | 10/95 → 05/00 | 2.497 | D | M | 5 | 20 | OM605.960 | 01-1997 → | 81726 |
| C 280 | 142 | 05/93 → 05/00 | 2.799 | B | M | 6 | 24 | M104.941 | | 81722 |
| | 145 | 06/97 → 05/00 | 2.799 | B | M | 6 | 18 | M112.920 | | 81722 |
| C 280 T | 145 | 06/97 → 03/01 | 2.799 | B | M | 6 | 18 | M112.920 | | 81722 |

KW

cm³

NO. OF VALVES

MERCEDES-BENZ
Classe C I (W202), Station Wagon (S202)

| | | | | | | | | | | |
|----------|-----|---------------|-------|---|---|---|----|-------------------|-----------|-------|
| C 36 AMG | 206 | 05/94 → 05/00 | 3.606 | B | M | 6 | 24 | M104.941 (AMG3.6) | | 81722 |
| C 43 AMG | 225 | 08/97 → 05/00 | 4.266 | B | M | 8 | 24 | M113.944 | 01-1998 → | 81730 |

Classe C II (W203), Station Wagon (S203), Coupé (CL203)

| | | | | | | | | | | |
|----------------------|-----|---------------|-------|---|----|---|----|----------------------|--|-------|
| C 160 Kompressor | 90 | 05/02 → 05/08 | 1.796 | B | M | 4 | 16 | M271.921 | | 84004 |
| C 180 Kompressor | 105 | 05/02 → 02/07 | 1.796 | B | M | 4 | 16 | M271.946 | | 84004 |
| C 200 CDI | 75 | 02/01 → 02/07 | 2.148 | D | M | 4 | 16 | OM646.962 | | 82088 |
| | 75 | 03/01 → 08/07 | 2.148 | D | M | 4 | 16 | OM611.962, OM646.962 | | 82082 |
| | 85 | 03/01 → 08/07 | 2.148 | D | AM | 4 | 16 | OM611.962 | | 82088 |
| | 85 | 09/00 → 02/07 | 2.148 | D | M | 4 | 16 | OM611.962 | | 82088 |
| | 90 | 04/03 → 02/07 | 2.148 | D | M | 4 | 16 | OM646.962 | | 82088 |
| C 200 CGI Kompressor | 125 | 07/03 → 02/07 | 1.796 | B | M | 4 | 16 | M271.942 | | 84004 |
| C 220 | 120 | 05/02 → 05/08 | 1.796 | B | M | 4 | 16 | M271.940 | | 84004 |
| C 220 CDI | 100 | 03/01 → 01/04 | 2.148 | D | M | 4 | 16 | OM611.962 | | 82088 |
| | 100 | 05/00 → 02/07 | 2.148 | D | M | 4 | 16 | OM611.962 | | 82088 |
| | 105 | 03/01 → 08/07 | 2.148 | D | AM | 4 | 16 | OM611.962 | | 82088 |
| | 105 | 05/00 → 02/07 | 2.148 | D | M | 4 | 16 | OM611.962 | | 82088 |
| | 110 | 02/03 → 02/07 | 2.148 | D | M | 4 | 16 | OM646.963 | | 82088 |
| | 100 | 08/06 → 08/07 | 2.149 | D | M | 4 | 16 | OM646.963 | | 82088 |
| C 230 Kompressor | 141 | 02/04 → 02/07 | 1.796 | B | M | 4 | 16 | M271.948 | | 84004 |
| C 240 | 125 | 05/00 → 02/07 | 2.597 | B | M | 6 | 18 | M112.912 | | 81730 |
| C 240 4-matic | 125 | 07/02 → 02/07 | 2.597 | B | M | 6 | 18 | M112.916 | | 81730 |
| C 270 CDI | 120 | 12/00 → 02/07 | 2.685 | D | M | 5 | 20 | OM612.962 | | 82088 |
| | 125 | 03/01 → 08/07 | 2.685 | D | AM | 5 | 20 | OM612.962 | | 82088 |
| | 125 | 12/00 → 02/07 | 2.685 | D | M | 5 | 20 | OM612.962 | | 82088 |
| C 320 | 160 | 09/02 → 05/08 | 3.199 | B | M | 6 | 18 | M112.946 | | 81730 |
| | 160 | 05/00 → 02/07 | 3.199 | B | A | 6 | 18 | M112.946 | | 81730 |
| C 320 4-matic | 160 | 07/02 → 02/07 | 3.199 | B | M | 6 | 18 | M112.953 | | 81730 |
| C 320 CDI | 165 | 01/05 → 02/07 | 2.987 | D | M | 6 | 24 | OM642.910 | | 82058 |
| C 55 AMG | 270 | 02/04 → 02/07 | 5.439 | B | M | 8 | 24 | M113.988 | | 81730 |

Classe C III (W204), Station Wagon (S204), Coupé (C204)

| | | | | | | | | | | |
|------------------|-----|---------------|-------|---|---|---|----|----------------------|--|------------------|
| C 180 | 115 | 06/11 → | 1.796 | B | M | 4 | 16 | M271.820 | | 84004 |
| C 180 CDI | 88 | 01/11 → 01/14 | 2.143 | D | M | 4 | 16 | OM651.913 | | 84044 NEW |
| C 180 CGI | 115 | 01/07 → 01/14 | 1.796 | B | M | 4 | 16 | M271.820 | | 84004 |
| C 180 Kompressor | 115 | 01/08 → 01/14 | 1.597 | B | M | 4 | 16 | M271.910 | | 84004 |
| | 115 | 01/07 → 01/14 | 1.796 | B | M | 4 | 16 | M271.952 | | 84004 |
| C 200 | 137 | 05/11 → 01/14 | 1.796 | B | M | 4 | 16 | M271.820 | | 84004 |
| C 200 CDI | 100 | 01/11 → 01/14 | 2.143 | D | M | 4 | 16 | OM651.913 | | 84044 NEW |
| | 100 | 08/07 → 12/11 | 2.148 | D | M | 4 | 16 | OM646.811 | | 82082 |
| | 100 | 01/07 → 12/10 | 2.148 | D | M | 4 | 16 | OM646.811, OM646.812 | | 82082 |
| C 200 CGI | 135 | 01/07 → 01/14 | 1.796 | B | M | 4 | 16 | M271.820 | | 84004 |
| | 135 | 08/07 → 08/14 | 1.796 | B | M | 4 | 16 | M271.820, M271.860 | | 84004 |
| C 200 Kompressor | 135 | 01/07 → 01/14 | 1.796 | B | M | 4 | 16 | M271.950 | | 84004 |

KW

cm³

NO. OF VALVES

MERCEDES-BENZ
Classe C III (W204), Station Wagon (S204), Coupé (C204)

| | | | | | | | | | | | |
|-------------------|-----|---------------|-------|---|---|---|----|-----------|--|-------|------------|
| C 220 CDI | 120 | 10/08 → 01/14 | 2.143 | D | M | 4 | 16 | OM651.911 | | 84044 | NEW |
| | 120 | 01/07 → 11/08 | 2.148 | D | M | 4 | 16 | OM646.811 | | 82082 | |
| | 120 | 06/11 → | 2.143 | D | M | 4 | 16 | OM651.911 | | 84044 | NEW |
| | 125 | 12/08 → 01/14 | 2.143 | D | M | 4 | 16 | OM651.911 | | 84044 | NEW |
| | 125 | 01/07 → 11/08 | 2.148 | D | M | 4 | 16 | OM646.811 | | 82082 | |
| C 220 CDI 4-matic | 125 | 02/13 → 01/14 | 2.143 | D | M | 4 | 16 | OM651.912 | | 84044 | NEW |
| C 250 | 150 | 06/11 → | 1.796 | B | M | 4 | 16 | M271.860 | | 84004 | |
| C 250 CDI | 150 | 08/08 → 01/14 | 2.143 | D | M | 4 | 16 | OM651.911 | | 84044 | NEW |
| C 250 CDI 4-matic | 150 | 01/11 → 01/14 | 2.143 | D | M | 4 | 16 | OM651.912 | | 84044 | NEW |
| C 250 CGI | 150 | 07/09 → 01/14 | 1.796 | B | M | 4 | 16 | M271.860 | | 84004 | |
| C 300 CDI 4-matic | 170 | 01/11 → 01/14 | 2.987 | D | M | 6 | 24 | OM642.832 | | 82058 | |
| C 320 CDI | 165 | 01/07 → 01/14 | 2.987 | D | M | 6 | 24 | OM642.960 | | 82058 | |
| C 320 CDI 4-matic | 165 | 07/07 → 01/14 | 2.987 | D | M | 6 | 24 | OM642.961 | | 82058 | |
| C 350 CDI | 165 | 08/07 → 08/14 | 2.987 | D | M | 6 | 24 | OM642.830 | | 82058 | |
| | 165 | 07/09 → 01/14 | 2.987 | D | M | 6 | 24 | OM642.960 | | 82058 | |
| | 170 | 10/09 → 01/14 | 2.987 | D | M | 6 | 24 | OM642.830 | | 82058 | |
| C 350 CDI 4-matic | 165 | 07/09 → 01/14 | 2.987 | D | M | 6 | 24 | OM642.961 | | 82058 | |
| | 170 | 10/09 → 01/14 | 2.987 | D | M | 6 | 24 | OM642.832 | | 82058 | |

Classe C IV (W205), Station Wagon (S205), Coupé (C205)

| | | | | | | | | | | | |
|-------------------|-----|---------|-------|---|---|---|----|-----------|--|-------|------------|
| C 180 BlueTEC / d | 85 | 05/14 → | 1.598 | D | M | 4 | 16 | OM626.951 | | 84034 | NEW |
| C 200 BlueTEC / d | 100 | 05/14 → | 1.598 | D | M | 4 | 16 | OM626.951 | | 84034 | NEW |

Classe CLC

| | | | | | | | | | | | |
|--------------------|-----|---------------|-------|---|---|---|----|-----------|--|-------|--|
| CLC 160 | 95 | 02/09 → 06/11 | 1.597 | B | M | 4 | 16 | M271.911 | | 84004 | |
| CLC 180 Kompressor | 105 | 05/08 → 06/11 | 1.796 | B | M | 4 | 16 | M271.946 | | 84004 | |
| CLC 200 CDI | 90 | 05/08 → 06/11 | 2.148 | D | M | 4 | 16 | OM646.962 | | 82082 | |
| CLC 200 Kompressor | 135 | 05/08 → 06/11 | 1.796 | B | M | 4 | 16 | M271.957 | | 84004 | |
| CLC 220 CDI | 110 | 05/08 → 06/11 | 2.148 | D | M | 4 | 16 | OM646.963 | | 82082 | |

Classe E I (W124), Station Wagon (S124), Cabrio (A124), Coupé (C124)

| | | | | | | | | | | | |
|---------------|-----|---------------|-------|---|---|---|----|-----------|-------------------------|-------|--|
| E 200 | 100 | 06/93 → 03/98 | 1.998 | B | M | 4 | 16 | M111.940 | 06-1993 → | 81499 | |
| | 100 | 06/93 → 06/95 | 1.998 | B | M | 4 | 16 | M111.940 | | 81499 | |
| E 200 D | 55 | 06/93 → 06/95 | 1.997 | D | M | 4 | 8 | OM601.912 | | 81504 | |
| E 200 T | 100 | 06/93 → 06/96 | 1.998 | B | M | 4 | 16 | M111.940 | 06-1993 →, → 01-1996 | 81499 | |
| E 220 | 110 | 06/93 → 03/98 | 2.199 | B | M | 4 | 16 | M111.960 | 06-1993 → | 81499 | |
| | 110 | 06/93 → 06/95 | 2.199 | B | M | 4 | 16 | M111.960 | | 81499 | |
| E 220 T | 110 | 06/93 → 06/96 | 2.199 | B | M | 4 | 16 | M111.960 | | 81499 | |
| E 250 D | 83 | 07/93 → 06/95 | 2.497 | D | M | 5 | 20 | OM605.911 | → M: 033.729 | 81506 | |
| | 83 | 07/93 → 06/95 | 2.497 | D | M | 5 | 20 | OM605.911 | M →: 033.730 | 81726 | |
| E 250 TD | 83 | 06/93 → 06/96 | 2.497 | D | M | 5 | 20 | OM605.911 | 01-1985 → | 81506 | |
| E 250 Turbo-D | 93 | 06/93 → 06/95 | 2.497 | D | M | 5 | 10 | OM602.962 | 01-1988 → | 81506 | |
| E 280 | 142 | 06/93 → 06/95 | 2.799 | B | M | 6 | 24 | M104.942 | 06-1993 →, → 06-1995 | 81722 | |
| | 145 | 06/93 → 06/95 | 2.799 | B | M | 6 | 24 | M104.942 | 06-1993 →, → 06-1995 | 81722 | |

KW

cm³

NO. OF VALVES

MERCEDES-BENZ
Classe E I (W124), Station Wagon (S124), Cabrio (A124), Coupé (C124)

| | | | | | | | | | | |
|-------------------------|-----|---------------|-------|---|---|---|----|--------------------|--|-------|
| E 280 T | 142 | 06/93 → 06/96 | 2.799 | B | M | 6 | 24 | M104.942 | 06-1993 →, → 01-1996 | 81722 |
| | 145 | 06/93 → 06/96 | 2.799 | B | M | 6 | 24 | M104.942 | 06-1993 →, → 01-1996 | 81722 |
| E 300 4-matic | 132 | 06/93 → 06/95 | 2.960 | B | M | 6 | 12 | M103.985 | 01-1985 →, → 12-1996, M →: 094.339 | 81507 |
| E 300 D | 100 | 07/93 → 06/95 | 2.996 | D | M | 6 | 24 | OM606.910 | 06-1993 → | 81506 |
| E 300 T 4-matic | 132 | 06/93 → 06/96 | 2.960 | B | M | 6 | 12 | M103.985 | 06-1993 →, → 01-1996 | 81507 |
| E 300 T Turbo-D | 108 | 06/93 → 06/96 | 2.996 | D | M | 6 | 12 | OM603.960 | 01-1987 → | 81506 |
| E 300 T Turbo-D 4-matic | 108 | 06/93 → 06/96 | 2.996 | D | M | 6 | 12 | OM603.963 | 01-1987 → | 81506 |
| E 300 TD | 100 | 06/93 → 06/96 | 2.996 | D | M | 6 | 24 | OM606.910 | 07-1995 → | 81506 |
| E 300 Turbo-D | 108 | 06/93 → 06/95 | 2.996 | D | M | 6 | 12 | OM603.960 | 06-1993 → | 81506 |
| E 300 Turbo-D 4-matic | 108 | 06/93 → 06/95 | 2.996 | D | M | 6 | 12 | OM603.963 | 06-1993 → | 81506 |
| E 320 | 162 | 06/93 → 06/95 | 3.199 | B | M | 6 | 24 | M104.992 | 06-1993 → | 81722 |
| | 162 | 06/93 → 03/98 | 3.199 | B | M | 6 | 24 | M104.992, M104.995 | 06-1993 → | 81722 |
| E 320 T | 162 | 06/93 → 06/96 | 3.199 | B | M | 6 | 24 | M104.992 | 06-1993 → | 81722 |
| E 36 AMG | 200 | 05/94 → 03/98 | 3.606 | B | M | 6 | 24 | M104.992 (AMG3.6) | | 81722 |

Classe E II (W210), Station Wagon (S210)

| | | | | | | | | | | |
|--------------------|-----|---------------|-------|---|---|---|----|-----------|--|-------|
| E 200 | 100 | 06/95 → 08/00 | 1.998 | B | M | 4 | 16 | M111.942 | | 81499 |
| E 200 CDI | 85 | 07/99 → 03/02 | 2.148 | D | M | 4 | 16 | OM611.961 | | 82088 |
| | 75 | 06/98 → 03/02 | 2.151 | D | M | 4 | 16 | OM611.961 | | 82088 |
| E 200 D | 65 | 01/96 → 03/02 | 1.997 | D | M | 4 | 16 | OM604.917 | | 81723 |
| E 200 Kompressor | 120 | 08/00 → 03/02 | 1.998 | B | M | 4 | 16 | M111.957 | | 81499 |
| | 137 | 06/97 → 03/02 | 1.998 | B | M | 4 | 16 | M111.947 | | 81725 |
| E 200 T | 100 | 06/96 → 08/00 | 1.998 | B | M | 4 | 16 | M111.942 | | 81499 |
| E 200 T Kompressor | 120 | 08/00 → 03/03 | 1.998 | B | M | 4 | 16 | M111.957 | | 81499 |
| | 137 | 06/97 → 03/03 | 1.998 | B | M | 4 | 16 | M111.947 | | 81725 |
| E 220 CDI | 100 | 07/99 → 03/02 | 2.148 | D | M | 4 | 16 | OM611.961 | | 82088 |
| | 105 | 07/99 → 03/02 | 2.148 | D | M | 4 | 16 | OM611.961 | | 82088 |
| | 92 | 06/98 → 07/99 | 2.151 | D | M | 4 | 16 | OM611.961 | | 82088 |
| E 220 D | 55 | 05/96 → 03/02 | 2.155 | D | M | 4 | 16 | OM604.912 | | 81723 |
| | 70 | 06/95 → 07/99 | 2.155 | D | M | 4 | 16 | OM604.912 | | 81723 |
| E 220 T CDI | 100 | 05/99 → 03/03 | 2.148 | D | M | 4 | 16 | OM611.961 | | 82088 |
| | 105 | 07/99 → 03/03 | 2.148 | D | M | 4 | 16 | OM611.961 | | 82088 |
| | 92 | 06/98 → 07/99 | 2.151 | D | M | 4 | 16 | OM611.961 | | 82088 |
| E 230 | 110 | 06/95 → 06/97 | 2.295 | B | M | 4 | 16 | M111.970 | | 81499 |
| E 230 T | 110 | 06/96 → 06/97 | 2.295 | B | M | 4 | 16 | M111.970 | | 81499 |
| E 240 | 125 | 06/97 → 08/00 | 2.398 | B | M | 6 | 18 | M112.911 | | 81730 |
| | 125 | 08/00 → 03/02 | 2.597 | B | M | 6 | 18 | M112.914 | | 81730 |
| E 240 T | 125 | 06/97 → 03/03 | 2.398 | B | M | 6 | 18 | M112.911 | | 81730 |
| | 125 | 08/00 → 03/03 | 2.597 | B | M | 6 | 18 | M112.914 | | 81730 |

KW

cm³

NO. OF VALVES

MERCEDES-BENZ
Classe E II (W210), Station Wagon (S210)

| | | | | | | | | | | |
|-----------------|-----|---------------|-------|---|---|---|----|--------------------|-----------|-------|
| E 250 D | 83 | 06/95 → 07/99 | 2.497 | D | M | 5 | 20 | OM605.912 | 01-1985 → | 81506 |
| E 250 T D | 83 | 06/96 → 07/99 | 2.497 | D | M | 5 | 20 | OM605.912 | 01-1988 → | 81506 |
| E 250 T Turbo-D | 110 | 06/97 → 07/99 | 2.497 | D | M | 5 | 20 | OM605.962 | 01-1988 → | 81506 |
| E 250 Turbo-D | 110 | 06/97 → 07/99 | 2.497 | D | M | 5 | 20 | OM605.962 | 01-1988 → | 81506 |
| E 270 CDI | 120 | 07/99 → 03/02 | 2.685 | D | M | 5 | 20 | OM612.961 | | 82088 |
| | 125 | 07/99 → 03/02 | 2.685 | D | M | 5 | 20 | OM612.961 | | 82088 |
| E 270 T CDI | 120 | 02/00 → 03/03 | 2.685 | D | M | 5 | 20 | OM612.961 | | 82088 |
| | 125 | 07/99 → 03/03 | 2.685 | D | M | 5 | 20 | OM612.961 | | 82088 |
| E 280 | 142 | 01/96 → 06/97 | 2.799 | B | M | 6 | 24 | M104.945 | | 81722 |
| | 150 | 12/96 → 03/02 | 2.799 | B | M | 6 | 18 | M112.921 | | 81722 |
| E 280 4-matic | 150 | 12/96 → 03/02 | 2.799 | B | M | 6 | 18 | M112.921 | | 81722 |
| E 280 T | 150 | 12/96 → 03/03 | 2.799 | B | M | 6 | 18 | M112.921 | | 81722 |
| E 280 T 4-matic | 150 | 12/96 → 03/03 | 2.799 | B | M | 6 | 18 | M112.921 | | 81722 |
| E 290 T Turbo-D | 95 | 06/96 → 07/99 | 2.874 | D | M | 5 | 10 | OM602.982 | | 81506 |
| E 290 Turbo-D | 95 | 03/96 → 07/99 | 2.874 | D | M | 5 | 10 | OM602.982 | | 81506 |
| E 300 D | 100 | 06/95 → 06/97 | 2.996 | D | M | 6 | 24 | OM606.912 | 07-1995 → | 81506 |
| E 300 T Turbo-D | 130 | 12/96 → 07/99 | 2.996 | D | M | 6 | 24 | OM606.962 | 07-1995 → | 81506 |
| E 300 Turbo-D | 130 | 12/96 → 07/99 | 2.996 | D | M | 6 | 24 | OM606.962 | | 81506 |
| E 320 | 162 | 06/95 → 06/97 | 3.199 | B | M | 6 | 24 | M104.992, M104.995 | | 81722 |
| | 165 | 06/97 → 03/02 | 3.199 | B | M | 6 | 18 | M112.941 | | 81722 |
| E 320 4-matic | 165 | 06/97 → 03/02 | 3.199 | B | M | 6 | 18 | M112.941 | | 81722 |
| E 320 CDI | 145 | 07/99 → 03/02 | 3.226 | D | A | 6 | 24 | OM613.961 | | 82084 |
| E 320 T | 165 | 12/96 → 03/03 | 3.199 | B | M | 6 | 18 | M112.941 | | 81722 |
| E 320 T 4-matic | 165 | 12/96 → 03/03 | 3.199 | B | M | 6 | 18 | M112.941 | | 81722 |
| E 320 T CDI | 145 | 07/99 → 03/03 | 3.226 | D | A | 6 | 24 | OM613.961 | | 82084 |
| E 430 | 205 | 06/97 → 03/02 | 4.266 | B | M | 8 | 24 | M113.940 | | 81730 |
| E 430 4-matic | 205 | 05/99 → 03/02 | 4.266 | B | M | 8 | 24 | M113.940 | | 81730 |
| E 430 T | 205 | 06/97 → 03/03 | 4.266 | B | M | 8 | 24 | M113.940 | | 81730 |
| E 430 T 4-matic | 205 | 05/99 → 03/03 | 4.266 | B | M | 8 | 24 | M113.940 | | 81730 |
| E 55 AMG | 260 | 08/97 → 03/02 | 5.439 | B | M | 8 | 24 | M113.980 | | 81730 |
| E 55 T AMG | 260 | 08/97 → 03/03 | 5.439 | B | M | 8 | 24 | M113.980 | 01-1998 → | 81730 |

Classe E III (W211), Station Wagon (S211)

| | | | | | | | | | | |
|--------------------|-----|---------------|-------|---|---|---|----|-----------|--|-------|
| E 200 CDI | 75 | 07/02 → 12/08 | 2.148 | D | M | 4 | 16 | OM646.951 | | 82082 |
| | 90 | 07/02 → 12/08 | 2.148 | D | M | 4 | 16 | OM646.951 | | 82082 |
| | 100 | 04/06 → 12/08 | 2.148 | D | M | 4 | 16 | OM646.820 | | 82082 |
| | 100 | 04/06 → 07/09 | 2.148 | D | M | 4 | 16 | OM646.821 | | 82082 |
| E 200 Kompressor | 120 | 11/02 → 12/08 | 1.796 | B | M | 4 | 16 | M271.941 | | 84004 |
| | 135 | 04/06 → 12/08 | 1.796 | B | M | 4 | 16 | M271.956 | | 84004 |
| E 200 NGT | 120 | 03/04 → 12/08 | 1.796 | | M | 4 | 16 | M271.941 | | 84004 |
| E 200 T Kompressor | 120 | 03/03 → 07/09 | 1.796 | B | M | 4 | 16 | M271.941 | | 84004 |
| E 220 CDI | 120 | 03/03 → 12/08 | 2.149 | D | M | 4 | 16 | OM646.821 | | 82082 |
| | 100 | 03/02 → 12/08 | 2.148 | D | M | 4 | 16 | OM646.961 | | 82082 |
| | 110 | 03/02 → 12/08 | 2.148 | D | M | 4 | 16 | OM646.961 | | 82082 |
| | 125 | 04/06 → 12/08 | 2.148 | D | M | 4 | 16 | OM646.821 | | 82082 |

KW

cm³

NO. OF VALVES

MERCEDES-BENZ
Classe E III (W211), Station Wagon (S211)

| | | | | | | | | | | |
|---------------------|-----|---------------|-------|---|---|---|----|--------------------|--------------|-------|
| E 220 T CDI | 120 | 03/03 → 07/09 | 2.148 | D | M | 4 | 16 | OM646.821 | | 82082 |
| | 110 | 03/03 → 07/09 | 2.148 | D | M | 4 | 16 | OM646.961 | | 82082 |
| | 125 | 04/06 → 07/09 | 2.148 | D | M | 4 | 16 | OM646.821 | | 82082 |
| E 240 | 130 | 03/02 → 12/08 | 2.597 | B | M | 6 | 18 | M112.913, M112.917 | → M: 036.808 | 81730 |
| E 240 4-matic | 130 | 03/03 → 12/08 | 2.597 | B | M | 6 | 18 | M112.917 | | 81730 |
| E 240 T | 130 | 03/03 → 07/09 | 2.597 | B | M | 6 | 18 | M112.913 | | 81730 |
| E 240 T 4-matic | 130 | 07/03 → 07/09 | 2.597 | B | M | 6 | 18 | M112.917 | | 81730 |
| E 270 CDI | 120 | 03/02 → 12/08 | 2.685 | D | M | 5 | 20 | OM647.961 | | 82082 |
| E 270 T CDI | 120 | 03/03 → 07/09 | 2.685 | D | M | 5 | 20 | OM647.961 | | 82082 |
| E 280 CDI | 140 | 03/05 → 12/08 | 2.987 | D | M | 6 | 24 | OM642.920 | | 82058 |
| E 280 CDI 4-matic | 140 | 03/05 → 12/08 | 2.987 | D | M | 6 | 24 | OM642.921 | | 82058 |
| E 280 T CDI | 140 | 03/05 → 07/09 | 2.987 | D | M | 6 | 24 | OM642.920 | | 82058 |
| E 280 T CDI 4-matic | 140 | 03/05 → 07/09 | 2.987 | D | M | 6 | 24 | OM642.921 | | 82058 |
| E 300 BlueTEC | 155 | 09/07 → 12/08 | 2.987 | D | M | 6 | 24 | OM642.920 | | 82058 |
| E 320 | 165 | 03/02 → 12/08 | 3.199 | B | M | 6 | 18 | M112.949 | | 81730 |
| E 320 4-matic | 165 | 03/03 → 12/08 | 3.199 | B | M | 6 | 18 | M112.954 | | 81730 |
| E 320 CDI | 165 | 03/05 → 12/08 | 2.987 | D | M | 6 | 24 | OM642.920 | | 82058 |
| E 320 CDI 4-matic | 165 | 03/05 → 12/08 | 2.987 | D | M | 6 | 24 | OM642.910 | | 82058 |
| E 320 T | 165 | 03/03 → 07/09 | 3.199 | B | M | 6 | 18 | M112.949 | | 81730 |
| E 320 T 4-matic | 165 | 07/03 → 07/09 | 3.199 | B | M | 6 | 18 | M112.954 | | 81730 |
| E 320 T CDI | 165 | 03/05 → 07/09 | 2.987 | D | M | 6 | 24 | OM642.920 | | 82058 |
| E 320 T CDI 4-matic | 165 | 03/05 → 07/09 | 2.987 | D | M | 6 | 24 | OM642.920 | | 82058 |
| E 500 | 225 | 03/02 → 12/08 | 4.966 | B | M | 8 | 24 | M113.967 | | 81730 |
| | 285 | 04/06 → 12/08 | 5.461 | B | M | 8 | 32 | M273.960 | | 81730 |
| E 500 4-matic | 225 | 10/03 → 12/08 | 4.966 | B | M | 8 | 24 | M113.969 | | 81730 |
| | 285 | 04/06 → 12/08 | 5.461 | B | M | 8 | 32 | M273.962 | | 81730 |
| E 500 T | 225 | 10/03 → 07/09 | 4.966 | B | M | 8 | 24 | M113.967 | | 81730 |
| | 285 | 04/06 → 07/09 | 5.461 | B | M | 8 | 32 | M273.960 | | 81730 |
| E 500 T 4-matic | 225 | 10/03 → 07/09 | 4.966 | B | M | 8 | 24 | M113.969 | | 81730 |
| | 285 | 04/06 → 07/09 | 5.461 | B | M | 8 | 32 | M273.962 | | 81730 |

Classe E IV (W212), Station Wagon (S212), Cabrio (A207), Coupé (C207)

| | | | | | | | | | | | |
|-------------------------|-----|---------|-------|---|---|---|----|--------------------|--|-------|------------|
| E 200 CDI / BlueTEC | 100 | 01/09 → | 2.143 | D | M | 4 | 16 | OM651.925 | | 84044 | NEW |
| E 200 CGI | 135 | 08/09 → | 1.796 | B | M | 4 | 16 | M271.820, M271.860 | | 84004 | |
| E 200 NGT | 120 | 03/11 → | 1.796 | | M | 4 | 16 | M271.958 | | 84004 | |
| E 220 BlueTEC | 130 | 05/15 → | 2.143 | D | M | 4 | 16 | OM651.924 | | 84044 | NEW |
| | 130 | 05/14 → | 2.143 | D | M | 4 | 16 | OM651.911 | | 84044 | NEW |
| | 130 | 05/14 → | 2.143 | D | M | 4 | 16 | OM651.924 | | 84044 | NEW |
| E 220 BlueTEC 4-matic | 125 | 01/15 → | 2.143 | D | M | 4 | 16 | OM651.924 | | 84044 | NEW |
| E 220 CDI | 120 | 07/14 → | 2.143 | D | M | 4 | 16 | OM651.911 | | 84044 | NEW |
| | 120 | 01/09 → | 2.143 | D | M | 4 | 16 | OM651.924 | | 84044 | NEW |
| | 120 | 02/10 → | 2.143 | D | M | 4 | 16 | OM651.911 | | 84044 | NEW |
| | 120 | 08/09 → | 2.143 | D | M | 4 | 16 | OM651.924 | | 84044 | NEW |
| E 220 CDI / BlueTEC | 125 | 01/09 → | 2.143 | D | M | 4 | 16 | OM651.924 | | 84044 | NEW |
| E 220 CDI / BlueTEC / d | 125 | 01/10 → | 2.143 | D | M | 4 | 16 | OM651.911 | | 84044 | NEW |

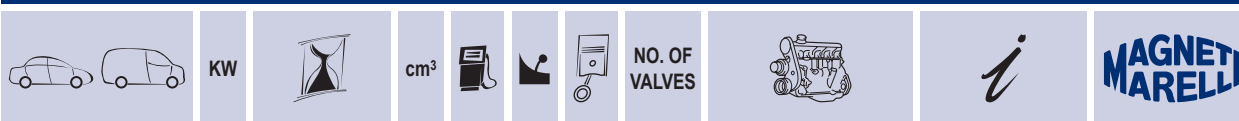

MERCEDES-BENZ

Classe E IV (W212), Station Wagon (S212), Cabrio (A207), Coupé (C207)

| | | | | | | | | | | | |
|-------------------------------|-----|---------------|-------|---|---|---|----|----------------------|--|-------|------------|
| E 220 CDI / d | 125 | 01/10 → | 2.143 | D | M | 4 | 16 | OM651.911 | | 84044 | NEW |
| E 250 CDI / BlueTEC | 150 | 01/09 → | 2.143 | D | M | 4 | 16 | OM651.924 | | 84044 | NEW |
| E 250 CDI / BlueTEC / d | 150 | 01/10 → | 2.143 | D | M | 4 | 16 | OM651.911 | | 84044 | NEW |
| E 250 CDI / BlueTEC 4-matic | 150 | 01/09 → | 2.143 | D | M | 4 | 16 | OM651.924 | | 84044 | NEW |
| E 250 CDI / d | 150 | 01/09 → | 2.143 | D | M | 4 | 16 | OM651.911 | | 84044 | NEW |
| E 250 CGI | 150 | 01/09 → | 1.796 | B | M | 4 | 16 | M271.860 | | 84004 | |
| E 300 CDI | 150 | 12/09 → 12/10 | 2.987 | D | M | 6 | 24 | OM642.850 | | 82058 | |
| E 300 CDI / BlueTEC | 170 | 03/11 → | 2.987 | D | M | 6 | 24 | OM642.850, OM642.852 | | 82058 | |
| E 300 Hybrid / BlueTEC Hybrid | 150 | 12/11 → | 2.143 | | M | 4 | 16 | OM651.924 | | 84044 | NEW |
| E 350 BlueTEC | 155 | 01/09 → | 2.987 | D | M | 6 | 24 | OM642.850 | | 82058 | |
| E 350 CDI | 170 | 01/10 → | 2.987 | D | M | 6 | 24 | OM642.836 | | 82058 | |
| | 170 | 01/09 → | 2.987 | D | M | 6 | 24 | OM642.850 | | 82058 | |
| | 170 | 11/09 → | 2.987 | D | M | 6 | 24 | OM642.850, OM642.852 | | 82058 | |
| E 350 CDI 4-matic | 170 | 09/09 → | 2.987 | D | M | 6 | 24 | OM642.856 | | 82058 | |

Classe G (W460, W461), Cabrio (W463)

| | | | | | | | | | | | |
|----------------|-----|---------------|-------|---|---|---|----|-----------|----------------------------|-------|--|
| 250 GD | 62 | 10/87 → 12/92 | 2.497 | D | M | 5 | 10 | OM602.930 | 07-1982 →, → 10-1991 | 81506 | |
| | 68 | 12/88 → 08/92 | 2.497 | D | M | 5 | 10 | OM602.930 | 07-1982 →, → 10-1991 | 81506 | |
| | 68 | 02/90 → | 2.497 | D | M | 5 | 10 | OM602.939 | | 81506 | |
| | 69 | 06/90 → | 2.497 | D | M | 5 | 10 | OM602.931 | | 81506 | |
| 290 GD/G 290 D | 70 | 04/92 → | 2.874 | D | M | 5 | 10 | OM602.942 | 01-1992 → | 81506 | |
| 300 GD | 83 | 12/90 → 09/97 | 2.996 | D | M | 6 | 12 | OM603.931 | | 81506 | |
| 300 GE | 125 | 06/90 → | 2.960 | B | M | 6 | 12 | M103.987 | 01-1989 → | 81507 | |
| | 128 | 06/90 → | 2.960 | B | M | 6 | 12 | M103.987 | 01-1989 → | 81507 | |
| | 155 | 09/94 → 11/97 | 3.199 | B | M | 6 | 24 | M104.996 | 01-1995 → | 81724 | |
| 350 G Turbo-D | 100 | 09/91 → 09/97 | 3.449 | D | M | 6 | 12 | OM603.972 | → M: 004.348 | 81506 | |
| | 100 | 09/91 → 09/97 | 3.449 | D | M | 6 | 12 | OM603.972 | 01-1997 →, M →: 004.349 | 81726 | |
| 350 Turbo GD | 100 | 09/91 → | 3.449 | D | M | 6 | 12 | OM603.972 | | 81506 | |
| G 270 CDI | 115 | 01/03 → | 2.685 | D | M | 5 | 20 | OM612.966 | | 82088 | |
| | 115 | 10/01 → | 2.685 | D | M | 5 | 20 | OM612.965 | | 82047 | |
| G 280 CDI | 135 | 04/09 → | 2.987 | D | M | 6 | 24 | OM642.884 | | 82058 | |
| G 290 TD | 88 | 07/97 → | 2.874 | D | M | 5 | 10 | OM602.983 | | 81506 | |
| G 300 CDI | 135 | 04/10 → | 2.987 | D | M | 6 | 24 | OM642.884 | | 82058 | |
| G 300 TD | 130 | 08/96 → | 2.996 | D | M | 6 | 24 | OM606.964 | | 81506 | |
| | 130 | 09/96 → | 2.996 | D | M | 6 | 24 | OM606.964 | | 81726 | |
| G 320 | 155 | 09/94 → 12/97 | 3.199 | B | M | 6 | 24 | M104.996 | 01-1995 → | 81724 | |
| | 158 | 07/97 → | 3.199 | B | M | 6 | 18 | M112.945 | | 81724 | |
| | 158 | 11/97 → | 3.199 | B | M | 6 | 18 | M112.945 | | 81730 | |
| G 320 CDI | 165 | 09/06 → | 2.987 | D | M | 6 | 24 | OM642.970 | | 82059 | |
| G 350 CDI | 155 | 07/11 → | 2.987 | D | M | 6 | 24 | OM642.886 | | 82058 | |



KW



cm³



NO. OF VALVES



MERCEDES-BENZ

Classe G (W460, W461), Cabrio (W463)

| | | | | | | | | | | |
|----------|-----|---------|-------|---|---|---|----|-------------------|--|-------|
| G 350 d | 180 | 06/15 → | 2.987 | D | M | 6 | 24 | OM642.887 | | 82058 |
| G 36 AMG | 200 | 01/95 → | 3.606 | B | M | 6 | 24 | M104.996 (AMG3,6) | | 81724 |
| G 500 | 218 | 04/98 → | 4.966 | B | A | 8 | 24 | M113.962 | | 81730 |
| G 55 AMG | 260 | 04/99 → | 5.439 | B | A | 8 | 24 | M113.982 | | 81730 |

Classe GL I (X164)

| | | | | | | | | | | |
|----------------------------------|-----|---------------|-------|---|---|---|----|-----------|--|-------|
| GL 320 CDI / 350 BlueTEC 4-matic | 155 | 12/09 → | 2.987 | D | M | 6 | 24 | OM642.820 | | 82058 |
| GL 320 CDI 4-matic | 165 | 09/06 → 05/09 | 2.987 | D | M | 6 | 24 | OM642.940 | | 82059 |
| GL 350 CDI 4-matic | 165 | 05/09 → | 2.987 | D | M | 6 | 24 | OM642.940 | | 82059 |
| | 195 | 10/10 → | 2.987 | D | M | 6 | 24 | OM642.822 | | 82058 |

Classe GL II (X166)

| | | | | | | | | | | |
|------------------------------|-----|---------|-------|---|---|---|----|-----------|--|-------|
| GL 350 CDI / BlueTec 4-matic | 190 | 07/12 → | 2.987 | D | M | 6 | 24 | OM642.826 | | 82058 |
|------------------------------|-----|---------|-------|---|---|---|----|-----------|--|-------|

Classe GLA (X156)

| | | | | | | | | | | |
|-----------------|----|---------|-------|---|---|---|---|-----------|--|-------|
| GLA 180 CDI / d | 80 | 07/14 → | 1.461 | D | M | 4 | 8 | OM607.951 | | 82098 |
|-----------------|----|---------|-------|---|---|---|---|-----------|--|-------|

Classe GLK (X204)

| | | | | | | | | | | | |
|-----------------|-----|---------------|-------|---|---|---|----|----------------------|--|-------|------------|
| 200 CDI | 105 | 07/10 → | 2.143 | D | M | 4 | 16 | OM651.913, OM651.916 | | 84044 | NEW |
| | 120 | 12/08 → | 2.143 | D | M | 4 | 16 | OM651.916 | | 84044 | NEW |
| | 125 | 12/08 → | 2.143 | D | M | 4 | 16 | OM651.916 | | 84044 | NEW |
| 220 CDI 4-matic | 120 | 12/08 → | 2.143 | D | M | 4 | 16 | OM651.912 | | 84044 | NEW |
| | 125 | 12/08 → | 2.143 | D | M | 4 | 16 | OM651.912 | | 84044 | NEW |
| 250 CDI 4-matic | 150 | 09/09 → | 2.143 | D | M | 4 | 16 | OM651.912 | | 84044 | NEW |
| 320 CDI 4-matic | 165 | 06/08 → | 2.987 | D | M | 6 | 24 | OM642.961 | | 82058 | |
| 350 CDI 4-matic | 165 | 07/09 → 01/10 | 2.987 | D | M | 6 | 24 | OM642.832 | | 82058 | |
| | 170 | 02/10 → 05/10 | 2.987 | D | M | 6 | 24 | OM642.832 | | 82058 | |

Classe M I (W163)

| | | | | | | | | | | |
|----------------|-----|---------------|-------|---|---|---|----|--------------------|---------------|-------|
| ML 230 | 110 | 02/98 → 06/05 | 2.295 | B | M | 4 | 16 | M111.977 | | 81499 |
| ML 270 CDI | 120 | 12/99 → 06/05 | 2.685 | D | M | 5 | 20 | OM612.963 | | 82088 |
| ML 320 | 160 | 02/98 → 08/02 | 3.199 | B | M | 6 | 18 | M112.942 | | 81730 |
| ML 350 | 180 | 08/02 → 06/05 | 3.724 | B | M | 6 | 18 | M112.970 | | 81730 |
| ML 350 4-matic | 173 | 02/03 → 06/05 | 3.724 | B | M | 6 | 18 | M112.970 | | 81730 |
| ML 430 | 200 | 02/98 → 06/05 | 4.266 | B | A | 8 | 24 | M113.942 | | 81730 |
| ML 500 | 215 | 09/01 → 06/05 | 4.966 | B | M | 8 | 24 | M113.964, M113.965 | | 81730 |
| ML 55 AMG | 255 | 02/00 → 06/05 | 5.439 | B | A | 8 | 24 | M113.981 | → M: M036.808 | 81730 |

Classe M II (W164)

| | | | | | | | | | | |
|--------------------|-----|---------------|-------|---|---|---|----|-----------|--|-------|
| ML 280 CDI 4-matic | 140 | 07/05 → 07/09 | 2.987 | D | M | 6 | 24 | OM642.940 | | 82059 |
| ML 300 CDI 4-matic | 140 | 07/09 → | 2.987 | D | M | 6 | 24 | OM642.940 | | 82059 |
| | 150 | 02/10 → | 2.987 | D | M | 6 | 24 | OM642.820 | | 82058 |
| ML 320 CDI 4-matic | 165 | 07/05 → 07/09 | 2.987 | D | M | 6 | 24 | OM642.940 | | 82059 |
| ML 350 CDI 4-matic | 155 | 09/09 → | 2.987 | D | M | 6 | 24 | OM642.820 | | 82058 |
| | 165 | 07/09 → | 2.987 | D | M | 6 | 24 | OM642.940 | | 82059 |
| | 170 | 02/10 → | 2.987 | D | M | 6 | 24 | OM642.820 | | 82059 |
| ML 500 4-matic | 225 | 07/05 → | 4.966 | B | M | 8 | 24 | M113.964 | | 81730 |

| | | | | | | | | | |
|--|--|--|--|--|--|--|--|--|--|
| | | | | | | | | | |
|--|--|--|--|--|--|--|--|--|--|

MERCEDES-BENZ

Classe M III (166)

| | | | | | | | | | | | |
|------------------------------|-----|---------|-------|---|---|---|----|-----------|--|-------|--|
| ML 250 CDI / BlueTEC 4-matic | 150 | 06/11 → | 2.143 | D | M | 4 | 16 | OM651.960 | | 84044 | |
| ML 350 BlueTEC 4-matic | 190 | 06/11 → | 2.987 | D | M | 6 | 24 | OM642.826 | | 82058 | |

Classe R (W251, V251)

| | | | | | | | | | | |
|-------------------|-----|---------|-------|---|---|---|----|---------------------------------|-----------|-------|
| R 280 CDI | 140 | 05/06 → | 2.987 | D | M | 6 | 24 | OM642.870, OM642.872, OM642.950 | → 10-2007 | 82058 |
| | 140 | 05/06 → | 2.987 | D | M | 6 | 24 | OM642.870, OM642.872, OM642.950 | 11-2007 → | 82059 |
| R 280 CDI 4-matic | 140 | 05/06 → | 2.987 | D | M | 6 | 24 | OM642.950 | → 10-2007 | 82058 |
| | 140 | 05/06 → | 2.987 | D | M | 6 | 24 | OM642.950 | 11-2007 → | 82059 |
| R 300 CDI | 140 | 07/09 → | 2.987 | D | M | 6 | 24 | OM642.870, OM642.872, OM642.950 | | 82059 |
| R 300 CDI 4-matic | 140 | 07/09 → | 2.987 | D | M | 6 | 24 | OM642.950 | | 82059 |
| R 320 CDI 4-matic | 155 | 01/06 → | 2.987 | D | M | 6 | 24 | OM642.870, OM642.950 | | 82058 |
| | 165 | 01/06 → | 2.987 | D | M | 6 | 24 | OM642.950 | → 10-2007 | 82058 |
| | 165 | 01/06 → | 2.987 | D | M | 6 | 24 | OM642.950 | 11-2007 → | 82059 |
| R 350 CDI 4-matic | 155 | 01/06 → | 2.987 | D | M | 6 | 24 | OM642.870, OM642.950 | | 82059 |
| | 165 | 07/09 → | 2.987 | D | M | 6 | 24 | OM642.950 | | 82059 |

Classe S III (W126), Coupé (C126)

| | | | | | | | | | | |
|------------|-----|---------------|-------|---|---|---|----|----------|--|-------|
| 260 SE | 118 | 09/85 → 06/91 | 2.597 | B | M | 6 | 12 | M103.941 | 09-1985 →, → 06-1991, M →: 002.988 | 81507 |
| | 122 | 09/85 → 06/91 | 2.597 | B | M | 6 | 12 | M103.941 | 09-1985 →, → 06-1991, M →: 002.988 | 81507 |
| 300 SE,SEL | 132 | 01/86 → 06/91 | 2.960 | B | M | 6 | 12 | M103.981 | | 81507 |

Classe S IV (W140), Coupé (C140)

| | | | | | | | | | | |
|-----------------|-----|---------------|-------|---|---|---|----|--------------------|--|-------|
| 300 SE 2.8 | 145 | 01/93 → 10/98 | 2.799 | B | M | 6 | 24 | M104.944 | | 81724 |
| 300 SE,SEL/S320 | 170 | 03/91 → 10/98 | 3.199 | B | M | 6 | 24 | M104.990, M104.994 | | 81724 |
| S 280 | 142 | 02/93 → 10/98 | 2.799 | B | M | 6 | 24 | M104.944 | | 81724 |
| S 300 Turbo-D | 130 | 05/96 → 10/98 | 2.996 | D | M | 6 | 24 | OM606.961 | | 81506 |
| S 350 Turbo-D | 110 | 01/93 → 10/98 | 3.449 | D | M | 6 | 12 | OM603.971 | | 81506 |

Classe S V (W220), Coupé (C215)

| | | | | | | | | | | |
|---------------|-----|---------------|-------|---|---|---|----|--------------------|--------------|-------|
| CL 500 | 225 | 03/99 → 03/06 | 4.966 | B | A | 8 | 24 | M113.960 | → M: 036.808 | 81730 |
| CL 55 AMG | 265 | 10/99 → 03/06 | 5.439 | B | A | 8 | 24 | M113.986 | | 81730 |
| S 280 | 150 | 10/98 → 08/05 | 2.799 | B | M | 6 | 18 | M112.922 | | 81730 |
| S 320 | 165 | 10/98 → 08/05 | 3.199 | B | A | 6 | 18 | M112.944 | | 81724 |
| S 350 | 180 | 09/02 → 08/05 | 3.724 | B | M | 6 | 18 | M112.972 | | 81730 |
| S 350 4-matic | 180 | 06/03 → 08/05 | 3.724 | B | M | 6 | 18 | M112.975 | | 81730 |
| S 430 | 205 | 10/98 → 08/05 | 4.266 | B | A | 8 | 24 | M113.941 | → M: 036.808 | 81730 |
| S 430 4-matic | 205 | 09/02 → 08/05 | 4.266 | B | A | 8 | 24 | M113.948 | | 81730 |
| S 500 | 225 | 10/98 → 08/05 | 4.966 | B | A | 8 | 24 | M113.960, M113.966 | | 81499 |
| S 500 4-matic | 225 | 09/02 → 08/05 | 4.966 | B | A | 8 | 24 | M113.966 | | 81730 |

KW

cm³

NO. OF VALVES

MERCEDES-BENZ
Classe S V (W220), Coupé (C215)

| | | | | | | | | | | |
|----------|-----|---------------|-------|---|---|---|----|----------|--|-------|
| S 55 AMG | 265 | 04/99 → 08/05 | 5.439 | B | A | 8 | 24 | M113.986 | | 81730 |
|----------|-----|---------------|-------|---|---|---|----|----------|--|-------|

Classe S VI (W221), Coupé (C216)

| | | | | | | | | | | |
|-----------------------|-----|---------------|-------|---|---|---|----|-----------|--|------------------|
| S 250 CDI | 150 | 01/11 → 12/13 | 2.143 | D | M | 4 | 16 | OM651.961 | | 84044 NEW |
| S 320 CDI | 155 | 10/05 → 12/13 | 2.987 | D | M | 6 | 24 | OM642.930 | | 82058 |
| | 173 | 12/05 → 06/09 | 2.987 | D | M | 6 | 24 | OM642.930 | | 82059 |
| S 320 CDI 4-matic | 155 | 10/05 → 12/13 | 2.987 | D | M | 6 | 24 | OM642.932 | | 82058 |
| | 173 | 10/06 → 12/13 | 2.987 | D | M | 6 | 24 | OM642.932 | | 82059 |
| S 350 BlueTec | 190 | 04/11 → 12/13 | 2.987 | D | M | 6 | 24 | OM642.862 | | 82058 |
| S 350 BlueTEC 4-matic | 190 | 04/11 → 12/13 | 2.987 | D | M | 6 | 24 | OM642.868 | | 82058 |
| S 350 CDI | 173 | 06/09 → 12/13 | 2.987 | D | M | 6 | 24 | OM642.930 | | 82058 |

Classe V

| | | | | | | | | | | |
|-----------|-----|---------------|-------|---|---|---|----|--------------------|---------------|-------|
| V 200 | 95 | 02/97 → 07/03 | 1.998 | B | M | 4 | 16 | M111.948, M111.950 | → M: 002.353 | 81728 |
| | 95 | 02/97 → 07/03 | 1.998 | B | M | 4 | 16 | M111.948, M111.950 | M → : 002.354 | 81729 |
| V 200 CDI | 75 | 03/99 → 07/03 | 2.151 | D | M | 4 | 16 | OM611.980 | | 82030 |
| V 220 CDI | 90 | 03/99 → 07/03 | 2.151 | D | M | 4 | 16 | OM611.980 | | 82030 |
| V 230 | 105 | 10/96 → 07/03 | 2.295 | B | M | 4 | 16 | M111.978 | → M: 001.594 | 81728 |
| | 105 | 10/96 → 07/03 | 2.295 | B | M | 4 | 16 | M111.978 | M → : 001.595 | 81729 |
| V 230 TD | 72 | 09/96 → 07/03 | 2.299 | D | M | 4 | 8 | OM601.970 | | 81506 |
| V 280 | 128 | 08/97 → 07/03 | 2.792 | B | M | 6 | 12 | M104.900 | | 81773 |

CLK I (C208), Cabrio (A208)

| | | | | | | | | | | |
|----------------|-----|---------------|-------|---|---|---|----|--------------------|--|-------|
| 200 | 100 | 03/98 → 03/02 | 1.998 | B | M | 4 | 16 | M111.941, M111.945 | | 81725 |
| | 100 | 06/97 → 06/02 | 1.998 | B | M | 4 | 16 | M111.945 | | 81499 |
| 200 Kompressor | 120 | 06/00 → 06/02 | 1.998 | B | M | 4 | 16 | M111.956 | | 81725 |
| | 141 | 06/97 → 06/00 | 1.998 | B | M | 4 | 16 | M111.944 | | 81725 |
| | 141 | 03/98 → 06/00 | 1.998 | B | M | 4 | 16 | M111.944 | | 81724 |
| 230 Kompressor | 142 | 06/97 → 06/00 | 2.295 | B | M | 4 | 16 | M111.973, M111.975 | | 81725 |
| | 145 | 06/00 → 06/02 | 2.295 | B | M | 4 | 16 | M111.982 | | 81725 |
| 320 | 160 | 06/97 → 06/02 | 3.199 | B | M | 6 | 18 | M112.940 | | 81730 |
| | 160 | 03/98 → 03/02 | 3.199 | B | A | 6 | 18 | M112.940 | | 81730 |
| 430 | 205 | 07/98 → 06/02 | 4.266 | B | A | 8 | 24 | M113.943 | | 81730 |
| 55 AMG | 255 | 08/99 → 06/02 | 5.439 | B | M | 8 | 24 | M113.981, M113.984 | | 81730 |

CLK II (C209), Cabrio (A209)

| | | | | | | | | | | |
|----------------|-----|---------------|-------|---|---|---|----|----------------------|--|-------|
| 200 CGI | 125 | 07/03 → 05/09 | 1.796 | B | M | 4 | 16 | M271.942 | | 84004 |
| 200 Kompressor | 120 | 09/02 → 05/09 | 1.796 | B | M | 4 | 16 | M271.940 | | 84004 |
| | 135 | 10/06 → 05/09 | 1.796 | B | M | 4 | 16 | M271.955 | | 84004 |
| 220 CDI | 100 | 01/05 → 05/09 | 2.148 | D | M | 4 | 16 | OM646.966 | | 82082 |
| | 110 | 01/05 → 05/09 | 2.148 | D | M | 4 | 16 | OM646.966 | | 82082 |
| 240 | 120 | 06/02 → 05/09 | 2.597 | B | M | 6 | 18 | M112.912 | | 81730 |
| | 125 | 06/02 → 05/09 | 2.597 | B | M | 6 | 18 | M112.912 | | 81730 |
| 270 CDI | 120 | 02/03 → 06/05 | 2.685 | D | M | 5 | 20 | OM612.967 | | 82088 |
| | 125 | 10/02 → 05/09 | 2.685 | D | M | 5 | 20 | OM612.962, OM612.967 | | 82088 |
| 320 | 160 | 06/02 → 05/09 | 3.199 | B | A | 6 | 18 | M112.955 | | 81730 |
| 320 CDI | 165 | 01/05 → 05/09 | 2.987 | D | M | 6 | 24 | OM642.910 | | 82058 |
| 500 | 225 | 06/02 → 05/09 | 4.966 | B | A | 8 | 24 | M113.968 | | 81730 |

| | | | | | | | | | | | |
|--|--|----|--|-----------------|--|--|--|---------------|--|--|--|
| | | KW | | cm ³ | | | | NO. OF VALVES | | | |
|--|--|----|--|-----------------|--|--|--|---------------|--|--|--|

MERCEDES-BENZ

CLK II (C209), Cabrio (A209)

| | | | | | | | | | | |
|--------------------|-----|---------------|-------|---|---|---|----|-----------|--|-------|
| 55 AMG | 270 | 09/02 → 05/09 | 5.439 | B | A | 8 | 24 | M113.987 | | 81730 |
| CLK 200 CGI | 125 | 07/03 → 03/10 | 1.796 | B | M | 4 | 16 | M271.942 | | 81725 |
| CLK 200 Kompressor | 120 | 02/03 → 03/10 | 1.796 | B | M | 4 | 16 | M271.940 | | 84004 |
| | 135 | 10/06 → 03/10 | 1.796 | B | M | 4 | 16 | M271.955 | | 84004 |
| CLK 240 | 125 | 02/03 → 03/10 | 2.597 | B | M | 6 | 18 | M112.912 | | 81730 |
| CLK 320 | 160 | 02/03 → 03/10 | 3.199 | B | M | 6 | 18 | M112.955 | | 81730 |
| CLK 320 CDI | 165 | 03/05 → 03/10 | 2.987 | D | M | 6 | 24 | OM642.910 | | 82058 |
| CLK 500 | 225 | 02/03 → 03/10 | 4.966 | B | M | 8 | 24 | M113.968 | | 81730 |
| CLK 55 AMG | 270 | 02/03 → 03/10 | 5.439 | B | M | 8 | 24 | M113.987 | | 81730 |
| CLK AMG DTM | 428 | 06/04 → 03/10 | 5.439 | B | M | 8 | 24 | M113.994 | | 81730 |
| DTM AMG | 428 | 06/04 → 05/09 | 5.439 | B | M | 8 | 24 | M113.994 | | 81730 |

CLS I (C219)

| | | | | | | | | | | |
|-------------|-----|---------------|-------|---|---|---|----|-----------|--|-------|
| CLS 320 CDI | 155 | 01/05 → 12/10 | 2.987 | D | M | 6 | 24 | OM642.920 | | 82058 |
| | 165 | 01/05 → 12/10 | 2.987 | D | M | 6 | 24 | OM642.920 | | 82058 |
| CLS 350 CDI | 200 | 04/09 → 12/10 | 2.987 | D | M | 6 | 24 | OM642.920 | | 82058 |
| | 165 | 04/09 → 12/10 | 2.987 | D | M | 6 | 24 | OM642.920 | | 82058 |
| CLS 500 | 225 | 10/04 → 12/10 | 4.966 | B | M | 8 | 24 | M113.967 | | 81730 |

CLS II (C218), Shooting Brake (X218)

| | | | | | | | | | | | |
|-----------------------------|-----|---------|-------|---|---|---|----|-----------|--|-------|--|
| CLS 220 BlueTEC | 130 | 05/14 → | 2.143 | D | M | 4 | 16 | OM651.924 | | 84044 | |
| CLS 220 BlueTEC / d | 120 | 05/14 → | 2.143 | D | M | 4 | 16 | OM651.924 | | 84044 | |
| | 125 | 05/14 → | 2.143 | D | M | 4 | 16 | OM651.924 | | 84044 | |
| CLS 250 BlueTEC / d 4-matic | 150 | 05/14 → | 2.143 | D | M | 4 | 16 | OM651.924 | | 84044 | |
| CLS 250 CDI / BlueTEC / d | 150 | 04/11 → | 2.143 | D | M | 4 | 16 | OM651.924 | | 84044 | |

Coupé III (C124)

| | | | | | | | | | | |
|--------|-----|---------------|-------|---|---|---|----|----------|--------------|-------|
| 220 CE | 110 | 10/92 → 05/93 | 2.199 | B | M | 4 | 16 | M111.960 | | 81499 |
| 230 CE | 97 | 03/87 → 12/92 | 2.298 | B | M | 4 | 8 | M102.982 | | 81509 |
| | 100 | 03/87 → 12/92 | 2.298 | B | M | 4 | 8 | M102.982 | | 81509 |
| 300 CE | 132 | 03/87 → 05/93 | 2.960 | B | M | 6 | 12 | M103.983 | M →: 018.293 | 81507 |
| 320 CE | 162 | 10/92 → 05/93 | 3.199 | B | M | 6 | 24 | M104.992 | | 81722 |

Kombi II (S124)

| | | | | | | | | | | |
|---------|-----|---------------|-------|---|---|---|----|-----------|-------------------------|-------|
| 200 T | 77 | 01/86 → 05/90 | 1.996 | B | M | 4 | 8 | M102.922 | | 81509 |
| 200 T D | 53 | 09/85 → 08/91 | 1.997 | D | M | 4 | 8 | OM601.912 | 01-1985 →, → 05-1993 | 81504 |
| | 55 | 09/88 → 08/91 | 1.997 | D | M | 4 | 8 | OM601.912 | 01-1985 →, → 05-1993 | 81504 |
| 200 TE | 87 | 09/88 → 08/92 | 1.996 | B | M | 4 | 8 | M102.963 | | 81509 |
| | 110 | 10/92 → 05/93 | 2.199 | B | M | 4 | 16 | M111.960 | | 81499 |
| 230 TE | 97 | 09/85 → 08/92 | 2.298 | B | M | 4 | 8 | M102.982 | | 81509 |
| | 100 | 09/85 → 08/92 | 2.298 | B | M | 4 | 8 | M102.982 | | 81509 |
| 250 T D | 66 | 09/85 → 06/93 | 2.497 | D | M | 5 | 10 | OM602.912 | → M: 033.729 | 81506 |
| | 66 | 09/85 → 06/93 | 2.497 | D | M | 5 | 10 | OM602.912 | M →: 033.730 | 81726 |
| | 69 | 01/89 → 06/93 | 2.497 | D | M | 5 | 10 | OM602.912 | | 81506 |

KW

cm³

NO. OF VALVES

MERCEDES-BENZ
Kombi II (S124)

| | | | | | | | | | | |
|-----------------------|-----|---------------|-------|---|---|---|----|-----------|--|-------|
| 280 TE | 145 | 10/92 → 06/93 | 2.799 | B | M | 6 | 24 | M104.942 | | 81722 |
| 300 T D | 80 | 09/86 → 06/93 | 2.996 | D | M | 6 | 12 | OM603.912 | 01-1985 → | 81506 |
| | 81 | 01/89 → 06/93 | 2.996 | D | M | 6 | 12 | OM603.912 | 01-1985 → | 81506 |
| | 83 | 01/89 → 06/93 | 2.996 | D | M | 6 | 12 | OM603.912 | 01-1985 → | 81506 |
| 300 T Turbo-D | 108 | 01/89 → 06/93 | 2.996 | D | M | 6 | 12 | OM603.960 | 01-1987 → | 81506 |
| 300 T Turbo-D 4-matic | 108 | 01/89 → 06/93 | 2.996 | D | M | 6 | 12 | OM603.960 | 01-1987 → | 81506 |
| 300 TE | 132 | 01/86 → 08/92 | 2.960 | B | M | 6 | 12 | M103.983 | M →: 018.293 | 81507 |
| 300 TE 4-matic | 132 | 09/86 → 06/93 | 2.960 | B | M | 6 | 12 | M103.985 | 01-1985 →, → 05-1996, M →: 094.339 | 81507 |
| 320 TE | 162 | 10/92 → 06/93 | 3.199 | B | M | 6 | 24 | M104.992 | | 81722 |

Saloon (W124)

| | | | | | | | | | | |
|---------------|-----|---------------|-------|---|---|---|----|--------------------|---|-------|
| 200 | 77 | 01/86 → 05/90 | 1.996 | B | M | 4 | 8 | M102.922 | | 81509 |
| | 75 | 01/86 → 05/90 | 1.996 | B | M | 4 | 8 | M102.922 | | 81509 |
| | 80 | 12/85 → 05/90 | 1.996 | B | M | 4 | 8 | M102.922 | | 81509 |
| 200 D | 55 | 08/89 → 06/93 | 1.997 | D | M | 4 | 8 | OM601.912 | | 81504 |
| 200 E | 87 | 09/88 → 08/92 | 1.996 | B | M | 4 | 8 | M102.963 | | 81509 |
| | 100 | 10/92 → 06/93 | 1.998 | B | M | 4 | 16 | M111.940 | | 81499 |
| 220 E | 110 | 10/92 → 06/93 | 2.199 | B | M | 4 | 16 | M111.960 | | 81499 |
| 230 E | 97 | 12/84 → 06/93 | 2.298 | B | M | 4 | 8 | M102.982 | | 81509 |
| | 100 | 01/85 → 06/93 | 2.298 | B | M | 4 | 8 | M102.982 | | 81509 |
| 250 D | 66 | 04/85 → 06/93 | 2.497 | D | M | 5 | 10 | OM602.912 | | 81506 |
| | 69 | 01/89 → 06/93 | 2.497 | D | M | 5 | 10 | OM602.912 | | 81506 |
| 250 Turbo-D | 93 | 09/88 → 06/93 | 2.497 | D | M | 5 | 10 | OM602.962 | 01-1985 → | 81506 |
| 260 E | 118 | 09/85 → 08/92 | 2.597 | B | M | 6 | 12 | M103.940 | M →: 016.912 | 81507 |
| 260 E 4-matic | 118 | 09/86 → 08/92 | 2.597 | B | M | 6 | 12 | M103.943 | 01-1985 →, → 05-1996, M →: 035.732 | 81507 |
| 280 E | 145 | 10/92 → 06/93 | 2.799 | B | M | 6 | 24 | M104.942 | 01-1993 → | 81722 |
| 300 D | 81 | 06/90 → 06/93 | 2.996 | D | M | 6 | 12 | OM603.912 | 01-1985 → | 81506 |
| | 83 | 08/89 → 06/93 | 2.996 | D | M | 6 | 12 | OM603.912 | → M: 054.122 | 81506 |
| | 83 | 08/89 → 06/93 | 2.996 | D | M | 6 | 12 | OM603.912 | M →: 054.123 | 81726 |
| 300 D 4-matic | 80 | 09/86 → 08/92 | 2.996 | D | M | 6 | 12 | OM603.913 | 01-1985 → | 81506 |
| | 83 | 08/89 → 06/93 | 2.996 | D | M | 6 | 12 | OM603.913 | 01-1985 → | 81506 |
| 300 E | 138 | 01/85 → 08/92 | 2.960 | B | M | 6 | 12 | M103.980, M103.983 | 01-1985 →, → 05-1996, M →: 018.293, → M: 018.293 | 81507 |
| | 132 | 08/85 → 08/92 | 2.960 | B | M | 6 | 12 | M103.983 | M →: 018.293 | 81507 |

KW

cm³

NO. OF VALVES

MERCEDES-BENZ
Saloon (W124)

| | | | | | | | | | | |
|---------------------|-----|---------------|-------|---|---|---|----|-----------|--|-------|
| 300 E 4-matic | 138 | 09/86 → 02/92 | 2.960 | B | M | 6 | 12 | M103.983 | 01-1985 →, → 05-1993, M →: 094.339 | 81507 |
| | 132 | 09/86 → 06/93 | 2.960 | B | M | 6 | 12 | M103.985 | 02-1985 →, → 05-1993, M →: 094.339 | 81507 |
| 300 Turbo-D | 108 | 09/88 → 06/93 | 2.996 | D | M | 6 | 12 | OM603.960 | 01-1987 → | 81506 |
| 300 Turbo-D 4-matic | 108 | 01/88 → 06/93 | 2.996 | D | M | 6 | 12 | OM603.963 | 01-1987 → | 81506 |
| 320 E | 162 | 10/92 → 06/93 | 3.199 | B | M | 6 | 24 | M104.992 | | 81722 |

SL III (R129)

| | | | | | | | | | | |
|--------|-----|---------------|-------|---|---|---|----|--------------------|-------------------------|-------|
| 280 | 142 | 08/93 → 10/01 | 2.799 | B | M | 6 | 24 | M104.943 | 09-1994 → | 81722 |
| | 150 | 05/98 → 10/01 | 2.799 | B | M | 6 | 18 | M112.923, M112.925 | | 81722 |
| 300 SL | 140 | 03/89 → 08/93 | 2.960 | B | M | 6 | 12 | M103.984 | 06-1989 →, → 09-1993 | 81507 |
| 320 | 165 | 05/98 → 10/01 | 3.199 | B | A | 6 | 18 | M112.943 | | 81730 |
| | 170 | 09/93 → 10/01 | 3.199 | B | M | 6 | 24 | M104.991 | | 81724 |

SL IV (R230)

| | | | | | | | | | | |
|-----|-----|---------------|-------|---|---|---|----|----------|--------------|-------|
| 350 | 180 | 03/03 → 01/12 | 3.724 | B | M | 6 | 18 | M112.973 | | 81730 |
| 500 | 225 | 10/01 → 01/12 | 4.966 | B | M | 8 | 24 | M113.963 | → M: 036.808 | 81730 |

SLC (R172)

| | | | | | | | | | | |
|-------|-----|---------|-------|---|---|---|----|-----------|--|------------------|
| 250 d | 150 | 01/16 → | 2.143 | D | M | 4 | 16 | OM651.980 | | 84044 NEW |
|-------|-----|---------|-------|---|---|---|----|-----------|--|------------------|

SLK I (R170)

| | | | | | | | | | | |
|----------------|-----|---------------|-------|---|----|---|----|----------|--|-------|
| 200 | 100 | 09/96 → 03/00 | 1.998 | B | M | 4 | 16 | M111.946 | | 81499 |
| 200 Kompressor | 141 | 10/96 → 03/00 | 1.998 | B | M | 4 | 16 | M111.943 | | 81725 |
| 230 Kompressor | 142 | 09/96 → 03/00 | 2.295 | B | M | 4 | 16 | M111.973 | | 81725 |
| 320 | 160 | 03/00 → 04/04 | 3.199 | B | AM | 6 | 18 | M112.947 | | 81730 |

SLK II (R171)

| | | | | | | | | | | |
|----------------|-----|---------------|-------|---|---|---|----|----------|--|-------|
| 200 Kompressor | 120 | 03/04 → 02/11 | 1.795 | B | M | 4 | 16 | M271.944 | | 84004 |
| | 135 | 01/08 → 02/11 | 1.796 | B | M | 4 | 16 | M271.954 | | 84004 |

SLK III (R172)

| | | | | | | | | | | |
|-------------|-----|---------|-------|---|---|---|----|--------------------|--|------------------|
| 200 | 135 | 02/11 → | 1.796 | B | M | 4 | 16 | M271.860, M271.861 | | 84004 |
| 250 | 150 | 02/11 → | 1.796 | B | M | 4 | 16 | M271.860, M271.861 | | 84004 |
| 250 CDI / d | 150 | 01/12 → | 2.143 | D | M | 4 | 16 | OM651.980 | | 84044 NEW |

Sprinter I (901, 902, 903, 904)

| | | | | | | | | | | |
|---------|-----|---------------|-------|---|---|---|----|--------------------|-------------|-------|
| 208 CDI | 60 | 04/00 → 05/06 | 2.148 | D | M | 4 | 16 | OM611.987 | | 82047 |
| 208 D | 58 | 02/95 → 04/00 | 2.299 | D | M | 4 | 8 | OM601.943 | 01-1996 → | 81774 |
| | 58 | 02/95 → 04/00 | 2.299 | D | M | 4 | 8 | OM601.943 | | 81506 |
| | 60 | 10/96 → 04/00 | 2.299 | D | M | 4 | 8 | OM601.943 | 01-1996 → | 81774 |
| | 75 | 03/97 → 04/00 | 2.874 | D | M | 5 | 10 | OM602.980 | 12-1994 → | 81506 |
| 211 CDI | 80 | 04/00 → 05/06 | 2.148 | D | M | 4 | 16 | OM611.981 | → M: 107859 | 82047 |
| 212 D | 90 | 02/95 → 04/00 | 2.874 | D | M | 5 | 10 | OM602.980 | 12-1994 → | 81506 |
| | 90 | 02/95 → 04/00 | 2.874 | D | M | 5 | 10 | OM602.980 | | 81506 |
| 213 CDI | 95 | 04/00 → 05/06 | 2.148 | D | M | 4 | 16 | OM611.981 | | 82047 |
| 214 | 105 | 02/95 → 05/06 | 2.295 | B | M | 4 | 16 | M111.979, M111.984 | 01-1996 → | 81774 |

KW

cm³

NO. OF VALVES

MERCEDES-BENZ
Sprinter I (901, 902, 903, 904)

| | | | | | | | | | | |
|---------------|-----|---------------|-------|---|---|---|----|--------------------|-------------|-------|
| 214 NGT | 92 | 04/00 → 05/06 | 2.295 | | M | 4 | 16 | M111.984 | | 81774 |
| 216 CDI | 115 | 04/00 → 05/06 | 2.685 | D | M | 5 | 20 | OM612.981 | → 01-2004 | 82047 |
| 308 CDI | 60 | 04/00 → 05/06 | 2.148 | D | M | 4 | 16 | OM611.987 | | 82047 |
| 308 D | 58 | 02/95 → 04/00 | 2.299 | D | M | 4 | 8 | OM601.943 | 01-1996 → | 81774 |
| | 60 | 03/97 → 04/00 | 2.299 | D | M | 4 | 8 | OM601.943 | | 81506 |
| 308 D 2.3 | 58 | 02/95 → 04/00 | 2.299 | D | M | 4 | 8 | OM601.943 | 01-1996 → | 81774 |
| | 60 | 02/95 → 04/00 | 2.299 | D | M | 4 | 8 | OM601.943 | → 04-1995 | 81506 |
| | 60 | 02/95 → 04/00 | 2.299 | D | M | 4 | 8 | OM601.943 | | 82047 |
| | 60 | 11/96 → 04/00 | 2.299 | D | M | 4 | 8 | OM601.943 | 01-1996 → | 81774 |
| 310 D | 75 | 01/97 → 12/99 | 2.874 | D | M | 5 | 10 | OM602.980 | | 81506 |
| 310 D 2.9 | 75 | 02/95 → 04/00 | 2.874 | D | M | 5 | 10 | OM602.980 | 12-1994 → | 81506 |
| 310 D 4x4 | 75 | 05/97 → 08/02 | 2.874 | D | M | 5 | 10 | OM602.980 | 12-1994 → | 81506 |
| 311 CDI | 80 | 04/00 → 05/06 | 2.148 | D | M | 4 | 16 | OM611.981 | → M: 107859 | 82047 |
| 311 CDI 4x4 | 80 | 08/02 → 05/06 | 2.148 | D | M | 4 | 16 | OM611.981 | → M: 107859 | 82047 |
| 312 D 2.9 | 90 | 02/95 → 04/00 | 2.874 | D | M | 5 | 10 | OM602.980 | 12-1994 → | 81506 |
| | 90 | 02/95 → 04/00 | 2.874 | D | M | 5 | 10 | OM602.980 | | 81506 |
| 312 D 2.9 4x4 | 90 | 05/97 → 08/02 | 2.874 | D | M | 5 | 10 | OM602.980 | 12-1994 → | 81506 |
| | 90 | 05/97 → 08/02 | 2.874 | D | M | 5 | 10 | OM602.980 | | 81506 |
| 313 CDI | 95 | 04/00 → 05/06 | 2.148 | D | M | 4 | 16 | OM611.981 | | 82047 |
| 313 CDI 4x4 | 95 | 08/02 → 05/06 | 2.148 | D | M | 4 | 16 | OM611.981 | | 82047 |
| 314 | 105 | 02/95 → 05/06 | 2.295 | B | M | 4 | 16 | M111.979, M111.984 | 01-1996 → | 81774 |
| | 105 | 02/95 → 05/06 | 2.295 | B | M | 4 | 16 | M111.984 | 01-1996 → | 81774 |
| 314 4x4 | 105 | 08/02 → 05/06 | 2.295 | B | M | 4 | 16 | M111.984 | | 81774 |
| 314 NGT | 92 | 04/00 → 05/06 | 2.295 | | M | 4 | 16 | M111.984 | | 81774 |
| | 92 | 04/00 → 05/06 | 2.295 | | M | 4 | 8 | | | 81774 |
| 316 CDI | 115 | 04/00 → 05/06 | 2.685 | D | M | 5 | 20 | OM612.981 | → 01-2004 | 82047 |
| 316 CDI 4x4 | 115 | 08/02 → 05/06 | 2.685 | D | M | 5 | 20 | OM612.981 | → 01-2004 | 82047 |
| 408 CDI | 60 | 04/00 → 05/06 | 2.148 | D | M | 4 | 16 | OM611.987 | | 82047 |
| 408 D | 58 | 02/96 → 05/06 | 2.299 | D | M | 4 | 8 | OM601.943 | 01-1996 → | 81774 |
| 410 D | 75 | 02/96 → 05/06 | 2.874 | D | M | 5 | 10 | OM602.980 | 12-1994 → | 81506 |
| 410 D 4x4 | 75 | 05/97 → 05/06 | 2.874 | D | M | 5 | 10 | OM602.980 | 12-1994 → | 81506 |
| 411 CDI | 80 | 04/00 → 05/06 | 2.148 | D | M | 4 | 16 | OM611.981 | → M: 107859 | 82047 |
| 411 CDI 4x4 | 80 | 04/00 → 05/06 | 2.148 | D | M | 4 | 16 | OM611.981 | → M: 107859 | 82047 |
| 412 D | 85 | 02/96 → 05/06 | 2.874 | D | M | 5 | 10 | OM602.980 | 12-1994 → | 81506 |
| | 90 | 02/96 → 05/06 | 2.874 | D | M | 5 | 10 | OM602.980 | 12-1994 → | 81506 |
| 412 D 4x4 | 85 | 05/97 → 05/06 | 2.874 | D | M | 5 | 10 | OM602.980 | 12-1994 → | 81506 |
| | 90 | 05/97 → 05/06 | 2.874 | D | M | 5 | 10 | OM602.980 | 12-1994 → | 81506 |
| 413 CDI | 95 | 04/00 → 05/06 | 2.148 | D | M | 4 | 16 | OM611.981 | | 82047 |
| 413 CDI 4x4 | 95 | 04/00 → 05/06 | 2.148 | D | M | 4 | 16 | OM611.981 | | 82047 |
| 414 | 105 | 02/96 → 05/06 | 2.295 | B | M | 4 | 16 | M111.979, M111.984 | 01-1996 → | 81774 |
| | 105 | 02/96 → 05/06 | 2.295 | B | M | 4 | 16 | M111.979, M111.984 | | 81774 |
| 414 4x4 | 105 | 05/97 → 05/06 | 2.295 | B | M | 4 | 16 | M111.979, M111.984 | 01-1996 → | 81774 |
| 416 CDI | 115 | 04/00 → 05/06 | 2.685 | D | M | 5 | 20 | OM612.981 | → 01-2004 | 82047 |
| 416 CDI 4x4 | 115 | 04/00 → 05/06 | 2.685 | D | M | 5 | 20 | OM612.981 | → 01-2004 | 82047 |



MERCEDES-BENZ

Sprinter II (905)

| | | | | | | | | | | |
|---------|-----|---------------|-------|---|---|---|----|-----------|--|-------|
| 616 CDI | 115 | 04/01 → 05/06 | 2.685 | D | M | 5 | 20 | OM612.981 | | 82047 |
|---------|-----|---------------|-------|---|---|---|----|-----------|--|-------|

Sprinter III (906)

| | | | | | | | | | | |
|-------------------|-----|---------|-------|---|---|---|----|---------------------------------|--|------------------|
| 209 CDI | 65 | 06/06 → | 2.148 | D | M | 4 | 16 | OM646.984 | | 82052 |
| 210 CDI | 70 | 03/09 → | 2.143 | D | M | 4 | 16 | OM651.955 | | 84025 NEW |
| 211 CDI | 80 | 06/06 → | 2.148 | D | M | 4 | 16 | OM646.985 | | 82052 |
| 213 CDI | 95 | 06/06 → | 2.143 | D | M | 4 | 16 | OM651.955, OM651.956 | | 84025 NEW |
| | 95 | 03/09 → | 2.143 | D | M | 4 | 16 | OM651.956 | | 84025 NEW |
| | 95 | 06/06 → | 2.148 | D | M | 4 | 16 | OM646.986 | | 82052 |
| 215 CDI | 110 | 06/06 → | 2.148 | D | M | 4 | 16 | OM646.986, OM646.989, OM646.990 | | 82052 |
| | 110 | 06/06 → | 2.148 | D | M | 4 | 16 | OM646.989, OM646.990 | | 82052 |
| 216 | 115 | 09/08 → | 1.796 | B | M | 4 | 16 | M271.951 | | 84002 |
| 216 CDI | 120 | 06/06 → | 2.143 | D | M | 4 | 16 | OM651.955, OM651.957 | | 84025 NEW |
| | 120 | 03/09 → | 2.143 | D | M | 4 | 16 | OM651.957 | | 84025 NEW |
| 218 CDI | 135 | 06/06 → | 2.987 | D | M | 6 | 24 | OM642.896, OM642.992 | | 82058 |
| | 135 | 06/06 → | 2.987 | D | M | 6 | 24 | OM642.896, OM642.992, OM642.993 | | 82052 |
| 219 CDI / BlueTEC | 140 | 03/09 → | 2.987 | D | M | 6 | 24 | OM642.896, OM642.992 | | 82058 |
| 224 | 190 | 06/06 → | 3.498 | B | M | 6 | 24 | M272.979 | | 82052 |
| 309 CDI | 65 | 06/06 → | 2.148 | D | M | 4 | 16 | OM646.984 | | 82052 |
| 310 CDI | 70 | 03/09 → | 2.143 | D | M | 4 | 16 | OM651.955 | | 84025 NEW |
| | 70 | 03/09 → | 2.143 | D | M | 4 | 16 | OM651.955, OM651.956 | | 84025 NEW |
| 311 CDI | 80 | 06/06 → | 2.148 | D | M | 4 | 16 | OM646.985 | | 82052 |
| 311 CDI 4x4 | 80 | 02/08 → | 2.148 | D | M | 4 | 16 | OM646.985 | | 82052 |
| 313 CDI | 95 | 08/11 → | 2.143 | D | M | 4 | 16 | OM651.955, OM651.956 | | 84025 NEW |
| | 95 | 06/06 → | 2.148 | D | M | 4 | 16 | OM646.986 | | 82052 |
| | 95 | 06/06 → | 2.148 | D | M | 4 | 16 | OM646.986, OM651.955 | | 82052 |
| 313 CDI 4x4 | 95 | 08/11 → | 2.143 | D | M | 4 | 16 | OM651.955, OM651.956 | | 84025 NEW |
| 315 CDI | 110 | 06/06 → | 2.148 | D | M | 4 | 16 | OM646.989, OM646.990 | | 82052 |
| 315 CDI 4x4 | 110 | 02/08 → | 2.148 | D | M | 4 | 16 | OM646.989, OM646.990 | | 82052 |
| 316 | 115 | 09/08 → | 1.796 | B | M | 4 | 16 | M271.951 | | 84002 |
| 316 CDI | 120 | 08/11 → | 2.143 | D | M | 4 | 16 | OM651.955, OM651.957 | | 84025 NEW |
| | 120 | 03/09 → | 2.143 | D | M | 4 | 16 | OM651.957 | | 84025 NEW |
| 316 CDI 4x4 | 120 | 08/11 → | 2.143 | D | M | 4 | 16 | OM651.955, OM651.957 | | 84025 NEW |
| 316 LGT | 115 | 09/08 → | 1.796 | | M | 4 | 16 | M271.951 | | 84002 |
| | 115 | 09/08 → | 1.796 | | M | 4 | 16 | M271.951 | | 84002 |
| 316 NGT | 115 | 09/08 → | 1.796 | | M | 4 | 16 | M271.951 | | 84002 |
| 318 CDI | 135 | 06/06 → | 2.987 | D | M | 6 | 24 | OM642.896, OM642.992, OM642.993 | | 82052 |
| | 135 | 02/08 → | 2.987 | D | M | 6 | 24 | OM642.896, OM642.992, OM642.993 | | 82058 |
| 318 CDI 4x4 | 135 | 02/08 → | 2.987 | D | M | 6 | 24 | OM642.896, OM642.992, OM642.993 | | 82058 |

KW

cm³

NO. OF VALVES

MERCEDES-BENZ
Sprinter III (906)

| | | | | | | | | | | |
|-----------------------|-----|---------|-------|---|---|---|----|---------------------------------|--|------------------|
| 319 CDI / BlueTEC | 140 | 03/09 → | 2.987 | D | M | 6 | 24 | OM642.896, OM642.898, OM642.992 | | 82058 |
| 319 CDI / BlueTEC 4x4 | 140 | 03/09 → | 2.987 | D | M | 6 | 24 | OM642.896, OM642.898, OM642.992 | | 82058 |
| 324 | 190 | 06/06 → | 3.498 | B | M | 6 | 24 | M272.979 | | 82052 |
| 411 CDI | 80 | 06/09 → | 2.148 | D | M | 4 | 16 | OM646.985 | | 82052 |
| 413 CDI | 95 | 06/06 → | 2.148 | D | M | 4 | 16 | OM646.986 | | 84025 NEW |
| 415 CDI | 110 | 06/06 → | 2.148 | D | M | 4 | 16 | OM646.989, OM646.990 | | 82052 |
| 416 CDI | 120 | 03/09 → | 2.143 | D | M | 4 | 16 | OM651.957 | | 84025 NEW |
| 418 CDI | 135 | 06/09 → | 2.987 | D | M | 6 | 24 | OM642.896, OM642.992 | | 82058 |
| | 135 | 06/06 → | 2.987 | D | M | 6 | 24 | OM642.896, OM642.992, OM642.993 | | 82058 |
| 419 CDI | 140 | 03/09 → | 2.987 | D | M | 6 | 24 | OM642.896, OM642.898, OM642.992 | | 82058 |
| | 140 | 03/09 → | 2.987 | D | M | 6 | 24 | OM642.992 | | 82058 |
| 509 CDI | 65 | 06/06 → | 2.148 | D | M | 4 | 16 | OM646.984 | | 82052 |
| 510 CDI | 70 | 03/09 → | 2.143 | D | M | 4 | 16 | OM651.955 | | 84025 NEW |
| 511 CDI | 80 | 06/06 → | 2.148 | D | M | 4 | 16 | OM646.985 | | 82052 |
| 511 CDI 4x4 | 80 | 06/06 → | 2.148 | D | M | 4 | 16 | OM646.985 | | 82052 |
| 513 CDI | 95 | 06/06 → | 2.143 | D | M | 4 | 16 | OM651.955, OM651.956 | | 84025 NEW |
| | 95 | 06/06 → | 2.143 | D | M | 4 | 16 | OM651.956 | | 84025 NEW |
| | 95 | 06/06 → | 2.148 | D | M | 4 | 16 | OM646.986 | | 84025 NEW |
| 513 CDI 4x4 | 95 | 05/11 → | 2.143 | D | M | 4 | 16 | OM651.955, OM651.956 | | 84025 NEW |
| | 95 | 06/06 → | 2.143 | D | M | 4 | 16 | OM651.956 | | 84025 NEW |
| 515 CDI | 110 | 06/06 → | 2.148 | D | M | 4 | 16 | OM646.986, OM646.989, OM646.990 | | 82052 |
| | 110 | 06/06 → | 2.148 | D | M | 4 | 16 | OM646.989, OM646.990 | | 82052 |
| 515 CDI 4x4 | 110 | 06/06 → | 2.148 | D | M | 4 | 16 | OM646.989, OM646.990 | | 82052 |
| 516 | 115 | 09/08 → | 1.796 | B | M | 4 | 16 | M271.951 | | 84002 |
| 516 CDI | 120 | 03/09 → | 2.143 | D | M | 4 | 16 | OM651.955, OM651.957 | | 84025 NEW |
| 516 CDI 4x4 | 120 | 06/06 → | 2.143 | D | M | 4 | 16 | OM651.955, OM651.957 | | 84025 NEW |
| 516 NGT | 115 | 09/08 → | 1.796 | | M | 4 | 16 | M271.951 | | 84002 |
| 518 CDI | 135 | 06/06 → | 2.987 | D | M | 6 | 24 | OM642.896, OM642.992, OM642.993 | | 82058 |
| | 135 | 06/06 → | 2.987 | D | M | 6 | 24 | OM642.896, OM642.992, OM642.993 | | 82052 |
| 518 CDI 4x4 | 135 | 06/06 → | 2.987 | D | M | 6 | 24 | OM642.896, OM642.992, OM642.993 | | 82058 |
| 519 CDI / BlueTEC | 140 | 03/09 → | 2.987 | D | M | 6 | 24 | OM642.896, OM642.898, OM642.992 | | 82058 |
| 519 CDI / BlueTEC 4x4 | 140 | 03/09 → | 2.987 | D | M | 6 | 24 | OM642.896, OM642.898, OM642.992 | | 82058 |

KW

cm³

NO. OF VALVES

MERCEDES-BENZ
Sprinter IV Classic

| | | | | | | | | | | |
|---------|----|---------|-------|---|---|---|----|-----------|--|-------|
| 311 CDI | 80 | 09/13 → | 2.148 | D | M | 4 | 16 | OM646.701 | | 82052 |
| 411 CDI | 80 | 09/13 → | 2.148 | D | M | 4 | 16 | OM646.701 | | 82052 |

T1

| | | | | | | | | | | |
|-----------|----|---------------|-------|---|---|---|----|----------------------|-------------------------|-------|
| 207 D 2.4 | 53 | 07/82 → 01/90 | 2.376 | D | M | 4 | 8 | | | 81508 |
| | 53 | 06/82 → 01/90 | 2.399 | D | M | 4 | 8 | OM616.937, OM616.939 | | 81508 |
| 208 D 2.3 | 58 | 10/88 → 02/96 | 2.299 | D | M | 4 | 8 | OM601.940 | | 81506 |
| | 60 | 10/88 → 02/96 | 2.299 | D | M | 4 | 8 | OM601.940 | 02-1988 →, → 04-1995 | 81506 |
| | 60 | 06/89 → 02/96 | 2.299 | D | M | 4 | 8 | OM601.940 | | 81506 |
| 210 D 2.8 | 70 | 11/88 → 02/96 | 2.874 | D | M | 5 | 10 | OM602.940 | 01-1983 → | 81506 |
| | 72 | 11/88 → 02/96 | 2.874 | D | M | 5 | 10 | OM602.940 | 01-1983 → | 81506 |
| | 72 | 11/88 → 02/96 | 2.874 | D | M | 5 | 10 | OM602.940 | | 81506 |
| 210 D 2.9 | 70 | 11/88 → 02/96 | 2.874 | D | M | 5 | 10 | OM602.940 | | 81506 |
| 307 D 2.4 | 53 | 10/82 → 01/90 | 2.399 | D | M | 4 | 8 | OM616.937, OM616.939 | | 81508 |
| 308 D 2.3 | 58 | 05/90 → 02/96 | 2.299 | D | M | 4 | 8 | OM601.940 | 01-1983 →, → 04-1995 | 81506 |
| | 60 | 06/89 → 02/96 | 2.299 | D | M | 4 | 8 | OM601.940 | 01-1983 →, → 04-1995 | 81506 |
| 310 D 2.9 | 70 | 06/89 → 02/96 | 2.874 | D | M | 5 | 10 | OM602.940 | 01-1983 → | 81506 |
| | 70 | 06/89 → 02/96 | 2.874 | D | M | 5 | 10 | OM602.940 | | 81506 |
| 310 D 2.9 | 72 | 06/89 → 02/96 | 2.874 | D | M | 5 | 10 | OM602.940 | | 81506 |
| | 72 | 06/90 → 02/96 | 2.874 | D | M | 5 | 10 | OM602.940 | 01-1983 → | 81506 |

Vaneo

| | | | | | | | | | | |
|---------|----|---------------|-------|---|---|---|----|-----------|--|-------|
| 1.6 | 60 | 02/02 → 07/05 | 1.598 | B | M | 4 | 8 | M166.961 | | 82087 |
| | 75 | 02/02 → 07/05 | 1.598 | B | M | 4 | 8 | M166.961 | | 82087 |
| 1.7 CDI | 55 | 02/02 → 07/05 | 1.689 | D | M | 4 | 16 | OM668.914 | | 82087 |
| | 67 | 02/02 → 07/05 | 1.689 | D | M | 4 | 16 | OM668.914 | | 82087 |
| 1.9 | 92 | 02/02 → 07/05 | 1.898 | B | M | 4 | 8 | M166.991 | | 82087 |

Vario

| | | | | | | | | | | |
|-------|----|---------|-------|---|---|---|----|----------------------|--|-------|
| 512 D | 90 | 09/96 → | 2.874 | D | M | 5 | 10 | OM602.984 | | 81506 |
| 612 D | 90 | 09/96 → | 2.874 | D | M | 5 | 10 | OM602.984, OM602.985 | | 81506 |
| 812 D | 90 | 09/96 → | 2.874 | D | M | 5 | 10 | OM602.984, OM602.985 | | 81506 |
| O 812 | 90 | 09/96 → | 2.874 | D | M | 5 | 10 | OM602.984, OM602.985 | | 81506 |

Vito I (W638)

| | | | | | | | | | | |
|-------------|----|---------------|-------|---|---|---|----|-------------------|-----------|-------|
| 108 CDI 2.2 | 60 | 03/99 → 07/03 | 2.148 | D | M | 4 | 16 | OM611A (60KWCDI) | | 82030 |
| | 60 | 03/99 → 07/03 | 2.151 | D | M | 4 | 16 | OM611A (60KWCDI) | | 82030 |
| 108 D 2.3 | 58 | 02/96 → 07/03 | 2.299 | D | M | 4 | 8 | OM601.942 | | 81506 |
| | 58 | 03/97 → 07/03 | 2.299 | D | M | 4 | 8 | OM601.942 | 11-1995 → | 81506 |
| 110 CDI 2.2 | 75 | 03/99 → 07/03 | 2.148 | D | M | 4 | 16 | OM611LA (75KWCDI) | | 82030 |
| | 75 | 03/99 → 07/03 | 2.151 | D | M | 4 | 16 | OM611LA (75KWCDI) | | 82030 |
| 110 D 2.3 | 72 | 03/97 → 07/03 | 2.299 | D | M | 4 | 8 | OM601.970 | 11-1995 → | 81506 |
| 110 TD 2.3 | 72 | 02/96 → 07/03 | 2.299 | D | M | 4 | 8 | OM601.970 | | 81506 |
| 112 CDI 2.2 | 90 | 03/99 → 07/03 | 2.151 | D | M | 4 | 16 | OM611.980 | | 82030 |

KW

cm³

NO. OF VALVES

MERCEDES-BENZ
Vito I (W638)

| | | | | | | | | | | |
|---------|-----|---------------|-------|---|---|---|----|--------------------|---------------|-------|
| 113 2.0 | 95 | 02/96 → 07/03 | 1.998 | B | M | 4 | 16 | M111.948, M111.950 | → M: 002.353 | 81728 |
| | 95 | 02/96 → 07/03 | 1.998 | B | M | 4 | 16 | M111.948, M111.950 | M → : 002.354 | 81729 |
| 114 2.3 | 105 | 12/96 → 07/03 | 2.295 | B | M | 4 | 16 | M111.978, M111.980 | → M: 001.954 | 81728 |
| | 105 | 12/96 → 07/03 | 2.295 | B | M | 4 | 16 | M111.978, M111.980 | M → : 001.595 | 81729 |
| | 105 | 03/97 → 07/03 | 2.295 | B | M | 4 | 16 | M111.978, M111.980 | → M: 001.594 | 81728 |

Vito II (W639) - Viano

| | | | | | | | | | | |
|-------------|-----|---------------|-------|---|---|---|----|----------------------|-----------------|------------------|
| 109 CDI | 65 | 09/03 → | 2.148 | D | M | 4 | 16 | OM646.983 | | 82052 |
| | 70 | 09/06 → | 2.148 | D | M | 4 | 16 | OM646.980 | | 82052 |
| | 70 | 08/06 → | 2.148 | D | M | 4 | 16 | OM646.980, OM646.981 | | 82052 |
| 109 CDI 4x4 | 70 | 09/07 → | 2.148 | D | M | 4 | 16 | OM646.981 | | 82052 |
| 110 CDI | 70 | 09/10 → | 2.143 | D | M | 4 | 16 | OM651.940 | Potenziata | 84048 NEW |
| | 70 | 09/10 → | 2.143 | D | M | 4 | 16 | OM651.940 | | 84046 NEW |
| | 70 | 09/10 → | 2.143 | D | M | 4 | 16 | OM651.940 | | 84047 NEW |
| 111 CDI | 80 | 09/03 → | 2.148 | D | M | 4 | 16 | OM646.982 | | 82052 |
| | 85 | 09/07 → | 2.148 | D | M | 4 | 16 | OM646.980, OM646.982 | | 82052 |
| | 85 | 09/07 → | 2.148 | D | M | 4 | 16 | OM646.980 | | 82052 |
| 111 CDI 4x4 | 80 | 09/07 → | 2.148 | D | M | 4 | 16 | OM646.982 | | 82052 |
| 113 CDI | 100 | 09/10 → | 2.143 | D | M | 4 | 16 | OM651.940 | Potenziata | 84048 NEW |
| | 100 | 09/10 → | 2.143 | D | M | 4 | 16 | OM651.940 | | 84046 NEW |
| | 100 | 09/10 → | 2.143 | D | M | 4 | 16 | OM651.940 | | 84047 NEW |
| 113 CDI 4x4 | 100 | 09/10 → | 2.143 | D | M | 4 | 16 | OM651.940 | Potenziata | 84048 NEW |
| | 100 | 09/10 → | 2.143 | D | M | 4 | 16 | OM651.940 | | 84046 NEW |
| | 100 | 09/10 → | 2.143 | D | M | 4 | 16 | OM651.940 | | 84047 NEW |
| 115 CDI | 110 | 09/03 → | 2.148 | D | M | 4 | 16 | OM646.980, OM646.982 | | 82052 |
| | 110 | 09/03 → | 2.148 | D | M | 4 | 16 | OM646.982 | | 82052 |
| 115 CDI 4x4 | 110 | 07/06 → | 2.148 | D | M | 4 | 16 | OM646.982 | | 82052 |
| 116 CDI | 120 | 09/10 → | 2.143 | D | M | 4 | 16 | OM651.940 | Potenziata | 84048 NEW |
| | 120 | 09/10 → | 2.143 | D | M | 4 | 16 | OM651.940 | | 84046 NEW |
| | 120 | 09/10 → | 2.143 | D | M | 4 | 16 | OM651.940 | | 84047 NEW |
| 116 CDI 4x4 | 120 | 09/10 → | 2.143 | D | M | 4 | 16 | OM651.940 | Potenziata | 84048 NEW |
| | 120 | 09/10 → | 2.143 | D | M | 4 | 16 | OM651.940 | | 84046 NEW |
| | 120 | 09/10 → | 2.143 | D | M | 4 | 16 | OM651.940 | | 84047 NEW |
| 119 | 140 | 09/03 → | 3.199 | B | M | 6 | 18 | M112.951 | | 81730 |
| 120 CDI | 150 | 07/06 → | 2.987 | D | M | 6 | 24 | OM642.990 | | 82058 |
| 122 | 160 | 09/03 → | 3.199 | B | M | 6 | 18 | M112.951 | | 81730 |
| 122 CDI | 165 | 09/10 → | 2.987 | D | M | 6 | 24 | OM642.890 | | 82058 |
| 123 | 170 | 06/04 → | 3.724 | B | M | 6 | 18 | M112.976 | → M: 31.000.000 | 81730 |
| | 170 | 06/04 → 07/08 | 3.724 | B | M | 6 | 18 | M112.976 | → M: 31.000.000 | 81730 |
| 3.0 | 140 | 09/03 → | 3.199 | B | M | 6 | 18 | M112.951 | | 81730 |
| 3.2 | 160 | 09/03 → | 3.199 | B | M | 6 | 18 | M112.951 | | 81730 |
| 3.7 | 170 | 06/04 → | 3.724 | B | M | 6 | 18 | M112.976 | → M: 31.000.000 | 81730 |

KW

cm³

NO. OF VALVES

MERCEDES-BENZ
Vito II (W639) - Viano

| | | | | | | | | | | | |
|-----------------|-----|---------|-------|---|---|---|----|----------------------|------------|-------|------------|
| CDI 2.0 | 100 | 07/10 → | 2.143 | D | M | 4 | 16 | OM651.940 | Potenziata | 84048 | NEW |
| | 100 | 07/10 → | 2.143 | D | M | 4 | 16 | OM651.940 | | 84046 | NEW |
| | 100 | 07/10 → | 2.143 | D | M | 4 | 16 | OM651.940 | | 84047 | NEW |
| | 80 | 09/03 → | 2.148 | D | M | 4 | 16 | OM646.982 | | 82052 | |
| | 85 | 08/05 → | 2.148 | D | M | 4 | 16 | OM646.982 | | 82052 | |
| CDI 2.0 4-matic | 100 | 07/10 → | 2.143 | D | M | 4 | 16 | OM651.940 | Potenziata | 84048 | NEW |
| | 100 | 07/10 → | 2.143 | D | M | 4 | 16 | OM651.940 | | 84046 | NEW |
| | 100 | 07/10 → | 2.143 | D | M | 4 | 16 | OM651.940 | | 84047 | NEW |
| | 80 | 07/05 → | 2.148 | D | M | 4 | 16 | OM646.982 | | 82052 | |
| CDI 2.2 | 120 | 07/10 → | 2.143 | D | M | 4 | 16 | OM651.940 | Potenziata | 84048 | NEW |
| | 120 | 07/10 → | 2.143 | D | M | 4 | 16 | OM651.940 | | 84046 | NEW |
| | 120 | 07/10 → | 2.143 | D | M | 4 | 16 | OM651.940 | | 84047 | NEW |
| | 110 | 09/03 → | 2.148 | D | M | 4 | 16 | OM646.980, OM646.982 | | 82052 | |
| CDI 2.2 4-matic | 120 | 07/10 → | 2.143 | D | M | 4 | 16 | OM651.940 | Potenziata | 84048 | NEW |
| | 120 | 07/10 → | 2.143 | D | M | 4 | 16 | OM651.940 | | 84046 | NEW |
| | 120 | 07/10 → | 2.143 | D | M | 4 | 16 | OM651.940 | | 84047 | NEW |
| | 110 | 07/05 → | 2.148 | D | M | 4 | 16 | OM646.982 | | 82052 | |
| CDI 3.0 | 150 | 03/06 → | 2.987 | D | M | 6 | 24 | OM642.990 | | 82058 | |
| | 165 | 07/10 → | 2.987 | D | M | 6 | 24 | OM642.990 | | 82058 | |

Vito III (W447)

| | | | | | | | | | | | |
|-----------------------|----|---------|-------|---|---|---|----|-----------|--|-------|------------|
| 109 CDI | 65 | 10/14 → | 1.598 | D | M | 4 | 16 | OM622.951 | | 84034 | NEW |
| 109 CDI / 109 BlueTEC | 65 | 10/14 → | 1.598 | D | M | 4 | 16 | OM622.951 | | 84034 | NEW |
| 111 CDI | 84 | 10/14 → | 1.598 | D | M | 4 | 16 | OM622.951 | | 84034 | NEW |
| 111 CDI / 111 BlueTEC | 84 | 10/14 → | 1.598 | D | M | 4 | 16 | OM622.951 | | 84034 | NEW |

MG
Metro

| | | | | | | | | | | | |
|-------|----|---------------|-------|---|---|---|---|--|----|-------|--|
| 1300 | 54 | 05/82 → 09/90 | 1.275 | B | M | 4 | 8 | | BC | 81419 | |
| Turbo | 69 | 10/82 → 09/90 | 1.275 | B | M | 4 | 8 | | BC | 81419 | |

MG TF

| | | | | | | | | | | | |
|-----|-----|---------------|-------|---|---|---|----|-------|--|-------|--|
| 115 | 85 | 03/02 → 12/09 | 1.588 | B | M | 4 | 16 | 16K4F | | 81615 | |
| 120 | 88 | 03/02 → 12/09 | 1.796 | B | A | 4 | 16 | 18K4F | | 81615 | |
| 135 | 100 | 03/02 → 12/09 | 1.796 | B | M | 4 | 16 | 18K4F | | 81615 | |
| 160 | 118 | 03/02 → 12/09 | 1.796 | B | M | 4 | 16 | 18K4K | | 81615 | |

MG ZR

| | | | | | | | | | | | |
|--------|-----|---------------|-------|---|---|---|----|-------|--|-------|--|
| 105 | 76 | 06/01 → 04/05 | 1.396 | B | M | 4 | 16 | 14K4F | | 81615 | |
| 120 | 86 | 06/01 → 04/05 | 1.796 | B | M | 4 | 16 | 18K4F | | 81615 | |
| 160 | 118 | 06/01 → 04/05 | 1.796 | B | M | 4 | 16 | 18K4K | | 81615 | |
| 2.0 TD | 74 | 06/01 → 04/05 | 1.994 | D | M | 4 | 8 | 20T2N | | 81707 | |

MG ZS

| | | | | | | | | | | | |
|--------|-----|---------------|-------|---|---|---|----|-------|--|-------|--|
| 120 | 86 | 07/01 → 04/05 | 1.796 | B | M | 4 | 16 | 18K4F | | 81615 | |
| 180 | 130 | 07/01 → 04/05 | 2.497 | B | M | 6 | 24 | 25K4F | | 82029 | |
| 2.0 TD | 74 | 01/04 → 04/05 | 1.994 | D | M | 4 | 8 | 20T2N | | 81707 | |
| | 83 | 01/04 → 04/05 | 1.994 | D | M | 4 | 8 | 20T2N | | 81707 | |



KW



cm³



NO. OF VALVES



MAGNETI MARELLI

MG

MGF

| | | | | | | | | | | |
|-----------|-----|---------------|-------|---|---|---|----|-------|--|-------|
| 1.8 i VVC | 118 | 10/01 → 03/02 | 1.796 | B | M | 4 | 16 | 18K4K | | 81615 |
| 1.6 | 82 | 02/00 → 03/02 | 1.588 | B | M | 4 | 16 | 16K4F | | 81615 |
| 1.8 i 16V | 88 | 03/95 → 03/02 | 1.796 | B | M | 4 | 16 | 18K4F | | 81615 |
| 1.8 i VVC | 107 | 03/95 → 03/02 | 1.796 | B | M | 4 | 16 | 18K4K | | 81615 |

MINI

Mini Clubvan

| | | | | | | | | | | | |
|----------|----|---------|-------|---|---|---|----|---------|--|-------|------------|
| Cooper D | 82 | 12/12 → | 1.598 | D | M | 4 | 16 | N47C16A | | 84026 | NEW |
| | 82 | 12/12 → | 1.995 | D | M | 4 | 16 | N47C20A | | 84026 | NEW |

Mini Countryman (R60)

| | | | | | | | | | | | |
|----------------|-----|---------|-------|---|---|---|----|---------|-----------|-------|------------|
| Cooper | 85 | 06/10 → | 1.598 | B | M | 4 | 16 | N16B16A | → 11-2012 | 82032 | |
| | 90 | 06/10 → | 1.598 | B | M | 4 | 16 | N16B16A | → 11-2012 | 82032 | |
| Cooper ALL4 | 90 | 11/14 → | 1.598 | B | M | 4 | 16 | N18B16A | | 82032 | |
| Cooper D | 82 | 06/10 → | 1.598 | D | M | 4 | 16 | N47C16A | | 84026 | NEW |
| | 82 | 02/11 → | 1.995 | D | M | 4 | 16 | N47C20A | | 84026 | NEW |
| Cooper D ALL4 | 82 | 06/10 → | 1.598 | D | M | 4 | 16 | N47C16A | | 84026 | NEW |
| | 82 | 02/11 → | 1.995 | D | M | 4 | 16 | N47C20A | | 84026 | NEW |
| Cooper S | 135 | 06/10 → | 1.598 | B | M | 4 | 16 | N18B16A | → 11-2012 | 82032 | |
| | 147 | 02/12 → | 1.598 | B | M | 4 | 16 | N18B16A | → 11-2012 | 82032 | |
| Cooper S ALL4 | 120 | 06/10 → | 1.598 | B | M | 4 | 16 | N18B16A | → 11-2012 | 82032 | |
| | 135 | 06/10 → | 1.598 | B | M | 4 | 16 | N18B16A | → 11-2012 | 82032 | |
| Cooper S JCW | 160 | 09/12 → | 1.598 | B | M | 4 | 16 | N18B16A | → 11-2012 | 82032 | |
| Cooper SD | 105 | 02/11 → | 1.995 | D | M | 4 | 16 | N47C20A | | 84026 | NEW |
| Cooper SD ALL4 | 100 | 02/11 → | 1.995 | D | M | 4 | 16 | N47C20A | | 84026 | NEW |
| | 105 | 02/11 → | 1.995 | D | M | 4 | 16 | N47C20A | | 84026 | NEW |
| One | 72 | 06/10 → | 1.598 | B | M | 4 | 16 | N16B16A | → 11-2012 | 82032 | |
| One D | 66 | 06/10 → | 1.598 | D | M | 4 | 16 | N47C16A | | 84026 | NEW |

Mini I (R50,R52, R53)

| | | | | | | | | | | | |
|-------------------|-----|---------------|-------|---|---|---|----|---------|--|-------|------------|
| Cooper | 85 | 06/01 → 09/06 | 1.598 | B | M | 4 | 16 | W10B16A | | 81861 | |
| Cooper S | 120 | 03/02 → 09/06 | 1.598 | B | M | 4 | 16 | W11B16A | | 84013 | NEW |
| | 125 | 07/04 → 09/06 | 1.598 | B | M | 4 | 16 | W11B16A | | 81861 | |
| John Cooper Works | 155 | 07/04 → 11/07 | 1.598 | B | M | 4 | 16 | W11B16A | | 84013 | NEW |
| | 160 | 03/06 → 09/06 | 1.598 | B | M | 4 | 16 | W11B16A | | 82032 | |
| One | 55 | 04/03 → 09/06 | 1.398 | B | M | 4 | 16 | W10B14A | | 81861 | |
| | 66 | 06/01 → 09/06 | 1.598 | B | M | 4 | 16 | W10B16A | | 81861 | |
| One D | 55 | 06/03 → 09/06 | 1.364 | D | M | 4 | 8 | 1ND | | 81821 | |
| | 65 | 06/03 → 09/06 | 1.364 | D | M | 4 | 8 | 1ND-TV | | 81821 | |
| S Works | 147 | 11/03 → 06/05 | 1.598 | B | M | 4 | 16 | W11B16A | | 84013 | NEW |
| Works | 155 | 11/03 → 09/06 | 1.598 | B | M | 4 | 16 | W11B16A | | 84013 | NEW |

| | | | | | | | | | | | |
|--|--|----|--|-----------------|--|--|--|---------------|--|--|--|
| | | KW | | cm ³ | | | | NO. OF VALVES | | | |
|--|--|----|--|-----------------|--|--|--|---------------|--|--|--|

MINI

Mini II (R55, R56, R57, R58, R59)

| | | | | | | | | | | |
|----------------------|-----|---------------|-------|---|---|---|----|-----------------------|-----------|------------------|
| Cooper | 85 | 03/10 → 11/13 | 1.598 | B | M | 4 | 16 | N12B16A, N16B16A | → 11-2012 | 82032 |
| | 85 | 03/09 → | 1.598 | B | M | 4 | 16 | N16B16A | → 11-2012 | 82032 |
| | 88 | 10/06 → 02/12 | 1.598 | B | M | 4 | 16 | N12B16A | → 11-2012 | 82032 |
| | 88 | 10/07 → 12/13 | 1.598 | B | M | 4 | 16 | N12B16A, N16B16A | → 11-2012 | 82032 |
| | 90 | 09/09 → 11/13 | 1.598 | B | M | 4 | 16 | N16B16A | → 11-2012 | 82032 |
| Cooper D | 80 | 10/07 → 02/10 | 1.560 | D | M | 4 | 16 | 9HZ (DV6TED4) | | 81869 |
| | 80 | 11/06 → 09/10 | 1.560 | D | M | 4 | 16 | 9HZ (DV6TED4), W16D16 | | 81869 |
| | 82 | 06/10 → 11/13 | 1.598 | D | M | 4 | 16 | N47C16A | | 84026 NEW |
| | 82 | 02/11 → 11/13 | 1.995 | D | M | 4 | 16 | N47C20A | | 84026 NEW |
| Cooper S | 120 | 10/07 → 02/10 | 1.598 | B | M | 4 | 16 | N14B16A | → 11-2012 | 82032 |
| | 120 | 03/10 → 11/13 | 1.598 | B | M | 4 | 16 | N18B16A | → 11-2012 | 82032 |
| | 120 | 09/11 → | 1.598 | B | M | 4 | 16 | N18B16A | | 82032 |
| | 128 | 10/06 → 01/11 | 1.598 | B | M | 4 | 16 | N14B16A | → 11-2012 | 82032 |
| | 135 | 03/10 → 11/13 | 1.598 | B | M | 4 | 16 | N18B16A | → 11-2012 | 82032 |
| | 135 | 09/11 → | 1.598 | B | M | 4 | 16 | N18B16A | | 82032 |
| | 147 | 03/10 → | 1.598 | B | M | 4 | 16 | N18B16A | → 11-2012 | 82032 |
| | 147 | 01/12 → 11/13 | 1.598 | B | M | 4 | 16 | N18B16A | | 82032 |
| Cooper SD Cooper SD | 100 | 02/11 → 11/13 | 1.995 | D | M | 4 | 16 | N47C20A | | 84026 NEW |
| | 105 | 02/11 → 11/13 | 1.995 | D | M | 4 | 16 | N47C20A | | 84026 NEW |
| | 105 | 02/11 → | 1.995 | D | M | 4 | 16 | N47C20A | | 82032 |
| John Cooper Works | 141 | 10/08 → 02/10 | 1.598 | B | M | 4 | 16 | N14B16A | | 82032 |
| | 141 | 11/06 → 12/11 | 1.598 | B | M | 4 | 16 | N14B16C | → 11-2012 | 82032 |
| | 155 | 03/08 → 08/12 | 1.598 | B | M | 4 | 16 | N14B16C | | 82032 |
| | 155 | 03/08 → 11/13 | 1.598 | B | M | 4 | 16 | N14B16C | → 11-2012 | 82032 |
| | 155 | 02/12 → | 1.598 | B | M | 4 | 16 | N14B16C, N18B16C | → 11-2012 | 82032 |
| John Cooper Works GP | 160 | 09/12 → 11/13 | 1.598 | B | M | 4 | 16 | N18B16C | → 11-2012 | 82032 |
| One | 55 | 03/09 → 03/10 | 1.397 | B | M | 4 | 16 | N12B14A | → 11-2012 | 82032 |
| | 70 | 11/06 → 03/10 | 1.397 | B | M | 4 | 16 | N12B14A | → 11-2012 | 82032 |
| | 55 | 03/10 → 11/13 | 1.598 | B | M | 4 | 16 | N16B16A | → 11-2012 | 82032 |
| | 72 | 03/10 → 11/13 | 1.598 | B | M | 4 | 16 | N16B16A | → 11-2012 | 82032 |
| One D | 66 | 06/09 → 07/10 | 1.560 | D | M | 4 | 16 | 9HZ (DV6TED4) | | 81869 |
| | 66 | 07/10 → 11/13 | 1.598 | D | M | 4 | 16 | N47C16A | | 84026 NEW |

Mini III (F54, F55, F56, F57)

| | | | | | | | | | | |
|-------------------|-----|---------|-------|---|---|---|----|------------------|--|------------------|
| Cooper | 100 | 07/14 → | 1.499 | B | M | 3 | 12 | B38A15A | | 84049 NEW |
| Cooper D | 85 | 07/14 → | 1.496 | D | M | 3 | 12 | B37C15A | | 84050 NEW |
| Cooper S | 141 | 07/14 → | 1.998 | B | M | 4 | 16 | B46A20A, B48A20A | | 84049 NEW |
| | 141 | 11/15 → | 1.998 | B | M | 4 | 16 | B48A20A | | 84049 NEW |
| Cooper SD | 125 | 07/14 → | 1.995 | D | M | 4 | 16 | B47C20A | | 84051 NEW |
| John Cooper Works | 170 | 03/15 → | 1.998 | B | M | 4 | 16 | B48A20B | | 84049 NEW |
| One | 75 | 11/14 → | 1.198 | B | M | 3 | 12 | B38A12A | | 84049 NEW |
| | 75 | 11/15 → | 1.499 | B | M | 3 | 12 | B38A15A | | 84049 NEW |
| One D | 70 | 11/14 → | 1.496 | D | M | 3 | 12 | B37C15A | | 84050 NEW |
| One First | 55 | 06/14 → | 1.198 | B | M | 3 | 12 | B38A12A | | 84049 NEW |



KW



cm³



NO. OF VALVES



MINI

Mini Paceman (R61)

| | | | | | | | | | | | |
|----------------|-----|---------|-------|---|---|---|----|---------|--|-------|------------|
| Cooper D | 82 | 09/12 → | 1.598 | D | M | 4 | 16 | N47C16A | | 84026 | NEW |
| | 82 | 09/12 → | 1.995 | D | M | 4 | 16 | N47C20A | | 84026 | NEW |
| Cooper D ALL4 | 82 | 09/12 → | 1.598 | D | M | 4 | 16 | N47C16A | | 84026 | NEW |
| | 82 | 09/12 → | 1.995 | D | M | 4 | 16 | N47C20A | | 84026 | NEW |
| Cooper SD | 105 | 10/12 → | 1.995 | D | M | 4 | 16 | N47C20A | | 84026 | NEW |
| Cooper SD ALL4 | 105 | 10/12 → | 1.995 | D | M | 4 | 16 | N47C20A | | 84026 | NEW |

MITSUBISHI

ASX, Van

| | | | | | | | | | | | |
|--------------|-----|---------|-------|---|---|---|----|------|--|-------|------------|
| 1.6 | 85 | 05/10 → | 1.590 | B | M | 4 | 16 | 4A92 | | 82049 | |
| | 86 | 06/10 → | 1.590 | B | M | 4 | 16 | 4A92 | | 82049 | |
| 1.6 DI-D | 84 | 07/15 → | 1.560 | D | M | 4 | 8 | 9HD | | 81869 | |
| 1.6 DI-D 4WD | 84 | 07/15 → | 1.560 | D | M | 4 | 8 | 9HD | | 81869 | |
| 1.8 DI-D | 85 | 06/10 → | 1.798 | D | M | 4 | 16 | 4N13 | | 84042 | NEW |
| | 110 | 06/10 → | 1.798 | D | M | 4 | 16 | 4N13 | | 84042 | NEW |
| 1.8 DI-D 4WD | 85 | 06/10 → | 1.798 | D | M | 4 | 16 | 4N13 | | 84042 | NEW |
| | 110 | 06/10 → | 1.798 | D | M | 4 | 16 | 4N13 | | 84042 | NEW |
| 2.2 Di-D 4WD | 110 | 04/13 → | 2.268 | D | M | 4 | 16 | 4N14 | | 84042 | NEW |

Carisma

| | | | | | | | | | | | |
|----------|----|---------------|-------|---|---|---|---|------|--|-------|--|
| 1.9 DI-D | 85 | 09/00 → 06/06 | 1.870 | D | M | 4 | 8 | F9Q2 | | 81814 | |
| | 85 | 09/00 → 06/06 | 1.870 | D | M | 4 | 8 | F9Q2 | | 84009 | |
| | 75 | 09/00 → 06/06 | 1.870 | D | M | 4 | 8 | F9Q1 | | 81814 | |
| | 75 | 09/00 → 06/06 | 1.870 | D | M | 4 | 8 | F9Q1 | | 84009 | |
| 1.9 TD | 66 | 10/96 → 09/00 | 1.870 | D | M | 4 | 8 | F8QT | | 81574 | |

Colt III

| | | | | | | | | | | | |
|-------------|-----|---------------|-------|---|---|---|----|------------|--|-------|--|
| 1.3 | 51 | 04/88 → 05/92 | 1.299 | B | M | 4 | 8 | 4G13 (8V) | | 81784 | |
| 1.3 12V | 55 | 04/88 → 05/92 | 1.299 | B | M | 4 | 12 | 4G13 (12V) | | 81784 | |
| 1.3 GL | 44 | 04/88 → 12/90 | 1.299 | B | M | 4 | 8 | 4G13 (8V) | | 81784 | |
| 1.5 | 66 | 07/90 → 05/92 | 1.468 | B | M | 4 | 12 | 4G15 (12V) | | 81784 | |
| 1.5 GLXi | 62 | 04/88 → 05/92 | 1.468 | B | M | 4 | 8 | 4G15 | | 81784 | |
| 1.8 GTi 16V | 100 | 06/90 → 05/92 | 1.836 | B | M | 4 | 16 | 4G67 | | 81786 | |

Colt IV

| | | | | | | | | | | | |
|--------------|-----|---------------|-------|---|---|---|----|-----------------------------------|--|-------|--|
| 1.3 GLi 12V | 55 | 04/92 → 04/96 | 1.299 | B | M | 4 | 12 | 4G13 (12V) | | 81784 | |
| 1.6 4WD | 84 | 08/93 → 08/95 | 1.597 | B | M | 4 | 16 | 4G92 (SOHC16V) | | 81731 | |
| 1.6 GLXi 16V | 83 | 04/92 → 04/96 | 1.597 | B | M | 4 | 16 | 4G92 (SOHC16V) | | 81731 | |
| 1.8 GTi 16V | 103 | 04/92 → 04/96 | 1.834 | B | M | 4 | 16 | 4G93 (DOHC16V), 4G93 (SOHC16V) | | 81731 | |

Colt V

| | | | | | | | | | | | |
|---------|----|---------------|-------|---|---|---|----|------------|--|-------|--|
| 1.5 16V | 69 | 10/99 → 09/03 | 1.468 | B | M | 4 | 16 | 4G15 (16V) | | 81784 | |
|---------|----|---------------|-------|---|---|---|----|------------|--|-------|--|

Colt VI

| | | | | | | | | | | | |
|------------|----|---------------|-------|----|---|---|----|------|--|-------|--|
| 1.1 | 55 | 10/04 → 06/12 | 1.124 | B | M | 3 | 12 | 3A91 | | 82049 | |
| 1.1 Bifuel | 55 | 10/04 → 06/12 | 1.124 | BF | M | 3 | 12 | 3A91 | | 82049 | |
| 1.3 | 70 | 06/04 → 06/12 | 1.332 | B | M | 4 | 16 | 4A90 | | 82049 | |
| 1.3 Bifuel | 70 | 06/04 → 06/12 | 1.332 | BF | M | 4 | 16 | 4A90 | | 82049 | |

| | | | | | | | | | | |
|--|----|--|-----------------|--|--|--|---------------|--|--|--|
| | KW | | cm ³ | | | | NO. OF VALVES | | | |
|--|----|--|-----------------|--|--|--|---------------|--|--|--|

MITSUBISHI

Colt VI

| | | | | | | | | | | |
|----------|----|---------------|-------|---|---|---|----|-----------|--|-------|
| 1.5 | 80 | 06/04 → 06/12 | 1.499 | B | M | 4 | 16 | 4A91 | | 82049 |
| 1.5 DI-D | 50 | 08/04 → 06/12 | 1.493 | D | M | 3 | 12 | OM639.939 | | 82017 |
| | 70 | 08/04 → 06/12 | 1.493 | D | M | 3 | 12 | OM639.939 | | 82017 |

Colt VII, CZC, Plus

| | | | | | | | | | | |
|-----|----|---------------|-------|---|---|---|----|------|--|-------|
| 1.5 | 80 | 05/06 → 07/09 | 1.499 | B | M | 4 | 16 | 4A91 | | 82049 |
|-----|----|---------------|-------|---|---|---|----|------|--|-------|

Eclipse I, Cabrio

| | | | | | | | | | | |
|---------------|-----|---------------|-------|---|---|---|----|----------------|--|-------|
| 2.0 i 16V | 110 | 04/91 → 11/95 | 1.997 | B | M | 4 | 16 | 4G63 (DOHC16V) | | 81786 |
| 2.0 i 16V 4WD | 110 | 04/91 → 11/95 | 1.997 | B | M | 4 | 16 | 4G63 (DOHC16V) | | 81786 |

Eclipse II, Cabrio

| | | | | | | | | | | |
|---------------|-----|---------------|-------|---|---|---|----|-----------------|--|-------|
| 2.0 Turbo | 147 | 04/94 → 04/99 | 1.997 | B | M | 4 | 16 | 4G63T (DOHC16V) | | 81733 |
| 2.0 Turbo 4WD | 157 | 12/95 → 04/99 | 1.997 | B | M | 4 | 16 | 4G63T (DOHC16V) | | 81733 |
| | 147 | 04/94 → 04/99 | 1.997 | B | M | 4 | 16 | 4G63T (DOHC16V) | | 81733 |
| 2000 GS 16V | 107 | 12/95 → 04/99 | 1.997 | B | M | 4 | 16 | 4G63 (DOHC16V) | | 81733 |
| | 157 | 12/95 → 04/99 | 1.997 | B | M | 4 | 16 | 4G63T (DOHC16V) | | 81733 |

Galant IV, Station Wagon

| | | | | | | | | | | |
|-----------------|-----|---------------|-------|---|---|---|----|----------------|--|-------|
| 2.0 GTI 16V | 106 | 11/88 → 10/92 | 1.997 | B | M | 4 | 16 | 4G63 (DOHC16V) | | 81786 |
| | 107 | 11/88 → 10/92 | 1.997 | B | M | 4 | 16 | 4G63 (DOHC16V) | | 81786 |
| 2.0 GTi 16V 4WD | 106 | 06/88 → 10/92 | 1.997 | B | M | 4 | 16 | 4G63 (DOHC16V) | | 81786 |
| | 110 | 09/91 → 10/92 | 1.997 | B | M | 4 | 16 | 4G63 (DOHC16V) | | 81786 |
| 2.0 GTI 16V 4x4 | 106 | 07/89 → 12/92 | 1.997 | B | M | 4 | 16 | 4G63 (DOHC16V) | | 81786 |

Galant V, Station Wagon

| | | | | | | | | | | |
|----------|----|---------------|-------|---|---|---|----|----------------|-----------|-------|
| 1.8 | 85 | 02/94 → 08/96 | 1.834 | B | M | 4 | 16 | 4G93 (SOHC16V) | | 81731 |
| 1.8 GLSI | 93 | 11/92 → 08/96 | 1.834 | B | M | 4 | 16 | 4G93 (SOHC16V) | 01-1993 → | 81731 |
| | 93 | 11/92 → 08/96 | 1.834 | B | M | 4 | 16 | 4G93 (SOHC16V) | | 81731 |

Grandis II

| | | | | | | | | | | |
|----------|-----|---------|-------|---|---|---|----|-----|--|-------|
| 2.0 DI-D | 100 | 09/05 → | 1.968 | D | M | 4 | 16 | BSY | | 81816 |
| | 100 | 09/05 → | 1.968 | D | M | 4 | 16 | BSY | | 84011 |
| | 103 | 02/07 → | 1.968 | D | M | 4 | 16 | BWC | | 81816 |
| | 103 | 02/07 → | 1.968 | D | M | 4 | 16 | BWC | | 84011 |

L 200 II

| | | | | | | | | | | |
|-----------|----|---------------|-------|---|---|---|---|-----------|-----------|-------|
| 2.5 D | 51 | 11/86 → 10/96 | 2.476 | D | M | 4 | 8 | 4D56 (8V) | → 06-1996 | 81787 |
| 2.5 D 4WD | 51 | 12/87 → 05/93 | 2.476 | D | M | 4 | 8 | 4D56 (8V) | | 81787 |

L 200 III

| | | | | | | | | | | |
|-------|----|---------------|-------|---|---|---|---|-----------|--|-------|
| 2.5 D | 55 | 06/96 → 12/07 | 2.477 | D | M | 4 | 8 | 4D56 (8V) | | 81787 |
|-------|----|---------------|-------|---|---|---|---|-----------|--|-------|

L 300

| | | | | | | | | | | |
|--------|----|---------------|-------|---|---|---|---|-----------|--|-------|
| 2.5 D | 51 | 11/86 → 02/06 | 2.477 | D | M | 4 | 8 | 4D56 (8V) | | 81787 |
| 2.5 TD | 64 | 02/87 → 08/97 | 2.477 | D | M | 4 | 8 | 4D56T | | 81787 |
| | 64 | 02/87 → 05/03 | 2.477 | D | M | 4 | 8 | 4D56T | | 81787 |

L 400

| | | | | | | | | | | |
|-------------|----|---------------|-------|---|---|---|---|--------|--|-------|
| 2.5 TD | 73 | 05/95 → 05/00 | 2.477 | D | M | 4 | 8 | 4D56TD | | 81787 |
| 2.5 TD 4WD | 73 | 05/95 → 05/00 | 2.477 | D | M | 4 | 8 | 4D56TD | | 81787 |
| 2500 TD | 64 | 05/95 → 06/05 | 2.477 | D | M | 4 | 8 | 4D56T | | 81787 |
| | 64 | 09/96 → 06/05 | 2.477 | D | M | 4 | 8 | 4D56T | | 81787 |
| 2500 TD 4WD | 64 | 09/96 → 06/05 | 2.477 | D | M | 4 | 8 | 4D56T | | 81787 |

KW

cm³

NO. OF VALVES

MAGNETI MARELLI
mitsubishi
Lancer III, Station Wagon

| | | | | | | | | | | |
|---------|----|---------------|-------|---|---|---|----|------------|-----------|-------|
| 1.3 GL | 50 | 05/88 → 06/90 | 1.298 | B | M | 4 | 8 | G13B | | 81784 |
| | 55 | 07/90 → 08/92 | 1.298 | B | M | 4 | 12 | 4G13 (12V) | | 81784 |
| 1.5 | 61 | 09/88 → 12/90 | 1.468 | B | M | 4 | 8 | 4G15 | | 81784 |
| 1.5 12V | 66 | 09/90 → 12/91 | 1.468 | B | M | 4 | 12 | 4G15 (12V) | | 81784 |
| 1.5 GLS | 63 | 08/89 → 08/92 | 1.468 | B | M | 4 | 12 | 4G15 (12V) | | 81784 |
| 1.8 4WD | 69 | 08/90 → 06/92 | 1.755 | B | M | 4 | 8 | 4G37 | 01-1992 → | 81731 |

Lancer IV, Station Wagon

| | | | | | | | | | | |
|-------------|-----|---------------|-------|---|---|---|----|-----------------------------------|--|-------|
| 1.2 GL | 44 | 05/88 → 08/92 | 1.198 | B | M | 4 | 8 | 4G16 | | 81784 |
| 1.3 | 44 | 04/88 → 05/92 | 1.299 | B | M | 4 | 8 | 4G13 (8V) | | 81784 |
| | 51 | 08/88 → 05/92 | 1.299 | B | M | 4 | 8 | 4G13 (8V), G13B | | 81784 |
| 1.3 12V | 55 | 06/92 → 05/94 | 1.299 | B | M | 4 | 12 | 4G13 (12V) | | 81784 |
| 1.3 GL | 50 | 05/88 → 06/90 | 1.298 | B | M | 4 | 8 | G13B | | 81784 |
| 1.5 | 62 | 06/88 → 05/92 | 1.468 | B | M | 4 | 8 | 4G15 | | 81784 |
| | 62 | 04/88 → 05/92 | 1.468 | B | M | 4 | 12 | 4G15 (12V) | | 81784 |
| 1.5 12V | 66 | 05/89 → 05/92 | 1.468 | B | M | 4 | 12 | 4G15 (12V) | | 81784 |
| 1.5 GLS | 63 | 08/89 → 08/92 | 1.468 | B | M | 4 | 12 | 4G15 (12V) | | 81784 |
| 1.6 16V | 83 | 06/92 → 05/94 | 1.597 | B | M | 4 | 16 | 4G92 (SOHC16V) | | 81731 |
| 1.6 4WD | 84 | 06/92 → 11/93 | 1.597 | B | M | 4 | 16 | 4G92 (SOHC16V) | | 81731 |
| 1.8 GTi 16V | 103 | 06/92 → 12/93 | 1.834 | B | M | 4 | 16 | 4G93 (DOHC16V), 4G93 (SOHC16V) | | 81731 |
| | 100 | 11/89 → 05/92 | 1.836 | B | M | 4 | 16 | 4G67 | | 81786 |

Lancer V, Station Wagon, Hatchback, Coupé

| | | | | | | | | | | |
|-------------|-----|---------------|-------|---|---|---|----|----------------|-----------|-------|
| 1.3 | 55 | 06/92 → 02/95 | 1.298 | B | M | 4 | 12 | 4G13 (12V) | | 81784 |
| | 55 | 06/92 → 12/96 | 1.299 | B | M | 4 | 12 | 4G13 (12V) | | 81784 |
| 1.6 | 66 | 02/94 → 12/96 | 1.597 | B | M | 4 | 16 | 4G92 (SOHC16V) | | 81731 |
| 1.6 16V | 83 | 06/92 → 12/96 | 1.597 | B | M | 4 | 16 | 4G92 (SOHC16V) | | 81731 |
| | 83 | 12/92 → 10/03 | 1.597 | B | M | 4 | 16 | 4G92 (SOHC16V) | → 02-1996 | 81731 |
| 1.6 16V 4WD | 83 | 06/92 → 12/96 | 1.597 | B | M | 4 | 16 | 4G92 (SOHC16V) | | 81731 |
| | 83 | 12/92 → 10/03 | 1.597 | B | M | 4 | 16 | 4G92 (SOHC16V) | → 02-1996 | 81731 |
| 1.8 16V | 103 | 06/92 → 12/93 | 1.834 | B | M | 4 | 16 | 4G93 (DOHC16V) | | 81731 |

Lancer VI, Station Wagon, Hatchback, Coupé, Cabrio

| | | | | | | | | | | |
|---------|----|---------------|-------|---|---|---|----|------------|--|-------|
| 1.5 16V | 69 | 10/99 → 08/03 | 1.468 | B | M | 4 | 16 | 4G15 (16V) | | 81784 |
|---------|----|---------------|-------|---|---|---|----|------------|--|-------|

Lancer VIII, Station Wagon, Sportback

| | | | | | | | | | | |
|----------|-----|---------|-------|---|---|---|----|----------|--|------------------|
| 1.5 | 80 | 06/08 → | 1.499 | B | M | 4 | 16 | 4A91 | | 82049 |
| 2.0 DI-D | 103 | 06/08 → | 1.968 | D | M | 4 | 16 | BKD, BWC | | 81816 |
| | 103 | 06/08 → | 1.968 | D | M | 4 | 16 | BKD, BWC | | 84011 NEW |

Outlander II, Van

| | | | | | | | | | | |
|--------------|-----|---------------|-------|---|---|---|----|----------|--|------------------|
| 2.0 DI-D | 103 | 02/07 → 11/12 | 1.968 | D | M | 4 | 16 | BSY | | 81816 |
| | 103 | 02/07 → 11/12 | 1.968 | D | M | 4 | 16 | BSY | | 84011 NEW |
| | 130 | 11/06 → 11/12 | 2.268 | D | M | 4 | 16 | 4N14 | | 84042 NEW |
| 2.2 DI-D 4WD | 115 | 08/07 → 11/12 | 2.179 | D | M | 4 | 16 | 4HK, 4HN | | 82068 |
| | 103 | 09/10 → 11/12 | 2.268 | D | M | 4 | 16 | 4N14 | | 84042 NEW |
| | 130 | 11/06 → 11/12 | 2.268 | D | M | 4 | 16 | 4N14 | | 84042 NEW |

| | | | | | | | | | |
|--|--|--|--|--|--|--|--|--|--|
| | | | | | | | | | |
|--|--|--|--|--|--|--|--|--|--|

MITSUBISHI

Outlander III, Van

| | | | | | | | | | | |
|--------------|-----|---------|-------|---|---|---|----|------|-------|--|
| 2.2 Di-D | 110 | 08/12 → | 2.268 | D | M | 4 | 16 | 4N14 | 84042 | |
| 2.2 Di-D 4WD | 110 | 08/12 → | 2.268 | D | M | 4 | 16 | 4N14 | 84042 | |

Pajero I

| | | | | | | | | | |
|--------|----|---------------|-------|---|---|---|---|-------|-------|
| 2.5 TD | 64 | 01/90 → 12/91 | 2.477 | D | M | 4 | 8 | 4D56T | 81787 |
| | 70 | 11/89 → 11/90 | 2.477 | D | M | 4 | 8 | 4D56T | 81787 |

Santamo

| | | | | | | | | | |
|-------------|-----|---------------|-------|---|---|---|----|----------------|-------|
| 2.0 16V | 102 | 05/99 → 12/04 | 1.997 | B | M | 4 | 16 | 4G63 (DOHC16V) | 81786 |
| 2.0 16V 4WD | 102 | 05/99 → 12/04 | 1.997 | B | M | 4 | 16 | 4G63 (DOHC16V) | 81786 |

Space Runner I

| | | | | | | | | | |
|---------|----|---------------|-------|---|---|---|----|----------------|-------|
| 1.8 | 85 | 06/96 → 08/99 | 1.834 | B | M | 4 | 16 | 4G93 (SOHC16V) | 81731 |
| | 90 | 10/91 → 08/99 | 1.834 | B | M | 4 | 16 | 4G93 (SOHC16V) | 81731 |
| 1.8 4WD | 85 | 06/96 → 08/99 | 1.834 | B | M | 4 | 16 | 4G93 (SOHC16V) | 81731 |
| | 90 | 10/91 → 08/99 | 1.834 | B | M | 4 | 16 | 4G93 (SOHC16V) | 81731 |

Space Star

| | | | | | | | | | |
|----------|----|---------------|-------|---|---|---|----|------------|-------|
| 1.3 16V | 60 | 09/00 → 12/04 | 1.299 | B | M | 4 | 16 | 4G13 (16V) | 81784 |
| | 61 | 12/98 → 12/04 | 1.299 | B | M | 4 | 16 | 4G13 (16V) | 81784 |
| | 63 | 06/98 → 12/04 | 1.299 | B | M | 4 | 16 | 4G13 (16V) | 81784 |
| 1.9 Di-D | 85 | 10/02 → 12/04 | 1.870 | D | M | 4 | 8 | F9Q2 | 81814 |
| | 85 | 10/02 → 12/04 | 1.870 | D | M | 4 | 8 | F9Q2 | 84009 |
| | 75 | 02/01 → 12/04 | 1.870 | D | M | 4 | 8 | F9Q1 | 81814 |
| | 75 | 02/01 → 12/04 | 1.870 | D | M | 4 | 8 | F9Q1 | 84009 |

Space Wagon II

| | | | | | | | | | |
|---------|----|---------------|-------|---|---|---|----|----------------|-------|
| 1.8 | 90 | 10/91 → 10/98 | 1.834 | B | M | 4 | 16 | 4G93 (SOHC16V) | 81731 |
| 1.8 4WD | 90 | 10/91 → 10/98 | 1.834 | B | M | 4 | 16 | 4G93 (SOHC16V) | 81731 |

NISSAN

100 NX

| | | | | | | | | | |
|---------|-----|---------------|-------|---|---|---|----|--------|-------|
| 1.6 | 66 | 03/90 → 10/94 | 1.597 | B | M | 4 | 16 | GA16DS | 81744 |
| 1.6 SR | 75 | 09/93 → 10/94 | 1.597 | B | M | 4 | 16 | GA16DE | 81744 |
| 2.0 | 110 | 10/90 → 10/94 | 1.998 | B | M | 4 | 16 | SR20DE | 81736 |
| 2.0 GTI | 105 | 03/91 → 10/94 | 1.998 | B | M | 4 | 16 | SR20DE | 81736 |

200 SX III

| | | | | | | | | | |
|-----------|-----|---------------|-------|---|---|---|----|--------|-------|
| 2.0 i 16V | 118 | 10/93 → 12/99 | 1.998 | B | M | 4 | 16 | SR20DE | 81736 |
|-----------|-----|---------------|-------|---|---|---|----|--------|-------|

Almera I, Hatchback

| | | | | | | | | | |
|-------------|-----|---------------|-------|---|---|---|----|--------|-------|
| 1.4 | 64 | 09/95 → 07/00 | 1.392 | B | M | 4 | 16 | GA14DE | 81744 |
| 1.4 GX,LX | 55 | 09/95 → 07/00 | 1.392 | B | M | 4 | 16 | GA14DE | 81744 |
| 1.4 S,GX,LX | 55 | 09/95 → 03/00 | 1.392 | B | M | 4 | 16 | GA14DE | 81744 |
| 1.6 | 73 | 09/95 → 07/00 | 1.597 | B | M | 4 | 16 | GA16DE | 81744 |
| 1.6 SLX | 66 | 09/95 → 07/00 | 1.597 | B | M | 4 | 16 | GA16DE | 81744 |
| 1.6 SR,SLX | 66 | 09/95 → 03/00 | 1.597 | B | M | 4 | 16 | GA16DE | 81744 |
| 2.0 D | 55 | 11/95 → 03/00 | 1.974 | D | M | 4 | 8 | CD20 | 81745 |
| | 55 | 11/95 → 07/00 | 1.974 | D | M | 4 | 8 | CD20 | 81736 |
| 2.0 GTi | 105 | 07/96 → 03/00 | 1.998 | B | M | 4 | 16 | SR20DE | 81736 |

KW

cm³

NO. OF VALVES

NISSAN
Almera II, Hatchback

| | | | | | | | | | | |
|---------|-----|---------|-------|---|---|---|----|----------------|--|-------|
| 1.5 | 72 | 10/02 → | 1.497 | B | M | 4 | 16 | QG15DE | | 82028 |
| | 66 | 07/00 → | 1.498 | B | M | 4 | 16 | QG15DE | | 82028 |
| | 77 | 03/01 → | 1.498 | B | M | 4 | 16 | GA15DE, QG15DE | | 82028 |
| 1.5 dCi | 60 | 01/03 → | 1.461 | D | M | 4 | 8 | K9K722 | | 81810 |
| 1.5 XL | 77 | 03/01 → | 1.498 | B | M | 4 | 16 | QG15DE | | 82028 |
| 1.8 | 84 | 07/00 → | 1.769 | B | M | 4 | 16 | QG18DE | | 82028 |
| | 85 | 10/02 → | 1.769 | B | M | 4 | 16 | QG18DE | | 82028 |
| 2.2 dCi | 82 | 09/03 → | 2.184 | D | M | 4 | 16 | YD22DDT | | 82023 |
| | 100 | 09/03 → | 2.184 | D | M | 4 | 16 | YD22DDTi | | 82023 |
| 2.2 Di | 81 | 07/00 → | 2.184 | D | M | 4 | 16 | YD22DDT | | 82023 |

Almera Tino

| | | | | | | | | | | |
|---------|-----|---------|-------|---|---|---|----|----------|--|-------|
| 1.8 | 84 | 08/00 → | 1.769 | B | M | 4 | 16 | QG18DE | | 82028 |
| | 85 | 12/02 → | 1.769 | B | M | 4 | 16 | QG18DE | | 82028 |
| 2.0 | 100 | 08/00 → | 1.998 | B | A | 4 | 16 | SR20DE | | 81736 |
| 2.2 dCi | 82 | 09/03 → | 2.184 | D | M | 4 | 16 | YD22DDT | | 82023 |
| | 100 | 09/03 → | 2.184 | D | M | 4 | 16 | YD22DDTi | | 82023 |
| 2.2 Di | 84 | 08/00 → | 2.184 | D | M | 4 | 16 | YD22DDTi | | 82023 |

Cube III

| | | | | | | | | | | |
|---------|----|---------|-------|---|---|---|----|-------------|--|-------|
| 1.5 dCi | 78 | 03/10 → | 1.461 | D | M | 4 | 8 | K9K, K9K270 | | 82098 |
| | 81 | 03/10 → | 1.461 | D | M | 4 | 8 | K9K, K9K270 | | 82098 |
| 1.6 16V | 81 | 03/10 → | 1.598 | B | M | 4 | 16 | HR16DE | | 84003 |

Interstar

| | | | | | | | | | | |
|--------|----|---------|-------|---|---|---|----|--------|--|-------|
| dCi 80 | 60 | 07/02 → | 1.870 | D | M | 4 | 8 | F9Q772 | | 81814 |
| | 60 | 07/02 → | 1.870 | D | M | 4 | 8 | F9Q772 | | 84009 |
| dCi 90 | 66 | 07/02 → | 2.188 | D | M | 4 | 16 | G9T722 | | 81855 |

Juke

| | | | | | | | | | | |
|-----------|----|---------|-------|---|---|---|----|----------------|--|-------|
| 1.2 DIG-T | 85 | 05/14 → | 1.197 | B | M | 4 | 16 | HR12DDT | | 84003 |
| 1.5 dCi | 81 | 06/10 → | 1.461 | D | M | 4 | 8 | K9K636, K9K896 | | 82098 |
| 1.6 | 69 | 01/13 → | 1.598 | B | M | 4 | 16 | HR16DE | | 84003 |
| | 86 | 06/10 → | 1.598 | B | M | 4 | 16 | HR16DE | | 84003 |

Kubistar

| | | | | | | | | | | |
|------------|----|---------------|-------|---|---|---|----|----------------|--|-------|
| 1.2 | 44 | 08/03 → 10/09 | 1.149 | B | M | 4 | 8 | D7F764 | | 81762 |
| 1.2 16V | 55 | 04/06 → 10/09 | 1.149 | B | M | 4 | 16 | D4F712 | | 81820 |
| 1.5 dCi | 42 | 08/03 → 10/09 | 1.461 | D | M | 4 | 8 | K9K710, K9K714 | | 81810 |
| | 45 | 08/05 → 10/09 | 1.461 | D | M | 4 | 8 | K9K710, K9K714 | | 81810 |
| | 48 | 08/03 → 10/09 | 1.461 | D | M | 4 | 8 | K9K704 | | 81810 |
| | 60 | 08/03 → 10/09 | 1.461 | D | M | 4 | 8 | K9K722 | | 81810 |
| 1.5 dCi 70 | 50 | 04/06 → 10/09 | 1.461 | D | M | 4 | 8 | K9K700, K9K716 | | 84007 |
| 1.5 dCi 85 | 62 | 04/06 → 10/09 | 1.461 | D | M | 4 | 8 | K9K276 | | 84007 |
| 1.6 16V | 70 | 08/03 → 10/09 | 1.598 | B | M | 4 | 16 | K4M752 | | 84039 |
| | 70 | 08/03 → 10/09 | 1.598 | B | M | 4 | 16 | K4M752 | | 81806 |

NEW

KW

cm³

NO. OF VALVES

MAGNETI MARELLI
NISSAN
Micra I (K10)

| | | | | | | | | | | |
|-----|----|---------------|-------|---|---|---|---|-------|----------------------------|-------|
| 1.0 | 43 | 12/82 → 05/91 | 988 | B | M | 4 | 8 | | 01-1989 →, M →: 945.693 | 81743 |
| 1.2 | 40 | 07/86 → 07/92 | 1.235 | B | M | 4 | 8 | MA12S | 01-1989 →, M →: 945.693 | 81743 |
| | 44 | 07/86 → 07/92 | 1.235 | B | M | 4 | 8 | MA12S | 01-1989 →, M →: 945.693 | 81743 |

Micra II (K11)

| | | | | | | | | | | |
|-----------|----|---------------|-------|---|---|---|----|--------|--|-------|
| 1.0 i 16V | 40 | 08/92 → 09/00 | 998 | B | M | 4 | 16 | CG10DE | | 81742 |
| | 44 | 09/00 → 02/03 | 998 | B | M | 4 | 16 | CG10DE | | 81742 |
| 1.3 i 16V | 55 | 08/92 → 09/00 | 1.275 | B | M | 4 | 16 | CG13DE | | 81742 |
| 1.4 i 16V | 60 | 09/00 → 02/03 | 1.348 | B | M | 4 | 16 | CGA3DE | | 81742 |
| 1.5 D | 42 | 02/98 → 02/03 | 1.527 | D | M | 4 | 8 | TD15 | | 81513 |

Micra III (K12), C+C

| | | | | | | | | | | |
|------------|----|---------------|-------|---|---|---|----|----------------|--|-------|
| 1.0 16V | 48 | 01/03 → 06/10 | 998 | B | M | 4 | 16 | CG10DE | | 82014 |
| 1.2 16V | 48 | 01/03 → 06/10 | 1.240 | B | M | 4 | 16 | CG12DE, CR12DE | | 82014 |
| | 59 | 01/03 → 06/10 | 1.240 | B | M | 4 | 16 | CG12DE, CR12DE | | 82014 |
| 1.4 16V | 65 | 08/05 → | 1.386 | B | M | 4 | 16 | CR14DE | | 82014 |
| 1.5 dCi | 48 | 01/03 → 06/10 | 1.461 | D | M | 4 | 8 | K9K704 | | 81810 |
| | 50 | 06/05 → 06/10 | 1.461 | D | M | 4 | 8 | K9K708 | | 84007 |
| | 60 | 09/03 → 06/10 | 1.461 | D | M | 4 | 8 | K9K722 | | 81810 |
| | 63 | 06/05 → 06/10 | 1.461 | D | M | 4 | 8 | K9K276 | | 84007 |
| 1.6 160 SR | 81 | 08/05 → | 1.598 | B | M | 4 | 16 | HR16DE | | 84003 |
| 160 SR | 81 | 05/05 → 06/10 | 1.598 | B | M | 4 | 16 | HR16DE | | 82014 |

Micra IV (K13)

| | | | | | | | | | | |
|---------|----|---------|-------|---|---|---|----|---------|--|-------|
| 1.2 | 56 | 05/10 → | 1.198 | B | M | 3 | 12 | HR12DE | | 84003 |
| | 59 | 05/10 → | 1.198 | B | M | 3 | 12 | HR12DE | | 84003 |
| 1.2 DIG | 72 | 04/11 → | 1.198 | B | M | 3 | 12 | HR12DDR | | 84003 |

Note I

| | | | | | | | | | | |
|---------|----|---------|-------|---|---|---|----|--------|--|-------|
| 1.4 | 65 | 03/06 → | 1.386 | B | M | 4 | 16 | CR14DE | | 82014 |
| 1.5 dCi | 50 | 03/06 → | 1.461 | D | M | 4 | 8 | K9K700 | | 84007 |
| | 63 | 03/06 → | 1.461 | D | M | 4 | 8 | K9K276 | | 84007 |
| | 66 | 09/10 → | 1.461 | D | M | 4 | 8 | K9K276 | | 84007 |
| | 76 | 07/08 → | 1.461 | D | M | 4 | 16 | K9K292 | | 84007 |
| 1.6 | 81 | 03/06 → | 1.598 | B | M | 4 | 16 | HR16DE | | 84003 |

Note II

| | | | | | | | | | | |
|---------|----|---------|-------|---|---|---|----|---------|--|-------|
| 1.2 | 59 | 06/13 → | 1.198 | B | M | 3 | 12 | HR12DE | | 84003 |
| 1.2 DIG | 72 | 06/13 → | 1.198 | B | M | 3 | 12 | HR12DDR | | 84003 |
| 1.2 LPG | 56 | 03/15 → | 1.198 | | M | 3 | 12 | HR12DE | | 84003 |
| 1.5 dCi | 66 | 06/13 → | 1.461 | D | M | 4 | 8 | K9K892 | | 82098 |

NV 200 Evalia, Box

| | | | | | | | | | | |
|---------|----|---------|-------|---|---|---|---|---------------------------|--|-------|
| 1.5 dci | 63 | 07/10 → | 1.461 | D | M | 4 | 8 | K9K400, K9K608, K9K628 | | 84007 |
| | 66 | 04/11 → | 1.461 | D | M | 4 | 8 | K9K892 | | 84007 |
| | 81 | 04/11 → | 1.461 | D | M | 4 | 8 | K9K636, K9K646 | | 84007 |

KW

cm³

NO. OF VALVES

NISSAN
Pixo

| | | | | | | | | | | | |
|-----|----|---------|-----|---|---|---|----|------|--|-------|------------|
| 1.0 | 50 | 06/09 → | 996 | B | M | 3 | 12 | K10B | | 84017 | NEW |
|-----|----|---------|-----|---|---|---|----|------|--|-------|------------|

Primastar

| | | | | | | | | | | |
|---------|----|---------|-------|---|---|---|----|----------------|--|-------|
| 2.0 | 88 | 02/03 → | 1.998 | B | M | 4 | 16 | F4R720 | | 81814 |
| | 88 | 02/03 → | 1.998 | B | M | 4 | 16 | F4R720 | | 84009 |
| | 88 | 03/01 → | 1.998 | B | M | 4 | 16 | F4R720, F4R722 | | 81814 |
| | 88 | 03/01 → | 1.998 | B | M | 4 | 16 | F4R720, F4R722 | | 84009 |
| dCi 100 | 74 | 03/01 → | 1.870 | D | M | 4 | 8 | F9Q760 | | 81814 |
| | 74 | 03/01 → | 1.870 | D | M | 4 | 8 | F9Q760 | | 84009 |
| dCi 120 | 84 | 09/06 → | 1.995 | D | M | 4 | 16 | M9R780 | | 82069 |
| dCi 140 | 99 | 07/03 → | 2.463 | D | M | 4 | 16 | G9U730 | | 81855 |
| dCi 80 | 60 | 03/01 → | 1.870 | D | M | 4 | 8 | F9Q762 | | 81814 |
| | 60 | 03/01 → | 1.870 | D | M | 4 | 8 | F9Q762 | | 84009 |
| dCi 90 | 66 | 09/06 → | 1.995 | D | M | 4 | 16 | M9R782 | | 82069 |

Primera I, Hatchback, Station Wagon

| | | | | | | | | | | |
|-------------|-----|---------------|-------|---|---|---|----|--------|--|-------|
| 1.6 | 66 | 06/90 → 01/96 | 1.597 | B | M | 4 | 16 | GA16DS | | 81744 |
| | 71 | 06/90 → 01/96 | 1.597 | B | M | 4 | 16 | GA16DS | | 81744 |
| | 75 | 06/93 → 01/96 | 1.597 | B | M | 4 | 16 | GA16DE | | 81744 |
| 1.6 i | 66 | 07/90 → 03/98 | 1.597 | B | M | 4 | 16 | GA16DS | | 81744 |
| | 75 | 02/91 → 03/98 | 1.597 | B | M | 4 | 16 | GA16DE | | 81744 |
| 2.0 | 105 | 06/90 → 04/93 | 1.998 | B | M | 4 | 16 | SR20DE | | 81736 |
| | 110 | 06/90 → 01/96 | 1.998 | B | M | 4 | 16 | SR20DE | | 81736 |
| 2.0 16V | 85 | 06/90 → 01/96 | 1.998 | B | M | 4 | 16 | SR20DI | | 81736 |
| 2.0 16V 4x4 | 85 | 04/91 → 06/96 | 1.998 | B | M | 4 | 16 | SR20DI | | 81736 |
| 2.0 D | 55 | 01/91 → 01/96 | 1.974 | D | M | 4 | 8 | CD20 | | 81745 |
| 2.0 GT | 110 | 06/90 → 01/96 | 1.998 | B | M | 4 | 16 | SR20DE | | 81736 |
| 2.0 GT 4x4 | 105 | 03/91 → 04/93 | 1.998 | B | M | 4 | 16 | SR20DE | | 81736 |
| 2.0 i | 85 | 07/90 → 03/98 | 1.998 | B | M | 4 | 16 | SR20DI | | 81736 |
| | 92 | 01/95 → 06/96 | 1.998 | B | M | 4 | 16 | SR20DE | | 81736 |

Primera II, Hatchback, Station Wagon

| | | | | | | | | | | |
|---------|-----|---------------|-------|---|---|---|----|--------|--|-------|
| 1.6 16V | 66 | 09/96 → 12/01 | 1.597 | B | M | 4 | 16 | GA16DE | | 81744 |
| | 73 | 09/96 → 10/00 | 1.597 | B | M | 4 | 16 | GA16DE | | 81744 |
| | 78 | 06/96 → 12/01 | 1.597 | B | M | 4 | 16 | QG16DE | | 81744 |
| | 80 | 04/98 → 12/01 | 1.597 | B | M | 4 | 16 | QG16DE | | 81744 |
| 1.8 16V | 84 | 08/99 → 12/01 | 1.769 | B | M | 4 | 16 | QG18DE | | 82028 |
| 2.0 16V | 85 | 09/96 → 12/01 | 1.998 | B | M | 4 | 16 | SR20De | | 81736 |
| | 96 | 09/96 → 12/01 | 1.998 | B | M | 4 | 16 | SR20DE | | 81736 |
| | 103 | 08/99 → 12/01 | 1.998 | B | M | 4 | 16 | SR20DE | | 81736 |
| | 110 | 09/96 → 12/01 | 1.998 | B | M | 4 | 16 | SR20DE | | 81736 |
| 2.0 TD | 66 | 09/96 → 12/01 | 1.974 | D | M | 4 | 8 | CD20T | | 81745 |

Primera III, Hatchback, Station Wagon

| | | | | | | | | | | |
|-----------|----|---------|-------|---|---|---|----|--------|--|-------|
| 1.6 | 78 | 03/02 → | 1.597 | B | M | 4 | 16 | QG16DE | | 82028 |
| 1.6 Visia | 80 | 01/02 → | 1.597 | B | M | 4 | 16 | QG16DE | | 82028 |
| 1.8 | 85 | 03/02 → | 1.769 | B | M | 4 | 16 | QG18DE | | 82028 |



KW



cm³



NO. OF VALVES



NISSAN

Primera III, Hatchback, Station Wagon

| | | | | | | | | | | |
|---------|-----|---------|-------|---|---|---|----|---------|--|------------------|
| 1.9 dCi | 88 | 04/03 → | 1.870 | D | M | 4 | 8 | F9Q | | 81868 |
| | 88 | 04/03 → | 1.870 | D | M | 4 | 8 | F9Q | | 84006 |
| 2.0 | 103 | 03/02 → | 1.998 | B | M | 4 | 16 | QR20DE | | 84061 NEW |
| 2.2 dCi | 102 | 04/03 → | 2.184 | D | M | 4 | 16 | YD22DDT | | 82023 |
| 2.2 Di | 93 | 03/02 → | 2.184 | D | M | 4 | 16 | YD22DDT | | 82023 |

Pulsar

| | | | | | | | | | | |
|-----------|----|---------|-------|---|---|---|----|---------|--|-------|
| 1.2 DIG-T | 85 | 10/14 → | 1.197 | B | M | 4 | 16 | HR12DDT | | 84003 |
| 1.5 dCi | 81 | 10/14 → | 1.461 | D | M | 4 | 8 | K9K | | 82098 |

Qashqai I

| | | | | | | | | | | |
|----------------------------|-----|---------|-------|---|---|---|----|----------------|--|------------------|
| 1.5 dCi | 76 | 07/08 → | 1.461 | D | M | 4 | 8 | K9K410 | | 84007 |
| | 78 | 02/07 → | 1.461 | D | M | 4 | 8 | K9K732, K9K764 | | 84007 |
| | 81 | 11/10 → | 1.461 | D | M | 4 | 8 | K9K430 | | 84007 |
| 1.6 | 84 | 02/07 → | 1.598 | B | M | 4 | 16 | HR16DE | | 84003 |
| | 86 | 11/10 → | 1.598 | B | M | 4 | 16 | HR16DE | | 84003 |
| 1.6 dCi | 96 | 10/11 → | 1.598 | D | M | 4 | 16 | R9M | | 84034 NEW |
| 1.6 dCi Trazione integrale | 96 | 10/11 → | 1.598 | D | M | 4 | 16 | R9M | | 84034 NEW |
| 2.0 dCi | 110 | 02/07 → | 1.995 | D | M | 4 | 16 | M1D, M9R | | 82069 |
| 2.0 dCi Trazione integrale | 110 | 02/07 → | 1.995 | D | M | 4 | 16 | M1D, M9R | | 82069 |

Qashqai II

| | | | | | | | | | | |
|-------------|----|---------|-------|---|---|---|----|---------|--|------------------|
| 1.2 DIG-T | 85 | 11/13 → | 1.197 | B | M | 4 | 16 | HR12DDT | | 84003 |
| 1.5 dCi | 81 | 11/13 → | 1.461 | D | M | 4 | 8 | K9K636 | | 82098 |
| 1.6 dCi | 96 | 11/13 → | 1.598 | D | M | 4 | 16 | R9M | | 84034 NEW |
| 1.6 dCi 4x4 | 96 | 11/13 → | 1.598 | D | M | 4 | 16 | R9M | | 84034 NEW |

Sentra VII

| | | | | | | | | | | |
|-----|----|---------|-------|---|---|---|----|--------|--|-------|
| 1.6 | 86 | 08/14 → | 1.598 | B | M | 4 | 16 | HR16DE | | 84003 |
|-----|----|---------|-------|---|---|---|----|--------|--|-------|

Serena I

| | | | | | | | | | | |
|---------|----|---------------|-------|---|---|---|----|--------|--|-------|
| 1.6 | 75 | 10/94 → 08/00 | 1.597 | B | M | 4 | 16 | GA16DE | | 81744 |
| 1.6 16V | 71 | 02/93 → 09/01 | 1.597 | B | M | 4 | 16 | GA16DE | | 81744 |
| 2.0 16V | 93 | 11/92 → 09/01 | 1.998 | B | M | 4 | 16 | SR20DE | | 81736 |
| 2.0 D | 49 | 11/92 → 09/01 | 1.952 | D | M | 4 | 8 | LD20 | | 82054 |
| 2.3 D | 55 | 01/95 → 09/01 | 2.283 | D | M | 4 | 8 | LD23 | | 82053 |

Sunny III

| | | | | | | | | | | |
|---------------|----|---------------|-------|---|---|---|----|-------------------------|--|-------|
| 1.4 | 60 | 10/90 → 06/95 | 1.392 | B | M | 4 | 16 | GA14DS | | 81744 |
| 1.4 i | 55 | 10/90 → 05/95 | 1.392 | B | M | 4 | 16 | GA14DE, GA14DS | | 81744 |
| 1.4 i 16V | 64 | 10/90 → 06/95 | 1.392 | B | M | 4 | 16 | GA14DE | | 81744 |
| 1.6 16V 4x4 | 66 | 11/90 → 05/95 | 1.597 | B | M | 4 | 16 | GA16DS | | 81744 |
| 1.6 i | 66 | 10/90 → 05/95 | 1.597 | B | M | 4 | 16 | GA16DE, GA16DEL, GA16DS | | 81744 |
| | 66 | 06/91 → 03/00 | 1.597 | B | M | 4 | 16 | GA16DE, GA16DS | | 81744 |
| 1.6 i 16V | 66 | 10/92 → 03/00 | 1.597 | B | M | 4 | 16 | GA16DE | | 81744 |
| 1.6 i 16V | 75 | 10/92 → 05/95 | 1.597 | B | M | 4 | 16 | GA16DE | | 81744 |
| 1.6 i 16V 4WD | 66 | 10/90 → 05/95 | 1.597 | B | M | 4 | 16 | GA16DS | | 81744 |

KW

cm³

NO. OF VALVES

MAGNETI MARELLI
NISSAN
Sunny III

| | | | | | | | | | | |
|---------------|-----|---------------|-------|---|---|---|----|---------|--|-------|
| 1.6 i 16V 4x4 | 75 | 10/92 → 05/95 | 1.597 | B | M | 4 | 16 | GA16DE | | 81744 |
| 1.6 L | 75 | 11/92 → 04/96 | 1.597 | B | M | 4 | 16 | GA16DE | | 81744 |
| 1.6 SR 4x4 | 66 | 01/92 → 06/95 | 1.598 | B | M | 4 | 16 | GA16DEL | | 81744 |
| 2.0 D | 55 | 10/90 → 05/95 | 1.974 | D | M | 4 | 8 | CD20 | | 81745 |
| 2.0 GTI 16V | 105 | 10/90 → 05/95 | 1.998 | B | M | 4 | 16 | SR20DE | | 81736 |
| 2.0 GTI-R 4x4 | 162 | 10/90 → 05/95 | 1.998 | B | M | 4 | 16 | SR20DET | | 81736 |
| 2.0 i 16V | 105 | 10/90 → 05/95 | 1.998 | B | M | 4 | 16 | SR20DE | | 81736 |

Tiida II

| | | | | | | | | | | |
|---------|----|---------|-------|---|---|---|----|--------|--|-------|
| 1.5 dCi | 78 | 09/07 → | 1.461 | D | M | 4 | 8 | K9K | | 84007 |
| | 78 | 09/07 → | 1.461 | D | M | 4 | 8 | K9K728 | | 84007 |
| 1.6 | 81 | 09/07 → | 1.598 | B | M | 4 | 16 | HR16DE | | 84003 |

Vanette II

| | | | | | | | | | | |
|-------|----|---------------|-------|---|---|---|---|--------|--|-------|
| 2.0 D | 49 | 07/91 → 01/95 | 1.952 | D | M | 4 | 8 | LD20II | | 82054 |
| | 47 | 10/86 → 12/95 | 1.952 | D | M | 4 | 8 | LD20 | | 82054 |
| | 49 | 10/86 → 12/95 | 1.952 | D | M | 4 | 8 | LD20 | | 82054 |

Vanette III Cargo

| | | | | | | | | | | |
|-------|----|---------|-------|---|---|---|----|--------|--|-------|
| 1.6 i | 71 | 01/95 → | 1.597 | B | M | 4 | 16 | GA16DE | | 81744 |
| | 72 | 01/96 → | 1.597 | B | M | 4 | 16 | GA16DE | | 81744 |
| 2.0 D | 49 | 01/96 → | 1.952 | D | M | 4 | 8 | LD20 | | 82054 |
| 2.3 D | 55 | 01/96 → | 2.283 | D | M | 4 | 8 | LD23 | | 82053 |

X-Trail I

| | | | | | | | | | | | |
|-------------|-----|---------------|-------|---|---|---|----|----------|--|-------|------------|
| 2.0 | 103 | 07/01 → 01/13 | 1.998 | B | M | 4 | 16 | QR20DE | | 84061 | NEW |
| | 110 | 09/01 → 01/13 | 1.998 | B | M | 4 | 16 | QR20DE | | 84061 | NEW |
| 2.0 4x4 | 103 | 07/01 → 01/13 | 1.998 | B | M | 4 | 16 | QR20DE | | 84061 | NEW |
| | 110 | 09/01 → 01/13 | 1.998 | B | M | 4 | 16 | QR20DE | | 84061 | NEW |
| | 206 | 06/01 → 01/13 | 1.998 | B | M | 4 | 16 | SR20VET | | 84061 | NEW |
| 2.2 dCi | 84 | 10/04 → 01/13 | 2.184 | D | M | 4 | 16 | YD22DDTi | | 82023 | |
| | 100 | 12/03 → 01/13 | 2.184 | D | M | 4 | 16 | YD22DDTi | | 82023 | |
| 2.2 dCi 4x4 | 100 | 12/03 → 01/13 | 2.184 | D | M | 4 | 16 | YD22DDTi | | 82023 | |
| 2.2 DCi FWD | 84 | 06/01 → 09/03 | 2.184 | D | M | 4 | 16 | YD22DDTi | | 82023 | |
| 2.2 Di 4x4 | 84 | 07/01 → 10/05 | 2.184 | D | M | 4 | 16 | YD22ETI | | 82023 | |
| 2.5 4x4 | 121 | 09/02 → 01/13 | 2.488 | B | M | 4 | 16 | QR25DE | | 84061 | NEW |
| | 132 | 11/02 → 01/13 | 2.488 | B | M | 4 | 16 | QR25DE | | 84061 | NEW |

X-Trail II

| | | | | | | | | | | | |
|-------------|-----|---------------|-------|---|---|---|----|--------|--|-------|------------|
| 2.0 dCi | 110 | 06/07 → 11/13 | 1.995 | D | M | 4 | 16 | M9R | | 82069 | |
| | 127 | 06/07 → 11/13 | 1.995 | D | M | 4 | 16 | M9R760 | | 82069 | |
| 2.0 dCi FWD | 110 | 06/07 → 11/13 | 1.995 | D | M | 4 | 16 | M9R | | 82069 | |
| 2.5 4x4 | 124 | 06/07 → 11/13 | 2.488 | B | M | 4 | 16 | QR25DE | | 84061 | NEW |

X-Trail III

| | | | | | | | | | | | |
|-------------|----|---------|-------|---|---|---|----|-----|--|-------|------------|
| 1.6 dCi | 96 | 12/13 → | 1.598 | D | M | 4 | 16 | R9M | | 84034 | NEW |
| 1.6 dCi 4x4 | 96 | 12/13 → | 1.598 | D | M | 4 | 16 | R9M | | 84034 | NEW |

KW

cm³

NO. OF VALVES

OPEL
Adam

| | | | | | | | | | | | |
|---------|-----|---------|-------|---|---|---|----|----------------|--|-------|------------|
| 1.2 | 51 | 10/12 → | 1.229 | B | M | 4 | 16 | A12XEL, B12XEL | | 84027 | NEW |
| 1.4 | 64 | 10/12 → | 1.398 | B | M | 4 | 16 | A14XEL, B14XEL | | 84027 | NEW |
| | 74 | 10/12 → | 1.398 | B | M | 4 | 16 | A14XER, B14XER | | 84027 | NEW |
| 1.4 LPG | 64 | 07/13 → | 1.398 | | M | 4 | 16 | A14XEL, B14XEL | | 84027 | NEW |
| 1.4 S | 110 | 11/14 → | 1.364 | B | M | 4 | 16 | B14NEH | | 84027 | NEW |

Agila A

| | | | | | | | | | | | |
|------------------|----|---------------|-------|---|---|---|----|--------|--|-------|--|
| 1.0 | 44 | 08/03 → 12/07 | 998 | B | M | 3 | 12 | Z10XEP | | 82011 | |
| 1.0 12V | 43 | 09/00 → 12/07 | 973 | B | M | 3 | 12 | Z10XE | | 81749 | |
| 1.2 16V | 55 | 09/00 → 12/07 | 1.199 | B | M | 4 | 16 | Z12XE | | 81749 | |
| 1.2 16V Twinport | 59 | 07/04 → 12/07 | 1.229 | B | M | 4 | 16 | Z12XEP | | 82011 | |
| 1.3 CDTI | 51 | 08/03 → 12/07 | 1.248 | D | M | 4 | 16 | Z13DT | | 81862 | |

Agila B

| | | | | | | | | | | | |
|----------|----|---------|-------|---|---|---|----|--------------|--|-------|------------|
| 1.0 | 48 | 04/08 → | 996 | B | M | 3 | 12 | K10B | | 84017 | NEW |
| | 50 | 07/11 → | 996 | B | M | 3 | 12 | K10B | | 84017 | NEW |
| 1.0 LPG | 48 | 01/10 → | 996 | | M | 3 | 12 | K10B | | 84017 | NEW |
| 1.2 | 63 | 04/08 → | 1.242 | B | M | 4 | 16 | K12B | | 84017 | NEW |
| | 69 | 11/10 → | 1.242 | B | M | 4 | 16 | K12B | | 84017 | NEW |
| 1.2 LPG | 63 | 04/08 → | 1.242 | | M | 4 | 16 | K12B | | 84017 | NEW |
| 1.3 CDTI | 55 | 04/08 → | 1.248 | D | M | 4 | 16 | D13A, Z13DTJ | | 81862 | |

Antara

| | | | | | | | | | | | |
|--------------|-----|---------|-------|---|---|---|----|--------------|--|-------|------------|
| 2.0 CDTI | 93 | 03/07 → | 1.991 | D | M | 4 | 16 | Z20DM, Z20S | | 84014 | NEW |
| | 110 | 05/06 → | 1.991 | D | M | 4 | 16 | Z20DMH, Z20S | | 84014 | NEW |
| 2.0 CDTI 4x4 | 110 | 05/06 → | 1.991 | D | M | 4 | 16 | Z20DMH, Z20S | | 84014 | NEW |
| 2.4 | 123 | 12/10 → | 2.384 | B | M | 4 | 16 | A24XE | | 81812 | |
| | 103 | 09/08 → | 2.405 | B | M | 4 | 16 | Z24XE | | 81550 | |
| | 104 | 05/06 → | 2.405 | B | M | 4 | 16 | Z24XED | | 81550 | |
| 2.4 4x4 | 123 | 12/10 → | 2.384 | B | M | 4 | 16 | A24XE | | 81812 | |
| | 103 | 01/07 → | 2.405 | B | M | 4 | 16 | Z24XE | | 81550 | |
| 2.4 LPG | 103 | 10/08 → | 2.405 | | M | 4 | 16 | Z24XE | | 81550 | |
| 2.4 LPG 4x4 | 103 | 10/08 → | 2.405 | | M | 4 | 16 | Z24XE | | 81550 | |
| 3.2 V6 | 167 | 03/07 → | 3.195 | B | M | 6 | 24 | 10HM, Z32SEE | | 84057 | NEW |

Arena

| | | | | | | | | | | | |
|-------|----|---------------|-------|---|---|---|---|----------------|--|-------|--|
| 1.9 D | 44 | 01/97 → 12/01 | 1.870 | D | M | 4 | 8 | 19DJ, 19DL | | 81574 | |
| | 44 | 03/98 → 08/01 | 1.870 | D | M | 4 | 8 | F8Q600, F8Q606 | | 81574 | |

Astra F Classic

| | | | | | | | | | | | |
|-----------|----|---------------|-------|---|---|---|----|--------|--|-------|--|
| 1.4 i | 44 | 01/98 → 08/02 | 1.389 | B | M | 4 | 8 | X14NZ | | 81549 | |
| 1.6 i | 55 | 01/98 → 08/02 | 1.598 | B | M | 4 | 8 | X16SZR | | 81549 | |
| 1.6 i 16V | 74 | 01/98 → 08/02 | 1.598 | B | M | 4 | 16 | X16XEL | | 82005 | |

Astra F, Station Wagon, Cabrio, Van

| | | | | | | | | | | | |
|-----------|----|---------------|-------|---|---|---|----|--------------|--|-------|--|
| 1.4 | 55 | 09/91 → 09/93 | 1.389 | B | M | 4 | 8 | 14NV | | 81549 | |
| | 60 | 09/92 → 09/98 | 1.389 | B | M | 4 | 8 | 14SE | | 81549 | |
| 1.4 i | 44 | 03/92 → 01/98 | 1.389 | B | M | 4 | 8 | C14NZ | | 81549 | |
| | 44 | 09/91 → 09/98 | 1.389 | B | M | 4 | 8 | C14NZ, X14NZ | | 81549 | |
| 1.4 i 16V | 66 | 02/96 → 09/98 | 1.389 | B | M | 4 | 16 | X14XE | | 82005 | |

KW

cm³

NO. OF VALVES

OPEL
Astra F, Station Wagon, Cabrio, Van

| | | | | | | | | | | |
|-------------|-----|---------------|-------|---|---|---|----|----------------------------------|-------------------------------|-------|
| 1.4 Si | 60 | 03/92 → 09/98 | 1.389 | B | M | 4 | 8 | C14SE | | 81549 |
| 1.6 | 55 | 09/95 → 09/98 | 1.598 | B | M | 4 | 8 | 16LZ2, 16NZR | | 81551 |
| 1.6 i | 52 | 05/93 → 07/96 | 1.598 | B | M | 4 | 8 | X16SZ | | 81549 |
| | 55 | 10/91 → 04/93 | 1.598 | B | M | 4 | 8 | C16NZ | | 81549 |
| | 55 | 03/92 → 09/98 | 1.598 | B | M | 4 | 8 | C16NZ, X16SZR | | 81549 |
| | 55 | 01/96 → 03/01 | 1.598 | B | M | 4 | 8 | X16SZR | | 81549 |
| 1.6 i 16V | 74 | 08/94 → 09/98 | 1.598 | B | M | 4 | 16 | X16XEL | | 82005 |
| 1.6 Si | 74 | 05/92 → 12/94 | 1.598 | B | M | 4 | 8 | C16SE | | 81549 |
| 1.7 D | 42 | 03/92 → 09/92 | 1.700 | D | M | 4 | 8 | 17D | | 81605 |
| | 44 | 07/92 → 09/98 | 1.700 | D | M | 4 | 8 | 17DR | → 12-1992, → M: 14.363.651 | 81605 |
| | 44 | 07/92 → 09/98 | 1.700 | D | M | 4 | 8 | 17DR | 01-1993 →, M →: 14.363.652 | 81550 |
| 1.7 TD | 60 | 03/95 → 02/98 | 1.686 | D | M | 4 | 8 | X17DT (TC4EE1) | | 81687 |
| | 50 | 11/94 → 09/98 | 1.700 | D | M | 4 | 8 | X17DTL | | 81550 |
| 1.7 TDS | 60 | 03/92 → 09/98 | 1.686 | D | M | 4 | 8 | 17DT (TC4EE1), X17DT (TC4EE1) | → 12-1992, → M: 855.805 | 81687 |
| | 60 | 03/92 → 09/98 | 1.686 | D | M | 4 | 8 | 17DT (TC4EE1), X17DT (TC4EE1) | 01-1993 →, M →: 855.806 | 81746 |
| 1.8 i | 66 | 03/92 → 09/98 | 1.796 | B | M | 4 | 8 | C18NZ | → 10-1992, → M: 14.254.438 | 81606 |
| | 66 | 03/92 → 09/98 | 1.796 | B | M | 4 | 8 | C18NZ | 11-1992 →, M →: 14.254.439 | 81551 |
| 1.8 i 16V | 85 | 11/94 → 09/98 | 1.799 | B | M | 4 | 16 | C18XEL, X18XE | | 81550 |
| | 92 | 06/93 → 10/94 | 1.799 | B | M | 4 | 16 | C18XE | | 81550 |
| 2.0 GSI 16V | 110 | 09/91 → 01/98 | 1.998 | B | M | 4 | 16 | C20XE | 01-1993 →, M →: 14.142.840 | 81550 |
| 2.0 i | 85 | 09/91 → 07/94 | 1.998 | B | M | 4 | 8 | C20NE | 01-1992 →, M →: 14.608.701 | 81551 |
| | 85 | 03/92 → 09/98 | 1.998 | B | M | 4 | 8 | C20NE | → 10-1992, → M: 14.608.700 | 81606 |
| | 85 | 03/92 → 09/98 | 1.998 | B | M | 4 | 8 | C20NE | 11-1992 →, M →: 14.608.701 | 81551 |
| | 85 | 03/93 → 10/94 | 1.998 | B | M | 4 | 8 | C20NE | → M: 14.608.700 | 81606 |
| | 85 | 03/93 → 10/94 | 1.998 | B | M | 4 | 8 | C20NE | M →: 14.608.701 | 81551 |
| 2.0 i 16V | 100 | 02/95 → 09/98 | 1.998 | B | M | 4 | 16 | X20XE | | 81550 |
| | 110 | 03/93 → 01/98 | 1.998 | B | M | 4 | 16 | C20XE | M →: 14.142.840 | 81550 |

Astra G, Station Wagon, Coupé, Cabrio, Van

| | | | | | | | | | | |
|---------|----|---------------|-------|---|---|---|----|--------|--|-------|
| 1.2 16V | 48 | 02/98 → 09/00 | 1.199 | B | M | 4 | 16 | X12XE | | 81749 |
| | 55 | 09/00 → 01/05 | 1.199 | B | M | 4 | 16 | Z12XE | | 81749 |
| 1.4 | 66 | 09/07 → 12/09 | 1.364 | B | M | 4 | 16 | Z14XEP | | 82011 |

KW

cm³

NO. OF VALVES

OPEL
Astra G, Station Wagon, Coupé, Cabrio, Van

| | | | | | | | | | | |
|----------|---------------|---------------|-------|---|---|----|--------|--------------------------|---|-------|
| 1.4 16V | 66 | 02/98 → 01/05 | 1.389 | B | M | 4 | 16 | X14XE, Z14XE | → 08-2000, → M: 20U75998, → M: 02MV7224, → M: 20U75998 | 82005 |
| | 66 | 02/98 → 01/05 | 1.389 | B | M | 4 | 16 | X14XE, Z14XE | 09-2000 →, M →: 20U75999, M →: 02MV7225, M →: 20U75999 | 81817 |
| | 66 | 09/98 → 01/05 | 1.389 | B | M | 4 | 16 | X14XE, Z14XE | 09-2000 → | 81818 |
| | 66 | 09/98 → 01/05 | 1.389 | B | M | 4 | 16 | X14XE, Z14XE | | 82005 |
| 1.6 | 55 | 02/98 → 09/00 | 1.598 | B | M | 4 | 8 | X16SZR | | 81549 |
| | 55 | 09/98 → 09/00 | 1.598 | B | M | 4 | 8 | X16SZR | 09-1996 → | 81549 |
| | 62 | 09/00 → 01/05 | 1.598 | B | M | 4 | 8 | Z16SE | → M: 02MZ5253, → M: 20U75998 | 81549 |
| | 62 | 09/00 → 01/05 | 1.598 | B | M | 4 | 8 | Z16SE | M →: 02MZ5254, M →: 20U75999 | 81818 |
| | 62 | 09/00 → 04/05 | 1.598 | B | M | 4 | 8 | Z16SE | → M: 20U75998, → M: 02MZ5253 | 81549 |
| | 62 | 09/00 → 07/04 | 1.598 | B | M | 4 | 8 | Z16SE | M →: 20U75999, M →: 02MZ5254 | 81818 |
| | 76 | 12/02 → 12/09 | 1.598 | B | M | 4 | 16 | Z16XEP | | 82083 |
| | 76 | 12/02 → 12/09 | 1.598 | B | M | 4 | 16 | Z16XEP | | 81818 |
| 1.6 16V | 74 | 02/98 → 01/05 | 1.598 | B | M | 4 | 16 | C16SEL, X16XEL, Z16XE | → M: 02MV7224, → M: 20U75998 | 82005 |
| | 74 | 02/98 → 01/05 | 1.598 | B | M | 4 | 16 | C16SEL, X16XEL, Z16XE | M →: 02MV7225, M →: 20U75999 | 81817 |
| | 74 | 02/98 → 07/04 | 1.598 | B | M | 4 | 16 | X16XEL, Z16XE | → M: 02MV7224, → M: 20U75998 | 82005 |
| | 74 | 02/98 → 07/04 | 1.598 | B | M | 4 | 16 | X16XEL, Z16XE | M →: 02MV7225, M →: 20U75999 | 81817 |
| | 74 | 09/98 → 01/05 | 1.598 | B | M | 4 | 16 | X16XEL, Z16XE | 09-2000 → | 81818 |
| | 74 | 09/98 → 01/05 | 1.598 | B | M | 4 | 16 | X16XEL, Z16XE | | 82005 |
| | 74 | 03/01 → 10/05 | 1.598 | B | M | 4 | 16 | Z16XE | → M: 02MV7224, → M: 20U75998 | 82005 |
| | 74 | 03/01 → 10/05 | 1.598 | B | M | 4 | 16 | Z16XE | M →: 02MV7225, M →: 20U75999 | 81817 |
| | 74 | 03/00 → 05/05 | 1.598 | B | M | 4 | 16 | Z16XE | | 81817 |
| | 74 | 03/00 → 05/05 | 1.598 | B | M | 4 | 16 | Z16XE | | 82005 |
| 76 | 03/00 → 05/05 | 1.598 | B | M | 4 | 16 | Z16XEP | | 82083 | |
| 1.6 CNG | 71 | 03/03 → 07/04 | 1.598 | | M | 4 | 16 | Z16YNG | | 81817 |
| 1.6 LPG | 74 | 06/02 → 01/05 | 1.598 | | M | 4 | 16 | Z16XE | | 81817 |
| | 74 | 06/02 → 01/05 | 1.598 | | M | 4 | 16 | Z16XE | | 82005 |
| 1.7 CDTI | 59 | 04/03 → 12/09 | 1.686 | D | M | 4 | 16 | Z17DTL | | 81836 |

KW

cm³

NO. OF VALVES

OPEL
Astra G, Station Wagon, Coupé, Cabrio, Van

| | | | | | | | | | | |
|---------------|-----|---------------|-------|---|---|---|----|----------------|---------------------------|-------|
| 1.7 DTI 16V | 55 | 02/00 → 01/05 | 1.686 | D | M | 4 | 16 | Y17DT | → 09-2000, → M: 073532 | 81746 |
| | 55 | 02/00 → 01/05 | 1.686 | D | M | 4 | 16 | Y17DT | 09-2000 →, M →: 073533 | 81836 |
| | 55 | 02/00 → 01/05 | 1.686 | D | M | 4 | 16 | Y17DT | | 81836 |
| | 55 | 02/00 → 07/04 | 1.686 | D | M | 4 | 16 | Y17DT | → 08-2000, → M: 073532 | 81746 |
| 1.7 TD | 50 | 02/98 → 08/00 | 1.700 | D | M | 4 | 8 | X17DTL | | 81550 |
| | 50 | 09/98 → 08/00 | 1.700 | D | M | 4 | 8 | X17DTL | | 81687 |
| 1.8 16V | 85 | 02/98 → 09/00 | 1.796 | B | M | 4 | 16 | X18XE1 | | 81751 |
| | 85 | 09/98 → 09/00 | 1.796 | B | M | 4 | 16 | X18XE1 | | 81550 |
| | 92 | 09/00 → 01/05 | 1.796 | B | M | 4 | 16 | Z18XE | | 81751 |
| 2.0 16V | 100 | 02/98 → 01/05 | 1.998 | B | M | 4 | 16 | C20SEL, X20XEV | | 81550 |
| | 100 | 02/98 → 07/04 | 1.998 | B | M | 4 | 16 | X20XEV | | 81550 |
| | 100 | 09/98 → 01/05 | 1.998 | B | M | 4 | 16 | X20XEV | M →: 14.142.840 | 81550 |
| 2.0 16V OPC | 118 | 11/99 → 09/02 | 1.998 | B | M | 4 | 16 | X20XER | | 81550 |
| 2.0 16V Turbo | 140 | 09/00 → 08/01 | 1.998 | B | M | 4 | 16 | Z20LET | | 81550 |
| | 141 | 08/01 → 05/05 | 1.998 | B | M | 4 | 16 | Z20LET | | 81550 |
| | 147 | 11/02 → 10/05 | 1.998 | B | M | 4 | 16 | Z20LER, Z20LET | | 81550 |
| | 147 | 11/02 → 05/05 | 1.998 | B | M | 4 | 16 | Z20LET | | 81550 |
| 2.0 DI | 60 | 01/99 → 04/05 | 1.995 | D | M | 4 | 16 | X20DTL | | 81747 |
| | 60 | 02/98 → 01/05 | 1.995 | D | M | 4 | 16 | X20DTL, Y20DTL | | 81747 |
| 2.0 DTI 16V | 74 | 08/99 → 01/05 | 1.995 | D | M | 4 | 16 | X20DTH, Y20DTH | | 81747 |
| 2.0 OPC | 141 | 09/02 → 01/05 | 1.998 | B | M | 4 | 16 | Z20LET | | 81550 |
| | 147 | 11/02 → 01/05 | 1.998 | B | M | 4 | 16 | Z20LET | | 81550 |
| 2.2 16V | 108 | 06/00 → 01/05 | 2.198 | B | M | 4 | 16 | Z22SE | | 81812 |
| 2.2 DTI | 86 | 09/02 → 01/05 | 2.172 | D | M | 4 | 16 | Y22DTR | | 81747 |
| | 92 | 09/02 → 01/05 | 2.172 | D | M | 4 | 16 | Y22DTR | | 81747 |

Astra H, Station Wagon, GTC, Twin Top, Van

| | | | | | | | | | | |
|-----------|-----|---------------|-------|---|---|---|----|----------------|--|-------|
| 1.2 | 59 | 08/05 → | 1.229 | B | M | 4 | 16 | Z12XEP | | 82011 |
| 1.3 CDTI | 66 | 08/05 → | 1.248 | D | M | 4 | 16 | Z13DTH | | 81862 |
| 1.4 | 55 | 04/04 → 10/04 | 1.364 | B | M | 4 | 16 | Z14XEL | | 82011 |
| | 59 | 04/04 → 10/04 | 1.364 | B | M | 4 | 16 | Z14XEL | | 82011 |
| | 66 | 03/04 → | 1.364 | B | M | 4 | 16 | Z14XEP | | 82011 |
| 1.4 LPG | 66 | 08/09 → | 1.364 | | M | 4 | 16 | Z14XEP | | 82011 |
| 1.6 | 76 | 02/04 → 11/04 | 1.598 | B | M | 4 | 16 | Z16XEP | | 82083 |
| | 77 | 03/04 → | 1.598 | B | M | 4 | 16 | Z16XE1, Z16XEP | | 82083 |
| | 85 | 12/06 → | 1.598 | B | M | 4 | 16 | A16XER, Z16XER | | 82083 |
| | 85 | 12/06 → | 1.598 | B | M | 4 | 16 | Z16XER | | 82083 |
| 1.6 LPG | 85 | 08/09 → | 1.598 | | M | 4 | 16 | Z16XER | | 82083 |
| 1.6 Turbo | 132 | 02/07 → | 1.598 | B | M | 4 | 16 | Z16LET | | 82083 |

KW

cm³

NO. OF VALVES

OPEL
Astra H, Station Wagon, GTC, Twin Top, Van

| | | | | | | | | | | |
|--------------|-----|---------|-------|---|---|---|----|----------------|--------------|-------|
| 1.7 CDTI | 59 | 03/04 → | 1.686 | D | M | 4 | 16 | Z17DTL | | 81836 |
| | 59 | 03/05 → | 1.686 | D | M | 4 | 16 | Z17DTL | | 84005 |
| | 74 | 03/04 → | 1.686 | D | M | 4 | 16 | Z17DTH | → T: 1874032 | 81836 |
| | 74 | 03/04 → | 1.686 | D | M | 4 | 16 | Z17DTH | T →: 1874033 | 84005 |
| | 74 | 03/04 → | 1.686 | D | M | 4 | 16 | Z17DTH | | 81836 |
| | 74 | 03/04 → | 1.686 | D | M | 4 | 16 | Z17DTH | | 84005 |
| | 81 | 02/07 → | 1.686 | D | M | 4 | 16 | A17DTJ | | 81836 |
| | 81 | 02/07 → | 1.686 | D | M | 4 | 16 | A17DTJ, Z17DTJ | | 81836 |
| | 81 | 02/07 → | 1.686 | D | M | 4 | 16 | A17DTJ, Z17DTJ | | 84005 |
| | 81 | 02/07 → | 1.686 | D | M | 4 | 16 | Z17DTJ | | 81836 |
| | 81 | 02/07 → | 1.686 | D | M | 4 | 16 | Z17DTJ | | 84005 |
| | 92 | 02/07 → | 1.686 | D | M | 4 | 16 | A17DTR | | 81836 |
| | 92 | 02/07 → | 1.686 | D | M | 4 | 16 | A17DTR, Z17DTR | | 81836 |
| | 92 | 02/07 → | 1.686 | D | M | 4 | 16 | A17DTR, Z17DTR | | 84005 |
| 1.8 | 92 | 03/04 → | 1.796 | B | M | 4 | 16 | Z18XE | | 82083 |
| | 103 | 01/06 → | 1.796 | B | M | 4 | 16 | A18XER, Z18XER | | 82083 |
| | 103 | 01/06 → | 1.796 | B | M | 4 | 16 | Z18XER | | 82083 |
| 1.9 CDTI | 74 | 09/05 → | 1.910 | D | M | 4 | 8 | Z19DTL | | 81352 |
| | 88 | 06/04 → | 1.910 | D | M | 4 | 8 | Z19DT | | 81352 |
| | 110 | 09/04 → | 1.910 | D | M | 4 | 16 | Z19DTH | | 81872 |
| 1.9 CDTI 16V | 88 | 04/04 → | 1.910 | D | M | 4 | 16 | Z19DTJ | | 81872 |
| 2.0 Turbo | 125 | 03/04 → | 1.998 | B | M | 4 | 16 | Z20LEL | | 81550 |
| | 147 | 09/04 → | 1.998 | B | M | 4 | 16 | Z20LER | | 81550 |
| | 177 | 03/05 → | 1.998 | B | M | 4 | 16 | Z20LEH | | 81550 |

Astra J, Station Wagon, GTC

| | | | | | | | | | | |
|-----------|-----|---------|-------|---|---|---|----|------------------------|--|------------------|
| 1.3 CDTI | 70 | 12/09 → | 1.248 | D | M | 4 | 16 | A13DTE | | 81862 |
| 1.4 | 88 | 10/11 → | 1.364 | B | M | 4 | 16 | A14NEL, B14NEL | | 84027 NEW |
| | 103 | 10/11 → | 1.364 | B | M | 4 | 16 | A14NET, B14NET | | 84027 NEW |
| | 64 | 12/09 → | 1.398 | B | M | 4 | 16 | A14XEL | | 84027 NEW |
| | 74 | 10/11 → | 1.398 | B | M | 4 | 16 | A14XER | | 84027 NEW |
| 1.4 LPG | 103 | 01/12 → | 1.364 | | M | 4 | 16 | A14NET | | 84027 NEW |
| 1.4 Turbo | 88 | 10/10 → | 1.364 | B | M | 4 | 16 | A14NEL, B14NEL | | 84027 NEW |
| | 103 | 12/09 → | 1.364 | B | M | 4 | 16 | A14NET | | 84027 NEW |
| | 103 | 10/10 → | 1.364 | B | M | 4 | 16 | A14NET, B14NET | | 84027 NEW |
| 1.6 | 85 | 12/09 → | 1.598 | B | M | 4 | 16 | A16XER, B16XER | | 82083 |
| | 132 | 10/11 → | 1.598 | B | M | 4 | 16 | A16LET | | 82083 |
| 1.6 Turbo | 132 | 12/09 → | 1.598 | B | M | 4 | 16 | A16LET | | 82083 |
| 1.7 CDTI | 74 | 10/10 → | 1.686 | D | M | 4 | 16 | A17DTL, A17DTN | | 84005 |
| | 81 | 10/11 → | 1.686 | D | M | 4 | 16 | A17DTC, A17DTE, A17DTJ | | 84005 |
| | 92 | 12/09 → | 1.686 | D | M | 4 | 16 | A17DTR | | 84005 |
| | 96 | 10/11 → | 1.686 | D | M | 4 | 16 | A17DTF, A17DTS | | 84005 |
| 1.8 | 103 | 10/11 → | 1.796 | B | M | 4 | 16 | A18XER | | 82083 |
| 2.0 | 206 | 04/12 → | 1.998 | B | M | 4 | 16 | A20NFT, B20NFT | | 81812 |

KW

cm³

NO. OF VALVES

MAGNETI MARELLI
OPEL
Astra J, Station Wagon, GTC

| | | | | | | | | | | |
|------------------|-----|---------|-------|---|---|---|----|--------|--|-------|
| 2.0 BiTurbo CDTI | 143 | 12/12 → | 1.956 | D | M | 4 | 16 | A20DTR | | 81872 |
| 2.0 CDTI | 96 | 10/10 → | 1.956 | D | M | 4 | 16 | | | 81872 |
| | 118 | 12/09 → | 1.956 | D | M | 4 | 16 | A20DTH | | 81872 |
| | 121 | 10/11 → | 1.956 | D | M | 4 | 16 | A20DTH | | 81872 |

Astra K, Sports Tourer

| | | | | | | | | | | | |
|-----|----|---------|-------|---|---|---|----|-------|--|-------|------------|
| 1.4 | 74 | 06/15 → | 1.399 | B | M | 4 | 16 | B14XE | | 84053 | NEW |
|-----|----|---------|-------|---|---|---|----|-------|--|-------|------------|

Calibra

| | | | | | | | | | | |
|-----------------|-----|---------------|-------|---|---|---|----|--------------|-------------------------------|-------|
| 2.0 i | 85 | 06/90 → 07/97 | 1.998 | B | M | 4 | 8 | C20NE | → 12-1992, → M: 14.608.700 | 81606 |
| | 85 | 06/90 → 07/97 | 1.998 | B | M | 4 | 8 | C20NE | 01-1993 →, M →: 14.608.701 | 81551 |
| 2.0 i 16V | 100 | 02/94 → 07/97 | 1.998 | B | M | 4 | 16 | X20XEV | M →: 14.142.840 | 81550 |
| | 110 | 06/90 → 02/94 | 1.998 | B | M | 4 | 16 | C20XE | 01-1993 →, M →: 14.142.839 | 81550 |
| 2.0 i 16V 4x4 | 100 | 02/94 → 07/97 | 1.998 | B | M | 4 | 16 | X20XEV | M →: 14.142.840 | 81550 |
| | 110 | 06/90 → 02/94 | 1.998 | B | M | 4 | 16 | C20XE | 01-1993 →, M →: 14.142.839 | 81550 |
| 2.0 i 4x4 | 85 | 06/90 → 07/97 | 1.998 | B | M | 4 | 8 | C20NE | → 12-1992, → M: 14.608.700 | 81606 |
| | 85 | 06/90 → 07/97 | 1.998 | B | M | 4 | 8 | C20NE | 01-1993 →, M →: 14.608.701 | 81551 |
| 2.0 i Turbo 4x4 | 150 | 03/92 → 07/97 | 1.998 | B | M | 4 | 16 | C20LET | 01-1993 →, M →: 14.002.935 | 81550 |
| 2.5 i V6 | 125 | 04/93 → 07/97 | 2.498 | B | M | 6 | 24 | C25XE, X25XE | | 81846 |

Cascade (W13)

| | | | | | | | | | | | |
|-----------|-----|---------|-------|---|---|---|----|--------|--|-------|------------|
| 1.4 | 88 | 03/13 → | 1.362 | B | M | 4 | 16 | A14NEL | | 84027 | NEW |
| 1.4 Turbo | 103 | 03/13 → | 1.362 | B | M | 4 | 16 | A14NET | | 84027 | NEW |
| 2.0 CDTI | 121 | 03/13 → | 1.956 | D | M | 4 | 16 | A20DTH | | 81872 | |
| | 143 | 03/13 → | 1.956 | D | M | 4 | 16 | A20DTR | | 81872 | |

Combo A

| | | | | | | | | | | | |
|---------|----|---------------|-------|---|---|---|----|-----------------------|-------------------------|-------|------------|
| 1.2 | 33 | 07/94 → 10/01 | 1.195 | B | M | 4 | 8 | C12NZ, X12SZ | | 81549 | |
| 1.4 | 44 | 07/94 → 10/01 | 1.389 | B | M | 4 | 8 | C14NZ, X14SZ | 09-1995 →, → 08-1996 | 81549 | |
| | 60 | 07/94 → 10/01 | 1.389 | B | M | 4 | 8 | C14SE | | 81549 | |
| 1.4 16V | 66 | 08/99 → 10/01 | 1.389 | B | M | 4 | 16 | X14XE | | 84027 | NEW |
| | 66 | 08/99 → 10/01 | 1.389 | B | M | 4 | 16 | X14XE | | 82005 | |
| 1.7 D | 44 | 07/94 → 10/01 | 1.686 | D | M | 4 | 8 | 17D(4EE1), X17D(4EE1) | → M: 877.697 | 81687 | |
| | 44 | 07/94 → 10/01 | 1.686 | D | M | 4 | 8 | 17D(4EE1), X17D(4EE1) | M →: 877.698 | 81746 | |

Combo B

| | | | | | | | | | | |
|--------------|----|---------|-------|---|---|---|----|--------------|--|-------|
| 1.3 CDTI 16V | 51 | 10/04 → | 1.248 | D | M | 4 | 16 | Y13DT, Z13DT | | 81862 |
| | 51 | 08/05 → | 1.248 | D | M | 4 | 16 | Z13DT | | 81862 |
| | 55 | 10/05 → | 1.248 | D | M | 4 | 16 | Z13DTJ | | 81862 |
| 1.4 | 66 | 10/04 → | 1.364 | B | M | 4 | 16 | Z14XEP | | 81836 |
| 1.4 16V | 66 | 08/05 → | 1.364 | B | M | 4 | 16 | Z14XEP | | 82011 |

KW

cm³

NO. OF VALVES

OPEL
Combo B

| | | | | | | | | | | |
|--------------|----|---------|-------|---|---|---|----|--------|----------|-------|
| 1.6 | 64 | 10/01 → | 1.598 | B | M | 4 | 8 | Z16SE | M: Z16SE | 81818 |
| | 64 | 10/01 → | 1.598 | B | M | 4 | 8 | Z16SE | | 81818 |
| 1.6 CNG | 69 | 06/06 → | 1.598 | | M | 4 | 16 | Z16YNG | | 81817 |
| | 71 | 04/05 → | 1.598 | | M | 4 | 16 | Z16YNG | | 81817 |
| 1.6 CNG 16V | 69 | 06/06 → | 1.598 | | M | 4 | 16 | Z16YNG | | 81817 |
| | 71 | 04/05 → | 1.598 | | M | 4 | 16 | Z16YNG | | 81817 |
| 1.7 CDTI 16V | 74 | 12/04 → | 1.686 | D | M | 4 | 16 | Z17DTH | | 81836 |
| 1.7 DI 16V | 48 | 10/01 → | 1.686 | D | M | 4 | 16 | Y17DTL | | 81836 |
| 1.7 DTI 16V | 55 | 10/01 → | 1.686 | D | M | 4 | 16 | Y17DT | | 81836 |

Combo C

| | | | | | | | | | | |
|----------|----|---------|-------|---|---|---|----|--------|-------|-------|
| 1.3 CDTI | 66 | 02/12 → | 1.248 | D | M | 4 | 16 | A13FD | | 81862 |
| 1.4 | 70 | 02/12 → | 1.368 | B | M | 4 | 16 | A14FP | TESMA | 82070 |
| 1.4 CNG | 88 | 02/12 → | 1.368 | | M | 4 | 16 | A14FC | TESMA | 82070 |
| 1.6 CDTI | 66 | 02/12 → | 1.598 | D | M | 4 | 16 | A16FDL | | 81872 |
| | 74 | 02/12 → | 1.598 | D | M | 4 | 16 | A16FDH | | 81872 |
| | 77 | 02/12 → | 1.598 | D | M | 4 | 16 | A16FDH | | 81872 |
| 2.0 CDTI | 99 | 02/12 → | 1.956 | D | M | 4 | 16 | A20FD | | 81872 |

Corsa A, Van

| | | | | | | | | | | |
|--------|----|---------------|-------|---|---|---|---|--------------|---|-------|
| 1.0 | 33 | 09/82 → 03/93 | 993 | B | M | 4 | 8 | 10S | | 81544 |
| 1.2 | 33 | 09/82 → 08/90 | 1.196 | B | M | 4 | 8 | 12NC, E12GV | | 81544 |
| | 44 | 09/82 → 08/90 | 1.196 | B | M | 4 | 8 | 12S | | 81549 |
| 1.2 i | 33 | 09/89 → 03/93 | 1.195 | B | M | 4 | 8 | C12NZ | | 81549 |
| 1.2 N | 38 | 01/90 → 03/93 | 1.196 | B | M | 4 | 8 | 12NV | | 81549 |
| 1.2 S | 40 | 09/82 → 02/90 | 1.196 | B | M | 4 | 8 | 12ST | | 81549 |
| 1.3 GL | 55 | 09/82 → 03/93 | 1.297 | B | M | 4 | 8 | 13S | | 81543 |
| 1.3 i | 44 | 09/86 → 09/90 | 1.297 | B | M | 4 | 8 | C13N | | 81543 |
| 1.4 i | 44 | 01/90 → 03/93 | 1.389 | B | M | 4 | 8 | C14NZ | → M: 19.311.737 | 81681 |
| | 44 | 01/90 → 03/93 | 1.389 | B | M | 4 | 8 | C14NZ | M →: 19.311.738 | 81549 |
| 1.4 S | 53 | 01/90 → 03/93 | 1.389 | B | M | 4 | 8 | 14NV | → M: 19.307.806 | 81681 |
| | 53 | 01/90 → 03/93 | 1.389 | B | M | 4 | 8 | 14NV | M →: 19.307.807 | 81549 |
| 1.4 Si | 60 | 09/91 → 03/93 | 1.389 | B | M | 4 | 8 | C14SE | | 81549 |
| 1.5 D | 37 | 09/87 → 03/93 | 1.488 | D | M | 4 | 8 | 15D (4EC1) | → 08-1990, M →: 804.795, → M: 909.999 | 81687 |
| | 37 | 09/87 → 03/93 | 1.488 | D | M | 4 | 8 | 15D (4EC1) | → M: 804.794 | 81684 |
| | 37 | 09/87 → 03/93 | 1.488 | D | M | 4 | 8 | 15D (4EC1) | 09-1990 →, M →: 910.000 | 81685 |
| 1.5 TD | 49 | 03/88 → 03/93 | 1.488 | D | M | 4 | 8 | 15DT (T4EC1) | → 08-1990, M →: 804.795, → M: 909.999 | 81687 |
| | 49 | 03/88 → 03/93 | 1.488 | D | M | 4 | 8 | 15DT (T4EC1) | → M: 804.794 | 81684 |
| | 49 | 03/88 → 03/93 | 1.488 | D | M | 4 | 8 | 15DT (T4EC1) | 09-1990 →, M →: 910.000 | 81685 |

KW

cm³

NO. OF VALVES

OPEL
Corsa A, Van

| | | | | | | | | | | |
|--------------|----|---------------|-------|---|---|---|---|--------|-----------------|-------|
| 1.6 GSI | 55 | 08/88 → 09/92 | 1.598 | B | M | 4 | 8 | C16NZ | → T: 02J22349 | 81681 |
| | 55 | 08/88 → 09/92 | 1.598 | B | M | 4 | 8 | C16NZ | T →: 02J22350 | 81549 |
| | 72 | 09/89 → 03/93 | 1.598 | B | M | 4 | 8 | C16SEI | → M: 19.311.738 | 81681 |
| | 72 | 09/89 → 03/93 | 1.598 | B | M | 4 | 8 | C16SEI | M →: 19.311.739 | 81549 |
| | 74 | 05/88 → 03/92 | 1.598 | B | M | 4 | 8 | E16SE | → T: 02J22349 | 81681 |
| | 74 | 05/88 → 03/92 | 1.598 | B | M | 4 | 8 | E16SE | T →: 02J22350 | 81549 |
| 1.6 GSI Cat. | 74 | 02/92 → 03/93 | 1.598 | B | M | 4 | 8 | C16SE | | 81549 |

Corsa B, Station Wagon, Van

| | | | | | | | | | | |
|-------------|----|---------------|-------|---|---|---|----|--------------------------------|---|-------|
| 1.0 i 12V | 40 | 11/96 → 09/00 | 973 | B | M | 3 | 12 | X10XE | | 81749 |
| 1.2 i | 33 | 03/93 → 09/00 | 1.195 | B | M | 4 | 8 | 12NZ, C12NZ, X12SZ | | 81549 |
| 1.2 i 16V | 48 | 03/98 → 09/00 | 1.199 | B | M | 4 | 16 | X12XE | | 81749 |
| 1.4 | 54 | 04/93 → 08/94 | 1.389 | B | M | 4 | 8 | C14SE | | 81549 |
| 1.4 i | 40 | 03/93 → 09/00 | 1.389 | B | M | 4 | 8 | C14NZ, X14SZ | | 81549 |
| | 44 | 03/93 → 09/00 | 1.389 | B | M | 4 | 8 | C14NZ, X14SZ | | 81549 |
| 1.4 i 16V | 63 | 08/97 → 09/00 | 1.389 | B | M | 4 | 16 | C14SEL | | 82005 |
| | 66 | 09/94 → 09/00 | 1.389 | B | M | 4 | 16 | X14XE | | 82005 |
| | 67 | 09/94 → 09/00 | 1.389 | B | M | 4 | 16 | X14XE | | 82005 |
| 1.4 Si | 60 | 03/93 → 09/00 | 1.389 | B | M | 4 | 8 | C14SE | | 81549 |
| 1.5 D | 37 | 03/93 → 09/00 | 1.488 | D | M | 4 | 8 | 15D (4EC1) | → 08-1994, → M: 877.697 | 81685 |
| | 37 | 03/93 → 09/00 | 1.488 | D | M | 4 | 8 | 15D (4EC1) | 09-1994 →, M →: 877.698 | 81748 |
| 1.5 TD | 49 | 03/93 → 09/00 | 1.488 | D | M | 4 | 8 | 15DT (T4EC1), X15DT (T4EC1) | → 08-1994, M →: 877.698, → M: 076.350 | 81748 |
| | 49 | 03/93 → 09/00 | 1.488 | D | M | 4 | 8 | 15DT (T4EC1), X15DT (T4EC1) | → M: 877.697 | 81685 |
| | 49 | 03/93 → 09/00 | 1.488 | D | M | 4 | 8 | 15DT (T4EC1), X15DT (T4EC1) | 09-1994 →, M →: 076.351 | 81750 |
| 1.6 GSI 16V | 80 | 03/93 → 09/00 | 1.598 | B | M | 4 | 16 | C16XE | | 82005 |
| 1.6 i 16V | 74 | 08/97 → 09/00 | 1.598 | B | M | 4 | 16 | C16SEL | | 82005 |
| | 78 | 09/94 → 09/00 | 1.598 | B | M | 4 | 16 | X16XE | | 82005 |
| 1.7 D | 44 | 02/96 → 09/00 | 1.686 | D | M | 4 | 8 | 17D (4EE1), X17D (4EE1) | → M: 877.697 | 81687 |
| | 44 | 02/96 → 09/00 | 1.686 | D | M | 4 | 8 | 17D (4EE1), X17D (4EE1) | M →: 877.698 | 81746 |
| | 44 | 08/99 → 09/00 | 1.686 | D | M | 4 | 8 | 17D (4EE1), X17D (4EE1) | | 81746 |
| | 44 | 01/99 → | 1.686 | D | M | 4 | 8 | X17D (4EE1) | | 81746 |
| | 44 | 01/99 → | 1.686 | D | M | 4 | 8 | X17D (4EE1) | | 81847 |

Corsa C, Van

| | | | | | | | | | | |
|--------------|----|---------------|-------|---|----|---|----|--------|--|-------|
| 1.0 | 43 | 09/00 → 06/03 | 973 | B | M | 3 | 12 | Z10XE | | 81749 |
| | 44 | 06/03 → 12/09 | 998 | B | M | 3 | 12 | Z10XEP | | 82011 |
| 1.2 | 55 | 09/00 → 12/09 | 1.199 | B | AM | 4 | 16 | Z12XE | | 81749 |
| | 59 | 07/05 → | 1.229 | B | M | 4 | 16 | Z12XEP | | 82011 |
| 1.2 16V | 55 | 09/00 → | 1.199 | B | M | 4 | 16 | Z12XE | | 81749 |
| 1.2 Twinport | 59 | 07/04 → 12/09 | 1.229 | B | M | 4 | 16 | Z12XEP | | 82011 |

| | | | | | | | | | |
|--|----|--|-----------------|--|--|--|---------------|--|--|
| | KW | | cm ³ | | | | NO. OF VALVES | | |
|--|----|--|-----------------|--|--|--|---------------|--|--|

OPEL

Corsa C, Van

| | | | | | | | | | | |
|--------------|----|---------------|-------|---|---|---|----|--------|--|-------|
| 1.3 CDTI | 51 | 06/03 → 12/09 | 1.248 | D | M | 4 | 16 | Z13DT | | 81862 |
| 1.3 CDTI 16V | 51 | 08/05 → | 1.248 | D | M | 4 | 16 | Z13DT | | 81862 |
| 1.4 | 66 | 08/03 → | 1.364 | B | M | 4 | 16 | Z14XEP | | 82011 |
| | 66 | 09/00 → 12/09 | 1.389 | B | M | 4 | 16 | Z14XE | | 81817 |
| 1.4 Twinport | 66 | 06/03 → 12/09 | 1.364 | B | M | 4 | 16 | Z14XEP | | 82011 |
| 1.7 CDTI | 74 | 06/03 → 12/09 | 1.686 | D | M | 4 | 16 | Z17DTH | | 81836 |
| 1.7 DI | 48 | 09/00 → 12/09 | 1.686 | D | M | 4 | 16 | Y17DTL | | 81836 |
| 1.7 DI 16V | 48 | 09/00 → | 1.686 | D | M | 4 | 16 | Y17DTL | | 81836 |
| 1.7 DTI | 55 | 09/00 → 12/09 | 1.686 | D | M | 4 | 16 | Y17DT | | 81836 |
| 1.7 DTI 16V | 55 | 09/00 → | 1.686 | D | M | 4 | 16 | Y17DT | | 81836 |
| 1.8 | 92 | 09/00 → 12/09 | 1.796 | B | M | 4 | 16 | Z18XE | | 81751 |

Corsa D, Van

| | | | | | | | | | | |
|-----------|-----|---------|-------|---|---|---|----|------------------------|--------------|------------------|
| 1.0 | 44 | 07/06 → | 998 | B | M | 3 | 12 | A10XEP | | 82011 |
| | 44 | 07/06 → | 998 | B | M | 3 | 12 | Z10XEP | | 82011 |
| | 48 | 01/10 → | 998 | B | M | 3 | 12 | A10XEP | | 82011 |
| 1.2 | 51 | 06/10 → | 1.229 | B | M | 4 | 16 | A12XEL | | 84027 NEW |
| | 59 | 07/06 → | 1.229 | B | M | 4 | 16 | Z12XEP | | 82011 |
| | 63 | 06/10 → | 1.229 | B | M | 4 | 16 | A12XER | | 84027 NEW |
| 1.2 LPG | 55 | 09/09 → | 1.229 | | M | 4 | 16 | Z12XEP | | 82011 |
| | 59 | 09/09 → | 1.229 | | M | 4 | 16 | Z12XEP | | 82011 |
| | 61 | 06/11 → | 1.229 | | M | 4 | 16 | A12XER | | 84027 NEW |
| | 63 | 08/11 → | 1.229 | | M | 4 | 16 | A12XER | | 84027 NEW |
| 1.3 CDTI | 55 | 07/06 → | 1.248 | D | M | 4 | 16 | A13DTC, Z13DTJ | | 81862 |
| | 66 | 07/06 → | 1.248 | D | M | 4 | 16 | Z13DTH | | 81862 |
| | 70 | 06/10 → | 1.248 | D | M | 4 | 16 | A13DTE, A13DTR, Z13DTE | | 81862 |
| 1.4 | 66 | 07/06 → | 1.364 | B | M | 4 | 16 | Z14XEP | | 82011 |
| | 88 | 07/12 → | 1.364 | B | M | 4 | 16 | A14NEL | | 84027 NEW |
| | 64 | 09/09 → | 1.398 | B | M | 4 | 16 | A14XEL | | 84027 NEW |
| | 74 | 06/10 → | 1.398 | B | M | 4 | 16 | A14XER | | 84027 NEW |
| 1.4 LPG | 66 | 07/06 → | 1.364 | | M | 4 | 16 | Z14XEP | | 82011 |
| | 64 | 09/09 → | 1.398 | | M | 4 | 16 | A14XEL | | 84027 NEW |
| 1.6 Turbo | 110 | 02/07 → | 1.598 | B | M | 4 | 16 | A16LEL, Z16LEL | | 82083 |
| | 141 | 02/07 → | 1.598 | B | M | 4 | 16 | A16LER, B16LER, Z16LER | | 82083 |
| | 155 | 06/11 → | 1.598 | B | M | 4 | 16 | A16LES, B16LES | | 82083 |
| 1.7 CDTI | 92 | 07/06 → | 1.686 | D | M | 4 | 16 | Z17DTR | → T: 1874032 | 81836 |
| | 92 | 07/06 → | 1.686 | D | M | 4 | 16 | Z17DTR | T →: 1874033 | 84005 |
| | 96 | 06/10 → | 1.686 | D | M | 4 | 16 | A17DTS | → T: 1874032 | 81836 |
| | 96 | 06/10 → | 1.686 | D | M | 4 | 16 | A17DTS | T →: 1874033 | 84005 |

KW

cm³

NO. OF VALVES

MAGNETI MARELLI
OPEL
Corsa E, Van

| | | | | | | | | | | | |
|-----------|-----|---------|-------|---|---|---|----|--------|--|-------|------------|
| 1.2 | 51 | 09/14 → | 1.229 | B | M | 4 | 16 | B12XEL | | 84027 | NEW |
| 1.3 CDTI | 55 | 09/14 → | 1.248 | D | M | 4 | 16 | B13DTC | | 81862 | |
| 1.4 | 55 | 09/14 → | 1.398 | B | M | 4 | 16 | B14XEJ | | 84027 | NEW |
| | 66 | 09/14 → | 1.398 | B | M | 4 | 16 | B14XEL | | 84027 | NEW |
| 1.4 LPG | 66 | 03/15 → | 1.398 | | M | 4 | 16 | B14XEL | | 84027 | NEW |
| 1.4 Turbo | 74 | 09/14 → | 1.364 | B | M | 4 | 16 | B14NEJ | | 84027 | NEW |
| | 110 | 03/15 → | 1.364 | B | M | 4 | 16 | B14NEH | | 84027 | NEW |
| 1.6 Turbo | 152 | 03/15 → | 1.598 | B | M | 4 | 16 | B16LES | | 82083 | |

Frontera A

| | | | | | | | | | | | |
|---------|-----|---------------|-------|---|---|---|----|---------------|----------|-------|--|
| 2.0 i | 85 | 03/92 → 10/98 | 1.998 | B | M | 4 | 8 | C20NE, X20SE | M: C20NE | 81606 | |
| | 85 | 03/92 → 10/98 | 1.998 | B | M | 4 | 8 | C20NE, X20SE | M: X20SE | 81551 | |
| 2.2 i | 100 | 03/95 → 10/98 | 2.198 | B | M | 4 | 16 | X22XE | | 81550 | |
| 2.5 TDS | 85 | 09/96 → 10/98 | 2.499 | D | M | 4 | 8 | 25TDS (VM41B) | (-)COP | 81362 | |

Frontera B

| | | | | | | | | | | | |
|---------|-----|---------------|-------|---|---|---|----|----------------|--|-------|--|
| 2.2 DTI | 88 | 09/02 → | 2.171 | D | M | 4 | 16 | Y22DTH | | 81747 | |
| | 85 | 10/98 → 09/02 | 2.171 | D | M | 4 | 16 | X22DTH, Y22DTH | | 81747 | |
| 2.2 i | 100 | 10/98 → | 2.198 | B | M | 4 | 16 | X22SE, Y22SE | | 81550 | |

GT II

| | | | | | | | | | | | |
|-----|-----|---------|-------|---|---|---|----|-------------|---------------|-------|--|
| 2.0 | 194 | 06/07 → | 1.998 | B | M | 4 | 16 | LNF, Z20NHH | → T: 7Y999999 | 81812 | |
|-----|-----|---------|-------|---|---|---|----|-------------|---------------|-------|--|

Insignia, Station Wagon

| | | | | | | | | | | | |
|----------------------|-----|---------|-------|----|---|---|----|----------------|--|-------|------------|
| 1.4 | 103 | 09/11 → | 1.364 | B | M | 4 | 16 | A14NET | | 84027 | NEW |
| | 103 | 04/11 → | 1.364 | B | M | 4 | 16 | A14NET, B14NET | | 84027 | NEW |
| 1.4 LPG | 103 | 07/12 → | 1.364 | | M | 4 | 16 | A14NET | | 84027 | NEW |
| 1.6 | 85 | 07/08 → | 1.598 | B | M | 4 | 16 | A16XER | | 82083 | |
| 1.6 Turbo | 132 | 07/08 → | 1.598 | B | M | 4 | 16 | A16LET | | 82083 | |
| 1.8 | 103 | 07/08 → | 1.796 | B | M | 4 | 16 | A18XER | | 82083 | |
| 2.0 Biturbo CDTI | 140 | 07/08 → | 1.956 | D | M | 4 | 16 | A20DTR | | 81872 | |
| | 143 | 01/12 → | 1.956 | D | M | 4 | 16 | A20DTR | | 81872 | |
| 2.0 Biturbo CDTI 4x4 | 140 | 05/09 → | 1.956 | D | M | 4 | 16 | A20DTR | | 81872 | |
| | 143 | 01/12 → | 1.956 | D | M | 4 | 16 | A20DTR | | 81872 | |
| 2.0 CDTI | 81 | 07/08 → | 1.956 | D | M | 4 | 16 | A20DTC, A20DTL | | 81872 | |
| | 88 | 03/12 → | 1.956 | D | M | 4 | 16 | A20DTE | | 81872 | |
| | 96 | 07/08 → | 1.956 | D | M | 4 | 16 | A20DT, A20DTJ | | 81872 | |
| | 103 | 07/13 → | 1.956 | D | M | 4 | 16 | A20DTE | | 81872 | |
| | 118 | 07/08 → | 1.956 | D | M | 4 | 16 | A20DTH | | 81872 | |
| | 120 | 07/13 → | 1.956 | D | M | 4 | 16 | A20DTH | | 81872 | |
| | 125 | 11/14 → | 1.956 | D | M | 4 | 16 | B20DTH | | 81872 | |
| 2.0 CDTI 4x4 | 118 | 06/10 → | 1.956 | D | M | 4 | 16 | A20DTH | | 81872 | |
| | 120 | 07/13 → | 1.956 | D | M | 4 | 16 | A20DTH | | 81872 | |
| 2.0 E85 Turbo | 162 | 09/10 → | 1.998 | FF | M | 4 | 16 | A20NFT, A20NHT | | 81812 | |
| | 162 | 09/10 → | 1.998 | FF | M | 4 | 16 | A20NHT | | 81812 | |
| 2.0 Turbo | 162 | 07/08 → | 1.998 | B | M | 4 | 16 | A20NHT | | 81812 | |
| 2.0 Turbo 4x4 | 162 | 07/08 → | 1.998 | B | M | 4 | 16 | A20NHT | | 81812 | |
| | 184 | 09/11 → | 1.998 | B | M | 4 | 16 | A20NFT | | 81812 | |

KW

cm³

NO. OF VALVES

OPEL
Insignia, Station Wagon

| | | | | | | | | | | |
|----------------------|-----|---------|-------|----|---|---|----|----------------|--|------------------|
| 2.0 Turbo E85 | 162 | 07/08 → | 1.998 | FF | M | 4 | 16 | A20NFT, A20NHT | | 81812 |
| 2.8 V6 Turbo 4x4 | 191 | 07/08 → | 2.792 | B | M | 6 | 24 | A28NET | | 84057 NEW |
| 2.8 V6 Turbo OPC 4x4 | 239 | 07/09 → | 2.792 | B | M | 6 | 24 | A28NER | | 84057 NEW |

Kadett E, Station Wagon, Coupé, Cabrio, Van

| | | | | | | | | | | |
|--------------|----|---------------|-------|---|---|---|---|---------------------|-------------------------------|-------|
| 1.3 i Cat. | 44 | 09/85 → 08/91 | 1.297 | B | M | 4 | 8 | C13N | | 81543 |
| 1.3 N | 44 | 09/84 → 08/91 | 1.297 | B | M | 4 | 8 | 13N | | 81543 |
| | 44 | 09/84 → 08/91 | 1.297 | B | M | 4 | 8 | 13N, 13NB | | 81543 |
| 1.3 S | 55 | 03/87 → 02/93 | 1.297 | B | M | 4 | 8 | 13S | | 81543 |
| 1.4 i | 44 | 01/90 → 08/91 | 1.389 | B | M | 4 | 8 | C14NZ | → M: 19.311.737 | 81681 |
| | 44 | 01/90 → 08/91 | 1.389 | B | M | 4 | 8 | C14NZ | M →: 19.311.738 | 81549 |
| 1.4 S | 55 | 01/90 → 08/91 | 1.389 | B | M | 4 | 8 | 14NV | | 81549 |
| | 60 | 09/89 → 08/91 | 1.389 | B | M | 4 | 8 | C14SE | → M: 19.311.737 | 81681 |
| | 60 | 09/89 → 08/91 | 1.389 | B | M | 4 | 8 | C14SE | M →: 19.311.738 | 81549 |
| 1.5 TD | 53 | 07/88 → 08/91 | 1.488 | D | M | 4 | 8 | 15DT (T4EC1) | → M: 804.794 | 81684 |
| | 53 | 07/88 → 08/91 | 1.488 | D | M | 4 | 8 | 15DT (T4EC1) | M →: 804.795 | 81685 |
| 1.6 | 60 | 09/86 → 12/91 | 1.598 | B | M | 4 | 8 | 16SV | → M: 19.311.737 | 81681 |
| | 60 | 09/86 → 12/91 | 1.598 | B | M | 4 | 8 | 16SV | M →: 19.311.738 | 81549 |
| 1.6 i | 55 | 08/91 → 07/94 | 1.598 | B | M | 4 | 8 | C16NZ | → M: 19.311.737 | 81681 |
| | 55 | 08/91 → 07/94 | 1.598 | B | M | 4 | 8 | C16NZ | M →: 19.311.738 | 81549 |
| | 55 | 09/86 → 08/91 | 1.598 | B | M | 4 | 8 | E16NZ | → M: 19.311.737 | 81681 |
| | 55 | 09/86 → 08/91 | 1.598 | B | M | 4 | 8 | E16NZ | M →: 19.311.738 | 81549 |
| | 60 | 07/89 → 02/93 | 1.598 | B | M | 4 | 8 | 16SV | → M: 19.311.737 | 81681 |
| | 60 | 07/89 → 02/93 | 1.598 | B | M | 4 | 8 | 16SV | M →: 19.311.738 | 81549 |
| 1.6 i Cat. | 55 | 09/86 → 08/91 | 1.598 | B | M | 4 | 8 | C16LZ, C16NZ | → M: 19.311.737 | 81681 |
| | 55 | 09/86 → 08/91 | 1.598 | B | M | 4 | 8 | C16LZ, C16NZ | M →: 19.311.738 | 81549 |
| 1.6 S | 60 | 09/86 → 08/91 | 1.598 | B | M | 4 | 8 | 16SV | → M: 19.311.737 | 81681 |
| | 60 | 09/86 → 08/91 | 1.598 | B | M | 4 | 8 | 16SV | M →: 19.311.738 | 81549 |
| 1.7 D | 42 | 02/89 → 08/91 | 1.700 | D | M | 4 | 8 | 17D | 09-1989 →, → 05-1992 | 81605 |
| | 42 | 02/89 → 08/91 | 1.700 | D | M | 4 | 8 | 17D | | 81605 |
| | 44 | 07/92 → 07/94 | 1.700 | D | M | 4 | 8 | 17DR | | 81605 |
| 1.8 | 84 | 09/87 → 08/90 | 1.796 | B | M | 4 | 8 | 18E | 09-1988 →, M →: 14.237.770 | 81606 |
| 1.8 i | 66 | 06/85 → 08/91 | 1.796 | B | M | 4 | 8 | C18NT, C18NZ, S18NV | | 81606 |
| 1.8 S | 62 | 09/87 → 08/91 | 1.796 | B | M | 4 | 8 | E18NV | | 81606 |
| | 62 | 09/87 → 08/91 | 1.796 | B | M | 4 | 8 | E18NV, S18NV | | 81606 |
| | 62 | 09/87 → 08/91 | 1.798 | B | M | 4 | 8 | E18NV | | 81606 |
| 2.0 GSI | 85 | 09/86 → 08/91 | 1.998 | B | M | 4 | 8 | 20NE | | 81606 |
| | 95 | 09/86 → 08/91 | 1.998 | B | M | 4 | 8 | 20SEH | | 81606 |
| 2.0 GSI Cat. | 85 | 09/86 → 08/91 | 1.998 | B | M | 4 | 8 | C20NE | | 81606 |
| 2.0 i | 85 | 10/86 → 02/93 | 1.998 | B | M | 4 | 8 | 20NE | | 81606 |
| | 85 | 03/87 → 08/91 | 1.998 | B | M | 4 | 8 | 20NE, 20SE | | 81606 |
| 2.0 i Cat. | 85 | 03/87 → 08/91 | 1.998 | B | M | 4 | 8 | C20NE | | 81606 |

KW

cm³

NO. OF VALVES

OPEL
Karl

| | | | | | | | | | | | |
|---------|----|---------|-----|---|---|---|----|-------|--|-------|------------|
| 1.0 | 52 | 06/15 → | 999 | B | M | 3 | 12 | B10XL | | 84053 | NEW |
| | 55 | 01/15 → | 999 | B | M | 3 | 12 | B10XE | | 84053 | NEW |
| 1.0 LPG | 54 | 02/15 → | 999 | | M | 3 | 12 | B10XE | | 84053 | NEW |

Meriva A

| | | | | | | | | | | | |
|----------------------|-----|---------------|-------|---|---|---|----|----------------|--|-------|--|
| 1.3 CDTI | 51 | 04/05 → 05/10 | 1.248 | D | M | 4 | 16 | Y13DT, Z13DT | | 81862 | |
| | 55 | 09/03 → 05/10 | 1.248 | D | M | 4 | 16 | Z13DTJ | | 81862 | |
| 1.4 16V Twinport | 66 | 07/04 → 05/10 | 1.364 | B | M | 4 | 16 | Z14XEP | | 82011 | |
| 1.4 16V Twinport LPG | 66 | 07/04 → 05/10 | 1.364 | | M | 4 | 16 | Z14XEP | | 82011 | |
| 1.6 | 64 | 05/03 → 05/10 | 1.598 | B | M | 4 | 8 | Z16SE | | 81818 | |
| | 77 | 01/06 → 05/10 | 1.598 | B | M | 4 | 16 | Z16XEP | | 82083 | |
| 1.6 16V | 74 | 05/03 → 01/06 | 1.598 | B | M | 4 | 16 | Z16XE | | 81817 | |
| 1.6 Turbo | 132 | 09/05 → 05/10 | 1.598 | B | M | 4 | 16 | Z16LET | | 82083 | |
| 1.7 CDTI | 74 | 09/03 → 05/10 | 1.686 | D | M | 4 | 16 | Z17DT, Z17DTH | | 81836 | |
| | 92 | 09/06 → 05/10 | 1.686 | D | M | 4 | 16 | A17DTR, Z17DTR | | 81836 | |
| 1.7 DTI | 55 | 09/03 → 05/10 | 1.686 | D | M | 4 | 16 | Y17DT | | 81836 | |
| 1.8 | 92 | 05/03 → 05/10 | 1.796 | B | M | 4 | 16 | Z18XE | | 81751 | |

Meriva B

| | | | | | | | | | | | |
|----------|-----|---------|-------|---|---|---|----|----------------|--|-------|------------|
| 1.3 CDTI | 55 | 06/10 → | 1.248 | D | M | 4 | 16 | A13DTC | | 81862 | |
| | 70 | 06/10 → | 1.248 | D | M | 4 | 16 | A13DTE | | 81862 | |
| 1.4 | 88 | 06/10 → | 1.364 | B | M | 4 | 16 | A14NEL, B14NEL | | 84027 | NEW |
| | 103 | 06/10 → | 1.364 | B | M | 4 | 16 | A14NET, B14NET | | 84027 | NEW |
| | 74 | 06/10 → | 1.398 | B | M | 4 | 16 | A14XER, B14XER | | 84027 | NEW |
| 1.4 LPG | 88 | 06/11 → | 1.364 | | M | 4 | 16 | A14NEL, B14NEL | | 84027 | NEW |
| 1.7 CDTI | 74 | 06/10 → | 1.686 | D | M | 4 | 16 | A17DT | | 84005 | |
| | 81 | 06/10 → | 1.686 | D | M | 4 | 16 | A17DTC, A17DTI | | 84005 | |
| | 96 | 06/10 → | 1.686 | D | M | 4 | 16 | A17DTS | | 84005 | |

Mokka

| | | | | | | | | | | | |
|--------------|-----|---------|-------|---|---|---|----|----------------|--|-------|------------|
| 1.4 | 103 | 04/13 → | 1.364 | B | M | 4 | 16 | A14NET, B14NET | | 84027 | NEW |
| 1.4 4x4 | 103 | 06/12 → | 1.364 | B | M | 4 | 16 | A14NET, B14NET | | 84027 | NEW |
| 1.4 LPG | 103 | 04/13 → | 1.364 | | M | 4 | 16 | A14NET | | 84027 | NEW |
| 1.6 | 85 | 06/12 → | 1.598 | B | M | 4 | 16 | A16XER, B16XER | | 82083 | |
| 1.7 CDTI | 96 | 06/12 → | 1.686 | D | M | 4 | 16 | A17DTS | | 84005 | |
| 1.7 CDTI 4x4 | 96 | 06/12 → | 1.686 | D | M | 4 | 16 | A17DTS | | 84005 | |
| 1.8 | 103 | 01/13 → | 1.796 | B | M | 4 | 16 | A18XER | | 82083 | |
| 1.8 4x4 | 103 | 01/13 → | 1.796 | B | M | 4 | 16 | A18XER | | 82083 | |

Movano A

| | | | | | | | | | | | |
|----------|-----|---------------|-------|---|---|---|----|------------------------|--|-------|--|
| 1.9 DTI | 59 | 09/00 → 10/01 | 1.870 | D | M | 4 | 8 | F9Q770 | | 81574 | |
| | 60 | 10/01 → | 1.870 | D | M | 4 | 8 | F9Q772, F9Q774 | | 81814 | |
| | 60 | 10/01 → | 1.870 | D | M | 4 | 8 | F9Q772, F9Q774 | | 84009 | |
| 2.2 DTI | 66 | 09/00 → | 2.188 | D | M | 4 | 16 | G9T720, G9T722, G9T750 | | 81855 | |
| 2.5 CDTI | 74 | 09/07 → | 2.464 | D | M | 4 | 16 | G9U650 | | 81855 | |
| | 88 | 08/06 → | 2.464 | D | M | 4 | 16 | G9U632, G9U650 | | 81855 | |
| | 107 | 08/06 → | 2.464 | D | M | 4 | 16 | G9U632, G9U650 | | 81855 | |

| | | | | | | | | | |
|--|--|--|--|--|--|--|--|--|--|
| | | | | | | | | | |
|--|--|--|--|--|--|--|--|--|--|

OPEL

Movano A

| | | | | | | | | | | |
|---------|----|---------------|-------|---|---|---|----|--------------------------------|-----------|-------|
| 2.5 D | 59 | 07/98 → 09/00 | 2.499 | D | M | 4 | 8 | S8U770, S8U772 | | 81834 |
| 2.5 DTi | 73 | 10/03 → | 2.463 | D | M | 4 | 16 | G9U754 | | 81855 |
| | 84 | 10/01 → | 2.463 | D | M | 4 | 16 | G9U720, G9U724, G9U750, G9U754 | | 81855 |
| | 84 | 10/01 → | 2.463 | D | M | 4 | 16 | G9U720, G9U724, G9U754 | | 81855 |
| 2.8 DTI | 84 | 07/98 → 10/01 | 2.799 | D | M | 4 | 8 | S9W700, S9W702 | | 81835 |
| | 84 | 01/99 → 10/01 | 2.799 | D | M | 4 | 8 | S9W700, S9W702 | → 12-1999 | 81834 |
| | 84 | 01/99 → 10/01 | 2.799 | D | M | 4 | 8 | S9W700, S9W702 | 01-2000 → | 81835 |

Movano B

| | | | | | | | | | | |
|----------------|-----|---------|-------|---|---|---|----|--|--|-------|
| 2.3 CDTI | 74 | 12/10 → | 2.298 | D | M | 4 | 16 | M9T670, M9T672, M9T676 | | 82069 |
| | 92 | 12/10 → | 2.298 | D | M | 4 | 16 | M9T670, M9T672, M9T676, M9T680, M9T876 | | 82069 |
| | 107 | 12/10 → | 2.298 | D | M | 4 | 16 | M9T678, M9T680 | | 82069 |
| | 110 | 01/13 → | 2.298 | D | M | 4 | 16 | M9T880 | | 82069 |
| 2.3 CDTI [RWD] | 74 | 05/10 → | 2.298 | D | M | 4 | 16 | M9T690, M9T692 | | 82069 |
| | 92 | 05/10 → | 2.298 | D | M | 4 | 16 | M9T692, M9T696, M9T698, M9T876 | | 82069 |
| | 107 | 05/10 → | 2.298 | D | M | 4 | 16 | M9T694, M9T696, M9T698 | | 82069 |
| 2.3 CDTI FWD | 74 | 05/10 → | 2.298 | D | M | 4 | 16 | M9T670, M9T672, M9T676 | | 82069 |
| | 92 | 05/10 → | 2.298 | D | M | 4 | 16 | M9T670, M9T672, M9T676, M9T680, M9T876 | | 82069 |
| | 92 | 05/10 → | 2.298 | D | M | 4 | 16 | M9T670, M9T672, M9T676, M9T876 | | 82069 |
| | 107 | 05/10 → | 2.298 | D | M | 4 | 16 | M9T678, M9T680 | | 82069 |
| | 110 | 01/13 → | 2.298 | D | M | 4 | 16 | M9T880 | | 82069 |

Omega A, Station Wagon

| | | | | | | | | | | |
|-------|----|---------------|-------|---|---|---|---|--------|-------------------------------|-------|
| 1.8 | 65 | 09/87 → 03/94 | 1.796 | B | M | 4 | 8 | E18NVR | | 81606 |
| | 85 | 09/86 → 03/94 | 1.796 | B | M | 4 | 8 | 18SEH | | 81606 |
| 1.8 S | 66 | 09/86 → 03/94 | 1.796 | B | M | 4 | 8 | 18SV | | 81606 |
| 2.0 | 73 | 09/90 → 03/94 | 1.998 | B | M | 4 | 8 | C20NEJ | | 81551 |
| | 74 | 09/90 → 03/94 | 1.998 | B | M | 4 | 8 | C20NEF | M →: 14.608.701 | 81551 |
| | 74 | 09/90 → 03/94 | 1.998 | B | M | 4 | 8 | C20NEF | | 81551 |
| | 90 | 09/86 → 03/94 | 1.998 | B | M | 4 | 8 | 20SE | → 12-1989, → M: 14.608.700 | 81606 |
| | 90 | 09/86 → 03/94 | 1.998 | B | M | 4 | 8 | 20SE | 01-1990 →, M →: 14.608.701 | 81551 |
| | 90 | 09/86 → 03/94 | 1.998 | B | M | 4 | 8 | 20SE | 01-1990 →, M →: 14608701 | 81551 |

KW

cm³

NO. OF VALVES

OPEL
Omega A, Station Wagon

| | | | | | | | | | | |
|-------|----|---------------|-------|---|---|---|---|--------|-------------------------------|-------|
| 2.0 i | 73 | 09/90 → 03/94 | 1.998 | B | M | 4 | 8 | C20NEJ | | 81551 |
| | 85 | 09/86 → 03/94 | 1.998 | B | M | 4 | 8 | C20NE | → 12-1989, → M: 14.608.700 | 81606 |
| | 85 | 09/86 → 03/94 | 1.998 | B | M | 4 | 8 | C20NE | 01-1990 →, M →: 14.608.701 | 81551 |

Omega B, Station Wagon

| | | | | | | | | | | |
|-------------|-----|---------------|-------|---|---|---|----|--------------------|--|-------|
| 2.0 | 85 | 03/94 → 12/00 | 1.998 | B | M | 4 | 8 | 20SE, X20SE | | 81551 |
| | 85 | 03/94 → 09/99 | 1.998 | B | M | 4 | 8 | X20SE | | 81551 |
| 2.0 16V | 100 | 03/94 → 09/99 | 1.998 | B | M | 4 | 16 | X20XEV | | 81550 |
| 2.0 DTI 16V | 74 | 09/97 → 09/00 | 1.995 | D | M | 4 | 16 | X20DTH | | 81747 |
| 2.2 16V | 106 | 09/99 → 07/03 | 2.198 | B | M | 4 | 16 | Y22XE, Z22XE | | 81550 |
| 2.2 DTI 16V | 81 | 09/00 → 07/03 | 2.171 | D | M | 4 | 16 | Y22DTH | | 81747 |
| | 88 | 09/00 → 07/03 | 2.171 | D | M | 4 | 16 | Y22DTH | | 81747 |
| 2.5 D | 96 | 05/94 → 05/99 | 2.498 | D | M | 6 | 12 | X25TD | | 81597 |
| 2.5 DTI | 110 | 09/01 → 07/03 | 2.497 | D | M | 6 | 24 | Y25DT | | 81795 |
| 2.5 TD | 96 | 04/94 → 07/03 | 2.497 | D | M | 6 | 12 | 25DT, X25DT, X25TD | | 81597 |
| 2.5 V6 | 125 | 03/94 → 09/00 | 2.498 | B | M | 6 | 24 | X25XE | | 81846 |
| 2.6 V6 | 132 | 09/00 → 07/03 | 2.597 | B | M | 6 | 24 | Y26SE | | 81846 |
| 3.0 V6 | 155 | 04/94 → 02/01 | 2.962 | B | M | 6 | 24 | X30XE | | 81846 |
| 3.2 V6 | 160 | 02/01 → 07/03 | 3.175 | B | M | 6 | 24 | Y32SE | | 81846 |

Signum

| | | | | | | | | | | |
|--------------|-----|---------|-------|---|---|---|----|--------|--|-------|
| 1.8 | 90 | 05/03 → | 1.796 | B | M | 4 | 16 | Z18XE | | 81751 |
| | 103 | 09/05 → | 1.796 | B | M | 4 | 16 | Z18XER | | 82083 |
| 1.9 CDTI | 74 | 08/05 → | 1.910 | D | M | 4 | 8 | Z19DT | | 81352 |
| | 88 | 04/04 → | 1.910 | D | M | 4 | 8 | Z19DT | | 81352 |
| | 110 | 04/04 → | 1.910 | D | M | 4 | 16 | Z19DTH | | 81872 |
| 2.0 DTI | 74 | 05/03 → | 1.994 | D | M | 4 | 16 | Y20DTH | | 81747 |
| 2.0 Turbo | 129 | 05/03 → | 1.998 | B | M | 4 | 16 | Z20NET | | 81812 |
| 2.2 direct | 114 | 05/03 → | 2.198 | B | M | 4 | 16 | Z22YH | | 81812 |
| 2.2 DTI | 92 | 05/03 → | 2.171 | D | M | 4 | 16 | Y22DTR | | 81747 |
| 2.8 V6 Turbo | 169 | 09/05 → | 2.792 | B | M | 6 | 24 | Z28NEL | | 84057 |
| | 184 | 01/06 → | 2.792 | B | M | 6 | 24 | Z28NET | | 84057 |
| 3.2 V6 | 155 | 05/03 → | 3.175 | B | M | 6 | 24 | Z32SE | | 81846 |

Sintra

| | | | | | | | | | | |
|-----------|-----|---------------|-------|---|---|---|----|--------|--|-------|
| 2.2 DTI | 85 | 07/97 → 04/99 | 2.171 | D | M | 4 | 16 | X22DTH | | 81747 |
| 2.2 i 16V | 104 | 11/96 → 04/99 | 2.198 | B | M | 4 | 16 | X22XE | | 81550 |
| 3.0 i 24V | 148 | 11/96 → 04/99 | 2.962 | B | A | 6 | 24 | X30XE | | 81846 |

Speedster

| | | | | | | | | | | |
|-----------|-----|---------|-------|---|---|---|----|--------|--|-------|
| 2.0 Turbo | 147 | 04/03 → | 1.998 | B | M | 4 | 16 | Z20LET | | 81550 |
| 2.2 | 108 | 09/00 → | 2.198 | B | M | 4 | 16 | Z22SE | | 81812 |

KW

cm³

NO. OF VALVES

MAGNETI MARELLI
OPEL
Tigra I

| | | | | | | | | | | |
|---------|----|---------------|-------|---|---|---|----|--------|--|-------|
| 1.4 16V | 63 | 08/97 → 12/00 | 1.389 | B | M | 4 | 16 | X14XE | | 82005 |
| | 66 | 07/94 → 12/00 | 1.389 | B | M | 4 | 16 | X14XE | | 82005 |
| 1.6 16V | 74 | 08/97 → 08/98 | 1.598 | B | M | 4 | 16 | C16SEL | | 82005 |
| | 78 | 07/94 → 08/98 | 1.598 | B | M | 4 | 16 | X16XE | | 82005 |

Tigra II Twin Top

| | | | | | | | | | | |
|----------|----|---------|-------|---|---|---|----|--------|--|-------|
| 1.3 CDTI | 51 | 06/04 → | 1.248 | D | M | 4 | 16 | Z13DT | | 81862 |
| 1.4 | 66 | 06/04 → | 1.364 | B | M | 4 | 16 | Z14XEP | | 82011 |
| 1.8 | 92 | 06/04 → | 1.796 | B | M | 4 | 16 | Z18XE | | 81751 |

Vectra A

| | | | | | | | | | | |
|------------|----|---------------|-------|---|---|---|---|-------------------------------------|-------------------------------|-------|
| 1.4 S | 55 | 09/88 → 06/92 | 1.389 | B | M | 4 | 8 | 14NV | → M: 19.307.805 | 81681 |
| | 55 | 09/88 → 06/92 | 1.389 | B | M | 4 | 8 | 14NV | M →: 19.307.806 | 81549 |
| 1.6 | 60 | 09/88 → 05/93 | 1.598 | B | M | 4 | 8 | 16SV | → M: 2.122.349 | 81681 |
| | 60 | 09/88 → 05/93 | 1.598 | B | M | 4 | 8 | 16SV | M →: 2.122.350 | 81549 |
| 1.6 i | 52 | 09/93 → 11/95 | 1.598 | B | M | 4 | 8 | X16SZ | → M: 2.122.349 | 81681 |
| | 52 | 09/93 → 11/95 | 1.598 | B | M | 4 | 8 | X16SZ | M →: 2.122.350 | 81549 |
| | 55 | 09/93 → 11/95 | 1.598 | B | M | 4 | 8 | 16LZ2 | → M: 2.122.349 | 81681 |
| | 55 | 09/93 → 11/95 | 1.598 | B | M | 4 | 8 | 16LZ2 | M →: 2.122.350 | 81549 |
| | 55 | 09/88 → 11/95 | 1.598 | B | M | 4 | 8 | 16LZ2, C16LZ2, C16NZ, C16NZ2, E16NZ | → M: 2.122.349 | 81681 |
| | 55 | 09/88 → 11/95 | 1.598 | B | M | 4 | 8 | 16LZ2, C16LZ2, C16NZ, C16NZ2, E16NZ | M →: 2.122.350 | 81549 |
| 1.6 i Cat. | 55 | 09/88 → 11/95 | 1.598 | B | M | 4 | 8 | C16NZ, C16NZ2 | → M: 2.122.349 | 81681 |
| | 55 | 09/88 → 11/95 | 1.598 | B | M | 4 | 8 | C16NZ, C16NZ2 | M →: 2.122.350 | 81549 |
| 1.6 S | 60 | 09/88 → 05/93 | 1.598 | B | M | 4 | 8 | 16SV | → M: 2.122.349 | 81681 |
| | 60 | 09/88 → 05/93 | 1.598 | B | M | 4 | 8 | 16SV | M →: 2.122.350 | 81549 |
| 1.7 D | 42 | 10/88 → 09/92 | 1.700 | D | M | 4 | 8 | 17D | → M: 14.333.449 | 81605 |
| | 42 | 10/88 → 09/92 | 1.700 | D | M | 4 | 8 | 17D | M →: 14.333.450 | 81550 |
| | 44 | 07/92 → 11/95 | 1.700 | D | M | 4 | 8 | 17DR | → 12-1992, → M: 14.333.449 | 81605 |
| | 44 | 07/92 → 11/95 | 1.700 | D | M | 4 | 8 | 17DR | 01-1993 →, M →: 14.333.450 | 81550 |
| | 44 | 07/92 → 11/95 | 1.700 | D | M | 4 | 8 | 17DR | M →: 14.333.450 | 81550 |
| 1.7 TD | 60 | 03/90 → 11/95 | 1.686 | D | M | 4 | 8 | 17DT (TC4EE1), X17DT (TC4EE1) | | 81687 |
| 1.8 i | 66 | 09/88 → 10/90 | 1.796 | B | M | 4 | 8 | 18SV | → T: N5.999.999 | 81606 |
| | 66 | 09/88 → 10/90 | 1.796 | B | M | 4 | 8 | 18SV | T →: P1.000.001 | 81551 |
| 1.8 i Cat. | 66 | 03/90 → 11/95 | 1.796 | B | M | 4 | 8 | C18NZ | → 12-1992, → T: N5.999.999 | 81606 |
| | 66 | 03/90 → 11/95 | 1.796 | B | M | 4 | 8 | C18NZ | 01-1993 →, T →: P1.000.001 | 81551 |
| 1.8 S | 66 | 09/89 → 10/90 | 1.796 | B | M | 4 | 8 | 18SV | → T: N5.999.999 | 81606 |
| | 66 | 09/89 → 10/90 | 1.796 | B | M | 4 | 8 | 18SV | T →: P1.000.001 | 81551 |

KW

cm³

NO. OF VALVES

OPEL
Vectra A

| | | | | | | | | | | |
|----------------------|-----|---------------|-------|---|---|---|----|--------|---|--------------|
| 2.0 i | 85 | 09/88 → 10/90 | 1.998 | B | M | 4 | 8 | 20NE | → T: N5.999.999 | 81606 |
| | 85 | 09/88 → 10/90 | 1.998 | B | M | 4 | 8 | 20NE | T →: P1.000.001 | 81551 |
| | 95 | 09/88 → 09/92 | 1.998 | B | M | 4 | 8 | 20SEH | 08-1988 →, → 12-1992, → T: N5.999.999 | 81606 |
| | 95 | 09/88 → 09/92 | 1.998 | B | M | 4 | 8 | 20SEH | T →: P1.000.001 | 81551 |
| 2.0 i 16V | 100 | 06/94 → 11/95 | 1.998 | B | M | 4 | 16 | X20XEV | M →: 14.142.839 | 81550 |
| | 110 | 02/89 → 10/90 | 1.998 | B | M | 4 | 16 | 20XEJ | M →: 14.142.839 | 81550 |
| 2.0 i 16V 4x4 | 100 | 06/94 → 11/95 | 1.998 | B | M | 4 | 16 | X20XEV | M →: 14.142.839 | 81550 |
| 2.0 i 16V Cat. | 110 | 02/90 → 11/95 | 1.998 | B | M | 4 | 16 | C20XE | M →: 14.142.839 | 81550 |
| 2.0 i 4x4 | 85 | 01/89 → 10/90 | 1.998 | B | M | 4 | 8 | 20NE | → T: N5.999.999 | 81606 |
| | 85 | 01/89 → 10/90 | 1.998 | B | M | 4 | 8 | 20NE | T →: P1.000.001 | 81551 |
| | 95 | 01/89 → 09/92 | 1.998 | B | M | 4 | 8 | 20SEH | 08-1988 →, → 12-1992, → T: N5.999.999 | 81606 |
| | 95 | 01/89 → 09/92 | 1.998 | B | M | 4 | 8 | 20SEH | T →: P1.000.001 | 81551 |
| 2.0 i 4x4 Cat. | 85 | 01/89 → 11/95 | 1.998 | B | M | 4 | 8 | C20NE | 08-1988 →, → 12-1992, → T: N5.999.999 | 81606 |
| | 85 | 01/89 → 11/95 | 1.998 | B | M | 4 | 8 | C20NE | T →: P1.000.001 | 81551 |
| 2.0 i Cat. | 85 | 09/88 → 11/95 | 1.998 | B | M | 4 | 8 | C20NE | → 12-1992, → T: N5.999.999 | 81606 |
| | 85 | 09/88 → 11/95 | 1.998 | B | M | 4 | 8 | C20NE | 01-1993 →, T →: P1.000.001 | 81551 |
| 2.0 i GT | 95 | 09/88 → 11/95 | 1.998 | B | M | 4 | 8 | 20SEH | → 12-1992, → T: N5.999.999 | 81606 |
| | 95 | 09/88 → 11/95 | 1.998 | B | M | 4 | 8 | 20SEH | 01-1993 →, T →: P1.000.001 | 81551 |
| 2.0 i Turbo 4x4 | 150 | 06/94 → 11/95 | 1.998 | B | M | 4 | 16 | C20LET | M →: 14.002.935 | 81550 |
| 2.5 V6 | 125 | 02/93 → 11/95 | 2.498 | B | M | 6 | 24 | C25XE | | 81846 |
| 2000 16V 4x4 | 110 | 01/89 → 10/90 | 1.998 | B | M | 4 | 16 | 20XEJ | M →: 14.142.839 | 81550 |
| 2000/GT 16V | 110 | 01/89 → 06/94 | 1.998 | B | M | 4 | 16 | 20XEJ | M →: 14.142.839 | 81550 |
| 2000/GT 16V 4x4 Cat. | 110 | 02/90 → 11/95 | 1.998 | B | M | 4 | 16 | C20XE | M →: 14.142.839 | 81550 |
| 2000/GT 16V Cat. | 110 | 02/90 → 11/95 | 1.998 | B | M | 4 | 16 | C20XE | M →: 14.142.839 | 81550 |

Vectra B, Station Wagon

| | | | | | | | | | | |
|-------|----|---------------|-------|---|---|---|---|--------|-----------------------------|--------------|
| 1.6 i | 55 | 10/95 → 04/02 | 1.598 | B | M | 4 | 8 | 16LZ2 | | 81551 |
| | 55 | 10/95 → 04/02 | 1.598 | B | M | 4 | 8 | X16SZR | → 12-1999, → M: 02MZ5253 | 81549 |
| | 55 | 10/95 → 04/02 | 1.598 | B | M | 4 | 8 | X16SZR | 01-2000 →, M →: 02MZ5254 | 81818 |
| | 55 | 10/95 → 07/03 | 1.598 | B | M | 4 | 8 | X16SZR | → M: 02MZ5253 | 81549 |
| | 55 | 10/95 → 07/03 | 1.598 | B | M | 4 | 8 | X16SZR | M →: 02MZ5254 | 81818 |

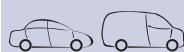
KW

cm³

NO. OF VALVES

MAGNETI MARELLI
OPEL
Vectra B, Station Wagon

| | | | | | | | | | | |
|-------------|-----|---------------|-------|---|---|---|----|----------------------|---------------------------------|-------|
| 1.6 i 16V | 74 | 10/95 → 04/02 | 1.598 | B | M | 4 | 16 | X16XEL, Y16XE, Z16XE | → M: 20U75998, → M: 02MV7224 | 82005 |
| | 74 | 10/95 → 04/02 | 1.598 | B | M | 4 | 16 | X16XEL, Y16XE, Z16XE | M →: 20U75999, M →: 02MV7225 | 81817 |
| | 74 | 10/95 → 07/02 | 1.598 | B | M | 4 | 16 | X16XEL, Y16XE, Z16XE | → M: 02MZ5253 | 82005 |
| | 74 | 10/95 → 07/02 | 1.598 | B | M | 4 | 16 | X16XEL, Y16XE, Z16XE | M →: 02MZ5254 | 81817 |
| | 74 | 11/96 → 07/02 | 1.598 | B | M | 4 | 16 | X16XEL, Y16XE, Z16XE | → M: 20U75998, → M: 02MZ5253 | 82005 |
| | 74 | 11/96 → 07/02 | 1.598 | B | M | 4 | 16 | X16XEL, Y16XE, Z16XE | M →: 20U75999, M →: 02MZ5254 | 81817 |
| 1.7 TD | 60 | 10/95 → 12/98 | 1.686 | D | M | 4 | 8 | X17DT (TC4EE1) | | 81746 |
| | 60 | 11/96 → 12/97 | 1.686 | D | M | 4 | 8 | X17DT (TC4EE1) | | 81847 |
| 1.8 i 16V | 85 | 10/95 → 09/00 | 1.796 | B | M | 4 | 16 | X18XE1, Z18XEL | → 12-1998, M: X18XE | 81550 |
| | 85 | 10/95 → 09/00 | 1.796 | B | M | 4 | 16 | X18XE1, Z18XEL | 01-1999 →, M: X18XE1 | 81751 |
| | 92 | 09/00 → 04/02 | 1.796 | B | M | 4 | 16 | Z18XE | | 81751 |
| | 85 | 10/95 → 09/00 | 1.799 | B | M | 4 | 16 | X18XE | | 81550 |
| 2.0 DI 16V | 60 | 11/96 → 04/02 | 1.995 | D | M | 4 | 16 | X20DTL | | 81747 |
| 2.0 DTI 16V | 74 | 06/97 → 04/02 | 1.995 | D | M | 4 | 16 | X20DTH, Y20DTH | | 81747 |
| 2.0 i | 82 | 10/95 → 04/02 | 1.998 | B | M | 4 | 8 | Z0NEJ | | 81551 |
| 2.0 i 16V | 100 | 10/95 → 09/00 | 1.998 | B | M | 4 | 16 | C20SEL, X20XEV | | 81550 |
| 2.2 DTI 16V | 88 | 09/00 → 04/02 | 2.172 | D | M | 4 | 16 | Y22DTR | | 81747 |
| | 92 | 09/00 → 04/02 | 2.172 | D | M | 4 | 16 | Y22DTR | | 81747 |
| 2.2 i 16V | 108 | 09/00 → 04/02 | 2.198 | B | M | 4 | 16 | C22SEL, Z22SE | | 81812 |
| 2.5 | 144 | 10/99 → 06/00 | 2.498 | B | M | 6 | 24 | X25XE | | 81846 |
| 2.5 i V6 | 125 | 10/95 → 09/00 | 2.498 | B | M | 6 | 24 | X25XE | | 81846 |
| 2.6 i V6 | 125 | 09/00 → 04/02 | 2.597 | B | M | 6 | 24 | Y26SE | | 81846 |
| i 500 2.5 | 143 | 05/98 → 09/00 | 2.498 | B | M | 6 | 24 | X25XE | | 81846 |

Vectra C, Station Wagon

| | | | | | | | | | | |
|---------------|-----|---------------|-------|---|---|---|----|--------|--|-------|
| 1.6 | 74 | 08/05 → | 1.598 | B | M | 4 | 16 | Z16XE | | 81817 |
| | 77 | 01/06 → | 1.598 | B | M | 4 | 16 | Z16XEP | | 82083 |
| 1.6 16V | 74 | 06/04 → | 1.598 | B | M | 4 | 16 | Z16XE | | 81817 |
| 1.8 | 81 | 04/02 → | 1.796 | B | M | 4 | 16 | Z18XEL | | 81751 |
| | 90 | 10/03 → | 1.796 | B | M | 4 | 16 | Z18XE | | 81751 |
| | 103 | 01/06 → | 1.796 | B | M | 4 | 16 | Z18XER | | 82083 |
| 1.8 16V | 81 | 08/02 → 12/06 | 1.796 | B | M | 4 | 16 | Z18XEL | | 81751 |
| | 90 | 04/02 → | 1.796 | B | M | 4 | 16 | Z18XE | | 81751 |
| 1.9 CDTI | 74 | 10/05 → | 1.910 | D | M | 4 | 8 | Z19DT | | 81352 |
| | 74 | 10/05 → | 1.910 | D | M | 4 | 8 | Z19DTL | | 81352 |
| | 88 | 04/04 → | 1.910 | D | M | 4 | 8 | Z19DT | | 81352 |
| | 110 | 04/04 → | 1.910 | D | M | 4 | 16 | Z19DTH | | 81872 |
| 2.0 16V Turbo | 129 | 03/03 → | 1.998 | B | M | 4 | 16 | Z20NET | | 81812 |
| 2.0 DTI | 74 | 10/03 → | 1.995 | D | M | 4 | 16 | Y20DTH | | 81747 |
| 2.0 DTI 16V | 74 | 04/02 → | 1.995 | D | M | 4 | 16 | Y20DTH | | 81747 |

KW

cm³

NO. OF VALVES

MAGNETI MARELLI
OPEL
Vectra C, Station Wagon

| | | | | | | | | | | |
|--------------|-----|---------------|-------|---|---|---|----|--------|--|------------------|
| 2.0 Turbo | 129 | 10/03 → | 1.998 | B | M | 4 | 16 | Z20NET | | 81812 |
| 2.2 16V | 108 | 04/02 → | 2.198 | B | M | 4 | 16 | Z22SE | | 81812 |
| 2.2 direct | 114 | 10/03 → | 2.198 | B | M | 4 | 16 | Z22YH | | 81812 |
| 2.2 DTI | 92 | 10/03 → | 2.172 | D | M | 4 | 16 | Y22DTR | | 81747 |
| 2.2 DTI 16V | 86 | 04/02 → 12/04 | 2.172 | D | M | 4 | 16 | Y22DTR | | 81747 |
| | 92 | 04/02 → | 2.172 | D | M | 4 | 16 | Y22DTR | | 81747 |
| 2.8 V6 Turbo | 169 | 08/05 → | 2.792 | B | M | 6 | 24 | Z28NEL | | 84057 NEW |
| | 184 | 08/06 → | 2.792 | B | M | 6 | 24 | Z28NET | | 84057 NEW |
| | 188 | 08/05 → | 2.792 | B | M | 6 | 24 | Z28NET | | 84057 NEW |
| | 206 | 08/06 → | 2.792 | B | M | 6 | 24 | Z28NET | | 84057 NEW |
| 3.2 V6 | 155 | 08/02 → | 3.175 | B | M | 6 | 24 | Z32SE | | 81846 |

Vivaro

| | | | | | | | | | | |
|------------|-----|---------|-------|---|---|---|----|--|--|-------|
| 1.9 DI | 60 | 08/01 → | 1.870 | D | M | 4 | 8 | F9Q762 | | 81814 |
| | 60 | 08/01 → | 1.870 | D | M | 4 | 8 | F9Q762 | | 84009 |
| | 60 | 08/01 → | 1.870 | D | M | 4 | 8 | F9Q762, F9Q774 | | 81814 |
| | 60 | 08/01 → | 1.870 | D | M | 4 | 8 | F9Q762, F9Q774 | | 84009 |
| 1.9 DTI | 74 | 08/01 → | 1.870 | D | M | 4 | 8 | F9Q760 | | 81814 |
| | 74 | 08/01 → | 1.870 | D | M | 4 | 8 | F9Q760 | | 84009 |
| 2.0 16V | 88 | 08/01 → | 1.998 | B | M | 4 | 16 | F4R720 | | 81814 |
| | 88 | 08/01 → | 1.998 | B | M | 4 | 16 | F4R720 | | 84009 |
| 2.0 CDTI | 66 | 08/06 → | 1.995 | D | M | 4 | 16 | M9R630, M9R780, M9R782, M9R786 | | 82069 |
| | 66 | 08/06 → | 1.995 | D | M | 4 | 16 | M9R780, M9R782, M9R786 | | 82069 |
| | 84 | 08/06 → | 1.995 | D | M | 4 | 16 | M9R630, M9R692, M9R780, M9R784, M9R786, M9R788 | | 82069 |
| | 84 | 08/06 → | 1.995 | D | M | 4 | 16 | M9R630, M9R780 | | 82069 |
| | 84 | 08/06 → | 1.995 | D | M | 4 | 16 | M9R692, M9R780, M9R784, M9R786, M9R788 | | 82069 |
| 2.0 ECOTEC | 86 | 08/06 → | 1.998 | B | M | 4 | 16 | F4R820 | | 81814 |
| | 86 | 08/06 → | 1.998 | B | M | 4 | 16 | F4R820 | | 84009 |
| 2.5 CDTI | 107 | 08/06 → | 2.463 | D | M | 4 | 16 | G9MB6, G9U630 | | 81855 |
| | 107 | 08/06 → | 2.463 | D | M | 4 | 16 | G9U630 | | 81855 |
| | 84 | 08/06 → | 2.464 | D | M | 4 | 16 | G9U630 | | 81855 |
| 2.5 DTI | 99 | 05/03 → | 2.463 | D | M | 4 | 16 | G9U730 | | 81855 |

KW

cm³

NO. OF VALVES

OPEL
Zafira A

| | | | | | | | | | | |
|-------------|-----|---------------|-------|---|---|---|----|----------------|---|-------|
| 1.6 16V | 74 | 04/99 → 06/05 | 1.598 | B | M | 4 | 16 | X16XEL, Z16XE | → 06-2000, → M: 02MV7224, → M: 20U75998, → M: 02MV7224 | 82005 |
| | 74 | 04/99 → 06/05 | 1.598 | B | M | 4 | 16 | X16XEL, Z16XE | 07-2000 →, M →: 02MV7225, M →: 20U75999, M →: 02MV7225 | 81817 |
| 1.6 CNG | 71 | 09/01 → 06/05 | 1.598 | | M | 4 | 16 | Z16YNG | | 81817 |
| 1.8 16V | 85 | 04/99 → 09/00 | 1.796 | B | M | 4 | 16 | X18XE1 | | 81751 |
| | 92 | 09/00 → 06/05 | 1.796 | B | M | 4 | 16 | Z18XE | | 81751 |
| 2.0 DI | 63 | 07/99 → 06/00 | 1.995 | D | M | 4 | 16 | X20DTL | | 81747 |
| 2.0 DI 16V | 60 | 07/99 → 06/05 | 1.995 | D | M | 4 | 16 | X20DTL | | 81747 |
| 2.0 DTI 16V | 74 | 09/00 → 06/05 | 1.995 | D | M | 4 | 16 | Y20DTH | | 81747 |
| 2.0 OPC | 141 | 09/01 → 06/05 | 1.998 | B | M | 4 | 16 | Z20LET | | 81550 |
| | 147 | 11/02 → 06/05 | 1.998 | B | M | 4 | 16 | Z20LER, Z20LET | | 81550 |
| 2.2 16V | 108 | 09/00 → 06/05 | 2.198 | B | M | 4 | 16 | Z22SE | | 81812 |
| 2.2 DTI 16V | 86 | 01/02 → 06/05 | 2.172 | D | M | 4 | 16 | Y22DTR | | 81747 |
| | 92 | 01/02 → 06/05 | 2.172 | D | M | 4 | 16 | Y22DTR | | 81747 |

Zafira B, Van

| | | | | | | | | | | |
|---------------|-----|---------|-------|---|---|---|----|----------------|--------------|-------|
| 1.6 | 77 | 07/05 → | 1.598 | B | M | 4 | 16 | Z16XE1, Z16XEP | | 82083 |
| | 85 | 01/08 → | 1.598 | B | M | 4 | 16 | A16XER, Z16XER | | 82083 |
| 1.6 CNG | 69 | 01/06 → | 1.598 | | M | 4 | 16 | Z16YNG | | 81817 |
| 1.6 CNG Turbo | 110 | 02/09 → | 1.598 | | M | 4 | 16 | A16XNT, Z16XNT | | 81817 |
| | 110 | 02/09 → | 1.598 | | M | 4 | 16 | A16XNT, Z16XNT | | 82083 |
| 1.7 CDTI | 81 | 01/08 → | 1.686 | D | M | 4 | 16 | A17DTJ, Z17DTJ | → T: 1874032 | 81836 |
| | 81 | 01/08 → | 1.686 | D | M | 4 | 16 | A17DTJ, Z17DTJ | T →: 1874033 | 84005 |
| | 81 | 01/08 → | 1.686 | D | M | 4 | 16 | A17DTJ, Z17DTJ | | 81836 |
| | 81 | 01/08 → | 1.686 | D | M | 4 | 16 | A17DTJ, Z17DTJ | | 84005 |
| | 92 | 01/08 → | 1.686 | D | M | 4 | 16 | A17DTR | → T: 1874032 | 81836 |
| | 92 | 01/08 → | 1.686 | D | M | 4 | 16 | A17DTR | T →: 1874033 | 84005 |
| | 92 | 01/08 → | 1.686 | D | M | 4 | 16 | A17DTR | | 81836 |
| | 92 | 01/08 → | 1.686 | D | M | 4 | 16 | A17DTR | | 84005 |
| 1.8 | 88 | 06/13 → | 1.796 | B | M | 4 | 16 | A18XEL | | 82083 |
| | 103 | 07/05 → | 1.796 | B | M | 4 | 16 | A18XER, Z18XER | | 82083 |
| 1.9 CDTI | 74 | 07/05 → | 1.910 | D | M | 4 | 8 | Z19DTL | | 81352 |
| | 88 | 07/05 → | 1.910 | D | M | 4 | 8 | Z19DT | | 81352 |
| | 110 | 07/05 → | 1.910 | D | M | 4 | 16 | Z19DTH | | 81872 |
| 2.0 | 147 | 07/05 → | 1.998 | B | M | 4 | 16 | Z20LER | | 81550 |
| | 177 | 01/06 → | 1.998 | B | M | 4 | 16 | Z20LEH | | 81550 |
| 2.2 | 110 | 07/05 → | 2.198 | B | M | 4 | 16 | Z22YH | | 81812 |

KW

cm³

NO. OF VALVES

MAGNETI MARELLI
OPEL
Zafira C

| | | | | | | | | | | | |
|------------------|-----|---------|-------|---|---|---|----|-----------------------|--|-------|------------|
| 1.4 < | 88 | 10/11 → | 1.364 | B | M | 4 | 16 | A14NEL, B14NEL | | 84027 | NEW |
| | 103 | 10/11 → | 1.364 | B | M | 4 | 16 | A14NET, B14NET | | 84027 | NEW |
| 1.4 LPG | 103 | 10/11 → | 1.364 | | M | 4 | 16 | A14NET, B14NET | | 84027 | NEW |
| 1.6 CNG | 110 | 10/11 → | 1.598 | | M | 4 | 16 | A16XNT, B16XNT | | 82083 | |
| 1.8 | 85 | 10/11 → | 1.796 | B | M | 4 | 16 | A18XEL | | 82083 | |
| | 88 | 10/11 → | 1.796 | B | M | 4 | 16 | A18XEL | | 82083 | |
| | 103 | 10/11 → | 1.796 | B | M | 4 | 16 | A18XER | | 82083 | |
| 1.8 LPG | 101 | 10/11 → | 1.796 | | M | 4 | 16 | A18XER | | 82083 | |
| 2.0 BiTurbo CDTI | 143 | 01/13 → | 1.956 | D | M | 4 | 16 | A20DTR | | 81872 | |
| 2.0 CDTi | 81 | 10/11 → | 1.956 | D | M | 4 | 16 | A20DTL | | 81872 | |
| | 96 | 10/11 → | 1.956 | D | M | 4 | 16 | A20DT, Y20DTJ, Z20DTJ | | 81872 | |
| | 118 | 10/11 → | 1.956 | D | M | 4 | 16 | A20DTH | | 81872 | |
| | 121 | 10/11 → | 1.956 | D | M | 4 | 16 | A20DTH | | 81872 | |

PEUGEOT
106 I, Van

| | | | | | | | | | | | |
|-------|----|---------------|-------|---|---|---|---|-------------------------|--|-------|--|
| 1.0 | 33 | 09/91 → 03/01 | 954 | B | M | 4 | 8 | CDY (TU9M), TU9 | | 81797 | |
| | 33 | 09/91 → 04/96 | 954 | B | M | 4 | 8 | CDY (TU9M), TU9 | | 81556 | |
| | 37 | 09/91 → 04/96 | 954 | B | M | 4 | 8 | CDZ (TU9M) | | 81556 | |
| 1.1 | 44 | 09/91 → 04/96 | 1.124 | B | M | 4 | 8 | HDZ (TU1M) | | 81556 | |
| 1.3 | 72 | 10/93 → 04/96 | 1.294 | B | M | 4 | 8 | TU2J2 | | 81556 | |
| 1.4 | 51 | 08/91 → 03/96 | 1.360 | B | M | 4 | 8 | K5A (TU3) | | 81556 | |
| | 55 | 09/91 → 04/96 | 1.361 | B | M | 4 | 8 | KDX (TU3MC), KDY (TU3M) | | 81556 | |
| | 69 | 09/91 → 04/96 | 1.361 | B | M | 4 | 8 | KFZ (TU3J2/Z) | | 81556 | |
| 1.4 D | 37 | 09/92 → 04/96 | 1.361 | D | M | 4 | 8 | K9Y (TUD3Y) | | 81556 | |
| 1.5 D | 40 | 06/94 → 04/96 | 1.527 | D | M | 4 | 8 | VJY (TUD5) | | 81513 | |
| | 42 | 10/00 → 03/01 | 1.527 | D | M | 4 | 8 | VJX (TUD5) | | 81513 | |
| | 43 | 06/94 → 04/96 | 1.527 | D | M | 4 | 8 | VJY (TUD5) | | 81513 | |
| 1.6 | 65 | 06/93 → 04/96 | 1.587 | B | M | 4 | 8 | NFZ (TU5JP) | | 81556 | |
| | 76 | 01/94 → 04/96 | 1.587 | B | M | 4 | 8 | NFY (TU5J2) | | 81513 | |

106 II

| | | | | | | | | | | | |
|-------|----|---------|-------|---|---|---|---|--------------------------|-----------|-------|--|
| 1.0 i | 33 | 05/96 → | 954 | B | M | 4 | 8 | CDY (TU9M) | | 81556 | |
| | 37 | 01/97 → | 954 | B | M | 4 | 8 | CDZ (TU9M) | | 81556 | |
| 1.1 i | 40 | 01/97 → | 1.124 | B | M | 4 | 8 | HDY (TU1M) | | 81556 | |
| | 44 | 05/96 → | 1.124 | B | M | 4 | 8 | HDZ (TU1M), HFX (TU1JP) | | 81556 | |
| 1.4 i | 55 | 05/96 → | 1.360 | B | M | 4 | 8 | KFW (TU3JP), KFX (TU3JP) | | 81556 | |
| 1.5 D | 40 | 05/96 → | 1.527 | D | M | 4 | 8 | VJY (TUD5) | 04-1996 → | 81513 | |
| | 42 | 04/98 → | 1.527 | D | M | 4 | 8 | VJX (TUD5) | | 81513 | |

| | | | | | | | | | |
|--|--|--|--|--|--|--|--|--|--|
| | | | | | | | | | |
|--|--|--|--|--|--|--|--|--|--|

PEUGEOT

106 II

| | | | | | | | | | | |
|---------|----|---------|-------|---|---|---|----|-----------------------------|--|-------|
| 1.6 i | 65 | 05/96 → | 1.587 | B | M | 4 | 8 | NFZ (TU5JP) | | 81556 |
| | 74 | 05/96 → | 1.587 | B | M | 4 | 8 | NFW (TU5J2), NFY (TU5J2) | | 81513 |
| 1.6 S16 | 87 | 05/96 → | 1.587 | B | M | 4 | 16 | NFX (TU5J4) | | 81753 |

107

| | | | | | | | | | | |
|---------|----|---------|-------|---|---|---|----|------------------------|--|-------|
| 1.0 | 50 | 06/05 → | 998 | B | M | 3 | 12 | 1KR (384F), CFA (384F) | | 82063 |
| 1.4 HDi | 40 | 06/05 → | 1.398 | D | M | 4 | 8 | 8HT (DV4TD) | | 81798 |

108

| | | | | | | | | | | |
|---------|----|---------|-------|---|---|---|----|------------|--|-------|
| 1.0 VTi | 51 | 05/14 → | 998 | B | M | 3 | 12 | 1KR-FE | | 84054 |
| 1.2 | 60 | 05/14 → | 1.199 | B | M | 3 | 12 | HMT (EB2D) | | 84066 |

205 I, Van, Cabrio

| | | | | | | | | | | |
|-------------|----|---------------|-------|---|---|---|---|-----------------------------|-----------|-------|
| 1.1 CJ | 44 | 10/89 → 12/94 | 1.124 | B | M | 4 | 8 | HDZ (TU1M) | | 81556 |
| 1.4 | 62 | 08/87 → 06/94 | 1.360 | B | M | 4 | 8 | K2B (TU3S) | | 81572 |
| 1.4 CJ | 49 | 03/89 → 12/94 | 1.360 | B | M | 4 | 8 | K1D (TU3A) | | 81556 |
| | 55 | 05/91 → 12/94 | 1.361 | B | M | 4 | 8 | KDY (TU3M), KDZ (TU3M) | | 81556 |
| 1.4 CJ Cat. | 44 | 01/89 → 09/93 | 1.361 | B | M | 4 | 8 | KAY (TU3CP) | | 81572 |
| 1.6 | 85 | 08/87 → 07/92 | 1.580 | B | M | 4 | 8 | B6D (XU5JA) | | 81554 |
| 1.6 CJ | 65 | 08/92 → 12/94 | 1.580 | B | M | 4 | 8 | BDY (XU5M3Z) | | 81512 |
| 1.6 CTI | 76 | 04/86 → 10/90 | 1.580 | B | M | 4 | 8 | 180A (XU5J), 180Z (XU5J) | | 81554 |
| 1.9 CTI | 75 | 10/87 → 12/94 | 1.905 | B | M | 4 | 8 | DFZ (XU9J1) | → 12-1991 | 81554 |
| | 75 | 10/87 → 12/94 | 1.905 | B | M | 4 | 8 | DFZ (XU9J1) | 01-1992 → | 81512 |
| | 92 | 08/90 → 07/92 | 1.905 | B | M | 4 | 8 | DKZ (XU9JAZ) | | 81554 |

205 II, Van

| | | | | | | | | | | |
|------------|----|---------------|-------|---|---|---|----|---|----------------|-------|
| 1.0 | 33 | 10/87 → 09/98 | 954 | B | M | 4 | 8 | TU9 | | 81556 |
| | 37 | 08/92 → 05/97 | 954 | B | M | 4 | 8 | CDZ (TU9M) | | 81556 |
| 1.1 | 36 | 10/87 → 10/90 | 1.124 | B | M | 4 | 8 | 109N (XW7) | | 81572 |
| | 40 | 10/87 → 10/90 | 1.124 | B | M | 4 | 8 | H1B (TU1) | | 81556 |
| | 40 | 08/98 → 07/00 | 1.124 | B | M | 4 | 8 | HFY (TU1JP) | → M: 3.762.433 | 81556 |
| | 40 | 08/98 → 07/00 | 1.124 | B | M | 4 | 8 | HFY (TU1JP) | M →: 3.762.434 | 81797 |
| | 44 | 07/89 → 09/98 | 1.124 | B | M | 4 | 8 | HDZ (TU1M) | | 81556 |
| 1.1 i | 44 | 09/98 → | 1.124 | B | M | 4 | 8 | HFX (TU1JP), HFZ (TU1JP) | → M: 3.762.433 | 81556 |
| | 44 | 09/98 → | 1.124 | B | M | 4 | 8 | HFX (TU1JP), HFZ (TU1JP) | M →: 3.762.434 | 81797 |
| 1.2 | 47 | 01/87 → 12/90 | 1.204 | B | M | 4 | 8 | F1 | | 81560 |
| 1.3 | 47 | 08/90 → 07/92 | 1.294 | B | M | 4 | 8 | G1A | | 81560 |
| 1.3 Rallye | 74 | 10/87 → 10/90 | 1.294 | B | M | 4 | 8 | TU24 | | 81556 |
| 1.4 | 49 | 10/87 → 10/90 | 1.360 | B | M | 4 | 8 | K1D (TU3A) | | 81556 |
| | 55 | 07/88 → 09/98 | 1.361 | B | M | 4 | 8 | KDY (TU3M), KDZ (TU3M), KFX (TU3JP) | | 81556 |
| 1.4 16V | 65 | 10/03 → | 1.360 | B | M | 4 | 16 | KFU (ET3J4) | | 82016 |

KW

cm³

NO. OF VALVES

MAGNETI MARELLI
PEUGEOT
205 II, Van

| | | | | | | | | | | |
|----------------|-----|---------------|-------|---|----|---|----|---------------------------------|----------------|------------------|
| 1.4 Cat. | 44 | 08/87 → 09/93 | 1.360 | B | M | 4 | 8 | KAY (TU3CP) | | 81556 |
| 1.4 HDi | 51 | 09/02 → 02/07 | 1.398 | D | M | 4 | 8 | 8HX (DV4TD) | | 81798 |
| 1.4 HDi eco 70 | 50 | 09/01 → | 1.398 | D | M | 4 | 8 | 8HX (DV4TD), 8HZ (DV4TD) | | 81798 |
| 1.4 i | 55 | 09/98 → | 1.360 | B | M | 4 | 8 | KFW (TU3JP), KFX (TU3JP) | → M: 3.666.765 | 81556 |
| | 55 | 09/98 → | 1.360 | B | M | 4 | 8 | KFW (TU3JP), KFX (TU3JP) | M →: 3.666.766 | 81797 |
| 1.4 LPG | 55 | 05/06 → 09/07 | 1.360 | | M | 4 | 8 | KFV (TU3JP) | | 81797 |
| | 55 | 05/06 → 09/07 | 1.360 | | M | 4 | 8 | KFV (TU3JP) | | 81556 |
| 1.6 | 53 | 10/87 → 09/98 | 1.580 | B | M | 4 | 8 | B1E (XU51C) | | 81554 |
| | 55 | 10/87 → 09/98 | 1.580 | B | M | 4 | 8 | B1A (XU51C), BAZ (XU5CP) | | 81554 |
| 1.6 16V | 80 | 12/00 → | 1.587 | B | AM | 4 | 16 | NFU (TU5JP4) | | 81753 |
| 1.6 Aut. | 58 | 10/87 → 09/98 | 1.580 | B | M | 4 | 8 | | → 12-1991 | 81554 |
| | 58 | 10/87 → 09/98 | 1.580 | B | M | 4 | 8 | | 01-1992 → | 81512 |
| | 65 | 05/90 → 09/98 | 1.580 | B | M | 4 | 8 | BDY (XU5M2Z), BDY (XU5M3Z) | | 81512 |
| 1.6 GTX | 69 | 01/87 → 10/91 | 1.592 | B | M | 4 | 8 | | | 81560 |
| 1.6 HDi 110 | 80 | 05/04 → | 1.560 | D | M | 4 | 16 | 9HY (DV6TED4), 9HZ (DV6TED4) | | 81869 |
| 1.6 i | 65 | 09/98 → 12/00 | 1.587 | B | M | 4 | 8 | NFZ (TU5JP) | | 81513 |
| 1.7 Diesel | 44 | 07/87 → 09/98 | 1.769 | D | M | 4 | 8 | 161A (XUD7) | | 81672 |
| | 44 | 03/94 → | 1.769 | D | M | 4 | 8 | 161A (XUD7) | | 81642 |
| 1.8 TD | 57 | 01/90 → 09/98 | 1.769 | D | M | 4 | 8 | A8B (XUD7TE) | | 81672 |
| 1.9 D | 51 | 09/98 → 11/01 | 1.868 | D | M | 4 | 8 | WJY (DW8B), WJZ (DW8) | | 81713 |
| 1.9 Diesel | 47 | 10/87 → 09/98 | 1.905 | D | M | 4 | 8 | DJZ (XUD9Y) | | 81672 |
| 1.9 GTI | 88 | 10/87 → 10/94 | 1.905 | B | M | 4 | 8 | DKZ (XU9JAZ) | → 12-1991 | 81554 |
| | 88 | 10/87 → 10/94 | 1.905 | B | M | 4 | 8 | DKZ (XU9JAZ) | 01-1992 → | 81512 |
| | 94 | 10/87 → 09/98 | 1.905 | B | M | 4 | 8 | D6B (XU9JA) | → 12-1991 | 81554 |
| | 94 | 10/87 → 09/98 | 1.905 | B | M | 4 | 8 | D6B (XU9JA) | 01-1992 → | 81512 |
| 1.9 GTI Cat. | 75 | 10/87 → 07/94 | 1.905 | B | M | 4 | 8 | DFZ (XU9J1) | → 12-1991 | 81554 |
| | 75 | 10/87 → 07/94 | 1.905 | B | M | 4 | 8 | DFZ (XU9J1) | 01-1992 → | 81512 |
| 2.0 HDi 90 | 66 | 12/99 → | 1.997 | D | M | 4 | 8 | RHY (DW10TD) | | 81713 |
| 2.0 RC | 130 | 07/03 → | 1.997 | B | M | 4 | 16 | RFK (EW10J4S) | (-)COP | 84038 NEW |
| | 130 | 07/03 → | 1.997 | B | M | 4 | 16 | RFK (EW10J4S) | (+)COP | 82089 |
| | 130 | 07/03 → | 1.997 | B | M | 4 | 16 | RFK (EW10J4S) | | 82089 |
| | 130 | 07/03 → | 1.997 | B | M | 4 | 16 | RFK (EW10J4S) | | 81799 |

KW

cm³

NO. OF VALVES

PEUGEOT
205 II, Van

| | | | | | | | | | | | |
|---------|-----|---------------|-------|---|---|---|----|---------------|--------|-------|------------|
| 2.0 S16 | 99 | 04/99 → 10/00 | 1.997 | B | M | 4 | 16 | RFR (DEW10J4) | (-)COP | 84038 | NEW |
| | 99 | 04/99 → 10/00 | 1.997 | B | M | 4 | 16 | RFR (DEW10J4) | (+)COP | 82089 | |
| | 99 | 04/99 → 10/00 | 1.997 | B | M | 4 | 16 | RFR (DEW10J4) | | 82089 | |
| | 99 | 04/99 → 10/00 | 1.997 | B | M | 4 | 16 | RFR (DEW10J4) | | 81799 | |
| | 100 | 06/99 → | 1.997 | B | M | 4 | 16 | RFN (EW10J4) | (-)COP | 84038 | NEW |
| | 100 | 06/99 → | 1.997 | B | M | 4 | 16 | RFN (EW10J4) | (+)COP | 82089 | |
| | 100 | 06/99 → | 1.997 | B | M | 4 | 16 | RFN (EW10J4) | | 82089 | |
| | 100 | 06/99 → | 1.997 | B | M | 4 | 16 | RFN (EW10J4) | | 81799 | |

206 +

| | | | | | | | | | | | |
|----------------|----|---------|-------|---|---|---|---|------------------------------------|--|-------|--|
| 1.1 | 44 | 01/09 → | 1.124 | B | M | 4 | 8 | HFX (TU1A), HFX (TU1JP), TU1AE5 | | 81797 | |
| 1.4 HDi eco 70 | 50 | 01/09 → | 1.398 | D | M | 4 | 8 | 8HX (DV4TD), 8HZ (DV4TD) | | 81798 | |
| 1.4 i | 54 | 09/10 → | 1.360 | B | M | 4 | 8 | KFT (TU3A) | | 81797 | |
| | 55 | 01/09 → | 1.360 | B | M | 4 | 8 | KFV (TU3A), KFW (TU3A) | | 81797 | |

206, CC, Van

| | | | | | | | | | | | |
|----------------|-----|---------------|-------|---|----|---|----|-----------------------------|----------------|-------|------------|
| 1.1 | 44 | 07/02 → | 1.124 | B | M | 4 | 8 | HFX (TU1JP) | → M: 3.762.433 | 81556 | |
| | 44 | 07/02 → | 1.124 | B | M | 4 | 8 | HFX (TU1JP) | M →: 3.762.434 | 81797 | |
| 1.4 | 55 | 07/02 → | 1.360 | B | M | 4 | 8 | KFV (TU3A), KFW (TU3JP) | → M: 3.666.765 | 81556 | |
| | 55 | 07/02 → | 1.360 | B | M | 4 | 8 | KFV (TU3A), KFW (TU3JP) | M →: 3.666.766 | 81797 | |
| | 55 | 03/07 → | 1.360 | B | M | 4 | 8 | KFV (TU3A), KFW (TU3JP) | | 81797 | |
| 1.4 16V | 65 | 10/03 → | 1.360 | B | M | 4 | 16 | KFU (ET3J4) | | 82016 | |
| 1.4 HDi | 50 | 07/02 → | 1.398 | D | M | 4 | 8 | 8HX (DV4TD) | | 81798 | |
| | 50 | 09/01 → 03/09 | 1.398 | D | M | 4 | 8 | 8HX (DV4TD), 8HZ (DV4TD) | | 81798 | |
| 1.4 HDi eco 70 | 50 | 09/08 → | 1.398 | D | M | 4 | 8 | 8HZ (DV4TD) | | 81798 | |
| 1.6 16V | 80 | 07/02 → | 1.587 | B | M | 4 | 16 | NFU (TU5JP4) | | 81753 | |
| | 80 | 09/00 → | 1.587 | B | AM | 4 | 16 | NFU (TU5JP4) | | 81753 | |
| 1.6 HDi 110 | 80 | 04/05 → | 1.560 | D | M | 4 | 16 | 9HZ (DV6TED4) | | 81869 | |
| 1.9 D | 51 | 04/99 → 05/07 | 1.868 | D | M | 4 | 8 | WJZ (DW8) | | 81713 | |
| 2.0 16V | 100 | 07/02 → | 1.997 | B | M | 4 | 16 | RFN (EW10J4) | (-)COP | 84038 | NEW |
| | 100 | 07/02 → | 1.997 | B | M | 4 | 16 | RFN (EW10J4) | (+)COP | 82089 | |
| | 100 | 07/02 → | 1.997 | B | M | 4 | 16 | RFN (EW10J4) | | 82089 | |
| | 100 | 07/02 → | 1.997 | B | M | 4 | 16 | RFN (EW10J4) | | 81799 | |
| 2.0 HDi | 66 | 07/02 → | 1.997 | D | M | 4 | 8 | RHY (DW10TD) | | 81713 | |
| 2.0 S16 | 100 | 09/00 → | 1.997 | B | M | 4 | 16 | RFN (EW10J4) | (-)COP | 84038 | NEW |
| | 100 | 09/00 → | 1.997 | B | M | 4 | 16 | RFN (EW10J4) | (+)COP | 82089 | |
| | 100 | 09/00 → | 1.997 | B | M | 4 | 16 | RFN (EW10J4) | | 82089 | |
| | 100 | 09/00 → | 1.997 | B | M | 4 | 16 | RFN (EW10J4) | | 81799 | |

KW

cm³

NO. OF VALVES

MAGNETI MARELLI
PEUGEOT
207, Station Wagon, CC, Van

| | | | | | | | | | |
|---------------|-----|---------|-------|---|---|---|----|----------------------------------|-------|
| 1.4 | 53 | 02/06 → | 1.360 | B | M | 4 | 8 | KFV (TU3A) | 81797 |
| | 54 | 12/07 → | 1.360 | B | M | 4 | 8 | KFT (TU3A), KFV (TU3A) | 81797 |
| | 54 | 12/07 → | 1.360 | B | M | 4 | 8 | KFV (TU3A) | 81797 |
| | 55 | 08/08 → | 1.360 | B | M | 4 | 8 | KFV (TU3A), KFW (TU3A) | 81797 |
| 1.4 16V | 65 | 02/06 → | 1.360 | B | M | 4 | 16 | KFU (ET3J4) | 82016 |
| | 70 | 06/07 → | 1.397 | B | M | 4 | 16 | 8FS (EP3), EP3, EP3C | 82032 |
| | 70 | 06/07 → | 1.397 | B | M | 4 | 16 | 8FS (EP3), EP3, EP3C | 82016 |
| | 72 | 10/09 → | 1.397 | B | M | 4 | 16 | 8FR (EP3) | 82032 |
| 1.4 Bioflex | 60 | 08/08 → | 1.360 | | M | 4 | 8 | KFW (TU3JP) | 81797 |
| 1.4 Flex | 60 | 11/08 → | 1.360 | | M | 4 | 8 | KFW (TU3A) | 81797 |
| 1.4 HDi | 50 | 02/06 → | 1.398 | D | M | 4 | 8 | 8HR (DV4C), 8HZ (DV4TD) | 81798 |
| | 50 | 04/07 → | 1.398 | D | M | 4 | 8 | 8HZ (DV4TD) | 81798 |
| 1.6 | 81 | 08/08 → | 1.587 | B | M | 4 | 16 | N6A (TU5JP4) | 81753 |
| 1.6 16V | 80 | 02/06 → | 1.587 | B | M | 4 | 16 | NFU (TU5JP4) | 81753 |
| | 88 | 02/07 → | 1.598 | B | M | 4 | 16 | 5FS (EP6C), 5FW (EP6), EP6 | 82032 |
| 1.6 16V RC | 128 | 02/07 → | 1.598 | B | M | 4 | 16 | 5FY (EP6DTS) | 82032 |
| 1.6 16V Turbo | 110 | 02/06 → | 1.598 | B | M | 4 | 16 | 5FX (EP6DT) | 82032 |
| | 115 | 10/09 → | 1.598 | B | M | 4 | 16 | 5FR (EP6DT) | 82032 |
| | 115 | 10/09 → | 1.598 | B | M | 4 | 16 | 5FR (EP6DT), EP6CDT | 82032 |
| 1.6 16V VTi | 88 | 02/07 → | 1.598 | B | M | 4 | 16 | 5FS (EP6C), 5FW (EP6), EP6 | 82032 |
| 1.6 Bioflex | 83 | 01/08 → | 1.587 | | M | 4 | 16 | N6A (TU5JP4) | 81753 |
| 1.6 HDi | 66 | 02/06 → | 1.560 | D | M | 4 | 16 | 9HV (DV6TED4), 9HX (DV6ATED4) | 81869 |
| | 66 | 06/07 → | 1.560 | D | M | 4 | 16 | 9HX (DV6ATED4) | 81869 |
| | 68 | 11/09 → | 1.560 | D | M | 4 | 8 | 9HP (DV6DTED) | 81869 |
| | 80 | 02/06 → | 1.560 | D | M | 4 | 16 | 9HY (DV6TED4), 9HZ (DV6TED4) | 81869 |
| | 80 | 02/07 → | 1.560 | D | M | 4 | 16 | 9HZ (DV6TED4) | 81869 |
| | 82 | 08/09 → | 1.560 | D | M | 4 | 8 | 9HR (DV6C) | 81869 |
| 1.6 HDi 110 | 82 | 08/09 → | 1.560 | D | M | 4 | 8 | 9HR (DV6C) | 81869 |
| 208 | | | | | | | | | |
| 1.0 | 50 | 03/12 → | 999 | B | M | 3 | 12 | ZMZ (EB0) | 84066 |
| 1.2 | 60 | 03/12 → | 1.199 | B | M | 3 | 12 | HMZ (EB2F) | 84066 |
| 1.2 THP | 81 | 01/13 → | 1.199 | B | M | 3 | 12 | HNZ (EB2DT) | 84066 |
| 1.4 GPL | 70 | 10/13 → | 1.397 | | M | 4 | 16 | EP3C | 82032 |
| 1.4 HDi | 50 | 03/12 → | 1.398 | D | M | 4 | 8 | 8HP (DV4C), 8HR (DV4C) | 81798 |
| 1.4 VTi | 70 | 03/12 → | 1.397 | B | M | 4 | 16 | 8FS (EP3), EP3C | 82032 |

| | | | | | | | | | | |
|--|----|--|-----------------|--|--|--|---------------|--|--|--|
| | KW | | cm ³ | | | | NO. OF VALVES | | | |
|--|----|--|-----------------|--|--|--|---------------|--|--|--|

PEUGEOT

208

| | | | | | | | | | | |
|----------------------|-----|---------|-------|---|---|---|----|--------------------------------|--|-------|
| 1.6 | 88 | 03/12 → | 1.598 | B | M | 4 | 16 | 5FS (EP6C) | | 82032 |
| | 115 | 03/12 → | 1.598 | B | M | 4 | 16 | 5FV (EP6DT), EP6CDT | | 82032 |
| 1.6 BlueHdI 100 | 73 | 01/15 → | 1.560 | D | M | 4 | 8 | BHY (DV6FD) | | 81869 |
| 1.6 BlueHdI 120 | 88 | 11/13 → | 1.560 | D | M | 4 | 8 | BHZ (DV6FC) | | 81869 |
| 1.6 GTi | 147 | 08/12 → | 1.598 | B | M | 4 | 16 | 5FU (EP6CDTX) | | 82032 |
| | 153 | 10/14 → | 1.598 | B | M | 4 | 16 | | | 82032 |
| 1.6 HdI | 68 | 03/12 → | 1.560 | D | M | 4 | 8 | 9HP (DV6DTED) | | 81869 |
| | 84 | 03/12 → | 1.560 | D | M | 4 | 8 | 9HD (DV6CTED) | | 81869 |
| | 85 | 04/14 → | 1.560 | D | M | 4 | 8 | BHX (DV6FC) | | 81869 |
| 1.6 HdI / BlueHdI 75 | 55 | 01/13 → | 1.560 | D | M | 4 | 8 | 9HK (DV6ETEDM), BHW (DV6FE) | | 81869 |
| 1.6 THP 165 | 121 | 03/15 → | 1.598 | B | M | 4 | 16 | | | 82032 |

301

| | | | | | | | | | | |
|-------------|----|---------|-------|---|---|---|----|---------------|--|------------------|
| 1.2 VTi 72 | 53 | 11/12 → | 1.199 | B | M | 3 | 12 | HMY (EB2M) | | 84066 NEW |
| 1.6 HdI 90 | 68 | 11/12 → | 1.560 | D | M | 4 | 8 | 9HF (DV6DTED) | | 81869 |
| 1.6 VTi 115 | 85 | 11/12 → | 1.587 | B | M | 4 | 16 | NFP (EC5) | | 81753 |

305 II, Station Wagon

| | | | | | | | | | | |
|-----|----|---------------|-------|---|---|---|---|------------|--------|-------|
| 1.5 | 50 | 09/85 → 07/90 | 1.472 | B | M | 4 | 8 | 142 (XR5A) | VA, BC | 81552 |
| | 50 | 09/85 → 07/90 | 1.472 | B | M | 4 | 8 | 142 (XR5A) | VF, BC | 81671 |

306, Station Wagon, Coupé, Cabrio, Van

| | | | | | | | | | | |
|---------|----|---------------|-------|---|---|---|----|---|----------------|-------|
| 1.1 | 44 | 06/94 → 05/01 | 1.124 | B | M | 4 | 8 | HDZ (TU1M) | | 81556 |
| 1.4 | 55 | 05/93 → 05/01 | 1.360 | B | M | 4 | 8 | KDX (TU3MC), KFW (TU3JP), KFX (TU3JP) | → M: 3.666.765 | 81556 |
| | 55 | 05/93 → 05/01 | 1.360 | B | M | 4 | 8 | KDX (TU3MC), KFW (TU3JP), KFX (TU3JP) | M →: 3.666.766 | 81797 |
| | 55 | 03/97 → 04/02 | 1.360 | B | M | 4 | 8 | KFW (TU3JP), KFX (TU3JP) | → M: 3.666.765 | 81556 |
| | 55 | 03/97 → 04/02 | 1.360 | B | M | 4 | 8 | KFW (TU3JP), KFX (TU3JP) | M →: 3.666.766 | 81797 |
| 1.4 SL | 55 | 06/94 → 05/01 | 1.360 | B | M | 4 | 8 | KDX (TU3MC), KFW (TU3JP), KFX (TU3JP) | → M: 3.666.765 | 81556 |
| | 55 | 06/94 → 05/01 | 1.360 | B | M | 4 | 8 | KDX (TU3MC), KFW (TU3JP), KFX (TU3JP) | M →: 3.666.766 | 81797 |
| 1.6 | 65 | 05/93 → 10/00 | 1.587 | B | M | 4 | 8 | NFZ (TU5JP) | | 81513 |
| | 72 | 10/00 → 05/01 | 1.587 | B | M | 4 | 8 | NFT (TU5JP) | | 81513 |
| 1.6 SR | 65 | 06/94 → 10/00 | 1.587 | B | M | 4 | 8 | NFZ (TU5JP) | | 81513 |
| 1.8 | 74 | 05/93 → 05/01 | 1.762 | B | M | 4 | 8 | LFZ (XU7JP) | | 81512 |
| 1.8 16V | 81 | 03/97 → 05/01 | 1.761 | B | M | 4 | 16 | LFY (XU7JP4) | | 81710 |
| 1.8 D | 43 | 05/93 → 05/01 | 1.769 | D | M | 4 | 8 | A9A (XUD7) | → PROD: 7390 | 81672 |
| | 43 | 05/93 → 05/01 | 1.769 | D | M | 4 | 8 | A9A (XUD7) | PROD →: 7391 | 81642 |

KW

cm³

NO. OF VALVES

PEUGEOT
306, Station Wagon, Coupé, Cabrio, Van

| | | | | | | | | | | |
|------------|-----|---------------|-------|---|---|---|----|--------------------------|--------------|-------|
| 1.8 ST | 74 | 06/94 → 05/01 | 1.762 | B | M | 4 | 8 | LFZ (XU7JP) | | 81512 |
| 1.9 D | 51 | 09/98 → 05/01 | 1.868 | D | M | 4 | 8 | WJY (DW8B), WJZ (DW8) | | 81713 |
| | 47 | 05/93 → 05/01 | 1.905 | D | M | 4 | 8 | DJZ (XUD9Y) | → PROD: 7390 | 81672 |
| | 47 | 05/93 → 05/01 | 1.905 | D | M | 4 | 8 | DJZ (XUD9Y) | PROD →: 7391 | 81642 |
| | 50 | 06/94 → 05/01 | 1.905 | D | M | 4 | 8 | DJY (XUD9A) | → PROD: 7390 | 81672 |
| | 50 | 06/94 → 05/01 | 1.905 | D | M | 4 | 8 | DJY (XUD9A) | PROD →: 7391 | 81642 |
| | 55 | 03/98 → 05/01 | 1.905 | D | M | 4 | 8 | DHV (XUD9BSD) | → PROD: 7390 | 81672 |
| | 55 | 03/98 → 05/01 | 1.905 | D | M | 4 | 8 | DHV (XUD9BSD) | PROD →: 7391 | 81642 |
| 1.9 DT | 66 | 05/93 → 05/01 | 1.905 | D | M | 4 | 8 | DHY (XUD9TE) | → PROD: 7390 | 81672 |
| | 66 | 05/93 → 05/01 | 1.905 | D | M | 4 | 8 | DHY (XUD9TE) | PROD →: 7391 | 81642 |
| 1.9 SLD | 47 | 06/94 → 05/01 | 1.905 | D | M | 4 | 8 | DJZ (XUD9Y) | → PROD: 7390 | 81672 |
| | 47 | 06/94 → 05/01 | 1.905 | D | M | 4 | 8 | DJZ (XUD9Y) | PROD →: 7391 | 81642 |
| | 50 | 06/94 → 05/01 | 1.905 | D | M | 4 | 8 | DJY (XUD9A) | → PROD: 7390 | 81672 |
| | 50 | 06/94 → 05/01 | 1.905 | D | M | 4 | 8 | DJY (XUD9A) | PROD →: 7391 | 81642 |
| 1.9 SRDT | 66 | 06/94 → 05/01 | 1.905 | D | M | 4 | 8 | DHY (XUD9TE) | → PROD: 7390 | 81672 |
| | 66 | 06/94 → 05/01 | 1.905 | D | M | 4 | 8 | DHY (XUD9TE) | PROD →: 7391 | 81642 |
| 1.9 TD | 66 | 02/97 → 04/02 | 1.905 | D | M | 4 | 8 | DHY (XUD9TE) | → PROD: 7390 | 81672 |
| | 66 | 02/97 → 04/02 | 1.905 | D | M | 4 | 8 | DHY (XUD9TE) | PROD →: 7391 | 81642 |
| 2.0 | 89 | 03/94 → 04/02 | 1.998 | B | M | 4 | 8 | RFX (XU10J2) | | 81642 |
| | 97 | 03/97 → 05/01 | 1.998 | B | M | 4 | 16 | RFV (XU10J4R) | | 81711 |
| 2.0 16V | 97 | 03/97 → 05/01 | 1.998 | B | M | 4 | 16 | RFV (XU10J4R) | | 81711 |
| | 99 | 03/97 → 06/00 | 1.998 | B | M | 4 | 16 | RFV (XU10J4R) | | 81711 |
| 2.0 HDI 90 | 66 | 06/99 → 05/01 | 1.997 | D | M | 4 | 8 | RHY (DW10TD) | | 81713 |
| 2.0 S16 | 110 | 06/94 → 05/01 | 1.998 | B | M | 4 | 16 | RFT (XU10J4) | | 81642 |
| | 112 | 06/94 → 05/01 | 1.998 | B | M | 4 | 16 | RFY (XU10J4Z) | | 81642 |
| | 120 | 03/96 → 05/01 | 1.998 | B | M | 4 | 16 | RFS (XU10J4RS) | | 81711 |
| 2.0 ST | 89 | 07/94 → 05/01 | 1.998 | B | M | 4 | 8 | RFX (XU10J2) | | 81642 |
| 2.0 XSi | 89 | 05/93 → 05/01 | 1.998 | B | M | 4 | 8 | RFX (XU10J2) | | 81642 |

307, Station Wagon, CC

| | | | | | | | | | | |
|-------------|----|---------|-------|---|---|---|----|---|----------------|-------|
| 1.4 | 55 | 08/00 → | 1.360 | B | M | 4 | 8 | KFW (TU3JP) | → M: 3.666.765 | 81556 |
| | 55 | 08/00 → | 1.360 | B | M | 4 | 8 | KFW (TU3JP) | M →: 3.666.766 | 81797 |
| 1.4 16V | 65 | 11/03 → | 1.360 | B | M | 4 | 16 | KFU (ET3J4) | | 82016 |
| 1.4 HDi | 50 | 10/01 → | 1.398 | D | M | 4 | 8 | 8HX (DV4TD), 8HZ (DV4TD) | | 81798 |
| | 50 | 03/02 → | 1.398 | D | M | 4 | 8 | 8HZ (DV4TD) | | 81798 |
| 1.6 | 81 | 07/06 → | 1.587 | B | M | 4 | 16 | NFU (TU5JP4) | | 81753 |
| 1.6 16V | 80 | 08/00 → | 1.587 | B | M | 4 | 16 | NFU (TU5JP4) | | 81753 |
| 1.6 BioFlex | 80 | 09/07 → | 1.587 | | M | 4 | 16 | NFU (TU5JP4) | | 81753 |
| 1.6 HDi | 66 | 04/05 → | 1.560 | D | M | 4 | 16 | 9HV (DV6ATED4) | | 81869 |
| | 66 | 04/05 → | 1.560 | D | M | 4 | 16 | 9HV (DV6ATED4), 9HV (DV6TED4), 9HX (DV6ATED4) | | 81869 |

| | | | | | | | | | |
|--|--|--|--|--|--|--|--|--|--|
| | | | | | | | | | |
|--|--|--|--|--|--|--|--|--|--|

PEUGEOT

307, Station Wagon, CC

| | | | | | | | | | | |
|-------------|-----|---------|-------|---|---|---|----|-----------------------------------|-----------|------------------|
| 1.6 HDi 110 | 80 | 02/04 → | 1.560 | D | M | 4 | 16 | 9HY (DV6TED4), 9HZ (DV6TED4) | | 81869 |
| 1.6 HDi 90 | 66 | 12/06 → | 1.560 | D | M | 4 | 16 | 9HV (DV6ATED4), 9HX (DV6ATED4) | | 81869 |
| 2.0 | 100 | 03/02 → | 1.997 | B | M | 4 | 16 | RFN (EW10J4) | (-)COP | 84038 NEW |
| | 100 | 03/02 → | 1.997 | B | M | 4 | 16 | RFN (EW10J4) | (+)COP | 82089 |
| | 100 | 03/02 → | 1.997 | B | M | 4 | 16 | RFN (EW10J4) | | 82089 |
| | 100 | 03/02 → | 1.997 | B | M | 4 | 16 | RFN (EW10J4) | | 81799 |
| | 105 | 08/08 → | 1.997 | B | M | 4 | 16 | RFN (EW10J4) | (-)COP | 84038 NEW |
| | 105 | 08/08 → | 1.997 | B | M | 4 | 16 | RFN (EW10J4) | (+)COP | 82089 |
| | 105 | 08/08 → | 1.997 | B | M | 4 | 16 | RFN (EW10J4) | | 82089 |
| | 105 | 08/08 → | 1.997 | B | M | 4 | 16 | RFN (EW10J4) | | 81799 |
| 2.0 16V | 100 | 08/00 → | 1.997 | B | M | 4 | 16 | RFN (EW10J4) | (-)COP | 84038 NEW |
| | 100 | 08/00 → | 1.997 | B | M | 4 | 16 | RFN (EW10J4) | (+)COP | 82089 |
| | 100 | 08/00 → | 1.997 | B | M | 4 | 16 | RFN (EW10J4) | | 82089 |
| | 100 | 08/00 → | 1.997 | B | M | 4 | 16 | RFN (EW10J4) | | 81799 |
| | 103 | 03/05 → | 1.997 | B | M | 4 | 16 | RFJ (EW10A) | (-)COP | 84038 NEW |
| | 103 | 03/05 → | 1.997 | B | M | 4 | 16 | RFJ (EW10A) | (+)COP | 82089 |
| | 103 | 03/05 → | 1.997 | B | M | 4 | 16 | RFJ (EW10A) | M: EW10J4 | 81799 |
| | 103 | 03/05 → | 1.997 | B | M | 4 | 16 | RFJ (EW10A) | | 82089 |
| | 103 | 03/05 → | 1.997 | B | M | 4 | 16 | RFJ (EW10A) | | 81799 |
| | 103 | 03/05 → | 1.997 | B | M | 4 | 16 | RFJ (EW10A), RFN (EW10J4) | (-)COP | 84038 NEW |
| | 103 | 03/05 → | 1.997 | B | M | 4 | 16 | RFJ (EW10A), RFN (EW10J4) | (+)COP | 82089 |
| | 103 | 03/05 → | 1.997 | B | M | 4 | 16 | RFJ (EW10A), RFN (EW10J4) | | 82089 |
| | 103 | 03/05 → | 1.997 | B | M | 4 | 16 | RFJ (EW10A), RFN (EW10J4) | | 81799 |
| 2.0 16V | 130 | 06/05 → | 1.997 | B | M | 4 | 16 | RFK (EW10J4S) | (-)COP | 84038 NEW |
| | 130 | 06/05 → | 1.997 | B | M | 4 | 16 | RFK (EW10J4S) | (+)COP | 82089 |
| | 130 | 06/05 → | 1.997 | B | M | 4 | 16 | RFK (EW10J4S) | | 82089 |
| 2.0 16V | 130 | 06/05 → | 1.997 | B | M | 4 | 16 | RFK (EW10J4S) | | 81799 |
| 2.0 HDi 110 | 79 | 08/00 → | 1.997 | D | M | 4 | 8 | RHS (DW10ATED) | | 81713 |
| 2.0 HDi 135 | 100 | 10/03 → | 1.997 | D | M | 4 | 16 | RHR (DW10BTED4) | | 81800 |
| 2.0 HDi 90 | 66 | 08/00 → | 1.997 | D | M | 4 | 8 | RHY (DW10TD) | | 81713 |

308 I, Station Wagon, CC

| | | | | | | | | | | |
|---------|-----|---------|-------|---|---|---|----|----------------|--|-------|
| 1.4 16V | 70 | 09/07 → | 1.397 | B | M | 4 | 16 | 8FS (EP3) | | 82032 |
| | 70 | 09/07 → | 1.397 | B | M | 4 | 16 | 8FS (EP3), EP3 | | 82032 |
| | 72 | 12/09 → | 1.397 | B | M | 4 | 16 | 8FR (EP3) | | 82032 |
| 1.6 | 120 | 01/12 → | 1.598 | B | M | 4 | 16 | 5FV (EP6DT) | | 82032 |

KW

cm³

NO. OF VALVES

MAGNETI MARELLI
PEUGEOT
308 I, Station Wagon, CC

| | | | | | | | | | | |
|-------------|-----|---------------|-------|---|---|---|----|-----------------------------------|--------|------------------|
| 1.6 16V | 88 | 09/07 → | 1.598 | B | M | 4 | 16 | 5FW (EP6), EP6 | | 82032 |
| | 88 | 06/09 → | 1.598 | B | M | 4 | 16 | EP6 | | 82032 |
| | 103 | 09/07 → | 1.598 | B | M | 4 | 16 | 5FT (EP6DT) | | 82032 |
| | 110 | 09/07 → | 1.598 | B | M | 4 | 16 | 5FX (EP6DT) | | 82032 |
| | 115 | 10/09 → | 1.598 | B | M | 4 | 16 | EP6CDT | | 82032 |
| | 128 | 03/08 → | 1.598 | B | M | 4 | 16 | 5FY (EP6DTS) | | 82032 |
| 1.6 Bioflex | 80 | 04/08 → | 1.587 | | M | 4 | 16 | NFU (TU5JP4) | | 81753 |
| | 82 | 03/09 → | 1.587 | | M | 4 | 16 | NFU (TU5JP4) | | 82032 |
| 1.6 GTi | 147 | 07/10 → | 1.598 | B | M | 4 | 16 | EP6CDTX | | 82032 |
| 1.6 HDi | 66 | 09/07 → | 1.560 | D | M | 4 | 16 | 9HV (DV6ATED4), 9HX (DV6ATED4) | | 81869 |
| | 66 | 09/07 → | 1.560 | D | M | 4 | 8 | | | 81869 |
| | 68 | 11/09 → | 1.560 | D | M | 4 | 8 | 9HP (DV6DTE) | | 81869 |
| | 80 | 09/07 → | 1.560 | D | M | 4 | 16 | 9HZ (DV6TED4) | | 81869 |
| | 82 | 12/09 → | 1.560 | D | M | 4 | 8 | 9HR (DV6C) | | 81869 |
| | 84 | 03/13 → | 1.560 | D | M | 4 | 16 | | | 81869 |
| 1.6 THP | 147 | 10/10 → | 1.598 | B | M | 4 | 16 | EP6CDTX | | 82032 |
| 2.0 Bioflex | 103 | 01/08 → 01/12 | 1.997 | | M | 4 | 16 | RFJ (EW10A) | (-)COP | 84038 NEW |
| | 103 | 01/08 → 01/12 | 1.997 | | M | 4 | 16 | RFJ (EW10A) | (+)COP | 82089 |
| | 103 | 01/08 → | 1.997 | | M | 4 | 16 | RFJ (EW10A) | | 82089 |
| 2.0 CVVT | 103 | 07/09 → 11/14 | 1.997 | B | M | 4 | 16 | RFJ (EW10A) | (-)COP | 84038 NEW |
| | 103 | 07/09 → 11/14 | 1.997 | B | M | 4 | 16 | RFJ (EW10A) | (+)COP | 82089 |
| 2.0 HDi | 100 | 09/07 → | 1.997 | D | M | 4 | 16 | RHR (DW10BTED4) | | 81800 |
| | 103 | 04/09 → | 1.997 | D | M | 4 | 16 | RHF (DW10BTED4) | | 81800 |
| | 103 | 07/10 → | 1.997 | D | M | 4 | 16 | RHR (DW10BTED4) | | 81800 |
| | 110 | 10/11 → | 1.997 | D | M | 4 | 16 | RHE (DW10CTED4) | | 84020 NEW |
| | 120 | 04/12 → | 1.997 | D | M | 4 | 16 | RHH (DW10CTED4) | | 84020 NEW |

308 II Station Wagon

| | | | | | | | | | | |
|-----------------------|-----|---------|-------|---|---|---|----|----------------------------|--|------------------|
| 1.2 THP 110 | 81 | 11/13 → | 1.199 | B | M | 3 | 12 | HNZ (EB2DT) | | 84066 NEW |
| 1.2 THP 130 | 96 | 11/13 → | 1.199 | B | M | 3 | 12 | HNY (EB2DTS) | | 84066 NEW |
| 1.2 VTi 72 | 60 | 09/13 → | 1.199 | B | M | 3 | 12 | HMZ (EB2F) | | 84066 NEW |
| 1.6 | 115 | 09/13 → | 1.598 | B | M | 4 | 16 | 5FV (EP6DT) | | 82032 |
| 1.6 BlueHDi 100 | 73 | 04/14 → | 1.560 | D | M | 4 | 8 | BHY (DV6FD) | | 81869 |
| 1.6 BlueHDi 120 | 88 | 11/13 → | 1.560 | D | M | 4 | 8 | BHZ (DV6FC) | | 81869 |
| 1.6 GT 205 | 151 | 06/14 → | 1.598 | B | M | 4 | 16 | | | 82032 |
| 1.6 GTi | 184 | 08/15 → | 1.598 | B | M | 4 | 16 | | | 82032 |
| | 200 | 06/15 → | 1.598 | B | M | 4 | 16 | 5GN (EP6FDTR) | | 82032 |
| 1.6 HDi | 68 | 09/13 → | 1.560 | D | M | 4 | 8 | | | 81869 |
| 1.6 HDi / BlueHDi 115 | 85 | 09/13 → | 1.560 | D | M | 4 | 8 | 9HC (DV6C), BHZ (DV6FC) | | 81869 |
| 1.6 HDi 100 | 73 | 04/14 → | 1.560 | D | M | 4 | 8 | BHY (DV6FD) | | 81869 |
| 1.6 HDi 92 | 68 | 03/14 → | 1.560 | D | M | 4 | 8 | | | 81869 |
| 1.6 THP 125 | 92 | 09/13 → | 1.598 | B | M | 4 | 16 | | | 82032 |
| 1.6 THP 155 | 115 | 03/14 → | 1.598 | B | M | 4 | 16 | 5FV (EP6DT) | | 82032 |

KW

cm³

NO. OF VALVES

PEUGEOT
308 II Station Wagon

| | | | | | | | | | | |
|--------------------|-----|---------|-------|---|---|---|----|--|--|-------|
| 1.6 VTi | 85 | 03/14 → | 1.598 | B | M | 4 | 16 | | | 81753 |
| 2.0 BlueHDi 150 | 110 | 11/13 → | 1.997 | D | M | 4 | 16 | | | 82068 |
| | 110 | 03/14 → | 1.997 | D | M | 4 | 8 | | | 82068 |
| 2.0 GT BlueHDi 180 | 133 | 06/14 → | 1.997 | D | M | 4 | 16 | | | 82068 |
| 2.0 GT HDi 180 | 133 | 06/14 → | 1.997 | D | M | 4 | 16 | | | 82068 |

309 II

| | | | | | | | | | | |
|-------------|-----|---------------|-------|---|---|---|----|--|-----------|-------|
| 1.1 | 40 | 09/89 → 10/93 | 1.124 | B | M | 4 | 8 | H1B (TU1) | | 81560 |
| | 44 | 08/90 → 12/93 | 1.124 | B | M | 4 | 8 | HDZ (TU1M) | | 81556 |
| 1.4 | 49 | 07/90 → 12/93 | 1.361 | B | M | 4 | 8 | K1D (TU3A) | | 81556 |
| | 55 | 07/89 → 12/93 | 1.361 | B | M | 4 | 8 | KDY (TU3M), KDZ (TU3M) | | 81556 |
| 1.6 | 65 | 07/89 → 12/93 | 1.580 | B | M | 4 | 8 | BDY (XU5M2Z), BDY (XU5M3Z), BDZ (XU5M) | → 01-1992 | 81554 |
| | 65 | 07/89 → 12/93 | 1.580 | B | M | 4 | 8 | BDY (XU5M2Z), BDY (XU5M3Z), BDZ (XU5M) | 02-1992 → | 81512 |
| | 68 | 07/89 → 12/93 | 1.580 | B | M | 4 | 8 | B2A (XU52C/K) | → 01-1992 | 81554 |
| | 68 | 07/89 → 12/93 | 1.580 | B | M | 4 | 8 | B2A (XU52C/K) | 02-1992 → | 81512 |
| | 69 | 07/89 → 12/93 | 1.580 | B | M | 4 | 8 | B2A (XU52C/K) | → 01-1992 | 81554 |
| | 69 | 07/89 → 12/93 | 1.580 | B | M | 4 | 8 | B2A (XU52C/K) | 02-1992 → | 81512 |
| 1.6 GTi | 85 | 09/89 → 10/93 | 1.580 | B | M | 4 | 8 | | → 01-1992 | 81554 |
| | 85 | 09/89 → 10/93 | 1.580 | B | M | 4 | 8 | | 02-1992 → | 81512 |
| 1.8 Diesel | 44 | 07/89 → 12/93 | 1.769 | D | M | 4 | 8 | 161A (XUD7) | | 81672 |
| 1.8 TD | 57 | 08/89 → 12/93 | 1.769 | D | M | 4 | 8 | A8B (XUD7TE) | | 81672 |
| 1.9 | 72 | 08/89 → 12/93 | 1.905 | B | M | 4 | 8 | DFZ (XU9J1) | → 01-1992 | 81554 |
| | 72 | 08/89 → 12/93 | 1.905 | B | M | 4 | 8 | DFZ (XU9J1) | 02-1992 → | 81512 |
| | 80 | 10/90 → 12/93 | 1.905 | B | M | 4 | 8 | DDZ (XU9M) | → 01-1992 | 81554 |
| | 80 | 10/90 → 12/93 | 1.905 | B | M | 4 | 8 | DDZ (XU9M) | 02-1992 → | 81512 |
| 1.9 Diesel | 47 | 07/89 → 12/93 | 1.905 | D | M | 4 | 8 | 162 (XUD9), D9A (XUD9), DJZ (XUD9Y) | | 81672 |
| 1.9 GTI | 88 | 07/89 → 12/93 | 1.905 | B | M | 4 | 8 | DKZ (XU9JAZ) | → 01-1992 | 81554 |
| | 88 | 07/89 → 12/93 | 1.905 | B | M | 4 | 8 | DKZ (XU9JAZ) | 02-1992 → | 81512 |
| 1.9 GTI 16V | 108 | 10/90 → 12/93 | 1.905 | B | M | 4 | 16 | DFW (XU9J4Z) | | 81512 |
| | 116 | 08/89 → 07/90 | 1.905 | B | M | 4 | 16 | D6C (XU9J4) | | 81512 |

405 I, Station Wagon

| | | | | | | | | | | |
|-----|----|---------------|-------|---|---|---|---|-----------|--|-------|
| 1.4 | 47 | 01/87 → 07/92 | 1.360 | B | M | 4 | 8 | K5A (TU3) | | 81556 |
|-----|----|---------------|-------|---|---|---|---|-----------|--|-------|

KW

cm³

NO. OF VALVES

PEUGEOT
405 I, Station Wagon

| | | | | | | | | | | |
|------------------------------|-----|---------------|-------|---|---|---|----|--|-----------|-------|
| 1.6 | 53 | 07/87 → 12/92 | 1.580 | B | M | 4 | 8 | B1E (XU51C) | | 81554 |
| | 55 | 10/88 → 08/92 | 1.580 | B | M | 4 | 8 | BAZ (XU5CP) | | 81554 |
| | 65 | 10/88 → 08/92 | 1.580 | B | M | 4 | 8 | BDY (XU5M2Z), BDY (XU5M3Z), BDZ (XU5M) | | 81554 |
| | 65 | 07/87 → 12/92 | 1.580 | B | M | 4 | 8 | BDY (XU5M2Z), BDZ (XU5M) | | 81554 |
| | 66 | 10/89 → 12/92 | 1.580 | B | M | 4 | 8 | BDZ (XU5M) | | 81554 |
| | 69 | 01/87 → 12/92 | 1.580 | B | M | 4 | 8 | B2A (XU52C/K) | | 81554 |
| | 69 | 10/88 → 08/92 | 1.580 | B | M | 4 | 8 | | | 81554 |
| 1.6 4x4 | 65 | 04/88 → 07/92 | 1.580 | B | M | 4 | 8 | BDZ (XU5M) | | 81554 |
| 1.6 SRi 4x4 | 65 | 04/88 → 07/92 | 1.580 | B | M | 4 | 8 | BDZ (XU5M) | | 81554 |
| 1.8 GLD | 44 | 04/90 → 07/92 | 1.769 | D | M | 4 | 8 | | | 81672 |
| 1.8 TD | 66 | 10/88 → 08/92 | 1.769 | D | M | 4 | 8 | A8A (XUD7TE), AJZ (XUD7TEY) | | 81672 |
| 1.8 Turbo Diesel | 66 | 03/88 → 12/92 | 1.769 | D | M | 4 | 8 | A8A (XUD7TE), AJZ (XUD7TEY) | | 81672 |
| 1.9 | 70 | 07/87 → 12/92 | 1.905 | B | M | 4 | 8 | D2C (XU92C) | | 81554 |
| | 77 | 10/88 → 08/92 | 1.905 | B | M | 4 | 8 | DFZ (XU9J1) | | 81554 |
| | 80 | 07/88 → 12/92 | 1.905 | B | M | 4 | 8 | DDZ (XU9M) | | 81554 |
| | 88 | 07/88 → 12/92 | 1.905 | B | M | 4 | 8 | DKZ (XU9JAZ) | | 81554 |
| | 93 | 07/87 → 12/93 | 1.905 | B | M | 4 | 8 | D6A (XU9J2) | | 81554 |
| 1.9 4x4 | 80 | 07/88 → 12/92 | 1.905 | B | M | 4 | 8 | DDZ (XU9M) | | 81554 |
| | 88 | 06/87 → 07/92 | 1.905 | B | M | 4 | 8 | DKZ (XU9JAZ) | | 81554 |
| | 93 | 07/90 → 07/92 | 1.905 | B | M | 4 | 8 | | | 81554 |
| | 108 | 07/90 → 07/92 | 1.905 | B | M | 4 | 16 | | | 81512 |
| | 116 | 06/87 → 07/92 | 1.905 | B | M | 4 | 16 | D6C (XU9J4) | | 81512 |
| 1.9 D | 47 | 10/88 → 08/92 | 1.905 | D | M | 4 | 8 | DJZ (XUD9Y) | → 07-1992 | 81672 |
| | 51 | 10/88 → 08/92 | 1.905 | D | M | 4 | 8 | D9B (XUD9A), DJY (XUD9A) | → 07-1992 | 81672 |
| 1.9 Diesel | 47 | 07/88 → 09/92 | 1.905 | D | M | 4 | 8 | DJZ (XUD9Y) | | 81672 |
| | 51 | 03/88 → 12/92 | 1.905 | D | M | 4 | 8 | D9B (XUD9A) | | 81672 |
| 1.9 Injection | 77 | 07/87 → 12/92 | 1.905 | B | M | 4 | 8 | DFZ (XU9J1) | | 81554 |
| 1.9 Sport MI-16 | 108 | 04/88 → 12/92 | 1.905 | B | M | 4 | 16 | DFW (XU9J4Z) | | 81512 |
| | 116 | 07/87 → 11/91 | 1.905 | B | M | 4 | 16 | D6C (XU9J4) | | 81512 |
| 1.9 SPort MI-16 4x4 | 108 | 04/88 → 12/92 | 1.905 | B | M | 4 | 16 | DFW (XU9J4Z) | | 81512 |
| 405 II, Station Wagon | | | | | | | | | | |
| 1.4 | 55 | 08/92 → 10/95 | 1.361 | B | M | 4 | 8 | KDX (TU3MC) | | 81513 |
| 1.6 | 65 | 08/92 → 10/95 | 1.580 | B | M | 4 | 8 | BDY (XU5M2Z), BDY (XU5M3Z), BDZ (XU5M), BFZ (XU5JP) | | 81512 |
| 1.8 | 74 | 08/92 → 10/95 | 1.762 | B | M | 4 | 8 | LFZ (XU7JP) | | 81512 |

KW

cm³

NO. OF VALVES

MAGNETI MARELLI
PEUGEOT
405 II, Station Wagon

| | | | | | | | | | | |
|-------------|-----|---------------|-------|---|---|---|----|------------------|--|-------|
| 1.9 D | 47 | 08/92 → 10/95 | 1.905 | D | M | 4 | 8 | DJZ (XUD9Y) | | 81512 |
| | 50 | 06/94 → 10/95 | 1.905 | D | M | 4 | 8 | DJY (XUD9A) | | 81512 |
| 1.9 TD | 66 | 08/92 → 10/95 | 1.905 | D | M | 4 | 8 | DHY (XUD9TE) | | 81512 |
| 2.0 | 89 | 08/92 → 10/95 | 1.998 | B | M | 4 | 8 | RFX (XU10J2) | | 81642 |
| 2.0 16V | 110 | 06/94 → 10/95 | 1.998 | B | M | 4 | 16 | RFT (XU10J4) | | 81642 |
| 2.0 4x4 | 89 | 08/92 → 10/96 | 1.998 | B | M | 4 | 8 | RFX (XU10J2) | | 81642 |
| 2.0 MI-16 | 112 | 08/92 → 10/95 | 1.998 | B | M | 4 | 16 | RFY (XU10J4Z) | | 81642 |
| 2.0 T 16 X4 | 144 | 08/92 → 10/95 | 1.998 | B | M | 4 | 16 | RGZ (XU10J4TE/Z) | | 81642 |
| 2.0 X4 | 89 | 08/92 → 10/95 | 1.998 | B | M | 4 | 8 | RFX (XU10J2) | | 81642 |

407, Station Wagon, Coupé

| | | | | | | | | | | |
|-------------|-----|---------------|-------|---|----|---|----|----------------|-----------|------------------|
| 1.6 | 65 | 11/95 → 05/04 | 1.580 | B | M | 4 | 8 | BFZ (XU5JP) | | 81512 |
| 1.6 HDi 110 | 80 | 05/04 → | 1.560 | D | M | 4 | 16 | 9HZ (DV6TED4) | | 81869 |
| 1.8 | 85 | 05/04 → | 1.749 | B | M | 4 | 16 | 6FZ (EW7J4) | (-)COP | 84038 NEW |
| | 85 | 05/04 → | 1.749 | B | M | 4 | 16 | 6FZ (EW7J4) | (+)COP | 82089 |
| | 85 | 05/04 → | 1.749 | B | M | 4 | 16 | 6FZ (EW7J4) | | 82089 |
| | 85 | 05/04 → | 1.749 | B | M | 4 | 16 | 6FZ (EW7J4) | | 81799 |
| | 66 | 05/97 → 05/04 | 1.761 | B | AM | 4 | 8 | LFX (XU7JB) | | 81512 |
| | 66 | 05/97 → 10/04 | 1.761 | B | M | 4 | 8 | LFX (XU7JB) | 06-1997 → | 81512 |
| 1.8 16V | 85 | 10/00 → 05/04 | 1.749 | B | M | 4 | 16 | 6FZ (EW7J4) | | 81710 |
| | 92 | 09/05 → | 1.749 | B | M | 4 | 16 | 6FY (EW7A) | (-)COP | 84038 NEW |
| | 92 | 09/05 → | 1.749 | B | M | 4 | 16 | 6FY (EW7A) | (+)COP | 82089 |
| | 92 | 09/05 → | 1.749 | B | M | 4 | 16 | 6FY (EW7A) | | 82089 |
| | 92 | 09/05 → | 1.749 | B | M | 4 | 16 | 6FY (EW7A) | | 81799 |
| | 81 | 11/95 → 10/00 | 1.761 | B | M | 4 | 16 | LFY (XU7JP4) | | 81710 |
| 1.9 D | 55 | 10/96 → 05/04 | 1.905 | D | M | 4 | 8 | DHW (XUD9SD) | | 81642 |
| 1.9 TD | 66 | 01/96 → 05/04 | 1.905 | D | M | 4 | 8 | DHX (XUD9TE) | | 81642 |
| | 68 | 01/96 → 05/04 | 1.905 | D | M | 4 | 8 | DHY (XUD9TE) | | 81642 |
| 2.0 | 100 | 05/04 → | 1.997 | B | M | 4 | 16 | RFN (EW10J4) | (-)COP | 84038 NEW |
| | 100 | 05/04 → | 1.997 | B | M | 4 | 16 | RFN (EW10J4) | (+)COP | 82089 |
| | 100 | 05/04 → | 1.997 | B | M | 4 | 16 | RFN (EW10J4) | | 82089 |
| | 100 | 05/04 → | 1.997 | B | M | 4 | 16 | RFN (EW10J4) | | 81799 |
| | 104 | 11/96 → 03/99 | 1.998 | B | M | 4 | 8 | RGY (XU10J2TE) | | 81711 |

KW

cm³

NO. OF VALVES

MAGNETI MARELLI
PEUGEOT
407, Station Wagon, Coupé

| | | | | | | | | | | | |
|-------------|---------------|---------------|-------|---|---|----|---------------|-----------------------------------|-----------|-------|------------|
| 2.0 16V | 99 | 01/99 → 08/00 | 1.997 | B | M | 4 | 16 | RFR (DEW10J4) | (-)COP | 84038 | NEW |
| | 99 | 01/99 → 08/00 | 1.997 | B | M | 4 | 16 | RFR (DEW10J4) | (+)COP | 82089 | |
| | 99 | 01/99 → 08/00 | 1.997 | B | M | 4 | 16 | RFR (DEW10J4) | | 82089 | |
| | 99 | 01/99 → 08/00 | 1.997 | B | M | 4 | 16 | RFR (DEW10J4) | | 81799 | |
| | 100 | 08/00 → 06/04 | 1.997 | B | M | 4 | 16 | RFN (EW10J4) | (-)COP | 84038 | NEW |
| | 100 | 08/00 → 06/04 | 1.997 | B | M | 4 | 16 | RFN (EW10J4) | (+)COP | 82089 | |
| | 100 | 08/00 → 06/04 | 1.997 | B | M | 4 | 16 | RFN (EW10J4) | | 82089 | |
| | 100 | 08/00 → 06/04 | 1.997 | B | M | 4 | 16 | RFN (EW10J4) | | 81799 | |
| | 100 | 10/00 → 12/04 | 1.997 | B | M | 4 | 16 | RFN (EW10J4), RFV (XU10J4R) | (-)COP | 84038 | NEW |
| | 100 | 10/00 → 12/04 | 1.997 | B | M | 4 | 16 | RFN (EW10J4), RFV (XU10J4R) | (+)COP | 82089 | |
| | 100 | 10/00 → 12/04 | 1.997 | B | M | 4 | 16 | RFN (EW10J4), RFV (XU10J4R) | | 82089 | |
| | 100 | 10/00 → 12/04 | 1.997 | B | M | 4 | 16 | RFN (EW10J4), RFV (XU10J4R) | | 81799 | |
| | 103 | 09/05 → | 1.997 | B | M | 4 | 16 | RFJ (EW10A) | (-)COP | 84038 | NEW |
| | 103 | 09/05 → | 1.997 | B | M | 4 | 16 | RFJ (EW10A) | (+)COP | 82089 | |
| | 103 | 09/05 → | 1.997 | B | M | 4 | 16 | RFJ (EW10A) | | 82089 | |
| | 103 | 09/05 → | 1.997 | B | M | 4 | 16 | RFJ (EW10A) | | 81799 | |
| | 97 | 11/95 → 05/04 | 1.998 | B | M | 4 | 16 | RFV (XU10J4R) | (-)COP | 84038 | NEW |
| | 97 | 11/95 → 05/04 | 1.998 | B | M | 4 | 16 | RFV (XU10J4R) | (+)COP | 82089 | |
| | 97 | 11/95 → 05/04 | 1.998 | B | M | 4 | 16 | RFV (XU10J4R) | → 03-1999 | 81711 | |
| | 97 | 11/95 → 05/04 | 1.998 | B | M | 4 | 16 | RFV (XU10J4R) | 04-1999 → | 81799 | |
| 97 | 11/95 → 05/04 | 1.998 | B | M | 4 | 16 | RFV (XU10J4R) | | 82089 | | |
| 97 | 03/97 → 12/04 | 1.998 | B | M | 4 | 16 | RFV (XU10J4R) | → 12-1999 | 81711 | | |
| 99 | 04/99 → 09/04 | 1.998 | B | M | 4 | 16 | RFV (XU10J4R) | | 81711 | | |
| 2.0 16V HPi | 103 | 05/01 → 05/04 | 1.997 | B | M | 4 | 16 | RLZ (EW10D) | (-)COP | 84038 | NEW |
| | 103 | 05/01 → 05/04 | 1.997 | B | M | 4 | 16 | RLZ (EW10D) | (+)COP | 82089 | |
| | 103 | 05/01 → 05/04 | 1.997 | B | M | 4 | 16 | RLZ (EW10D) | | 82089 | |
| | 103 | 05/01 → 05/04 | 1.997 | B | M | 4 | 16 | RLZ (EW10D) | | 81799 | |
| 2.0 Bioflex | 103 | 09/07 → | 1.997 | | M | 4 | 16 | RFJ (EW10A) | (-)COP | 84038 | NEW |
| | 103 | 09/07 → | 1.997 | | M | 4 | 16 | RFJ (EW10A) | (+)COP | 82089 | |
| | 103 | 09/07 → | 1.997 | | M | 4 | 16 | RFJ (EW10A) | | 82089 | |
| | 103 | 09/07 → | 1.997 | | M | 4 | 16 | RFJ (EW10A) | | 81799 | |
| 2.0 HDi | 100 | 10/05 → | 1.997 | D | M | 4 | 16 | RHR (DW10BTED4) | | 81800 | |
| | 103 | 08/08 → | 1.997 | D | M | 4 | 16 | RHF (DW10BTED4) | | 81800 | |
| | 103 | 08/08 → | 1.997 | D | M | 4 | 16 | RHR (DW10BTED4) | | 81800 | |
| | 110 | 02/10 → | 1.997 | D | M | 4 | 16 | RHE (DW10CTED4) | | 81800 | |
| | 120 | 07/09 → | 1.997 | D | M | 4 | 16 | RHH (DW10CTED4) | | 81800 | |
| 2.0 HDi 110 | 79 | 08/01 → 05/04 | 1.997 | D | M | 4 | 8 | RHS (DW10ATED), RHZ (DW10ATED) | | 81713 | |
| | 80 | 06/98 → 08/01 | 1.997 | D | M | 4 | 8 | RHZ (DW10ATED) | | 81713 | |
| 2.0 HDi 135 | 100 | 05/04 → | 1.997 | D | M | 4 | 16 | RHR (DW10BTED4) | | 81800 | |

KW

cm³

NO. OF VALVES

MAGNETI MARELLI
PEUGEOT
407, Station Wagon, Coupé

| | | | | | | | | | | |
|-------------|-----|---------------|-------|---|---|---|----|--------------------|---|------------------|
| 2.0 HDi 90 | 66 | 02/99 → 05/04 | 1.997 | D | M | 4 | 8 | RHY (DW10TD) | | 81713 |
| 2.0 Turbo | 108 | 04/96 → 05/04 | 1.998 | B | M | 4 | 8 | RGX (XU10J2TE) | | 81642 |
| 2.1 TD 12V | 80 | 01/96 → 05/04 | 2.088 | D | M | 4 | 12 | P8C (XUD11BTE) | | 81353 |
| 2.2 | 116 | 07/00 → 05/04 | 2.230 | B | M | 4 | 16 | 3FZ (EW12J4) | (-)COP | 84038 NEW |
| | 116 | 07/00 → 05/04 | 2.230 | B | M | 4 | 16 | 3FZ (EW12J4) | (+)COP | 82089 |
| | 116 | 07/00 → 05/04 | 2.230 | B | M | 4 | 16 | 3FZ (EW12J4) | | 82089 |
| | 116 | 07/00 → 05/04 | 2.230 | B | M | 4 | 16 | 3FZ (EW12J4) | | 81799 |
| 2.2 16V | 120 | 09/05 → | 2.230 | B | M | 4 | 16 | 3FY (EW12J4) | (-)COP | 84038 NEW |
| | 120 | 09/05 → | 2.230 | B | M | 4 | 16 | 3FY (EW12J4) | (+)COP | 82089 |
| | 120 | 09/05 → | 2.230 | B | M | 4 | 16 | 3FY (EW12J4) | | 82089 |
| | 120 | 09/05 → | 2.230 | B | M | 4 | 16 | 3FY (EW12J4) | | 81799 |
| 2.2 HDi | 98 | 03/00 → 05/04 | 2.179 | D | M | 4 | 16 | 4HX (DW12TED4/FAP) | | 81800 |
| | 120 | 06/08 → | 2.179 | D | M | 4 | 16 | 4HP (DW12BTED4) | | 82068 |
| 2.2 HDi 170 | 125 | 05/06 → | 2.179 | D | M | 4 | 16 | 4HT (DW12BTED4) | | 82068 |
| 2.7 HDi | 150 | 10/05 → | 2.720 | D | M | 6 | 24 | UHZ (DT17) | | 82067 |
| 3.0 | 155 | 05/04 → | 2.946 | B | M | 6 | 24 | XFV (ES9A) | | 81813 |
| 3.0 24V | 140 | 10/96 → 05/04 | 2.946 | B | M | 6 | 24 | XFZ (ES9J4) | → 12-1999, → T: 08441, → PROD: 8554 | 81844 |
| | 140 | 10/96 → 05/04 | 2.946 | B | M | 6 | 24 | XFZ (ES9J4) | T →: 08442 | 82042 |
| 3.0 HDi | 177 | 06/09 → | 2.992 | D | M | 6 | 24 | DT20C | | 84019 NEW |
| 3.0 V6 | 152 | 03/00 → 05/04 | 2.946 | B | M | 6 | 24 | XFV (ES9J4S) | PROD →: 8555 | 81813 |
| | 155 | 10/05 → | 2.946 | B | M | 6 | 24 | XFV (ES9A) | | 81813 |
| 3.0 V6 24V | 140 | 03/97 → 12/04 | 2.946 | B | M | 6 | 24 | XFZ (ES9J4) | → T: 08441 | 81844 |
| | 140 | 03/97 → 12/04 | 2.946 | B | M | 6 | 24 | XFZ (ES9J4) | T →: 08442 | 82042 |

508, Station Wagon

| | | | | | | | | | | |
|-----------------|-----|---------|-------|---|---|---|----|-----------------|--|------------------|
| 1.6 | 120 | 01/12 → | 1.598 | B | M | 4 | 16 | 5GZ (EP6FDT) | | 82032 |
| | 121 | 09/11 → | 1.598 | B | M | 4 | 16 | | | 82032 |
| 1.6 BlueHDi 120 | 88 | 03/14 → | 1.560 | D | M | 4 | 8 | BHZ (DV6FC) | | 81869 |
| 1.6 HDi | 82 | 11/10 → | 1.560 | D | M | 4 | 8 | 9HR (DV6C) | | 81869 |
| | 84 | 02/12 → | 1.560 | D | M | 4 | 8 | 9HD (DV6CTED) | | 81869 |
| | 85 | 09/14 → | 1.560 | D | M | 4 | 8 | BHX (DV6FC) | | 81869 |
| 1.6 THP | 110 | 11/10 → | 1.598 | B | M | 4 | 16 | 5FN (EP6CDT) | | 82032 |
| | 110 | 11/10 → | 1.598 | B | M | 4 | 16 | 5FX (EP6DT) | | 82032 |
| | 115 | 11/10 → | 1.598 | B | M | 4 | 16 | EP6CDT | | 82032 |
| 1.6 VTi | 85 | 11/10 → | 1.598 | B | M | 4 | 16 | 5FH (EP6C) | | 82032 |
| | 88 | 11/10 → | 1.598 | B | M | 4 | 16 | 5FS (EP6C) | | 82032 |
| 2.0 BlueHDi 150 | 110 | 04/14 → | 1.997 | D | M | 4 | 16 | AHX (DW10FD) | | 82068 |
| 2.0 BlueHDi 180 | 133 | 04/14 → | 1.997 | D | M | 4 | 16 | AHW (DW10FC) | | 82068 |
| 2.0 HDi | 100 | 11/10 → | 1.997 | D | M | 4 | 16 | RHR (DW10BTED4) | | 81800 |
| | 103 | 11/10 → | 1.997 | D | M | 4 | 16 | RHF (DW10BTED4) | | 84020 NEW |
| | 120 | 11/10 → | 1.997 | D | M | 4 | 16 | RHH (DW10CTED4) | | 84020 NEW |
| 2.0 HDi 180 RXH | 133 | 10/14 → | 1.997 | | M | 4 | 16 | | | 82068 |

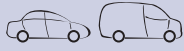
KW

cm³

NO. OF VALVES

MAGNETI MARELLI
PEUGEOT
508, Station Wagon

| | | | | | | | | | | | |
|---------------------|-----|---------|-------|---|---|---|----|-----------------|--|-------|------------|
| 2.0 HDi Hybrid4 AWC | 120 | 11/10 → | 1.997 | | M | 4 | 16 | RHC (DW10CTED4) | | 84020 | NEW |
| | 147 | 11/10 → | 1.997 | | M | 4 | 16 | | | 84020 | NEW |
| 2.0 HDi RXH Hybrid4 | 120 | 11/10 → | 1.997 | | M | 4 | 16 | RHC (DW10CTED4) | | 84020 | NEW |
| | 147 | 12/11 → | 1.997 | | M | 4 | 16 | RHC (DW10CTED4) | | 84020 | NEW |
| 2.2 HDi | 150 | 11/10 → | 2.179 | D | M | 4 | 16 | 4HL (DW12C) | | 82068 | |

605

| | | | | | | | | | | | |
|------------------|-----|---------------|-------|---|---|---|----|----------------|----------------------------|-------|--|
| 2.0 | 79 | 02/90 → 09/99 | 1.998 | B | M | 4 | 8 | | | 81642 | |
| | 84 | 06/89 → 09/99 | 1.998 | B | M | 4 | 8 | R5A (XU102C) | | 81642 | |
| | 89 | 06/89 → 09/99 | 1.998 | B | M | 4 | 8 | RFZ (XU10J2Z) | | 81642 | |
| 2.0 16V | 97 | 07/94 → 09/99 | 1.998 | B | M | 4 | 16 | RFV (XU10J4R) | | 81711 | |
| 2.0 Turbo | 104 | 07/92 → 09/99 | 1.998 | B | M | 4 | 8 | RGY (XU10J2TE) | | 81642 | |
| | 108 | 07/91 → 09/99 | 1.998 | B | M | 4 | 8 | RGX (XU10J2TE) | | 81642 | |
| 2.1 D | 60 | 06/89 → 07/95 | 2.138 | D | M | 4 | 12 | P9A (XUD11A) | | 81642 | |
| 2.1 TD 12V | 80 | 08/94 → 09/99 | 2.088 | D | M | 4 | 12 | P8C (XUD11BTE) | | 81353 | |
| 2.1 Turbo Diesel | 80 | 06/89 → 09/99 | 2.088 | D | M | 4 | 12 | PHZ (XUD11ATE) | | 81353 | |
| 2.5 Turbo Diesel | 95 | 07/94 → 09/99 | 2.446 | D | M | 4 | 12 | THY (DK5ATE) | → 03-1995, → PROD: 7143 | 81752 | |
| | 95 | 07/94 → 09/99 | 2.446 | D | M | 4 | 12 | THY (DK5ATE) | 04-1995 →, PROD →: 7144 | 81712 | |

607

| | | | | | | | | | | | |
|-------------|-----|---------------|-------|---|---|---|----|-----------------------------|--------|-------|------------|
| 2.0 | 100 | 02/00 → | 1.997 | B | M | 4 | 16 | RFN (EW10J4) | (-)COP | 84038 | NEW |
| | 100 | 02/00 → | 1.997 | B | M | 4 | 16 | RFN (EW10J4) | (+)COP | 82089 | |
| | 100 | 02/00 → | 1.997 | B | M | 4 | 16 | RFN (EW10J4) | | 82089 | |
| | 100 | 02/00 → | 1.997 | B | M | 4 | 16 | RFN (EW10J4) | | 81799 | |
| 2.0 HDi | 79 | 03/01 → 07/04 | 1.997 | D | M | 4 | 8 | RHS (DW10ATED) | | 81713 | |
| | 80 | 05/00 → | 1.997 | D | M | 4 | 8 | RHZ (DW10ATED) | | 81713 | |
| | 100 | 09/05 → | 1.997 | D | M | 4 | 16 | RHR (DW10BTED4) | | 81800 | |
| 2.2 16V | 116 | 02/00 → | 2.230 | B | M | 4 | 16 | 3FZ (EW12J4) | (-)COP | 84038 | NEW |
| | 116 | 02/00 → | 2.230 | B | M | 4 | 16 | 3FZ (EW12J4) | (+)COP | 82089 | |
| | 116 | 02/00 → | 2.230 | B | M | 4 | 16 | 3FZ (EW12J4) | | 82089 | |
| | 116 | 02/00 → | 2.230 | B | M | 4 | 16 | 3FZ (EW12J4) | | 81799 | |
| | 120 | 09/05 → | 2.230 | B | M | 4 | 16 | 3FY (EW12J4) | (-)COP | 84038 | NEW |
| | 120 | 09/05 → | 2.230 | B | M | 4 | 16 | 3FY (EW12J4) | (+)COP | 82089 | |
| | 120 | 09/05 → | 2.230 | B | M | 4 | 16 | 3FY (EW12J4) | | 82089 | |
| | 120 | 09/05 → | 2.230 | B | M | 4 | 16 | 3FY (EW12J4) | | 81799 | |
| 2.2 HDi | 98 | 02/00 → | 2.179 | D | M | 4 | 16 | 4HX (DW12TED4/FAP) | | 81800 | |
| | 125 | 05/06 → | 2.179 | D | M | 4 | 16 | 4HT (DW12BTED4) | | 82068 | |
| 2.7 HDi 24V | 150 | 12/04 → | 2.721 | D | M | 6 | 24 | DT17TED4 | | 82067 | |
| 3.0 V6 24V | 152 | 02/00 → | 2.946 | B | M | 6 | 24 | XFX (ES9J4S) | | 81813 | |
| | 155 | 03/04 → | 2.946 | B | M | 6 | 24 | XFV (ES9A), XFX (ES9J4S) | | 81813 | |

| | | | | | | | | | |
|--|----|--|--|--|--|---------------|--|--|--|
| | | | | | | | | | |
| | KW | | | | | NO. OF VALVES | | | |

PEUGEOT

806

| | | | | | | | | | | |
|-------------|-----|---------------|-------|---|---|---|----|-----------------|--------|------------------|
| 1.8 | 73 | 07/95 → 08/02 | 1.761 | B | M | 4 | 8 | LFW (XU7JP) | | 81512 |
| 1.9 TD | 66 | 07/95 → 08/02 | 1.905 | D | M | 4 | 8 | DHX (XUD9TE) | | 81642 |
| | 68 | 05/97 → 08/02 | 1.905 | D | M | 4 | 8 | DHY (XUD9TE) | | 81642 |
| 2.0 | 89 | 06/94 → 08/02 | 1.998 | B | M | 4 | 8 | RFU (XU10J2) | | 81642 |
| 2.0 16V | 100 | 09/00 → 08/02 | 1.997 | B | M | 4 | 16 | RFN (EW10J4) | (-)COP | 84038 NEW |
| | 100 | 09/00 → 08/02 | 1.997 | B | M | 4 | 16 | RFN (EW10J4) | (+)COP | 82089 |
| | 100 | 09/00 → 08/02 | 1.997 | B | M | 4 | 16 | RFN (EW10J4) | | 82089 |
| | 100 | 09/00 → 08/02 | 1.997 | B | M | 4 | 16 | RFN (EW10J4) | | 81799 |
| | 97 | 05/98 → 09/00 | 1.998 | B | M | 4 | 16 | RFV (XU10J4R) | | 81711 |
| 2.0 HDI | 80 | 08/99 → 08/02 | 1.997 | D | M | 4 | 8 | RHZ (DW10ATED) | | 81713 |
| 2.0 HDI 16V | 80 | 08/99 → 08/02 | 1.997 | D | M | 4 | 16 | RHW (DW10ATED4) | | 81713 |
| 2.0 Turbo | 108 | 06/94 → 08/02 | 1.998 | B | M | 4 | 8 | RGX (XU10J2TE) | | 81642 |
| 2.1 td 12V | 80 | 06/96 → 08/99 | 2.088 | D | M | 4 | 12 | P8C (XUD11BTE) | | 81353 |

807

| | | | | | | | | | | |
|---------|-----|---------------|-------|---|---|---|----|---|--------|------------------|
| 2.0 | 100 | 06/02 → | 1.997 | B | M | 4 | 16 | RFN (EW10J4) | (-)COP | 84038 NEW |
| | 100 | 06/02 → | 1.997 | B | M | 4 | 16 | RFN (EW10J4) | (+)COP | 82089 |
| | 100 | 06/02 → | 1.997 | B | M | 4 | 16 | RFN (EW10J4) | | 82089 |
| | 100 | 06/02 → | 1.997 | B | M | 4 | 16 | RFN (EW10J4) | | 81799 |
| 2.0 16V | 103 | 09/05 → | 1.997 | B | M | 4 | 16 | RFJ (EW10A) | (-)COP | 84038 NEW |
| | 103 | 09/05 → | 1.997 | B | M | 4 | 16 | RFJ (EW10A) | (+)COP | 82089 |
| | 103 | 09/05 → | 1.997 | B | M | 4 | 16 | RFJ (EW10A) | | 82089 |
| | 103 | 09/05 → | 1.997 | B | M | 4 | 16 | RFJ (EW10A) | | 81799 |
| 2.0 HDi | 79 | 06/02 → | 1.997 | D | M | 4 | 16 | RHM (DW10ATED4), RHT (DW10ATED4), RHW (DW10ATED4) | | 81713 |
| | 80 | 04/04 → 05/06 | 1.997 | D | M | 4 | 16 | RHW (DW10ATED4) | | 81800 |
| | 88 | 02/06 → | 1.997 | D | M | 4 | 16 | RHK (DW10UTED4) | | 81800 |
| | 100 | 06/06 → | 1.997 | D | M | 4 | 16 | RHR (DW10BTED4) | | 81800 |
| | 120 | 06/09 → | 1.997 | D | M | 4 | 16 | RHH (DW10CTED4) | | 84020 NEW |
| 2.2 | 116 | 06/02 → | 2.230 | B | M | 4 | 16 | 3FZ (EW12J4) | (-)COP | 84038 NEW |
| | 116 | 06/02 → | 2.230 | B | M | 4 | 16 | 3FZ (EW12J4) | (+)COP | 82089 |
| | 116 | 06/02 → | 2.230 | B | M | 4 | 16 | 3FZ (EW12J4) | | 82089 |
| | 116 | 06/02 → | 2.230 | B | M | 4 | 16 | 3FZ (EW12J4) | | 81799 |
| 2.2 HDi | 94 | 06/02 → | 2.179 | D | M | 4 | 16 | 4HW (DW12BTED4), 4HX (DW12TED4/FAP) | | 81800 |
| | 120 | 06/06 → | 2.179 | D | M | 4 | 16 | 4HT (DW12BTED4) | | 82068 |
| | 125 | 06/06 → | 2.179 | D | M | 4 | 16 | 4HT (DW12BTED4) | | 82068 |
| 3.0 V6 | 150 | 06/02 → | 2.946 | B | M | 6 | 24 | XFX (ES9J4S) | | 81813 |

1007

| | | | | | | | | | | |
|---------|----|---------|-------|---|---|---|----|-----------------------------|--|-------|
| 1.4 | 54 | 04/05 → | 1.360 | B | M | 4 | 8 | KFV (TU3JP) | | 81797 |
| 1.4 16V | 65 | 10/05 → | 1.360 | B | M | 4 | 16 | KFU (ET3J4) | | 81797 |
| 1.4 HDi | 50 | 04/05 → | 1.398 | D | M | 4 | 8 | 8HX (DV4TD), 8HZ (DV4TD) | | 81798 |
| 1.6 16V | 80 | 04/05 → | 1.587 | B | M | 4 | 16 | NFU (TU5JP4) | | 81753 |



KW



cm³



NO. OF VALVES



MAGNETI MARELLI

PEUGEOT

1007

| | | | | | | | | | | |
|---------|----|---------|-------|---|---|---|----|---------------|--|-------|
| 1.6 HDi | 80 | 06/07 → | 1.560 | D | M | 4 | 16 | 9HZ (DV6TED4) | | 81869 |
|---------|----|---------|-------|---|---|---|----|---------------|--|-------|

2008

| | | | | | | | | | | | |
|-----------------|----|---------|-------|---|---|---|----|---------------|--|-------|------------|
| 1.2 THP 110 | 81 | 01/15 → | 1.199 | B | M | 3 | 12 | HNZ (EB2DT) | | 84066 | NEW |
| 1.2 THP 130 | 96 | 01/15 → | 1.199 | B | M | 3 | 12 | HNY (EB2DTS) | | 84066 | NEW |
| 1.2 VTi | 60 | 03/13 → | 1.199 | B | M | 3 | 12 | HMZ (EB2F) | | 84066 | NEW |
| 1.4 HDi | 50 | 06/13 → | 1.398 | D | M | 4 | 8 | 8HR (DV4C) | | 81798 | |
| 1.6 BlueHDi 100 | 73 | 01/15 → | 1.560 | D | M | 4 | 8 | BHY (DV6FD) | | 81869 | |
| 1.6 BlueHDi 120 | 88 | 07/14 → | 1.560 | D | M | 4 | 8 | BHZ (DV6FC) | | 81869 | |
| 1.6 BlueHDi 75 | 55 | 01/15 → | 1.560 | D | M | 4 | 8 | BHW (DV6FE) | | 81869 | |
| 1.6 HDi | 68 | 03/13 → | 1.560 | D | M | 4 | 8 | 9HP (DV6DTED) | | 81869 | |
| | 84 | 03/13 → | 1.560 | D | M | 4 | 8 | 9HD (DV6CTED) | | 81869 | |
| | 85 | 07/14 → | 1.560 | D | M | 4 | 8 | BHX (DV6FC) | | 81869 | |
| 1.6 VTi | 88 | 03/13 → | 1.598 | B | M | 4 | 16 | 5FS (EP6C) | | 82032 | |

3008

| | | | | | | | | | | | |
|---------------------------|-----|---------|-------|---|---|---|----|----------------------------------|--|-------|------------|
| 1.2 | 96 | 01/15 → | 1.199 | B | M | 3 | 12 | HNY (EB2DTS) | | 84066 | NEW |
| 1.6 BlueHDi 120 | 88 | 05/14 → | 1.560 | D | M | 4 | 8 | BHZ (DV6FC) | | 81869 | |
| 1.6 HDi | 80 | 06/09 → | 1.560 | D | M | 4 | 16 | 9HZ (DV6TED4) | | 81869 | |
| | 82 | 08/10 → | 1.560 | D | M | 4 | 8 | 9HR (DV6C) | | 81869 | |
| | 84 | 03/13 → | 1.560 | D | M | 4 | 8 | 9HD (DV6CTED) | | 81869 | |
| 1.6 THP | 110 | 06/09 → | 1.598 | B | M | 4 | 16 | 5FX (EP6DT) | | 82032 | |
| | 115 | 06/09 → | 1.598 | B | M | 4 | 16 | 5FV (EP6DT) | | 82032 | |
| 1.6 Turbo | 121 | 05/14 → | 1.598 | B | M | 4 | 16 | 5GZ (EP6FDT) | | 82032 | |
| 1.6 VTi | 88 | 06/09 → | 1.598 | B | M | 4 | 16 | 5FS (EP6C), 5FW (EP6), EP6 | | 82032 | |
| 2.0 HDi | 100 | 09/11 → | 1.997 | D | M | 4 | 16 | | | 84020 | NEW |
| | 120 | 06/09 → | 1.997 | D | M | 4 | 16 | RHH (DW10CTED4) | | 84020 | NEW |
| 2.0 HDi 150 / BlueHDi 150 | 110 | 06/09 → | 1.997 | D | M | 4 | 16 | AHX (DW10FD), RHE (DW10CTED4) | | 84020 | NEW |
| 2.0 HDi Hybrid4 | 120 | 02/11 → | 1.997 | | M | 4 | 16 | RHC (DW10CTED4) | | 84020 | NEW |

4007

| | | | | | | | | | | |
|---------|-----|---------|-------|---|---|---|----|-------------------------------------|--|-------|
| 2.2 HDi | 115 | 02/07 → | 2.179 | D | M | 4 | 16 | 4HK (DW12MTED4), 4HN (DW12MTED4) | | 82068 |
|---------|-----|---------|-------|---|---|---|----|-------------------------------------|--|-------|

4008

| | | | | | | | | | | | |
|-------------|-----|---------|-------|---|---|---|----|------------|--|-------|------------|
| 1.6 HDi AWC | 84 | 05/12 → | 1.560 | D | M | 4 | 8 | 9HD (DV6C) | | 81869 | |
| 1.8 HDi AWC | 110 | 05/12 → | 1.798 | D | M | 4 | 16 | | | 84042 | NEW |

5008

| | | | | | | | | | | | |
|-----------------|-----|---------|-------|---|---|---|----|-------------------------------|--|-------|------------|
| 1.2 | 96 | 01/15 → | 1.199 | B | M | 3 | 12 | HNY (EB2DTS) | | 84066 | NEW |
| 1.6 | 120 | 02/12 → | 1.598 | B | M | 4 | 16 | 5GZ (EP6FDT) | | 82032 | |
| 1.6 16V | 88 | 09/09 → | 1.598 | B | M | 4 | 16 | 5FS (EP6C), 5FW (EP6), EP6 | | 82032 | |
| | 115 | 09/09 → | 1.598 | B | M | 4 | 16 | EP6CDT | | 82032 | |
| 1.6 BlueHDi 120 | 88 | 05/14 → | 1.560 | D | M | 4 | 8 | BHZ (DV6FC) | | 81869 | |

| | | | | | | | | | | |
|--|--|--|--|--|--|--|--|--|--|--|
| | | | | | | | | | | |
|--|--|--|--|--|--|--|--|--|--|--|

PEUGEOT

5008

| | | | | | | | | | | |
|---------------------------|-----|---------|-------|---|---|---|----|----------------------------------|--|-------|
| 1.6 HDi | 80 | 09/09 → | 1.560 | D | M | 4 | 16 | 9HZ (DV6TED4) | | 81869 |
| | 82 | 08/10 → | 1.560 | D | M | 4 | 8 | 9HR (DV6C) | | 81869 |
| | 84 | 03/13 → | 1.560 | D | M | 4 | 8 | 9HD (DV6CTED) | | 81869 |
| 1.6 THP 150 | 110 | 02/12 → | 1.598 | B | M | 4 | 16 | | | 82032 |
| 1.6 THP 165 | 121 | 02/12 → | 1.598 | B | M | 4 | 16 | 5GZ (EP6FDT) | | 82032 |
| 2.0 HDi | 120 | 09/09 → | 1.997 | D | M | 4 | 16 | RHH (DW10CTED4) | | 84020 |
| 2.0 HDi 136 / BlueHDi 136 | 100 | 02/12 → | 1.997 | D | M | 4 | 16 | AHV (DW10FD), RHD (DW10CTED4) | | 84020 |
| 2.0 HDi 150 / BlueHDi 150 | 110 | 06/09 → | 1.997 | D | M | 4 | 16 | AHX (DW10FD), RHE (DW10CTED4) | | 84020 |

Bipper, Tepee

| | | | | | | | | | | |
|------------|----|---------|-------|---|---|---|----|--------------|--|-------|
| 1.3 HDi 75 | 55 | 10/10 → | 1.248 | D | M | 4 | 16 | 199A9.000 | | 81862 |
| 1.4 | 54 | 02/08 → | 1.360 | B | M | 4 | 8 | KFV (TU3A) | | 81797 |
| 1.4 HDi | 50 | 02/08 → | 1.398 | D | M | 4 | 8 | 8HS (DV4TED) | | 81798 |

Boxer I

| | | | | | | | | | | |
|------------|----|---------------|-------|---|---|---|----|--------------------------|----------------------------|-------|
| 1.9 D | 50 | 07/99 → 04/02 | 1.905 | D | M | 4 | 8 | DJY (XUD9A) | | 81642 |
| | 51 | 03/94 → 04/02 | 1.905 | D | M | 4 | 8 | D9B (XUD9AU) | | 81642 |
| 1.9 DT 4x4 | 66 | 03/96 → 09/98 | 1.905 | D | M | 4 | 8 | XUD9TE | | 81642 |
| 1.9 TD | 66 | 08/94 → 04/02 | 1.905 | D | M | 4 | 8 | DHY (XUD9TE) | | 81642 |
| | 66 | 06/94 → 04/02 | 1.905 | D | M | 4 | 8 | DHY (XUD9TE), XUD9TE | | 81642 |
| | 66 | 07/99 → 04/02 | 1.905 | D | M | 4 | 8 | XUD9TE | | 81642 |
| | 68 | 03/94 → 04/02 | 1.905 | D | M | 4 | 8 | D8C (XUD9UTF) | | 81642 |
| | 68 | 07/94 → 04/02 | 1.905 | D | M | 4 | 8 | D8C (XUD9UTF), XUD9TE | | 81642 |
| 1.9 TD 4x4 | 68 | 07/96 → 04/02 | 1.905 | D | M | 4 | 8 | D8C (XUD9UTF) | | 81642 |
| 2.0 | 81 | 12/01 → 04/02 | 1.998 | B | M | 4 | 8 | RFL (XU10J2U) | | 81642 |
| 2.0 4x4 | 80 | 03/96 → 09/98 | 1.998 | B | M | 4 | 8 | | | 81642 |
| 2.0 HDi | 62 | 08/01 → 04/02 | 1.997 | D | M | 4 | 8 | RHV (DW10UTD) | | 81713 |
| 2.0 i | 80 | 03/94 → 04/02 | 1.998 | B | M | 4 | 8 | RFW (XU10J2) | | 81642 |
| 2.0 i 4x4 | 80 | 08/96 → 04/02 | 1.998 | B | M | 4 | 8 | RFW (XU10J2) | | 81642 |
| 2.5 D | 63 | 08/94 → 04/02 | 2.446 | D | M | 4 | 8 | T9A (DJ5) | → 05-1996, → PROD: 7143 | 81752 |
| | 63 | 08/94 → 04/02 | 2.446 | D | M | 4 | 8 | T9A (DJ5) | 01-1999 →, M: SOFIM | 81316 |
| | 63 | 08/94 → 04/02 | 2.446 | D | M | 4 | 8 | T9A (DJ5) | 06-1996 →, PROD →: 7144 | 81712 |
| 2.5 D 4x4 | 63 | 07/96 → 04/02 | 2.446 | D | M | 4 | 8 | T9A (DJ5) | M: SOFIM | 81316 |
| | 63 | 07/96 → 04/02 | 2.446 | D | M | 4 | 8 | T9A (DJ5) | | 81712 |
| 2.5 DT | 62 | 10/97 → 11/01 | 2.499 | D | M | 4 | 8 | | | 81712 |
| 2.5 TD | 76 | 07/94 → 04/02 | 2.446 | D | M | 4 | 12 | T8A (DJ5T) | → 05-1996, → PROD: 7143 | 81752 |
| | 76 | 07/94 → 04/02 | 2.446 | D | M | 4 | 12 | T8A (DJ5T) | 06-1996 →, PROD →: 7144 | 81712 |

KW

cm³

NO. OF VALVES

PEUGEOT
Boxer I

| | | | | | | | | | | |
|----------------------------|----|---------------|-------|---|---|---|----|--------------------|----------|-------|
| 2.5 TD 4x4 | 76 | 07/96 → 04/02 | 2.446 | D | M | 4 | 12 | T8A (DJ5T) | M: SOFIM | 81316 |
| | 76 | 07/96 → 04/02 | 2.446 | D | M | 4 | 12 | T8A (DJ5T) | | 81712 |
| 2.5 TDI | 79 | 01/97 → 04/02 | 2.446 | D | M | 4 | 8 | THX (DJ5TED) | | 81712 |
| 2.5 TDI 4x4 | 79 | 01/97 → 04/02 | 2.446 | D | M | 4 | 8 | THX (DJ5TED) | | 81712 |
| 2.8 D | 64 | 01/99 → 02/02 | 2.798 | D | M | 4 | 8 | 8140.63 (F28D) | | 81316 |
| 2.8 HDi | 93 | 10/00 → 11/01 | 2.798 | D | M | 4 | 8 | 8140.43S (F28DTCR) | | 81316 |
| | 94 | 11/00 → 04/02 | 2.798 | D | M | 4 | 8 | 8140.43S (F28DTCR) | | 81316 |
| 2.8 HDi 4x4 | 93 | 10/00 → 11/01 | 2.798 | D | M | 4 | 8 | 8140.43S (F28DTCR) | | 81316 |
| | 94 | 10/00 → 04/02 | 2.798 | D | M | 4 | 8 | 8140.43S (F28DTCR) | | 81316 |
| 2.8 HDi Trazione integrale | 93 | 10/00 → 11/01 | 2.798 | D | M | 4 | 8 | 8140.43S (F28DTCR) | | 81316 |

Boxer II

| | | | | | | | | | | |
|-------------|-----|---------|-------|---|---|---|---|--------------------------------|--|-------|
| 2.0 | 81 | 04/02 → | 1.998 | B | M | 4 | 8 | RFL (XU10J2U) | | 81642 |
| 2.0 HDi | 62 | 04/02 → | 1.997 | D | M | 4 | 8 | RHV (DW10TD), RHV (DW10UTD) | | 81713 |
| 2.2 HDi | 74 | 04/02 → | 2.179 | D | M | 4 | 8 | 4HY (DW12UTED) | | 81800 |
| 2.8 HDi | 94 | 04/02 → | 2.798 | D | M | 4 | 8 | 8140.43S (F28DTCR) | | 81316 |
| | 107 | 04/04 → | 2.798 | D | M | 4 | 8 | 8140.43N | | 81316 |
| 2.8 HDi 4x4 | 94 | 04/02 → | 2.798 | D | M | 4 | 8 | 8140.43S (F28DTCR) | | 81316 |

Boxer III

| | | | | | | | | | | |
|-------------|-----|---------|-------|---|---|---|----|-------------------|--|-------|
| 2.2 HDi 100 | 74 | 04/06 → | 2.198 | D | M | 4 | 16 | 4HV (P22DTE) | | 82066 |
| 2.2 HDi 110 | 81 | 03/11 → | 2.198 | D | M | 4 | 16 | 4HG (P22DTE) | | 82066 |
| 2.2 HDi 120 | 88 | 04/06 → | 2.198 | D | M | 4 | 16 | 4HU (P22DTE) | | 82066 |
| 2.2 HDi 130 | 96 | 03/11 → | 2.198 | D | M | 4 | 16 | 4HH (P22DTE) | | 82066 |
| 2.2 HDi 150 | 110 | 03/11 → | 2.198 | D | M | 4 | 16 | 4HJ (P22DTE) | | 82066 |
| 3.0 HDi | 115 | 07/06 → | 2.998 | D | M | 4 | 16 | F1CE0481D (F30DT) | | 82094 |
| 3.0 HDi 145 | 107 | 04/10 → | 2.999 | D | M | 4 | 16 | | | 82094 |
| 3.0 HDi 160 | 116 | 04/06 → | 2.999 | D | M | 4 | 16 | F1CE0481D (F30DT) | | 82094 |
| 3.0 HDi 175 | 130 | 03/11 → | 2.999 | D | M | 4 | 16 | F1CE0481D (F30DT) | | 82094 |

Expert I

| | | | | | | | | | | |
|----------|----|---------------|-------|---|---|---|---|--------------------------|--------|-------|
| 1.6 | 58 | 02/96 → | 1.581 | B | M | 4 | 8 | 222A2 (1580SPI) | (-)COP | 81368 |
| | 58 | 02/96 → | 1.581 | B | M | 4 | 8 | 222A2 (1580SPI) | (+)COP | 81346 |
| 1.8 | 74 | 10/96 → 09/00 | 1.761 | B | M | 4 | 8 | LFZ (XU7JP) | | 81512 |
| 1.9 D | 51 | 06/98 → 11/03 | 1.868 | D | M | 4 | 8 | WJY (DW8B), WJZ (DW8) | | 81642 |
| | 51 | 12/03 → | 1.868 | D | M | 4 | 8 | WJY (DW8B), WJZ (DW8) | | 81713 |
| | 51 | 02/96 → | 1.905 | D | M | 4 | 8 | D9B (XUD9AU) | | 81642 |
| 1.9 D 70 | 51 | 12/98 → | 1.868 | D | M | 4 | 8 | WJY (DW8B), WJZ (DW8) | | 81713 |
| 1.9 TD | 66 | 02/96 → | 1.905 | D | M | 4 | 8 | DHX (XUD9TE) | | 81642 |
| | 68 | 02/96 → | 1.905 | D | M | 4 | 8 | D8B (XUD9TE) | | 81642 |

KW

cm³

NO. OF VALVES

PEUGEOT
Expert I

| | | | | | | | | | | | |
|-------------|-----|---------------|-------|---|---|---|----|--|--------|-------|------------|
| 2.0 | 100 | 07/00 → | 1.997 | B | M | 4 | 16 | RFN (EW10J4) | (-)COP | 84038 | NEW |
| | 100 | 07/00 → | 1.997 | B | M | 4 | 16 | RFN (EW10J4) | (+)COP | 82089 | |
| | 100 | 07/00 → | 1.997 | B | M | 4 | 16 | RFN (EW10J4) | | 82089 | |
| | 100 | 07/00 → | 1.997 | B | M | 4 | 16 | RFN (EW10J4) | | 81799 | |
| 2.0 HDi | 69 | 07/00 → | 1.997 | D | M | 4 | 8 | RHX (DW10BTED) | | 81800 | |
| | 69 | 10/00 → 11/03 | 1.997 | D | M | 4 | 8 | RHX (DW10BTED) | | 81713 | |
| | 80 | 07/00 → | 1.997 | D | M | 4 | 16 | RHW (DW10ATED4) | | 81800 | |
| | 80 | 10/00 → 10/06 | 1.997 | D | M | 4 | 16 | RHW (DW10ATED4) | | 81713 | |
| | 80 | 07/00 → | 1.997 | D | M | 4 | 8 | RHZ (DW10ATED), RHZ (DW10BTED), RHZ (DW10CTED) | | 81713 | |
| | 80 | 07/00 → | 1.997 | D | M | 4 | 8 | RHZ (DW10ATED), RHZ (DW10BTED), RHZ (DW10CTED) | | 81800 | |
| 2.0 HDi 16V | 80 | 07/00 → | 1.997 | D | M | 4 | 16 | RHW (DW10ATED4) | | 81713 | |

Expert II, Tepee

| | | | | | | | | | | | |
|-----------------|-----|---------|-------|---|---|---|----|-----------------------------|--------|-------|------------|
| 1.6 HDi 90 | 66 | 01/07 → | 1.560 | D | M | 4 | 16 | 9HU (DV6UTED4) | | 81869 | |
| 1.6 HDi 90 16V | 66 | 01/07 → | 1.560 | D | M | 4 | 16 | 9HU (DV6UTED4) | | 81869 | |
| 2.0 16V | 103 | 01/07 → | 1.997 | B | M | 4 | 16 | RFH (EW10A), RFJ (EW10A) | (-)COP | 84038 | NEW |
| | 103 | 01/07 → | 1.997 | B | M | 4 | 16 | RFH (EW10A), RFJ (EW10A) | (+)COP | 82089 | |
| | 103 | 01/07 → | 1.997 | B | M | 4 | 16 | RFH (EW10A), RFJ (EW10A) | | 82089 | |
| | 103 | 01/07 → | 1.997 | B | M | 4 | 16 | RFH (EW10A), RFJ (EW10A) | | 81799 | |
| 2.0 HDi 100 | 72 | 03/11 → | 1.997 | D | M | 4 | 16 | AHY (DW10CE) | | 84020 | NEW |
| 2.0 HDi 120 | 88 | 01/07 → | 1.997 | D | M | 4 | 16 | RHK (DW10UTED4) | | 81800 | |
| 2.0 HDi 120 4x4 | 88 | 01/07 → | 1.997 | D | M | 4 | 16 | RHK (DW10UTED4) | | 84020 | NEW |
| 2.0 HDi 130 | 94 | 03/11 → | 1.997 | D | M | 4 | 16 | AHZ (DW10CD) | | 84020 | NEW |
| 2.0 HDi 140 | 100 | 01/07 → | 1.997 | D | M | 4 | 16 | RHR (DW10BTED4) | | 81800 | |
| 2.0 HDi 165 | 120 | 09/09 → | 1.997 | D | M | 4 | 16 | RHH (DW10CTED4) | | 84020 | NEW |

J5 I

| | | | | | | | | | | | |
|--------|----|---------------|-------|---|---|---|---|------------------------------|--|-------|--|
| 2.0 | 55 | 09/81 → 09/90 | 1.971 | B | M | 4 | 8 | 170B (XN1T) | | 81367 | |
| | 55 | 09/87 → 08/90 | 1.971 | B | M | 4 | 8 | XN1T | | 81367 | |
| | 58 | 01/83 → 09/90 | 1.971 | B | M | 4 | 8 | 170 (XN1T) | | 81367 | |
| | 58 | 09/81 → 08/90 | 1.971 | B | M | 4 | 8 | XN1P | | 81367 | |
| 2.5 D | 54 | 09/81 → 08/90 | 2.498 | D | M | 4 | 8 | CRD93 | | 81822 | |
| | 54 | 09/81 → 09/90 | 2.498 | D | M | 4 | 8 | CRD93 (U25/661) | | 81822 | |
| 2.5 DT | 70 | 09/81 → 08/90 | 2.498 | D | M | 4 | 8 | CRD93L, CRD93LS (U25/673) | | 81822 | |

KW

cm³

NO. OF VALVES

MAGNETI MARELLI
PEUGEOT
J5 II

| | | | | | | | | | | |
|------------|----|---------------|-------|---|---|---|---|--------------------------|-------------------------|-------|
| 1.9 D | 51 | 10/90 → 02/94 | 1.905 | D | M | 4 | 8 | D9B (XUD9A) | | 81672 |
| 2.0 | 62 | 10/90 → 02/94 | 1.971 | B | M | 4 | 8 | 170D (XN1TACP) | 09-1981 →, → 01-1994 | 81367 |
| | 62 | 10/90 → 02/94 | 1.971 | B | M | 4 | 8 | 170D (XN1TACP) | | 81367 |
| | 62 | 09/90 → 01/94 | 1.971 | B | M | 4 | 8 | 170D (XN1TACP), XN1TA | | 81367 |
| 2.5 D | 54 | 09/90 → 01/94 | 2.498 | D | M | 4 | 8 | CRD93 | | 81822 |
| | 54 | 10/90 → 02/94 | 2.500 | D | M | 4 | 8 | CRD93 (U25/661) | | 81822 |
| 2.5 D 4x4 | 54 | 10/90 → 02/94 | 2.500 | D | M | 4 | 8 | CRD93 (U25/661) | | 81822 |
| 2.5 DT | 70 | 09/90 → 01/94 | 2.498 | D | M | 4 | 8 | CRD93L | | 81822 |
| 2.5 TD | 70 | 10/90 → 02/94 | 2.500 | D | M | 4 | 8 | CRD93LS (U25/673) | | 81822 |
| 2.5 TD 4x4 | 70 | 10/90 → 02/94 | 2.500 | D | M | 4 | 8 | CRD93LS (U25/673) | | 81822 |

Partner I

| | | | | | | | | | | |
|------------|----|---------------|-------|----|---|---|----|-----------------------------------|-----------------|-------|
| 1.1 | 44 | 06/96 → | 1.124 | B | M | 4 | 8 | HDZ (TU1M) | → 10-2002 | 81556 |
| | 44 | 06/96 → | 1.124 | B | M | 4 | 8 | HDZ (TU1M) | 11-2002 → | 81797 |
| | 44 | 06/96 → | 1.124 | B | M | 4 | 8 | HDZ (TU1M), HFX (TU1JP) | → 10-2002 | 81556 |
| | 44 | 06/96 → | 1.124 | B | M | 4 | 8 | HDZ (TU1M), HFX (TU1JP) | 11-2002 → | 81797 |
| 1.4 | 54 | 11/02 → 10/06 | 1.360 | B | M | 4 | 8 | KFW (TU3JP) | | 81797 |
| | 55 | 06/96 → | 1.360 | B | M | 4 | 8 | KFW (TU3JP), KFX (TU3JP), TU32 | → 10-2002 | 81556 |
| | 55 | 06/96 → | 1.360 | B | M | 4 | 8 | KFW (TU3JP), KFX (TU3JP), TU32 | 11-2002 → | 81797 |
| | 55 | 06/96 → | 1.360 | B | M | 4 | 8 | KFX (TU3JP), TU32 | → 10-2002 | 81556 |
| | 55 | 06/96 → | 1.360 | B | M | 4 | 8 | KFX (TU3JP), TU32 | 11-2002 → | 81797 |
| 1.4 BiFuel | 55 | 04/03 → | 1.360 | BF | M | 4 | 8 | KFW (TU3JP) | → M: 3.666.765 | 81556 |
| | 55 | 04/03 → | 1.360 | BF | M | 4 | 8 | KFW (TU3JP) | M → : 3.666.766 | 81797 |
| 1.6 | 80 | 09/00 → 10/02 | 1.587 | B | M | 4 | 16 | NFU (TU5JP4) | | 81753 |
| 1.6 16V | 80 | 07/01 → | 1.587 | B | M | 4 | 16 | NFU (TU5JP4) | | 81753 |
| 1.6 HDi 75 | 55 | 02/06 → | 1.560 | D | M | 4 | 16 | 9HW (DV6BTED4) | | 81869 |
| 1.6 HDi 90 | 66 | 10/05 → | 1.560 | D | M | 4 | 16 | 9HX (DV6ATED4) | | 81869 |
| 1.8 | 66 | 05/97 → | 1.761 | B | M | 4 | 8 | LFX (XU7JB) | 03-1997 → | 81512 |
| 1.8 D | 43 | 06/96 → | 1.769 | D | M | 4 | 8 | A9A (XUD7) | 03-1997 → | 81512 |
| | 44 | 11/96 → 02/98 | 1.769 | D | M | 4 | 8 | A9A (XUD7) | | 81642 |
| 1.9 D | 51 | 06/96 → | 1.868 | D | M | 4 | 8 | WJY (DW8B), WJZ (DW8) | | 81713 |
| | 51 | 12/98 → | 1.868 | D | M | 4 | 8 | WJY (DW8B), WJZ (DW8) | | 81642 |
| | 50 | 06/96 → | 1.905 | D | M | 4 | 8 | DJY (XUD9A) | | 81642 |
| | 51 | 06/96 → | 1.905 | D | M | 4 | 8 | DJY (XUD9A) | | 81642 |
| | 51 | 05/96 → 12/98 | 1.905 | D | M | 4 | 8 | XUD9 | | 81642 |
| 1.9 D 4x4 | 51 | 04/04 → 08/05 | 1.868 | D | M | 4 | 8 | WJY (DW8B) | | 81713 |
| 2.0 HDI | 66 | 02/00 → | 1.997 | D | M | 4 | 8 | RHY (DW10TD) | | 81713 |

| | | | | | | | | | |
|--|--|--|--|--|--|--|--|--|--|
| | | | | | | | | | |
|--|--|--|--|--|--|--|--|--|--|

PEUGEOT

Partner I

| | | | | | | | | | |
|-------------|----|---------------|-------|---|---|---|---|--------------|-------|
| 2.0 HDi 4x4 | 66 | 04/04 → 08/05 | 1.997 | D | M | 4 | 8 | RHY (DW10TD) | 81800 |
| | 66 | 04/04 → | 1.997 | D | M | 4 | 8 | RHY (DW10TD) | 81713 |

Partner II, Tepee

| | | | | | | | | | |
|-----------------|----|---------|-------|---|---|---|----|--|-------|
| 1.6 | 66 | 04/08 → | 1.587 | B | M | 4 | 16 | NFR (TU5JP4B) | 81753 |
| | 80 | 04/08 → | 1.587 | B | M | 4 | 16 | NFU (TU5JP4) | 81753 |
| | 72 | 08/10 → | 1.598 | B | M | 4 | 16 | 5FK (EP6CB) | 81753 |
| | 72 | 11/10 → | 1.598 | B | M | 4 | 16 | 5FK (EP6CB) | 82032 |
| | 88 | 04/10 → | 1.598 | B | M | 4 | 16 | 5FS (EP6C) | 81753 |
| 1.6 HDi | 55 | 04/08 → | 1.560 | D | M | 4 | 16 | 9HN (DV6ETED4), 9HT (DV6BTED4), 9HW (DV6BTED4) | 81869 |
| | 55 | 04/08 → | 1.560 | D | M | 4 | 16 | 9HT (DV6BTED4), 9HW (DV6BTED4) | 81869 |
| | 80 | 04/08 → | 1.560 | D | M | 4 | 16 | 9HZ (DV6TED4) | 81869 |
| | 82 | 08/10 → | 1.560 | D | M | 4 | 8 | 9HL (DV6C) | 81869 |
| | 84 | 03/13 → | 1.560 | D | M | 4 | 8 | 9HL (DV6C) | 81869 |
| 1.6 HDi 16V | 66 | 04/08 → | 1.560 | D | M | 4 | 16 | 9HS (DV6TED4BU), 9HX (DV6ATED4) | 81869 |
| | 66 | 04/08 → | 1.560 | D | M | 4 | 16 | 9HV (DV6TED4), 9HX (DV6ATED4) | 81869 |
| 1.6 HDi 16V 4x4 | 66 | 04/12 → | 1.560 | D | M | 4 | 16 | 9HS (DV6TED4BU), 9HX (DV6ATED4) | 81869 |
| 1.6 HDi 90 | 68 | 04/10 → | 1.560 | D | M | 4 | 8 | 9HP (DV6DTED) | 81869 |
| | 68 | 04/10 → | 1.560 | D | M | 4 | 8 | 9HP (DV6DTED), 9HX (DV6ATED4) | 81869 |

RCZ

| | | | | | | | | | |
|-------------|-----|---------|-------|---|---|---|----|-----------------|-------|
| 1.6 16V | 115 | 03/10 → | 1.598 | B | M | 4 | 16 | EP6CDT | 82032 |
| | 147 | 06/10 → | 1.598 | B | M | 4 | 16 | EP6CDTX | 82032 |
| 1.6 THP 270 | 199 | 06/13 → | 1.598 | B | M | 4 | 16 | 5FG (EP6CDTR) | 82032 |
| 2.0 HDi | 120 | 03/10 → | 1.997 | D | M | 4 | 16 | RHH (DW10CTED4) | 84020 |

PROTON

Persona 400

| | | | | | | | | | |
|-------|----|---------|-------|---|---|---|----|------|-------|
| 416 i | 70 | 12/95 → | 1.597 | B | M | 4 | 16 | 4G92 | 81731 |
|-------|----|---------|-------|---|---|---|----|------|-------|

PUCH

G Model

| | | | | | | | | | |
|----------------|-----|---------|-------|---|---|---|----|-----------|-------|
| 290 GD/G 290 D | 70 | 04/92 → | 2.874 | D | M | 5 | 10 | OM602.942 | 81506 |
| 300 GE | 125 | 06/90 → | 2.960 | B | M | 6 | 12 | M103.987 | 81507 |
| 350 G Turbo D | 100 | 09/91 → | 3.449 | D | M | 6 | 12 | OM603.972 | 81506 |
| G 290 TD | 88 | 07/97 → | 2.874 | D | M | 5 | 10 | OM602.983 | 81506 |

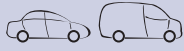
KW

cm³

NO. OF VALVES

MAGNETI MARELLI
RENAULT

| 4 | | | | | | | | | | | |
|-------------------------------|-----|---------------|-------|---|---|---|----|----------------|--|------------------------------|-------|
| 1.0 | 25 | 06/87 → 12/93 | 956 | B | M | 4 | 8 | C1C708 | | | 81660 |
| | 31 | 12/85 → 06/93 | 956 | B | M | 4 | 8 | 689710 | | | 81660 |
| | 25 | 06/87 → 06/93 | 956 | B | M | 4 | 8 | C1C708 | | | 81660 |
| 1.1 | 32 | 06/86 → 06/90 | 1.108 | B | M | 4 | 8 | C1E714 | | | 81660 |
| 19 I, Chamade, Cabrio | | | | | | | | | | | |
| 1.2 | 40 | 01/88 → 12/92 | 1.237 | B | M | 4 | 8 | C1G730 | | (-)COP | 81573 |
| | 40 | 01/88 → 12/92 | 1.237 | B | M | 4 | 8 | C1G730 | | (+)COP | 81811 |
| 1.4 | 55 | 09/90 → 04/92 | 1.390 | B | M | 4 | 8 | E7J700 | | | 81661 |
| | 57 | 07/88 → 08/90 | 1.390 | B | M | 4 | 8 | E6J700, E6J701 | | | 81661 |
| | 59 | 01/88 → 12/92 | 1.390 | B | M | 4 | 8 | E6J700 | | | 81661 |
| | 59 | 01/88 → 12/92 | 1.390 | B | M | 4 | 8 | E6J700, E6J701 | | | 81661 |
| | 43 | 07/88 → 04/92 | 1.397 | B | M | 4 | 8 | C2J772, C3J710 | | (-)COP | 81573 |
| | 43 | 01/89 → 04/92 | 1.397 | B | M | 4 | 8 | C2J772, C3J710 | | (-)COP, 07-1988 →, → 04-1992 | 81573 |
| 1.4 | 43 | 01/89 → 04/92 | 1.397 | B | M | 4 | 8 | C2J772, C3J710 | | (+)COP | 81811 |
| 1.7 | 55 | 07/91 → 04/92 | 1.721 | B | M | 4 | 8 | F2N724 | | | 81574 |
| | 70 | 07/91 → 04/92 | 1.721 | B | M | 4 | 8 | F3N742, F3N743 | | | 81574 |
| | 54 | 09/88 → 04/92 | 1.721 | B | M | 4 | 8 | F3N740, F3N741 | | | 81574 |
| | 66 | 09/88 → 04/92 | 1.721 | B | M | 4 | 8 | F3N742, F3N743 | | | 81574 |
| | 79 | 08/88 → 12/92 | 1.721 | B | M | 4 | 8 | F3N746 | | | 81574 |
| 1.8 16V | 99 | 06/89 → 04/92 | 1.764 | B | M | 4 | 16 | F7P704 | | | 81574 |
| | 101 | 07/91 → 04/92 | 1.764 | B | M | 4 | 16 | F7P700, F7P704 | | | 81574 |
| 1.9 D | 48 | 01/88 → 12/92 | 1.870 | D | M | 4 | 8 | F8Q706, F8Q742 | | | 81574 |
| | 47 | 09/88 → 04/92 | 1.870 | D | M | 4 | 8 | F8Q706, F8Q742 | | | 81574 |
| 1.9 DT | 68 | 09/90 → 04/92 | 1.870 | D | M | 4 | 8 | F8Q610 | | | 81574 |
| 1.9 TD | 68 | 09/90 → 04/92 | 1.870 | D | M | 4 | 8 | F8Q740 | | | 81574 |
| 19 II, Chamade, Cabrio | | | | | | | | | | | |
| 1.2 | 44 | 05/92 → 09/94 | 1.171 | B | M | 4 | 8 | E7F730 | | | 81661 |
| | 40 | 03/92 → 12/95 | 1.237 | B | M | 4 | 8 | C1G730 | | | 81661 |
| | 40 | 04/92 → 12/95 | 1.237 | B | M | 4 | 8 | C1G730 | | (-)COP | 81573 |
| | 40 | 04/92 → 12/95 | 1.237 | B | M | 4 | 8 | C1G730 | | (+)COP | 81811 |
| 1.4 | 59 | 03/92 → 12/95 | 1.390 | B | M | 4 | 8 | E6J700 | | | 81661 |
| | 59 | 01/92 → 12/95 | 1.390 | B | M | 4 | 8 | E6J700, E7J706 | | | 81661 |
| | 59 | 10/94 → 11/95 | 1.390 | B | M | 4 | 8 | E7J706 | | | 81661 |
| | 55 | 01/92 → 12/95 | 1.390 | B | M | 4 | 8 | E7J742 | | | 81661 |
| | 43 | 04/92 → 12/95 | 1.397 | B | M | 4 | 8 | C3J710 | | (-)COP | 81573 |
| | 43 | 04/92 → 12/95 | 1.397 | B | M | 4 | 8 | C3J710 | | (+)COP | 81811 |
| 1.7 | 54 | 04/92 → 12/95 | 1.721 | B | M | 4 | 8 | F3N740, F3N741 | | | 81574 |
| | 66 | 04/92 → 09/93 | 1.721 | B | M | 4 | 8 | F3N742, F3N743 | | | 81574 |
| | 66 | 04/92 → 12/95 | 1.721 | B | M | 4 | 8 | F3N743 | | | 81574 |

| | | | | | | | | | | | |
|--|--|----|--|-----------------|--|--|--|---------------|--|--|--|
| | | KW | | cm ³ | | | | NO. OF VALVES | | | |
|--|--|----|--|-----------------|--|--|--|---------------|--|--|--|

RENAULT

19 II, Chamade, Cabrio

| | | | | | | | | | | |
|---------|----|---------------|-------|---|---|---|----|--|--|-------|
| 1.8 | 79 | 05/94 → 12/95 | 1.783 | B | M | 4 | 8 | F3P682 | | 81574 |
| | 65 | 04/92 → 06/96 | 1.794 | B | M | 4 | 8 | F3P704, F3P705, F3P706, F3P707, F3P708, F3P760 | | 81574 |
| | 65 | 04/92 → 12/95 | 1.794 | B | M | 4 | 8 | F3P706, F3P707, F3P708, F3P760 | | 81574 |
| | 66 | 04/92 → 12/95 | 1.794 | B | M | 4 | 8 | F3P706, F3P760 | | 81574 |
| | 79 | 07/94 → 06/96 | 1.794 | B | M | 4 | 8 | F3P682, F3P764, F3P765 | | 81574 |
| | 79 | 05/94 → 12/95 | 1.794 | B | M | 4 | 8 | F3P682, F3P765 | | 81574 |
| | 81 | 04/92 → 05/94 | 1.794 | B | M | 4 | 8 | F3P700 | | 81574 |
| 1.8 16V | 99 | 04/92 → 12/95 | 1.764 | B | M | 4 | 16 | F7P704 | | 81574 |
| 1.9 D | 48 | 03/92 → 12/95 | 1.870 | D | M | 4 | 8 | F8Q706, F8Q742 | | 81574 |
| | 47 | 04/92 → 12/95 | 1.870 | D | M | 4 | 8 | F8Q742 | | 81574 |
| 1.9 dT | 68 | 03/92 → 12/95 | 1.870 | D | M | 4 | 8 | F8Q740 | | 81574 |
| | 66 | 04/92 → 12/95 | 1.870 | D | M | 4 | 8 | F8Q744 | | 81574 |

21, Station Wagon

| | | | | | | | | | | |
|-----------|-----|---------------|-------|---|---|---|----|--------------------------------|----------------|-------|
| 1.4 | 51 | 09/89 → 05/93 | 1.397 | B | M | 4 | 8 | C2J770 | (-)COP | 81573 |
| | 51 | 09/89 → 05/93 | 1.397 | B | M | 4 | 8 | C2J770 | (+)COP | 81811 |
| 1.7 | 65 | 06/86 → 04/95 | 1.721 | B | M | 4 | 8 | F2N710 | | 81574 |
| | 54 | 06/86 → 06/93 | 1.721 | B | M | 4 | 8 | F2N750, F3N726 | | 81574 |
| | 54 | 09/89 → 10/92 | 1.721 | B | M | 4 | 8 | F3N726 | | 81574 |
| | 55 | 06/86 → 03/93 | 1.721 | B | M | 4 | 8 | F2N712 | | 81574 |
| | 65 | 03/86 → 03/93 | 1.721 | B | M | 4 | 8 | F2N710 | | 81574 |
| | 66 | 09/89 → 06/94 | 1.721 | B | M | 4 | 8 | F3N722, F3N723 | | 81574 |
| | 69 | 03/86 → 02/94 | 1.721 | B | M | 4 | 8 | F3N722, F3N723 | | 81574 |
| 1.9 D | 47 | 06/86 → 08/94 | 1.870 | D | M | 4 | 8 | F8Q710 | | 81574 |
| | 47 | 09/89 → 01/94 | 1.870 | D | M | 4 | 8 | F8Q710 | | 81574 |
| 2.0 | 78 | 05/91 → 10/93 | 1.995 | B | M | 4 | 8 | J6R758 | → M: F.197.763 | 81608 |
| | 78 | 05/91 → 10/93 | 1.995 | B | M | 4 | 8 | J6R758 | M →: F.197.764 | 81666 |
| | 75 | 03/86 → 10/93 | 1.995 | B | M | 4 | 8 | J6R758, J6R759, J6R792, J6R793 | → M: F.197.763 | 81608 |
| | 75 | 03/86 → 10/93 | 1.995 | B | M | 4 | 8 | J6R758, J6R759, J6R792, J6R793 | M →: F.197.764 | 81666 |
| | 88 | 09/89 → 12/93 | 1.995 | B | M | 4 | 8 | J7R746, J7R747 | → M: F.197.763 | 81608 |
| | 88 | 09/89 → 12/93 | 1.995 | B | M | 4 | 8 | J7R746, J7R747 | M →: F.197.764 | 81666 |
| | 99 | 02/90 → 10/92 | 1.995 | B | M | 4 | 12 | J7R740 | → M: F.197.763 | 81608 |
| | 99 | 02/90 → 10/92 | 1.995 | B | M | 4 | 12 | J7R740 | M →: F.197.764 | 81666 |
| 2.0 4x4 | 88 | 03/89 → 12/93 | 1.995 | B | M | 4 | 8 | J7R746, J7R747 | → M: F.197.763 | 81608 |
| | 88 | 03/89 → 12/93 | 1.995 | B | M | 4 | 8 | J7R746, J7R747 | M →: F.197.764 | 81666 |
| | 99 | 09/90 → 10/92 | 1.995 | B | M | 4 | 12 | J7R740 | → M: F.197.763 | 81608 |
| | 99 | 09/90 → 10/92 | 1.995 | B | M | 4 | 12 | J7R740 | M →: F.197.764 | 81666 |
| 2.0 Turbo | 119 | 02/90 → 10/92 | 1.995 | B | M | 4 | 8 | J7R756 | M →: F.209.863 | 81754 |
| | 129 | 04/87 → 03/90 | 1.995 | B | M | 4 | 8 | J7R752 | M →: F.209.863 | 81754 |

KW

cm³

NO. OF VALVES

MAGNETI MARELLI
RENAULT
21, Station Wagon

| | | | | | | | | | | |
|---------------|-----|---------------|-------|---|---|---|---|------------------------|----------------|-------|
| 2.0 Turbo 4x4 | 129 | 08/89 → 10/93 | 1.995 | B | M | 4 | 8 | J7R752 | M →: F.209.863 | 81754 |
| | 119 | 02/90 → 10/92 | 1.995 | B | M | 4 | 8 | J7R756 | M →: F.209.863 | 81754 |
| 2.1 D | 49 | 06/86 → 08/94 | 2.068 | D | M | 4 | 8 | J8S704 | | 81608 |
| | 48 | 10/86 → 09/90 | 2.068 | D | M | 4 | 8 | J8S704 | | 81608 |
| | 51 | 04/92 → 06/94 | 2.068 | D | M | 4 | 8 | J8S784 | | 81608 |
| | 53 | 09/89 → 12/92 | 2.068 | D | M | 4 | 8 | J8S600, J8S740 | | 81608 |
| 2.1 D 4x4 | 48 | 10/88 → 05/92 | 2.068 | D | M | 4 | 8 | J8S704 | | 81608 |
| 2.1 Turbo-D | 65 | 09/89 → 06/94 | 2.068 | D | M | 4 | 8 | J8S714, J8S786, J8S788 | | 81608 |
| 2.2 | 79 | 09/89 → 06/94 | 2.165 | B | M | 4 | 8 | J7T754, J7T755 | → M: F241.442 | 81608 |
| | 79 | 09/89 → 06/94 | 2.165 | B | M | 4 | 8 | J7T754, J7T755 | M →: F241.443 | 81666 |
| 2.2 4x4 | 79 | 07/90 → 06/94 | 2.165 | B | M | 4 | 8 | J7T754, J7T755 | → M: F241.442 | 81608 |
| | 79 | 07/90 → 06/94 | 2.165 | B | M | 4 | 8 | J7T754, J7T755 | M →: F241.443 | 81666 |

25

| | | | | | | | | | | |
|-----------------|-----|---------------|-------|---|---|---|----|--|----------------|-------|
| 2.0 | 88 | 03/87 → 12/93 | 1.995 | B | M | 4 | 8 | J7R722, J7R723 | | 81666 |
| | 74 | 04/84 → 12/92 | 1.995 | B | M | 4 | 8 | J6R706, J6R707, J6R760, J6R762, J6R763 | → M: F.308.131 | 81828 |
| | 74 | 04/84 → 12/92 | 1.995 | B | M | 4 | 8 | J6R706, J6R707, J6R760, J6R762, J6R763 | M →: F.308.132 | 81754 |
| 2.0 12V | 103 | 06/88 → 12/93 | 1.995 | B | M | 4 | 12 | J7R720, J7R721 | | 81666 |
| | 99 | 06/89 → 12/92 | 1.995 | B | M | 4 | 12 | J7R726 | | 81666 |
| 2.1 Diesel | 51 | 06/89 → 12/92 | 2.068 | D | M | 4 | 8 | J8S736 | | 81851 |
| 2.1 Turbo-D FWD | 63 | 04/84 → 12/92 | 2.068 | D | M | 4 | 8 | J8S708, J8S738 | M →: F.397.290 | 81755 |
| 2.2 | 79 | 09/86 → 12/92 | 2.165 | B | M | 4 | 8 | J7T708, J7T732, J7T733 | | 81666 |

Avantime

| | | | | | | | | | | |
|---------------|-----|---------------|-------|---|----|---|----|----------------|--|-------|
| 2.0 16V Turbo | 120 | 11/01 → 05/03 | 1.998 | B | M | 4 | 16 | F4R760, F4R761 | | 81814 |
| | 120 | 11/01 → 05/03 | 1.998 | B | M | 4 | 16 | F4R760, F4R761 | | 84009 |
| 2.2 dCi | 110 | 05/02 → 05/03 | 2.188 | D | M | 4 | 16 | G9T712 | | 81855 |
| 3.0 V6 | 152 | 09/01 → 05/03 | 2.946 | B | AM | 6 | 24 | L7X720, L7X721 | | 81813 |

Captur

| | | | | | | | | | | |
|-------------|----|---------|-------|---|---|---|----|--------|--|-------|
| 0.9 TCe 90 | 66 | 06/13 → | 898 | B | M | 3 | 12 | H4B400 | | 84003 |
| 1.2 TCe 120 | 88 | 06/13 → | 1.197 | B | M | 4 | 16 | H5F403 | | 84003 |
| 1.5 dCi 110 | 81 | 01/15 → | 1.461 | D | M | 4 | 8 | K9K646 | | 82098 |



KW

cm³

NO. OF VALVES

RENAULT
Clio I

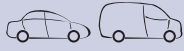
| | | | | | | | | | | |
|----------------|-----|---------------|-------|---|---|---|----|-----------------------------------|---------------------------------|-------|
| 1.1 | 34 | 01/91 → 09/98 | 1.108 | B | M | 4 | 8 | C1E700 | (-)COP | 81573 |
| | 34 | 01/91 → 09/98 | 1.108 | B | M | 4 | 8 | C1E700 | (-)COP, → 05-1994, M: C1E700 | 81573 |
| | 34 | 01/91 → 09/98 | 1.108 | B | M | 4 | 8 | C1E700 | (+)COP | 81811 |
| | 34 | 01/91 → 09/98 | 1.108 | B | M | 4 | 8 | C1E700 | (+)COP, → 05-1994, M: C1E700 | 81811 |
| | 36 | 04/92 → 08/92 | 1.108 | B | M | 4 | 8 | C1E700 | (-)COP, → 05-1994, M: C1E700 | 81573 |
| | 36 | 04/92 → 08/92 | 1.108 | B | M | 4 | 8 | C1E700 | (+)COP, → 05-1994, M: C1E700 | 81811 |
| 1.2 | 40 | 01/91 → 09/98 | 1.171 | B | M | 4 | 8 | E7F706 | | 81661 |
| | 44 | 01/91 → 09/98 | 1.171 | B | M | 4 | 8 | E7F750 | | 81661 |
| | 40 | 06/94 → 02/98 | 1.239 | B | M | 4 | 8 | C3G720 | (-)COP | 81596 |
| | 40 | 06/94 → 02/98 | 1.239 | B | M | 4 | 8 | C3G720 | (+)COP | 81854 |
| | 40 | 01/96 → 09/98 | 1.149 | B | M | 4 | 8 | D7F730 | | 81762 |
| | 43 | 01/96 → 09/98 | 1.149 | B | M | 4 | 8 | D7F730 | | 81762 |
| | 40 | 01/91 → 06/96 | 1.171 | B | M | 4 | 8 | E7F706 | | 81661 |
| | 43 | 05/90 → 09/98 | 1.171 | B | M | 4 | 8 | E7F700, E7F708, E7F750 | | 81661 |
| | 44 | 05/90 → 03/96 | 1.171 | B | M | 4 | 8 | E5F710 | | 81661 |
| | 40 | 01/96 → 12/96 | 1.239 | B | M | 4 | 8 | C3G720 | (-)COP | 81596 |
| 1.4 | 59 | 01/91 → 09/98 | 1.390 | B | M | 4 | 8 | E7J710, E7J711 | | 81661 |
| | 55 | 01/91 → 09/98 | 1.390 | B | M | 4 | 8 | E7J756, E7J757 | | 81661 |
| | 58 | 01/91 → 09/98 | 1.390 | B | M | 4 | 8 | E7J601, E7J718, E7J719, E7J754 | | 81661 |
| 1.7 | 68 | 01/91 → 12/93 | 1.721 | B | M | 4 | 8 | F2N770 | | 81574 |
| 1.8 | 70 | 01/91 → 09/98 | 1.794 | B | M | 4 | 8 | F3P710 | | 81574 |
| | 65 | 01/91 → 09/98 | 1.794 | B | M | 4 | 8 | F3P710, F3P714 | | 81574 |
| | 66 | 08/94 → 09/98 | 1.794 | B | M | 4 | 8 | F3P754, F3P755 | | 81574 |
| 1.8 16V | 99 | 01/91 → 03/96 | 1.764 | B | M | 4 | 16 | F7P722 | | 81574 |
| 1.8 Rsi | 79 | 08/95 → 09/98 | 1.783 | B | M | 4 | 8 | F3P758 | | 81574 |
| | 80 | 01/93 → 08/95 | 1.794 | B | M | 4 | 8 | F3P712 | | 81574 |
| 1.9 D | 40 | 01/97 → 09/98 | 1.870 | D | M | 4 | 8 | F8Q678 | | 81574 |
| | 48 | 01/91 → 09/98 | 1.870 | D | M | 4 | 8 | F8Q730, F8Q732 | | 81574 |
| | 47 | 01/91 → 09/98 | 1.870 | D | M | 4 | 8 | F8Q730, F8Q732 | | 81574 |
| 1.9 RND | 40 | 04/96 → 02/98 | 1.870 | D | M | 4 | 8 | F8Q678 | | 81574 |
| Williams | 108 | 01/94 → 09/98 | 1.998 | B | M | 4 | 16 | F7R700 | | 81574 |
| Clio II | | | | | | | | | | |
| 1.1 | 43 | 09/98 → | 1.149 | B | M | 4 | 8 | D7F720, D7F726, D7F746 | | 81762 |

KW

cm³

NO. OF VALVES

MAGNETI MARELLI
RENAULT
Clio II

| | | | | | | | | | | |
|---------|----|---------------|-------|---|---|---|----|---|-----------|------------------|
| 1.2 | 55 | 06/01 → | 1.149 | B | M | 4 | 8 | | | 81762 |
| | 43 | 09/98 → | 1.149 | B | M | 4 | 8 | D7F720, D7F726, D7F746, D7F764, D7F766 | → 12-2003 | 81762 |
| | 43 | 09/98 → | 1.149 | B | M | 4 | 8 | D7F720, D7F726, D7F746, D7F764, D7F766 | 01-2004 → | 82091 |
| | 44 | 03/99 → 05/01 | 1.149 | B | M | 4 | 8 | D7F722 | | 81762 |
| | 44 | 03/99 → 10/03 | 1.149 | B | M | 4 | 8 | D7F722, D7F726, D7F746 | | 81762 |
| 1.2 16V | 55 | 06/01 → | 1.149 | B | M | 4 | 16 | D4F706, D4F712, D4F714, D4F722, D4F728 | → 05-2003 | 81820 |
| | 55 | 06/01 → | 1.149 | B | M | 4 | 16 | D4F706, D4F712, D4F714, D4F722, D4F728 | 06-2003 → | 82090 |
| 1.4 | 55 | 09/98 → 05/05 | 1.390 | B | M | 4 | 8 | E7J634, E7J780, K7J700 | | 81578 |
| 1.4 16V | 70 | 10/99 → 09/04 | 1.390 | B | M | 4 | 16 | K4J712, K4J713 | | 84039 NEW |
| | 70 | 10/99 → 09/04 | 1.390 | B | M | 4 | 16 | K4J712, K4J713 | | 81806 |
| | 72 | 08/00 → | 1.390 | B | M | 4 | 16 | K4J710, K4J711, K4J712, K4J713 | | 84039 NEW |
| | 72 | 08/00 → | 1.390 | B | M | 4 | 16 | K4J710, K4J711, K4J712, K4J713 | | 81806 |
| 1.5 dCi | 50 | 04/04 → | 1.461 | D | M | 4 | 8 | K9K714 | | 81810 |
| | 59 | 06/01 → 10/04 | 1.461 | D | M | 4 | 8 | K9K702 | | 81810 |
| | 60 | 11/03 → | 1.461 | D | M | 4 | 8 | K9K702, K9K710, K9K716 | | 81810 |
| | 74 | 01/04 → | 1.461 | D | M | 4 | 8 | K9K712 | | 84007 |
| | 47 | 06/05 → | 1.461 | D | M | 4 | 8 | K9K740 | | 84007 |
| | 48 | 06/01 → | 1.461 | D | M | 4 | 8 | K9K700, K9K704 | | 81810 |
| | 50 | 08/04 → | 1.461 | D | M | 4 | 8 | K9K700, K9K714 | | 84007 |
| | 59 | 06/01 → 10/03 | 1.461 | D | M | 4 | 8 | K9K702 | | 81810 |
| | 60 | 06/01 → | 1.461 | D | M | 4 | 8 | K9K702 | | 81810 |
| 1.6 | 62 | 02/07 → | 1.461 | D | M | 4 | 8 | K9K718 | | 84007 |
| | 66 | 09/98 → 05/05 | 1.598 | B | M | 4 | 8 | K7M744, K7M745 | | 81579 |
| 1.6 16V | 79 | 09/98 → | 1.598 | B | M | 4 | 16 | K4M708, K4M740, K4M742, K4M743, K4M744, K4M745, K4M748 | | 84039 NEW |
| | 79 | 09/98 → | 1.598 | B | M | 4 | 16 | K4M708, K4M740, K4M742, K4M743, K4M744, K4M745, K4M748 | | 81806 |

KW

cm³

NO. OF VALVES

RENAULT
Clio II

| | | | | | | | | | | | |
|---------------|-----|---------------|-------|---|---|---|----|----------------|--|-------|------------|
| 1.6 Hi-Flex | 86 | 01/05 → 02/10 | 1.598 | | M | 4 | 16 | K4M748 | | 84039 | NEW |
| | 86 | 01/05 → 02/10 | 1.598 | | M | 4 | 16 | K4M748 | | 81806 | |
| 1.9 D | 47 | 09/98 → 05/05 | 1.870 | D | M | 4 | 8 | F8Q630 | | 81574 | |
| | 48 | 02/00 → 05/01 | 1.870 | D | M | 4 | 8 | F8Q630, F8Q632 | | 81574 | |
| | 48 | 02/00 → 05/01 | 1.870 | D | M | 4 | 8 | F8Q632 | | 81574 | |
| 1.9 dTi | 59 | 12/99 → 05/05 | 1.870 | D | M | 4 | 8 | F9Q780 | | 81574 | |
| 2.0 16V Sport | 132 | 01/04 → | 1.998 | B | M | 4 | 16 | F4R738 | | 81574 | |
| | 124 | 02/00 → | 1.998 | B | M | 4 | 16 | F4R730, F4R736 | | 81574 | |
| 3.0 V6 Sport | 166 | 11/00 → 12/02 | 2.946 | B | M | 6 | 24 | L7X760 | | 81813 | |
| | 187 | 12/02 → | 2.946 | B | M | 6 | 24 | L7X762 | | 81813 | |

Clio III, Grandtour

| | | | | | | | | | | | |
|-----------------|---------|---------|-------|---|---|---|----------------|----------------|-------|-------|------------|
| 1.2 | 57 | 10/05 → | 1.149 | B | M | 4 | 16 | D4F764 | | 82090 | |
| 1.2 16V | 58 | 06/05 → | 1.149 | B | M | 4 | 16 | D4F764 | | 82090 | |
| | 76 | 09/10 → | 1.149 | B | M | 4 | 16 | D4F786 | | 81820 | |
| | 76 | 09/10 → | 1.149 | B | M | 4 | 16 | D4F786 | | 82090 | |
| | 76 | 09/10 → | 1.149 | B | M | 4 | 16 | D4F786 | | 84024 | NEW |
| | 76 | 09/10 → | 1.149 | B | M | 4 | 16 | D4F786 | | 81762 | |
| | 48 | 06/05 → | 1.149 | B | M | 4 | 16 | D4F740 | | 82090 | |
| | 55 | 06/05 → | 1.149 | B | M | 4 | 16 | D4F706, D4F740 | | 82090 | |
| | 55 | 02/08 → | 1.149 | B | M | 4 | 16 | D4F740 | | 82090 | |
| | 58 | 02/08 → | 1.149 | B | M | 4 | 16 | D4F764 | | 82090 | |
| | 74 | 02/08 → | 1.149 | B | M | 4 | 16 | D4F784 | | 82090 | |
| 1.2 16V Hi-Flex | 55 | 07/08 → | 1.149 | | M | 4 | 16 | D4F740 | | 82090 | |
| | 55 | 07/08 → | 1.149 | | M | 4 | 16 | D4F740, D4F742 | | 82090 | |
| 1.2 Ethanol | 55 | 07/08 → | 1.149 | | M | 4 | 16 | | | 81820 | |
| | 55 | 07/08 → | 1.149 | | M | 4 | 16 | | | 82090 | |
| | 55 | 07/08 → | 1.149 | | M | 4 | 16 | | | 84024 | NEW |
| | 55 | 07/08 → | 1.149 | | M | 4 | 16 | | | 81762 | |
| 1.4 16V | 72 | 02/10 → | 1.390 | B | M | 4 | 16 | K4J780 | | 84039 | NEW |
| | 72 | 02/10 → | 1.390 | B | M | 4 | 16 | K4J780 | | 81806 | |
| 1.5 dCi | 47 | 06/05 → | 1.461 | D | M | 4 | 8 | K9K752 | | 84007 | |
| | 48 | 02/10 → | 1.461 | D | M | 4 | 8 | K9K752 | | 84007 | |
| | 55 | 08/10 → | 1.461 | D | M | 4 | 8 | K9K770 | | 82098 | |
| | 60 | 11/07 → | 1.461 | D | M | 4 | 8 | K9K750 | | 84007 | |
| | 65 | 08/10 → | 1.461 | D | M | 4 | 8 | K9K770 | | 82098 | |
| | 65 | 08/10 → | 1.461 | D | M | 4 | 8 | K9K770, K9K772 | | 82098 | |
| | 50 | 02/08 → | 1.461 | D | M | 4 | 8 | K9K714, K9K768 | | 84007 | |
| | 63 | 02/08 → | 1.461 | D | M | 4 | 8 | K9K766 | | 84007 | |
| | 76 | 02/08 → | 1.461 | D | M | 4 | 8 | K9K772 | | 84007 | |
| 78 | 02/08 → | 1.461 | D | M | 4 | 8 | K9K764, K9K774 | | 84007 | | |

KW

cm³

NO. OF VALVES

MAGNETI MARELLI
RENAULT
Clio III, Grandtour

| | | | | | | | | | | | |
|---------------|-----|---------------|-------|---|---|---|----|----------------|--|-------|------------|
| 1.6 16V | 65 | 06/05 → | 1.598 | B | M | 4 | 16 | K4M804 | | 84039 | NEW |
| | 65 | 06/05 → | 1.598 | B | M | 4 | 16 | K4M804 | | 81806 | |
| | 82 | 02/08 → | 1.598 | B | M | 4 | 16 | K4M800, K4M801 | | 84039 | NEW |
| | 82 | 02/08 → | 1.598 | B | M | 4 | 16 | K4M800, K4M801 | | 81806 | |
| | 94 | 11/08 → | 1.598 | B | M | 4 | 16 | K4M862 | | 84039 | NEW |
| | 94 | 11/08 → | 1.598 | B | M | 4 | 16 | K4M862 | | 81806 | |
| 1.6 16V GT | 94 | 06/09 → | 1.598 | B | M | 4 | 16 | K4M862 | | 84039 | NEW |
| | 94 | 06/09 → | 1.598 | B | M | 4 | 16 | K4M862 | | 81806 | |
| 1.6 Hi-Flex | 86 | 05/05 → 02/10 | 1.598 | | M | 4 | 16 | K4M748 | | 84039 | NEW |
| | 86 | 05/05 → 02/10 | 1.598 | | M | 4 | 16 | K4M748 | | 81806 | |
| 2.0 16V Sport | 145 | 02/06 → | 1.998 | B | M | 4 | 16 | F4R830 | | 81814 | |
| | 145 | 02/06 → | 1.998 | B | M | 4 | 16 | F4R830 | | 84009 | |
| | 148 | 09/08 → | 1.998 | B | M | 4 | 16 | F4R830 | | 81814 | |
| | 148 | 09/08 → | 1.998 | B | M | 4 | 16 | F4R830 | | 84009 | |

Clio IV, Grandtour

| | | | | | | | | | | | |
|-------------|----|---------|-------|---|---|---|----|----------------|--|-------|------------|
| 0.9 TCe 90 | 66 | 01/13 → | 898 | B | M | 3 | 12 | H4B400 | | 84003 | |
| 1.2 16V | 54 | 11/12 → | 1.149 | B | M | 4 | 16 | D4F728, D4F740 | | 81820 | |
| | 54 | 11/12 → | 1.149 | B | M | 4 | 16 | D4F728, D4F740 | | 82090 | |
| | 54 | 11/12 → | 1.149 | B | M | 4 | 16 | D4F728, D4F740 | | 84024 | NEW |
| | 54 | 11/12 → | 1.149 | B | M | 4 | 16 | D4F728, D4F740 | | 81762 | |
| | 54 | 01/13 → | 1.149 | B | M | 4 | 16 | D4F740 | | 81820 | |
| | 54 | 01/13 → | 1.149 | B | M | 4 | 16 | D4F740 | | 82090 | |
| | 54 | 01/13 → | 1.149 | B | M | 4 | 16 | D4F740 | | 84024 | NEW |
| | 54 | 01/13 → | 1.149 | B | M | 4 | 16 | D4F740 | | 81762 | |
| 1.2 TCe 120 | 88 | 03/13 → | 1.197 | B | M | 4 | 16 | H5F403 | | 84003 | |
| 1.5 dCi 75 | 55 | 01/13 → | 1.461 | D | M | 4 | 8 | K9K612 | | 82098 | |
| 1.5 dCi 90 | 66 | 01/13 → | 1.461 | D | M | 4 | 8 | K9K608 | | 82098 | |

Duster

| | | | | | | | | | | | |
|---------|----|---------|-------|---|---|---|----|----------------|--|-------|------------|
| 1.6 16V | 75 | 02/12 → | 1.598 | B | M | 4 | 16 | K4M616 | | 84039 | NEW |
| | 75 | 02/12 → | 1.598 | B | M | 4 | 16 | K4M616 | | 81806 | |
| 2.0 | 98 | 02/12 → | 1.998 | B | M | 4 | 16 | F4R403, F4R405 | | 81814 | |
| | 98 | 02/12 → | 1.998 | B | M | 4 | 16 | F4R403, F4R405 | | 84009 | |

Espace I

| | | | | | | | | | | | |
|--------------|----|---------------|-------|---|---|---|---|------------------------|--|-------|--|
| 2.0 | 74 | 01/88 → 12/90 | 1.995 | B | M | 4 | 8 | J6R734 | | 81576 | |
| | 80 | 07/84 → 12/90 | 1.995 | B | M | 4 | 8 | J6R234, J6R236 | | 81576 | |
| 2.0 i | 87 | 01/89 → 12/90 | 1.995 | B | M | 4 | 8 | J7R760 | | 81576 | |
| 2.0 i Quadra | 87 | 03/88 → 12/92 | 1.995 | B | M | 4 | 8 | J7R760 | | 81576 | |
| 2.1 TD | 65 | 10/84 → 12/90 | 2.068 | D | M | 4 | 8 | J8S240, J8S774, J8S776 | | 81576 | |
| 2.2 | 79 | 07/86 → 12/90 | 2.165 | B | M | 4 | 8 | J7T770 | | 81576 | |
| 2.2 Quadra | 79 | 01/88 → 12/90 | 2.165 | B | M | 4 | 8 | J7T770 | | 81576 | |

| | | | | | | | | | |
|--|--|--|--|--|--|--|--|--|--|
| | | | | | | | | | |
|--|--|--|--|--|--|--|--|--|--|

RENAULT

Espace II

| | | | | | | | | | | |
|-----------------|----|---------------|-------|---|---|---|---|--------------------------------|--|-------|
| 2.0 | 76 | 01/91 → 10/96 | 1.995 | B | M | 4 | 8 | J7R768 | | 81666 |
| 2.1 RTDT Quadra | 65 | 01/91 → 05/92 | 2.068 | D | M | 4 | 8 | J8S772 | | 81667 |
| 2.1 TD | 65 | 01/91 → 10/96 | 2.068 | D | M | 4 | 8 | J8S610, J8S772, J8S776, J8S778 | | 81667 |
| | 66 | 11/94 → 10/96 | 2.068 | D | M | 4 | 8 | J8S612 | | 81667 |
| 2.2 | 79 | 01/91 → 10/96 | 2.165 | B | M | 4 | 8 | J7T772, J7T773, J7T776 | | 81666 |
| 2.2 4x4 | 79 | 03/91 → 12/96 | 2.165 | B | M | 4 | 8 | J7T772, J7T773 | | 81666 |

Espace III

| | | | | | | | | | | |
|------------|-----|---------------|-------|---|---|---|----|--|------------|-------|
| 1.9 dTi | 72 | 02/99 → 10/02 | 1.870 | D | M | 4 | 8 | F9Q722 | | 81574 |
| 2.0 | 102 | 09/01 → 10/02 | 1.998 | B | M | 4 | 16 | F4R700, F4R701 | | 81574 |
| | 84 | 11/96 → 10/00 | 1.998 | B | M | 4 | 8 | F3R728, F3R729, F3R742, F3R768, F3R769 | | 81574 |
| 2.0 16V | 103 | 10/98 → 10/02 | 1.998 | B | M | 4 | 16 | F4R700, F4R701 | | 81574 |
| 2.2 12V TD | 83 | 11/96 → 10/00 | 2.188 | D | M | 4 | 12 | G8T714, G8T716, G8T760 | | 81761 |
| 2.2 D | 84 | 11/97 → 01/00 | 2.188 | D | M | 4 | 12 | G8T716 | | 81761 |
| 2.2 dCi | 85 | 07/00 → 10/02 | 2.188 | D | M | 4 | 16 | G9T710 | | 81855 |
| | 95 | 10/00 → 10/02 | 2.188 | D | M | 4 | 16 | G9T642, G9T710 | | 81855 |
| 3.0 V6 24V | 140 | 10/98 → 10/02 | 2.946 | B | M | 6 | 24 | L7X727 | → T: 08441 | 81844 |
| | 140 | 10/98 → 10/02 | 2.946 | B | M | 6 | 24 | L7X727 | T →: 08442 | 82042 |

Espace IV

| | | | | | | | | | | |
|---------|-----|---------------|-------|---|---|---|----|--|--|-------|
| 1.9 dCi | 85 | 04/03 → 02/05 | 1.870 | D | M | 4 | 8 | F9Q820 | | 81814 |
| | 85 | 04/03 → 02/05 | 1.870 | D | M | 4 | 8 | F9Q820 | | 84009 |
| | 88 | 11/02 → | 1.870 | D | M | 4 | 8 | F9Q680, F9Q820, F9Q826 | | 81814 |
| | 88 | 11/02 → | 1.870 | D | M | 4 | 8 | F9Q680, F9Q820, F9Q826 | | 84009 |
| 2.0 | 98 | 11/02 → 02/05 | 1.998 | B | M | 4 | 16 | F4R790 | | 81814 |
| | 98 | 11/02 → 02/05 | 1.998 | B | M | 4 | 16 | F4R790 | | 84009 |
| | 100 | 11/02 → | 1.998 | B | M | 4 | 16 | F4R792 | | 81814 |
| | 100 | 11/02 → | 1.998 | B | M | 4 | 16 | F4R792 | | 84009 |
| | 125 | 04/05 → | 1.998 | B | M | 4 | 16 | F4R796, F4R797, F4R896, F4R897 | | 81814 |
| | 125 | 04/05 → | 1.998 | B | M | 4 | 16 | F4R796, F4R797, F4R896, F4R897 | | 84009 |
| 2.0 dCi | 96 | 01/06 → | 1.995 | D | M | 4 | 16 | M9R740, M9R750, M9R760, M9R761, M9R762, M9R763 | | 82069 |
| | 110 | 01/06 → | 1.995 | D | M | 4 | 16 | M9R740, M9R750, M9R815 | | 82069 |
| | 127 | 01/06 → | 1.995 | D | M | 4 | 16 | M9R760, M9R761, M9R762, M9R763, M9R815 | | 82069 |

KW

cm³

NO. OF VALVES

RENAULT
Espace IV

| | | | | | | | | | | |
|-----------|-----|---------|-------|---|----|---|----|--------------------------------|--|-------|
| 2.0 Turbo | 120 | 11/02 → | 1.998 | B | AM | 4 | 16 | F4R794, F4R795, F4R796, F4R797 | | 81814 |
| | 120 | 11/02 → | 1.998 | B | AM | 4 | 16 | F4R794, F4R795, F4R796, F4R797 | | 84009 |
| 2.2 dCi | 102 | 02/06 → | 2.188 | D | M | 4 | 16 | G9T645 | | 81855 |
| | 110 | 11/02 → | 2.188 | D | M | 4 | 16 | G9T742, G9T743 | | 81855 |

Espace V

| | | | | | | | | | | | |
|-------------|-----|---------|-------|---|---|---|----|--------|--|-------|------------|
| 1.6 dCi 130 | 96 | 06/15 → | 1.598 | D | M | 4 | 16 | R9M409 | | 84034 | NEW |
| 1.6 dCi 160 | 118 | 06/15 → | 1.598 | D | M | 4 | 16 | R9M452 | | 84034 | NEW |

Fluence

| | | | | | | | | | | | |
|---------|----|---------|-------|---|---|---|----|----------------|--|-------|------------|
| 1.5 dCi | 63 | 02/10 → | 1.461 | D | M | 4 | 8 | K9K830 | | 84007 | |
| | 66 | 02/10 → | 1.461 | D | M | 4 | 8 | K9K834 | | 82098 | |
| | 78 | 02/10 → | 1.461 | D | M | 4 | 8 | K9K832 | | 84007 | |
| | 81 | 02/10 → | 1.461 | D | M | 4 | 8 | K9K836, K9K837 | | 82098 | |
| 1.6 16V | 82 | 02/10 → | 1.598 | B | M | 4 | 16 | K4M838 | | 84039 | NEW |
| | 82 | 02/10 → | 1.598 | B | M | 4 | 16 | K4M838 | | 81806 | |
| | 81 | 02/10 → | 1.598 | B | M | 4 | 16 | K4M838, K4M839 | | 84039 | NEW |
| | 81 | 02/10 → | 1.598 | B | M | 4 | 16 | K4M838, K4M839 | | 81806 | |

Grand Scénic II

| | | | | | | | | | | | |
|---------|---------|---------------|-------|---|---|---|-----------------------------------|-----------------------------------|-------|-------|------------|
| 1.5 dCi | 74 | 04/04 → | 1.461 | D | M | 4 | 8 | K9K728 | | 81810 | |
| | 78 | 05/05 → | 1.461 | D | M | 4 | 8 | K9KP732 | | 81810 | |
| 1.6 | 77 | 06/06 → | 1.598 | B | M | 4 | 16 | K4M788 | | 84039 | NEW |
| | 77 | 06/06 → | 1.598 | B | M | 4 | 16 | K4M788 | | 81806 | |
| | 82 | 06/06 → 11/08 | 1.598 | B | M | 4 | 16 | K4M812 | | 84039 | NEW |
| | 82 | 06/06 → 11/08 | 1.598 | B | M | 4 | 16 | K4M812 | | 81806 | |
| | 83 | 04/04 → | 1.598 | B | M | 4 | 16 | K4M761, K4M782 | | 84039 | NEW |
| | 83 | 04/04 → | 1.598 | B | M | 4 | 16 | K4M761, K4M782 | | 81806 | |
| 1.9 dCi | 85 | 05/05 → 01/09 | 1.870 | D | M | 4 | 8 | F9Q803, F9Q804, F9Q812 | | 81868 | |
| | 85 | 05/05 → 01/09 | 1.870 | D | M | 4 | 8 | F9Q803, F9Q804, F9Q812 | | 84006 | |
| | 81 | 05/05 → | 1.870 | D | M | 4 | 8 | F9QE804 | | 81868 | |
| | 81 | 05/05 → | 1.870 | D | M | 4 | 8 | F9QE804 | | 84006 | |
| | 88 | 04/04 → | 1.870 | D | M | 4 | 8 | F9Q812 | | 81868 | |
| | 88 | 04/04 → | 1.870 | D | M | 4 | 8 | F9Q812 | | 84006 | |
| | 96 | 05/05 → | 1.870 | D | M | 4 | 8 | F9Q816, F9Q818, F9QEE804, F9QJ803 | | 81868 | |
| 96 | 05/05 → | 1.870 | D | M | 4 | 8 | F9Q816, F9Q818, F9QEE804, F9QJ803 | | 84006 | | |
| 2.0 | 99 | 04/04 → | 1.998 | B | M | 4 | 16 | F4R770, F4R771 | | 81814 | |
| | 99 | 04/04 → | 1.998 | B | M | 4 | 16 | F4R770, F4R771 | | 84009 | |
| | 120 | 04/04 → | 1.998 | B | M | 4 | 16 | F4R776 | | 81814 | |
| | 120 | 04/04 → | 1.998 | B | M | 4 | 16 | F4R776 | | 84009 | |

| | | | | | | | | | |
|--|--|--|--|--|--|--|--|--|--|
| | | | | | | | | | |
|--|--|--|--|--|--|--|--|--|--|

RENAULT

Grand Scénic II

| | | | | | | | | | | |
|---------|-----|---------|-------|---|---|---|----|------------------------|--|-------|
| 2.0 dCi | 110 | 09/05 → | 1.995 | D | M | 4 | 16 | M9R700, M9R721, M9R722 | | 82069 |
|---------|-----|---------|-------|---|---|---|----|------------------------|--|-------|

Grand Scénic III

| | | | | | | | | | | |
|----------------|-----|---------|-------|----|---|---|----|------------------------|--|------------------|
| 1.2 TCe | 97 | 01/13 → | 1.197 | B | M | 4 | 16 | H5F404 | | 84003 |
| 1.4 16V | 96 | 02/09 → | 1.397 | B | M | 4 | 16 | H4J700 | | 84003 |
| 1.5 dCi | 63 | 04/09 → | 1.461 | D | M | 4 | 8 | K9K830 | | 84007 |
| | 70 | 11/10 → | 1.461 | D | M | 4 | 8 | K9K846 | | 82098 |
| | 78 | 02/09 → | 1.461 | D | M | 4 | 8 | K9K832 | | 84007 |
| | 81 | 04/09 → | 1.461 | D | M | 4 | 8 | K9K636, K9K836, K9K837 | | 82098 |
| 1.6 16V | 81 | 02/09 → | 1.598 | B | M | 4 | 16 | K4M858 | | 84039 NEW |
| | 81 | 02/09 → | 1.598 | B | M | 4 | 16 | K4M858 | | 81806 |
| 1.6 16V Bifuel | 81 | 02/09 → | 1.598 | BF | M | 4 | 16 | K4M866 | | 84039 NEW |
| | 81 | 02/09 → | 1.598 | BF | M | 4 | 16 | K4M866 | | 81806 |
| 1.6 dCi | 96 | 04/11 → | 1.598 | D | M | 4 | 16 | R9M402, R9M404 | | 84034 NEW |
| 1.9 dCi | 96 | 02/09 → | 1.870 | D | M | 4 | 8 | F9Q870, F9Q872 | | 82099 |
| 2.0 dCi | 110 | 02/09 → | 1.995 | D | M | 4 | 16 | M9R615 | | 82069 |
| | 118 | 04/09 → | 1.995 | D | M | 4 | 16 | M9R610 | | 82069 |

Kadjar

| | | | | | | | | | | |
|-----------------|----|---------|-------|---|---|---|----|----------------|--|------------------|
| 1.2 TCe 130 | 96 | 06/15 → | 1.197 | B | M | 4 | 16 | H5F408 | | 84003 |
| 1.5 dCi 110 | 81 | 06/15 → | 1.461 | D | M | 4 | 8 | K9K646, K9K647 | | 82098 |
| 1.6 dCi 130 | 96 | 06/15 → | 1.598 | D | M | 4 | 16 | R9M414 | | 84034 NEW |
| 1.6 dCi 130 4x4 | 96 | 06/15 → | 1.598 | D | M | 4 | 16 | R9M414 | | 84034 NEW |

Kangoo I, Van

| | | | | | | | | | | |
|------------|----|---------------|-------|----|---|---|----|--|--|-------|
| 1.2 | 43 | 08/97 → | 1.149 | B | M | 4 | 8 | D7F710, D7F720, D7F722, D7F726, D7F744, D7F746 | | 81762 |
| | 44 | 07/98 → 07/01 | 1.149 | B | M | 4 | 8 | D7F764, D7F766 | | 81762 |
| 1.2 16V | 55 | 06/01 → | 1.149 | B | M | 4 | 16 | D4F712, D4F714, D4F716, D4F730 | | 81820 |
| | 55 | 10/01 → | 1.149 | B | M | 4 | 16 | D4F712, D4F714, D4F730 | | 81820 |
| 1.2 BiFuel | 43 | 07/98 → 07/01 | 1.149 | BF | M | 4 | 8 | D7F710, D7F744 | | 82091 |
| | 43 | 07/98 → 07/01 | 1.149 | BF | M | 4 | 8 | D7F710, D7F744 | | 81762 |
| 1.4 | 55 | 08/97 → | 1.390 | B | M | 4 | 8 | E7J634, E7J635, E7J780, K7J700, K7J701 | M: E7J 634, M: E7J 780, M: E7J 635, M: E7J 634 | 81578 |
| | 55 | 08/97 → | 1.390 | B | M | 4 | 8 | E7J634, E7J635, E7J780, K7J700, K7J701 | M: K7J 701, M: K7J 700 | 81579 |
| | 55 | 08/97 → | 1.390 | B | M | 4 | 8 | E7J634, E7J635, E7J780, K7J701 | M: E7J 634, M: E7J 780, M: E7J 635, M: E7J 634 | 81578 |
| | 55 | 08/97 → | 1.390 | B | M | 4 | 8 | E7J634, E7J635, E7J780, K7J701 | M: K7J 701, M: K7J 700 | 81579 |

KW

cm³

NO. OF VALVES

RENAULT
Kangoo I, Van

| | | | | | | | | | | |
|------------------|-----|---------------|---------------|-------|---|---|----|--------------------------------|-----------|------------------|
| 1.5 dCi | 42 | 07/03 → | 1.461 | D | M | 4 | 8 | K9K704 | → 03-2004 | 81810 |
| | 42 | 07/03 → | 1.461 | D | M | 4 | 8 | K9K704 | 04-2004 → | 84007 |
| | 45 | 04/05 → 06/10 | 1.461 | D | M | 4 | 8 | K9K700, K9K702 | | 81810 |
| | 45 | 04/05 → 06/10 | 1.461 | D | M | 4 | 8 | K9K700, K9K702 | | 84007 |
| | 45 | 10/05 → | 1.461 | D | M | 4 | 8 | K9K716 | | 81810 |
| | 50 | 06/05 → | 1.461 | D | M | 4 | 8 | K9K714 | | 81810 |
| | 62 | 06/05 → | 1.461 | D | M | 4 | 8 | K9K718 | | 84007 |
| | 42 | 12/02 → | 1.461 | D | M | 4 | 8 | K9K704 | → 03-2004 | 81810 |
| | 42 | 12/02 → | 1.461 | D | M | 4 | 8 | K9K704 | 04-2004 → | 84007 |
| | 48 | 12/01 → | 1.461 | D | M | 4 | 8 | K9K700, K9K702, K9K704 | → 03-2004 | 81810 |
| | 48 | 12/01 → | 1.461 | D | M | 4 | 8 | K9K700, K9K702, K9K704 | 04-2004 → | 84007 |
| | 48 | 12/01 → | 1.461 | D | M | 4 | 8 | K9K700, K9K704 | → 03-2004 | 81810 |
| | 48 | 12/01 → | 1.461 | D | M | 4 | 8 | K9K700, K9K704 | 04-2004 → | 84007 |
| | 50 | 06/05 → | 1.461 | D | M | 4 | 8 | K9K714 | | 81810 |
| | 60 | 07/02 → | 1.461 | D | M | 4 | 8 | K9K702, K9K710 | → 03-2004 | 81810 |
| | 60 | 07/02 → | 1.461 | D | M | 4 | 8 | K9K702, K9K710 | 04-2004 → | 84007 |
| | 62 | 06/05 → | 1.461 | D | M | 4 | 8 | K9K718 | | 81810 |
| | 1.6 | 66 | 09/99 → 06/01 | 1.598 | B | M | 4 | 8 | K7M746 | |
| 1.6 16V | 70 | 06/01 → | 1.598 | B | M | 4 | 16 | K4M706, K4M750, K4M752, K4M753 | | 84039 NEW |
| | 70 | 06/01 → | 1.598 | B | M | 4 | 16 | K4M706, K4M750, K4M752, K4M753 | | 81806 |
| | 70 | 10/01 → | 1.598 | B | M | 4 | 16 | K4M706, K4M752 | | 84039 NEW |
| | 70 | 10/01 → | 1.598 | B | M | 4 | 16 | K4M706, K4M752 | | 81806 |
| 1.6 16V 4x4 | 70 | 10/01 → | 1.598 | B | M | 4 | 16 | K4M750, K4M752, K4M753 | | 84039 NEW |
| | 70 | 10/01 → | 1.598 | B | M | 4 | 16 | K4M750, K4M752, K4M753 | | 81806 |
| 1.6 16V bivalent | 60 | 06/05 → | 1.598 | | M | 4 | 16 | K4M850 | | 84039 NEW |
| | 60 | 06/05 → | 1.598 | | M | 4 | 16 | K4M850 | | 81806 |
| 1.9 D | 48 | 09/99 → 06/03 | 1.870 | D | M | 4 | 8 | F8Q632 | | 81574 |
| 1.9 dCi | 62 | 07/03 → | 1.870 | D | M | 4 | 8 | F9Q782, F9Q790 | | 81574 |
| 1.9 dCi 4x4 | 62 | 10/03 → | 1.870 | D | M | 4 | 8 | F9Q790 | | 81574 |
| | 59 | 10/01 → | 1.870 | D | M | 4 | 8 | F9Q782, F9Q790 | | 81574 |
| | 62 | 07/03 → | 1.870 | D | M | 4 | 8 | F9Q790 | | 81574 |
| 1.9 dTi | 59 | 02/00 → | 1.870 | D | M | 4 | 8 | F9Q780 | | 81574 |
| | 59 | 02/00 → | 1.870 | D | M | 4 | 8 | F9Q780, F9Q782 | | 81574 |
| 1.9 RXED | 48 | 09/99 → 06/01 | 1.870 | D | M | 4 | 8 | F8Q630, F8Q632 | | 81574 |
| D 55 1.9 | 40 | 08/97 → | 1.870 | D | M | 4 | 8 | F8Q662 | | 81574 |
| D 65 1.9 | 47 | 08/97 → | 1.870 | D | M | 4 | 8 | F8Q630, F8Q632 | | 81574 |

KW

cm³

NO. OF VALVES

RENAULT
Kangoo II, Be Bop, Van

| | | | | | | | | | | |
|-----------------|----|---------|-------|---|---|---|----|------------------------|--|------------------|
| 1.2 TCe 115 | 84 | 07/13 → | 1.197 | B | M | 4 | 16 | H5F400 | | 84003 |
| 1.5 dCi | 50 | 02/08 → | 1.461 | D | M | 4 | 8 | K9K800 | | 84007 |
| | 66 | 11/12 → | 1.461 | D | M | 4 | 8 | K9K808 | | 82098 |
| | 80 | 06/09 → | 1.461 | D | M | 4 | 8 | K9K804 | | 82098 |
| | 50 | 02/08 → | 1.461 | D | M | 4 | 8 | K9K714, K9K800, K9K840 | | 84007 |
| | 63 | 02/08 → | 1.461 | D | M | 4 | 8 | K9K802 | | 84007 |
| | 66 | 06/09 → | 1.461 | D | M | 4 | 8 | K9K808 | | 82098 |
| | 76 | 02/08 → | 1.461 | D | M | 4 | 8 | K9K804, K9K806 | | 84007 |
| | 76 | 02/09 → | 1.461 | D | M | 4 | 8 | K9K806 | | 84007 |
| 1.5 dCi 110 | 80 | 09/10 → | 1.461 | D | M | 4 | 8 | K9K804 | | 84007 |
| | 80 | 09/10 → | 1.461 | D | M | 4 | 8 | K9K804 | | 82098 |
| | 81 | 03/13 → | 1.461 | D | M | 4 | 8 | K9K636 | | 82098 |
| 1.5 dCi 75 | 55 | 09/10 → | 1.461 | D | M | 4 | 8 | K9K608, K9K808 | | 82098 |
| | 55 | 09/10 → | 1.461 | D | M | 4 | 8 | K9K802 | | 82098 |
| 1.5 dCi 85 | 63 | 02/08 → | 1.461 | D | M | 4 | 8 | K9K800, K9K802 | | 84007 |
| 1.5 dCi 90 | 66 | 06/09 → | 1.461 | D | M | 4 | 8 | K9K608, K9K808 | | 82098 |
| 1.6 | 64 | 02/08 → | 1.598 | B | M | 4 | 8 | K7M750 | | 81579 |
| | 64 | 02/08 → | 1.598 | B | M | 4 | 8 | K7M750 | | 81579 |
| | 78 | 02/09 → | 1.598 | B | M | 4 | 16 | K4M830 | | 84039 NEW |
| | 78 | 02/09 → | 1.598 | B | M | 4 | 16 | K4M830 | | 81806 |
| 1.6 16V | 78 | 02/08 → | 1.598 | B | M | 4 | 16 | K4M830 | | 84039 NEW |
| | 78 | 02/08 → | 1.598 | B | M | 4 | 16 | K4M830 | | 81806 |
| | 78 | 02/08 → | 1.598 | B | M | 4 | 16 | K4M830, K4M831 | | 84039 NEW |
| | 78 | 02/08 → | 1.598 | B | M | 4 | 16 | K4M830, K4M831 | | 81806 |
| 1.6 16V Hi-Flex | 78 | 02/08 → | 1.598 | | M | 4 | 16 | K4M834, K4M850 | | 84039 NEW |
| | 78 | 02/08 → | 1.598 | | M | 4 | 16 | K4M834, K4M850 | | 81806 |
| 1.6 16V LPG | 72 | 02/08 → | 1.598 | | M | 4 | 16 | K4M834 | | 84039 NEW |
| | 72 | 02/08 → | 1.598 | | M | 4 | 16 | K4M834 | | 81806 |

Koleos

| | | | | | | | | | | |
|-------------|-----|---------|-------|---|---|---|----|--|--|------------------|
| 2.0 dCi | 110 | 09/08 → | 1.995 | D | M | 4 | 16 | M9R855, M9R856, M9R862, M9R865, M9R866 | | 82069 |
| | 130 | 09/08 → | 1.995 | D | M | 4 | 16 | M9R830 | | 82069 |
| 2.0 dCi 4x4 | 110 | 09/08 → | 1.995 | D | M | 4 | 16 | M9R832, M9R855, M9R856, M9R862, M9R865, M9R866 | | 82069 |
| | 127 | 09/08 → | 1.995 | D | M | 4 | 16 | M9R830 | | 82069 |
| 2.5 | 126 | 09/08 → | 2.488 | B | M | 4 | 16 | 2TR700, 2TR702, 2TR703 | | 84061 NEW |
| 2.5 4x4 | 126 | 09/08 → | 2.488 | B | M | 4 | 16 | 2TR700, 2TR702, 2TR703 | | 84061 NEW |

KW

cm³

NO. OF VALVES

RENAULT
Laguna I, Grantour

| | | | | | | | | | | | |
|---------|-----|---------------|-------|---|---|---|----|--------------------------------|------------|-------|------------|
| 1.6 16V | 79 | 11/97 → 03/01 | 1.598 | B | M | 4 | 16 | K4M720, K4M724 | | 84039 | NEW |
| | 79 | 11/97 → 03/01 | 1.598 | B | M | 4 | 16 | K4M720, K4M724 | | 81806 | |
| 1.8 | 69 | 06/95 → 02/01 | 1.783 | B | M | 4 | 8 | F3P674 | | 81574 | |
| | 70 | 06/95 → 06/98 | 1.794 | B | M | 4 | 8 | F3P676 | | 81574 | |
| | 66 | 08/95 → 03/01 | 1.783 | B | M | 4 | 8 | F3P670, F3P678 | | 81574 | |
| | 66 | 11/93 → 03/01 | 1.794 | B | M | 4 | 8 | F3P720, F3P724 | | 81574 | |
| | 69 | 08/95 → 03/01 | 1.794 | B | M | 4 | 8 | F3P720, F3P724 | | 81574 | |
| 1.8 16V | 88 | 04/98 → 03/01 | 1.783 | B | M | 4 | 16 | F4P760 | | 81574 | |
| | 88 | 04/98 → 03/01 | 1.783 | B | M | 4 | 16 | F4P760, F4P770 | | 81574 | |
| 1.9 dCi | 79 | 09/99 → 03/01 | 1.870 | D | M | 4 | 8 | F9Q718 | | 81814 | |
| | 79 | 09/99 → 03/01 | 1.870 | D | M | 4 | 8 | F9Q718 | | 84009 | |
| 1.9 dTi | 72 | 10/97 → 03/01 | 1.870 | D | M | 4 | 8 | F9Q710, F9Q716, F9Q717 | | 81574 | |
| 2.0 | 103 | 06/95 → 02/01 | 1.948 | B | M | 4 | 16 | N7Q700, N7Q704 | | 82056 | |
| | 70 | 11/93 → 03/01 | 1.994 | B | M | 4 | 8 | | | 81574 | |
| | 80 | 03/99 → 03/01 | 1.998 | B | A | 4 | 8 | F3R611 | | 81574 | |
| | 84 | 06/95 → 02/01 | 1.998 | B | M | 4 | 8 | F3R722, F3R768 | | 81574 | |
| | 84 | 10/98 → 01/01 | 1.998 | B | M | 4 | 8 | F3R728, F3R768 | | 81574 | |
| | 83 | 11/93 → 03/01 | 1.998 | B | M | 4 | 8 | F3R722, F3R723 | | 81574 | |
| 2.0 16V | 102 | 09/99 → 02/01 | 1.998 | B | M | 4 | 16 | F4R780 | | 81574 | |
| | 102 | 06/95 → 03/01 | 1.948 | B | M | 4 | 16 | N7Q700, N7Q704 | | 82056 | |
| | 103 | 09/99 → 03/01 | 1.998 | B | M | 4 | 16 | F4R780 | | 81814 | |
| | 103 | 09/99 → 03/01 | 1.998 | B | M | 4 | 16 | F4R780 | | 84009 | |
| 2.2 D | 61 | 11/93 → 03/01 | 2.188 | D | M | 4 | 12 | G8T706, G8T752, G8T790, G8T794 | | 81760 | |
| 2.2 dT | 83 | 03/96 → 03/01 | 2.188 | D | M | 4 | 12 | G8T760 | | 81761 | |
| 3.0 24V | 140 | 03/97 → 03/01 | 2.946 | B | M | 6 | 24 | L7X700, L7X701 | → T: 08441 | 81844 | |
| | 140 | 03/97 → 03/01 | 2.946 | B | M | 6 | 24 | L7X700, L7X701 | T →: 08442 | 82042 | |

Laguna II, Grantour

| | | | | | | | | | | | |
|--------------|----|---------------|-------|---|---|---|----|----------------|--|-------|------------|
| 1.6 16V | 82 | 02/05 → | 1.598 | B | M | 4 | 16 | K4M716 | | 84039 | NEW |
| | 82 | 02/05 → | 1.598 | B | M | 4 | 16 | K4M716 | | 81806 | |
| | 79 | 03/01 → | 1.598 | B | M | 4 | 16 | K4M710, K4M714 | | 84039 | NEW |
| | 79 | 03/01 → | 1.598 | B | M | 4 | 16 | K4M710, K4M714 | | 81806 | |
| | 82 | 02/05 → | 1.598 | B | M | 4 | 16 | K4M716 | | 84039 | NEW |
| | 82 | 02/05 → | 1.598 | B | M | 4 | 16 | K4M716 | | 81806 | |
| 1.6 FlexFuel | 76 | 06/01 → 10/03 | 1.598 | | M | 4 | 16 | K4M718 | | 84039 | NEW |
| | 76 | 06/01 → 10/03 | 1.598 | | M | 4 | 16 | K4M718 | | 81806 | |



KW



cm³



NO. OF VALVES



RENAULT

Laguna II, Grantour

| | | | | | | | | | | |
|---------|----|---------|-------|---|----|---|----|--|------------|-------|
| 1.8 16V | 86 | 03/01 → | 1.783 | B | M | 4 | 16 | F4P770 | | 81814 |
| | 86 | 03/01 → | 1.783 | B | M | 4 | 16 | F4P770 | | 84009 |
| | 89 | 03/01 → | 1.783 | B | M | 4 | 16 | F4P770, F4P774 | | 81814 |
| | 89 | 03/01 → | 1.783 | B | M | 4 | 16 | F4P770, F4P774 | | 84009 |
| | 85 | 03/01 → | 1.783 | B | A | 4 | 16 | F4P770, F4P771, F4P773, F4P774, F4P775 | M: F4P 775 | 81806 |
| | 85 | 03/01 → | 1.783 | B | A | 4 | 16 | F4P770, F4P771, F4P773, F4P774, F4P775 | | 81814 |
| | 85 | 03/01 → | 1.783 | B | A | 4 | 16 | F4P770, F4P771, F4P773, F4P774, F4P775 | | 84009 |
| | 85 | 03/01 → | 1.783 | B | A | 4 | 16 | F4P770, F4P771, F4P773, F4P774, F4P775 | | 84039 |
| | 85 | 03/01 → | 1.783 | B | A | 4 | 16 | F4P770, F4P771, F4P774, F4P775 | | 81814 |
| | 85 | 03/01 → | 1.783 | B | A | 4 | 16 | F4P770, F4P771, F4P774, F4P775 | | 84009 |
| | 86 | 03/01 → | 1.783 | B | M | 4 | 16 | F4P770, F4P774 | | 81814 |
| | 86 | 03/01 → | 1.783 | B | M | 4 | 16 | F4P770, F4P774 | | 84009 |
| | 88 | 03/01 → | 1.783 | B | M | 4 | 16 | F4P770, F4P773 | | 81814 |
| | 88 | 03/01 → | 1.783 | B | M | 4 | 16 | F4P770, F4P773 | | 84009 |
| | 89 | 03/01 → | 1.783 | B | AM | 4 | 16 | F4P770, F4P772 | | 81814 |
| | 89 | 03/01 → | 1.783 | B | AM | 4 | 16 | F4P770, F4P772 | | 84009 |

KW

cm³

NO. OF VALVES

RENAULT
Laguna II, Grantour

| | | | | | | | | | | |
|-------------|---------|---------------|---------|-------|----|---|----|--------------------------------|--------------------------------|-------|
| 1.9 dCi | 79 | 03/01 → | 1.870 | D | M | 4 | 8 | F9Q718, F9Q754 | 81814 | |
| | 79 | 03/01 → | 1.870 | D | M | 4 | 8 | F9Q718, F9Q754 | 84009 | |
| | 85 | 09/05 → | 1.870 | D | M | 4 | 8 | F9Q750 | 81814 | |
| | 85 | 09/05 → | 1.870 | D | M | 4 | 8 | F9Q750 | 84009 | |
| | 92 | 09/05 → | 1.870 | D | M | 4 | 8 | F9Q750 | 81814 | |
| | 92 | 09/05 → | 1.870 | D | M | 4 | 8 | F9Q750 | 84009 | |
| | 68 | 03/04 → | 1.870 | D | M | 4 | 8 | F9Q664 | 81868 | |
| | 68 | 03/04 → | 1.870 | D | M | 4 | 8 | F9Q664 | 84006 | |
| | 74 | 10/01 → | 1.870 | D | M | 4 | 8 | F9Q752 | 81814 | |
| | 74 | 10/01 → | 1.870 | D | M | 4 | 8 | F9Q752 | 84009 | |
| | 74 | 10/01 → | 1.870 | D | M | 4 | 8 | F9Q754 | 81814 | |
| | 74 | 10/01 → | 1.870 | D | M | 4 | 8 | F9Q754 | 84009 | |
| | 77 | 06/01 → | 1.870 | D | AM | 4 | 8 | F9Q752 | 81814 | |
| | 77 | 06/01 → | 1.870 | D | AM | 4 | 8 | F9Q752 | 84009 | |
| | 81 | 01/05 → | 1.870 | D | M | 4 | 8 | F9Q674, F9Q758 | 81868 | |
| | 81 | 01/05 → | 1.870 | D | M | 4 | 8 | F9Q674, F9Q758 | 84006 | |
| | 85 | 08/05 → 09/07 | 1.870 | D | M | 4 | 8 | F9Q758, F9Q759 | 81814 | |
| | 85 | 08/05 → 09/07 | 1.870 | D | M | 4 | 8 | F9Q758, F9Q759 | 84009 | |
| | 2.0 16V | 88 | 03/01 → | 1.870 | D | M | 4 | 8 | F9Q650, F9Q670, F9Q674, F9Q750 | 81814 |
| | | 88 | 03/01 → | 1.870 | D | M | 4 | 8 | F9Q650, F9Q670, F9Q674, F9Q750 | 84009 |
| 88 | | 03/01 → | 1.870 | D | M | 4 | 8 | F9Q670, F9Q674, F9Q750 | 81814 | |
| 88 | | 03/01 → | 1.870 | D | M | 4 | 8 | F9Q670, F9Q674, F9Q750 | 84009 | |
| 96 | | 05/05 → | 1.870 | D | M | 4 | 8 | F9Q758, F9Q759 | 81868 | |
| 96 | | 05/05 → | 1.870 | D | M | 4 | 8 | F9Q758, F9Q759 | 84006 | |
| 98 | | 08/02 → | 1.998 | B | M | 4 | 16 | F4R714 | 81814 | |
| 98 | | 08/02 → | 1.998 | B | M | 4 | 16 | F4R714 | 84009 | |
| 98 | | 10/04 → 09/07 | 1.998 | B | M | 4 | 16 | F4R714, F4R715 | 81814 | |
| 98 | | 10/04 → 09/07 | 1.998 | B | M | 4 | 16 | F4R714, F4R715 | 84009 | |
| 2.0 16V IDE | 125 | 01/05 → | 1.998 | B | M | 4 | 16 | F4R784, F4R786, F4R787 | 81814 | |
| | 125 | 01/05 → | 1.998 | B | M | 4 | 16 | F4R784, F4R786, F4R787 | 84009 | |
| | 150 | 01/05 → | 1.998 | B | M | 4 | 16 | F4R886, F4R887 | 81814 | |
| | 150 | 01/05 → | 1.998 | B | M | 4 | 16 | F4R886, F4R887 | 84009 | |
| | 99 | 08/02 → | 1.998 | B | M | 4 | 16 | F4R712, F4R713, F4R714, F4R715 | 81814 | |
| | 99 | 08/02 → | 1.998 | B | M | 4 | 16 | F4R712, F4R713, F4R714, F4R715 | 84009 | |

KW

cm³

NO. OF VALVES

RENAULT
Laguna II, Grantour

| | | | | | | | | | | |
|---------------|-----|---------------|-------|---|----|---|----|--------------------------------|--|-------|
| 2.0 16V Turbo | 120 | 01/03 → | 1.998 | B | M | 4 | 16 | F4R764, F4R765, F4R786, F4R787 | | 81814 |
| | 120 | 01/03 → | 1.998 | B | M | 4 | 16 | F4R764, F4R765, F4R786, F4R787 | | 84009 |
| 2.0 dCi | 110 | 08/05 → | 1.995 | D | M | 4 | 16 | M9R740 | | 82069 |
| | 127 | 01/06 → | 1.995 | D | M | 4 | 16 | M9R760 | | 82069 |
| 2.2 dCi | 102 | 05/05 → | 2.188 | D | M | 4 | 16 | G9T600, G9T605, G9T706, G9T707 | | 81855 |
| | 102 | 05/05 → | 2.188 | D | M | 4 | 16 | G9T600, G9T706, G9T707 | | 81855 |
| | 85 | 04/04 → 10/05 | 2.188 | D | M | 4 | 16 | G9T600 | | 81855 |
| | 110 | 10/01 → | 2.188 | D | AM | 4 | 16 | G9T700, G9T702 | | 81855 |
| | 110 | 10/01 → | 2.188 | D | AM | 4 | 16 | G9T702 | | 81855 |
| 3.0 V6 24V | 152 | 03/01 → | 2.946 | B | A | 6 | 24 | L7X731 | | 81813 |
| | 152 | 03/01 → | 2.946 | B | M | 6 | 24 | L7X731 | | 81813 |

Laguna III, Grantour, Coupé

| | | | | | | | | | | |
|---------------|-----|---------|-------|---|---|---|----|-----------------|--|------------------|
| 1.5 dCi | 81 | 03/12 → | 1.461 | D | M | 4 | 8 | K9K846 | | 82098 |
| | 81 | 10/07 → | 1.461 | D | M | 4 | 8 | K9K780 | | 84007 |
| 1.6 16V | 81 | 10/07 → | 1.598 | B | M | 4 | 16 | K4M824 | | 84039 NEW |
| | 81 | 10/07 → | 1.598 | B | M | 4 | 16 | K4M824 | | 81806 |
| 2.0 16V Turbo | 125 | 10/07 → | 1.998 | B | M | 4 | 16 | F4R811 | | 81814 |
| | 125 | 10/07 → | 1.998 | B | M | 4 | 16 | F4R811 | | 84009 |
| | 125 | 09/08 → | 1.998 | B | M | 4 | 16 | F4R811, F4Rt811 | | 81814 |
| | 125 | 09/08 → | 1.998 | B | M | 4 | 16 | F4R811, F4Rt811 | | 84009 |

Laguna III, Grantour, Coupé

| | | | | | | | | | | |
|------------|-----|---------|-------|---|---|---|----|------------------------|--|-------|
| 2.0 dCi | 127 | 09/08 → | 1.995 | D | M | 4 | 16 | M9R800, M9R809, M9R815 | | 82069 |
| | 96 | 10/07 → | 1.995 | D | M | 4 | 16 | M9R742, M9R744, M9R802 | | 82069 |
| | 110 | 09/08 → | 1.995 | D | M | 4 | 16 | M9R802, M9R805, M9R814 | | 82069 |
| | 127 | 01/08 → | 1.995 | D | M | 4 | 16 | M9R800, M9R809, M9R815 | | 82069 |
| 2.0 dCi GT | 131 | 03/08 → | 1.995 | D | M | 4 | 16 | M9R816 | | 82069 |
| | 131 | 09/08 → | 1.995 | D | M | 4 | 16 | M9R816, M9R820 | | 82069 |
| 2.0 GT | 150 | 09/08 → | 1.998 | B | M | 4 | 16 | F4R800 | | 81814 |
| | 150 | 09/08 → | 1.998 | B | M | 4 | 16 | F4R800 | | 84009 |
| 3.0 dCi | 177 | 01/12 → | 2.998 | D | M | 6 | 24 | V9X891 | | 82069 |
| | 173 | 09/08 → | 2.998 | D | M | 6 | 24 | V9X791, V9X891 | | 82069 |

Latitude

| | | | | | | | | | | |
|-------------|-----|---------|-------|---|---|---|----|------------------------|--|-------|
| 1.5 dCi | 81 | 07/10 → | 1.461 | D | M | 4 | 8 | K9K782 | | 82098 |
| 2.0 dCi 150 | 110 | 02/11 → | 1.995 | D | M | 4 | 16 | M9R824, M9R846 | | 82069 |
| 2.0 dCi 175 | 127 | 05/11 → | 1.995 | D | M | 4 | 16 | M9R804, M9R817, M9R844 | | 82069 |

KW

cm³

NO. OF VALVES

RENAULT
Latitude

| | | | | | | | | | | |
|-------------|-----|---------|-------|---|---|---|----|--------|--|-------|
| 3.0 dCi 240 | 177 | 02/11 → | 2.998 | D | M | 6 | 24 | V9X891 | | 82069 |
|-------------|-----|---------|-------|---|---|---|----|--------|--|-------|

Logan I, Station Wagon

| | | | | | | | | | | |
|---------|----|---------|-------|---|---|---|----|--------|--|------------------|
| 1.4 | 55 | 09/04 → | 1.390 | B | M | 4 | 8 | K7J710 | | 81579 |
| 1.5 dCi | 50 | 04/07 → | 1.461 | D | M | 4 | 8 | K9K792 | | 84007 |
| 1.6 | 64 | 09/04 → | 1.598 | B | M | 4 | 8 | K7M710 | | 81579 |
| | 77 | 04/07 → | 1.598 | B | M | 4 | 16 | K4M690 | | 84039 NEW |
| | 77 | 04/07 → | 1.598 | B | M | 4 | 16 | K4M690 | | 81806 |

Logan I, Station Wagon, Express

| | | | | | | | | | | |
|---------|----|---------|-------|---|---|---|----|--------|--|------------------|
| 1.4 | 55 | 10/07 → | 1.390 | B | M | 4 | 8 | K7J710 | | 81579 |
| 1.5 dCi | 50 | 04/07 → | 1.461 | D | M | 4 | 8 | K9K792 | | 81810 |
| | 50 | 04/07 → | 1.461 | D | M | 4 | 8 | K9K792 | | 84007 |
| 1.6 | 64 | 04/07 → | 1.598 | B | M | 4 | 8 | K7M710 | | 81579 |
| | 77 | 04/07 → | 1.598 | B | M | 4 | 16 | K4M697 | | 84039 NEW |
| | 77 | 04/07 → | 1.598 | B | M | 4 | 16 | K4M697 | | 81806 |

Master I

| | | | | | | | | | | |
|-------------|----|---------------|-------|---|---|---|---|----------------------|---------------|-------|
| 28-35 2,5 D | 55 | 08/89 → 07/98 | 2.499 | D | M | 4 | 8 | 8140.67.2510, S8U742 | | 81334 |
| 28-35 2.0 | 58 | 10/86 → 07/98 | 1.995 | B | M | 4 | 8 | J5R718 | → M: F029.328 | 81828 |
| | 58 | 10/86 → 07/98 | 1.995 | B | M | 4 | 8 | J5R718 | M →: F029.329 | 81754 |
| | 58 | 10/86 → 07/98 | 1.995 | B | M | 4 | 8 | J5R728 | → M: F029.328 | 81828 |
| | 58 | 10/86 → 07/98 | 1.995 | B | M | 4 | 8 | J5R728 | M →: F029.329 | 81754 |
| 28-35 2.1 D | 44 | 08/80 → 07/98 | 2.068 | D | M | 4 | 8 | J8S330 | | 81576 |
| 28-35 2.5 D | 52 | 09/80 → 07/98 | 2.445 | D | M | 4 | 8 | 8140.61.2300, S8U731 | | 81334 |
| | 55 | 08/89 → 07/98 | 2.499 | D | M | 4 | 8 | 8140.67.2510, S8U742 | | 81334 |
| 30 2,2 | 67 | 08/80 → 07/98 | 2.165 | B | M | 4 | 8 | J7T782, J7T788 | → M: F305.272 | 81828 |
| | 67 | 08/80 → 07/98 | 2.165 | B | M | 4 | 8 | J7T782, J7T788 | M →: F305.273 | 81666 |

Master II

| | | | | | | | | | | |
|-------------|-----|---------------|-------|---|---|---|----|--------------------------------|-----------|-------|
| 1.9 dCi 80 | 60 | 11/01 → | 1.870 | D | M | 4 | 8 | F9Q772, F9Q774 | | 81814 |
| | 60 | 11/01 → | 1.870 | D | M | 4 | 8 | F9Q772, F9Q774 | | 84009 |
| 1.9 dTI | 59 | 09/00 → | 1.870 | D | M | 4 | 8 | F9Q770 | | 81574 |
| 2.2 dCi 90 | 66 | 09/00 → | 2.188 | D | M | 4 | 16 | G9T720, G9T722, G9T750 | | 81855 |
| 2.5 D | 59 | 07/98 → 01/01 | 2.499 | D | M | 4 | 8 | S8U770 | 11-1989 → | 81491 |
| | 59 | 07/98 → 01/01 | 2.499 | D | M | 4 | 8 | S8U770 | | 81834 |
| 2.5 dCi | 74 | 08/06 → | 2.464 | D | M | 4 | 16 | G9U650, G9U754 | | 81855 |
| | 84 | 01/04 → | 2.464 | D | M | 4 | 16 | G9U750 | | 81855 |
| | 88 | 08/06 → | 2.464 | D | M | 4 | 16 | G9U650 | | 81855 |
| | 107 | 08/06 → | 2.464 | D | M | 4 | 16 | G9U632 | | 81855 |
| 2.5 dCi 100 | 73 | 10/03 → | 2.463 | D | M | 4 | 16 | G9U754 | | 81855 |
| 2.5 dCi 120 | 84 | 10/01 → | 2.463 | D | M | 4 | 16 | G9U720, G9U724, G9U750, G9U754 | | 81855 |
| | 84 | 10/01 → | 2.463 | D | M | 4 | 16 | G9U720, G9U750, G9U754 | | 81855 |
| 2.8 dTI | 84 | 07/98 → 10/01 | 2.799 | D | M | 4 | 8 | S9W702 | → 12-1999 | 81834 |
| | 84 | 07/98 → 10/01 | 2.799 | D | M | 4 | 8 | S9W702 | 01-2000 → | 81835 |

KW

cm³

NO. OF VALVES

RENAULT
Master III

| | | | | | | | | | | |
|-----------------|-----|---------|-------|---|---|---|----|--|--|-------|
| 2.3 dCi 100 FWD | 74 | 02/11 → | 2.299 | D | M | 4 | 16 | M9T670, M9T672, M9T676, M9T870 | | 82069 |
| 2.3 dCi 125 FWD | 92 | 02/11 → | 2.299 | D | M | 4 | 16 | M9T670, M9T672, M9T676, M9T870 | | 82069 |
| 2.3 dCi 150 | 110 | 10/12 → | 2.299 | D | M | 4 | 16 | M9T880 | | 82069 |
| 2.3 dCi FWD | 110 | 03/13 → | 2.299 | D | M | 4 | 16 | M9T880, M9T898 | | 82069 |
| | 74 | 02/10 → | 2.298 | D | M | 4 | 16 | M9T670, M9T672, M9T676, M9T870, M9T890 | | 82069 |
| | 92 | 02/10 → | 2.298 | D | M | 4 | 16 | M9T670, M9T672, M9T676, M9T696, M9T698, M9T870, M9T890, M9T896 | | 82069 |
| | 92 | 02/10 → | 2.298 | D | M | 4 | 16 | M9T670, M9T672, M9T676, M9T698, M9T870, M9T890, M9T896 | | 82069 |
| | 107 | 02/10 → | 2.298 | D | M | 4 | 16 | M9T678, M9T680, M9T694, M9T696, M9T698, M9T896 | | 82069 |
| | 107 | 02/10 → | 2.298 | D | M | 4 | 16 | M9T678, M9T680, M9T698, M9T896 | | 82069 |
| | 107 | 02/11 → | 2.299 | D | M | 4 | 16 | M9T680 | | 82069 |

Megane I, Coach, Cabrio, Scénic, Station Wagon

| | | | | | | | | | | |
|---------|----|---------------|-------|---|---|---|----|--------------------------------|--|------------------|
| 1.4 | 55 | 09/96 → 08/03 | 1.390 | B | M | 4 | 8 | E7J626, E7J764 | | 81578 |
| 1.4 16V | 70 | 03/99 → 08/03 | 1.390 | B | M | 4 | 16 | K4J714, K4J750 | | 84039 NEW |
| | 70 | 03/99 → 08/03 | 1.390 | B | M | 4 | 16 | K4J714, K4J750 | | 81806 |
| 1.4 e | 55 | 03/99 → 08/03 | 1.390 | B | M | 4 | 8 | E7J626 | | 81578 |
| | 55 | 01/96 → 08/03 | 1.390 | B | M | 4 | 8 | E7J626, E7J764 | | 81578 |
| 1.4 Eco | 52 | 01/96 → 03/99 | 1.390 | B | M | 4 | 8 | E7J624 | | 81578 |
| 1.4 i | 55 | 01/97 → 09/99 | 1.390 | B | M | 4 | 8 | E7J764 | | 81578 |
| 1.6 16V | 79 | 03/99 → 08/03 | 1.598 | B | M | 4 | 16 | K4M700, K4M701, K4M704, K4M708 | | 84039 NEW |
| | 79 | 03/99 → 08/03 | 1.598 | B | M | 4 | 16 | K4M700, K4M701, K4M704, K4M708 | | 81806 |
| | 79 | 03/99 → 08/03 | 1.598 | B | M | 4 | 16 | K4M700, K4M701, K4M708 | | 84039 NEW |
| | 79 | 03/99 → 08/03 | 1.598 | B | M | 4 | 16 | K4M700, K4M701, K4M708 | | 81806 |
| 1.6 e | 66 | 10/96 → 03/99 | 1.598 | B | M | 4 | 8 | K7M702, K7M703 | | 81579 |
| | 66 | 01/96 → 03/99 | 1.598 | B | M | 4 | 8 | K7M702, K7M703, K7M790 | | 81579 |
| 1.6 i | 55 | 01/96 → 03/99 | 1.598 | B | M | 4 | 8 | K7M720 | | 81579 |
| 1.6 LPG | 80 | 10/00 → 08/02 | 1.598 | | M | 4 | 16 | K4M704 | | 84039 NEW |
| | 80 | 10/00 → 08/02 | 1.598 | | M | 4 | 16 | K4M704 | | 81806 |
| 1.8 16V | 85 | 01/01 → 08/03 | 1.783 | B | M | 4 | 16 | F4P720, F4P722 | | 81574 |

KW

cm³

NO. OF VALVES

RENAULT
Megane I, Coach, Cabrio, Scénic, Station Wagon

| | | | | | | | | | | |
|-------------|-----|---------------|-------|---|---|---|----|--|-----------|-------|
| 1.9 D | 69 | 04/96 → 02/01 | 1.870 | D | M | 4 | 8 | F8Q784 | | 81574 |
| | 47 | 09/96 → 08/03 | 1.870 | D | M | 4 | 8 | F8Q620, F8Q624 | | 81574 |
| | 47 | 04/99 → 08/03 | 1.870 | D | M | 4 | 8 | F8Q622, F8Q790 | | 81574 |
| | 47 | 03/97 → 09/99 | 1.870 | D | M | 4 | 8 | F8Q790 | | 81574 |
| 1.9 D Eco | 47 | 01/96 → 08/03 | 1.870 | D | M | 4 | 8 | F8Q620, F8Q624 | | 81574 |
| 1.9 dCi | 77 | 03/99 → 09/00 | 1.870 | D | M | 4 | 8 | F9Q733 | | 81574 |
| | 75 | 02/01 → 08/03 | 1.870 | D | M | 4 | 8 | F9Q732, F9Q733 | | 81814 |
| | 75 | 02/01 → 08/03 | 1.870 | D | M | 4 | 8 | F9Q732, F9Q733 | | 84009 |
| | 75 | 02/01 → 08/03 | 1.870 | D | M | 4 | 8 | F9Q732, F9Q733, F9Q738 | | 81814 |
| 1.9 dT | 66 | 01/96 → 08/03 | 1.870 | D | M | 4 | 8 | F8Q784, F8Q786 | | 81574 |
| | 60 | 02/00 → 09/00 | 1.870 | D | M | 4 | 8 | F9Q730 | | 81574 |
| 1.9 dTi | 59 | 02/01 → 08/03 | 1.870 | D | M | 4 | 8 | F9Q744 | | 81574 |
| | 72 | 03/97 → 02/01 | 1.870 | D | M | 4 | 8 | F9Q730, F9Q731, F9Q734, F9Q736 | | 81574 |
| | 72 | 04/97 → 09/99 | 1.870 | D | M | 4 | 8 | F9Q730, F9Q734 | | 81574 |
| | 72 | 03/97 → 02/01 | 1.870 | D | M | 4 | 8 | F9Q731, F9Q734, F9Q736 | | 81574 |
| | 72 | 03/99 → 02/01 | 1.870 | D | M | 4 | 8 | F9Q731, F9Q736 | | 81574 |
| 1.9 TDI | 69 | 09/96 → 08/03 | 1.870 | D | M | 4 | 8 | F8Q784 | 10-1996 → | 81574 |
| | 69 | 09/96 → 08/03 | 1.870 | D | M | 4 | 8 | F8Q784 | | 81574 |
| 2.0 | 84 | 04/97 → 08/03 | 1.998 | B | M | 4 | 8 | F3R750, F3R798 | | 81574 |
| 2.0 16V | 102 | 01/02 → 08/03 | 1.998 | B | M | 4 | 16 | F4R746 | | 81574 |
| | 102 | 01/02 → 08/03 | 1.998 | B | M | 4 | 16 | F4R746, F4R770 | | 81574 |
| | 108 | 07/96 → 08/03 | 1.998 | B | M | 4 | 16 | F7R710, F7R714 | | 81574 |
| 2.0 16V IDE | 103 | 11/99 → 08/03 | 1.998 | B | M | 4 | 16 | F4R746, F5R740 | | 81574 |
| | 103 | 11/99 → 08/03 | 1.998 | B | M | 4 | 16 | F5R740 | | 81574 |
| 2.0 i | 80 | 03/99 → 08/03 | 1.998 | B | M | 4 | 8 | F3R750, F3R751 | | 81574 |
| | 80 | 03/99 → 08/03 | 1.998 | B | M | 4 | 8 | F3R791, F3R796 | | 81574 |
| | 80 | 03/99 → 08/03 | 1.998 | B | M | 4 | 8 | F3R750, F3R751, F3R752, F3R791, F3R796, F3R797, F3R798 | | 81574 |
| | 80 | 03/99 → 08/03 | 1.998 | B | M | 4 | 8 | F3R791, F3R796 | | 81574 |
| | 80 | 01/99 → 09/99 | 1.998 | B | M | 4 | 8 | F3R796 | | 81574 |
| | 84 | 01/96 → 08/03 | 1.998 | B | M | 4 | 8 | F3R750, F3R751 | | 81574 |
| | 84 | 09/96 → 08/03 | 1.998 | B | M | 4 | 8 | F3R750, F3R751, F3R752, F3R791, F3R796, F3R797, F3R798 | | 81574 |
| | 84 | 03/96 → 08/03 | 1.998 | B | M | 4 | 8 | F3R750, F3R751, F3R798 | | 81574 |
| 2.0 RXE 4x4 | 84 | 05/97 → 10/99 | 1.998 | B | M | 4 | 8 | F3R750 | | 81574 |



KW



cm³



NO. OF VALVES



RENAULT

Megane II, Station Wagon, Coupé-Cabrio

| | | | | | | | | | | | |
|---------|---------------|---------------|-------|---|---|----|--------|--------------------------------|-----------|------------|------------|
| 1.4 | 60 | 09/03 → | 1.390 | B | M | 4 | 16 | K4J732 | | 84039 | NEW |
| | 60 | 09/03 → | 1.390 | B | M | 4 | 16 | K4J732 | | 81806 | |
| | 72 | 08/03 → 07/09 | 1.390 | B | M | 4 | 16 | K4J730, K4J740 | | 84039 | NEW |
| | 72 | 08/03 → 07/09 | 1.390 | B | M | 4 | 16 | K4J730, K4J740 | | 81806 | |
| 1.4 16V | 60 | 10/03 → 02/08 | 1.390 | B | M | 4 | 16 | K4J732 | | 84039 | NEW |
| | 60 | 10/03 → 02/08 | 1.390 | B | M | 4 | 16 | K4J732 | | 81806 | |
| | 72 | 11/02 → 02/08 | 1.390 | B | M | 4 | 16 | K4J730, K4J740 | | 84039 | NEW |
| | 72 | 11/02 → 02/08 | 1.390 | B | M | 4 | 16 | K4J730, K4J740 | | 81806 | |
| 1.5 dCi | 60 | 08/03 → 05/06 | 1.461 | D | M | 4 | 8 | K9K722 | → 03-2004 | 81810 | |
| | 60 | 08/03 → 05/06 | 1.461 | D | M | 4 | 8 | K9K722 | 04-2004 → | 84007 | |
| | 60 | 09/03 → | 1.461 | D | M | 4 | 8 | K9K722 | 03-2004 → | 84007 | |
| | 63 | 05/05 → 02/08 | 1.461 | D | M | 4 | 8 | K9K724 | | 84007 | |
| | 74 | 10/03 → 03/06 | 1.461 | D | M | 4 | 8 | K9K728, K9K729 | | 84007 | |
| | 76 | 01/07 → 02/08 | 1.461 | D | M | 4 | 8 | K9K734 | | 84007 | |
| | 78 | 05/05 → | 1.461 | D | M | 4 | 8 | K9K732 | | 84007 | |
| | 78 | 05/05 → 06/08 | 1.461 | D | M | 4 | 8 | K9K732, K9K734 | | 84007 | |
| | 60 | 11/02 → 02/08 | 1.461 | D | M | 4 | 8 | K9K722 | → 03-2004 | 81810 | |
| | 60 | 11/02 → 02/08 | 1.461 | D | M | 4 | 8 | K9K722 | 04-2004 → | 84007 | |
| | 76 | 01/07 → 07/09 | 1.461 | D | M | 4 | 8 | K9K728 | | 84007 | |
| | 76 | 01/07 → 06/09 | 1.461 | D | M | 4 | 8 | K9K734 | | 84007 | |
| | 78 | 03/06 → 06/08 | 1.461 | D | M | 4 | 8 | K9K732 | | 84007 | |
| | 78 | 05/05 → 06/08 | 1.461 | D | M | 4 | 8 | K9K732, K9K734 | | 84007 | |
| 1.6 | 75 | 09/03 → | 1.598 | B | M | 4 | 16 | K4M768 | | 84039 | NEW |
| | 75 | 09/03 → | 1.598 | B | M | 4 | 16 | K4M768 | | 81806 | |
| | 77 | 05/05 → | 1.598 | B | M | 4 | 16 | K4M762 | | 84039 | NEW |
| | 77 | 05/05 → | 1.598 | B | M | 4 | 16 | K4M762 | | 81806 | |
| | 77 | 06/05 → 02/08 | 1.598 | B | M | 4 | 16 | K4M788 | | 84039 | NEW |
| | 77 | 06/05 → 02/08 | 1.598 | B | M | 4 | 16 | K4M788 | | 81806 | |
| | 83 | 09/03 → 03/09 | 1.598 | B | M | 4 | 16 | K4M760, K4M761 | | 84039 | NEW |
| | 83 | 09/03 → 03/09 | 1.598 | B | M | 4 | 16 | K4M760, K4M761 | | 81806 | |
| 1.6 16V | 77 | 05/05 → 07/09 | 1.598 | B | M | 4 | 16 | K4M762 | | 84039 | NEW |
| | 77 | 05/05 → 07/09 | 1.598 | B | M | 4 | 16 | K4M762 | | 81806 | |
| | 82 | 01/06 → 06/08 | 1.598 | B | M | 4 | 16 | K4M760, K4M761, K4M812, K4M813 | | 84039 | NEW |
| | 82 | 01/06 → 06/08 | 1.598 | B | M | 4 | 16 | K4M760, K4M761, K4M812, K4M813 | | 81806 | |
| | 82 | 01/06 → 06/08 | 1.598 | B | M | 4 | 16 | K4M760, K4M812, K4M813 | | 84039 | NEW |
| | 82 | 01/06 → 06/08 | 1.598 | B | M | 4 | 16 | K4M760, K4M812, K4M813 | | 81806 | |
| | 82 | 01/06 → | 1.598 | B | M | 4 | 16 | K4M812, K4M813 | | 84039 | NEW |
| | 82 | 01/06 → | 1.598 | B | M | 4 | 16 | K4M812, K4M813 | | 81806 | |
| 83 | 11/02 → 02/08 | 1.598 | B | M | 4 | 16 | K4M760 | | 84039 | NEW | |
| 83 | 11/02 → 02/08 | 1.598 | B | M | 4 | 16 | K4M760 | | 81806 | | |

KW

cm³

NO. OF VALVES

RENAULT
Megane II, Station Wagon, Coupé-Cabrio

| | | | | | | | | | | | |
|-----------------|-----|---------------|-------|---|---|---|----|--------------------------------|--|-------|------------|
| 1.6 16V Hi-Flex | 77 | 02/08 → 07/09 | 1.598 | | M | 4 | 16 | K4M856 | | 84039 | NEW |
| | 77 | 02/08 → 07/09 | 1.598 | | M | 4 | 16 | K4M856 | | 81806 | |
| 1.6 Flex-Fuel | 77 | 01/07 → 02/08 | 1.598 | | M | 4 | 16 | K4M788 | | 84039 | NEW |
| | 77 | 01/07 → 02/08 | 1.598 | | M | 4 | 16 | K4M788 | | 81806 | |
| 1.9 dCi | 66 | 11/02 → 12/05 | 1.870 | D | M | 4 | 8 | F9Q808 | | 81868 | |
| | 66 | 11/02 → 12/05 | 1.870 | D | M | 4 | 8 | F9Q808 | | 84006 | |
| | 68 | 03/04 → 08/06 | 1.870 | D | M | 4 | 8 | F9Q808 | | 81868 | |
| | 68 | 03/04 → 08/06 | 1.870 | D | M | 4 | 8 | F9Q808 | | 84006 | |
| | 81 | 05/05 → 03/09 | 1.870 | D | M | 4 | 8 | F9Q804, F9Q816, F9Q818 | | 81868 | |
| | 81 | 05/05 → 03/09 | 1.870 | D | M | 4 | 8 | F9Q804, F9Q816, F9Q818 | | 84006 | |
| | 81 | 05/05 → 02/08 | 1.870 | D | M | 4 | 8 | F9Q804, F9Q818 | | 81868 | |
| | 81 | 05/05 → 02/08 | 1.870 | D | M | 4 | 8 | F9Q804, F9Q818 | | 84006 | |
| | 85 | 11/02 → 02/08 | 1.870 | D | M | 4 | 8 | F9Q804, F9Q816, F9Q818 | | 81868 | |
| | 85 | 11/02 → 02/08 | 1.870 | D | M | 4 | 8 | F9Q804, F9Q816, F9Q818 | | 84006 | |
| | 85 | 05/05 → 07/09 | 1.870 | D | M | 4 | 8 | F9Q818 | | 81868 | |
| | 85 | 05/05 → 07/09 | 1.870 | D | M | 4 | 8 | F9Q818 | | 84006 | |
| | 88 | 09/03 → 03/09 | 1.870 | D | M | 4 | 8 | F9Q800 | | 81868 | |
| | 88 | 09/03 → 03/09 | 1.870 | D | M | 4 | 8 | F9Q800 | | 84006 | |
| | 96 | 05/05 → 02/07 | 1.870 | D | M | 4 | 8 | F9Q803, F9Q804 | | 81868 | |
| | 96 | 05/05 → 02/07 | 1.870 | D | M | 4 | 8 | F9Q803, F9Q804 | | 84006 | |
| | 96 | 05/05 → 12/09 | 1.870 | D | M | 4 | 8 | F9Q803, F9Q804, F9Q816, F9Q818 | | 81868 | |
| | 96 | 05/05 → 12/09 | 1.870 | D | M | 4 | 8 | F9Q803, F9Q804, F9Q816, F9Q818 | | 84006 | |
| | 81 | 05/05 → | 1.870 | D | M | 4 | 8 | F9Q803, F9Q804, F9Q816, F9Q818 | | 81868 | |
| | 81 | 05/05 → | 1.870 | D | M | 4 | 8 | F9Q803, F9Q804, F9Q816, F9Q818 | | 84006 | |
| 2.0 | 99 | 09/03 → 12/09 | 1.998 | B | M | 4 | 16 | F4R770, F4R771 | | 81814 | |
| | 99 | 09/03 → 12/09 | 1.998 | B | M | 4 | 16 | F4R770, F4R771 | | 84009 | |
| | 102 | 09/03 → 02/07 | 1.998 | B | M | 4 | 16 | F4R770 | | 81814 | |
| | 102 | 09/03 → 02/07 | 1.998 | B | M | 4 | 16 | F4R770 | | 84009 | |
| | 169 | 08/06 → 02/08 | 1.998 | B | M | 4 | 16 | F4R774 | | 81814 | |
| | 169 | 08/06 → 02/08 | 1.998 | B | M | 4 | 16 | F4R774 | | 84009 | |
| 2.0 16V | 99 | 11/02 → 02/08 | 1.998 | B | M | 4 | 16 | F4R770 | | 81814 | |
| | 99 | 11/02 → 02/08 | 1.998 | B | M | 4 | 16 | F4R770 | | 84009 | |
| 2.0 16V Turbo | 120 | 05/04 → 02/08 | 1.998 | B | M | 4 | 16 | F4R776 | | 81814 | |
| | 120 | 05/04 → 02/08 | 1.998 | B | M | 4 | 16 | F4R776 | | 84009 | |

KW

cm³

NO. OF VALVES

RENAULT
Megane II, Station Wagon, Coupé-Cabrio

| | | | | | | | | | | |
|-------------------|-----|---------------|-------|---|---|---|----|-----------------|--|-------|
| 2.0 dCi | 110 | 09/05 → 03/09 | 1.995 | D | M | 4 | 16 | M9R700, M9R722 | | 82069 |
| | 127 | 01/07 → 02/08 | 1.995 | D | M | 4 | 16 | M9R724 | | 82069 |
| | 110 | 09/05 → 02/08 | 1.995 | D | M | 4 | 16 | M9R700, M9R722 | | 82069 |
| 2.0 Renault Sport | 165 | 05/04 → 10/09 | 1.998 | B | M | 4 | 16 | F4R774, F4Rt774 | | 81814 |
| | 165 | 05/04 → 10/09 | 1.998 | B | M | 4 | 16 | F4R774, F4Rt774 | | 84009 |

Megane III, Station Wagon, Coupé, CC

| | | | | | | | | | | |
|----------------|-----|---------|-------|----|---|---|----|--|--|------------------|
| 1.2 TCe | 97 | 01/13 → | 1.197 | B | M | 4 | 16 | H5F404 | | 84003 |
| 1.4 TCe | 96 | 06/10 → | 1.397 | B | M | 4 | 16 | H4J700 | | 84003 |
| 1.5 dCi | 63 | 03/09 → | 1.461 | D | M | 4 | 8 | K9K830 | | 81810 |
| | 63 | 12/09 → | 1.461 | D | M | 4 | 8 | K9K830 | | 84007 |
| | 78 | 02/09 → | 1.461 | D | M | 4 | 8 | K9KG832 | | 84007 |
| | 63 | 11/08 → | 1.461 | D | M | 4 | 8 | K9K830 | | 84007 |
| | 66 | 05/09 → | 1.461 | D | M | 4 | 8 | K9K834 | | 82098 |
| | 66 | 11/08 → | 1.461 | D | M | 4 | 8 | K9KH834 | | 82098 |
| | 78 | 02/09 → | 1.461 | D | M | 4 | 8 | K9K832 | | 84007 |
| | 78 | 02/09 → | 1.461 | D | M | 4 | 8 | K9K836, K9K846 | | 84007 |
| | 81 | 02/09 → | 1.461 | D | M | 4 | 8 | K9K636, K9K656, K9K657, K9K836, K9K837, K9K846 | | 82098 |
| | 81 | 02/09 → | 1.461 | D | M | 4 | 8 | K9K636, K9K836, K9K837, K9K846 | | 82098 |
| 1.6 16V | 81 | 02/09 → | 1.461 | D | M | 4 | 8 | K9K636, K9K837, K9K846, K9KJ836 | | 82098 |
| | 81 | 06/10 → | 1.461 | D | M | 4 | 8 | K9K837 | | 82098 |
| | 82 | 11/08 → | 1.598 | B | M | 4 | 16 | K4M858, K4M866 | | 84039 NEW |
| | 82 | 11/08 → | 1.598 | B | M | 4 | 16 | K4M858, K4M866 | | 81806 |
| | 74 | 11/08 → | 1.598 | B | M | 4 | 16 | K4M848 | | 84039 NEW |
| | 74 | 11/08 → | 1.598 | B | M | 4 | 16 | K4M848 | | 81806 |
| 1.6 16V Bifuel | 81 | 06/10 → | 1.598 | B | M | 4 | 16 | K4M858 | | 84039 NEW |
| | 81 | 06/10 → | 1.598 | B | M | 4 | 16 | K4M858 | | 81806 |
| 1.6 dCi | 81 | 11/08 → | 1.598 | BF | M | 4 | 16 | K4M866 | | 84039 NEW |
| | 81 | 11/08 → | 1.598 | BF | M | 4 | 16 | K4M866 | | 81806 |
| 1.6 TCe | 96 | 04/11 → | 1.598 | D | M | 4 | 16 | R9M402 | | 84034 NEW |
| | 96 | 04/11 → | 1.598 | D | M | 4 | 16 | R9M402, R9M404 | | 84034 NEW |
| 1.6 TCe | 96 | 01/11 → | 1.598 | B | M | 4 | 16 | | | 84039 NEW |
| | 96 | 01/11 → | 1.598 | B | M | 4 | 16 | | | 81806 |
| 1.9 dCi | 96 | 06/10 → | 1.870 | D | M | 4 | 8 | F9Q870 | | 82099 |
| | 96 | 11/08 → | 1.870 | D | M | 4 | 8 | F9Q870, F9Q872 | | 82099 |
| 2.0 CVT | 103 | 05/09 → | 1.997 | B | M | 4 | 16 | M4R711, M4RF713 | | 82069 |
| 2.0 dCi | 120 | 07/12 → | 1.995 | D | M | 4 | 16 | M9R610 | | 82069 |
| | 110 | 10/10 → | 1.995 | D | M | 4 | 16 | M9R615 | | 82069 |
| | 118 | 06/10 → | 1.995 | D | M | 4 | 16 | M9R610 | | 82069 |
| 2.0 R.S. | 195 | 11/08 → | 1.998 | B | M | 4 | 16 | F4R874 | | 81814 |
| | 195 | 11/08 → | 1.998 | B | M | 4 | 16 | F4R874 | | 84009 |

KW

cm³

NO. OF VALVES

RENAULT
Megane III, Station Wagon, Coupé, CC

| | | | | | | | | | | |
|---------|-----|---------|-------|---|---|---|----|----------------|--|-------|
| 2.0 TCe | 140 | 06/12 → | 1.998 | B | M | 4 | 16 | F4R872 | | 81814 |
| | 140 | 06/12 → | 1.998 | B | M | 4 | 16 | F4R872 | | 84009 |
| | 162 | 09/12 → | 1.998 | B | M | 4 | 16 | F4R874 | | 81814 |
| | 162 | 09/12 → | 1.998 | B | M | 4 | 16 | F4R874 | | 84009 |
| | 132 | 11/08 → | 1.998 | B | M | 4 | 16 | F4R870 | | 81814 |
| | 132 | 11/08 → | 1.998 | B | M | 4 | 16 | F4R870 | | 84009 |
| | 132 | 06/10 → | 1.998 | B | M | 4 | 16 | F4R870, F4R872 | | 81814 |
| | 132 | 06/10 → | 1.998 | B | M | 4 | 16 | F4R870, F4R872 | | 84009 |
| | 184 | 05/09 → | 1.998 | B | M | 4 | 16 | F4R874 | | 81814 |
| | 184 | 05/09 → | 1.998 | B | M | 4 | 16 | F4R874 | | 84009 |

Megane IV

| | | | | | | | | | | |
|-------------|----|---------|-------|---|---|---|----|--|--|------------------|
| 1.2 TCe 100 | 74 | 11/15 → | 1.197 | B | M | 4 | 16 | | | 84003 |
| 1.2 TCe 130 | 97 | 11/15 → | 1.197 | B | M | 4 | 16 | | | 84003 |
| 1.5 dCi 110 | 81 | 11/15 → | 1.461 | D | M | 4 | 8 | | | 82098 |
| 1.5 dCi 90 | 66 | 11/15 → | 1.461 | D | M | 4 | 8 | | | 82098 |
| 1.6 dCi 130 | 96 | 11/15 → | 1.598 | D | M | 4 | 16 | | | 84034 NEW |

Modus

| | | | | | | | | | | |
|-----------------|----|---------|-------|---|---|---|----|--------------------------------|--|------------------|
| 1.2 | 76 | 04/11 → | 1.149 | B | M | 4 | 16 | D4F786 | | 82090 |
| | 48 | 05/05 → | 1.149 | B | M | 4 | 16 | D4F740 | | 81820 |
| | 55 | 12/04 → | 1.149 | B | M | 4 | 16 | D4F740 | | 81820 |
| | 58 | 12/04 → | 1.149 | B | M | 4 | 16 | D4F764 | | 81820 |
| 1.2 16V | 74 | 05/07 → | 1.149 | B | M | 4 | 16 | D4F784 | | 81820 |
| 1.2 16V Hi-Flex | 55 | 10/08 → | 1.149 | | M | 4 | 16 | D4F740 | | 81820 |
| 1.4 | 72 | 12/04 → | 1.390 | B | M | 4 | 16 | K4J770, K4J780 | | 84039 NEW |
| | 72 | 12/04 → | 1.390 | B | M | 4 | 16 | K4J770, K4J780 | | 81806 |
| 1.5 dCi | 48 | 12/04 → | 1.461 | D | M | 4 | 8 | K9K752 | | 84007 |
| | 50 | 12/04 → | 1.461 | D | M | 4 | 8 | K9K762, K9K768 | | 81810 |
| | 60 | 09/04 → | 1.461 | D | M | 4 | 8 | K9K750 | | 84007 |
| | 63 | 12/04 → | 1.461 | D | M | 4 | 8 | K9K760, K9K766 | | 81810 |
| | 76 | 05/07 → | 1.461 | D | M | 4 | 8 | K9K772 | | 84007 |
| | 78 | 05/05 → | 1.461 | D | M | 4 | 8 | K9K764 | | 84007 |
| 1.5 dCi 75 | 55 | 10/10 → | 1.461 | D | M | 4 | 8 | K9K770 | | 84007 |
| 1.5 dCi 90 | 65 | 10/10 → | 1.461 | D | M | 4 | 8 | K9K750 | | 84007 |
| 1.6 | 65 | 12/04 → | 1.598 | B | M | 4 | 16 | K4M794 | | 84039 NEW |
| | 65 | 12/04 → | 1.598 | B | M | 4 | 16 | K4M794 | | 81806 |
| | 82 | 12/04 → | 1.598 | B | M | 4 | 16 | K4M790, K4M791, K4M800, K4M801 | | 84039 NEW |
| | 82 | 12/04 → | 1.598 | B | M | 4 | 16 | K4M790, K4M791, K4M800, K4M801 | | 81806 |

Rapid

| | | | | | | | | | | |
|-----|----|---------------|-----|---|---|---|---|--------|---------------|-------|
| 1.0 | 27 | 02/86 → 05/92 | 956 | B | M | 4 | 8 | C1C706 | (-)COP, (-)AC | 81573 |
| | 27 | 02/86 → 05/92 | 956 | B | M | 4 | 8 | C1C706 | (-)COP, (+)AC | 81756 |
| | 27 | 02/86 → 05/92 | 956 | B | M | 4 | 8 | C1C706 | (+)COP, (-)AC | 81811 |
| | 27 | 02/86 → 05/92 | 956 | B | M | 4 | 8 | C1C706 | (+)COP, (+)AC | 81853 |



KW

cm³

NO. OF VALVES

RENAULT
Rapid

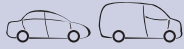
| | | | | | | | | | | |
|-----|---------------|---------------|-------|---|---|---|--------|--|-------------------|-------|
| 1.1 | 33 | 07/85 → 04/95 | 1.108 | B | M | 4 | 8 | C1E750, C1E752, C1E754, C1E756, C1E760, C1E762, C1E792 | (-)COP, (-)AC | 81573 |
| | 33 | 07/85 → 04/95 | 1.108 | B | M | 4 | 8 | C1E750, C1E752, C1E754, C1E756, C1E760, C1E762, C1E792 | (-)COP, (+)AC | 81756 |
| | 33 | 07/85 → 04/95 | 1.108 | B | M | 4 | 8 | C1E750, C1E752, C1E754, C1E756, C1E760, C1E762, C1E792 | (+)COP, (-)AC | 81811 |
| | 33 | 07/85 → 04/95 | 1.108 | B | M | 4 | 8 | C1E750, C1E752, C1E754, C1E756, C1E760, C1E762, C1E792 | (+)COP, (+)AC | 81853 |
| 1.2 | 40 | 09/91 → 03/98 | 1.239 | B | M | 4 | 8 | C3G710, C3G712 | (-)COP | 81596 |
| | 40 | 09/91 → 03/98 | 1.239 | B | M | 4 | 8 | C3G710, C3G712 | (-)COP, (-)AC | 81573 |
| | 40 | 09/91 → 03/98 | 1.239 | B | M | 4 | 8 | C3G710, C3G712 | (-)COP, (+)AC | 81756 |
| | 40 | 09/91 → 03/98 | 1.239 | B | M | 4 | 8 | C3G710, C3G712 | (+)COP, (-)AC | 81811 |
| | 40 | 09/91 → 03/98 | 1.239 | B | M | 4 | 8 | C3G710, C3G712 | (+)COP, (+)AC | 81853 |
| | 40 | 09/91 → 03/98 | 1.239 | B | M | 4 | 8 | C3G710, C3G712 | (+)COP, 05-1995 → | 81854 |
| 1.4 | 55 | 09/91 → 03/98 | 1.390 | B | M | 4 | 8 | E7J720, E7J724, E7J726, E7J773 | 01-1996 → | 81578 |
| | 55 | 09/91 → 03/98 | 1.390 | B | M | 4 | 8 | E7J720, E7J724, E7J726, E7J773 | | 81661 |
| | 58 | 01/94 → 03/98 | 1.390 | B | M | 4 | 8 | E7J728 | | 81661 |
| | 43 | 07/85 → 03/98 | 1.397 | B | M | 4 | 8 | C1J768, C1J780, C3J700, C3J702, C3J760, C3J762 | (-)COP, (-)AC | 81573 |
| | 43 | 07/85 → 03/98 | 1.397 | B | M | 4 | 8 | C1J768, C1J780, C3J700, C3J702, C3J760, C3J762 | (-)COP, (+)AC | 81756 |
| | 43 | 07/85 → 03/98 | 1.397 | B | M | 4 | 8 | C1J768, C1J780, C3J700, C3J702, C3J760, C3J762 | (+)COP, (-)AC | 81811 |
| | 43 | 07/85 → 03/98 | 1.397 | B | M | 4 | 8 | C1J768, C1J780, C3J700, C3J702, C3J760, C3J762 | (+)COP, (+)AC | 81853 |
| | 44 | 03/86 → 08/91 | 1.397 | B | M | 4 | 8 | C2J784 | (-)COP, (-)AC | 81573 |
| | 44 | 03/86 → 08/91 | 1.397 | B | M | 4 | 8 | C2J784 | (-)COP, (+)AC | 81756 |
| | 44 | 03/86 → 08/91 | 1.397 | B | M | 4 | 8 | C2J784 | (+)COP, (-)AC | 81811 |
| 44 | 03/86 → 08/91 | 1.397 | B | M | 4 | 8 | C2J784 | (+)COP, (+)AC | 81853 | |

KW

cm³

NO. OF VALVES

MAGNETI MARELLI
RENAULT
Rapid

| | | | | | | | | | | |
|-------|----|---------------|-------|---|---|---|---|--|--|-------|
| 1.6 D | 40 | 09/93 → 04/95 | 1.595 | D | M | 4 | 8 | F8M736 | | 81574 |
| | 40 | 03/86 → 08/98 | 1.596 | D | M | 4 | 8 | F8M720, F8M730, F8M736, F8M760 | | 81574 |
| 1.9 D | 40 | 09/94 → 03/98 | 1.870 | D | M | 4 | 8 | F8Q640, F8Q682 | | 81574 |
| | 47 | 09/91 → 03/98 | 1.870 | D | M | 4 | 8 | F8Q646, F8Q722, F8Q724, F8Q774, F8Q776 | | 81574 |

Safrane I

| | | | | | | | | | | |
|-----------------|-----|---------------|-------|---|---|---|----|--------------------------------|----------------------------|-------|
| 2.0 | 77 | 11/92 → 07/96 | 1.995 | B | M | 4 | 8 | J7R732, J7R733 | | 81759 |
| 2.0 12V | 97 | 04/92 → 07/96 | 1.995 | B | M | 4 | 12 | J7R734, J7R735 | | 81759 |
| 2.1 dT | 65 | 11/93 → 07/96 | 2.068 | D | M | 4 | 8 | J8S760 | → M: 920.501, (-)AC | 81757 |
| | 65 | 11/93 → 07/96 | 2.068 | D | M | 4 | 8 | J8S760 | M →: 920.502, (+)AC, (-)AC | 81758 |
| 2.2 | 79 | 04/92 → 07/96 | 2.165 | B | M | 4 | 8 | J7T762 | | 81759 |
| | 101 | 04/92 → 07/96 | 2.165 | B | M | 4 | 12 | J7T760, J7T761 | | 81759 |
| 2.5 dT | 83 | 12/92 → 07/96 | 2.500 | D | M | 4 | 8 | S8U762, S8U763 | | 81325 |
| 3.0 Biturbo 4x4 | 193 | 02/93 → 07/96 | 2.963 | B | M | 6 | 12 | Z7X726 | | 81764 |
| 3.0 V6 | 123 | 12/92 → 07/96 | 2.963 | B | M | 6 | 12 | Z7X721, Z7X722, Z7X723, Z7X753 | | 81764 |
| 3.0 V6 4x4 | 123 | 12/92 → 07/96 | 2.963 | B | M | 6 | 12 | Z7X721, Z7X722, Z7X723 | | 81764 |

Safrane II

| | | | | | | | | | | |
|---------|-----|---------------|-------|---|---|---|----|------------------------|------------|-------|
| 2.0 16V | 100 | 07/96 → 12/00 | 1.948 | B | M | 4 | 16 | N7Q710, N7Q711 | | 81759 |
| 2.2 dT | 83 | 07/96 → 12/00 | 2.188 | D | M | 4 | 12 | G8T740 | | 81761 |
| 2.5 20V | 121 | 07/96 → 12/00 | 2.435 | B | M | 5 | 20 | N7U700, N7U701 | | 81846 |
| 2.9 24V | 140 | 03/99 → 12/00 | 2.946 | B | A | 6 | 24 | L7X713 | → T: 08441 | 81844 |
| | 140 | 03/99 → 12/00 | 2.946 | B | A | 6 | 24 | L7X713 | T →: 08442 | 82042 |
| 3.0 V6 | 123 | 07/96 → 12/00 | 2.963 | B | M | 6 | 12 | Z7X722, Z7X723, Z7X755 | | 81844 |

Sandero I

| | | | | | | | | | | |
|-----|----|---------|-------|---|---|---|----|--------|--|-------|
| 1.4 | 55 | 02/09 → | 1.390 | B | M | 4 | 8 | K7J710 | | 81579 |
| 1.6 | 62 | 11/10 → | 1.598 | B | M | 4 | 8 | K7M718 | | 81579 |
| | 64 | 02/09 → | 1.598 | B | M | 4 | 8 | K7M710 | | 81579 |
| | 75 | 12/07 → | 1.598 | B | M | 4 | 8 | K7M710 | | 81579 |
| | 76 | 12/07 → | 1.598 | B | M | 4 | 16 | K4M690 | | 81579 |

Scénic I

| | | | | | | | | | | | |
|------------|----|---------------|-------|----|---|---|----|----------------|--|-------|------------|
| 1.4 16V | 70 | 09/99 → 08/03 | 1.390 | B | M | 4 | 16 | K4J714, K4J750 | | 84039 | NEW |
| | 70 | 09/99 → 08/03 | 1.390 | B | M | 4 | 16 | K4J714, K4J750 | | 81806 | |
| 1.6 | 75 | 03/01 → 08/03 | 1.598 | B | M | 4 | 16 | K4M708, K4M709 | | 81574 | |
| | 79 | 09/99 → 09/03 | 1.598 | B | M | 4 | 16 | K4M700, K4M706 | | 84039 | NEW |
| | 79 | 09/99 → 09/03 | 1.598 | B | M | 4 | 16 | K4M700, K4M706 | | 81806 | |
| 1.6 BiFuel | 79 | 09/99 → 04/01 | 1.598 | BF | M | 4 | 16 | K4M704 | | 84039 | NEW |
| | 79 | 09/99 → 04/01 | 1.598 | BF | M | 4 | 16 | K4M704 | | 81806 | |
| 1.8 16V | 85 | 01/01 → 08/03 | 1.783 | B | M | 4 | 16 | F4P720, F4P722 | | 81574 | |
| 1.8 4x4 | 85 | 07/00 → 04/01 | 1.783 | B | M | 4 | 16 | F4P722 | | 81574 | |

| | | | | | | | | |
|----|-----|--|--|--|---------------|--|--|--|
| | | | | | | | | |
| KW | cm³ | | | | NO. OF VALVES | | | |

RENAULT

Scénic I

| | | | | | | | | | | |
|-------------|-----|---------------|-------|---|---|---|----|--------------------------------|-----------|-------|
| 1.9 D | 47 | 09/99 → 03/01 | 1.870 | D | M | 4 | 8 | F8Q790 | | 81574 |
| 1.9 dCi | 75 | 09/99 → 08/03 | 1.870 | D | M | 4 | 8 | F9Q732, F9Q733 | | 81574 |
| 1.9 dCi RX4 | 74 | 12/02 → 08/03 | 1.870 | D | M | 4 | 8 | F9Q732, F9Q748, F9Q796 | | 81574 |
| | 75 | 11/00 → 08/03 | 1.870 | D | M | 4 | 8 | F9Q740 | | 81574 |
| 1.9 dTi | 59 | 02/01 → 08/03 | 1.870 | D | M | 4 | 8 | F9Q744 | | 81574 |
| | 72 | 09/99 → 08/03 | 1.870 | D | M | 4 | 8 | F9Q731, F9Q734, F9Q736 | | 81574 |
| 2.0 16V | 103 | 09/99 → 08/03 | 1.998 | B | M | 4 | 16 | F4R740, F4R741, F4R744, F4R747 | 10-1996 → | 81574 |
| | 102 | 07/00 → 08/03 | 1.998 | B | M | 4 | 16 | F4R740, F4R741, F4R746 | | 81574 |
| 2.0 16V RX4 | 102 | 06/00 → 08/03 | 1.998 | B | M | 4 | 16 | F4R744, F4R746 | | 81574 |

Scénic II

| | | | | | | | | | | | |
|---------|----|---------|-------|---|---|---|----|---------------------------------|-----------|-------|--|
| 1.4 | 72 | 06/03 → | 1.390 | B | M | 4 | 16 | K4J730, K4J740, K4J770 | | 84039 | |
| | 72 | 06/03 → | 1.390 | B | M | 4 | 16 | K4J730, K4J740, K4J770 | | 81806 | |
| 1.5 dCi | 60 | 06/03 → | 1.461 | D | M | 4 | 8 | K9K722 | → 03-2004 | 81810 | |
| | 60 | 06/03 → | 1.461 | D | M | 4 | 8 | K9K722 | 04-2004 → | 84007 | |
| | 63 | 05/05 → | 1.461 | D | M | 4 | 8 | K9K724 | | 84007 | |
| | 74 | 11/03 → | 1.461 | D | M | 4 | 8 | K9K728, K9K729 | → 03-2004 | 81810 | |
| | 74 | 11/03 → | 1.461 | D | M | 4 | 8 | K9K728, K9K729 | 04-2004 → | 84007 | |
| | 76 | 01/07 → | 1.461 | D | M | 4 | 8 | K9K734 | | 84007 | |
| 1.6 | 77 | 06/06 → | 1.598 | B | M | 4 | 16 | K4M788 | | 84039 | |
| | 77 | 06/06 → | 1.598 | B | M | 4 | 16 | K4M788 | | 81806 | |
| | 83 | 06/03 → | 1.598 | B | M | 4 | 16 | K4M761, K4M782 | | 84039 | |
| | 83 | 06/03 → | 1.598 | B | M | 4 | 16 | K4M761, K4M782 | | 81806 | |
| 1.6 16V | 82 | 10/05 → | 1.598 | B | M | 4 | 16 | K4M706, K4M766, K4M812, K4M813 | | 84039 | |
| | 82 | 10/05 → | 1.598 | B | M | 4 | 16 | K4M706, K4M766, K4M812, K4M813 | | 81806 | |
| 1.9 D | 85 | 06/06 → | 1.870 | D | M | 4 | 8 | F9Q812, F9QJ803 | | 81868 | |
| | 85 | 06/06 → | 1.870 | D | M | 4 | 8 | F9Q812, F9QJ803 | | 84006 | |
| 1.9 dCi | 92 | 06/03 → | 1.870 | D | M | 4 | 8 | F9Q804 | | 81868 | |
| | 92 | 06/03 → | 1.870 | D | M | 4 | 8 | F9Q804 | | 84006 | |
| | 81 | 05/05 → | 1.870 | D | M | 4 | 8 | F9Q804 | | 81868 | |
| | 81 | 05/05 → | 1.870 | D | M | 4 | 8 | F9Q804 | | 84006 | |
| | 88 | 06/03 → | 1.870 | D | M | 4 | 8 | F9Q812 | | 81868 | |
| | 88 | 06/03 → | 1.870 | D | M | 4 | 8 | F9Q812 | | 84006 | |
| | 96 | 05/05 → | 1.870 | D | M | 4 | 8 | F9Q804, F9Q816, F9Q818, F9QJ803 | | 81868 | |
| | 96 | 05/05 → | 1.870 | D | M | 4 | 8 | F9Q804, F9Q816, F9Q818, F9QJ803 | | 84006 | |

KW

cm³

NO. OF VALVES

RENAULT
Scénic II

| | | | | | | | | | | |
|---------------|-----|---------|-------|---|---|---|----|------------------------|--|-------|
| 2.0 | 99 | 06/03 → | 1.998 | B | M | 4 | 16 | F4R770, F4R771 | | 81814 |
| 2.0 | 99 | 06/03 → | 1.998 | B | M | 4 | 16 | F4R770, F4R771 | | 84009 |
| 2.0 16V Turbo | 120 | 05/04 → | 1.998 | B | M | 4 | 16 | F4R776 | | 81814 |
| | 120 | 05/04 → | 1.998 | B | M | 4 | 16 | F4R776 | | 84009 |
| 2.0 dCi | 110 | 09/05 → | 1.995 | D | M | 4 | 16 | M9R700, M9R721, M9R722 | | 82069 |

Scénic III

| | | | | | | | | | | |
|---------|-----|---------|-------|----|---|---|----|--|--|------------------|
| 1.2 TCe | 97 | 01/13 → | 1.197 | B | M | 4 | 16 | H5F404 | | 84003 |
| 1.4 16V | 96 | 02/09 → | 1.397 | B | M | 4 | 16 | H4J700 | | 84003 |
| 1.5 dCi | 63 | 04/09 → | 1.461 | D | M | 4 | 8 | K9K830 | | 84007 |
| | 70 | 11/10 → | 1.461 | D | M | 4 | 8 | K9K846 | | 82098 |
| | 78 | 02/09 → | 1.461 | D | M | 4 | 8 | K9K832 | | 84007 |
| | 81 | 04/09 → | 1.461 | D | M | 4 | 8 | K9K636, K9K656, K9K657, K9K836, K9K837 | | 82098 |
| 1.6 16V | 81 | 02/09 → | 1.598 | B | M | 4 | 16 | K4M858 | | 84039 NEW |
| | 81 | 02/09 → | 1.598 | B | M | 4 | 16 | K4M858 | | 81806 |
| 1.6 dCi | 96 | 04/11 → | 1.598 | D | M | 4 | 16 | R9M402, R9M404 | | 84034 NEW |
| 1.6 E85 | 81 | 02/09 → | 1.598 | FF | M | 4 | 16 | K4M866 | | 84039 NEW |
| | 81 | 02/09 → | 1.598 | FF | M | 4 | 16 | K4M866 | | 81806 |
| 1.9 dCi | 96 | 02/09 → | 1.870 | D | M | 4 | 8 | F9Q870, F9Q872 | | 82099 |
| 2.0 dCi | 110 | 02/09 → | 1.995 | D | M | 4 | 16 | M9R615 | | 82069 |
| | 118 | 04/09 → | 1.995 | D | M | 4 | 16 | M9R610 | | 82069 |

Sport Spider

| | | | | | | | | | | |
|---------|-----|---------------|-------|---|---|---|----|--------|--|-------|
| 2.0 16V | 110 | 03/95 → 10/99 | 1.998 | B | M | 4 | 16 | F7R710 | | 81574 |
|---------|-----|---------------|-------|---|---|---|----|--------|--|-------|

Super 5

| | | | | | | | | | | |
|-----|----|---------------|-------|---|---|---|---|--------------------------------|---------------|-------|
| 1.1 | 33 | 01/86 → 03/95 | 1.108 | B | M | 4 | 8 | C1E750, C1E752, C1E756, C1E760 | (-)COP, (-)AC | 81573 |
| | 33 | 01/86 → 03/95 | 1.108 | B | M | 4 | 8 | C1E750, C1E752, C1E756, C1E760 | (-)COP, (+)AC | 81756 |
| | 33 | 01/86 → 03/95 | 1.108 | B | M | 4 | 8 | C1E750, C1E752, C1E756, C1E760 | (+)COP, (-)AC | 81811 |
| | 33 | 01/86 → 03/95 | 1.108 | B | M | 4 | 8 | C1E750, C1E752, C1E756, C1E760 | (+)COP, (+)AC | 81853 |
| | 34 | 10/84 → 12/96 | 1.108 | B | M | 4 | 8 | C1E750, C1E752, C1E754 | (-)COP, (-)AC | 81573 |
| | 34 | 10/84 → 12/96 | 1.108 | B | M | 4 | 8 | C1E750, C1E752, C1E754 | (-)COP, (+)AC | 81756 |
| | 34 | 10/84 → 12/96 | 1.108 | B | M | 4 | 8 | C1E750, C1E752, C1E754 | (+)COP, (-)AC | 81811 |
| | 34 | 10/84 → 12/96 | 1.108 | B | M | 4 | 8 | C1E750, C1E752, C1E754 | (+)COP, (+)AC | 81853 |

KW

cm³

NO. OF VALVES

RENAULT
Super 5

| | | | | | | | | | | |
|--------------|-----|---------------|-------|---|---|---|---|--|---------------|-------|
| 1.2 | 40 | 01/87 → 08/90 | 1.237 | B | M | 4 | 8 | C1G702, C1G720, C1G722 | (-)COP, (-)AC | 81573 |
| | 40 | 01/87 → 08/90 | 1.237 | B | M | 4 | 8 | C1G702, C1G720, C1G722 | (-)COP, (+)AC | 81756 |
| | 40 | 01/87 → 08/90 | 1.237 | B | M | 4 | 8 | C1G702, C1G720, C1G722 | (+)COP, (-)AC | 81811 |
| | 40 | 01/87 → 08/90 | 1.237 | B | M | 4 | 8 | C1G702, C1G720, C1G722 | (+)COP, (+)AC | 81853 |
| | 44 | 01/87 → 12/96 | 1.237 | B | M | 4 | 8 | C1G702 | (-)COP, (-)AC | 81573 |
| | 44 | 01/87 → 12/96 | 1.237 | B | M | 4 | 8 | C1G702 | (-)COP, (+)AC | 81756 |
| | 44 | 01/87 → 12/96 | 1.237 | B | M | 4 | 8 | C1G702 | (+)COP, (-)AC | 81811 |
| | 44 | 01/87 → 12/96 | 1.237 | B | M | 4 | 8 | C1G702 | (+)COP, (+)AC | 81853 |
| 1.4 | 43 | 10/84 → 12/96 | 1.397 | B | M | 4 | 8 | C1J768, C1J780, C3J700, C3J702, C3J760 | (-)COP, (-)AC | 81573 |
| | 43 | 10/84 → 12/96 | 1.397 | B | M | 4 | 8 | C1J768, C1J780, C3J700, C3J702, C3J760 | (-)COP, (+)AC | 81756 |
| | 43 | 10/84 → 12/96 | 1.397 | B | M | 4 | 8 | C1J768, C1J780, C3J700, C3J702, C3J760 | (+)COP, (-)AC | 81811 |
| | 43 | 10/84 → 12/96 | 1.397 | B | M | 4 | 8 | C1J768, C1J780, C3J700, C3J702, C3J760 | (+)COP, (+)AC | 81853 |
| | 44 | 06/87 → 08/90 | 1.397 | B | M | 4 | 8 | C2J784 | (-)COP, (-)AC | 81573 |
| | 44 | 06/87 → 08/90 | 1.397 | B | M | 4 | 8 | C2J784 | (-)COP, (+)AC | 81756 |
| | 44 | 06/87 → 08/90 | 1.397 | B | M | 4 | 8 | C2J784 | (+)COP, (-)AC | 81811 |
| | 44 | 06/87 → 08/90 | 1.397 | B | M | 4 | 8 | C2J784 | (+)COP, (+)AC | 81853 |
| 1.4 Turbo | 88 | 04/85 → 08/90 | 1.397 | B | M | 4 | 8 | C1J782, C1J784, C1J788 | (-)COP, (-)AC | 81573 |
| | 88 | 04/85 → 08/90 | 1.397 | B | M | 4 | 8 | C1J782, C1J784, C1J788 | (-)COP, (+)AC | 81756 |
| | 88 | 04/85 → 08/90 | 1.397 | B | M | 4 | 8 | C1J782, C1J784, C1J788 | (+)COP, (-)AC | 81811 |
| | 88 | 04/85 → 08/90 | 1.397 | B | M | 4 | 8 | C1J782, C1J784, C1J788 | (+)COP, (+)AC | 81853 |
| 1.4 Turbo GT | 118 | 01/85 → 05/91 | 1.397 | B | M | 4 | 8 | 840730 | (-)COP, (-)AC | 81573 |
| | 118 | 01/85 → 05/91 | 1.397 | B | M | 4 | 8 | 840730 | (-)COP, (+)AC | 81756 |
| | 118 | 01/85 → 05/91 | 1.397 | B | M | 4 | 8 | 840730 | (+)COP, (-)AC | 81811 |
| | 118 | 01/85 → 05/91 | 1.397 | B | M | 4 | 8 | 840730 | (+)COP, (+)AC | 81853 |
| 1.6 D | 40 | 10/84 → 12/96 | 1.595 | D | M | 4 | 8 | F8M720 | | 81574 |
| | 40 | 08/85 → 12/96 | 1.596 | D | M | 4 | 8 | F8M720, F8M730 | | 81574 |
| 1.7 | 54 | 10/86 → 03/95 | 1.721 | B | M | 4 | 8 | F3N716, F3N717 | | 81574 |
| | 64 | 06/87 → 03/95 | 1.721 | B | M | 4 | 8 | F2N740, F2N742 | | 81574 |
| 1.7 i | 69 | 10/86 → 08/91 | 1.721 | B | M | 4 | 8 | F3N702, F3N722 | | 81574 |

KW

cm³

NO. OF VALVES

MAGNETI MARELLI
RENAULT
Thalia I

| | | | | | | | | | | |
|--------------------|-----|---------------|-------|---|---|---|----|----------------|--|------------------|
| 1.2 | 43 | 02/98 → 10/03 | 1.149 | B | M | 4 | 8 | D7F744, D7F746 | | 81661 |
| 1.2 16V | 55 | 04/02 → | 1.149 | B | M | 4 | 16 | D4F706, D4F712 | | 81820 |
| 1.4 | 55 | 08/00 → | 1.390 | B | M | 4 | 8 | K7J700 | | 81578 |
| 1.4 16V | 72 | 08/00 → | 1.390 | B | M | 4 | 16 | K4J712 | | 84039 NEW |
| | 72 | 08/00 → | 1.390 | B | M | 4 | 16 | K4J712 | | 81806 |
| 1.5 dCi | 47 | 06/05 → | 1.461 | D | M | 4 | 8 | K9K740 | | 84007 |
| | 48 | 04/02 → | 1.461 | D | M | 4 | 8 | K9K700 | | 81810 |
| | 50 | 02/03 → | 1.461 | D | M | 4 | 8 | K9K700, K9K714 | | 84007 |
| | 60 | 06/01 → | 1.461 | D | M | 4 | 8 | K9K702 | | 84007 |
| 1.6 | 66 | 03/98 → | 1.598 | B | M | 4 | 8 | K7M746 | | 81579 |
| 1.6 16V | 79 | 04/02 → | 1.598 | B | M | 4 | 16 | K4M740 | | 84039 NEW |
| | 79 | 04/02 → | 1.598 | B | M | 4 | 16 | K4M740 | | 81806 |
| 1.9 D | 48 | 02/98 → 05/01 | 1.870 | D | M | 4 | 8 | F8Q630 | | 81574 |
| 2.0 | 124 | 09/01 → | 1.998 | B | M | 4 | 16 | F4R738 | | 81574 |
| 3.0 V6 Turbo Sport | 169 | 04/00 → 09/01 | 2.946 | B | M | 6 | 24 | L7X732 | | 81844 |
| | 187 | 06/02 → | 2.946 | B | M | 6 | 24 | L7X762 | | 81844 |

Thalia II

| | | | | | | | | | | |
|---------|----|---------|-------|---|---|---|----|--------|--|------------------|
| 1.2 16V | 55 | 09/08 → | 1.149 | B | M | 4 | 16 | D4F728 | | 82090 |
| 1.5 dCi | 47 | 09/08 → | 1.461 | D | M | 4 | 8 | K9K740 | | 84007 |
| | 48 | 01/09 → | 1.461 | D | M | 4 | 8 | K9K700 | | 81810 |
| | 48 | 01/09 → | 1.461 | D | M | 4 | 8 | K9K700 | | 84007 |
| | 62 | 09/08 → | 1.461 | D | M | 4 | 8 | K9K718 | | 84007 |
| 1.6 16V | 77 | 09/08 → | 1.598 | B | M | 4 | 16 | K4M743 | | 84039 NEW |
| | 77 | 09/08 → | 1.598 | B | M | 4 | 16 | K4M743 | | 81806 |

Trafic I

| | | | | | | | | | | |
|-------|----|---------------|-------|---|---|---|---|----------------|-----------------------------|-------|
| 1.7 | 50 | 08/92 → 08/94 | 1.721 | B | M | 4 | 8 | F1N720 | 01-1986 →, → 12-1995 | 81574 |
| | 50 | 08/92 → 08/94 | 1.721 | B | M | 4 | 8 | F1N724 | 01-1986 →, → 12-1995 | 81574 |
| 1.9 D | 44 | 06/97 → 03/01 | 1.870 | D | M | 4 | 8 | F8Q606 | | 81574 |
| 2.0 | 59 | 05/89 → 08/90 | 1.995 | B | M | 4 | 8 | J5R716 | 01-1981 →, → M: F029.328 | 81828 |
| | 59 | 05/89 → 08/90 | 1.995 | B | M | 4 | 8 | J5R716 | 01-1981 →, M →: F029.329 | 81666 |
| | 59 | 05/89 → 08/90 | 1.995 | B | M | 4 | 8 | J5R726 | 01-1981 →, → 08-1994 | 81828 |
| 2.1 D | 43 | 05/89 → 06/94 | 2.068 | D | M | 4 | 8 | 852720, 852750 | | 81664 |
| | 43 | 05/89 → 06/94 | 2.068 | D | M | 4 | 8 | 852750 | 01-1981 →, → 12-1995 | 81664 |
| | 47 | 06/94 → 10/97 | 2.068 | D | M | 4 | 8 | J8S620, J8S758 | 09-1994 → | 81608 |
| 2.2 | 70 | 05/89 → 06/94 | 2.165 | B | M | 4 | 8 | J7T780 | 01-1981 → | 81828 |
| | 74 | 06/94 → 10/97 | 2.165 | B | M | 4 | 8 | J7T600 | 01-1981 →, → M: F305.272 | 81828 |
| | 74 | 06/94 → 10/97 | 2.165 | B | M | 4 | 8 | J7T600 | 01-1981 →, M →: F305.273 | 81666 |

KW

cm³

NO. OF VALVES

RENAULT
Traffic I

| | | | | | | | | | |
|-------|----|---------------|-------|---|---|---|---|--|-------|
| 2.5 D | 51 | 05/89 → 03/01 | 2.445 | D | M | 4 | 8 | 8140.61.240, S8U720, S8U722 | 81334 |
| | 55 | 05/89 → 03/01 | 2.499 | D | M | 4 | 8 | 8140.67.2500, 8140.67.2550, 8140.67.2580, S8U750, S8U752, S8U758 | 81334 |

Traffic II

| | | | | | | | | | |
|-------------|-----|---------------|-------|---|---|---|----|--|-------|
| 1.9 dCi | 59 | 04/01 → 07/03 | 1.870 | D | M | 4 | 8 | F9Q762 | 81814 |
| | 59 | 04/01 → 07/03 | 1.870 | D | M | 4 | 8 | F9Q762 | 84009 |
| | 75 | 03/01 → | 1.870 | D | M | 4 | 8 | F9Q760 | 81814 |
| | 75 | 03/01 → | 1.870 | D | M | 4 | 8 | F9Q760 | 84009 |
| 1.9 dCi 100 | 74 | 03/01 → | 1.870 | D | M | 4 | 8 | F9Q760 | 81814 |
| | 74 | 03/01 → | 1.870 | D | M | 4 | 8 | F9Q760 | 84009 |
| 1.9 dCi 80 | 60 | 03/01 → | 1.870 | D | M | 4 | 8 | F9Q760, F9Q762 | 81814 |
| | 60 | 03/01 → | 1.870 | D | M | 4 | 8 | F9Q760, F9Q762 | 84009 |
| | 60 | 03/01 → | 1.870 | D | M | 4 | 8 | F9Q762 | 81814 |
| | 60 | 03/01 → | 1.870 | D | M | 4 | 8 | F9Q762 | 84009 |
| 2.0 | 88 | 03/01 → | 1.998 | B | M | 4 | 16 | F4R720 | 81814 |
| | 88 | 03/01 → | 1.998 | B | M | 4 | 16 | F4R720 | 84009 |
| | 88 | 03/01 → | 1.998 | B | M | 4 | 16 | F4R720, F4R722 | 81814 |
| | 88 | 03/01 → | 1.998 | B | M | 4 | 16 | F4R720, F4R722 | 84009 |
| 2.0 16V | 86 | 08/06 → | 1.998 | B | M | 4 | 16 | F4R820 | 81814 |
| | 86 | 08/06 → | 1.998 | B | M | 4 | 16 | F4R820 | 84009 |
| 2.0 dCi 115 | 84 | 08/06 → | 1.995 | D | M | 4 | 16 | M9R630, M9R692, M9R780, M9R782, M9R786 | 82069 |
| | 84 | 08/06 → | 1.995 | D | M | 4 | 16 | M9R692, M9R780, M9R782, M9R786 | 82069 |
| | 84 | 08/06 → | 1.995 | D | M | 4 | 16 | M9R780, M9R782, M9R786 | 82069 |
| 2.0 dCi 90 | 66 | 08/06 → | 1.995 | D | M | 4 | 16 | M9R630, M9R780, M9R782 | 82069 |
| | 66 | 08/06 → | 1.995 | D | M | 4 | 16 | M9R780, M9R782 | 82069 |
| | 66 | 08/06 → | 1.995 | D | M | 4 | 16 | M9R782 | 82069 |
| 2.5 dCi | 84 | 08/07 → | 2.463 | D | M | 4 | 16 | G9U630 | 81855 |
| 2.5 dCi 115 | 84 | 02/08 → | 2.464 | D | M | 4 | 16 | G9U630 | 81855 |
| 2.5 dCi 135 | 99 | 03/01 → | 2.463 | D | M | 4 | 16 | G9U730 | 81855 |
| | 99 | 05/03 → | 2.464 | D | M | 4 | 16 | G9U730 | 81855 |
| 2.5 dCi 145 | 107 | 08/06 → | 2.464 | D | M | 4 | 16 | G9U630 | 81855 |
| 2.5 DTi | 99 | 03/03 → 07/03 | 2.463 | D | M | 4 | 16 | G9U730 | 81855 |

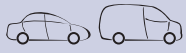
KW

cm³

NO. OF VALVES

RENAULT
Twingo I

| | | | | | | | | | | |
|---------|----|---------------|-------|---|---|---|----|--|---------------|-------|
| 1.2 | 44 | 09/98 → 08/00 | 1.149 | B | M | 4 | 8 | D7F702, D7F703, D7F704 | | 81762 |
| | 40 | 05/96 → | 1.149 | B | M | 4 | 8 | D7F700, D7F701 | | 81762 |
| | 43 | 05/96 → | 1.149 | B | M | 4 | 8 | D7F700, D7F701, D7F702, D7F703, D7F704 | | 81762 |
| | 43 | 05/96 → | 1.149 | B | M | 4 | 8 | D7F700, D7F701, D7F702, D7F703, D7F704, D7F706 | | 81762 |
| | 40 | 03/93 → 10/96 | 1.239 | B | M | 4 | 8 | C3G700, C3G702 | (-)COP, (-)AC | 81596 |
| | 40 | 03/93 → 10/96 | 1.239 | B | M | 4 | 8 | C3G700, C3G702 | (+)COP, (-)AC | 81854 |
| | 40 | 03/93 → 10/96 | 1.239 | B | M | 4 | 8 | C3G700, C3G702 | (+)COP, (+)AC | 81852 |
| 1.2 16V | 44 | 08/04 → 06/07 | 1.149 | B | M | 4 | 16 | D4F708 | | 81820 |
| | 55 | 01/01 → | 1.149 | B | M | 4 | 16 | D4F702 | | 81820 |
| 1.2 LPG | 44 | 10/03 → | 1.149 | | M | 4 | 8 | D7F702, D7F708 | | 82091 |
| | 44 | 10/03 → | 1.149 | | M | 4 | 8 | D7F702, D7F708 | | 81762 |

Twingo II

| | | | | | | | | | | |
|-------------|----|---------|-------|---|---|---|----|------------------------|--|------------------|
| 1.2 | 43 | 03/07 → | 1.149 | B | M | 4 | 8 | D7F800 | | 82091 |
| 1.2 16V | 55 | 03/07 → | 1.149 | B | M | 4 | 16 | D4F764, D4F770, D4F772 | | 82090 |
| | 56 | 03/07 → | 1.149 | B | M | 4 | 16 | D4F772 | | 82090 |
| 1.2 TCe 100 | 75 | 02/11 → | 1.149 | B | M | 4 | 16 | D4F780, D4F782 | | 82090 |
| 1.2 Turbo | 74 | 03/07 → | 1.149 | B | M | 4 | 16 | D4F780, D4F782 | | 82090 |
| 1.5 dCi | 47 | 03/07 → | 1.461 | D | M | 4 | 8 | K9K740 | | 84007 |
| | 62 | 04/08 → | 1.461 | D | M | 4 | 8 | K9K718 | | 81810 |
| | 62 | 04/08 → | 1.461 | D | M | 4 | 8 | K9K718 | | 84007 |
| 1.5 dCi 75 | 55 | 10/10 → | 1.461 | D | M | 4 | 8 | K9K820 | | 82098 |
| 1.5 dCi 90 | 63 | 10/10 → | 1.461 | D | M | 4 | 8 | K9K820 | | 82098 |
| 1.6 RS | 98 | 05/08 → | 1.598 | B | M | 4 | 16 | K4M854 | | 84039 NEW |
| | 98 | 05/08 → | 1.598 | B | M | 4 | 16 | K4M854 | | 81806 |

Twingo III

| | | | | | | | | | | |
|------------|----|---------|-----|---|---|---|----|--------|--|-------|
| 0.9 TCe 90 | 66 | 09/14 → | 898 | B | M | 3 | 12 | H4B401 | | 84003 |
| 1.0 SCe 70 | 52 | 09/14 → | 999 | B | M | 3 | 12 | H4D400 | | 84003 |

Vel Satis

| | | | | | | | | | | |
|---------------|-----|---------|-------|---|---|---|----|------------------------|--|-------|
| 2.0 16V Turbo | 125 | 04/04 → | 1.998 | B | M | 4 | 16 | F4R766, F4R767 | | 81814 |
| | 125 | 04/04 → | 1.998 | B | M | 4 | 16 | F4R766, F4R767 | | 84009 |
| | 120 | 06/02 → | 1.998 | B | M | 4 | 16 | F4R762, F4R763 | | 81814 |
| | 120 | 06/02 → | 1.998 | B | M | 4 | 16 | F4R762, F4R763 | | 84009 |
| 2.0 dCi | 110 | 08/05 → | 1.995 | D | M | 4 | 16 | M9R760 | | 82069 |
| | 127 | 01/06 → | 1.995 | D | M | 4 | 16 | M9R760, M9R762, M9R763 | | 82069 |
| 2.0 Turbo | 108 | 04/05 → | 1.998 | B | M | 4 | 16 | F4R867 | | 81814 |
| | 108 | 04/05 → | 1.998 | B | M | 4 | 16 | F4R867 | | 84009 |

KW

cm³

NO. OF VALVES

MAGNETI MARELLI
RENAULT
Vel Satis

| | | | | | | | | | | |
|---------|-----|---------|-------|---|---|---|----|--|--|-------|
| 2.2 dCi | 83 | 12/04 → | 2.188 | D | M | 4 | 16 | G9T600 | | 81855 |
| | 85 | 04/04 → | 2.188 | D | M | 4 | 16 | G9T600 | | 81855 |
| | 102 | 09/04 → | 2.188 | D | M | 4 | 16 | G9T600, G9T606, G9T607, G9T700, G9T702 | | 81855 |
| | 110 | 06/02 → | 2.188 | D | M | 4 | 16 | G9T702, G9T703 | | 81855 |

Wind

| | | | | | | | | | | | |
|-------------|----|---------|-------|---|---|---|----|--------|--|-------|------------|
| 1.2 | 74 | 07/10 → | 1.149 | B | M | 4 | 16 | D4F782 | | 84024 | NEW |
| 1.2 TCe 100 | 75 | 02/11 → | 1.149 | B | M | 4 | 16 | D4F780 | | 82090 | |
| 1.6 | 98 | 07/10 → | 1.598 | B | M | 4 | 16 | K4M854 | | 84039 | NEW |
| | 98 | 07/10 → | 1.598 | B | M | 4 | 16 | K4M854 | | 81806 | |

ROVER
25

| | | | | | | | | | | |
|---------|-----|---------------|-------|---|---|---|----|-------|--|-------|
| 1.1 16V | 55 | 01/04 → 05/05 | 1.119 | B | M | 4 | 16 | 11K4F | | 81615 |
| 1.4 16V | 62 | 10/99 → 05/05 | 1.396 | B | M | 4 | 16 | 14K4M | | 81615 |
| | 76 | 10/99 → 05/05 | 1.396 | B | M | 4 | 16 | 14K4F | | 81615 |
| 1.6 16V | 80 | 10/99 → 05/05 | 1.588 | B | M | 4 | 16 | 16K4F | | 81615 |
| 1.8 16V | 85 | 10/99 → 05/05 | 1.796 | B | A | 4 | 16 | 18K4F | | 81615 |
| | 107 | 02/00 → 05/05 | 1.796 | B | M | 4 | 16 | 18K4K | | 81615 |
| 2.0 iDT | 74 | 10/99 → 05/05 | 1.994 | D | M | 4 | 8 | 20T2N | | 81707 |

45

| | | | | | | | | | | |
|---------|-----|---------------|-------|---|---|---|----|-------|--|-------|
| 1.4 | 76 | 02/00 → 05/05 | 1.396 | B | M | 4 | 16 | 14K4F | | 81615 |
| 1.6 | 80 | 02/00 → 05/05 | 1.588 | B | M | 4 | 16 | 16K4F | | 81615 |
| 1.8 | 86 | 02/00 → 05/05 | 1.796 | B | M | 4 | 16 | 18K4F | | 81615 |
| 2.0 iDT | 74 | 02/00 → 05/05 | 1.994 | D | M | 4 | 8 | 20T2N | | 81707 |
| 2.0 V6 | 110 | 02/00 → 05/05 | 1.997 | B | A | 6 | 24 | 20K4F | | 82029 |

75, Station Wagon

| | | | | | | | | | | |
|-----------|-----|---------------|-------|---|---|---|----|-------|--|-------|
| 1.8 | 88 | 02/99 → 05/05 | 1.796 | B | M | 4 | 16 | K1.8 | | 81615 |
| 1.8 Turbo | 110 | 05/03 → 05/05 | 1.796 | B | M | 4 | 16 | 18K4G | | 81615 |
| 2.0 V6 | 110 | 02/99 → 05/05 | 1.997 | B | M | 6 | 24 | 20K4F | | 82029 |
| 2.5 V6 | 129 | 02/99 → 10/01 | 2.497 | B | M | 6 | 24 | KV6 | | 82029 |
| | 130 | 10/01 → 05/05 | 2.497 | B | M | 6 | 24 | 25K4F | | 82029 |
| | 130 | 08/01 → 05/05 | 2.497 | B | M | 6 | 24 | KV6 | | 82029 |

100

| | | | | | | | | | | |
|-----|----|---------------|-------|---|---|---|----|--------------|--|-------|
| 111 | 44 | 04/94 → 10/97 | 1.119 | B | M | 4 | 8 | 11K2D | | 81614 |
| 114 | 55 | 04/94 → 10/97 | 1.396 | B | M | 4 | 8 | 14K2A, 14K2D | | 81614 |
| | 75 | 03/97 → 10/98 | 1.396 | B | M | 4 | 16 | 14K4F | | 81615 |

100 (Metro)

| | | | | | | | | | | |
|-------------|----|---------------|-------|---|---|---|----|--------------|--|-------|
| 111 C/L/S | 44 | 03/90 → 12/98 | 1.119 | B | M | 4 | 8 | 11K2A, 11K2D | | 81614 |
| 114 D | 38 | 10/92 → 12/94 | 1.361 | D | M | 4 | 8 | TUD3 | | 81556 |
| 114 GSi | 76 | 10/94 → 10/95 | 1.396 | B | M | 4 | 16 | 14K4F | | 81615 |
| 114 GTI 16V | 69 | 03/90 → 08/91 | 1.396 | B | M | 4 | 16 | 14K4C, 14K4D | | 81615 |
| | 76 | 08/91 → 12/98 | 1.396 | B | M | 4 | 16 | 14K4F | | 81615 |

KW

cm³

NO. OF VALVES

ROVER
100 (Metro)

| | | | | | | | | | | |
|---------------------|----|---------------|-------|---|---|---|----|--------------|--|-------|
| 114 GTI/GT 16V Cat. | 66 | 03/90 → 12/98 | 1.396 | B | M | 4 | 16 | 14K4C, 14K4D | | 81615 |
| 114 Si/L/GTA | 55 | 03/90 → 12/98 | 1.396 | B | M | 4 | 8 | 14K2A, 14K2D | | 81614 |
| 115 D | 42 | 12/94 → 12/98 | 1.527 | D | M | 4 | 8 | TUD5 | | 81556 |

200 II, Coupé

| | | | | | | | | | | |
|------------|-----|---------------|-------|---|---|---|----|--------------|--|-------|
| 2.0 | 152 | 10/92 → 09/97 | 1.994 | B | M | 4 | 16 | | | 81707 |
| 214 | 55 | 09/93 → 10/95 | 1.396 | B | M | 4 | 8 | 14K2A, 14K2D | | 81614 |
| 214 GSi/Si | 70 | 01/90 → 10/95 | 1.396 | B | M | 4 | 16 | 14K4C | | 81615 |
| | 76 | 12/92 → 10/95 | 1.396 | B | M | 4 | 16 | 14K4F | | 81615 |
| 214 Si/Gsi | 66 | 10/89 → 10/95 | 1.396 | B | M | 4 | 16 | 14K4C, 14K4D | | 81615 |
| 216 | 90 | 10/92 → 06/99 | 1.590 | B | M | 4 | 16 | D16A8 | | 81613 |
| 216 GSi | 82 | 10/89 → 10/95 | 1.590 | B | M | 4 | 16 | D16Z2 | | 81613 |
| | 85 | 10/89 → 10/95 | 1.590 | B | M | 4 | 16 | D16A7 | | 81613 |
| 216 GTi | 90 | 09/90 → 10/95 | 1.590 | B | M | 4 | 16 | D16A8 | | 81613 |
| | 96 | 09/90 → 10/95 | 1.590 | B | M | 4 | 16 | D16A9 | | 81613 |
| 218 D | 52 | 09/91 → 10/95 | 1.905 | D | M | 4 | 8 | XUD9 | | 81672 |
| 218 TD | 65 | 09/91 → 10/95 | 1.769 | D | M | 4 | 8 | XUD7TE | | 81672 |
| 220 GSi | 100 | 05/94 → 06/99 | 1.994 | B | M | 4 | 16 | 20T4H | | 81707 |
| 220 GTi | 100 | 01/93 → 10/95 | 1.994 | B | M | 4 | 16 | 20T4H | | 81707 |
| | 103 | 09/91 → 10/95 | 1.994 | B | M | 4 | 16 | 20M4F | | 81707 |
| 220 Turbo | 147 | 01/93 → 10/95 | 1.994 | B | M | 4 | 16 | 20T4G | | 81707 |

200 III

| | | | | | | | | | | |
|----------|-----|---------------|-------|---|---|---|----|-------|-----------|-------|
| 211 | 44 | 01/98 → 03/00 | 1.119 | B | M | 4 | 8 | 11K2D | | 81614 |
| 214 i | 55 | 11/95 → 03/00 | 1.396 | B | M | 4 | 8 | 14K2F | 03-1996 → | 81614 |
| 214 Si | 76 | 11/95 → 03/00 | 1.396 | B | M | 4 | 16 | 14K4F | | 81615 |
| 216 Si | 82 | 11/95 → 03/00 | 1.588 | B | M | 4 | 16 | 16K4F | | 81615 |
| 218 K Vi | 107 | 11/95 → 03/00 | 1.796 | B | M | 4 | 16 | 18K4K | | 81615 |
| 220 D/SD | 63 | 11/95 → 03/00 | 1.994 | D | M | 4 | 8 | 20T2R | | 81707 |
| 220 SDi | 77 | 11/95 → 03/00 | 1.994 | D | M | 4 | 8 | 20T2N | | 81707 |

400 I, Station Wagon

| | | | | | | | | | | |
|---------------------|-----|---------------|-------|---|---|---|----|--------------|-----------|-------|
| 1.6 i | 82 | 05/94 → 11/98 | 1.590 | B | M | 4 | 16 | D16Z2 | → 02-1996 | 81613 |
| | 82 | 05/94 → 11/98 | 1.590 | B | M | 4 | 16 | D16Z2 | 03-1996 → | 81615 |
| | 90 | 05/94 → 11/98 | 1.590 | B | M | 4 | 16 | D16A8 | → 02-1996 | 81613 |
| | 90 | 05/94 → 11/98 | 1.590 | B | M | 4 | 16 | D16A8 | 03-1996 → | 81615 |
| 1.8 i | 107 | 06/96 → 11/98 | 1.796 | B | M | 4 | 16 | 18K4K | | 81615 |
| 1.8 TD | 65 | 09/93 → 11/98 | 1.769 | D | M | 4 | 8 | XUD7TE | | 81672 |
| 2.0 i | 100 | 05/94 → 11/98 | 1.994 | B | M | 4 | 16 | 20T4H | | 81707 |
| 2.0 Turbo GSi Sport | 152 | 10/92 → 04/95 | 1.994 | B | M | 4 | 16 | | | 81707 |
| 414 | 70 | 01/93 → 04/95 | 1.396 | B | M | 4 | 16 | 14K4C | | 81615 |
| 414 GSi/Si | 66 | 04/90 → 04/95 | 1.396 | B | M | 4 | 16 | 14K4C, 14K4D | | 81615 |
| 414 GSi/Si Cat. | 76 | 01/93 → 04/95 | 1.396 | B | M | 4 | 16 | 14K4F | | 81615 |
| 416 GSi | 82 | 04/90 → 04/95 | 1.590 | B | M | 4 | 16 | D16Z2 | | 81613 |
| 416 GSi/GSE | 85 | 04/90 → 04/95 | 1.590 | B | M | 4 | 16 | D16A7 | | 81613 |
| 416 GTi | 90 | 04/90 → 04/95 | 1.590 | B | M | 4 | 16 | D16A8 | | 81613 |
| 416 GTi/GTE | 96 | 04/90 → 04/95 | 1.590 | B | M | 4 | 16 | D16A9 | | 81613 |

KW

cm³

NO. OF VALVES

ROVER
400 I, Station Wagon

| | | | | | | | | | | |
|----------------------|-----|---------------|-------|---|---|---|----|--------|-----------|-------|
| 418 D | 49 | 09/91 → 04/95 | 1.905 | D | M | 4 | 8 | XUD9 | | 81672 |
| 418 TD | 65 | 09/91 → 04/95 | 1.769 | D | M | 4 | 8 | XUD7TE | | 81672 |
| 420 GSI/SLI/GTI/Vite | 100 | 01/93 → 04/95 | 1.994 | B | M | 4 | 16 | 20T4H | | 81707 |
| 420 GTI/GSI/Vitesse | 103 | 02/92 → 04/95 | 1.994 | B | M | 4 | 16 | 20M4F | → 09-1992 | 81843 |
| | 103 | 02/92 → 04/95 | 1.994 | B | M | 4 | 16 | 20M4F | 10-1992 → | 81707 |
| 420 Turbo | 147 | 01/93 → 04/95 | 1.994 | B | M | 4 | 16 | 20T4G | | 81707 |

400 II

| | | | | | | | | | | |
|------------|-----|---------------|-------|---|---|---|----|-------|--|-------|
| 414 Si | 76 | 05/95 → 03/00 | 1.396 | B | M | 4 | 16 | 14K4F | | 81615 |
| 416 Si | 82 | 05/95 → 03/00 | 1.588 | B | M | 4 | 16 | 16K4F | | 81615 |
| | 83 | 05/95 → 03/00 | 1.590 | B | A | 4 | 16 | D16Y2 | | 81615 |
| 420 D | 63 | 11/95 → 03/00 | 1.994 | D | M | 4 | 8 | 20T2R | | 81707 |
| 420 Di | 77 | 05/95 → 03/00 | 1.994 | D | M | 4 | 8 | 20T2N | | 81707 |
| 420 Si Lux | 100 | 12/95 → 03/00 | 1.994 | B | M | 4 | 16 | 20T4H | | 81707 |

600

| | | | | | | | | | | |
|----------------|-----|---------------|-------|---|---|---|----|-------|--|-------|
| 618 i/Si | 85 | 03/96 → 02/99 | 1.850 | B | M | 4 | 16 | F18A3 | | 81708 |
| 620 i | 85 | 08/93 → 06/96 | 1.997 | B | M | 4 | 16 | F20Z2 | | 81708 |
| 620 Sdi | 77 | 12/94 → 02/99 | 1.994 | D | M | 4 | 8 | 20T2N | | 81707 |
| 620 Si | 96 | 08/93 → 02/99 | 1.997 | B | M | 4 | 16 | F20Z1 | | 81708 |
| 620 Ti Vitesse | 147 | 07/94 → 02/99 | 1.994 | B | M | 4 | 16 | 20T4G | | 81707 |
| 623 Si | 116 | 08/93 → 02/99 | 2.259 | B | M | 4 | 16 | H23A3 | | 81709 |

800

| | | | | | | | | | | |
|---------------|-----|---------------|-------|---|---|---|----|------------------------|-------------------|-------|
| 2.0 E | 84 | 10/88 → 10/91 | 1.994 | B | M | 4 | 16 | | → T: 200.604 | 81843 |
| 2.0 Turbo | 120 | 10/88 → 10/91 | 1.994 | B | M | 4 | 16 | | → T: 200.604 | 81843 |
| 820 | 74 | 10/88 → 10/91 | 1.994 | B | M | 4 | 8 | | → T: 200.604 | 81843 |
| 820 16V Turbo | 132 | 01/92 → 02/99 | 1.996 | B | M | 4 | 16 | T16 | | 81707 |
| 820 i/Si | 103 | 10/88 → 12/91 | 1.994 | B | M | 4 | 16 | 20HD | → T: 200.604 | 81843 |
| | 100 | 01/92 → 02/99 | 1.996 | B | M | 4 | 16 | 20T4H | | 81707 |
| 820 SE/SI | 88 | 10/86 → 12/91 | 1.994 | B | M | 4 | 8 | 20HS | → T: 200.604 | 81843 |
| 820 SI | 98 | 10/88 → 12/91 | 1.994 | B | M | 4 | 16 | 20HDM16 | → T: 200.604 | 81843 |
| 820 Sport | 145 | 04/94 → 03/96 | 1.994 | B | M | 4 | 16 | 20T4G | | 81707 |
| 820e | 88 | 10/86 → 10/91 | 1.994 | B | M | 4 | 8 | 20HS | → T: 200.604 | 81843 |
| 825 D/SD | 87 | 01/90 → 02/99 | 2.500 | D | M | 4 | 8 | 425SL1RR, 4924SHIRG | (-)COP, 03-1996 → | 81362 |
| | 87 | 01/90 → 02/99 | 2.500 | D | M | 4 | 8 | 425SL1RR, 4924SHIRG | → 02-1996 | 81302 |
| 825 SD | 87 | 09/93 → 02/99 | 2.500 | D | M | 4 | 8 | 425SL1RR, 4924SHIRG | (-)COP, 03-1996 → | 81362 |
| | 87 | 09/93 → 02/99 | 2.500 | D | M | 4 | 8 | 425SL1RR, 4924SHIRG | → 02-1996 | 81302 |
| 825 Si | 129 | 04/96 → 02/99 | 2.497 | B | M | 6 | 24 | 25K4F | | 81302 |

KW

cm³

NO. OF VALVES

MAGNETI MARELLI

ROVER

Cabriolet

| | | | | | | | | | | |
|--------------|----|---------------|-------|---|---|---|----|--------------|--|-------|
| 214 1.4 | 66 | 01/92 → 11/99 | 1.396 | B | M | 4 | 16 | 14K4C, 14K4D | | 81615 |
| | 70 | 04/90 → 09/92 | 1.396 | B | M | 4 | 16 | 14K4C | | 81615 |
| 214 1.4i 16V | 76 | 01/93 → 11/99 | 1.396 | B | M | 4 | 16 | 14K4F | | 81615 |
| 216 1.6i | 90 | 01/92 → 11/99 | 1.590 | B | M | 4 | 16 | D16A8 | | 81613 |
| 216 1.6i 16V | 82 | 01/96 → 11/99 | 1.588 | B | M | 4 | 16 | 16K4F | | 81613 |

Coupé

| | | | | | | | | | | |
|----------|-----|---------------|-------|---|---|---|----|-------|--|-------|
| 1.6 16 V | 82 | 03/96 → 11/99 | 1.588 | B | M | 4 | 16 | 16K4F | | 81615 |
| 1.8 16 V | 107 | 03/96 → 11/99 | 1.795 | B | M | 4 | 16 | 18K4K | | 81615 |

Mini, Cabrio

| | | | | | | | | | | |
|------|----|---------------|-------|---|---|---|---|--------------|----|-------|
| 1000 | 30 | 01/92 → 06/93 | 999 | B | M | 4 | 8 | 99HD81 | BC | 81419 |
| 1300 | 37 | 10/92 → 11/00 | 1.273 | B | M | 4 | 8 | 12A2B | BC | 81419 |
| | 39 | 01/92 → 04/95 | 1.273 | B | M | 4 | 8 | 12A2D | BC | 81419 |
| | 45 | 01/91 → 12/91 | 1.273 | B | M | 4 | 8 | 12A2A | BC | 81419 |
| | 46 | 09/92 → 04/95 | 1.273 | B | M | 4 | 8 | 12A2E | BC | 81419 |
| | 46 | 01/92 → 11/00 | 1.275 | B | M | 4 | 8 | 12A2E, 12A2L | BC | 81419 |

Streetwise

| | | | | | | | | | | |
|--------|----|---------------|-------|---|---|---|----|-------|--|-------|
| 1.4 | 62 | 08/03 → 05/05 | 1.396 | B | M | 4 | 16 | 14K4M | | 81615 |
| | 76 | 08/03 → 05/05 | 1.396 | B | M | 4 | 16 | 14K4F | | 81615 |
| 2.0 TD | 74 | 08/03 → 05/05 | 1.994 | D | M | 4 | 8 | 20T2N | | 81707 |

SAAB

9-3 I, Cabrio

| | | | | | | | | | | |
|--------------|-----|---------------|-------|---|---|---|----|---------------------|--|-------|
| 2.0 i | 96 | 02/98 → 09/02 | 1.985 | B | M | 4 | 16 | B204I | | 81764 |
| 2.0 SE Turbo | 147 | 02/98 → 09/02 | 1.985 | B | M | 4 | 16 | B204R | | 81764 |
| 2.0 Turbo | 110 | 01/01 → 09/02 | 1.985 | B | M | 4 | 16 | B205E | | 81764 |
| | 113 | 10/98 → 09/02 | 1.985 | B | M | 4 | 16 | B204E | | 81764 |
| | 136 | 02/98 → 09/02 | 1.985 | B | M | 4 | 16 | B204L, B205E, B205L | | 81764 |
| | 151 | 10/99 → 09/02 | 1.985 | B | M | 4 | 16 | B205R | | 81764 |
| 2.2 TiD | 85 | 02/98 → 11/00 | 2.171 | D | M | 4 | 16 | D223L, X22DTH | | 81747 |
| | 92 | 11/00 → 09/02 | 2.171 | D | M | 4 | 16 | D223L | | 81747 |
| 2.3 | 169 | 09/99 → 01/02 | 2.290 | B | M | 4 | 16 | B235R | | 81764 |
| 2.3 i | 110 | 02/98 → 09/02 | 2.290 | B | M | 4 | 16 | B234I | | 81764 |
| 2.3 Turbo | 165 | 10/98 → 09/02 | 2.290 | B | M | 4 | 16 | B235R | | 81764 |

9-3 II, Station Wagon, Cabrio

| | | | | | | | | | | |
|---------------|-----|---------|-------|---|---|---|----|----------------|--|-------|
| 1,8t | 110 | 09/02 → | 1.998 | B | M | 4 | 16 | B207E | | 81812 |
| 1,8t BioPower | 110 | 01/07 → | 1.998 | | M | 4 | 16 | B207E | | 81812 |
| | 129 | 05/09 → | 1.998 | | M | 4 | 16 | B207L | | 81812 |
| 1.8 i | 90 | 01/04 → | 1.796 | B | M | 4 | 16 | Z18XE | | 81751 |
| 1.8t 2.0 | 110 | 03/05 → | 1.998 | B | M | 4 | 16 | B207E | | 81812 |
| 1.9 TiD | 88 | 09/04 → | 1.910 | D | M | 4 | 8 | Z19DT | | 81352 |
| | 110 | 09/04 → | 1.910 | D | M | 4 | 16 | Z19DTH | | 81872 |
| 1.9 TTiD | 132 | 12/07 → | 1.910 | D | M | 4 | 16 | A19DTR, Z19DTR | | 81872 |
| | 132 | 12/07 → | 1.910 | D | M | 4 | 16 | Z19DTR | | 81872 |

KW

cm³

NO. OF VALVES

SAAB
9-3 II, Station Wagon, Cabrio

| | | | | | | | | | | |
|------------------|-----|---------|-------|---|---|---|----|--------------|--|-------|
| 2.0 t | 110 | 03/05 → | 1.998 | B | M | 4 | 16 | B207E | | 81812 |
| | 129 | 08/03 → | 1.998 | B | M | 4 | 16 | B207L | | 81812 |
| | 129 | 09/02 → | 1.998 | B | M | 4 | 16 | B207L, B207M | | 81812 |
| | 147 | 02/09 → | 1.998 | B | M | 4 | 16 | B207M | | 81812 |
| | 154 | 09/02 → | 1.998 | B | M | 4 | 16 | B207R | | 81812 |
| | 177 | 05/09 → | 1.998 | B | M | 4 | 16 | B207R | | 81812 |
| 2.0 t BioPower | 110 | 01/07 → | 1.998 | | M | 4 | 16 | B207E | | 81812 |
| | 129 | 01/07 → | 1.998 | | M | 4 | 16 | B207L | | 81812 |
| | 145 | 06/07 → | 1.998 | | M | 4 | 16 | B207R | | 81812 |
| | 147 | 05/09 → | 1.998 | | M | 4 | 16 | B207M | | 81812 |
| | 154 | 09/02 → | 1.998 | | M | 4 | 16 | B207R | | 81812 |
| 2.0 t XWD | 154 | 06/08 → | 1.998 | B | M | 4 | 16 | B207R | | 81812 |
| 2.0 Turbo XWD | 154 | 01/08 → | 1.998 | B | M | 4 | 16 | B207R | | 81812 |
| 2.2 TiD | 92 | 09/02 → | 2.171 | D | M | 4 | 16 | D223L | | 81747 |
| 2.8 Turbo V6 | 184 | 03/05 → | 2.792 | B | M | 6 | 24 | LP9 | | 84057 |
| | 188 | 12/07 → | 2.792 | B | M | 6 | 24 | B284L | | 84057 |
| | 203 | 04/08 → | 2.792 | B | M | 6 | 24 | B284L | | 84057 |
| | 203 | 02/09 → | 2.792 | B | M | 6 | 24 | B284R | | 84057 |
| | 206 | 02/09 → | 2.792 | B | M | 6 | 24 | B284R | | 84057 |
| 2.8 Turbo V6 XWD | 206 | 05/08 → | 2.792 | B | M | 6 | 24 | B284R | | 84057 |

9-3 X

| | | | | | | | | | | |
|--------------------|-----|---------|-------|---|---|---|----|----------------|--|-------|
| 1.9 TTiD | 132 | 02/09 → | 1.910 | D | M | 4 | 16 | A19DTR, Z19DTR | | 81872 |
| 2.0 t BioPower XWD | 154 | 02/09 → | 1.998 | | M | 4 | 16 | B207R | | 81812 |
| 2.0 t XWD | 154 | 02/09 → | 1.998 | B | M | 4 | 16 | B207R | | 81812 |

9-5 I, Station Wagon

| | | | | | | | | | | |
|----------------|-----|---------------|-------|---|---|---|----|--------|--|-------|
| 1.9 TiD | 110 | 01/06 → 12/09 | 1.910 | D | M | 4 | 16 | Z19DTH | | 81872 |
| 2.0 t | 110 | 09/97 → 12/09 | 1.985 | B | M | 4 | 16 | B205E | | 81764 |
| | 136 | 07/00 → 12/09 | 1.985 | B | M | 4 | 16 | B205L | | 81764 |
| | 141 | 10/98 → 12/09 | 1.985 | B | M | 4 | 16 | B204R | | 81764 |
| 2.0 t Biopower | 132 | 09/05 → 12/09 | 1.985 | | M | 4 | 16 | B205E | | 81764 |
| 2.0 Turbo SE | 141 | 10/98 → 07/00 | 1.985 | B | M | 4 | 16 | B205E | | 81764 |
| 2.2 TiD | 88 | 03/02 → 12/09 | 2.171 | D | M | 4 | 16 | D223L | | 81747 |
| 2.3 t | 125 | 09/97 → 12/09 | 2.290 | B | M | 4 | 16 | B235E | | 81764 |
| | 136 | 01/01 → 12/09 | 2.290 | B | M | 4 | 16 | B235E | | 81764 |
| 2.3 Turbo | 162 | 07/03 → 12/09 | 2.290 | B | M | 4 | 16 | B235L | | 81764 |
| | 169 | 10/99 → 09/01 | 2.290 | B | M | 4 | 16 | B235R | | 81764 |
| | 184 | 09/01 → 12/09 | 2.290 | B | M | 4 | 16 | B235R | | 81764 |
| | 191 | 11/05 → 12/09 | 2.290 | B | M | 4 | 16 | B235R | | 81764 |
| | 224 | 06/03 → 08/05 | 2.290 | B | M | 4 | 16 | B235R | | 81764 |
| 3.0 V6t | 147 | 01/98 → 12/09 | 2.962 | B | A | 6 | 24 | B308E | | 81846 |

KW

cm³

NO. OF VALVES

MAGNETI MARELLI

SAAB

9-5 II, Station Wagon

| | | | | | | | | | | |
|--------------------|-----|---------------|-------|---|---|---|----|--------|--|------------------|
| 1.6 Turbo | 132 | 05/10 → 01/12 | 1.598 | B | M | 4 | 16 | A16LET | | 82083 |
| 2.0 t BioPower | 162 | 05/10 → 01/12 | 1.998 | | M | 4 | 16 | A20NFT | | 81812 |
| 2.0 t BioPower XWD | 162 | 05/10 → 01/12 | 1.998 | | M | 4 | 16 | A20NHT | | 81812 |
| 2.0 TiD | 118 | 05/10 → 01/12 | 1.956 | D | M | 4 | 16 | A20DTH | | 81872 |
| 2.0 TTiD | 140 | 05/10 → 01/12 | 1.956 | D | M | 4 | 16 | A20DTR | | 81872 |
| 2.0 TTiD XWD | 140 | 05/10 → 01/12 | 1.956 | D | M | 4 | 16 | A20DTR | | 81872 |
| 2.0 Turbo | 162 | 05/10 → 01/12 | 1.998 | B | M | 4 | 16 | A20NHT | | 81812 |
| 2.0 Turbo XWD | 162 | 05/10 → 01/12 | 1.998 | B | M | 4 | 16 | A20NHT | | 81812 |
| 2.8 Turbo V6 XWD | 221 | 05/10 → 01/12 | 2.792 | B | M | 6 | 24 | A28NER | | 84057 NEW |

900 II, Cabrio, Coupé

| | | | | | | | | | | |
|---------------|-----|---------------|-------|---|---|---|----|-------|--|-------|
| 2.0 -16 Turbo | 136 | 07/93 → 02/98 | 1.985 | B | M | 4 | 16 | B204L | | 81764 |
| 2.0 i | 96 | 08/94 → 02/98 | 1.985 | B | M | 4 | 16 | B204I | | 81764 |
| | 98 | 07/93 → 07/94 | 1.985 | B | M | 4 | 16 | B206I | | 81764 |
| 2.3 -16 | 110 | 07/93 → 02/98 | 2.290 | B | M | 4 | 16 | B234I | | 81764 |
| 2.5 -24 V6 | 125 | 07/93 → 02/98 | 2.498 | B | M | 6 | 24 | B258I | | 81846 |

9000

| | | | | | | | | | | |
|-------------------|-----|---------------|-------|---|---|---|----|-------|--|-------|
| 3.0 -24 V6 CD/CDE | 155 | 07/94 → 12/98 | 2.962 | B | M | 6 | 24 | B308I | | 81846 |
| | 155 | 07/94 → 12/98 | 2.962 | B | M | 6 | 24 | B308I | | 81846 |

SEAT

Alhambra I

| | | | | | | | | | | |
|-----------------|---------------|---------------|-------|---|---|---|-----|--------------|-------------------|------------------|
| 1.8 T 20V | 110 | 10/97 → 03/10 | 1.781 | B | M | 4 | 20 | AJH, AWC | | 81703 |
| 1.9 TDI | 66 | 04/96 → 03/10 | 1.896 | D | M | 4 | 8 | 1Z, AHU, ANU | (-)COP, → 07-2000 | 81522 |
| | 66 | 04/96 → 03/10 | 1.896 | D | M | 4 | 8 | 1Z, AHU, ANU | (+)COP | 82080 |
| | 66 | 04/96 → 03/10 | 1.896 | D | M | 4 | 8 | 1Z, AHU, ANU | (+)COP, → 07-2000 | 82080 |
| | 66 | 04/96 → 03/10 | 1.896 | D | M | 4 | 8 | 1Z, AHU, ANU | 08-2000 → | 81816 |
| | 66 | 04/96 → 03/10 | 1.896 | D | M | 4 | 8 | 1Z, AHU, ANU | | 84011 NEW |
| | 81 | 08/96 → 06/00 | 1.896 | D | M | 4 | 8 | AFN, AVG | (-)COP | 81522 |
| | 81 | 08/96 → 06/00 | 1.896 | D | M | 4 | 8 | AFN, AVG | (+)COP | 82080 |
| | 85 | 06/00 → 03/10 | 1.896 | D | M | 4 | 8 | AUY, BVK | | 81816 |
| | 85 | 06/00 → 03/10 | 1.896 | D | M | 4 | 8 | AUY, BVK | | 84011 NEW |
| | 96 | 11/02 → 11/08 | 1.896 | D | M | 4 | 8 | ASZ | | 84010 NEW |
| | 96 | 11/02 → 11/08 | 1.896 | D | M | 4 | 8 | ASZ | | 81791 |
| | 110 | 05/05 → 05/07 | 1.896 | D | M | 4 | 8 | BTB | | 81816 |
| 110 | 05/05 → 05/07 | 1.896 | D | M | 4 | 8 | BTB | | 84011 NEW | |
| 1.9 TDI 4motion | 85 | 06/00 → 03/10 | 1.896 | D | M | 4 | 8 | AUY, BVK | | 81816 |
| | 85 | 06/00 → 03/10 | 1.896 | D | M | 4 | 8 | AUY, BVK | | 84011 NEW |
| 1.9 Tdi 4x4 | 96 | 06/05 → 11/08 | 1.896 | D | M | 4 | 8 | ASZ | | 84010 NEW |
| | 96 | 06/05 → 11/08 | 1.896 | D | M | 4 | 8 | ASZ | | 81791 |

KW

cm³

NO. OF VALVES

SEAT
Alhambra I

| | | | | | | | | | | |
|----------------|-----|---------------|-------|---|----|---|----|----------|---------------------------|------------------|
| 2.0 i | 85 | 04/96 → 03/10 | 1.984 | B | AM | 4 | 8 | ADY, ATM | (-)COP, → 07-2000, M: ADY | 81522 |
| | 85 | 04/96 → 03/10 | 1.984 | B | AM | 4 | 8 | ADY, ATM | (+)COP | 82080 |
| | 85 | 04/96 → 03/10 | 1.984 | B | AM | 4 | 8 | ADY, ATM | (+)COP, → 07-2000, M: ADY | 82080 |
| | 85 | 04/96 → 03/10 | 1.984 | B | AM | 4 | 8 | ADY, ATM | 08-2000 →, M: ATM | 81703 |
| 2.0 TDI | 103 | 11/05 → 03/10 | 1.968 | D | M | 4 | 8 | BRT | | 81816 |
| | 103 | 11/05 → 03/10 | 1.968 | D | M | 4 | 8 | BRT | | 84011 NEW |
| 2.8 V6 | 150 | 06/00 → 03/10 | 2.792 | B | M | 6 | 24 | AUE, AYL | | 81866 |
| 2.8 V6 4motion | 150 | 06/00 → 03/10 | 2.792 | B | M | 6 | 24 | AUE, AYL | | 81866 |

Alhambra II

| | | | | | | | | | | |
|----------------|-----|---------------|-------|---|---|---|----|------|--|------------------|
| 1.4 TSI | 110 | 05/15 → | 1.395 | B | M | 4 | 16 | CZDA | | 84062 NEW |
| 2.0 TDI | 85 | 05/11 → | 1.968 | D | M | 4 | 16 | CFFE | | 84001 |
| | 100 | 06/10 → 05/11 | 1.968 | D | M | 4 | 16 | CFFA | | 84001 |
| | 103 | 06/10 → | 1.968 | D | M | 4 | 16 | CFFB | | 84001 |
| | 125 | 06/10 → | 1.968 | D | M | 4 | 16 | CFGB | | 84001 |
| | 130 | 11/12 → | 1.968 | D | M | 4 | 16 | CFGC | | 84001 |
| 2.0 TDI 4Drive | 103 | 05/11 → | 1.968 | D | M | 4 | 16 | CFFB | | 84001 |
| 2.0 TSI | 147 | 11/10 → | 1.984 | B | M | 4 | 16 | CCZA | | 84016 NEW |
| | 162 | 05/15 → | 1.984 | B | M | 4 | 16 | DEDA | | 84037 NEW |

Altea, Altea XL

| | | | | | | | | | | |
|---------------|-----|---------|-------|---|---|---|----|---------------------------|--|------------------|
| 1.2 TSI | 77 | 04/10 → | 1.197 | B | M | 4 | 8 | CBZB | | 84045 NEW |
| 1.4 16V | 63 | 05/06 → | 1.390 | B | M | 4 | 16 | BXW, CGGB | | 81777 |
| 1.4 TSI | 92 | 11/07 → | 1.390 | B | M | 4 | 16 | CAXC | | 82097 |
| 1.6 | 75 | 03/04 → | 1.595 | B | M | 4 | 8 | BGU, BSE, BSF, CCSA, CMXA | | 81702 |
| | 75 | 10/06 → | 1.595 | B | M | 4 | 8 | BSE, BSF, CCSA, CMXA | | 81702 |
| 1.6 LPG | 75 | 09/09 → | 1.595 | | M | 4 | 8 | CHGA | | 81702 |
| 1.6 Multifuel | 75 | 10/06 → | 1.595 | | M | 4 | 8 | CCSA | | 81702 |
| 1.6 TDI | 66 | 11/10 → | 1.598 | D | M | 4 | 16 | CAYB | | 84001 |
| | 77 | 10/09 → | 1.598 | D | M | 4 | 16 | CAYC | | 84001 |
| 1.8 TFSI | 118 | 01/07 → | 1.798 | B | M | 4 | 16 | BYT, BZB, CDAA | → 05-2007, → T: 5P7084000 | 84016 NEW |
| | 118 | 01/07 → | 1.798 | B | M | 4 | 16 | BYT, BZB, CDAA | 06-2007 →, → 05-2007, T →: 5P7084001, → T: 5P7084000 | 84016 NEW |
| 1.9 TDI | 66 | 08/09 → | 1.896 | D | M | 4 | 8 | BXF | | 84010 NEW |
| | 66 | 08/09 → | 1.896 | D | M | 4 | 8 | BXF | | 81791 |
| | 77 | 04/04 → | 1.896 | D | M | 4 | 8 | BJB, BKC, BLS, BXE | | 84010 NEW |
| | 77 | 04/04 → | 1.896 | D | M | 4 | 8 | BJB, BKC, BLS, BXE | | 81791 |
| | 77 | 10/06 → | 1.896 | D | M | 4 | 8 | BKC, BLS, BXE | | 84010 NEW |
| | 77 | 10/06 → | 1.896 | D | M | 4 | 8 | BKC, BLS, BXE | | 81791 |

KW

cm³

NO. OF VALVES

MAGNETI MARELLI
SEAT
Altea, Altea XL

| | | | | | | | | | | |
|-----------------|-----|---------------|-------|---|---|---|----|--------------------|--|------------------|
| 2.0 FSI | 110 | 05/04 → 03/09 | 1.984 | B | M | 4 | 16 | BLR, BLY, BVY, BVZ | | 81702 |
| | 110 | 10/06 → 03/09 | 1.984 | B | M | 4 | 16 | BVY, BVZ | | 81702 |
| 2.0 TDI | 100 | 03/04 → 05/09 | 1.968 | D | M | 4 | 16 | AZV | | 81816 |
| | 100 | 03/04 → 05/09 | 1.968 | D | M | 4 | 16 | AZV | | 84011 NEW |
| | 103 | 11/05 → | 1.968 | D | M | 4 | 8 | BMM | | 81816 |
| | 103 | 11/05 → | 1.968 | D | M | 4 | 8 | BMM | | 84011 NEW |
| | 125 | 03/06 → | 1.968 | D | M | 4 | 16 | BMN, CEGA | | 81816 |
| | 125 | 03/06 → | 1.968 | D | M | 4 | 16 | BMN, CEGA | | 84011 NEW |
| 2.0 TDI 16V | 103 | 03/04 → | 1.968 | D | M | 4 | 16 | BKD, CFHC | | 81816 |
| | 103 | 03/04 → | 1.968 | D | M | 4 | 16 | BKD, CFHC | | 84011 NEW |
| 2.0 TDI 16V 4x4 | 103 | 10/10 → | 1.968 | D | M | 4 | 16 | CFHC | | 84001 |
| 2.0 TDI 4x4 | 103 | 06/07 → | 1.968 | D | M | 4 | 8 | BMM | | 81816 |
| | 103 | 06/07 → | 1.968 | D | M | 4 | 8 | BMM | | 84011 NEW |
| | 125 | 06/07 → | 1.968 | D | M | 4 | 16 | BMN, CEGA, CFJA | | 81816 |
| | 125 | 06/07 → | 1.968 | D | M | 4 | 16 | BMN, CEGA, CFJA | | 84011 NEW |
| 2.0 TFSI | 147 | 04/06 → 05/09 | 1.984 | B | M | 4 | 16 | BWA | | 82025 |
| 2.0 TFSI 4x4 | 147 | 06/07 → 05/09 | 1.984 | B | M | 4 | 16 | BWA | | 82025 |
| | 155 | 05/09 → | 1.984 | B | M | 4 | 16 | CCZB | | 84016 NEW |

Arosa

| | | | | | | | | | | |
|---------|----|---------------|-------|---|----|---|----|------------------------------|--|------------------|
| 1.0 | 37 | 10/98 → 01/01 | 997 | B | M | 4 | 8 | AHT | | 81807 |
| | 37 | 05/97 → 06/04 | 999 | B | M | 4 | 8 | AER, ALD, ALL, ANV, AUC | → 11-1999, M: AHT | 81807 |
| | 37 | 05/97 → 06/04 | 999 | B | M | 4 | 8 | AER, ALD, ALL, ANV, AUC | M: ALD, M: AER, M: ALL, M: ALD, M: AUC, M: AER | 81775 |
| 1.4 | 44 | 05/97 → 06/04 | 1.390 | B | AM | 4 | 8 | AEX, AKK, AKV, ANW, APQ, AUD | → 11-1999 | 81527 |
| | 44 | 05/97 → 06/04 | 1.390 | B | AM | 4 | 8 | AEX, AKK, AKV, ANW, APQ, AUD | 12-1999 →, M: AUD, M: ANW, M: AUD | 81775 |
| 1.4 16V | 74 | 01/00 → 06/04 | 1.390 | B | M | 4 | 16 | AFK, AQQ, AUB | | 81777 |
| 1.4 TDI | 55 | 01/00 → 06/04 | 1.422 | D | M | 3 | 6 | AMF | | 84010 NEW |
| | 55 | 01/00 → 06/04 | 1.422 | D | M | 3 | 6 | AMF | | 81791 |
| 1.7 SDI | 44 | 08/97 → 06/04 | 1.716 | D | M | 4 | 8 | AKU | | 81528 |

Cordoba I, Vario

| | | | | | | | | | | |
|-----------|----|---------------|-------|---|---|---|----|--------------------|-----------|-------|
| 1.0 i | 37 | 09/96 → 06/99 | 999 | B | M | 4 | 8 | AER | | 81775 |
| 1.4 i | 44 | 06/94 → 06/99 | 1.390 | B | M | 4 | 8 | ABD, AEX, AKV, APQ | → 05-1996 | 81524 |
| | 44 | 06/94 → 06/99 | 1.390 | B | M | 4 | 8 | ABD, AEX, AKV, APQ | 06-1996 → | 81527 |
| | 44 | 09/96 → 06/99 | 1.390 | B | M | 4 | 8 | AEX, AKV, APQ | 05-1997 → | 81527 |
| 1.4 i 16V | 74 | 09/96 → 06/99 | 1.390 | B | M | 4 | 16 | AFH | | 81776 |



KW



cm³



NO. OF VALVES



MAGNETI MARELLI

SEAT

Cordoba I, Vario

| | | | | | | | | | | |
|-----------|-----|---------------|-------|---|---|---|----|---------------|-------------------|-------|
| 1.6 i | 55 | 05/94 → 06/99 | 1.595 | B | M | 4 | 8 | 1F | (-)COP | 81522 |
| | 55 | 05/94 → 06/99 | 1.595 | B | M | 4 | 8 | 1F | (+)COP | 82080 |
| | 74 | 09/96 → 06/99 | 1.595 | B | M | 4 | 8 | AFT | (-)COP | 81522 |
| | 74 | 09/96 → 06/99 | 1.595 | B | M | 4 | 8 | AFT | (+)COP | 82080 |
| | 74 | 07/96 → 10/99 | 1.595 | B | M | 4 | 8 | AFT, AKL | (-)COP | 81522 |
| | 74 | 07/96 → 10/99 | 1.595 | B | M | 4 | 8 | AFT, AKL | (+)COP | 82080 |
| | 55 | 02/93 → 06/99 | 1.598 | B | M | 4 | 8 | ABU, AEE, ALM | | 81524 |
| | 55 | 09/96 → 06/99 | 1.598 | B | M | 4 | 8 | AEE, ALM | (-)COP | 81522 |
| | 55 | 09/96 → 06/99 | 1.598 | B | M | 4 | 8 | AEE, ALM | (+)COP | 82080 |
| 1.8 i | 66 | 02/93 → 06/99 | 1.781 | B | M | 4 | 8 | ABS, ACC, ADZ | (-)COP, 10-1993 → | 81522 |
| | 66 | 02/93 → 06/99 | 1.781 | B | M | 4 | 8 | ABS, ACC, ADZ | (+)COP | 82080 |
| | 66 | 02/93 → 06/99 | 1.781 | B | M | 4 | 8 | ABS, ACC, ADZ | (+)COP, 10-1993 → | 82080 |
| 1.8 i 16V | 95 | 10/93 → 08/96 | 1.781 | B | M | 4 | 16 | ADL | (-)COP, 10-1993 → | 81522 |
| | 95 | 10/93 → 08/96 | 1.781 | B | M | 4 | 16 | ADL | (+)COP | 82080 |
| | 95 | 10/93 → 08/96 | 1.781 | B | M | 4 | 16 | ADL | (+)COP, 10-1993 → | 82080 |
| 1.9 D | 47 | 01/96 → 08/96 | 1.896 | D | M | 4 | 8 | 1Y | (-)COP, 06-1996 → | 81522 |
| | 47 | 01/96 → 08/96 | 1.896 | D | M | 4 | 8 | 1Y | (+)COP | 82080 |
| | 47 | 01/96 → 08/96 | 1.896 | D | M | 4 | 8 | 1Y | (+)COP, 06-1996 → | 82080 |
| | 50 | 02/93 → 08/96 | 1.896 | D | M | 4 | 8 | 1Y | (-)COP, 10-1993 → | 81522 |
| | 50 | 02/93 → 08/96 | 1.896 | D | M | 4 | 8 | 1Y | (+)COP | 82080 |
| | 50 | 02/93 → 08/96 | 1.896 | D | M | 4 | 8 | 1Y | (+)COP, 10-1993 → | 82080 |
| 1.9 SDI | 47 | 08/96 → 06/99 | 1.896 | D | M | 4 | 8 | AEY | (-)COP, 05-1997 → | 81522 |
| | 47 | 08/96 → 06/99 | 1.896 | D | M | 4 | 8 | AEY | (+)COP | 82080 |
| | 47 | 08/96 → 06/99 | 1.896 | D | M | 4 | 8 | AEY | (+)COP, 05-1997 → | 82080 |
| | 47 | 09/96 → 06/99 | 1.896 | D | M | 4 | 8 | AEY | (-)COP | 81522 |
| 1.9 TD | 55 | 02/93 → 08/96 | 1.896 | D | M | 4 | 8 | AAZ | (-)COP, 10-1993 → | 81522 |
| | 55 | 02/93 → 08/96 | 1.896 | D | M | 4 | 8 | AAZ | (+)COP | 82080 |
| | 55 | 02/93 → 08/96 | 1.896 | D | M | 4 | 8 | AAZ | (+)COP, 10-1993 → | 82080 |
| 1.9 TDI | 66 | 08/96 → 06/99 | 1.896 | D | M | 4 | 8 | 1Z, AHU | (-)COP | 81522 |
| | 66 | 08/96 → 06/99 | 1.896 | D | M | 4 | 8 | 1Z, AHU | (-)COP, 06-1996 → | 81522 |
| | 66 | 08/96 → 06/99 | 1.896 | D | M | 4 | 8 | 1Z, AHU | (+)COP | 82080 |
| | 66 | 08/96 → 06/99 | 1.896 | D | M | 4 | 8 | 1Z, AHU | (+)COP, 06-1996 → | 82080 |
| | 81 | 03/97 → 06/99 | 1.896 | D | M | 4 | 8 | AFN | (-)COP, 05-1997 → | 81522 |
| | 81 | 03/97 → 06/99 | 1.896 | D | M | 4 | 8 | AFN | (+)COP | 82080 |
| | 81 | 03/97 → 06/99 | 1.896 | D | M | 4 | 8 | AFN | (+)COP, 05-1997 → | 82080 |
| | 81 | 07/97 → 06/99 | 1.896 | D | M | 4 | 8 | AFN | (-)COP | 81522 |
| 2.0 i | 85 | 02/93 → 06/99 | 1.984 | B | M | 4 | 8 | 2E, AGG | (-)COP, 10-1993 → | 81522 |
| | 85 | 02/93 → 06/99 | 1.984 | B | M | 4 | 8 | 2E, AGG | (+)COP | 82080 |
| | 85 | 02/93 → 06/99 | 1.984 | B | M | 4 | 8 | 2E, AGG | (+)COP, 10-1993 → | 82080 |
| 2.0 i 16V | 110 | 08/96 → 06/99 | 1.984 | B | M | 4 | 16 | ABF | (-)COP, 02-1997 → | 81522 |
| | 110 | 08/96 → 06/99 | 1.984 | B | M | 4 | 16 | ABF | (+)COP | 82080 |
| | 110 | 08/96 → 06/99 | 1.984 | B | M | 4 | 16 | ABF | (+)COP, 02-1997 → | 82080 |

KW

cm³

NO. OF VALVES

MAGNETI MARELLI
SEAT
Cordoba II, Vario

| | | | | | | | | | |
|-----------------|-----|---------------|-------|---|---|---|----|--------------------|-------|
| 1.0 | 37 | 06/99 → 10/02 | 999 | B | M | 4 | 8 | ALD, ANV, AUC | 81775 |
| 1.4 | 44 | 06/99 → 10/02 | 1.390 | B | M | 4 | 8 | AKK, ANW, AUD | 81775 |
| 1.4 16V | 55 | 05/00 → 10/02 | 1.390 | B | M | 4 | 16 | APE, AUA | 81777 |
| | 74 | 02/00 → 10/02 | 1.390 | B | M | 4 | 16 | AQQ, AUB | 81777 |
| 1.6 | 74 | 06/99 → 10/02 | 1.595 | B | M | 4 | 8 | AEH, AKL, APF, AUR | 81702 |
| | 55 | 06/99 → 12/02 | 1.598 | B | M | 4 | 8 | ABU, ALM | 81527 |
| | 55 | 06/99 → 10/02 | 1.598 | B | M | 4 | 8 | ALM | 81527 |
| 1.8 T 20V Cupra | 115 | 07/00 → 10/02 | 1.781 | B | M | 4 | 20 | AQX, AYP | 81703 |
| 1.9 SDI | 50 | 06/99 → 10/02 | 1.896 | D | M | 4 | 8 | AGP, AQM | 81706 |
| 1.9 TDI | 66 | 06/99 → 10/02 | 1.896 | D | M | 4 | 8 | AGR, AHU, ALH | 81706 |
| | 66 | 06/99 → 12/02 | 1.896 | D | M | 4 | 8 | AGR, ALH | 81706 |
| | 81 | 06/99 → 10/02 | 1.896 | D | M | 4 | 8 | ASK, ASV | 81706 |

Cordoba III, Vario

| | | | | | | | | | |
|---------|----|---------------|-------|---|----|---|----|---------------|------------------|
| 1.2 | 47 | 10/02 → 06/06 | 1.198 | B | M | 3 | 12 | AZQ, BME | 81867 |
| 1.2 12V | 51 | 05/06 → 11/09 | 1.198 | B | M | 3 | 12 | BXV | 81867 |
| 1.4 16V | 55 | 09/02 → 12/07 | 1.390 | B | AM | 4 | 16 | BBY, BKY | 81777 |
| | 63 | 05/06 → 11/09 | 1.390 | B | M | 4 | 16 | BXW | 81777 |
| | 74 | 10/02 → 11/09 | 1.390 | B | M | 4 | 16 | AUB, BBZ | 81777 |
| 1.4 TDI | 51 | 05/05 → 11/09 | 1.422 | D | M | 3 | 6 | BNM | 84010 NEW |
| | 51 | 05/05 → 11/09 | 1.422 | D | M | 3 | 6 | BNM | 81791 |
| | 55 | 10/02 → 12/05 | 1.422 | D | M | 3 | 6 | AMF | 84010 NEW |
| | 55 | 10/02 → 12/05 | 1.422 | D | M | 3 | 6 | AMF | 81791 |
| | 59 | 06/05 → 11/09 | 1.422 | D | M | 3 | 6 | BMS, BNV | 84010 NEW |
| | 59 | 06/05 → 11/09 | 1.422 | D | M | 3 | 6 | BMS, BNV | 81791 |
| 1.6 | 74 | 04/03 → 11/09 | 1.598 | B | M | 4 | 8 | BAH | 81527 |
| 1.6 16V | 77 | 11/06 → 11/09 | 1.598 | B | M | 4 | 16 | BTS | 81865 |
| 1.9 SDI | 47 | 09/02 → 11/09 | 1.896 | D | M | 4 | 8 | ASY | 82013 |
| | 74 | 09/02 → 11/09 | 1.896 | D | M | 4 | 8 | ATD, AXR, BMT | 84010 NEW |
| | 74 | 09/02 → 11/09 | 1.896 | D | M | 4 | 8 | ATD, AXR, BMT | 81791 |
| | 96 | 10/02 → 11/09 | 1.896 | D | M | 4 | 8 | ASZ, BLT | 84010 NEW |
| | 96 | 10/02 → 11/09 | 1.896 | D | M | 4 | 8 | ASZ, BLT | 81791 |
| 2.0 | 85 | 09/02 → 11/09 | 1.984 | B | M | 4 | 8 | AZL, BBX | 81703 |

Exeo, Exeo ST

| | | | | | | | | | |
|---------|-----|---------------|-------|---|---|---|----|------------|------------------|
| 1.6 | 75 | 03/09 → 09/10 | 1.595 | B | M | 4 | 8 | ALZ | 81702 |
| 1.8 T | 110 | 12/08 → 05/10 | 1.781 | B | M | 4 | 20 | CFMA | 81702 |
| 1.8 TSI | 88 | 09/10 → | 1.798 | B | M | 4 | 16 | CDHA | 84016 NEW |
| | 118 | 05/10 → | 1.798 | B | M | 4 | 16 | CDHB | 84016 NEW |
| 2.0 TDI | 88 | 12/08 → | 1.968 | D | M | 4 | 16 | CAGC, CJCC | 81816 |
| | 88 | 12/08 → | 1.968 | D | M | 4 | 16 | CAGC, CJCC | 84011 NEW |
| | 105 | 12/08 → | 1.968 | D | M | 4 | 16 | CAGA, CJCA | 81816 |
| | 105 | 12/08 → | 1.968 | D | M | 4 | 16 | CAGA, CJCA | 84011 NEW |
| | 125 | 02/09 → | 1.968 | D | M | 4 | 16 | CAHA, CGLB | 81816 |
| | 125 | 02/09 → | 1.968 | D | M | 4 | 16 | CAHA, CGLB | 84011 NEW |

KW

cm³

NO. OF VALVES

SEAT
Exeo, Exeo ST

| | | | | | | | | | | |
|----------|-----|---------|-------|---|---|---|----|------|--|------------------|
| 2.0 TFSI | 147 | 03/09 → | 1.984 | B | M | 4 | 16 | BWE | | 82025 |
| | 155 | 05/10 → | 1.984 | B | M | 4 | 16 | CDND | | 84016 NEW |

Ibiza I

| | | | | | | | | | | |
|------------|----|---------------|-------|---|---|---|---|----------------|---------------------------------|-------|
| 0.9 | 29 | 08/90 → 05/93 | 903 | B | M | 4 | 8 | 09NCA, 146A000 | | 81415 |
| | 32 | 08/86 → 05/93 | 903 | B | M | 4 | 8 | 146A000 | 09-1984 →, → 12-1992 | 81415 |
| 1.2 | 44 | 11/84 → 12/93 | 1.193 | B | M | 4 | 8 | 021A1000 | | 81498 |
| | 46 | 11/84 → 12/93 | 1.193 | B | M | 4 | 8 | 021A1000 | | 81498 |
| 1.2 i | 52 | 01/89 → 05/93 | 1.193 | B | M | 4 | 8 | 021C.1000 | | 81498 |
| 1.5 | 63 | 11/84 → 05/93 | 1.461 | B | M | 4 | 8 | 021A2000 | | 81498 |
| 1.5 i | 65 | 10/86 → 05/93 | 1.461 | B | M | 4 | 8 | 021D.2000 | | 81498 |
| | 74 | 10/86 → 05/93 | 1.461 | B | M | 4 | 8 | 021B.2000 | | 81498 |
| 1.5 i Cat. | 66 | 10/86 → 05/93 | 1.461 | B | M | 4 | 8 | 021C.2000 | | 81498 |
| 1.7 | 72 | 01/91 → 05/93 | 1.675 | B | M | 4 | 8 | 021A.3000 | | 81498 |
| | 76 | 01/91 → 05/93 | 1.675 | B | M | 4 | 8 | 021B.3000 | | 81498 |
| 1.7 D | 40 | 06/84 → 05/93 | 1.714 | D | M | 4 | 8 | 022A.5000 | (+)COP, 01-1990 → | 81497 |
| | 42 | 08/90 → 05/93 | 1.714 | D | M | 4 | 8 | 022A.5000 | (+)COP, 01-1990 →, → 12-1993 | 81497 |

Ibiza II

| | | | | | | | | | | |
|-----------|----|---------------|-------|---|---|---|----|--------------------|------------------------------|-------|
| 1.0 | 33 | 03/93 → 09/96 | 1.043 | B | M | 4 | 8 | AAU | | 81524 |
| 1.0 i | 37 | 09/96 → 08/99 | 999 | B | M | 4 | 8 | AER | | 81775 |
| 1.3 i | 40 | 03/93 → 08/99 | 1.272 | B | M | 4 | 8 | 2G, AAV | | 81524 |
| 1.4 | 40 | 12/97 → 04/99 | 1.390 | B | M | 4 | 8 | ANX | | 81527 |
| 1.4 i | 44 | 09/93 → 08/99 | 1.390 | B | M | 4 | 8 | ABD, AEX, AKV, APQ | → 07-1996, M: ABD | 81524 |
| | 44 | 09/93 → 08/99 | 1.390 | B | M | 4 | 8 | ABD, AEX, AKV, APQ | 08-1996 →, M: AEX | 81527 |
| 1.4 i 16V | 74 | 06/97 → 08/99 | 1.390 | B | M | 4 | 16 | AFH | | 81527 |
| 1.6 i | 55 | 09/94 → 06/99 | 1.595 | B | M | 4 | 8 | 1F | (-)COP | 81522 |
| | 55 | 09/94 → 06/99 | 1.595 | B | M | 4 | 8 | 1F | (+)COP | 82080 |
| | 74 | 04/96 → 08/99 | 1.595 | B | M | 4 | 8 | AFT | (-)COP | 81522 |
| | 74 | 04/96 → 08/99 | 1.595 | B | M | 4 | 8 | AFT | (+)COP | 82080 |
| | 55 | 03/93 → 08/99 | 1.598 | B | M | 4 | 8 | ABU, AEE, ALM | (-)COP, 01-1995 →, M: AEE | 81522 |
| | 55 | 03/93 → 08/99 | 1.598 | B | M | 4 | 8 | ABU, AEE, ALM | (+)COP | 82080 |
| | 55 | 03/93 → 08/99 | 1.598 | B | M | 4 | 8 | ABU, AEE, ALM | (+)COP, 01-1995 →, M: AEE | 82080 |
| | 55 | 03/93 → 08/99 | 1.598 | B | M | 4 | 8 | ABU, AEE, ALM | → 12-1994, M: ABU | 81524 |
| 1.8 i | 66 | 03/93 → 08/99 | 1.781 | B | M | 4 | 8 | ABS, ACC, ADZ | (-)COP, 01-1993 → | 81522 |
| | 66 | 03/93 → 08/99 | 1.781 | B | M | 4 | 8 | ABS, ACC, ADZ | (+)COP | 82080 |
| | 66 | 03/93 → 08/99 | 1.781 | B | M | 4 | 8 | ABS, ACC, ADZ | (+)COP, 01-1993 → | 82080 |
| | 95 | 11/93 → 08/96 | 1.781 | B | M | 4 | 16 | ADL | (-)COP | 81522 |
| | 95 | 11/93 → 08/96 | 1.781 | B | M | 4 | 16 | ADL | (+)COP | 82080 |

KW

cm³

NO. OF VALVES

SEAT
Ibiza II

| | | | | | | | | | | |
|-----------|-----|---------------|-------|---|---|---|----|---------|-------------------|-------|
| 1.9 D | 47 | 04/93 → 08/96 | 1.896 | D | M | 4 | 8 | 1Y, AEY | (-)COP | 81522 |
| | 47 | 04/93 → 08/96 | 1.896 | D | M | 4 | 8 | 1Y, AEY | (+)COP | 82080 |
| | 50 | 10/94 → 08/96 | 1.896 | D | M | 4 | 8 | 1Y | (-)COP | 81522 |
| | 50 | 10/94 → 08/96 | 1.896 | D | M | 4 | 8 | 1Y | (+)COP | 82080 |
| 1.9 SDI | 47 | 08/96 → 08/99 | 1.896 | D | M | 4 | 8 | AEY | (-)COP | 81522 |
| | 47 | 08/96 → 08/99 | 1.896 | D | M | 4 | 8 | AEY | (+)COP | 82080 |
| 1.9 TD | 55 | 03/93 → 08/96 | 1.896 | D | M | 4 | 8 | AAZ | (-)COP, 06-1994 → | 81522 |
| | 55 | 03/93 → 08/96 | 1.896 | D | M | 4 | 8 | AAZ | (+)COP | 82080 |
| 1.9 TDI | 66 | 08/96 → 08/99 | 1.896 | D | M | 4 | 8 | 1Z, AHU | | 81528 |
| | 81 | 02/97 → 08/99 | 1.896 | D | M | 4 | 8 | AFN | | 81528 |
| 2.0 i | 85 | 03/93 → 08/99 | 1.984 | B | M | 4 | 8 | 2E, AGG | (-)COP | 81522 |
| | 85 | 03/93 → 08/99 | 1.984 | B | M | 4 | 8 | 2E, AGG | (+)COP | 82080 |
| 2.0 i 16V | 110 | 08/96 → 08/99 | 1.984 | B | M | 4 | 16 | ABF | (-)COP | 81522 |
| | 110 | 08/96 → 08/99 | 1.984 | B | M | 4 | 16 | ABF | (+)COP | 82080 |

Ibiza III

| | | | | | | | | | | |
|-----------------|-----|---------------|-------|---|---|---|----|--------------------|--|-------|
| 1.0 | 37 | 08/99 → 02/02 | 999 | B | M | 4 | 8 | ALD, ANV, AUC | | 81775 |
| 1.0 16V | 51 | 10/99 → 02/02 | 999 | B | M | 4 | 16 | AST, AVZ | | 81776 |
| 1.4 | 44 | 08/99 → 02/02 | 1.390 | B | M | 4 | 8 | AKK, ANW, AUD | | 81775 |
| 1.4 16V | 55 | 05/00 → 02/02 | 1.390 | B | M | 4 | 16 | APE, AUA | | 81777 |
| | 74 | 08/99 → 02/02 | 1.390 | B | M | 4 | 16 | AQQ, AUB | | 81777 |
| 1.6 | 74 | 08/99 → 02/02 | 1.595 | B | M | 4 | 8 | AEH, AKL, APF, AUR | | 81702 |
| | 55 | 08/99 → 02/02 | 1.598 | B | M | 4 | 8 | ALM | | 81527 |
| 1.8 T 20V Cupra | 115 | 07/00 → 02/02 | 1.781 | B | M | 4 | 20 | AQX, AYP | | 81703 |
| 1.9 SDI | 50 | 08/99 → 02/02 | 1.896 | D | M | 4 | 8 | AGP, AQM | | 81706 |
| 1.9 TDI | 66 | 08/99 → 02/02 | 1.896 | D | M | 4 | 8 | AGR, ALH | | 81706 |
| | 81 | 08/99 → 02/02 | 1.896 | D | M | 4 | 8 | ASK, ASV | | 81706 |

Ibiza IV

| | | | | | | | | | | | |
|---------------|-----|---------------|-------|---|----|---|----|----------|----------------|-------|------------|
| 1.2 | 44 | 06/07 → 05/08 | 1.198 | B | M | 3 | 6 | BBM | | 81867 | |
| | 47 | 02/02 → 06/06 | 1.198 | B | M | 3 | 12 | AZQ, BME | | 81867 | |
| 1.2 12V | 51 | 05/06 → 11/09 | 1.198 | B | M | 3 | 12 | BXV | | 81867 | |
| 1.4 16V | 55 | 02/02 → 12/07 | 1.390 | B | AM | 4 | 16 | BBY, BKY | | 81777 | |
| | 63 | 05/06 → 11/09 | 1.390 | B | M | 4 | 16 | BXW | | 81777 | |
| | 74 | 02/02 → 11/09 | 1.390 | B | M | 4 | 16 | AUB, BBZ | | 81777 | |
| 1.4 TDI | 51 | 05/05 → 11/09 | 1.422 | D | M | 3 | 6 | BNM | | 84010 | NEW |
| | 51 | 05/05 → 11/09 | 1.422 | D | M | 3 | 6 | BNM | | 81791 | |
| | 55 | 05/02 → 12/05 | 1.422 | D | M | 3 | 6 | AMF | | 84010 | NEW |
| | 55 | 05/02 → 12/05 | 1.422 | D | M | 3 | 6 | AMF | | 81791 | |
| | 59 | 06/05 → 11/09 | 1.422 | D | M | 3 | 6 | BMS, BNV | | 84010 | NEW |
| | 59 | 06/05 → 11/09 | 1.422 | D | M | 3 | 6 | BMS, BNV | | 81791 | |
| 1.6 | 74 | 02/03 → 11/09 | 1.598 | B | M | 4 | 8 | BAH | | 81527 | |
| 1.6 16V | 77 | 11/06 → 11/09 | 1.598 | B | M | 4 | 16 | BTS | | 81865 | |
| 1.8 T Cupra R | 132 | 01/04 → 02/08 | 1.781 | B | M | 4 | 20 | BBU, BLZ | | 81703 | |
| 1.8 T FR | 110 | 12/03 → 05/08 | 1.781 | B | M | 4 | 20 | BJX, BKV | | 81703 | |
| 1.9 SDI | 47 | 02/02 → 12/05 | 1.896 | D | M | 4 | 8 | ASY | → T: 6L3000000 | 84052 | NEW |

KW

cm³

NO. OF VALVES

SEAT
Ibiza IV

| | | | | | | | | | | | |
|-----------------|-----|---------------|-------|---|---|---|---|---------------|--|-------|------------|
| 1.9 TDI | 74 | 02/02 → 11/09 | 1.896 | D | M | 4 | 8 | ATD, AXR, BMT | | 84010 | NEW |
| | 74 | 02/02 → 11/09 | 1.896 | D | M | 4 | 8 | ATD, AXR, BMT | | 81791 | |
| | 96 | 02/02 → 11/09 | 1.896 | D | M | 4 | 8 | ASZ, BLT | | 84010 | NEW |
| | 96 | 02/02 → 11/09 | 1.896 | D | M | 4 | 8 | ASZ, BLT | | 81791 | |
| 1.9 TDI Cupra R | 118 | 03/04 → 02/08 | 1.896 | D | M | 4 | 8 | BPX, BUK | | 81816 | |
| | 118 | 03/04 → 02/08 | 1.896 | D | M | 4 | 8 | BPX, BUK | | 84011 | NEW |
| 2.0 | 85 | 04/02 → 11/09 | 1.984 | B | M | 4 | 8 | AZL, BBX | | 81703 | |

Ibiza V

| | | | | | | | | | | | |
|---------|-----|---------------|-------|---|---|---|----|-----------------|----------------|-------|------------|
| 1.2 | 44 | 07/09 → | 1.198 | B | M | 3 | 12 | CGPB | | 81867 | |
| | 51 | 03/08 → | 1.198 | B | M | 3 | 12 | BZG, CGPA, CJLB | | 81867 | |
| 1.2 TDI | 55 | 05/10 → | 1.199 | D | M | 3 | 12 | CFWA | | 84001 | |
| 1.2 TSI | 63 | 08/12 → | 1.197 | B | M | 4 | 8 | CBZA | | 84045 | NEW |
| | 66 | 05/15 → | 1.197 | B | M | 4 | 16 | CJZC | | 84062 | NEW |
| | 77 | 09/10 → | 1.197 | B | M | 4 | 8 | CBZB | | 84045 | NEW |
| | 81 | 09/15 → | 1.197 | B | M | 4 | 16 | CJZD | | 84062 | NEW |
| 1.4 | 63 | 03/08 → | 1.390 | B | M | 4 | 16 | BXW, CGGB | | 81777 | |
| | 63 | 03/10 → | 1.390 | B | M | 4 | 16 | CGGB | | 81777 | |
| 1.4 TDI | 59 | 07/08 → 06/10 | 1.422 | D | M | 3 | 6 | BMS | | 84010 | NEW |
| | 59 | 07/08 → 06/10 | 1.422 | D | M | 3 | 6 | BMS | | 81791 | |
| 1.4 TSI | 103 | 10/13 → | 1.395 | B | M | 4 | 16 | CPTA | | 84062 | NEW |
| | 110 | 11/15 → | 1.395 | B | M | 4 | 16 | CZEA | | 84062 | NEW |
| 1.6 | 77 | 05/08 → | 1.598 | B | M | 4 | 16 | BTS | → T: 6J9002800 | 81865 | |
| | 77 | 05/08 → | 1.598 | B | M | 4 | 16 | BTS | T →: 6J9002801 | 81777 | |
| | 77 | 02/12 → | 1.598 | B | M | 4 | 16 | BTS | | 81865 | |
| | 77 | 02/12 → | 1.598 | B | M | 4 | 16 | BTS | | 81777 | |
| 1.6 LPG | 60 | 05/11 → | 1.598 | | M | 4 | 16 | CNKA | | 81777 | |
| 1.6 TDI | 66 | 05/09 → | 1.598 | D | M | 4 | 16 | CAYB | | 84001 | |
| | 77 | 05/09 → | 1.598 | D | M | 4 | 16 | CAYC, CLNA | | 84001 | |
| 1.9 TDI | 66 | 07/08 → 06/10 | 1.896 | D | M | 4 | 8 | BXJ | | 84010 | NEW |
| | 66 | 07/08 → 06/10 | 1.896 | D | M | 4 | 8 | BXJ | | 81791 | |
| | 77 | 03/08 → 06/10 | 1.896 | D | M | 4 | 8 | BLS | | 84010 | NEW |
| | 77 | 03/08 → 06/10 | 1.896 | D | M | 4 | 8 | BLS | | 81791 | |
| 2.0 | 85 | 10/08 → | 1.984 | B | M | 4 | 8 | CEKA | | 81703 | |
| 2.0 TDI | 105 | 01/10 → | 1.968 | D | M | 4 | 16 | CFHD | | 84001 | |

Inca

| | | | | | | | | | | | |
|---------|----|---------------|-------|---|---|---|----|--------------------|-------------------|-------|--|
| 1.4 16V | 55 | 04/00 → 06/03 | 1.390 | B | M | 4 | 16 | AUA | | 81777 | |
| 1.4 i | 44 | 11/95 → 06/03 | 1.390 | B | M | 4 | 8 | AEX, AKV, APQ, AUD | 01-1998 → | 81527 | |
| 1.6 i | 55 | 11/95 → 05/98 | 1.595 | B | M | 4 | 8 | 1F | (-)COP, 11-1995 → | 81522 | |
| | 55 | 11/95 → 05/98 | 1.595 | B | M | 4 | 8 | 1F | (+)COP | 82080 | |
| | 55 | 11/95 → 05/98 | 1.595 | B | M | 4 | 8 | 1F | (+)COP, 11-1995 → | 82080 | |
| | 55 | 06/97 → 09/00 | 1.598 | B | M | 4 | 8 | AEE, ALM | | 81527 | |
| 1.7 D | 42 | 09/96 → 06/03 | 1.716 | D | M | 4 | 8 | AHB | (-)COP | 81522 | |
| | 42 | 09/96 → 06/03 | 1.716 | D | M | 4 | 8 | AHB | (+)COP | 82080 | |

KW

cm³

NO. OF VALVES

SEAT

| Inca | | | | | | | | | | |
|----------------|-----|---------------|-------|---|----|---|----|-------------------------|-------------------|------------------|
| 1.9 D | 47 | 11/95 → 06/03 | 1.896 | D | M | 4 | 8 | 1Y | (-)COP, 11-1995 → | 81522 |
| | 47 | 11/95 → 06/03 | 1.896 | D | M | 4 | 8 | 1Y | (+)COP | 82080 |
| | 47 | 11/95 → 06/03 | 1.896 | D | M | 4 | 8 | 1Y | (+)COP, 11-1995 → | 82080 |
| 1.9 SDI | 47 | 11/95 → 06/03 | 1.896 | D | M | 4 | 8 | 1Y, AEY, AYQ | (-)COP, 11-1995 → | 81522 |
| | 47 | 11/95 → 06/03 | 1.896 | D | M | 4 | 8 | 1Y, AEY, AYQ | (+)COP | 82080 |
| | 47 | 11/95 → 06/03 | 1.896 | D | M | 4 | 8 | 1Y, AEY, AYQ | (+)COP, 11-1995 → | 82080 |
| 1.9 TDI | 66 | 09/96 → 06/03 | 1.896 | D | M | 4 | 8 | ALH | 11-1995 → | 81706 |
| Leon I | | | | | | | | | | |
| 1.4 16V | 55 | 11/99 → 06/06 | 1.390 | B | M | 4 | 16 | AHW, APE, AUA, AXP, BCA | | 81777 |
| 1.6 | 74 | 11/99 → 06/06 | 1.595 | B | M | 4 | 8 | AEH, AKL, APF | | 81702 |
| | 75 | 10/05 → 06/06 | 1.595 | B | M | 4 | 8 | BFQ, BGU | | 81702 |
| 1.6 16 V | 77 | 09/00 → 06/06 | 1.598 | B | M | 4 | 16 | ATN, AUS, AZD, BCB | | 81840 |
| 1.8 20V | 92 | 11/99 → 06/06 | 1.781 | B | AM | 4 | 20 | AGN, APG | | 81703 |
| 1.8 20V T | 132 | 11/99 → 06/06 | 1.781 | B | M | 4 | 20 | APP, AUQ | | 81703 |
| 1.8 20V T 4 | 132 | 11/99 → 06/06 | 1.781 | B | M | 4 | 20 | AJQ, ARY | | 81703 |
| 1.8 T Cupra R | 154 | 02/02 → 06/06 | 1.781 | B | M | 4 | 20 | AMK | | 81703 |
| | 165 | 07/03 → 06/06 | 1.781 | B | M | 4 | 20 | BAM | | 81703 |
| 1.9 SDI | 50 | 11/99 → 06/06 | 1.896 | D | M | 4 | 8 | AQM | | 81706 |
| 1.9 TDI | 66 | 11/99 → 06/06 | 1.896 | D | M | 4 | 8 | AGR, ALH | | 81706 |
| | 74 | 10/05 → 06/06 | 1.896 | D | M | 4 | 8 | AXR | | 81816 |
| | 74 | 10/05 → 06/06 | 1.896 | D | M | 4 | 8 | AXR | | 84011 NEW |
| | 81 | 11/99 → 06/06 | 1.896 | D | M | 4 | 8 | AHF, ASV | | 81706 |
| | 96 | 05/03 → 06/06 | 1.896 | D | M | 4 | 8 | ASZ | | 81816 |
| | 96 | 05/03 → 06/06 | 1.896 | D | M | 4 | 8 | ASZ | | 84011 NEW |
| | 110 | 09/00 → 06/06 | 1.896 | D | M | 4 | 8 | ARL | | 81816 |
| | 110 | 09/00 → 06/06 | 1.896 | D | M | 4 | 8 | ARL | | 84011 NEW |
| 1.9 TDI Syncro | 110 | 05/02 → 06/06 | 1.896 | D | M | 4 | 8 | ARL | | 81816 |
| | 110 | 05/02 → 06/06 | 1.896 | D | M | 4 | 8 | ARL | | 84011 NEW |
| 2.8 | 150 | 05/02 → 06/04 | 2.792 | B | M | 6 | 24 | BDE | | 81866 |
| 2.8 Cupra 4 | 150 | 02/01 → 06/06 | 2.792 | B | M | 6 | 24 | AUE | → 09-2001 | 81773 |
| | 150 | 02/01 → 06/06 | 2.792 | B | M | 6 | 24 | AUE | 10-2001 → | 81866 |
| Leon II | | | | | | | | | | |
| 1.2 TSI | 77 | 02/10 → 12/12 | 1.197 | B | M | 4 | 8 | CBZB | | 84045 NEW |
| 1.4 16V | 63 | 06/06 → 12/12 | 1.390 | B | M | 4 | 16 | BXW, CGGB | | 81777 |
| 1.4 TSI | 92 | 11/07 → 12/12 | 1.390 | B | M | 4 | 16 | CAXC | | 82097 |
| 1.6 | 75 | 07/05 → 12/12 | 1.595 | B | M | 4 | 8 | BSE, BSF, CCSA, CMXA | | 81702 |
| 1.6 LPG | 75 | 12/09 → 12/12 | 1.595 | | M | 4 | 8 | CHGA | | 81702 |
| 1.6 MultiFuel | 75 | 11/10 → 12/12 | 1.595 | | M | 4 | 8 | BSE, CMXA | | 81702 |
| 1.6 TDI | 66 | 11/10 → 12/12 | 1.598 | D | M | 4 | 16 | CAYB | | 84001 |
| | 77 | 02/10 → 12/12 | 1.598 | D | M | 4 | 16 | CAYC | | 84001 |
| 1.8 TSI | 118 | 06/07 → 12/12 | 1.798 | B | M | 4 | 16 | BZB, CDAA | | 84016 NEW |

KW

cm³

NO. OF VALVES

SEAT
Leon II

| | | | | | | | | | | | |
|-------------|-----|---------------|-------|---|---|---|----|--------------------|--|-------|------------|
| 1.9 TDI | 66 | 06/07 → 12/10 | 1.896 | D | M | 4 | 8 | BXF | | 84010 | NEW |
| | 66 | 06/07 → 12/10 | 1.896 | D | M | 4 | 8 | BXF | | 81791 | |
| | 77 | 07/05 → 12/10 | 1.896 | D | M | 4 | 8 | BKC, BLS, BXE | | 84010 | NEW |
| | 77 | 07/05 → 12/10 | 1.896 | D | M | 4 | 8 | BKC, BLS, BXE | | 81791 | |
| | 81 | 10/05 → 12/12 | 1.896 | D | M | 4 | 8 | ASV | | 84010 | NEW |
| | 81 | 10/05 → 12/12 | 1.896 | D | M | 4 | 8 | ASV | | 81791 | |
| 2.0 Cupra R | 195 | 09/09 → 12/12 | 1.984 | B | M | 4 | 16 | CDLA | | 84016 | NEW |
| 2.0 FSI | 110 | 07/05 → 05/10 | 1.984 | B | M | 4 | 16 | BLR, BLY, BVY, BVZ | | 81702 | |
| 2.0 TDI | 100 | 07/05 → 05/10 | 1.968 | D | M | 4 | 16 | AZV | | 81816 | |
| | 100 | 07/05 → 05/10 | 1.968 | D | M | 4 | 16 | AZV | | 84011 | NEW |
| | 103 | 10/05 → 10/10 | 1.968 | D | M | 4 | 8 | BMM | | 81816 | |
| | 103 | 10/05 → 10/10 | 1.968 | D | M | 4 | 8 | BMM | | 84011 | NEW |
| | 125 | 05/06 → 12/12 | 1.968 | D | M | 4 | 16 | BMN, CEGA, CFJA | | 81816 | |
| | 125 | 05/06 → 12/12 | 1.968 | D | M | 4 | 16 | BMN, CEGA, CFJA | | 84011 | NEW |
| 2.0 TDI 16V | 103 | 07/05 → 12/12 | 1.968 | D | M | 4 | 16 | BKD, CFHC, CLCB | | 81816 | |
| | 103 | 07/05 → 12/12 | 1.968 | D | M | 4 | 16 | BKD, CFHC, CLCB | | 84011 | NEW |
| 2.0 TFSI | 136 | 09/05 → 05/06 | 1.984 | B | M | 4 | 16 | BWA1 | | 82025 | |
| | 147 | 05/05 → 03/09 | 1.984 | B | M | 4 | 16 | BWA | | 82025 | |
| | 155 | 06/09 → 12/12 | 1.984 | B | M | 4 | 16 | CCZB | | 84016 | NEW |
| | 177 | 11/06 → 05/11 | 1.984 | B | M | 4 | 16 | BWJ, CDLD | | 82025 | |

Leon III

| | | | | | | | | | | | |
|----------------|-----|---------|-------|---|---|---|----|------------|--|-------|------------|
| 1.0 TSI | 85 | 05/15 → | 999 | B | M | 3 | 12 | CHZD | | 84062 | NEW |
| 1.2 TSI | 63 | 12/12 → | 1.197 | B | M | 4 | 16 | CJZB, CYVA | | 84062 | NEW |
| | 77 | 01/13 → | 1.197 | B | M | 4 | 16 | CJZA | | 84062 | NEW |
| | 81 | 04/14 → | 1.197 | B | M | 4 | 16 | CYVB | | 84062 | NEW |
| 1.4 TGI | 81 | 02/13 → | 1.395 | | M | 4 | 16 | CPWA | | 84062 | NEW |
| 1.4 TSI | 90 | 11/12 → | 1.395 | B | M | 4 | 16 | CMBA, CXSA | | 84062 | NEW |
| | 92 | 05/14 → | 1.395 | B | M | 4 | 16 | CZCA | | 84062 | NEW |
| | 103 | 09/12 → | 1.395 | B | M | 4 | 16 | CHPA, CPTA | | 84062 | NEW |
| | 110 | 05/14 → | 1.395 | B | M | 4 | 16 | CZEA | | 84062 | NEW |
| | 132 | 02/13 → | 1.798 | B | M | 4 | 16 | CJSA, CJSB | | 84037 | NEW |
| 1.8 TSI 4Drive | 132 | 11/14 → | 1.798 | B | M | 4 | 16 | CJSA | | 84037 | NEW |
| 2.0 Cupra | 195 | 10/13 → | 1.984 | B | M | 4 | 16 | CJXE | | 84037 | NEW |
| | 206 | 10/13 → | 1.984 | B | M | 4 | 16 | CJXA | | 84037 | NEW |

Malaga

| | | | | | | | | | | | |
|------------|----|---------------|-------|---|---|---|---|--------------------------------|--|-------|--|
| 1.2 | 44 | 05/85 → 12/93 | 1.193 | B | M | 4 | 8 | 021A1000 | | 81498 | |
| | 47 | 11/84 → 12/93 | 1.193 | B | M | 4 | 8 | 021A1000 | | 81498 | |
| 1.2 i | 52 | 12/89 → 12/93 | 1.193 | B | M | 4 | 8 | 021C.1000 | | 81498 | |
| 1.5 | 63 | 05/85 → 12/93 | 1.461 | B | M | 4 | 8 | 021A2000 | | 81498 | |
| 1.5 i | 74 | 01/87 → 12/93 | 1.461 | B | M | 4 | 8 | 021B.2000 | | 81498 | |
| 1.5 i Cat. | 66 | 10/86 → 12/93 | 1.461 | B | M | 4 | 8 | 021A2000, 021C.2000, 021D.2000 | | 81498 | |

KW

cm³

NO. OF VALVES

MAGNETI MARELLI
SEAT
Marbella

| | | | | | | | | | | |
|----------|----|---------------|-----|---|---|---|---|------------------|--|-------|
| 0.8 | 25 | 08/86 → 12/93 | 843 | B | M | 4 | 8 | 08NCA | | 81415 |
| 0.9 | 32 | 07/97 → 10/98 | 899 | B | M | 4 | 8 | 08NCB | | 81415 |
| | 29 | 01/87 → 12/93 | 903 | B | M | 4 | 8 | 09NCA | | 81415 |
| | 29 | 01/87 → 12/93 | 903 | B | M | 4 | 8 | 09NCA, 100GL7000 | | 81415 |
| 0.9 Cat. | 30 | 11/96 → 10/98 | 899 | B | M | 4 | 8 | 08NCB | | 81415 |
| | 29 | 01/87 → 12/93 | 903 | B | M | 4 | 8 | 09NCB | | 81415 |
| | 29 | 01/90 → 11/96 | 903 | B | M | 4 | 8 | 09NCB, 100GL7000 | | 81415 |

Terra

| | | | | | | | | | | |
|----------|----|---------------|-------|---|---|---|---|-------|--|-------|
| 0.9 | 29 | 02/87 → 12/96 | 903 | B | M | 4 | 8 | 09NCA | | 81415 |
| 0.9 Cat. | 29 | 02/92 → 12/94 | 903 | B | M | 4 | 8 | 09NCB | | 81415 |
| 1.3 D | 33 | 03/90 → 12/94 | 1.272 | D | M | 4 | 8 | MN | | 81525 |
| 1.4 D | 35 | 10/90 → 12/95 | 1.398 | D | M | 4 | 8 | 1W | | 81525 |

Toledo I

| | | | | | | | | | | |
|---------|-----|---------------|-------|---|---|---|----|---------------|-------------------|-------|
| 1.6 i | 52 | 05/91 → 12/93 | 1.595 | B | M | 4 | 8 | 1F | (-)COP | 81522 |
| | 52 | 05/91 → 12/93 | 1.595 | B | M | 4 | 8 | 1F | (+)COP | 82080 |
| | 54 | 05/91 → 03/99 | 1.595 | B | M | 4 | 8 | 1F, ABN, EZ | (-)COP, 05-1991 → | 81522 |
| | 54 | 05/91 → 03/99 | 1.595 | B | M | 4 | 8 | 1F, ABN, EZ | (+)COP | 82080 |
| | 54 | 05/91 → 03/99 | 1.595 | B | M | 4 | 8 | 1F, ABN, EZ | (+)COP, 05-1991 → | 82080 |
| | 55 | 01/93 → 03/99 | 1.595 | B | M | 4 | 8 | 1F | (-)COP, 05-1991 → | 81522 |
| | 55 | 01/93 → 03/99 | 1.595 | B | M | 4 | 8 | 1F | (+)COP | 82080 |
| | 55 | 01/93 → 03/99 | 1.595 | B | M | 4 | 8 | 1F | (+)COP, 05-1991 → | 82080 |
| | 74 | 11/96 → 03/99 | 1.595 | B | M | 4 | 8 | AFT | (-)COP | 81522 |
| | 74 | 11/96 → 03/99 | 1.595 | B | M | 4 | 8 | AFT | (+)COP | 82080 |
| 1.8 16V | 92 | 05/91 → 03/99 | 1.781 | B | M | 4 | 16 | PL | (-)COP, 05-1991 → | 81522 |
| | 92 | 05/91 → 03/99 | 1.781 | B | M | 4 | 16 | PL | (+)COP | 82080 |
| | 92 | 05/91 → 03/99 | 1.781 | B | M | 4 | 16 | PL | (+)COP, 05-1991 → | 82080 |
| | 98 | 05/91 → 03/99 | 1.781 | B | M | 4 | 16 | KR | (-)COP, 05-1991 → | 81522 |
| | 98 | 05/91 → 03/99 | 1.781 | B | M | 4 | 16 | KR | (+)COP | 82080 |
| | 98 | 05/91 → 03/99 | 1.781 | B | M | 4 | 16 | KR | (+)COP, 05-1991 → | 82080 |
| 1.8 GT | 102 | 05/91 → 11/92 | 1.781 | B | M | 4 | 16 | KR | (-)COP | 81522 |
| | 102 | 05/91 → 11/92 | 1.781 | B | M | 4 | 16 | KR | (+)COP | 82080 |
| 1.8 i | 65 | 05/91 → 12/96 | 1.781 | B | M | 4 | 8 | RP | (-)COP | 81522 |
| | 65 | 05/91 → 12/96 | 1.781 | B | M | 4 | 8 | RP | (+)COP | 82080 |
| | 66 | 11/93 → 12/96 | 1.781 | B | M | 4 | 8 | ABS, ACC, ADZ | (-)COP | 81522 |
| | 66 | 11/93 → 12/96 | 1.781 | B | M | 4 | 8 | ABS, ACC, ADZ | (+)COP | 82080 |
| 1.9 D | 47 | 12/95 → 03/99 | 1.896 | D | M | 4 | 8 | 1Y | (-)COP, 05-1991 → | 81522 |
| | 47 | 12/95 → 03/99 | 1.896 | D | M | 4 | 8 | 1Y | (+)COP | 82080 |
| | 47 | 12/95 → 03/99 | 1.896 | D | M | 4 | 8 | 1Y | (+)COP, 05-1991 → | 82080 |
| | 50 | 05/91 → 03/99 | 1.896 | D | M | 4 | 8 | 1Y | (-)COP, 05-1991 → | 81522 |
| | 50 | 05/91 → 03/99 | 1.896 | D | M | 4 | 8 | 1Y | (+)COP | 82080 |
| | 50 | 05/91 → 03/99 | 1.896 | D | M | 4 | 8 | 1Y | (+)COP, 05-1991 → | 82080 |
| 1.9 TD | 55 | 05/91 → 03/99 | 1.896 | D | M | 4 | 8 | AAZ | (-)COP, 05-1991 → | 81522 |
| | 55 | 05/91 → 03/99 | 1.896 | D | M | 4 | 8 | AAZ | (+)COP | 82080 |
| | 55 | 05/91 → 03/99 | 1.896 | D | M | 4 | 8 | AAZ | (+)COP, 05-1991 → | 82080 |

KW

cm³

NO. OF VALVES

SEAT
Toledo I

| | | | | | | | | | | |
|---------------------|-----|---------------|-------|---|---|---|----|---------|-------------------|-------|
| 1.9 TDI | 66 | 08/95 → 03/99 | 1.896 | D | M | 4 | 8 | 1Z, AHU | (-)COP, 05-1991 → | 81522 |
| | 66 | 08/95 → 03/99 | 1.896 | D | M | 4 | 8 | 1Z, AHU | (+)COP | 82080 |
| | 66 | 08/95 → 03/99 | 1.896 | D | M | 4 | 8 | 1Z, AHU | (+)COP, 05-1991 → | 82080 |
| | 81 | 11/96 → 03/99 | 1.896 | D | M | 4 | 8 | AFN | (-)COP, 05-1991 → | 81522 |
| | 81 | 11/96 → 03/99 | 1.896 | D | M | 4 | 8 | AFN | (+)COP | 82080 |
| | 81 | 11/96 → 03/99 | 1.896 | D | M | 4 | 8 | AFN | (+)COP, 05-1991 → | 82080 |
| 2.0 i | 85 | 05/91 → 03/99 | 1.984 | B | M | 4 | 8 | 2E, AGG | (-)COP | 81522 |
| | 85 | 05/91 → 03/99 | 1.984 | B | M | 4 | 8 | 2E, AGG | (+)COP | 82080 |
| 2.0 i 16V/2.0 i 16V | 110 | 11/93 → 03/99 | 1.984 | B | M | 4 | 16 | ABF | (-)COP, 01-1997 → | 81522 |
| | 110 | 11/93 → 03/99 | 1.984 | B | M | 4 | 16 | ABF | (+)COP | 82080 |
| | 110 | 11/93 → 03/99 | 1.984 | B | M | 4 | 16 | ABF | (+)COP, 01-1997 → | 82080 |

Toledo II

| | | | | | | | | | | |
|------------|-----|---------------|-------|---|----|---|----|-------------------------|-----------|------------------|
| 1.4 16V | 55 | 01/00 → 05/02 | 1.390 | B | M | 4 | 16 | AHW, APE, AUA, AXP, BCA | | 81777 |
| 1.6 | 74 | 10/98 → 07/04 | 1.595 | B | M | 4 | 8 | AEH, AKL, APF | 08-1995 → | 81702 |
| 1.6 16V | 77 | 06/00 → 05/06 | 1.598 | B | M | 4 | 16 | AUS, AZD, BCB | | 81840 |
| 1.8 20V | 92 | 10/98 → 07/04 | 1.781 | B | AM | 4 | 20 | AGN, APG | | 81703 |
| 1.8 20VT | 132 | 09/00 → 07/04 | 1.781 | B | AM | 4 | 20 | APP, AUQ | | 81703 |
| 1.9 SDI | 50 | 11/99 → 06/04 | 1.896 | D | M | 4 | 8 | AQM | | 81706 |
| 1.9 TDI | 66 | 03/99 → 07/04 | 1.896 | D | M | 4 | 8 | AGR, ALH | 05-1991 → | 81706 |
| | 81 | 10/98 → 07/04 | 1.896 | D | M | 4 | 8 | AHF, ASV | 05-1991 → | 81706 |
| | 96 | 05/03 → 05/06 | 1.896 | D | M | 4 | 8 | ASZ | | 81816 |
| | 96 | 05/03 → 05/06 | 1.896 | D | M | 4 | 8 | ASZ | | 84011 NEW |
| | 110 | 10/00 → 07/04 | 1.896 | D | M | 4 | 8 | ARL | | 81816 |
| | 110 | 10/00 → 07/04 | 1.896 | D | M | 4 | 8 | ARL | | 84011 NEW |
| 2.3 V5 | 110 | 10/98 → 11/00 | 2.324 | B | M | 5 | 10 | AGZ | | 81856 |
| 2.3 V5 20V | 125 | 09/00 → 11/03 | 2.324 | B | M | 5 | 20 | AQN | | 81856 |

Toledo III

| | | | | | | | | | | |
|-------------|-----|---------------|-------|---|---|---|----|---------------------|--|------------------|
| 1.6 | 75 | 10/04 → 05/09 | 1.595 | B | M | 4 | 8 | BGU, BSE, BSF, CCSA | | 81702 |
| 1.8 TFSI | 118 | 01/07 → 05/09 | 1.798 | B | M | 4 | 16 | BYT, BZB, CDAA | | 84016 NEW |
| 1.9 TDI | 77 | 10/04 → 05/09 | 1.896 | D | M | 4 | 8 | BJB, BKC, BLS, BXE | | 84010 NEW |
| | 77 | 10/04 → 05/09 | 1.896 | D | M | 4 | 8 | BJB, BKC, BLS, BXE | | 81791 |
| 2.0 FSI | 110 | 10/04 → 05/09 | 1.984 | B | M | 4 | 16 | BLR, BLY, BVY, BVZ | | 81702 |
| 2.0 TDI | 100 | 09/04 → 05/09 | 1.968 | D | M | 4 | 16 | AZV | | 81816 |
| | 100 | 09/04 → 05/09 | 1.968 | D | M | 4 | 16 | AZV | | 84011 NEW |
| | 103 | 11/05 → 05/09 | 1.968 | D | M | 4 | 8 | BMM | | 81816 |
| | 103 | 11/05 → 05/09 | 1.968 | D | M | 4 | 8 | BMM | | 84011 NEW |
| | 125 | 01/06 → 05/09 | 1.968 | D | M | 4 | 16 | BMN, CEGA | | 81816 |
| | 125 | 01/06 → 05/09 | 1.968 | D | M | 4 | 16 | BMN, CEGA | | 84011 NEW |
| 2.0 TDI 16V | 103 | 04/04 → 05/09 | 1.968 | D | M | 4 | 16 | BKD | | 81816 |
| | 103 | 04/04 → 05/09 | 1.968 | D | M | 4 | 16 | BKD | | 84011 NEW |
| 2.0 TFSI | 147 | 11/05 → 05/09 | 1.984 | B | M | 4 | 16 | BWA | | 82025 |

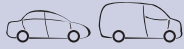
KW

cm³

NO. OF VALVES

MAGNETI MARELLI

SEAT

Toledo IV

| | | | | | | | | | | |
|---------|----|---------|-------|---|---|---|----|------------|--|------------------|
| 1.2 | 55 | 07/12 → | 1.198 | B | M | 3 | 12 | CGPC | | 81867 |
| 1.2 TSI | 63 | 07/12 → | 1.197 | B | M | 4 | 8 | CBZA | | 84045 NEW |
| | 77 | 07/12 → | 1.197 | B | M | 4 | 8 | CBZB | | 84045 NEW |
| 1.4 TSI | 90 | 07/12 → | 1.390 | B | M | 4 | 16 | CAXA | | 82097 |
| 1.6 TDI | 77 | 07/12 → | 1.598 | D | M | 4 | 16 | CAYC, CLNA | | 84001 |

SKODA

Fabia I, Station Wagon, Van

| | | | | | | | | | | |
|------------|----|---------------|-------|---|----|---|----|---------------|-----------------|------------------|
| 1.2 | 40 | 08/02 → 03/08 | 1.198 | B | M | 3 | 6 | AWY, BMD | | 81867 |
| | 47 | 01/03 → 03/08 | 1.198 | B | M | 3 | 12 | AZQ, BME | | 81867 |
| 1.4 16V | 55 | 12/99 → 03/08 | 1.390 | B | AM | 4 | 16 | AUA, BBY, BKY | | 81777 |
| | 59 | 04/06 → 12/07 | 1.390 | B | M | 4 | 16 | BUD | | 81777 |
| | 74 | 12/99 → 03/08 | 1.390 | B | M | 4 | 16 | AUB, BBZ | | 81777 |
| | 74 | 04/00 → 12/07 | 1.390 | B | AM | 4 | 16 | AUB, BBZ | | 81777 |
| 1.4 TDI | 51 | 10/05 → 03/08 | 1.422 | D | M | 3 | 6 | BNM | | 84010 NEW |
| | 51 | 10/05 → 03/08 | 1.422 | D | M | 3 | 6 | BNM | | 81791 |
| | 55 | 04/03 → 03/08 | 1.422 | D | M | 3 | 6 | AMF | | 84010 NEW |
| | 55 | 04/03 → 03/08 | 1.422 | D | M | 3 | 6 | AMF | | 81791 |
| | 59 | 10/05 → 03/08 | 1.422 | D | M | 3 | 6 | BNV | | 84010 NEW |
| | 59 | 10/05 → 03/08 | 1.422 | D | M | 3 | 6 | BNV | | 81791 |
| 1.9 SDI | 47 | 12/99 → 03/08 | 1.896 | D | M | 4 | 8 | ASY | → T: 6Y3X628012 | 84052 NEW |
| | 47 | 12/99 → 03/08 | 1.896 | D | M | 4 | 8 | ASY | T →: 6Y3X628013 | 82013 |
| | 74 | 01/00 → 03/08 | 1.896 | D | M | 4 | 8 | ATD, AXR | | 84010 NEW |
| | 74 | 01/00 → 03/08 | 1.896 | D | M | 4 | 8 | ATD, AXR | | 81791 |
| 1.9 TDI RS | 96 | 06/03 → 03/08 | 1.896 | D | M | 4 | 8 | ASZ, BLT | | 84010 NEW |
| | 96 | 06/03 → 03/08 | 1.896 | D | M | 4 | 8 | ASZ, BLT | | 81791 |
| 2.0 | 85 | 12/99 → 03/08 | 1.984 | B | M | 4 | 8 | AZL | | 81703 |

Fabia II, Station Wagon, Van

| | | | | | | | | | | |
|---------|----|---------------|-------|---|---|---|----|-----------------------|--|------------------|
| 1.2 | 44 | 12/06 → 12/14 | 1.198 | B | M | 3 | 6 | BBM, CHFA | | 81867 |
| | 51 | 01/07 → 12/14 | 1.198 | B | M | 3 | 12 | BZG, CEVA, CGPA, CHTA | | 81867 |
| 1.2 12V | 44 | 11/11 → 12/14 | 1.198 | B | M | 3 | 12 | CGPB | | 81867 |
| 1.2 TDI | 55 | 05/10 → 12/14 | 1.199 | D | M | 3 | 12 | CFWA | | 84001 |
| 1.2 TSI | 63 | 03/10 → 12/14 | 1.197 | B | M | 4 | 8 | CBZA | | 84045 NEW |
| | 77 | 03/10 → 12/14 | 1.197 | B | M | 4 | 8 | CBZB | | 84045 NEW |
| 1.4 | 63 | 01/07 → 12/14 | 1.390 | B | M | 4 | 16 | BXW, CGGB | | 81777 |
| 1.4 TDI | 51 | 02/07 → 03/10 | 1.422 | D | M | 3 | 6 | BNM | | 84010 NEW |
| | 51 | 02/07 → 03/10 | 1.422 | D | M | 3 | 6 | BNM | | 81791 |
| | 59 | 01/07 → 03/10 | 1.422 | D | M | 3 | 6 | BMS, BNV | | 84010 NEW |
| | 59 | 01/07 → 03/10 | 1.422 | D | M | 3 | 6 | BMS, BNV | | 81791 |
| 1.6 | 77 | 04/07 → 12/14 | 1.598 | B | M | 4 | 16 | BTS, CFNA | | 81865 |
| 1.6 TDI | 55 | 04/10 → 12/14 | 1.598 | D | M | 4 | 16 | CAYA | | 84001 |
| | 66 | 03/10 → 12/14 | 1.598 | D | M | 4 | 16 | CAYB | | 84001 |
| | 77 | 03/10 → 12/14 | 1.598 | D | M | 4 | 16 | CAYC | | 84001 |

KW

cm³

NO. OF VALVES

SKODA
Fabia II, Station Wagon, Van

| | | | | | | | | | | |
|---------|----|---------------|-------|---|---|---|---|----------|-------|------------|
| 1.9 TDI | 77 | 04/07 → 03/10 | 1.896 | D | M | 4 | 8 | BLS, BSW | 84010 | NEW |
| | 77 | 04/07 → 03/10 | 1.896 | D | M | 4 | 8 | BLS, BSW | 81791 | |

Fabia III, Station Wagon

| | | | | | | | | | | |
|---------|----|---------|-------|---|---|---|----|------|-------|------------|
| 1.2 TSI | 66 | 08/14 → | 1.197 | B | M | 4 | 16 | CJZC | 84062 | NEW |
| | 81 | 08/14 → | 1.197 | B | M | 4 | 16 | CJZD | 84062 | NEW |

Felicia I, Station Wagon

| | | | | | | | | | | |
|---------|----|---------------|-------|---|---|---|---|------------|-------|--|
| 1.6 | 55 | 06/97 → 04/02 | 1.598 | B | M | 4 | 8 | AEE | 81527 | |
| 1.6 GLX | 55 | 08/95 → 03/98 | 1.598 | B | M | 4 | 8 | AEE | 81527 | |
| 1.6 LX | 55 | 08/95 → 03/98 | 1.598 | B | M | 4 | 8 | AEE, EA111 | 81527 | |
| 1.9 D | 47 | 10/95 → 03/98 | 1.896 | D | M | 4 | 8 | AEF | 81528 | |

Felicia II, Station Wagon

| | | | | | | | | | | |
|-------|----|---------------|-------|---|---|---|---|-----|-------|--|
| 1.6 | 55 | 01/98 → 06/01 | 1.598 | B | M | 4 | 8 | AEE | 81527 | |
| 1.9 D | 47 | 01/98 → 06/01 | 1.896 | D | M | 4 | 8 | AEF | 81528 | |

Octavia I, Station Wagon

| | | | | | | | | | | |
|-------------|-----|---------------|-------|---|----|---|----|-------------------------|-------|------------|
| 1.4 16V | 55 | 09/00 → 12/10 | 1.390 | B | M | 4 | 16 | AXP, BCA | 81777 | |
| 1.6 | 74 | 02/97 → 12/07 | 1.595 | B | AM | 4 | 8 | AEH, AKL | 81702 | |
| | 74 | 07/98 → 12/07 | 1.595 | B | M | 4 | 8 | AEH, AKL | 81702 | |
| | 75 | 11/00 → 12/10 | 1.595 | B | M | 4 | 8 | AVU, BFQ | 81702 | |
| | 55 | 09/96 → 09/04 | 1.598 | B | M | 4 | 8 | AEE | 81527 | |
| 1.8 | 92 | 09/96 → 07/00 | 1.781 | B | M | 4 | 20 | AGN | 81703 | |
| 1.8 20V | 92 | 07/98 → 07/00 | 1.781 | B | M | 4 | 20 | AGN | 81703 | |
| 1.8 T | 110 | 08/97 → 12/10 | 1.781 | B | AM | 4 | 20 | AGU, ARX, ARZ, AUM | 81703 | |
| | 110 | 07/98 → 12/10 | 1.781 | B | M | 4 | 20 | AGU, ARX, ARZ, AUM | 81703 | |
| 1.8 T 4x4 | 110 | 05/01 → 05/06 | 1.781 | B | M | 4 | 20 | AGU, ARX, AUM | 81703 | |
| | 110 | 05/01 → 05/06 | 1.781 | B | M | 4 | 20 | ARX, AUM | 81703 | |
| 1.9 SDI | 50 | 06/97 → 12/03 | 1.896 | D | M | 4 | 8 | AGP, AQM | 81706 | |
| 1.9 TDI | 66 | 09/96 → 03/10 | 1.896 | D | AM | 4 | 8 | AGR, ALH | 81706 | |
| | 66 | 07/98 → 03/10 | 1.896 | D | M | 4 | 8 | AGR, ALH | 81706 | |
| | 74 | 10/05 → 12/10 | 1.896 | D | M | 4 | 8 | AXR | 81816 | |
| | 74 | 10/05 → 12/10 | 1.896 | D | M | 4 | 8 | AXR | 84011 | NEW |
| | 81 | 08/97 → 01/06 | 1.896 | D | M | 4 | 8 | AHF, ASV | 81706 | |
| | 96 | 09/02 → 09/04 | 1.896 | D | M | 4 | 8 | ASZ | 81816 | |
| | 96 | 09/02 → 09/04 | 1.896 | D | M | 4 | 8 | ASZ | 84011 | NEW |
| 1.9 TDI 4x4 | 66 | 11/99 → 02/06 | 1.896 | D | M | 4 | 8 | AGR | 81706 | |
| | 74 | 09/00 → 01/06 | 1.896 | D | M | 4 | 8 | ATD | 81816 | |
| | 74 | 09/00 → 01/06 | 1.896 | D | M | 4 | 8 | ATD | 84011 | NEW |
| 2.0 | 85 | 04/99 → 05/07 | 1.984 | B | AM | 4 | 8 | AEG, APK, AQY, AZH, AZJ | 81703 | |
| | 85 | 04/99 → 05/07 | 1.984 | B | M | 4 | 8 | AEG, APK, AQY, AZH, AZJ | 81703 | |
| 2.0 4x4 | 85 | 08/00 → 09/04 | 1.984 | B | M | 4 | 8 | AZH, AZJ | 81703 | |
| | 88 | 01/00 → 12/10 | 1.984 | B | M | 4 | 8 | ATF | 81703 | |
| RS 1.8 T | 132 | 05/01 → 01/06 | 1.781 | B | M | 4 | 20 | AUQ | 81703 | |

KW

cm³

NO. OF VALVES

MAGNETI MARELLI
SKODA
Octavia II, Station Wagon

| | | | | | | | | | | | |
|-----------------|-----|---------------|-------|---|---|---|----|---------------------------|--|-------|------------|
| 1.2 TSI | 77 | 02/10 → 06/13 | 1.197 | B | M | 4 | 8 | CBZB | | 84045 | NEW |
| 1.4 | 55 | 05/04 → 05/06 | 1.390 | B | M | 4 | 16 | BCA | | 81777 | |
| | 59 | 06/04 → 04/13 | 1.390 | B | M | 4 | 16 | BUD, CGGA | | 81777 | |
| 1.4 TSI | 90 | 11/08 → 06/13 | 1.390 | B | M | 4 | 16 | CAXA | | 82097 | |
| 1.6 | 75 | 06/04 → 06/13 | 1.595 | B | M | 4 | 8 | BGU, BSE, BSF, CCSA, CMXA | | 81702 | |
| 1.6 FSI | 85 | 02/04 → 10/08 | 1.598 | B | M | 4 | 16 | BLF | | 81865 | |
| 1.6 LPG | 75 | 08/09 → 11/12 | 1.595 | | M | 4 | 8 | CHGA | | 81702 | |
| 1.6 MultiFuel | 75 | 01/08 → 06/13 | 1.595 | | M | 4 | 8 | CCSA, CMXA | | 81702 | |
| 1.6 TDI | 77 | 06/09 → 04/13 | 1.598 | D | M | 4 | 16 | CAYC | | 84001 | |
| 1.6 TDI 4x4 | 77 | 06/09 → 02/13 | 1.598 | D | M | 4 | 16 | CAYC | | 84001 | |
| 1.8 TSI | 112 | 03/09 → 06/13 | 1.798 | B | M | 4 | 16 | CDAB | | 84016 | NEW |
| | 118 | 06/07 → 04/13 | 1.798 | B | M | 4 | 16 | BZB, CDAА | | 84016 | NEW |
| 1.8 TSI 4x4 | 112 | 03/09 → 02/13 | 1.798 | B | M | 4 | 16 | CDAB | | 84016 | NEW |
| | 118 | 11/08 → 02/13 | 1.798 | B | M | 4 | 16 | CDAА | | 84016 | NEW |
| 1.9 TDI | 77 | 06/04 → 12/10 | 1.896 | D | M | 4 | 8 | BJB, BKC, BLS, BXE | | 84010 | NEW |
| | 77 | 06/04 → 12/10 | 1.896 | D | M | 4 | 8 | BJB, BKC, BLS, BXE | | 81791 | |
| 1.9 TDI 4x4 | 77 | 11/04 → 12/10 | 1.896 | D | M | 4 | 8 | BKC, BLS, BXE | | 84010 | NEW |
| | 77 | 11/04 → 12/10 | 1.896 | D | M | 4 | 8 | BKC, BLS, BXE | | 81791 | |
| 2.0 FSI | 110 | 11/04 → 10/08 | 1.984 | B | M | 4 | 16 | BLR, BLY, BVY, BVZ | | 81702 | |
| 2.0 FSI 4x4 | 110 | 11/04 → 10/08 | 1.984 | B | M | 4 | 16 | BLX, BVX | | 81702 | |
| 2.0 RS | 147 | 10/05 → 02/13 | 1.984 | B | M | 4 | 16 | BWA, CCZA | | 82025 | |
| 2.0 TDI | 81 | 03/10 → 06/13 | 1.968 | D | M | 4 | 16 | CFHF, CLCA | | 84001 | |
| | 100 | 02/04 → 05/10 | 1.968 | D | M | 4 | 16 | AZV | | 81816 | |
| | 100 | 02/04 → 05/10 | 1.968 | D | M | 4 | 16 | AZV | | 84011 | NEW |
| | 103 | 11/05 → 05/10 | 1.968 | D | M | 4 | 8 | BMM | | 81816 | |
| | 103 | 11/05 → 05/10 | 1.968 | D | M | 4 | 8 | BMM | | 84011 | NEW |
| 2.0 TDI 16V | 100 | 02/04 → 05/10 | 1.968 | D | M | 4 | 16 | AZV | | 81816 | |
| | 100 | 02/04 → 05/10 | 1.968 | D | M | 4 | 16 | AZV | | 84011 | NEW |
| | 103 | 02/04 → 04/13 | 1.968 | D | M | 4 | 16 | BKD, CFHC, CLCB | | 81816 | |
| | 103 | 02/04 → 04/13 | 1.968 | D | M | 4 | 16 | BKD, CFHC, CLCB | | 84011 | NEW |
| 2.0 TDI 16V 4x4 | 103 | 05/10 → 02/13 | 1.968 | D | M | 4 | 16 | CFHC | | 84001 | |
| 2.0 TDI 4x4 | 81 | 05/11 → 02/13 | 1.968 | D | M | 4 | 16 | CFHF | | 84001 | |
| | 103 | 07/06 → 05/10 | 1.968 | D | M | 4 | 8 | BMM | | 81816 | |
| | 103 | 07/06 → 05/10 | 1.968 | D | M | 4 | 8 | BMM | | 84011 | NEW |
| 2.0 TDI RS | 125 | 04/06 → 02/13 | 1.968 | D | M | 4 | 16 | BMN, CEGA | | 81816 | |
| | 125 | 04/06 → 02/13 | 1.968 | D | M | 4 | 16 | BMN, CEGA | | 84011 | NEW |

Octavia III, Station Wagon

| | | | | | | | | | | | |
|---------------|-----|---------|-------|---|---|---|----|------------|--|-------|------------|
| 1.2 TSI | 63 | 11/12 → | 1.197 | B | M | 4 | 16 | CJZB | | 84062 | NEW |
| | 77 | 11/12 → | 1.197 | B | M | 4 | 16 | CJZA | | 84062 | NEW |
| | 81 | 05/15 → | 1.197 | B | M | 4 | 16 | CYVB | | 84062 | NEW |
| | 103 | 11/12 → | 1.395 | B | M | 4 | 16 | CHPA | | 84062 | NEW |
| | 110 | 08/14 → | 1.395 | B | M | 4 | 16 | CHPB, CZDA | | 84062 | NEW |
| 1.4 TSI G-TEC | 81 | 11/13 → | 1.395 | | M | 4 | 16 | CPWA | | 84062 | NEW |

KW

cm³

NO. OF VALVES

SKODA
Octavia III, Station Wagon

| | | | | | | | | | | | |
|-------------|-----|---------|-------|---|---|---|----|------------|--|-------|------------|
| 1.6 | 81 | 01/14 → | 1.598 | B | M | 4 | 16 | CWVA | | 84062 | NEW |
| 1.8 TSI | 132 | 11/12 → | 1.798 | B | M | 4 | 16 | CJSA | | 84037 | NEW |
| | 132 | 11/12 → | 1.798 | B | M | 4 | 16 | CJSA, CJSB | | 84037 | NEW |
| 1.8 TSI 4x4 | 132 | 09/14 → | 1.798 | B | M | 4 | 16 | CJSA | | 84037 | NEW |
| | 132 | 11/12 → | 1.798 | B | M | 4 | 16 | CJSB | | 84037 | NEW |
| 2.0 TSI RS | 162 | 05/13 → | 1.984 | B | M | 4 | 16 | CHHB | | 84037 | NEW |
| | 169 | 05/15 → | 1.984 | B | M | 4 | 16 | CHHA | | 84037 | NEW |

Rapid II

| | | | | | | | | | | | |
|---------|----|---------|-------|---|---|---|----|------------|--|-------|------------|
| 1.2 | 55 | 07/12 → | 1.198 | B | M | 3 | 12 | CGPC | | 81867 | |
| 1.2 TSI | 63 | 07/12 → | 1.197 | B | M | 4 | 8 | CBZA | | 84045 | NEW |
| | 77 | 07/12 → | 1.197 | B | M | 4 | 8 | CBZB | | 84045 | NEW |
| 1.4 TSI | 90 | 07/12 → | 1.390 | B | M | 4 | 16 | CAXA | | 82097 | |
| | 92 | 05/15 → | 1.395 | B | M | 4 | 16 | CZCA | | 84062 | NEW |
| 1.6 | 77 | 07/12 → | 1.598 | B | M | 4 | 16 | CFNA | | 81865 | |
| 1.6 TDI | 66 | 08/13 → | 1.598 | D | M | 4 | 16 | CAYB | | 84001 | |
| | 77 | 07/12 → | 1.598 | D | M | 4 | 16 | CAYC, CLNA | | 84001 | |

Roomster, Van

| | | | | | | | | | | | |
|---------|----|---------------|-------|---|---|---|----|-----------|--|-------|------------|
| 1.2 | 47 | 05/06 → 01/07 | 1.198 | B | M | 3 | 12 | BME | | 81867 | |
| | 51 | 01/07 → 05/15 | 1.198 | B | M | 3 | 12 | BZG, CGPA | | 81867 | |
| 1.2 TDI | 55 | 03/10 → 05/15 | 1.199 | D | M | 3 | 12 | CFWA | | 84001 | |
| 1.2 TSI | 63 | 03/10 → 05/15 | 1.197 | B | M | 4 | 8 | CBZA | | 84045 | NEW |
| | 77 | 03/10 → 05/15 | 1.197 | B | M | 4 | 8 | CBZB | | 84045 | NEW |
| 1.4 | 63 | 09/06 → 05/15 | 1.390 | B | M | 4 | 16 | BXW, CGGB | | 81777 | |
| 1.4 TDI | 51 | 07/06 → 03/10 | 1.422 | D | M | 3 | 6 | BNM | | 84010 | NEW |
| | 51 | 07/06 → 03/10 | 1.422 | D | M | 3 | 6 | BNM | | 81791 | |
| | 59 | 09/06 → 03/10 | 1.422 | D | M | 3 | 6 | BMS, BNV | | 84010 | NEW |
| | 59 | 09/06 → 03/10 | 1.422 | D | M | 3 | 6 | BMS, BNV | | 81791 | |
| 1.6 | 77 | 09/06 → 05/15 | 1.598 | B | M | 4 | 16 | BTS, CFNA | | 81865 | |
| 1.6 TDI | 66 | 03/10 → 05/15 | 1.598 | D | M | 4 | 16 | CAYB | | 84001 | |
| | 77 | 03/10 → 05/15 | 1.598 | D | M | 4 | 16 | CAYC | | 84001 | |
| 1.9 TDI | 74 | 03/06 → 05/06 | 1.896 | D | M | 4 | 8 | AXR | | 81816 | |
| | 74 | 03/06 → 05/06 | 1.896 | D | M | 4 | 8 | AXR | | 84011 | NEW |
| | 77 | 09/06 → 03/10 | 1.896 | D | M | 4 | 8 | BLS, BSW | | 84010 | NEW |
| | 77 | 09/06 → 03/10 | 1.896 | D | M | 4 | 8 | BLS, BSW | | 81791 | |

Superb

| | | | | | | | | | | | |
|-------------|-----|---------|-------|---|---|---|----|------------|--|-------|------------|
| 1.4 TSI | 92 | 03/15 → | 1.395 | B | M | 4 | 16 | CZCA | | 84062 | NEW |
| | 110 | 03/15 → | 1.395 | B | M | 4 | 16 | CZDA, CZEA | | 84062 | NEW |
| 1.4 TSI 4x4 | 110 | 03/15 → | 1.395 | B | M | 4 | 16 | CZDA, CZEA | | 84062 | NEW |
| 1.8 TSI | 132 | 03/15 → | 1.798 | B | M | 4 | 16 | CJSA, CJSC | | 84037 | NEW |
| 2.0 TSI | 162 | 03/15 → | 1.984 | B | M | 4 | 16 | CHHB | | 84037 | NEW |
| 2.0 TSI 4x4 | 206 | 03/15 → | 1.984 | B | M | 4 | 16 | CJXA | | 84037 | NEW |

KW

cm³

NO. OF VALVES

SKODA
Superb I

| | | | | | | | | | | |
|---------|-----|---------------|-------|---|----|---|----|----------|--|------------------|
| 1.8 T | 110 | 12/01 → 03/08 | 1.781 | B | M | 4 | 20 | AWT | | 81703 |
| 1.9 TDI | 74 | 08/02 → 10/05 | 1.896 | D | M | 4 | 8 | AVB | | 81816 |
| | 74 | 08/02 → 10/05 | 1.896 | D | M | 4 | 8 | AVB | | 84011 NEW |
| | 77 | 10/05 → 05/07 | 1.896 | D | M | 4 | 8 | BSV | | 81816 |
| | 77 | 10/05 → 05/07 | 1.896 | D | M | 4 | 8 | BSV | | 84011 NEW |
| | 85 | 01/07 → 03/08 | 1.896 | D | M | 4 | 8 | BPZ | | 81816 |
| | 85 | 01/07 → 03/08 | 1.896 | D | M | 4 | 8 | BPZ | | 84011 NEW |
| | 96 | 12/01 → 03/08 | 1.896 | D | M | 4 | 8 | AVF, AWX | | 81816 |
| | 96 | 12/01 → 03/08 | 1.896 | D | M | 4 | 8 | AVF, AWX | | 84011 NEW |
| 2.0 | 85 | 12/01 → 03/08 | 1.984 | B | M | 4 | 8 | AZM | | 81703 |
| 2.0 TDI | 103 | 10/05 → 03/08 | 1.968 | D | M | 4 | 8 | BSS | | 81816 |
| | 103 | 10/05 → 03/08 | 1.968 | D | M | 4 | 8 | BSS | | 84011 NEW |
| 2.5 TDI | 114 | 12/01 → 08/03 | 2.496 | D | AM | 6 | 24 | AYM | | 81705 |
| | 120 | 06/03 → 03/08 | 2.496 | D | M | 6 | 24 | BDG | | 81705 |
| 2.8 V6 | 140 | 06/02 → 03/08 | 2.771 | B | M | 6 | 30 | BBG | | 81842 |
| | 142 | 12/01 → 03/08 | 2.771 | B | AM | 6 | 30 | AMX | | 81842 |

Superb II, Station Wagon

| | | | | | | | | | | |
|-----------------|-----|---------------|-------|---|---|---|----|-----------------|--|------------------|
| 1.4 TSI | 92 | 07/08 → 05/15 | 1.390 | B | M | 4 | 16 | CAXC | | 82097 |
| 1.6 TDI | 77 | 09/10 → 05/15 | 1.598 | D | M | 4 | 16 | CAYC | | 84001 |
| 1.8 TSI | 112 | 03/09 → 05/15 | 1.798 | B | M | 4 | 16 | CDAB | | 84016 NEW |
| | 118 | 03/08 → 05/15 | 1.798 | B | M | 4 | 16 | BZB, CDAA | | 84016 NEW |
| | 118 | 10/09 → 05/15 | 1.798 | B | M | 4 | 16 | CDAA | | 84016 NEW |
| 1.8 TSI 4x4 | 112 | 03/09 → 05/15 | 1.798 | B | M | 4 | 16 | CDAB | | 84016 NEW |
| | 118 | 11/08 → 05/15 | 1.798 | B | M | 4 | 16 | CDAA | | 84016 NEW |
| 1.9 TDI | 77 | 03/08 → 11/10 | 1.896 | D | M | 4 | 8 | BLS, BXE | | 84010 NEW |
| | 77 | 03/08 → 11/10 | 1.896 | D | M | 4 | 8 | BLS, BXE | | 81791 |
| 2.0 TDI | 103 | 03/08 → 05/10 | 1.968 | D | M | 4 | 8 | BMP | | 81816 |
| | 103 | 03/08 → 05/10 | 1.968 | D | M | 4 | 8 | BMP | | 84011 NEW |
| | 125 | 07/08 → 05/15 | 1.968 | D | M | 4 | 16 | CBBB, CFGB | | 81816 |
| | 125 | 07/08 → 05/15 | 1.968 | D | M | 4 | 16 | CBBB, CFGB | | 84011 NEW |
| 2.0 TDI 16V | 103 | 01/09 → 05/15 | 1.968 | D | M | 4 | 16 | BKD, CFFB, CLJA | | 81816 |
| | 103 | 01/09 → 05/15 | 1.968 | D | M | 4 | 16 | BKD, CFFB, CLJA | | 84011 NEW |
| 2.0 TDI 16V 4x4 | 103 | 11/10 → 05/15 | 1.968 | D | M | 4 | 16 | CFFB | | 84001 |
| 2.0 TDI 4x4 | 125 | 09/08 → 05/15 | 1.968 | D | M | 4 | 16 | CBBB, CFGB | | 81816 |
| | 125 | 09/08 → 05/15 | 1.968 | D | M | 4 | 16 | CBBB, CFGB | | 84011 NEW |
| 2.0 TSI | 147 | 05/10 → 05/15 | 1.984 | B | M | 4 | 16 | CCZA | | 84016 NEW |
| 3.6 FSI 4x4 | 191 | 04/09 → 05/15 | 3.597 | B | M | 6 | 24 | | | 81866 |
| 3.6 V6 4x4 | 191 | 11/08 → 05/15 | 3.580 | B | M | 6 | 24 | CDVA | | 81866 |

Yeti

| | | | | | | | | | | |
|-------------|-----|---------|-------|---|---|---|----|------|--|------------------|
| 1.2 TSI | 77 | 09/09 → | 1.197 | B | M | 4 | 8 | CBZB | | 84045 NEW |
| | 81 | 05/15 → | 1.197 | B | M | 4 | 16 | CYVB | | 84062 NEW |
| 1.4 TSI | 90 | 06/10 → | 1.390 | B | M | 4 | 16 | CAXA | | 82097 |
| | 92 | 05/15 → | 1.395 | B | M | 4 | 16 | CZCA | | 84062 NEW |
| 1.4 TSI 4x4 | 110 | 05/15 → | 1.395 | B | M | 4 | 16 | CZDA | | 84062 NEW |

| | | | | | | | | | |
|--|--|--|--|--|--|--|--|--|--|
| | | | | | | | | | |
|--|--|--|--|--|--|--|--|--|--|

SKODA

Yeti

| | | | | | | | | | | | |
|-------------|-----|---------|-------|---|---|---|----|------------------|---------|-------|--|
| 1.6 | 81 | 04/14 → | 1.598 | B | M | 4 | 16 | CWVA | | 84062 | |
| 1.6 TDI | 77 | 11/10 → | 1.598 | D | M | 4 | 16 | CAYC | | 84001 | |
| 1.8 TSI 4x4 | 112 | 11/09 → | 1.798 | B | M | 4 | 16 | CDAB | | 84016 | |
| | 118 | 05/09 → | 1.798 | B | M | 4 | 16 | CDAA | | 84016 | |
| 2.0 TDI | 81 | 11/09 → | 1.968 | D | M | 4 | 16 | CFHA, CLCA | | 84001 | |
| | 103 | 11/11 → | 1.968 | D | M | 4 | 16 | CFHC | | 84001 | |
| 2.0 TDI 4x4 | 81 | 11/09 → | 1.968 | D | M | 4 | 16 | CFHF | | 84001 | |
| | 103 | 05/09 → | 1.968 | D | M | 4 | 16 | CBDB, CFHC, CLCB | M: CBDB | 81816 | |
| | 103 | 05/09 → | 1.968 | D | M | 4 | 16 | CBDB, CFHC, CLCB | M: CFHC | 84001 | |
| | 103 | 05/09 → | 1.968 | D | M | 4 | 16 | CBDB, CFHC, CLCB | | 84001 | |
| | 103 | 05/09 → | 1.968 | D | M | 4 | 16 | CBDB, CFHC, CLCB | | 84011 | |
| | 125 | 11/09 → | 1.968 | D | M | 4 | 16 | CEGA, CFJA | M: CEGA | 81816 | |
| | 125 | 11/09 → | 1.968 | D | M | 4 | 16 | CEGA, CFJA | M: CFJA | 84001 | |
| | 125 | 11/09 → | 1.968 | D | M | 4 | 16 | CEGA, CFJA | | 84001 | |
| | 125 | 11/09 → | 1.968 | D | M | 4 | 16 | CEGA, CFJA | | 84011 | |

SMART

Cabrio

| | | | | | | | | | | | |
|---------|----|---------------|-----|---|---|---|---|--------------------------|--|-------|--|
| 0.6 | 40 | 03/00 → 01/04 | 599 | B | M | 3 | 6 | M160.920, M160E6ALB03 | | 84012 | |
| | 45 | 01/01 → 01/04 | 599 | B | M | 3 | 6 | M160.920, M160E6ALB05 | | 84012 | |
| | 52 | 06/02 → 01/04 | 599 | B | M | 3 | 6 | M160.920 | | 84012 | |
| 0.7 | 45 | 01/03 → 01/04 | 698 | B | M | 3 | 6 | M160.910 | | 84012 | |
| | 55 | 01/03 → 01/04 | 698 | B | M | 3 | 6 | M160.910 | | 84012 | |
| 0.8 CDI | 30 | 03/01 → 01/04 | 799 | D | M | 3 | 6 | OM660.940, OM660DE8LA | | 84012 | |

City-Coupé

| | | | | | | | | | | | |
|---------|----|---------------|-----|---|---|---|---|--------------------------|--|-------|--|
| 0.6 | 33 | 07/98 → 01/04 | 599 | B | M | 3 | 6 | M160.920, M160E6ALB04 | | 84012 | |
| | 40 | 07/98 → 01/04 | 599 | B | M | 3 | 6 | M160.920, M160E6ALB03 | | 84012 | |
| | 45 | 01/01 → 01/04 | 599 | B | M | 3 | 6 | M160.920, M160E6ALB05 | | 84012 | |
| | 52 | 06/02 → 01/04 | 599 | B | M | 3 | 6 | M160.920 | | 84012 | |
| 0.70.7 | 37 | 01/03 → 01/04 | 698 | B | M | 3 | 6 | M160.910 | | 84012 | |
| | 45 | 01/03 → 01/04 | 698 | B | M | 3 | 6 | M160.910 | | 84012 | |
| | 55 | 01/03 → 01/04 | 698 | B | M | 3 | 6 | M160.910 | | 84012 | |
| 0.8 CDI | 30 | 11/99 → 01/04 | 799 | D | M | 3 | 6 | OM660.940, OM660DE8LA | | 84012 | |

CrossBlade

| | | | | | | | | | | | |
|-----|----|---------------|-----|---|---|---|---|----------|--|-------|--|
| 0.6 | 52 | 06/02 → 12/03 | 599 | B | M | 3 | 6 | M160.920 | | 84012 | |
|-----|----|---------------|-----|---|---|---|---|----------|--|-------|--|

KW

cm³

NO. OF VALVES

SMART
ForFour I

| | | | | | | | | | | |
|------------|-----|---------------|-------|---|---|---|----|-----------|--|-------|
| 1.1 | 47 | 02/05 → 06/06 | 1.124 | B | M | 3 | 12 | M134.911 | | 82049 |
| | 55 | 01/04 → 06/06 | 1.124 | B | M | 3 | 12 | M134.910 | | 82049 |
| 1.3 | 70 | 01/04 → 06/06 | 1.332 | B | M | 4 | 16 | M135.930 | | 82049 |
| 1.5 | 80 | 01/04 → 06/06 | 1.499 | B | M | 4 | 16 | M135.950 | | 82049 |
| | 90 | 01/04 → 06/06 | 1.499 | B | M | 4 | 16 | M135.950 | | 82049 |
| 1.5 BRABUS | 130 | 05/05 → 06/06 | 1.468 | B | M | 4 | 16 | M122.950 | | 82049 |
| 1.5 CDI | 50 | 09/04 → 06/06 | 1.493 | D | M | 3 | 12 | OM639.939 | | 82017 |
| | 70 | 09/04 → 06/06 | 1.493 | D | M | 3 | 12 | OM639.939 | | 82017 |

ForFour II

| | | | | | | | | | | |
|-----|----|---------|-----|---|---|---|----|----------|--|-------|
| 0.9 | 66 | 11/14 → | 898 | B | M | 3 | 12 | M281.910 | | 84003 |
| 1.0 | 45 | 11/14 → | 999 | B | M | 3 | 12 | M281.920 | | 84003 |
| | 52 | 07/14 → | 999 | B | M | 3 | 12 | M281.920 | | 84003 |

ForTwo I Coupé, Cabrio

| | | | | | | | | | | | |
|---------|----|---------------|-----|---|---|---|---|-----------------------|--|-------|------------|
| 0.7 | 37 | 01/04 → 01/07 | 698 | B | M | 3 | 6 | M160.910 | | 84012 | NEW |
| | 45 | 01/04 → 01/07 | 698 | B | M | 3 | 6 | M160.910 | | 84012 | NEW |
| | 55 | 01/04 → 01/07 | 698 | B | M | 3 | 6 | M160.910 | | 84012 | NEW |
| 0.8 CDI | 30 | 01/04 → 01/07 | 799 | D | M | 3 | 6 | OM660.940 | | 84012 | NEW |
| | 30 | 01/04 → 01/07 | 799 | D | M | 3 | 6 | OM660.940, OM660DE8LA | | 84012 | NEW |

ForTwo II Coupé, Cabrio

| | | | | | | | | | | | |
|---------|----|---------|-----|---|---|---|---|-----------|--|-------|------------|
| 0.8 CDi | 33 | 01/07 → | 799 | D | M | 3 | 6 | OM660.950 | | 84012 | NEW |
| | 40 | 08/09 → | 799 | D | M | 3 | 6 | OM660.951 | | 84012 | NEW |

ForTwo III Coupé, Cabrio

| | | | | | | | | | | |
|-----|----|---------|-----|---|---|---|----|----------|--|-------|
| 0.9 | 66 | 09/15 → | 898 | B | M | 3 | 12 | M281.910 | | 84003 |
| 1.0 | 45 | 11/14 → | 999 | B | M | 3 | 12 | M281.920 | | 84003 |
| | 52 | 09/15 → | 999 | B | M | 3 | 12 | M281.920 | | 84003 |

Roadster

| | | | | | | | | | | | |
|------------|----|---------------|-----|---|---|---|---|----------|--|-------|------------|
| 0.7 | 45 | 04/03 → 11/05 | 698 | B | M | 3 | 6 | M160.921 | | 84012 | NEW |
| | 45 | 06/03 → 11/05 | 698 | B | M | 3 | 6 | M160.922 | | 84012 | NEW |
| | 60 | 04/03 → 11/05 | 698 | B | M | 3 | 6 | M160.921 | | 84012 | NEW |
| | 60 | 04/03 → 11/05 | 698 | B | M | 3 | 6 | M160.922 | | 84012 | NEW |
| 0.7 Brabus | 74 | 12/03 → 11/05 | 698 | B | M | 3 | 6 | M160.923 | | 84012 | NEW |

SSANGYONG
Korando II, Cabrio

| | | | | | | | | | | |
|--------|-----|---------|-------|---|---|---|----|-----------|--|-------|
| 2.3 D | 58 | 12/96 → | 2.299 | D | M | 4 | 8 | OM601.940 | | 81506 |
| 2.9 D | 72 | 11/97 → | 2.874 | D | M | 5 | 10 | MB-OM662 | | 81506 |
| | 72 | 12/96 → | 2.874 | D | M | 5 | 10 | MB-OM662 | | 81506 |
| 2.9 TD | 88 | 04/98 → | 2.874 | D | M | 5 | 10 | | | 81506 |
| 3.2 | 156 | 01/99 → | 3.199 | B | M | 6 | 24 | M104.995 | | 81724 |
| | 162 | 06/97 → | 3.199 | B | M | 6 | 24 | M104.992 | | 81724 |
| | 154 | 12/96 → | 3.199 | B | M | 6 | 24 | M104.995 | | 81724 |

| | | | | | | | | | |
|--|--|--|--|--|--|--|--|--|--|
| | | | | | | | | | |
|--|--|--|--|--|--|--|--|--|--|

SSANGYONG

Musso

| | | | | | | | | | | |
|--------|-----|---------|-------|---|---|---|----|------------------------|--|-------|
| 2.3 D | 59 | 10/95 → | 2.299 | D | M | 4 | 8 | MB-OM661, OM601.940 | | 81506 |
| 2.9 D | 73 | 03/96 → | 2.874 | D | M | 5 | 10 | MB-OM662 | | 81506 |
| 2.9 TD | 88 | 04/98 → | 2.874 | D | M | 5 | 10 | | | 81506 |
| 3.2 | 162 | 06/96 → | 3.199 | B | M | 6 | 24 | M104.992 | | 81724 |

Rexton

| | | | | | | | | | | |
|--------|-----|---------|-------|---|---|---|----|------|--|-------|
| 2.9 TD | 88 | 04/02 → | 2.874 | D | M | 5 | 10 | | | 81506 |
| 3.2 | 162 | 04/02 → | 3.199 | B | M | 6 | 24 | G32D | | 81724 |

SUBARU

Justy II

| | | | | | | | | | | |
|------------|----|---------------|-------|---|---|---|----|-------|--|-------|
| 1.3 4x4 | 63 | 04/01 → 11/03 | 1.298 | B | M | 4 | 16 | G13BB | | 81858 |
| 1.3 GX 4x4 | 50 | 10/95 → 11/03 | 1.298 | B | M | 4 | 8 | EF13 | | 81858 |

Justy III

| | | | | | | | | | | |
|---------|----|---------|-------|---|---|---|----|------|--|-------|
| 1.3 AWD | 69 | 09/03 → | 1.328 | B | M | 4 | 16 | M13A | | 82026 |
| 1.5 AWD | 73 | 09/03 → | 1.490 | B | M | 4 | 16 | M15A | | 82026 |

Justy IV

| | | | | | | | | | | |
|-----|----|---------|-----|---|---|---|----|--------|--|-------|
| 1.0 | 51 | 01/07 → | 998 | B | M | 3 | 12 | 1KR-FE | | 82063 |
|-----|----|---------|-----|---|---|---|----|--------|--|-------|

Trezia

| | | | | | | | | | | |
|-------|----|---------|-------|---|---|---|----|-----------------|--|-------|
| 1.3 | 73 | 03/11 → | 1.329 | B | M | 4 | 16 | 1NR-FE, 1NR-FKE | | 84032 |
| 1.4 D | 66 | 03/11 → | 1.364 | D | M | 4 | 8 | 1ND-TV | | 84029 |

SUZUKI

ALTO

| | | | | | | | | | | |
|-----|----|---------------|-----|---|---|---|----|-------|--|-------|
| 1.0 | 43 | 01/00 → 06/02 | 993 | B | M | 4 | 16 | G10BB | | 81858 |
|-----|----|---------------|-----|---|---|---|----|-------|--|-------|

Alto III

| | | | | | | | | | | |
|-----|----|---------------|-----|---|---|---|----|-------|-----------|-------|
| 1.0 | 39 | 09/94 → 09/98 | 993 | B | M | 4 | 16 | G10BB | 01-1991 → | 81858 |
|-----|----|---------------|-----|---|---|---|----|-------|-----------|-------|

Alto IV

| | | | | | | | | | | |
|-----|----|---------------|-------|---|---|---|----|-------------|--|-------|
| 1.1 | 46 | 09/04 → 12/08 | 1.061 | B | M | 4 | 16 | F10D, F10DN | | 81858 |
|-----|----|---------------|-------|---|---|---|----|-------------|--|-------|

Alto V

| | | | | | | | | | | |
|-----|----|---------|-----|---|---|---|----|------|--|-------|
| 1.0 | 50 | 01/09 → | 996 | B | M | 3 | 12 | K10B | | 84017 |
|-----|----|---------|-----|---|---|---|----|------|--|-------|

Baleno, Station Wagon

| | | | | | | | | | | |
|---------------|----|---------------|-------|---|---|---|----|--------------------------------|-----------|-------|
| 1.3 | 52 | 09/96 → 05/02 | 1.298 | B | M | 4 | 8 | G13BA | | 81858 |
| 1.3 16V | 63 | 03/97 → 05/02 | 1.298 | B | M | 4 | 16 | G13BB | | 81858 |
| 1.3 i 16V | 63 | 07/95 → 05/02 | 1.298 | B | M | 4 | 16 | G13BB | 01-1994 → | 81858 |
| 1.6 i 16V | 72 | 07/95 → 05/02 | 1.590 | B | M | 4 | 16 | G16B | | 81790 |
| | 73 | 08/96 → 05/02 | 1.590 | B | M | 4 | 16 | G16B | | 81790 |
| 1.6 i 16V 4x4 | 72 | 07/95 → 05/02 | 1.590 | B | M | 4 | 16 | G16B | | 81790 |
| 1.8 GTX | 89 | 03/96 → 05/02 | 1.839 | B | M | 4 | 16 | J18A | | 81790 |
| 1.8 i 16V | 89 | 08/96 → 05/02 | 1.839 | B | M | 4 | 16 | J18A | | 81790 |
| 1.9 TD | 55 | 04/98 → 05/02 | 1.905 | D | M | 4 | 8 | DHV (XUD9BSD), DHW (XUD9SD) | | 81642 |
| | 55 | 04/98 → 05/02 | 1.905 | D | M | 4 | 8 | DHW (XUD9SD) | | 81642 |

KW

cm³

NO. OF VALVES

SUZUKI
Cappucino

| | | | | | | | | | | |
|-----|----|---------------|-----|---|---|---|----|-----|--|-------|
| 0.7 | 47 | 02/92 → 08/95 | 657 | B | M | 3 | 12 | F6A | | 81783 |
|-----|----|---------------|-----|---|---|---|----|-----|--|-------|

Celerio

| | | | | | | | | | | |
|-----|----|---------|-----|---|---|---|----|------|--|------------------|
| 1.0 | 50 | 03/14 → | 998 | B | M | 3 | 12 | K10B | | 84017 NEW |
|-----|----|---------|-----|---|---|---|----|------|--|------------------|

Grand Vitara I

| | | | | | | | | | | |
|---------|----|---------------|-------|---|---|---|----|------|--|-------|
| 1.6 4x4 | 69 | 03/98 → 07/03 | 1.590 | B | M | 4 | 16 | G16B | | 82050 |
|---------|----|---------------|-------|---|---|---|----|------|--|-------|

| | | | | | | | | | | |
|--|----|---------------|-------|---|---|---|----|------|--|-------|
| | 73 | 02/00 → 09/02 | 1.590 | B | M | 4 | 16 | G16B | | 82050 |
|--|----|---------------|-------|---|---|---|----|------|--|-------|

| | | | | | | | | | | |
|-----------------|----|---------------|-------|---|---|---|----|----------|--|-------|
| 2.0 HDI 110 16V | 80 | 07/01 → 09/05 | 1.997 | D | M | 4 | 16 | RHW, RHZ | | 81713 |
|-----------------|----|---------------|-------|---|---|---|----|----------|--|-------|

Grand Vitara II

| | | | | | | | | | | |
|------------------------|----|---------------|-------|---|---|---|----|------|--|-------|
| 1.6 Trazione integrale | 73 | 09/05 → 02/15 | 1.586 | B | M | 4 | 16 | M16A | | 82050 |
|------------------------|----|---------------|-------|---|---|---|----|------|--|-------|

| | | | | | | | | | | |
|--|----|---------|-------|---|---|---|----|------|--|-------|
| | 78 | 04/05 → | 1.586 | B | M | 4 | 16 | M16A | | 82050 |
|--|----|---------|-------|---|---|---|----|------|--|-------|

| | | | | | | | | | | |
|----------|----|---------------|-------|---|---|---|---|------|--|-------|
| 1.9 DDiS | 95 | 10/05 → 02/15 | 1.870 | D | M | 4 | 8 | F9QB | | 81868 |
|----------|----|---------------|-------|---|---|---|---|------|--|-------|

| | | | | | | | | | | |
|--|----|---------------|-------|---|---|---|---|------|--|-------|
| | 95 | 10/05 → 02/15 | 1.870 | D | M | 4 | 8 | F9QB | | 84006 |
|--|----|---------------|-------|---|---|---|---|------|--|-------|

Ignis I

| | | | | | | | | | | |
|-----|----|---------------|-------|---|----|---|----|------|---------|-------|
| 1.3 | 61 | 10/00 → 09/03 | 1.328 | B | AM | 4 | 16 | M13A | M: M13A | 82026 |
|-----|----|---------------|-------|---|----|---|----|------|---------|-------|

| | | | | | | | | | | |
|---------|----|---------------|-------|---|---|---|----|------|--|-------|
| 1.3 4WD | 61 | 10/00 → 09/03 | 1.328 | B | M | 4 | 16 | M13A | | 82026 |
|---------|----|---------------|-------|---|---|---|----|------|--|-------|

Ignis II

| | | | | | | | | | | |
|-----|----|---------|-------|---|---|---|----|------|--|-------|
| 1.3 | 69 | 09/03 → | 1.328 | B | M | 4 | 16 | M13A | | 82026 |
|-----|----|---------|-------|---|---|---|----|------|--|-------|

| | | | | | | | | | | |
|---------|----|---------|-------|---|---|---|----|------|--|-------|
| 1.3 4x4 | 69 | 09/03 → | 1.328 | B | M | 4 | 16 | M13A | | 82026 |
|---------|----|---------|-------|---|---|---|----|------|--|-------|

| | | | | | | | | | | |
|----------|----|---------|-------|---|---|---|----|-------|--|-------|
| 1.3 DDiS | 51 | 09/03 → | 1.248 | D | M | 4 | 16 | Z13DT | | 81862 |
|----------|----|---------|-------|---|---|---|----|-------|--|-------|

| | | | | | | | | | | |
|-----|----|---------|-------|---|---|---|----|------|--|-------|
| 1.5 | 73 | 09/03 → | 1.490 | B | M | 4 | 16 | M15A | | 82026 |
|-----|----|---------|-------|---|---|---|----|------|--|-------|

| | | | | | | | | | | |
|---------|----|---------|-------|---|---|---|----|------|--|-------|
| 1.5 4x4 | 73 | 09/03 → | 1.490 | B | M | 4 | 16 | M15A | | 82026 |
|---------|----|---------|-------|---|---|---|----|------|--|-------|

| | | | | | | | | | | |
|-----------|----|---------|-------|---|---|---|----|------|--|-------|
| 1.5 Sport | 80 | 12/03 → | 1.490 | B | M | 4 | 16 | M15A | | 82026 |
|-----------|----|---------|-------|---|---|---|----|------|--|-------|

Jimny

| | | | | | | | | | | |
|---------|----|---------|-------|---|---|---|----|-------|--|-------|
| 1.3 16V | 59 | 09/98 → | 1.298 | B | M | 4 | 16 | G13BB | | 81789 |
|---------|----|---------|-------|---|---|---|----|-------|--|-------|

| | | | | | | | | | | |
|--|----|---------|-------|---|---|---|----|------|--|-------|
| | 60 | 02/01 → | 1.328 | B | M | 4 | 16 | M13A | | 82026 |
|--|----|---------|-------|---|---|---|----|------|--|-------|

| | | | | | | | | | | |
|-------------|----|---------|-------|---|---|---|----|-------|--|-------|
| 1.3 16V 4WD | 59 | 09/98 → | 1.298 | B | M | 4 | 16 | G13BB | | 81789 |
|-------------|----|---------|-------|---|---|---|----|-------|--|-------|

| | | | | | | | | | | |
|--|----|---------|-------|---|---|---|----|------|----------|-------|
| | 60 | 02/01 → | 1.328 | B | M | 4 | 16 | M13A | M: G13BB | 82026 |
|--|----|---------|-------|---|---|---|----|------|----------|-------|

| | | | | | | | | | | |
|-------------|----|---------|-------|---|---|---|----|------|--|-------|
| 1.3 16V 4x4 | 63 | 08/05 → | 1.328 | B | M | 4 | 16 | M13A | | 82026 |
|-------------|----|---------|-------|---|---|---|----|------|--|-------|

| | | | | | | | | | | |
|---------|----|---------|-------|---|---|---|----|------|--|-------|
| 1.3 4WD | 62 | 05/14 → | 1.328 | B | M | 4 | 16 | M13A | | 82026 |
|---------|----|---------|-------|---|---|---|----|------|--|-------|

| | | | | | | | | | | |
|---------|----|---------------|-------|---|---|---|----|-------|--|-------|
| 1.3 4x4 | 63 | 09/98 → 08/00 | 1.298 | B | M | 4 | 16 | G13BB | | 81789 |
|---------|----|---------------|-------|---|---|---|----|-------|--|-------|

| | | | | | | | | | | |
|--|----|---------------|-------|---|---|---|----|------|--|-------|
| | 65 | 09/00 → 08/02 | 1.328 | B | M | 4 | 16 | M13A | | 82026 |
|--|----|---------------|-------|---|---|---|----|------|--|-------|

| | | | | | | | | | | |
|--------------|----|---------|-------|---|---|---|---|--------|--|-------|
| 1.5 DDiS 4WD | 48 | 12/03 → | 1.461 | D | M | 4 | 8 | K9K700 | | 81810 |
|--------------|----|---------|-------|---|---|---|---|--------|--|-------|

| | | | | | | | | | | |
|--------------|----|---------|-------|---|---|---|----|--------|--|-------|
| 1.5 DDiS 4x4 | 63 | 08/05 → | 1.461 | D | M | 4 | 16 | K9K266 | | 84007 |
|--------------|----|---------|-------|---|---|---|----|--------|--|-------|

Liana

| | | | | | | | | | | |
|-----|----|---------|-------|---|---|---|----|------|--|-------|
| 1.3 | 66 | 03/02 → | 1.328 | B | M | 4 | 16 | M13A | | 82026 |
|-----|----|---------|-------|---|---|---|----|------|--|-------|

| | | | | | | | | | | |
|----------|----|---------|-------|---|---|---|----|-----|--|-------|
| 1.4 DDiS | 66 | 04/04 → | 1.398 | D | M | 4 | 16 | 8HY | | 81798 |
|----------|----|---------|-------|---|---|---|----|-----|--|-------|

| | | | | | | | | | | |
|-----|----|---------------|-------|---|----|---|----|------|--|-------|
| 1.6 | 76 | 07/01 → 12/07 | 1.586 | B | AM | 4 | 16 | M16A | | 82026 |
|-----|----|---------------|-------|---|----|---|----|------|--|-------|

| | | | | | | | | | | |
|--|----|---------|-------|---|---|---|----|------|--|-------|
| | 76 | 03/02 → | 1.586 | B | M | 4 | 16 | M16A | | 82026 |
|--|----|---------|-------|---|---|---|----|------|--|-------|

| | | | | | | | | | | |
|---------|----|---------------|-------|---|----|---|----|------|--|-------|
| 1.6 4WD | 76 | 07/01 → 12/07 | 1.586 | B | AM | 4 | 16 | M16A | | 82026 |
|---------|----|---------------|-------|---|----|---|----|------|--|-------|

| | | | | | | | | | | |
|--|----|---------|-------|---|---|---|----|------|--|-------|
| | 76 | 03/02 → | 1.586 | B | M | 4 | 16 | M16A | | 82026 |
|--|----|---------|-------|---|---|---|----|------|--|-------|

| | | | | | | | | | | |
|--|----|---------|-------|---|---|---|----|------|--|-------|
| | 78 | 04/02 → | 1.586 | B | M | 4 | 16 | M16A | | 82026 |
|--|----|---------|-------|---|---|---|----|------|--|-------|

| | | | | | | | | | | |
|-------|----|---------|-------|---|---|---|----|------|--|-------|
| 1.6 i | 78 | 04/02 → | 1.586 | B | M | 4 | 16 | M16A | | 82026 |
|-------|----|---------|-------|---|---|---|----|------|--|-------|



KW



cm³



NO. OF VALVES



MAGNETI MARELLI

SUZUKI

Samurai

| | | | | | | | | | | |
|------------------------|----|---------------|-------|---|---|---|---|-------|--|-------|
| 1.3 | 47 | 11/88 → 12/04 | 1.324 | B | M | 4 | 8 | G13A | | 81789 |
| 1.3 Trazione integrale | 51 | 11/88 → 12/04 | 1.298 | B | M | 4 | 8 | G13BA | | 81789 |
| | 44 | 11/88 → 12/04 | 1.324 | B | M | 4 | 8 | G13A | | 81789 |
| 1.9 TD | 46 | 11/98 → 12/04 | 1.905 | D | M | 4 | 8 | XUD9 | | 81642 |

SJ 413

| | | | | | | | | | | |
|-----|----|---------------|-------|---|---|---|---|------|--|-------|
| 1.3 | 44 | 08/86 → 08/90 | 1.324 | B | M | 4 | 8 | G13A | | 81789 |
| | 47 | 09/84 → 08/90 | 1.324 | B | M | 4 | 8 | G13A | | 81789 |

Splash

| | | | | | | | | | | | |
|----------|----|---------|-------|---|---|---|----|--------------|--|-------|--|
| 1.0 | 48 | 01/08 → | 996 | B | M | 3 | 12 | K10B | | 84017 | |
| | 50 | 06/11 → | 996 | B | M | 3 | 12 | K10B | | 84017 | |
| 1.2 | 63 | 01/08 → | 1.242 | B | M | 4 | 16 | K12B | | 84017 | |
| 1.2 VVT | 66 | 06/11 → | 1.242 | B | M | 4 | 16 | K12B | | 84017 | |
| | 69 | 09/10 → | 1.242 | B | M | 4 | 16 | K12B | | 84017 | |
| 1.3 CDTI | 55 | 01/08 → | 1.248 | D | M | 4 | 16 | D13A, Z13DTJ | | 81862 | |

Swift II, Cabrio

| | | | | | | | | | | |
|-----------|----|---------------|-------|---|---|---|----|-------|--|-------|
| 1.0 | 37 | 03/89 → 05/01 | 993 | B | M | 3 | 6 | G10A | | 81858 |
| 1.0 i | 39 | 01/95 → 12/05 | 993 | B | M | 3 | 6 | G10A | | 81858 |
| | 40 | 03/89 → 12/91 | 993 | B | M | 3 | 6 | G10A | | 81858 |
| 1.3 | 50 | 03/89 → 05/01 | 1.298 | B | M | 4 | 8 | G13A | | 81858 |
| | 50 | 03/89 → 05/01 | 1.324 | B | M | 4 | 8 | G13A | | 81858 |
| | 52 | 03/89 → 12/91 | 1.324 | B | M | 4 | 8 | G13A | | 81858 |
| 1.3 4WD | 50 | 03/89 → 05/01 | 1.324 | B | M | 4 | 8 | G13A | | 81858 |
| | 52 | 10/89 → 12/91 | 1.324 | B | M | 4 | 8 | G13A | | 81858 |
| 1.3 GTi | 74 | 03/89 → 05/01 | 1.298 | B | M | 4 | 16 | G13B | | 81858 |
| 1.3 i | 50 | 09/91 → 10/96 | 1.298 | B | M | 4 | 8 | G13BA | | 81858 |
| 1.6 | 70 | 11/89 → 12/91 | 1.590 | B | M | 4 | 16 | G16B | | 81790 |
| 1.6 4WD | 70 | 11/89 → 12/91 | 1.590 | B | M | 4 | 16 | G16B | | 81790 |
| 1.6 i | 68 | 01/90 → 05/01 | 1.590 | B | M | 4 | 16 | G16B | | 81790 |
| 1.6 i 4WD | 68 | 01/90 → 05/01 | 1.590 | B | M | 4 | 16 | G16B | | 81790 |

Swift III

| | | | | | | | | | | |
|----------|----|---------|-------|---|---|---|----|--------------|--|-------|
| 1.3 | 68 | 02/05 → | 1.328 | B | M | 4 | 16 | M13A | | 82026 |
| 1.3 4x4 | 66 | 01/06 → | 1.328 | B | M | 4 | 16 | M13A | | 82026 |
| | 68 | 02/05 → | 1.328 | B | M | 4 | 16 | M13A | | 82026 |
| 1.3 DDiS | 51 | 08/05 → | 1.248 | D | M | 4 | 16 | Z13DT | | 81862 |
| | 55 | 08/05 → | 1.248 | D | M | 4 | 16 | D13A, Z13DTJ | | 81862 |
| 1.5 | 75 | 02/05 → | 1.490 | B | M | 4 | 16 | M15A | | 82026 |
| 1.5 4x4 | 74 | 02/05 → | 1.490 | B | M | 4 | 16 | M15A | | 82026 |
| 1.6 | 92 | 05/06 → | 1.586 | B | M | 4 | 16 | M16A | | 82026 |

Swift IV

| | | | | | | | | | | | |
|----------|----|---------|-------|---|---|---|----|------|--|-------|--|
| 1.2 | 66 | 10/10 → | 1.242 | B | M | 4 | 16 | K12B | | 84017 | |
| | 69 | 10/10 → | 1.242 | B | M | 4 | 16 | K12B | | 84017 | |
| 1.2 4x4 | 66 | 10/10 → | 1.242 | B | M | 4 | 16 | K12B | | 84017 | |
| | 69 | 10/10 → | 1.242 | B | M | 4 | 16 | K12B | | 84017 | |
| 1.3 DDiS | 55 | 10/10 → | 1.248 | D | M | 4 | 16 | D13A | | 81862 | |

KW

cm³

NO. OF VALVES

MAGNETI MARELLI
SUZUKI
Swift IV

| | | | | | | | | | | |
|-----|-----|---------|-------|---|---|---|----|------|--|-------|
| 1.6 | 100 | 01/12 → | 1.586 | B | M | 4 | 16 | M16A | | 82026 |
|-----|-----|---------|-------|---|---|---|----|------|--|-------|

SX4

| | | | | | | | | | | |
|--------------|----|---------|-------|---|---|---|----|-------|--|-------|
| 1.5 | 73 | 06/06 → | 1.490 | B | M | 4 | 16 | M15A | | 82026 |
| 1.6 | 74 | 06/06 → | 1.586 | B | M | 4 | 16 | M16A | | 82026 |
| | 75 | 10/07 → | 1.586 | B | M | 4 | 16 | M16A | | 82026 |
| | 79 | 10/07 → | 1.586 | B | M | 4 | 16 | M16A | | 82026 |
| 1.6 DDiS | 66 | 04/07 → | 1.560 | D | M | 4 | 16 | 9HX | | 81869 |
| 1.6 VVT | 79 | 06/06 → | 1.586 | B | M | 4 | 16 | M16A | | 82026 |
| | 88 | 07/09 → | 1.586 | B | M | 4 | 16 | M16A | | 82026 |
| 1.6 VVT 4x4 | 79 | 06/06 → | 1.586 | B | M | 4 | 16 | M16A | | 82026 |
| | 88 | 07/09 → | 1.586 | B | M | 4 | 16 | M16A | | 82026 |
| 1.9 DDiS | 88 | 06/06 → | 1.910 | D | M | 4 | 8 | D19AA | | 81352 |
| 1.9 DDiS 4x4 | 88 | 06/06 → | 1.910 | D | M | 4 | 8 | D19AA | | 81352 |
| 2.0 DDiS | 99 | 07/09 → | 1.956 | D | M | 4 | 16 | D20AA | | 81872 |
| 2.0 DDiS 4x4 | 99 | 07/09 → | 1.956 | D | M | 4 | 16 | D20AA | | 81872 |

Vitara

| | | | | | | | | | | |
|-------------------------------|-----|---------------|-------|---|---|---|----|-----------|--|-------|
| 1.6 | 88 | 02/15 → | 1.586 | B | M | 4 | 16 | M16A | | 82026 |
| | 59 | 07/88 → 01/95 | 1.589 | B | M | 4 | 8 | G16A (8V) | | 81790 |
| 1.6 i 16V | 71 | 07/90 → 03/99 | 1.589 | B | M | 4 | 16 | G16B | | 81790 |
| 1.6 i 16V Trazione integrale | 71 | 07/90 → 03/98 | 1.589 | B | M | 4 | 16 | G16B | | 81790 |
| 1.6 Trazione integrale | 59 | 07/88 → 03/98 | 1.589 | B | M | 4 | 8 | G16A (8V) | | 81790 |
| | 60 | 07/88 → 12/91 | 1.589 | B | M | 4 | 8 | G16A (8V) | | 81790 |
| 1.9 D | 50 | 01/95 → 03/98 | 1.905 | D | M | 4 | 8 | XUD9A | | 81642 |
| | 55 | 08/96 → 03/99 | 1.905 | D | M | 4 | 8 | XUD9SD | | 81642 |
| 1.9 D Trazione integrale | 50 | 01/95 → 03/98 | 1.905 | D | M | 4 | 8 | XUD9A | | 81642 |
| | 55 | 08/96 → 03/98 | 1.905 | D | M | 4 | 8 | XUD9SD | | 81642 |
| 2.0 V6 24V Trazione integrale | 100 | 12/94 → 03/98 | 1.998 | B | M | 6 | 24 | H20A | | 81790 |

Wagon R+ II

| | | | | | | | | | | |
|----------|----|---------------|-------|---|----|---|----|-------|--|-------|
| 1.3 | 56 | 05/00 → 12/04 | 1.298 | B | AM | 4 | 16 | G13BB | | 81858 |
| | 65 | 08/01 → | 1.328 | B | M | 4 | 16 | M13A | | 82026 |
| | 69 | 09/03 → | 1.328 | B | M | 4 | 16 | M13A | | 82026 |
| 1.3 4WD | 56 | 10/01 → | 1.298 | B | M | 4 | 16 | G13BB | | 81858 |
| | 69 | 09/03 → | 1.328 | B | M | 4 | 16 | M13A | | 82026 |
| 1.3 DDiS | 51 | 09/03 → | 1.248 | D | M | 4 | 16 | Z13DT | | 81862 |

X-90

| | | | | | | | | | | |
|---------------|----|---------------|-------|---|---|---|----|------|--|-------|
| 1.6 i 16V | 71 | 09/95 → 12/97 | 1.590 | B | M | 4 | 16 | G16B | | 81790 |
| 1.6 i 16V 4x4 | 71 | 09/95 → 12/97 | 1.590 | B | M | 4 | 16 | G16B | | 81790 |

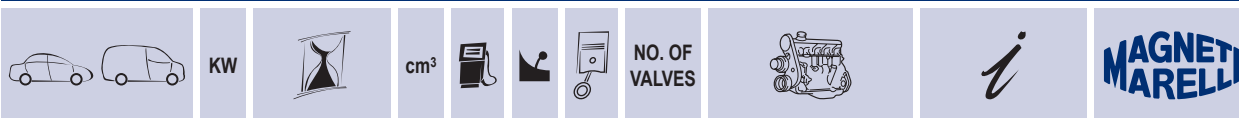
TOYOTA
Auris I, Van

| | | | | | | | | | | | |
|----------------|-----|---------------|-------|---|---|---|----|---------|-----------|-------|------------|
| 1.33 Dual-VVTi | 73 | 01/10 → 09/12 | 1.329 | B | M | 4 | 16 | 1NR-FE | | 84032 | NEW |
| | 74 | 05/09 → 09/12 | 1.329 | B | M | 4 | 16 | 1NR-FE | | 84032 | NEW |
| 1.4 D-4D | 66 | 03/07 → 09/12 | 1.364 | D | M | 4 | 8 | 1ND-TV | → 01-2009 | 81821 | |
| | 66 | 03/07 → 09/12 | 1.364 | D | M | 4 | 8 | 1ND-TV | 02-2009 → | 84029 | NEW |
| 1.4 VVTi | 71 | 03/07 → 09/12 | 1.398 | B | M | 4 | 16 | 4ZZ-FE | | 82012 | |
| 1.6 | 97 | 05/09 → 09/12 | 1.598 | B | M | 4 | 16 | 1ZR-FAE | | 84030 | NEW |
| 1.6 VVTi | 91 | 03/07 → 09/12 | 1.598 | B | M | 4 | 16 | 1ZR-FE | | 84030 | NEW |
| 1.8 | 106 | 02/09 → 09/12 | 1.798 | B | M | 4 | 16 | 2ZR-FAE | | 84030 | NEW |
| | 108 | 02/09 → 09/12 | 1.798 | B | M | 4 | 16 | 2ZR-FAE | | 84030 | NEW |
| 1.8 4WD | 100 | 02/09 → 09/12 | 1.798 | B | M | 4 | 16 | 2ZR-FAE | | 84030 | NEW |
| 2.0 D-4D | 93 | 03/07 → 09/12 | 1.998 | D | M | 4 | 16 | 1AD-FTV | | 82071 | |
| 2.2 D | 130 | 03/07 → 09/12 | 2.231 | D | M | 4 | 16 | 2AD-FHV | | 82071 | |

Auris II, Touring Sports, Van

| | | | | | | | | | | | |
|----------|----|---------|-------|---|---|---|----|---------|--|-------|------------|
| 1.3 | 73 | 10/12 → | 1.329 | B | M | 4 | 16 | 1NR-FE | | 84032 | NEW |
| 1.4 D-4D | 66 | 10/12 → | 1.364 | D | M | 4 | 8 | 1ND-TV | | 84029 | NEW |
| 1.6 | 97 | 10/12 → | 1.598 | B | M | 4 | 16 | 1ZR-FAE | | 84030 | NEW |
| 1.6 D4-D | 82 | 04/15 → | 1.598 | D | M | 4 | 16 | 1WW | | 84026 | NEW |

Avenis I, Liftback, Station Wagon

| | | | | | | | | | | | |
|-----------|-----|---------------|-------|---|----|---|----|---------|--------------------|-------|--|
| 1.6 | 74 | 09/97 → 10/00 | 1.587 | B | M | 4 | 16 | 4A-FE | (+)COP | 81767 | |
| | 81 | 09/97 → 10/00 | 1.587 | B | M | 4 | 16 | 4A-FE | (+)COP | 81767 | |
| 1.6 VVT-i | 81 | 10/00 → 02/03 | 1.598 | B | M | 4 | 16 | 3ZZ-FE | | 82012 | |
| 1.8 | 81 | 09/97 → 10/00 | 1.762 | B | M | 4 | 16 | 7A-FE | (+)COP, OEM: AISIN | 81769 | |
| | 81 | 09/97 → 10/00 | 1.762 | B | M | 4 | 16 | 7A-FE | (+)COP, OEM: SEM | 81768 | |
| 1.8 VVT-i | 95 | 10/00 → 02/03 | 1.794 | B | AM | 4 | 16 | 1ZZ-FE | | 82012 | |
| 2.0 | 94 | 09/97 → 10/00 | 1.998 | B | M | 4 | 16 | 3S-FE | (-)COP, 01-1997 → | 81770 | |
| 2.0 D | 85 | 09/02 → 02/03 | 1.995 | D | M | 4 | 16 | 1CD-FTV | | 82022 | |
| 2.0 D-4D | 81 | 10/99 → 02/03 | 1.995 | D | M | 4 | 16 | 1CD-FTV | | 82022 | |
| 2.0 VVT-i | 110 | 10/00 → 02/03 | 1.998 | B | AM | 4 | 16 | 1AZ-FSE | | 82055 | |

Avenis II, Liftback, Station Wagon

| | | | | | | | | | | | |
|-----------|-----|---------------|-------|---|---|---|----|---------|-----------|-------|--|
| 1.6 VVT-i | 81 | 04/03 → 11/08 | 1.598 | B | M | 4 | 16 | 3ZZ-FE | | 82012 | |
| 1.8 | 95 | 04/03 → 11/08 | 1.794 | B | M | 4 | 16 | 1ZZ-FE | | 82012 | |
| 2.0 | 108 | 04/03 → 11/08 | 1.998 | B | M | 4 | 16 | 1AZ-FSE | | 82055 | |
| 2.0 D-4D | 85 | 04/03 → 11/08 | 1.995 | D | M | 4 | 16 | 1CD-FTV | → 06-2004 | 82022 | |
| | 85 | 04/03 → 11/08 | 1.995 | D | M | 4 | 16 | 1CD-FTV | 07-2004 → | 82044 | |
| | 93 | 03/06 → 11/08 | 1.998 | D | M | 4 | 16 | 1AD-FTV | | 82071 | |
| 2.0 VVTi | 114 | 04/03 → 11/08 | 1.998 | B | M | 4 | 16 | 1AZ-FE | | 82055 | |
| 2.2 D-4D | 110 | 10/05 → 11/08 | 2.231 | D | M | 4 | 16 | 2AD-FTV | | 82071 | |
| 2.2 D-CAT | 130 | 07/05 → 11/08 | 2.231 | D | M | 4 | 16 | 2AD-FHV | | 82071 | |
| 2.4 | 120 | 10/03 → 11/08 | 2.362 | B | M | 4 | 16 | 2AZ-FSE | | 82055 | |
| | 125 | 09/03 → 11/08 | 2.362 | B | M | 4 | 16 | 2AZ-FSE | | 82055 | |

KW

cm³

NO. OF VALVES

MAGNETI MARELLI
TOYOTA
Avensis III, Liftback, Station Wagon

| | | | | | | | | | | | |
|----------|-----|---------|-------|---|---|---|----|------------------|-----------|-------|------------|
| 1.6 | 97 | 02/09 → | 1.598 | B | M | 4 | 16 | 1ZR-FAE | | 84030 | NEW |
| 1.8 | 108 | 02/09 → | 1.798 | B | M | 4 | 16 | 2ZR-FAE | | 84030 | NEW |
| 2.0 | 112 | 02/09 → | 1.987 | B | M | 4 | 16 | 3ZR-FAE, 3ZR-FE | | 84030 | NEW |
| 2.0 D-4D | 93 | 02/09 → | 1.998 | D | M | 4 | 16 | 1AD-FTV | → 11-2011 | 82071 | |
| | 110 | 02/09 → | 2.231 | D | M | 4 | 16 | 2AD-FHV, 2AD-FTV | | 82071 | |
| | 130 | 02/09 → | 2.231 | D | M | 4 | 16 | 2AD-FHV | | 82071 | |

Avensis Verso

| | | | | | | | | | | | |
|--------------|-----|---------------|-------|---|----|---|----|---------|--|-------|--|
| 2.0 D-4D | 85 | 08/01 → 08/05 | 1.995 | D | M | 4 | 16 | 1CD-FTV | | 82022 | |
| 2.0 VVT-i | 110 | 08/01 → 11/09 | 1.998 | B | AM | 4 | 16 | 1AZ-FE | | 82055 | |
| 2.4 VVTi GLS | 115 | 10/03 → 11/09 | 2.362 | B | M | 4 | 16 | 2AZ-FE | | 82055 | |

Aygo I

| | | | | | | | | | | | |
|---------|----|---------------|-------|---|---|---|----|--------|--|-------|--|
| 1.0 | 50 | 07/05 → | 998 | B | M | 3 | 12 | 1KR-FE | | 82063 | |
| 1.0 GPL | 50 | 07/05 → | 998 | | M | 3 | 12 | 1KR-FE | | 82063 | |
| 1.4 HDi | 40 | 07/05 → 08/10 | 1.398 | D | M | 4 | 8 | 2WZ-TV | | 81798 | |

Aygo II

| | | | | | | | | | | | |
|-----|----|---------|-------|---|---|---|----|--------|--|-------|------------|
| 1.0 | 51 | 05/14 → | 998 | B | M | 3 | 12 | 1KR-FE | | 84054 | NEW |
| 1.2 | 60 | 05/14 → | 1.199 | B | M | 3 | 12 | 1PP | | 84054 | NEW |

Camry I, Liftback, Station Wagon

| | | | | | | | | | | | |
|-------------|----|---------------|-------|---|---|---|----|-------|--------|-------|--|
| 2.0 | 94 | 11/86 → 05/91 | 1.998 | B | M | 4 | 16 | 3S-FE | (-)COP | 81770 | |
| 2.0 Gli 16V | 89 | 11/86 → 05/91 | 1.998 | B | M | 4 | 16 | 3S-FE | (-)COP | 81770 | |

Camry II, Liftback, Station Wagon

| | | | | | | | | | | | |
|-----|-----|---------------|-------|---|---|---|----|-------|--------|-------|--|
| 2.2 | 100 | 06/91 → 08/96 | 2.164 | B | M | 4 | 16 | 5S-FE | (-)COP | 81770 | |
|-----|-----|---------------|-------|---|---|---|----|-------|--------|-------|--|

Camry III, Station Wagon

| | | | | | | | | | | | |
|---------|-----|---------------|-------|---|----|---|----|--------|-------------------|-------|--|
| 2.2 | 93 | 11/00 → 11/01 | 2.164 | B | M | 4 | 16 | 5S-FE | (-)COP | 81770 | |
| | 96 | 08/96 → 11/01 | 2.164 | B | AM | 4 | 16 | 5S-FE | (-)COP, 01-1993 → | 81770 | |
| 3.0 24V | 140 | 08/96 → 11/01 | 2.995 | B | A | 6 | 24 | 1MZ-FE | | 82051 | |
| 3.0 V6 | 135 | 08/96 → 11/01 | 2.995 | B | M | 6 | 24 | 1MZ-FE | | 82051 | |

Camry IV

| | | | | | | | | | | | |
|-----------------|-----|---------------|-------|---|----|---|----|---------|--|-------|--|
| 2.0 VVTi | 110 | 08/01 → 11/06 | 1.998 | B | M | 4 | 16 | 1AZ-FE | | 82055 | |
| 2.4 VVT-i | 112 | 11/01 → 11/06 | 2.362 | B | AM | 4 | 16 | 2AZ-FE | | 82055 | |
| 2.4 VVTi Hybrid | 105 | 01/06 → 11/06 | 2.362 | B | M | 4 | 16 | 2AZ-FXE | | 82055 | |
| 3.0 V6 | 137 | 11/01 → 11/06 | 2.995 | B | A | 6 | 24 | 1MZ-FE | | 82051 | |

Camry V

| | | | | | | | | | | | |
|----------|-----|---------------|-------|---|---|---|----|--------|--|-------|--|
| 2.4 VVTi | 116 | 01/06 → 09/11 | 2.362 | B | M | 4 | 16 | 2AZ-FE | | 82055 | |
| | 123 | 01/06 → 09/11 | 2.362 | B | M | 4 | 16 | 2AZ-FE | | 82055 | |

Carina E (T19), Station Wagon

| | | | | | | | | | | | |
|--------|----|---------------|-------|---|---|---|----|-------|--------|-------|--|
| 1.5 SG | 77 | 04/92 → 09/97 | 1.498 | B | M | 4 | 16 | 5A-FE | (-)COP | 81771 | |
|--------|----|---------------|-------|---|---|---|----|-------|--------|-------|--|

KW

cm³

NO. OF VALVES

TOYOTA
Carina E (T19), Station Wagon

| | | | | | | | | | | |
|-------------------|-----|---------------|-------|---|---|---|----|--------|---------------------------------|-------|
| 1.6 | 73 | 12/93 → 09/97 | 1.587 | B | M | 4 | 16 | 4A-FE | (-)COP | 81815 |
| | 73 | 12/93 → 09/97 | 1.587 | B | M | 4 | 16 | 4A-FE | (+)COP, → 12-1994 | 81766 |
| | 73 | 12/93 → 09/97 | 1.587 | B | M | 4 | 16 | 4A-FE | (+)COP, 01-1995 → | 81767 |
| | 73 | 01/95 → 09/97 | 1.587 | B | M | 4 | 16 | 4A-FE | (+)COP | 81767 |
| | 78 | 10/95 → 09/97 | 1.587 | B | M | 4 | 16 | 4A-FE | (+)COP | 81767 |
| | 79 | 01/93 → 09/97 | 1.587 | B | M | 4 | 16 | 4A-FE | (-)COP, → 12-1994 | 81815 |
| | 79 | 01/93 → 09/97 | 1.587 | B | M | 4 | 16 | 4A-FE | (+)COP, → 12-1994 | 81766 |
| | 79 | 01/93 → 09/97 | 1.587 | B | M | 4 | 16 | 4A-FE | (+)COP, 01-1995 → | 81767 |
| | 85 | 12/93 → 09/97 | 1.587 | B | M | 4 | 16 | 4A-FE | (-)COP | 81815 |
| | 85 | 12/93 → 09/97 | 1.587 | B | M | 4 | 16 | 4A-FE | (+)COP, → 12-1994 | 81766 |
| | 85 | 12/93 → 09/97 | 1.587 | B | M | 4 | 16 | 4A-FE | (+)COP, 01-1995 → | 81767 |
| 1.6 16V | 78 | 10/95 → 09/97 | 1.587 | B | M | 4 | 16 | 4A-FE | (+)COP | 81767 |
| | 85 | 12/94 → 09/97 | 1.587 | B | M | 4 | 16 | 4A-FE | (+)COP | 81767 |
| 1.6 GLI | 79 | 04/92 → 09/97 | 1.587 | B | M | 4 | 16 | 4A-FE | (-)COP | 81815 |
| | 79 | 04/92 → 09/97 | 1.587 | B | M | 4 | 16 | 4A-FE | (+)COP, → 12-1994 | 81766 |
| | 79 | 04/92 → 09/97 | 1.587 | B | M | 4 | 16 | 4A-FE | (+)COP, 01-1995 → | 81767 |
| 1.6 i | 73 | 02/95 → 09/97 | 1.587 | B | M | 4 | 16 | 4A-FE | (+)COP | 81767 |
| 1.8 | 85 | 04/92 → 09/97 | 1.762 | B | M | 4 | 16 | 7A-FE | (-)COP, → 12-1994 | 81770 |
| | 85 | 04/92 → 09/97 | 1.762 | B | M | 4 | 16 | 7A-FE | (+)COP, 01-1995 →, → 12-1995 | 81768 |
| | 85 | 04/92 → 09/97 | 1.762 | B | M | 4 | 16 | 7A-FE | (+)COP, 01-1996 → | 81769 |
| | 79 | 01/95 → 09/97 | 1.762 | B | M | 4 | 16 | 7A-FE | (+)COP, → 12-1995 | 81768 |
| | 79 | 01/95 → 09/97 | 1.762 | B | M | 4 | 16 | 7A-FE | (+)COP, 01-1996 → | 81769 |
| 1.8 GL | 92 | 10/94 → 09/97 | 1.762 | B | M | 4 | 16 | 7A-FE | (+)COP, → 12-1995 | 81768 |
| | 92 | 10/94 → 09/97 | 1.762 | B | M | 4 | 16 | 7A-FE | (+)COP, 01-1996 → | 81769 |
| 1.8 i | 79 | 02/95 → 09/97 | 1.762 | B | M | 4 | 16 | 7A-FE | (+)COP | 81768 |
| 1.8 i 16V | 79 | 01/95 → 09/97 | 1.762 | B | M | 4 | 16 | 7A-FE | (+)COP, → 12-1995 | 81768 |
| | 79 | 01/95 → 09/97 | 1.762 | B | M | 4 | 16 | 7A-FE | (+)COP, 01-1996 → | 81769 |
| 2.0 | 98 | 01/93 → 09/97 | 1.998 | B | M | 4 | 16 | 3S-FE | (-)COP | 81770 |
| 2.0 GLI | 98 | 04/92 → 09/97 | 1.998 | B | M | 4 | 16 | 3S-FE | (-)COP | 81770 |
| | 116 | 04/92 → 02/94 | 1.998 | B | M | 4 | 16 | 3S-GE | (-)COP | 81770 |
| 2.0 GTi 16V | 129 | 03/94 → 09/97 | 1.998 | B | M | 4 | 16 | 3S-GE | (-)COP | 81770 |
| 2.0 i | 93 | 12/93 → 09/97 | 1.998 | B | M | 4 | 16 | 3S-FE | (-)COP | 81770 |
| Celica V | | | | | | | | | | |
| 1.6 STI | 77 | 10/89 → 11/93 | 1.587 | B | M | 4 | 16 | 4A-FE | (-)COP | 81815 |
| | 77 | 10/89 → 11/93 | 1.587 | B | M | 4 | 16 | 4A-FE | (+)COP | 81766 |
| Celica VI | | | | | | | | | | |
| 1.8 i 16V | 85 | 11/93 → 11/99 | 1.762 | B | M | 4 | 16 | 7A-FE | (+)COP | 81769 |
| Celica VII | | | | | | | | | | |
| 1.8 16V VT-i | 105 | 08/99 → 07/05 | 1.794 | B | M | 4 | 16 | 1ZZ-FE | | 82012 |

KW

cm³

NO. OF VALVES

TOYOTA
Corolla V, Liftback, Station Wagon, Compact

| | | | | | | | | | | |
|-------------|----|---------------|-------|---|---|---|----|-------|--------|-------|
| 1.3 XLI | 55 | 09/95 → 04/97 | 1.332 | B | M | 4 | 16 | 4E-FE | (-)COP | 81771 |
| | 65 | 07/92 → 04/97 | 1.332 | B | M | 4 | 16 | 4E-FE | (-)COP | 81771 |
| 1.3 XLI 16V | 65 | 07/92 → 09/95 | 1.332 | B | M | 4 | 16 | 4E-FE | (-)COP | 81771 |
| 1.6 GLI | 84 | 07/92 → 04/97 | 1.587 | B | M | 4 | 16 | 4A-FE | (-)COP | 81815 |
| | 84 | 07/92 → 04/97 | 1.587 | B | M | 4 | 16 | 4A-FE | (+)COP | 81766 |
| 1.6 Si | 84 | 09/95 → 04/97 | 1.587 | B | M | 4 | 16 | 4A-FE | (-)COP | 81815 |
| | 84 | 09/95 → 04/97 | 1.587 | B | M | 4 | 16 | 4A-FE | (+)COP | 81766 |
| 1.8 16V 4WD | 81 | 09/95 → 04/97 | 1.762 | B | M | 4 | 16 | 7A-FE | (+)COP | 81769 |
| 1.8 GT | 86 | 11/92 → 05/95 | 1.762 | B | M | 4 | 16 | 7A-FE | (+)COP | 81769 |

Corolla Verso

| | | | | | | | | | | |
|----------|-----|---------------|-------|---|---|---|----|---------|-----------|------------------|
| 1.4 D-4D | 66 | 03/04 → 03/09 | 1.364 | D | M | 4 | 8 | 1ND-TV | → 01-2009 | 81821 |
| | 66 | 03/04 → 03/09 | 1.364 | D | M | 4 | 8 | 1ND-TV | 02-2009 → | 84029 NEW |
| 1.6 | 81 | 04/04 → 03/09 | 1.598 | B | M | 4 | 16 | 3ZZ-FE | | 82012 |
| 1.8 | 95 | 04/04 → 03/09 | 1.794 | B | M | 4 | 16 | 1ZZ-FE | | 82012 |
| 2.0 D-4D | 85 | 04/04 → 03/09 | 1.995 | D | M | 4 | 16 | 1CD-FTV | | 82044 |
| 2.2 D-4D | 100 | 10/05 → 03/09 | 2.231 | D | M | 4 | 16 | 2AD-FTV | | 82071 |
| | 130 | 10/05 → 03/09 | 2.231 | D | M | 4 | 16 | 2AD-FHV | | 82071 |

Corolla VI, Liftback, Station Wagon, Compact

| | | | | | | | | | | |
|----------|----|---------------|-------|---|---|---|----|---------|-----------|-------|
| 1.3 | 55 | 05/97 → 10/01 | 1.295 | B | M | 4 | 12 | 2E | (-)COP | 81771 |
| 1.4 | 63 | 04/97 → 02/00 | 1.332 | B | M | 4 | 16 | 4E-FE | (-)COP | 81771 |
| | 71 | 02/00 → 01/02 | 1.398 | B | M | 4 | 16 | 4ZZ-FE | 11-2001 → | 82012 |
| | 71 | 02/00 → 01/02 | 1.398 | B | M | 4 | 16 | 4ZZ-FE | | 82012 |
| 1.4 16V | 71 | 02/00 → 11/01 | 1.398 | B | M | 4 | 16 | 4ZZ-FE | 11-2001 → | 82012 |
| 1.6 | 81 | 04/97 → 02/00 | 1.587 | B | M | 4 | 16 | 4A-FE | (-)COP | 81815 |
| | 81 | 04/97 → 02/00 | 1.587 | B | M | 4 | 16 | 4A-FE | (+)COP | 81766 |
| | 81 | 02/00 → 01/02 | 1.598 | B | M | 4 | 16 | 3ZZ-FE | | 82012 |
| 1.6 16V | 81 | 02/00 → 11/01 | 1.598 | B | M | 4 | 16 | 3ZZ-FE | | 82012 |
| 1.6 Aut. | 79 | 04/97 → 02/00 | 1.587 | B | A | 4 | 16 | 4A-FE | (-)COP | 81815 |
| | 79 | 04/97 → 02/00 | 1.587 | B | M | 4 | 16 | 4A-FE | (-)COP | 81815 |
| | 79 | 04/97 → 02/00 | 1.587 | B | A | 4 | 16 | 4A-FE | (+)COP | 81766 |
| | 79 | 04/97 → 02/00 | 1.587 | B | M | 4 | 16 | 4A-FE | (+)COP | 81766 |
| 1.8 | 81 | 10/97 → 10/01 | 1.762 | B | M | 4 | 16 | 7A-FE | (+)COP | 81769 |
| 1.8 4WD | 81 | 04/97 → 10/01 | 1.762 | B | M | 4 | 16 | 7A-FE | (+)COP | 81769 |
| 2.0 D-4D | 66 | 09/00 → 11/01 | 1.995 | D | M | 4 | 16 | 1CD-FTV | | 82022 |

Corolla VII, Liftback, Station Wagon, Verso

| | | | | | | | | | | |
|-----------|-----|---------------|-------|---|---|---|----|--------|--|-------|
| 1.4 D | 66 | 07/04 → 02/07 | 1.364 | D | M | 4 | 8 | 1ND-TV | | 81809 |
| 1.4 D4-D | 66 | 07/04 → 02/07 | 1.364 | D | M | 4 | 8 | 1ND-TV | | 81809 |
| 1.4 D-4D | 66 | 07/04 → 07/07 | 1.364 | D | M | 4 | 8 | 1ND-TV | | 81809 |
| 1.4 VVT-i | 71 | 01/02 → 12/06 | 1.398 | B | M | 4 | 16 | 4ZZ-FE | | 82012 |
| 1.6 VVT-i | 81 | 01/02 → 12/06 | 1.598 | B | M | 4 | 16 | 3ZZ-FE | | 82012 |
| 1.81.8 | 92 | 05/02 → 05/04 | 1.794 | B | M | 4 | 16 | 1ZZ-FE | | 82012 |
| | 96 | 03/01 → 07/05 | 1.794 | B | M | 4 | 16 | 1ZZ-FE | | 82012 |
| | 100 | 06/04 → 02/07 | 1.794 | B | M | 4 | 16 | 1ZZ-FE | | 82012 |
| 1.8 4WD | 100 | 12/01 → 02/07 | 1.794 | B | M | 4 | 16 | 1ZZ-FE | | 82012 |

| | | | | | | | | | | |
|--|----|--|-----------------|--|--|--|---------------|--|--|--|
| | KW | | cm ³ | | | | NO. OF VALVES | | | |
|--|----|--|-----------------|--|--|--|---------------|--|--|--|

TOYOTA

Corolla VII, Liftback, Station Wagon, Verso

| | | | | | | | | | | |
|-----------|---------------|---------------|-------|---|---|----|---------|---------|-----------|-------|
| 1.8 4x4 | 94 | 06/07 → 07/07 | 1.794 | B | M | 4 | 16 | 1ZZ-FE | | 82012 |
| 1.8 VVTi | 100 | 06/04 → 02/07 | 1.794 | B | M | 4 | 16 | 1ZZ-FE | | 82012 |
| 1.8 VVT-i | 99 | 01/02 → 05/04 | 1.794 | B | A | 4 | 16 | 1ZZ-FE | | 82012 |
| 2.0 D-4D | 66 | 01/02 → 02/07 | 1.995 | D | M | 4 | 16 | 1CD-FTV | → 06-2004 | 82022 |
| | 66 | 01/02 → 02/07 | 1.995 | D | M | 4 | 16 | 1CD-FTV | 07-2004 → | 82044 |
| | 66 | 01/02 → 12/06 | 1.995 | D | M | 4 | 16 | 1CD-FTV | | 82022 |
| | 85 | 04/04 → 02/07 | 1.995 | D | M | 4 | 16 | 1CD-FTV | | 82044 |
| | 85 | 06/04 → 07/07 | 1.995 | D | M | 4 | 16 | 1CD-FTV | | 82022 |
| | 81 | 01/02 → 12/06 | 1.995 | D | M | 4 | 16 | 1CD-FTV | | 82022 |
| 85 | 05/03 → 02/07 | 1.995 | D | M | 4 | 16 | 1CD-FTV | | 82022 | |

Corolla VIII, Hatchback, Station Wagon

| | | | | | | | | | | | |
|---------------|-----|---------|-------|---|---|---|----|-----------------|-----------|-------|--|
| 1.33 | 74 | 01/07 → | 1.329 | B | M | 4 | 16 | 1NR-FE | | 84032 | |
| 1.4 D-4D | 66 | 01/07 → | 1.364 | D | M | 4 | 8 | 1ND-TV | → 01-2009 | 81821 | |
| | 66 | 01/07 → | 1.364 | D | M | 4 | 8 | 1ND-TV | 02-2009 → | 84029 | |
| 1.4 VVT-i | 71 | 01/07 → | 1.398 | B | M | 4 | 16 | 4ZZ-FE | | 82012 | |
| 1.6 | 97 | 01/09 → | 1.598 | B | M | 4 | 16 | 1ZR-FAE, 1ZR-FE | | 84030 | |
| 1.6 Dual VVTi | 91 | 01/07 → | 1.598 | B | M | 4 | 16 | 1ZR-FE | | 84030 | |
| 1.6 VVTi | 90 | 10/12 → | 1.598 | B | M | 4 | 16 | 1ZR-FE | | 84030 | |
| 2.0 D-4D | 93 | 01/07 → | 1.998 | D | M | 4 | 16 | 1AD-FTV | | 82071 | |
| | 130 | 11/06 → | 2.231 | D | M | 4 | 16 | 2AD-FHV | | 82071 | |

Corolla IX, Hatchback, Station Wagon

| | | | | | | | | | | | |
|----------|-----|---------|-------|---|---|---|----|-----------------|--|-------|--|
| 1.3 | 73 | 06/13 → | 1.329 | B | M | 4 | 16 | 1NR-FE | | 84032 | |
| 1.4 D-4D | 66 | 06/13 → | 1.364 | D | M | 4 | 8 | 1ND-TV | | 84029 | |
| 1.6 | 97 | 06/13 → | 1.598 | B | M | 4 | 16 | 1ZR-FAE | | 84030 | |
| 1.8 VVTi | 103 | 06/13 → | 1.798 | B | M | 4 | 16 | 2ZR-FBE, 2ZR-FE | | 84030 | |

IQ

| | | | | | | | | | | | |
|----------|----|---------|-------|---|---|---|----|--------|--|-------|--|
| 1.0 | 50 | 01/09 → | 998 | B | M | 3 | 12 | 1KR-FE | | 84031 | |
| 1.4 D-4D | 66 | 01/09 → | 1.364 | D | M | 4 | 8 | 1ND-TV | | 84028 | |

MR 2 III

| | | | | | | | | | | |
|--------------|-----|---------------|-------|---|---|---|----|--------|--|-------|
| 1.8 16V VT-i | 103 | 10/99 → 06/07 | 1.794 | B | M | 4 | 16 | 1ZZ-FE | | 82012 |
|--------------|-----|---------------|-------|---|---|---|----|--------|--|-------|

Paseo II

| | | | | | | | | | | |
|---------|----|---------------|-------|---|---|---|----|-------|--------|-------|
| 1.5 | 66 | 10/96 → 01/98 | 1.497 | B | M | 4 | 16 | 5E-FE | (-)COP | 81771 |
| 1.5 16V | 66 | 08/95 → 07/99 | 1.497 | B | M | 4 | 16 | 5E-FE | (-)COP | 81771 |

Picnic I

| | | | | | | | | | | |
|---------|----|---------------|-------|---|---|---|----|-------|--------|-------|
| 2.0 | 90 | 01/01 → 12/01 | 1.998 | B | M | 4 | 16 | 3S-FE | (-)COP | 81770 |
| 2.0 16V | 94 | 05/96 → 12/01 | 1.998 | B | M | 4 | 16 | 3S-FE | (-)COP | 81770 |

Previa II

| | | | | | | | | | | |
|----------|-----|---------------|-------|---|---|---|----|---------|--|-------|
| 2.0 D-4D | 85 | 03/01 → 01/06 | 1.995 | D | M | 4 | 16 | 1CD-FTV | | 82022 |
| 2.4 | 115 | 08/00 → 01/06 | 2.362 | B | M | 4 | 16 | 2AZ-FE | | 82055 |
| 2.4 4WD | 96 | 07/02 → 12/05 | 2.362 | B | M | 4 | 16 | 2AZ-FXE | | 82055 |

Previa III

| | | | | | | | | | | |
|-----|-----|---------|-------|---|---|---|----|--------|--|-------|
| 2.4 | 125 | 10/05 → | 2.362 | B | M | 4 | 16 | 2AZ-FE | | 82055 |
|-----|-----|---------|-------|---|---|---|----|--------|--|-------|

Prius I

| | | | | | | | | | | |
|------------|----|---------------|-------|--|---|---|----|---------|--|-------|
| 1.5 Hybrid | 53 | 05/00 → 01/04 | 1.497 | | A | 4 | 16 | 1NZ-FXE | | 81809 |
|------------|----|---------------|-------|--|---|---|----|---------|--|-------|

KW

cm³

NO. OF VALVES

TOYOTA
Prius II

| | | | | | | | | | | |
|-----|----|---------------|-------|--|---|---|----|---------|--|-------|
| 1.5 | 57 | 08/03 → 03/09 | 1.497 | | M | 4 | 16 | 1NZ-FXE | | 81809 |
|-----|----|---------------|-------|--|---|---|----|---------|--|-------|

RAV 4 I

| | | | | | | | | | | |
|-------------|----|---------------|-------|---|---|---|----|-------|--------|-------|
| 2.0 16V 4WD | 94 | 12/97 → 06/00 | 1.998 | B | M | 4 | 16 | 3S-FE | (-)COP | 81770 |
| 2.0 4WD | 95 | 06/94 → 06/00 | 1.998 | B | M | 4 | 16 | 3S-FE | (-)COP | 81770 |

RAV 4 II

| | | | | | | | | | | |
|--------------|-----|---------------|-------|---|---|---|----|---------|--|-------|
| 1.8 VVTi | 92 | 08/00 → 11/05 | 1.794 | B | M | 4 | 16 | 1ZZ-FE | | 82012 |
| 2.0 D-4D 4WD | 85 | 09/01 → 11/05 | 1.995 | D | M | 4 | 16 | 1CD-FTV | | 82022 |
| 2.0 VVTi 4WD | 110 | 06/00 → 11/05 | 1.998 | B | M | 4 | 16 | 1AZ-FE | | 82055 |
| 2.4 VVTi 4WD | 112 | 08/03 → 11/05 | 2.362 | B | M | 4 | 16 | 2AZ-FE | | 82055 |

RAV 4 III

| | | | | | | | | | | | |
|---------------|-----|---------|-------|---|---|---|----|------------------|--|-------|------------|
| 2.0 | 116 | 12/08 → | 1.987 | B | M | 4 | 16 | 3ZR-FAE | | 84030 | NEW |
| 2.0 4WD | 116 | 12/08 → | 1.987 | B | M | 4 | 16 | 3ZR-FAE | | 84030 | NEW |
| 2.0 VVT-i | 109 | 03/09 → | 1.987 | B | M | 4 | 16 | 3ZR-FAE | | 84030 | NEW |
| 2.0 VVT-i 4WD | 109 | 03/09 → | 1.987 | B | M | 4 | 16 | 3ZR-FAE | | 84030 | NEW |
| | 112 | 03/06 → | 1.998 | B | M | 4 | 16 | 1AZ-FE | | 82055 | |
| 2.2 D-4D | 110 | 12/08 → | 2.231 | D | M | 4 | 16 | 2AD-FHV, 2AD-FTV | | 82071 | |
| 2.2 D-4D 4WD | 100 | 03/06 → | 2.231 | D | M | 4 | 16 | 2AD-FTV | | 82071 | |
| | 110 | 12/08 → | 2.231 | D | M | 4 | 16 | 2AD-FHV, 2AD-FTV | | 82071 | |
| 2.2 D-CAT 4WD | 130 | 03/06 → | 2.231 | D | M | 4 | 16 | 2AD-FHV | | 82071 | |
| 2.4 VVTi | 125 | 11/05 → | 2.362 | B | M | 4 | 16 | 2AZ-FE | | 82055 | |
| 2.4 VVTi 4WD | 125 | 11/05 → | 2.362 | B | M | 4 | 16 | 2AZ-FE | | 82055 | |

RAV 4 IV

| | | | | | | | | | | | |
|---------------|-----|---------|-------|---|---|---|----|------------------|--|-------|------------|
| 2.0 D-4D | 105 | 10/15 → | 1.995 | D | M | 4 | 16 | 2WW | | 84026 | NEW |
| 2.0 VVT-i | 107 | 12/12 → | 1.987 | B | M | 4 | 16 | 3ZR-FE | | 84030 | NEW |
| 2.0 VVT-i 4WD | 111 | 12/12 → | 1.987 | B | M | 4 | 16 | 3ZR-FAE | | 84030 | NEW |
| 2.2 D4-D 4WD | 110 | 12/12 → | 2.231 | D | M | 4 | 16 | 2AD-FHV, 2AD-FTV | | 82071 | |

Starlet IV

| | | | | | | | | | | |
|-----|----|---------------|-------|---|---|---|----|-------|--------|-------|
| 1.3 | 55 | 04/96 → 03/99 | 1.332 | B | M | 4 | 16 | 4E-FE | (-)COP | 81771 |
|-----|----|---------------|-------|---|---|---|----|-------|--------|-------|

Urban Cruiser

| | | | | | | | | | | | |
|--------------|----|---------|-------|---|---|---|----|--------|--|-------|------------|
| 1.33 | 73 | 04/10 → | 1.329 | B | M | 4 | 16 | 1NR-FE | | 84032 | NEW |
| | 74 | 04/09 → | 1.329 | B | M | 4 | 16 | 1NR-FE | | 84032 | NEW |
| 1.4 D-4D | 66 | 04/09 → | 1.364 | D | M | 4 | 8 | 1ND-TV | | 84029 | NEW |
| 1.4 D-4D 4WD | 66 | 04/09 → | 1.364 | D | M | 4 | 8 | 1ND-TV | | 84029 | NEW |
| 1.5 VVTi | 80 | 07/07 → | 1.497 | B | M | 4 | 16 | 1NZ-FE | | 81809 | |
| 1.5 VVTi 4WD | 76 | 04/09 → | 1.497 | B | M | 4 | 16 | 1NZ-FE | | 81809 | |

Verso

| | | | | | | | | | | | |
|-----------|-----|---------|-------|---|---|---|----|---------|--|-------|------------|
| 1.6 | 97 | 04/09 → | 1.598 | B | M | 4 | 16 | 1ZR-FAE | | 84030 | NEW |
| 1.6 D4-D | 82 | 11/13 → | 1.598 | D | M | 4 | 16 | 1WW | | 84026 | NEW |
| 1.8 | 108 | 04/09 → | 1.798 | B | M | 4 | 16 | 2ZR-FAE | | 84030 | NEW |
| 2.0 D-4D | 91 | 11/12 → | 1.998 | D | M | 4 | 16 | 1AD-FTV | | 82071 | |
| | 93 | 04/09 → | 1.998 | D | M | 4 | 16 | 1AD-FTV | | 82071 | |
| 2.2 D-4D | 110 | 04/09 → | 2.231 | D | M | 4 | 16 | 2AD-FHV | | 82071 | |
| 2.2 D-CAT | 130 | 04/09 → | 2.231 | D | M | 4 | 16 | 2AD-FHV | | 82071 | |



KW



cm³



NO. OF VALVES



TOYOTA

Verso S

| | | | | | | | | | | | |
|----------|----|---------|-------|---|---|---|----|--------|--|-------|------------|
| 1.33 | 70 | 11/10 → | 1.329 | B | M | 4 | 16 | 1NR-FE | | 84032 | NEW |
| | 73 | 11/10 → | 1.329 | B | M | 4 | 16 | 1NR-FE | | 84032 | NEW |
| 1.4 D4-D | 66 | 11/10 → | 1.364 | D | M | 4 | 8 | 1ND-TV | | 84029 | NEW |
| 1.5 | 80 | 11/10 → | 1.497 | B | M | 4 | 16 | 1NZ-FE | | 81809 | |
| 1.5 4WD | 76 | 11/10 → | 1.497 | B | M | 4 | 16 | 1NZ-FE | | 81809 | |

Yaris I

| | | | | | | | | | | | |
|--------------|-----|---------------|-------|---|---|---|----|----------------|-----------------|-------|--|
| 1.0 16V | 48 | 03/03 → 09/05 | 998 | B | M | 4 | 16 | 1SZ-FE | Flange: 3 holes | 81808 | |
| | 48 | 03/03 → 09/05 | 998 | B | M | 4 | 16 | 1SZ-FE | Flange: 4 holes | 82048 | |
| | 50 | 04/99 → 09/05 | 998 | B | M | 4 | 16 | 1SZ-FE | Flange: 3 holes | 81808 | |
| | 50 | 04/99 → 09/05 | 998 | B | M | 4 | 16 | 1SZ-FE | Flange: 4 holes | 82048 | |
| 1.3 | 64 | 04/02 → 09/05 | 1.298 | B | M | 4 | 16 | 2SZ-FE | | 81809 | |
| 1.3 16V | 63 | 11/99 → 09/05 | 1.299 | B | M | 4 | 16 | 2NZ-FE, 2SZ-FE | | 81809 | |
| 1.4 D-4D | 55 | 12/01 → 09/05 | 1.364 | D | M | 4 | 8 | 1ND-TV | | 81809 | |
| 1.5 TS | 77 | 01/03 → 09/05 | 1.497 | B | M | 4 | 16 | 1NZ-FE | | 81809 | |
| 1.5 VVT-i TS | 78 | 04/01 → 09/05 | 1.497 | B | M | 4 | 16 | 1NZ-FE | | 81809 | |
| | 110 | 03/03 → 07/05 | 1.497 | B | M | 4 | 16 | 1NZ-FE | | 81809 | |

Yaris II

| | | | | | | | | | | | |
|------------|----|---------|-------|---|---|---|----|----------------|-----------------|-------|------------|
| 1.0 | 52 | 08/07 → | 998 | B | M | 3 | 12 | 1KR-FE | | 82063 | |
| 1.0 GPL | 51 | 01/06 → | 998 | | M | 3 | 12 | 1KR-FE | | 82063 | |
| 1.0 VVT-i | 51 | 08/05 → | 998 | B | M | 3 | 12 | 1KR-FE | | 82063 | |
| 1.3 | 64 | 08/07 → | 1.298 | B | M | 4 | 16 | 2NZ-FE, 2SZ-FE | | 81809 | |
| 1.3 4WD | 64 | 08/07 → | 1.298 | B | M | 4 | 16 | 2NZ-FE | | 81809 | |
| 1.3 VVT-i | 64 | 08/05 → | 1.298 | B | M | 4 | 16 | 2NZ-FE, 2SZ-FE | Flange: 4 holes | 82048 | |
| 1.33 VVT-i | 73 | 07/10 → | 1.329 | B | M | 4 | 16 | 1NR-FE | | 84032 | NEW |
| | 74 | 03/09 → | 1.329 | B | M | 4 | 16 | 1NR-FE | | 84032 | NEW |
| 1.4 D-4D | 66 | 08/05 → | 1.364 | D | M | 4 | 8 | 1ND-TV | | 81821 | |
| 1.5 | 80 | 08/07 → | 1.497 | B | M | 4 | 16 | 1NZ-FE | | 81809 | |
| | 81 | 08/07 → | 1.497 | B | M | 4 | 16 | 1NZ-FE | | 81809 | |
| | 80 | 11/05 → | 1.497 | B | M | 4 | 16 | 1NZ-FE | | 81809 | |
| 1.8 VVTi | 98 | 01/07 → | 1.798 | B | M | 4 | 16 | 2ZR-FE | | 84030 | NEW |

Yaris III

| | | | | | | | | | | | |
|-----------|----|---------|-------|---|---|---|----|-----------------|--|-------|------------|
| 1.0 | 51 | 09/11 → | 998 | B | M | 3 | 12 | 1KR-FE | | 82063 | |
| 1.3 | 70 | 09/11 → | 1.329 | B | M | 4 | 16 | 1NR-FE | | 84032 | NEW |
| | 73 | 09/11 → | 1.329 | B | M | 4 | 16 | 1NR-FE, 1NR-FKE | | 84032 | NEW |
| 1.3 4WD | 70 | 12/10 → | 1.329 | B | M | 4 | 16 | 1NR-FE | | 84032 | NEW |
| 1.3 VVT-i | 63 | 12/10 → | 1.299 | B | M | 4 | 16 | 2NZ-FE | | 81809 | |
| 1.4 D-4D | 66 | 09/11 → | 1.364 | D | M | 4 | 8 | 1ND-TV | | 84029 | NEW |

Yaris Verso

| | | | | | | | | | | | |
|----------|----|---------------|-------|---|---|---|----|--------|--|-------|--|
| 1.3 | 62 | 11/02 → 09/05 | 1.299 | B | M | 4 | 16 | 2NZ-FE | | 81809 | |
| | 63 | 08/99 → 10/02 | 1.299 | B | M | 4 | 16 | 2NZ-FE | | 81809 | |
| 1.4 D-4D | 55 | 12/01 → 09/05 | 1.364 | D | M | 4 | 8 | 1ND-TV | | 81809 | |
| 1.5 | 77 | 05/03 → 09/05 | 1.497 | B | M | 4 | 16 | 1NZ-FE | | 81809 | |
| | 78 | 03/00 → 09/05 | 1.497 | B | M | 4 | 16 | 1NZ-FE | | 81809 | |

KW

cm³

NO. OF VALVES

MAGNETI MARELLI
VAUXHALL
AGILA

| | | | | | | | | | | |
|----------|----|---------------|-------|---|---|---|----|--------------|--|-------|
| 1.3 CDTI | 55 | 01/08 → 11/14 | 1.248 | D | M | 4 | 16 | D13A, Z13DTJ | | 81862 |
|----------|----|---------------|-------|---|---|---|----|--------------|--|-------|

ANTARA

| | | | | | | | | | | |
|----------|-----|---------------|-------|---|---|---|----|--------|--|------------------|
| 2.0 CDTI | 110 | 08/06 → 04/15 | 1.991 | D | M | 4 | 16 | Z20DMH | | 84014 NEW |
|----------|-----|---------------|-------|---|---|---|----|--------|--|------------------|

ASTRA

| | | | | | | | | | | |
|-----|----|---------------|-------|---|---|---|---|-----|--|-------|
| 1.3 | 55 | 09/85 → 08/91 | 1.297 | B | M | 4 | 8 | 13S | | 81543 |
|-----|----|---------------|-------|---|---|---|---|-----|--|-------|

| | | | | | | | | | | |
|----------|----|---------|-------|---|---|---|----|--------|--|-------|
| 1.3 CDTI | 70 | 12/09 → | 1.248 | D | M | 4 | 16 | A13DTE | | 81862 |
|----------|----|---------|-------|---|---|---|----|--------|--|-------|

| | | | | | | | | | | |
|-----|----|---------------|-------|---|---|---|----|--------|--|-------|
| 1.4 | 66 | 01/04 → 05/09 | 1.364 | B | M | 4 | 16 | Z14XEP | | 82011 |
|-----|----|---------------|-------|---|---|---|----|--------|--|-------|

| | | | | | | | | | | |
|-----|----|---------|-------|---|---|---|----|--------|--|------------------|
| 1.4 | 64 | 12/09 → | 1.398 | B | M | 4 | 16 | A14XEL | | 84027 NEW |
|-----|----|---------|-------|---|---|---|----|--------|--|------------------|

| | | | | | | | | | | |
|-----|----|---------|-------|---|---|---|----|--------|--|------------------|
| 1.4 | 74 | 12/09 → | 1.398 | B | M | 4 | 16 | A14XER | | 84027 NEW |
|-----|----|---------|-------|---|---|---|----|--------|--|------------------|

| | | | | | | | | | | |
|-----|----|---------|-------|---|---|---|----|-------|--|------------------|
| 1.4 | 74 | 07/15 → | 1.399 | B | M | 4 | 16 | B14XE | | 84053 NEW |
|-----|----|---------|-------|---|---|---|----|-------|--|------------------|

| | | | | | | | | | | |
|---------|----|---------------|-------|---|---|---|----|--------------|-----------|-------|
| 1.4 16V | 66 | 02/98 → 05/05 | 1.389 | B | M | 4 | 16 | X14XE, Z14XE | 09-2000 → | 81817 |
|---------|----|---------------|-------|---|---|---|----|--------------|-----------|-------|

| | | | | | | | | | | |
|-----------|-----|---------|-------|---|---|---|----|--------|--|------------------|
| 1.4 Turbo | 103 | 12/09 → | 1.364 | B | M | 4 | 16 | A14NET | | 84027 NEW |
|-----------|-----|---------|-------|---|---|---|----|--------|--|------------------|

| | | | | | | | | | | |
|-----|----|---------------|-------|---|---|---|---|-------|--|-------|
| 1.6 | 62 | 09/00 → 05/05 | 1.598 | B | M | 4 | 8 | Z16SE | | 81818 |
|-----|----|---------------|-------|---|---|---|---|-------|--|-------|

| | | | | | | | | | | |
|-----|----|---------|-------|---|---|---|----|----------------|--|-------|
| 1.6 | 85 | 12/09 → | 1.598 | B | M | 4 | 16 | A16XER, B16XER | | 82083 |
|-----|----|---------|-------|---|---|---|----|----------------|--|-------|

| | | | | | | | | | | |
|---------|----|---------------|-------|---|---|---|----|-------------------------------|----------------------|-------|
| 1.6 16V | 74 | 09/98 → 05/05 | 1.598 | B | M | 4 | 16 | C16SEL, X16XEL, Z16XE, Z16XEP | 05-2004 →, M: Z16XEP | 82083 |
|---------|----|---------------|-------|---|---|---|----|-------------------------------|----------------------|-------|

| | | | | | | | | | | |
|---------|----|---------------|-------|---|---|---|----|-------------------------------|-----------|-------|
| 1.6 16V | 74 | 09/98 → 05/05 | 1.598 | B | M | 4 | 16 | C16SEL, X16XEL, Z16XE, Z16XEP | 09-2000 → | 81817 |
|---------|----|---------------|-------|---|---|---|----|-------------------------------|-----------|-------|

| | | | | | | | | | | |
|---------|----|---------------|-------|---|---|---|----|---------------|-----------|-------|
| 1.6 16V | 74 | 02/98 → 05/05 | 1.598 | B | M | 4 | 16 | X16XEL, Z16XE | 09-2000 → | 81817 |
|---------|----|---------------|-------|---|---|---|----|---------------|-----------|-------|

| | | | | | | | | | | |
|---------|----|---------------|-------|---|---|---|----|-------|----------------------|-------|
| 1.6 16V | 74 | 03/01 → 10/05 | 1.598 | B | M | 4 | 16 | Z16XE | 05-2004 →, M: Z16XEP | 82083 |
|---------|----|---------------|-------|---|---|---|----|-------|----------------------|-------|

| | | | | | | | | | | |
|---------|----|---------------|-------|---|---|---|----|-------|--|-------|
| 1.6 16V | 74 | 03/01 → 10/05 | 1.598 | B | M | 4 | 16 | Z16XE | | 81817 |
|---------|----|---------------|-------|---|---|---|----|-------|--|-------|

| | | | | | | | | | | |
|-----------|-----|---------|-------|---|---|---|----|--------|--|-------|
| 1.6 Turbo | 132 | 12/09 → | 1.598 | B | M | 4 | 16 | A16LET | | 82083 |
|-----------|-----|---------|-------|---|---|---|----|--------|--|-------|

| | | | | | | | | | | |
|----------|-----|---------|-------|---|---|---|----|--------|--|-------|
| 2.0 CDTi | 118 | 12/09 → | 1.956 | D | M | 4 | 16 | A20DTH | | 81872 |
|----------|-----|---------|-------|---|---|---|----|--------|--|-------|

| | | | | | | | | | | |
|---------|-----|---------------|-------|---|---|---|----|-------|--|-------|
| 2.2 16V | 108 | 03/01 → 05/05 | 2.198 | B | M | 4 | 16 | Z22SE | | 81812 |
|---------|-----|---------------|-------|---|---|---|----|-------|--|-------|

| | | | | | | | | | | |
|--------------|--|--|--|--|--|--|--|--|--|--|
| COMBO | | | | | | | | | | |
|--------------|--|--|--|--|--|--|--|--|--|--|

| | | | | | | | | | | |
|------------|----|---------------|-------|---|---|---|----|--------|--|-------|
| 1.7 DI 16V | 48 | 09/01 → 11/11 | 1.686 | D | M | 4 | 16 | Y17DTL | | 81836 |
|------------|----|---------------|-------|---|---|---|----|--------|--|-------|

| | | | | | | | | | | |
|--------------|--|--|--|--|--|--|--|--|--|--|
| CORSA | | | | | | | | | | |
|--------------|--|--|--|--|--|--|--|--|--|--|

| | | | | | | | | | | |
|---------|----|---------------|-----|---|---|---|----|-------|--|-------|
| 1.0 12V | 43 | 09/00 → 10/03 | 973 | B | M | 3 | 12 | Z10XE | | 81749 |
|---------|----|---------------|-----|---|---|---|----|-------|--|-------|

| | | | | | | | | | | |
|-----------|----|---------------|-----|---|---|---|----|-------|--|-------|
| 1.0 i 12V | 40 | 11/96 → 09/00 | 973 | B | M | 3 | 12 | X10XE | | 81749 |
|-----------|----|---------------|-----|---|---|---|----|-------|--|-------|

| | | | | | | | | | | |
|---------|----|---------------|-------|---|---|---|----|-------|-----------|-------|
| 1.2 16V | 55 | 09/00 → 10/06 | 1.199 | B | M | 4 | 16 | Z12XE | 09-1996 → | 81549 |
|---------|----|---------------|-------|---|---|---|----|-------|-----------|-------|

| | | | | | | | | | | |
|--------------|----|---------------|-------|---|---|---|----|-------|--|-------|
| 1.3 CDTI 16V | 52 | 08/00 → 09/06 | 1.248 | D | M | 4 | 16 | Z13DT | | 81862 |
|--------------|----|---------------|-------|---|---|---|----|-------|--|-------|

| | | | | | | | | | | |
|---------|----|---------------|-------|---|---|---|----|-------|--|-------|
| 1.4 16V | 66 | 09/00 → 10/06 | 1.389 | B | M | 4 | 16 | Z14XE | | 81817 |
|---------|----|---------------|-------|---|---|---|----|-------|--|-------|

| | | | | | | | | | | |
|-------|----|---------------|-------|---|---|---|---|-----|--------------|-------|
| 1.5 D | 37 | 12/92 → 12/96 | 1.488 | D | M | 4 | 8 | 15D | → M: 877.697 | 81685 |
|-------|----|---------------|-------|---|---|---|---|-----|--------------|-------|

| | | | | | | | | | | |
|-------|----|---------------|-------|---|---|---|---|-----|--------------|-------|
| 1.5 D | 37 | 12/92 → 12/96 | 1.488 | D | M | 4 | 8 | 15D | M →: 877.698 | 81748 |
|-------|----|---------------|-------|---|---|---|---|-----|--------------|-------|

| | | | | | | | | | | |
|--------|----|---------------|-------|---|---|---|---|-----------------------------|-------------------------|-------|
| 1.5 TD | 49 | 03/93 → 10/96 | 1.488 | D | M | 4 | 8 | 15DT (T4EC1), X15DT (T4EC1) | 03-1993 →, → M: 877.697 | 81685 |
|--------|----|---------------|-------|---|---|---|---|-----------------------------|-------------------------|-------|

| | | | | | | | | | | |
|--------|----|---------------|-------|---|---|---|---|-----------------------------|-------------------------|-------|
| 1.5 TD | 49 | 03/93 → 10/96 | 1.488 | D | M | 4 | 8 | 15DT (T4EC1), X15DT (T4EC1) | 03-1993 →, M →: 877.698 | 81748 |
|--------|----|---------------|-------|---|---|---|---|-----------------------------|-------------------------|-------|

| | | | | | | | | | | |
|------------|----|---------------|-------|---|---|---|----|--------|--|-------|
| 1.7 DI 16V | 48 | 08/00 → 09/06 | 1.686 | D | M | 4 | 16 | Y17DTL | | 81687 |
|------------|----|---------------|-------|---|---|---|----|--------|--|-------|

| | | | | | | | | | | |
|-------------|----|---------------|-------|---|---|---|----|-------|--|-------|
| 1.7 DTI 16V | 55 | 08/00 → 09/06 | 1.686 | D | M | 4 | 16 | Y17DT | | 81687 |
|-------------|----|---------------|-------|---|---|---|----|-------|--|-------|

| | | | | | | | | | | |
|-----------------|--|--|--|--|--|--|--|--|--|--|
| CORSAVAN | | | | | | | | | | |
|-----------------|--|--|--|--|--|--|--|--|--|--|

| | | | | | | | | | | |
|--------------|----|---------------|-------|---|---|---|----|-------|--|-------|
| 1.3 CDTI 16V | 52 | 04/04 → 06/06 | 1.248 | D | M | 4 | 16 | Z13DT | | 81862 |
|--------------|----|---------------|-------|---|---|---|----|-------|--|-------|

KW

cm³

NO. OF VALVES

VAUXHALL
MERIVA

| | | | | | | | | | | |
|-----------|----|---------------|-------|---|---|---|----|-------|--|-------|
| 1.6 i | 64 | 01/03 → 06/10 | 1.598 | B | M | 4 | 8 | Z16SE | | 81818 |
| 1.6 i 16V | 74 | 01/03 → 09/05 | 1.598 | B | M | 4 | 16 | Z16XE | | 81817 |

MOVANO

| | | | | | | | | | | |
|---------|----|---------------|-------|---|---|---|----|------------------------|--|-------|
| 1.9 DTI | 59 | 09/00 → 10/01 | 1.870 | D | M | 4 | 8 | F9Q770 | | 81814 |
| | 59 | 09/00 → 10/01 | 1.870 | D | M | 4 | 8 | F9Q770 | | 84009 |
| | 60 | 10/01 → 05/10 | 1.870 | D | M | 4 | 8 | F9Q774 | | 81814 |
| | 60 | 10/01 → 05/10 | 1.870 | D | M | 4 | 8 | F9Q774 | | 84009 |
| 2.2 DTI | 66 | 09/00 → 05/10 | 2.188 | D | M | 4 | 16 | G9T720, G9T722, G9T750 | | 81855 |
| | 66 | 09/00 → 05/10 | 2.188 | D | M | 4 | 16 | G9T720, G9T750 | | 81855 |
| 2.5 D | 59 | 10/98 → 01/01 | 2.499 | D | M | 4 | 8 | S8U770 | | 81834 |
| 2.8 DTI | 84 | 10/98 → 10/01 | 2.799 | D | M | 4 | 8 | S9W702 | | 81835 |
| | 84 | 10/98 → 10/01 | 2.799 | D | M | 4 | 8 | S9W702 | | 81835 |

OMEGA

| | | | | | | | | | | |
|-----|----|---------------|-------|---|---|---|---|------|--|-------|
| 2.0 | 85 | 09/95 → 09/96 | 1.998 | B | M | 4 | 8 | 20SE | | 81551 |
|-----|----|---------------|-------|---|---|---|---|------|--|-------|

SIGNUM

| | | | | | | | | | | |
|--------------|-----|---------------|-------|---|---|---|----|--------|--|------------------|
| 2.2 i | 114 | 05/03 → 05/08 | 2.198 | B | M | 4 | 16 | Z22YH | | 81812 |
| 2.8 V6 Turbo | 169 | 07/05 → 05/08 | 2.792 | B | M | 6 | 24 | Z28NEL | | 84057 NEW |

TIGRA

| | | | | | | | | | | |
|----------|----|---------------|-------|---|---|---|----|-------|--|-------|
| 1.3 CDTI | 51 | 06/04 → 08/09 | 1.248 | D | M | 4 | 16 | Z13DT | | 81862 |
|----------|----|---------------|-------|---|---|---|----|-------|--|-------|

VECTRA

| | | | | | | | | | | |
|--------------|-----|---------------|-------|---|---|---|----|--------|--|------------------|
| 1.8 16V | 90 | 04/02 → 07/08 | 1.796 | B | M | 4 | 16 | Z18XE | | 81751 |
| 2.8 V6 Turbo | 169 | 08/05 → 07/08 | 2.792 | B | M | 6 | 24 | Z28NEL | | 84057 NEW |
| | 184 | 08/06 → 07/08 | 2.792 | B | M | 6 | 24 | Z28NET | | 84057 NEW |
| | 188 | 08/05 → 07/08 | 2.792 | B | M | 6 | 24 | Z28NET | | 84057 NEW |

VIVA

| | | | | | | | | | | |
|-----|----|---------|-----|---|---|---|----|-------|--|------------------|
| 1.0 | 55 | 01/15 → | 999 | B | M | 3 | 12 | B10XE | | 84053 NEW |
|-----|----|---------|-----|---|---|---|----|-------|--|------------------|

VIVARO

| | | | | | | | | | | |
|---------|----|---------------|-------|---|---|---|---|--------|--|-------|
| 1.9 DI | 59 | 08/01 → 12/06 | 1.870 | D | M | 4 | 8 | F9Q762 | | 81814 |
| | 59 | 08/01 → 12/06 | 1.870 | D | M | 4 | 8 | F9Q762 | | 84009 |
| 1.9 DTI | 74 | 08/01 → 12/06 | 1.870 | D | M | 4 | 8 | F9Q760 | | 81814 |
| | 74 | 08/01 → 12/06 | 1.870 | D | M | 4 | 8 | F9Q760 | | 84009 |

ZAFIRA

| | | | | | | | | | | |
|---------------|-----|---------------|-------|---|---|---|----|---------------|-----------|-------|
| 1.6 16V | 74 | 04/99 → 08/05 | 1.598 | B | M | 4 | 16 | X16XEL, Z16XE | 07-2000 → | 81817 |
| 2.0 GSI Turbo | 141 | 09/01 → 06/05 | 1.998 | B | M | 4 | 16 | Z20LET | | 81747 |
| 2.2 16V | 108 | 11/98 → 08/04 | 2.198 | B | M | 4 | 16 | Z22SE | | 81812 |

VOLKSWAGEN
Amarok

| | | | | | | | | | | |
|-------------------|-----|---------|-------|---|---|---|----|------------|--|-------|
| 2.0 BITDI | 120 | 09/10 → | 1.968 | D | M | 4 | 16 | CDCA | | 84001 |
| | 132 | 11/11 → | 1.968 | D | M | 4 | 16 | CNEA, CSHA | | 84001 |
| 2.0 BITDI 4motion | 120 | 09/10 → | 1.968 | D | M | 4 | 16 | CDCA | | 84001 |
| | 132 | 11/11 → | 1.968 | D | M | 4 | 16 | CNEA, CSHA | | 84001 |

KW

cm³

NO. OF VALVES

MAGNETI MARELLI
VOLKSWAGEN
Amarok

| | | | | | | | | | | |
|-----------------|-----|---------|-------|---|---|---|----|------------|--|------------------|
| 2.0 TDI | 90 | 09/10 → | 1.968 | D | M | 4 | 16 | CDBA, CNFA | | 84001 |
| | 103 | 07/12 → | 1.968 | D | M | 4 | 16 | CNFB | | 84001 |
| 2.0 TDI 4motion | 90 | 09/10 → | 1.968 | D | M | 4 | 16 | CDBA, CNFA | | 84001 |
| | 103 | 06/12 → | 1.968 | D | M | 4 | 16 | CNFB | | 84001 |
| 2.0 TSI | 118 | 12/10 → | 1.984 | B | M | 4 | 16 | CFPA | | 84016 NEW |

Beetle II (Maggiolino)

| | | | | | | | | | | |
|-----------------|-----|---------|-------|---|---|---|----|------------------|--|------------------|
| 1.2 TSI | 77 | 07/11 → | 1.197 | B | M | 4 | 8 | CBZB | | 84045 NEW |
| 1.6 TDI | 77 | 10/11 → | 1.598 | D | M | 4 | 16 | CAYC | | 84001 |
| 2.0 TDI | 103 | 04/11 → | 1.968 | D | M | 4 | 16 | CFFB, CJAA | | 84001 |
| | 103 | 04/12 → | 1.968 | D | M | 4 | 16 | CFFB, CJAA | | 81816 |
| | 103 | 04/12 → | 1.968 | D | M | 4 | 16 | CFFB, CJAA | | 84011 NEW |
| 2.0 TSI 2.0 TSI | 147 | 04/11 → | 1.984 | B | M | 4 | 16 | CBFA, CCTA, CCZA | | 84016 NEW |
| | 155 | 12/12 → | 1.984 | B | M | 4 | 16 | CPLA, CPPA | | 84037 NEW |
| | 162 | 12/14 → | 1.984 | B | M | 4 | 16 | CULC | | 84037 NEW |

Bora, Station Wagon

| | | | | | | | | | | |
|-------------|-----|---------------|-------|---|---|---|----|-------------------------|-----------|------------------|
| 1.4 16V | 55 | 03/00 → 05/05 | 1.390 | B | M | 4 | 16 | AHW, AKQ, APE, AXP, BCA | 04-1998 → | 81777 |
| | 55 | 09/01 → 05/05 | 1.390 | B | M | 4 | 16 | AHW, AXP, BCA | | 81777 |
| 1.6 | 74 | 10/98 → 05/05 | 1.595 | B | M | 4 | 8 | AEH, AKL, APF | | 81702 |
| | 75 | 08/00 → 05/05 | 1.595 | B | A | 4 | 8 | AVU, BFQ | | 81702 |
| | 75 | 08/00 → 05/05 | 1.595 | B | A | 4 | 8 | AVU, BFQ, BJH | | 81702 |
| | 78 | 06/02 → 10/04 | 1.595 | B | M | 4 | 20 | AWB | | 81702 |
| 1.6 16V | 77 | 05/00 → 05/05 | 1.598 | B | M | 4 | 16 | ATN, AUS, AZD, BCB | | 81840 |
| 1.6 FSI | 81 | 01/02 → 05/05 | 1.598 | B | M | 4 | 16 | BAD | | 81840 |
| 1.8 | 92 | 10/98 → 05/05 | 1.781 | B | M | 4 | 20 | AGN, BAF | | 81703 |
| 1.8 4motion | 92 | 02/99 → 05/05 | 1.781 | B | M | 4 | 20 | AGN | | 81703 |
| 1.8 T | 110 | 05/00 → 05/05 | 1.781 | B | M | 4 | 20 | AGU, ARX, AUM | | 81703 |
| | 110 | 05/00 → 05/05 | 1.781 | B | M | 4 | 20 | AGU, ARX, AUM, BAE | | 81703 |
| | 132 | 03/02 → 05/05 | 1.781 | B | M | 4 | 20 | AUQ | | 81703 |
| 1.9 SDI | 50 | 10/98 → 05/05 | 1.896 | D | M | 4 | 8 | AGP, AQM | | 81706 |
| 1.9 TDI | 66 | 10/98 → 05/05 | 1.896 | D | M | 4 | 8 | AGR, ALH | | 81706 |
| | 74 | 09/00 → 05/05 | 1.896 | D | M | 4 | 8 | ATD, AXR | | 81816 |
| | 74 | 09/00 → 05/05 | 1.896 | D | M | 4 | 8 | ATD, AXR | | 84011 NEW |
| | 81 | 10/98 → 06/01 | 1.896 | D | M | 4 | 8 | AHF, ASV | | 81706 |
| | 85 | 12/98 → 01/02 | 1.896 | D | M | 4 | 8 | AJM, AUY | | 81816 |
| | 85 | 12/98 → 01/02 | 1.896 | D | M | 4 | 8 | AJM, AUY | | 84011 NEW |
| | 96 | 11/00 → 05/05 | 1.896 | D | M | 4 | 8 | ASZ | | 81816 |
| | 96 | 11/00 → 05/05 | 1.896 | D | M | 4 | 8 | ASZ | | 84011 NEW |
| | 110 | 05/00 → 05/05 | 1.896 | D | M | 4 | 8 | ARL | | 81816 |
| | 110 | 05/00 → 05/05 | 1.896 | D | M | 4 | 8 | ARL | | 84011 NEW |

| | | | | | | | | | |
|--|--|--|--|--|--|--|--|--|--|
| | | | | | | | | | |
|--|--|--|--|--|--|--|--|--|--|

VOLKSWAGEN

Bora, Station Wagon

| | | | | | | | | | | |
|-----------------|-----|---------------|-------|---|---|---|----|------------------------------|----------------|------------------|
| 1.9 TDI 4motion | 66 | 11/98 → 04/02 | 1.896 | D | M | 4 | 8 | AGR | | 81706 |
| | 74 | 09/00 → 05/05 | 1.896 | D | M | 4 | 8 | ATD | | 81816 |
| | 74 | 09/00 → 05/05 | 1.896 | D | M | 4 | 8 | ATD | | 84011 NEW |
| | 85 | 02/99 → 06/01 | 1.896 | D | M | 4 | 8 | AJM, AUJ | | 81816 |
| | 85 | 02/99 → 06/01 | 1.896 | D | M | 4 | 8 | AJM, AUJ | | 84011 NEW |
| | 96 | 11/00 → 05/05 | 1.896 | D | M | 4 | 8 | ASZ | | 81816 |
| | 96 | 11/00 → 05/05 | 1.896 | D | M | 4 | 8 | ASZ | | 84011 NEW |
| | 110 | 05/00 → 05/05 | 1.896 | D | M | 4 | 8 | ARL | | 81816 |
| | 110 | 05/00 → 05/05 | 1.896 | D | M | 4 | 8 | ARL | | 84011 NEW |
| 2.0 | 85 | 05/99 → 05/05 | 1.984 | B | M | 4 | 8 | APK, AQY, AZG, AZH, AZJ | | 81703 |
| | 85 | 10/98 → 05/05 | 1.984 | B | M | 4 | 8 | APK, AQY, AZG, AZH, AZJ, BBW | | 81703 |
| 2.0 4motion | 85 | 04/00 → 05/05 | 1.984 | B | M | 4 | 8 | AZH, AZJ | | 81703 |
| 2.3 V5 | 110 | 10/98 → 10/00 | 2.324 | B | M | 5 | 10 | AGZ | 08-1998 → | 81856 |
| | 110 | 05/99 → 10/00 | 2.324 | B | M | 5 | 10 | AGZ | | 81856 |
| | 125 | 10/00 → 05/05 | 2.324 | B | M | 5 | 20 | AQN | | 81856 |
| 2.3 V5 4motion | 110 | 12/98 → 10/00 | 2.324 | B | M | 5 | 10 | AGZ | 08-1998 → | 81856 |
| | 110 | 05/99 → 10/00 | 2.324 | B | M | 5 | 10 | AGZ | | 81856 |
| | 125 | 10/00 → 05/05 | 2.324 | B | M | 5 | 20 | AQN | | 81856 |
| 2.8 V6 4motion | 150 | 03/99 → 05/05 | 2.792 | B | M | 6 | 24 | AQP, AUE, BDE | M: AUE, M: AQP | 81773 |
| | 150 | 03/99 → 05/05 | 2.792 | B | M | 6 | 24 | AQP, AUE, BDE | M: BDE | 81866 |
| Caddy I | | | | | | | | | | |
| 1.6 | 55 | 01/83 → 07/92 | 1.595 | B | M | 4 | 8 | EW | (-)COP | 81522 |
| | 55 | 01/83 → 07/92 | 1.595 | B | M | 4 | 8 | EW | (+)COP | 82080 |
| 1.6 D | 40 | 08/82 → 07/92 | 1.588 | D | M | 4 | 8 | JK, ME | (-)COP | 81522 |
| | 40 | 08/82 → 07/92 | 1.588 | D | M | 4 | 8 | JK, ME | (+)COP | 82080 |
| 1.8 | 70 | 08/85 → 07/92 | 1.781 | B | M | 4 | 8 | JH | (-)COP | 81522 |
| | 70 | 08/85 → 07/92 | 1.781 | B | M | 4 | 8 | JH | (+)COP | 82080 |
| Caddy II | | | | | | | | | | |
| 1.4 | 44 | 11/95 → 01/04 | 1.390 | B | M | 4 | 8 | AEX, AKV, APQ, AUD | | 81527 |
| | 55 | 08/00 → 01/04 | 1.390 | B | M | 4 | 16 | AUA | | 81777 |
| 1.4 16V | 55 | 08/00 → 01/04 | 1.390 | B | M | 4 | 16 | AUA | | 81777 |
| 1.6 | 55 | 11/95 → 05/97 | 1.595 | B | M | 4 | 8 | 1F | (-)COP | 81522 |
| | 55 | 11/95 → 05/97 | 1.595 | B | M | 4 | 8 | 1F | (+)COP | 82080 |
| | 55 | 06/96 → 12/00 | 1.598 | B | M | 4 | 8 | AEE | | 81527 |
| 1.7 SDI | 42 | 07/96 → 09/00 | 1.716 | D | M | 4 | 8 | AHB | (-)COP | 81522 |
| | 42 | 07/96 → 09/00 | 1.716 | D | M | 4 | 8 | AHB | (+)COP | 82080 |
| 1.9 D | 47 | 11/95 → 01/04 | 1.896 | D | M | 4 | 8 | 1Y | (-)COP | 81522 |
| | 47 | 11/95 → 01/04 | 1.896 | D | M | 4 | 8 | 1Y | (+)COP | 82080 |
| | 47 | 06/96 → 12/00 | 1.896 | D | M | 4 | 8 | AEF | | 81528 |

KW

cm³

NO. OF VALVES

VOLKSWAGEN
Caddy II

| | | | | | | | | | | |
|---------|----|---------------|-------|---|---|---|---|---------------|----------------|-------|
| 1.9 SDI | 47 | 11/95 → 01/04 | 1.896 | D | M | 4 | 8 | AEY, AYQ | (-)COP, M: AEY | 81522 |
| | 47 | 11/95 → 01/04 | 1.896 | D | M | 4 | 8 | AEY, AYQ | (+)COP | 82080 |
| | 47 | 11/95 → 01/04 | 1.896 | D | M | 4 | 8 | AEY, AYQ | (+)COP, M: AEY | 82080 |
| | 47 | 11/95 → 01/04 | 1.896 | D | M | 4 | 8 | AEY, AYQ | M: AYQ | 81706 |
| 1.9 TDI | 66 | 09/96 → 01/04 | 1.896 | D | M | 4 | 8 | 1Z, AHU, ALH | (-)COP | 81522 |
| | 66 | 09/96 → 01/04 | 1.896 | D | M | 4 | 8 | 1Z, AHU, ALH | (+)COP | 82080 |
| | 66 | 10/96 → 01/04 | 1.896 | D | M | 4 | 8 | AHU, ALE, ALH | (-)COP | 81522 |
| | 66 | 10/96 → 01/04 | 1.896 | D | M | 4 | 8 | AHU, ALE, ALH | (+)COP | 82080 |
| 60 1.4 | 44 | 11/95 → 01/04 | 1.390 | B | M | 4 | 8 | AEX, APQ, AUD | | 81527 |
| 75 1.6 | 55 | 11/95 → 05/97 | 1.595 | B | M | 4 | 8 | 1F | (-)COP | 81522 |
| | 55 | 11/95 → 05/97 | 1.595 | B | M | 4 | 8 | 1F | (+)COP | 82080 |
| | 55 | 11/95 → 09/00 | 1.598 | B | M | 4 | 8 | AEE | | 81527 |

Caddy III

| | | | | | | | | | | | |
|---------------------|-----|---------------|-------|----|---|---|----|---------------|--|-------|------------|
| 1.2 TSI | 63 | 09/10 → | 1.197 | B | M | 4 | 8 | CBZA | | 84045 | NEW |
| | 77 | 09/10 → | 1.197 | B | M | 4 | 8 | CBZB | | 84045 | NEW |
| 1.4 | 55 | 03/04 → 05/06 | 1.390 | B | M | 4 | 16 | BCA | | 81777 | |
| | 59 | 05/06 → 08/10 | 1.390 | B | M | 4 | 16 | BUD | | 81777 | |
| 1.6 | 74 | 03/05 → | 1.595 | B | M | 4 | 8 | BRY | | 81702 | |
| | 75 | 04/04 → | 1.595 | B | M | 4 | 8 | BGU, BSE, BSF | | 81702 | |
| 1.6 BiFuel | 75 | 05/11 → | 1.595 | BF | M | 4 | 8 | CHGA | | 81702 | |
| 1.6 TDI | 55 | 08/10 → | 1.598 | D | M | 4 | 16 | CAYE | | 84001 | |
| | 75 | 08/10 → | 1.598 | D | M | 4 | 16 | CAYD | | 84001 | |
| 1.9 TDI | 55 | 09/05 → 08/10 | 1.896 | D | M | 4 | 8 | BSU | | 84010 | NEW |
| | 55 | 09/05 → 08/10 | 1.896 | D | M | 4 | 8 | BSU | | 81791 | |
| | 77 | 04/04 → 08/10 | 1.896 | D | M | 4 | 8 | BJB, BLS | | 84010 | NEW |
| | 77 | 04/04 → 08/10 | 1.896 | D | M | 4 | 8 | BJB, BLS | | 81791 | |
| 1.9 TDI 4motion | 77 | 11/08 → 08/10 | 1.896 | D | M | 4 | 8 | BLS | | 84010 | NEW |
| | 77 | 11/08 → 08/10 | 1.896 | D | M | 4 | 8 | BLS | | 81791 | |
| 2.0 EcoFuel | 80 | 04/06 → | 1.984 | M | M | 4 | 8 | BSX | | 81703 | |
| 2.0 SDI | 51 | 03/04 → 08/10 | 1.968 | D | M | 4 | 8 | BDJ, BST | | 84010 | NEW |
| | 51 | 03/04 → 08/10 | 1.968 | D | M | 4 | 8 | BDJ, BST | | 81791 | |
| 2.0 TDI | 62 | 11/10 → | 1.968 | D | M | 4 | 16 | CFHE | | 84001 | |
| | 81 | 08/10 → | 1.968 | D | M | 4 | 16 | CLCA | | 84001 | |
| | 103 | 09/07 → 08/10 | 1.968 | D | M | 4 | 8 | BMM | | 81816 | |
| | 103 | 09/07 → 08/10 | 1.968 | D | M | 4 | 8 | BMM | | 84011 | NEW |
| | 125 | 05/12 → | 1.968 | D | M | 4 | 16 | CFJA | | 84001 | |
| 2.0 TDI 16V | 103 | 11/10 → | 1.968 | D | M | 4 | 16 | CFHC, CLCB | | 84001 | |
| 2.0 TDI 16V 4motion | 103 | 11/10 → | 1.968 | D | M | 4 | 16 | CFHC | | 84001 | |
| 2.0 TDI 4motion | 62 | 12/10 → | 1.968 | D | M | 4 | 16 | CFHE | | 84001 | |
| | 81 | 08/10 → | 1.968 | D | M | 4 | 16 | CFHF | | 84001 | |

KW

cm³

NO. OF VALVES

MAGNETI MARELLI
VOLKSWAGEN
CC

| | | | | | | | | | | | |
|-----------------|-----|---------|-------|---|---|---|----|------------|--|-------|------------|
| | 112 | 11/11 → | 1.798 | B | M | 4 | 16 | CDAB | | 84016 | NEW |
| | 118 | 11/11 → | 1.798 | B | M | 4 | 16 | CDAА | | 84016 | NEW |
| 2.0 TDI | 100 | 11/11 → | 1.968 | D | M | 4 | 16 | CFFA | | 84001 | |
| | 103 | 11/11 → | 1.968 | D | M | 4 | 16 | CFFB | | 84001 | |
| | 125 | 11/11 → | 1.968 | D | M | 4 | 16 | CFGБ, CLLA | | 84001 | |
| | 130 | 12/12 → | 1.968 | D | M | 4 | 16 | CFGС | | 84001 | |
| 2.0 TDI 4motion | 103 | 11/11 → | 1.968 | D | M | 4 | 16 | CFFB | | 84001 | |
| | 125 | 11/11 → | 1.968 | D | M | 4 | 16 | CFGБ | | 84001 | |
| | 130 | 12/12 → | 1.968 | D | M | 4 | 16 | CFGС | | 84001 | |
| 2.0 TSI | 155 | 11/11 → | 1.984 | B | M | 4 | 16 | CCZB | | 84016 | NEW |
| 3.6 FSI 4motion | 220 | 11/11 → | 3.597 | B | M | 6 | 24 | BWS | | 81866 | |

Corrado

| | | | | | | | | | | | |
|-----------|-----|---------------|-------|---|---|---|----|---------|--------|-------|--|
| 1.8 16V | 100 | 04/89 → 07/92 | 1.781 | B | M | 4 | 16 | KR | (-)COP | 81522 | |
| | 100 | 04/89 → 07/92 | 1.781 | B | M | 4 | 16 | KR | (+)COP | 82080 | |
| 1.8 G60 | 118 | 09/88 → 09/93 | 1.781 | B | M | 4 | 8 | PG | (-)COP | 81522 | |
| | 118 | 09/88 → 09/93 | 1.781 | B | M | 4 | 8 | PG | (+)COP | 82080 | |
| 2.0 i | 85 | 04/93 → 12/95 | 1.984 | B | M | 4 | 8 | 2E, ADY | (-)COP | 81522 | |
| | 85 | 04/93 → 12/95 | 1.984 | B | M | 4 | 8 | 2E, ADY | (+)COP | 82080 | |
| 2.0 i 16V | 100 | 08/91 → 12/95 | 1.984 | B | M | 4 | 16 | 9A | (-)COP | 81522 | |
| | 100 | 08/91 → 12/95 | 1.984 | B | M | 4 | 16 | 9A | (+)COP | 82080 | |
| 2.9 VR6 | 140 | 08/91 → 12/95 | 2.861 | B | M | 6 | 12 | ABV | | 81773 | |

Crafter 30-35, 30-50

| | | | | | | | | | | | |
|-----------------|-----|---------------|-------|---|---|---|----|------------|--|-------|------------|
| 2.0 TDI | 80 | 05/11 → | 1.968 | D | M | 4 | 16 | CKTB | | 84001 | |
| | 100 | 05/11 → | 1.968 | D | M | 4 | 16 | CKTC | | 84001 | |
| | 105 | 10/11 → | 1.968 | D | M | 4 | 16 | CKUC | | 84001 | |
| | 120 | 07/11 → | 1.968 | D | M | 4 | 16 | CKUB, CSNA | | 84001 | |
| 2.0 TDI 4motion | 120 | 11/11 → | 1.968 | D | M | 4 | 16 | CKUB, CSNA | | 84001 | |
| 2.5 TDI | 65 | 04/06 → 07/11 | 2.461 | D | M | 5 | 10 | BJJ, CEBA | | 84010 | NEW |
| | 65 | 04/06 → 07/11 | 2.461 | D | M | 5 | 10 | BJJ, CEBA | | 81791 | |

Eos

| | | | | | | | | | | | |
|-------------|-----|---------------|-------|---|---|---|----|----------------------------------|--|-------|------------|
| 1.4 TSI | 118 | 05/08 → | 1.390 | B | M | 4 | 16 | CAVD, CTHD | | 82097 | |
| 1.6 FSI | 85 | 06/06 → 05/08 | 1.598 | B | M | 4 | 16 | BLF | | 81865 | |
| 2.0 FSI | 110 | 03/06 → 05/08 | 1.984 | B | M | 4 | 16 | BVY, BVZ | | 81702 | |
| 2.0 TDI | 100 | 11/10 → | 1.968 | D | M | 4 | 16 | CFFA | | 84001 | |
| | 103 | 06/06 → 05/08 | 1.968 | D | M | 4 | 8 | BMM | | 81816 | |
| | 103 | 06/06 → 05/08 | 1.968 | D | M | 4 | 8 | BMM | | 84011 | NEW |
| 2.0 TDI 16V | 103 | 05/08 → | 1.968 | D | M | 4 | 16 | CBAB, CFFB | | 81816 | |
| | 103 | 05/08 → | 1.968 | D | M | 4 | 16 | CBAB, CFFB | | 84011 | NEW |
| 2.0 TFSI | 147 | 03/06 → | 1.984 | B | M | 4 | 16 | BPY, BWA, CAWB, CBFA, CCTA, CCZA | | 82025 | |
| 2.0 TSI | 155 | 11/09 → | 1.984 | B | M | 4 | 16 | CCZB | | 84016 | NEW |
| 3.2 V6 | 184 | 06/06 → 05/09 | 3.189 | B | M | 6 | 24 | BUB, CBRA | | 81866 | |
| 3.6 V6 | 191 | 05/09 → 11/10 | 3.597 | B | M | 6 | 24 | CDVA | | 81866 | |

KW

cm³

NO. OF VALVES

VOLKSWAGEN
Fox I

| | | | | | | | | | | |
|----------------|----|---------|-------|---|---|---|---|--------------------------------|--|------------------|
| 1.2 | 40 | 04/05 → | 1.198 | B | M | 3 | 6 | BMD, CHFB | | 81867 |
| | 44 | 09/10 → | 1.198 | B | M | 3 | 6 | CHFA | | 81867 |
| 1.4 | 55 | 04/05 → | 1.390 | B | M | 4 | 8 | BKR | | 81527 |
| 1.4 TDI | 51 | 04/05 → | 1.422 | D | M | 3 | 6 | BNM | | 84010 NEW |
| | 51 | 04/05 → | 1.422 | D | M | 3 | 6 | BNM | | 81791 |
| 1.6 | 74 | 10/03 → | 1.598 | B | M | 4 | 8 | BAH, BJA, BLH, BPA, CCRA, CFZA | | 81527 |
| 1.6 Total Flex | 74 | 10/03 → | 1.598 | | M | 4 | 8 | BJA, BPA, CCRA | | 81527 |

Golf I, Cabrio

| | | | | | | | | | | |
|-----|----|---------------|-------|---|---|---|---|--------|--------|-------|
| 1.6 | 53 | 04/86 → 02/90 | 1.595 | B | M | 4 | 8 | RE | (-)COP | 81522 |
| | 53 | 04/86 → 02/90 | 1.595 | B | M | 4 | 8 | RE | (+)COP | 82080 |
| | 55 | 08/83 → 04/92 | 1.595 | B | M | 4 | 8 | EW, HN | (-)COP | 81522 |
| | 55 | 08/83 → 04/92 | 1.595 | B | M | 4 | 8 | EW, HN | (+)COP | 82080 |
| 1.8 | 66 | 08/83 → 09/92 | 1.781 | B | M | 4 | 8 | EX | (-)COP | 81522 |
| | 66 | 08/83 → 09/92 | 1.781 | B | M | 4 | 8 | EX | (+)COP | 82080 |
| | 70 | 08/83 → 04/93 | 1.781 | B | M | 4 | 8 | JH | (-)COP | 81522 |
| | 70 | 08/83 → 04/93 | 1.781 | B | M | 4 | 8 | JH | (+)COP | 82080 |
| | 72 | 08/89 → 03/93 | 1.781 | B | M | 4 | 8 | 2H | (-)COP | 81522 |
| | 72 | 08/89 → 03/93 | 1.781 | B | M | 4 | 8 | 2H | (+)COP | 82080 |

Golf II

| | | | | | | | | | | |
|----------|----|---------------|-------|---|---|---|---|-------------|---------------|-------|
| 1.0 | 37 | 08/85 → 10/91 | 1.043 | B | M | 4 | 8 | HZ | → M: 786.022 | 81520 |
| | 37 | 08/85 → 10/91 | 1.043 | B | M | 4 | 8 | HZ | M → : 786.023 | 81524 |
| 1.3 Cat. | 40 | 06/86 → 12/92 | 1.272 | B | M | 4 | 8 | 2G, MH, NZ | → M: 262.739 | 81520 |
| | 40 | 06/86 → 12/92 | 1.272 | B | M | 4 | 8 | 2G, MH, NZ | M → : 262.740 | 81524 |
| 1.6 | 51 | 10/86 → 12/92 | 1.595 | B | M | 4 | 8 | PN | (-)COP | 81522 |
| | 51 | 10/86 → 12/92 | 1.595 | B | M | 4 | 8 | PN | (+)COP | 82080 |
| | 53 | 02/86 → 10/91 | 1.595 | B | M | 4 | 8 | RF | (-)COP | 81522 |
| | 53 | 02/86 → 10/91 | 1.595 | B | M | 4 | 8 | RF | (+)COP | 82080 |
| | 55 | 08/83 → 07/92 | 1.595 | B | M | 4 | 8 | ABN, EZ, HM | (-)COP | 81522 |
| | 55 | 08/83 → 07/92 | 1.595 | B | M | 4 | 8 | ABN, EZ, HM | (+)COP | 82080 |
| 1.6 D | 37 | 08/83 → 10/91 | 1.588 | D | M | 4 | 8 | | (-)COP | 81522 |
| | 37 | 08/83 → 10/91 | 1.588 | D | M | 4 | 8 | | (+)COP | 82080 |
| | 40 | 08/83 → 10/91 | 1.588 | D | M | 4 | 8 | JP, ME | (-)COP | 81522 |
| | 40 | 08/83 → 10/91 | 1.588 | D | M | 4 | 8 | JP, ME | (+)COP | 82080 |
| 1.6 TD | 51 | 08/83 → 10/91 | 1.588 | D | M | 4 | 8 | JR, MF | (-)COP | 81522 |
| | 51 | 08/83 → 10/91 | 1.588 | D | M | 4 | 8 | JR, MF | (+)COP | 82080 |
| | 59 | 04/89 → 10/91 | 1.588 | D | M | 4 | 8 | RA, SB | (-)COP | 81522 |
| | 59 | 04/89 → 10/91 | 1.588 | D | M | 4 | 8 | RA, SB | (+)COP | 82080 |
| | 44 | 08/89 → 10/91 | 1.589 | D | M | 4 | 8 | 1V | (-)COP | 81522 |
| | 44 | 08/89 → 10/91 | 1.589 | D | M | 4 | 8 | 1V | (+)COP | 82080 |
| 1.8 | 62 | 08/86 → 01/90 | 1.781 | B | M | 4 | 8 | RH | (-)COP | 81522 |
| | 62 | 08/86 → 01/90 | 1.781 | B | M | 4 | 8 | RH | (+)COP | 82080 |
| | 66 | 08/84 → 10/91 | 1.781 | B | M | 4 | 8 | GU, GX, HV | (-)COP | 81522 |
| | 66 | 08/84 → 10/91 | 1.781 | B | M | 4 | 8 | GU, GX, HV | (+)COP | 82080 |

KW

cm³

NO. OF VALVES

VOLKSWAGEN
Golf II

| | | | | | | | | | | |
|--------------------|-----|---------------|-------|---|---|---|----|----------------|--------|-------|
| 1.8 GTI | 82 | 08/83 → 10/91 | 1.781 | B | M | 4 | 8 | DX, EV, GZ, PB | (-)COP | 81522 |
| | 82 | 08/83 → 10/91 | 1.781 | B | M | 4 | 8 | DX, EV, GZ, PB | (+)COP | 82080 |
| 1.8 GTI 16V | 95 | 02/86 → 10/91 | 1.781 | B | M | 4 | 16 | PL | (-)COP | 81522 |
| | 95 | 02/86 → 10/91 | 1.781 | B | M | 4 | 16 | PL | (+)COP | 82080 |
| | 102 | 02/86 → 06/90 | 1.781 | B | M | 4 | 16 | KR | (-)COP | 81522 |
| | 102 | 02/86 → 06/90 | 1.781 | B | M | 4 | 16 | KR | (+)COP | 82080 |
| 1.8 GTI Cat. | 79 | 01/87 → 10/91 | 1.781 | B | M | 4 | 8 | PF | (-)COP | 81522 |
| | 79 | 01/87 → 10/91 | 1.781 | B | M | 4 | 8 | PF | (+)COP | 82080 |
| 1.8 GTI G60 | 118 | 04/90 → 07/91 | 1.781 | B | M | 4 | 8 | PG | (-)COP | 81522 |
| | 118 | 04/90 → 07/91 | 1.781 | B | M | 4 | 8 | PG | (+)COP | 82080 |
| 1.8 GTI G60 Syncro | 118 | 08/88 → 12/91 | 1.781 | B | M | 4 | 8 | 1H, PG | (-)COP | 81522 |
| | 118 | 08/88 → 12/91 | 1.781 | B | M | 4 | 8 | 1H, PG | (+)COP | 82080 |
| 1.8 i Cat. | 66 | 08/87 → 10/91 | 1.781 | B | M | 4 | 8 | GX, RP | (-)COP | 81522 |
| | 66 | 08/87 → 10/91 | 1.781 | B | M | 4 | 8 | GX, RP | (+)COP | 82080 |
| 1.8 i Syncro Cat. | 66 | 08/87 → 10/91 | 1.781 | B | M | 4 | 8 | RP | (-)COP | 81522 |
| | 66 | 08/87 → 10/91 | 1.781 | B | M | 4 | 8 | RP | (+)COP | 82080 |
| 1.8 Syncro | 66 | 02/86 → 07/91 | 1.781 | B | M | 4 | 8 | GU, GX | (-)COP | 81522 |
| | 66 | 02/86 → 07/91 | 1.781 | B | M | 4 | 8 | GU, GX | (+)COP | 82080 |
| | 72 | 08/88 → 07/91 | 1.781 | B | M | 4 | 8 | 1P | (-)COP | 81522 |
| | 72 | 08/88 → 07/91 | 1.781 | B | M | 4 | 8 | 1P | (+)COP | 82080 |
| 2.0 | 57 | 08/85 → 07/92 | 1.968 | B | M | 4 | 8 | | (-)COP | 81522 |
| | 57 | 08/85 → 07/92 | 1.968 | B | M | 4 | 8 | | (+)COP | 82080 |

Golf III, Variant, Cabrio

| | | | | | | | | | | |
|-----|----|---------------|-------|---|---|---|---|---------------|--------------------------------------|-------|
| 1.3 | 40 | 08/91 → 07/92 | 1.272 | B | M | 4 | 8 | 2G | | 81524 |
| 1.4 | 40 | 07/93 → 04/99 | 1.390 | B | M | 4 | 8 | ABD | → 07-1995 | 81524 |
| | 40 | 07/93 → 04/99 | 1.390 | B | M | 4 | 8 | ABD | 08-1995 → | 81527 |
| | 40 | 11/91 → 08/97 | 1.390 | B | M | 4 | 8 | ABD, AEX | 08-1995 →, M: AEX | 81527 |
| | 40 | 11/91 → 08/97 | 1.390 | B | M | 4 | 8 | ABD, AEX | 11-1991 →, → 07-1995, M: ABD | 81524 |
| | 44 | 10/91 → 08/97 | 1.390 | B | M | 4 | 8 | ABD, AEX | → 07-1995, M: ABD | 81524 |
| | 44 | 10/91 → 08/97 | 1.390 | B | M | 4 | 8 | ABD, AEX | 08-1995 →, M: AEX | 81527 |
| | 44 | 07/93 → 04/99 | 1.390 | B | M | 4 | 8 | ABD, AEX, APQ | → 07-1995 | 81524 |
| | 44 | 07/93 → 04/99 | 1.390 | B | M | 4 | 8 | ABD, AEX, APQ | 08-1995 → | 81527 |
| 1.6 | 74 | 10/94 → 05/98 | 1.595 | B | M | 4 | 8 | AEK, AFT, AKS | (-)COP, 05-1996 → | 81522 |
| | 74 | 10/94 → 05/98 | 1.595 | B | M | 4 | 8 | AEK, AFT, AKS | (+)COP, 05-1996 → | 82080 |
| | 74 | 07/95 → 08/97 | 1.595 | B | M | 4 | 8 | AEK, AFT, AKS | (-)COP | 81522 |
| | 74 | 07/95 → 08/97 | 1.595 | B | M | 4 | 8 | AEK, AFT, AKS | (+)COP | 82080 |
| | 74 | 07/95 → 08/97 | 1.595 | B | M | 4 | 8 | AEK, AFT, AKS | (+)COP, M: AEK - AFT | 82080 |
| | 55 | 09/92 → 08/97 | 1.598 | B | M | 4 | 8 | ABU, AEA, AEE | → 07-1995, M: ABU | 81524 |
| | 55 | 09/92 → 08/97 | 1.598 | B | M | 4 | 8 | ABU, AEA, AEE | 05-1996 →, M: AEE, M: AEA, M: AEE | 81527 |

KW

cm³

NO. OF VALVES

VOLKSWAGEN
Golf III, Variant, Cabrio

| | | | | | | | | | | |
|------------|----|---------------|-------|---|---|---|---|---------------|---------------------------------|-------|
| 1.8 | 55 | 11/91 → 08/97 | 1.781 | B | M | 4 | 8 | AAM | (-)COP | 81522 |
| | 55 | 11/91 → 08/97 | 1.781 | B | M | 4 | 8 | AAM | (+)COP | 82080 |
| | 55 | 07/93 → 04/99 | 1.781 | B | M | 4 | 8 | AAM, ANN | (-)COP | 81522 |
| | 55 | 07/93 → 04/99 | 1.781 | B | M | 4 | 8 | AAM, ANN | (+)COP | 82080 |
| | 66 | 11/91 → 08/97 | 1.781 | B | M | 4 | 8 | ABS, ACC, ADZ | (-)COP | 81522 |
| | 66 | 11/91 → 08/97 | 1.781 | B | M | 4 | 8 | ABS, ACC, ADZ | (+)COP | 82080 |
| | 66 | 07/93 → 05/98 | 1.781 | B | M | 4 | 8 | ABS, ADZ | (-)COP | 81522 |
| | 66 | 07/93 → 05/98 | 1.781 | B | M | 4 | 8 | ABS, ADZ | (+)COP | 82080 |
| | 66 | 07/93 → 04/99 | 1.781 | B | M | 4 | 8 | ABS, ADZ, ANP | (-)COP | 81522 |
| | 66 | 07/93 → 04/99 | 1.781 | B | M | 4 | 8 | ABS, ADZ, ANP | (+)COP | 82080 |
| 1.8 Syncro | 66 | 10/94 → 04/99 | 1.781 | B | M | 4 | 8 | ADZ | (-)COP | 81522 |
| | 66 | 10/94 → 04/99 | 1.781 | B | M | 4 | 8 | ADZ | (+)COP | 82080 |
| | 66 | 01/93 → 08/97 | 1.781 | B | M | 4 | 8 | ABS, ADZ | (-)COP | 81522 |
| | 66 | 01/93 → 08/97 | 1.781 | B | M | 4 | 8 | ABS, ADZ | (+)COP | 82080 |
| 1.9 D | 48 | 11/91 → 08/97 | 1.896 | D | M | 4 | 8 | 1Y | (-)COP, → 07-1995 | 81522 |
| | 48 | 11/91 → 08/97 | 1.896 | D | M | 4 | 8 | 1Y | (+)COP | 82080 |
| | 48 | 11/91 → 08/97 | 1.896 | D | M | 4 | 8 | 1Y | (+)COP, → 07-1995 | 82080 |
| | 48 | 11/91 → 08/97 | 1.896 | D | M | 4 | 8 | 1Y | 08-1995 → | 81528 |
| | 48 | 07/93 → 04/99 | 1.896 | D | M | 4 | 8 | 1Y | 08-1995 →, → 04-1996 | 81528 |
| 1.9 SDI | 47 | 07/95 → 04/99 | 1.896 | D | M | 4 | 8 | AEY | | 81528 |
| | 47 | 07/95 → 08/97 | 1.896 | D | M | 4 | 8 | AEY | (-)COP | 81522 |
| | 47 | 07/95 → 08/97 | 1.896 | D | M | 4 | 8 | AEY | (+)COP | 82080 |
| 1.9 TD | 55 | 07/93 → 04/99 | 1.896 | D | M | 4 | 8 | AAZ | (-)COP, → 07-1995 | 81522 |
| | 55 | 07/93 → 04/99 | 1.896 | D | M | 4 | 8 | AAZ | (+)COP | 82080 |
| | 55 | 07/93 → 04/99 | 1.896 | D | M | 4 | 8 | AAZ | (+)COP, → 07-1995 | 82080 |
| | 55 | 07/93 → 04/99 | 1.896 | D | M | 4 | 8 | AAZ | 08-1995 →, → 12-1997 | 81528 |
| 1.9 TD,GTD | 55 | 11/91 → 08/97 | 1.896 | D | M | 4 | 8 | AAZ | (-)COP, → 07-1995 | 81522 |
| | 55 | 11/91 → 08/97 | 1.896 | D | M | 4 | 8 | AAZ | (+)COP | 82080 |
| | 55 | 11/91 → 08/97 | 1.896 | D | M | 4 | 8 | AAZ | (+)COP, → 07-1995 | 82080 |
| | 55 | 11/91 → 08/97 | 1.896 | D | M | 4 | 8 | AAZ | 08-1995 → | 81528 |
| 1.9 TDI | 66 | 09/93 → 08/97 | 1.896 | D | M | 4 | 8 | 1Z, AHU, ALE | (-)COP, → 07-1995 | 81522 |
| | 66 | 09/93 → 08/97 | 1.896 | D | M | 4 | 8 | 1Z, AHU, ALE | (+)COP | 82080 |
| | 66 | 09/93 → 08/97 | 1.896 | D | M | 4 | 8 | 1Z, AHU, ALE | (+)COP, → 07-1995 | 82080 |
| | 66 | 09/93 → 08/97 | 1.896 | D | M | 4 | 8 | 1Z, AHU, ALE | 08-1995 → | 81528 |
| | 66 | 03/94 → 04/99 | 1.896 | D | M | 4 | 8 | 1Z, AHU, ALE | 07-1995 →, → 12-1997, M: AHU | 81528 |
| | 66 | 08/95 → 05/98 | 1.896 | D | M | 4 | 8 | 1Z, AHU, ALE | (-)COP, M: 1Z | 81522 |
| | 66 | 08/95 → 05/98 | 1.896 | D | M | 4 | 8 | 1Z, AHU, ALE | (+)COP, M: 1Z | 82080 |
| | 66 | 08/95 → 05/98 | 1.896 | D | M | 4 | 8 | 1Z, AHU, ALE | M: AHU | 81528 |
| | 81 | 04/96 → 08/97 | 1.896 | D | M | 4 | 8 | AFN | (-)COP | 81522 |
| | 81 | 04/96 → 08/97 | 1.896 | D | M | 4 | 8 | AFN | (+)COP | 82080 |

| | | | | | | | | | |
|--|--|--|--|--|--|--|---------------|--|--|
| | | | | | | | NO. OF VALVES | | |
|--|--|--|--|--|--|--|---------------|--|--|

VOLKSWAGEN

Golf III, Variant, Cabrio

| | | | | | | | | | | |
|----------------|-----|---------------|-------|---|---|---|----|------------------------|-------------------|-------|
| 1.9 TDI Syncro | 66 | 07/95 → 04/99 | 1.896 | D | M | 4 | 8 | 1Z, AHU, ALE | (-)COP, → 07-1995 | 81522 |
| | 66 | 07/95 → 04/99 | 1.896 | D | M | 4 | 8 | 1Z, AHU, ALE | (+)COP | 82080 |
| | 66 | 07/95 → 04/99 | 1.896 | D | M | 4 | 8 | 1Z, AHU, ALE | (+)COP, → 07-1995 | 82080 |
| | 66 | 07/95 → 04/99 | 1.896 | D | M | 4 | 8 | 1Z, AHU, ALE | 08-1995 → | 81528 |
| | 66 | 08/95 → 08/97 | 1.896 | D | M | 4 | 8 | 1Z, AHU, ALE | | 81528 |
| 2.0 | 79 | 08/95 → 04/96 | 1.984 | B | M | 4 | 8 | AEP | (+)COP | 82080 |
| | 85 | 11/91 → 08/97 | 1.984 | B | M | 4 | 8 | 2E, ABA, ADY, AGG, AKR | (-)COP | 81522 |
| | 85 | 11/91 → 08/97 | 1.984 | B | M | 4 | 8 | 2E, ABA, ADY, AGG, AKR | (+)COP | 82080 |
| | 85 | 07/93 → 05/98 | 1.984 | B | M | 4 | 8 | 2E, ADY, AGG, AKR | (-)COP, 08-1991 → | 81522 |
| | 85 | 07/93 → 05/98 | 1.984 | B | M | 4 | 8 | 2E, ADY, AGG, AKR | (+)COP | 82080 |
| | 85 | 07/93 → 05/98 | 1.984 | B | M | 4 | 8 | 2E, ADY, AGG, AKR | (+)COP, 08-1991 → | 82080 |
| 2.0 GTI 16V | 110 | 08/92 → 08/97 | 1.984 | B | M | 4 | 16 | ABF | (-)COP, 08-1991 → | 81522 |
| | 110 | 08/92 → 08/97 | 1.984 | B | M | 4 | 16 | ABF | (+)COP | 82080 |
| | 110 | 08/92 → 08/97 | 1.984 | B | M | 4 | 16 | ABF | (+)COP, 08-1991 → | 82080 |
| 2.0 Syncro | 85 | 08/95 → 04/99 | 1.984 | B | M | 4 | 8 | AGG | (-)COP, 08-1991 → | 81522 |
| | 85 | 08/95 → 04/99 | 1.984 | B | M | 4 | 8 | AGG | (+)COP | 82080 |
| | 85 | 08/95 → 04/99 | 1.984 | B | M | 4 | 8 | AGG | (+)COP, 08-1991 → | 82080 |
| | 85 | 08/95 → 08/97 | 1.984 | B | M | 4 | 8 | AGG | (-)COP, 08-1991 → | 81522 |
| | 85 | 08/95 → 08/97 | 1.984 | B | M | 4 | 8 | AGG | (+)COP | 82080 |
| | 85 | 08/95 → 08/97 | 1.984 | B | M | 4 | 8 | AGG | (+)COP, 08-1991 → | 82080 |
| 2.8 VR6 | 128 | 01/92 → 08/97 | 2.792 | B | M | 6 | 12 | AAA | | 81773 |
| 2.9 VR6 Syncro | 140 | 10/94 → 04/99 | 2.861 | B | M | 6 | 12 | ABV | 01-1993 → | 81773 |
| | 140 | 10/94 → 08/97 | 2.861 | B | M | 6 | 12 | ABV | 01-1993 → | 81773 |

Golf IV, Variant, Cabrio

| | | | | | | | | | | |
|---------|----|---------------|-------|---|---|---|----|-------------------------|-------------------|-------|
| 1.4 16V | 55 | 08/97 → 06/05 | 1.390 | B | M | 4 | 16 | AHW, AKQ, APE, AXP, BCA | | 81777 |
| | 55 | 05/99 → 06/06 | 1.390 | B | M | 4 | 16 | AHW, AKQ, APE, AXP, BCA | 01-1997 → | 81777 |
| 1.6 | 74 | 08/97 → 05/04 | 1.595 | B | M | 4 | 8 | AEH, AKL, APF | | 81702 |
| | 74 | 06/98 → 06/02 | 1.595 | B | M | 4 | 8 | AFT, AKS | (-)COP, 05-1996 → | 81522 |
| | 74 | 06/98 → 06/02 | 1.595 | B | M | 4 | 8 | AFT, AKS | (+)COP | 82080 |
| | 74 | 06/98 → 06/02 | 1.595 | B | M | 4 | 8 | AFT, AKS | (+)COP, 05-1996 → | 82080 |
| | 75 | 08/00 → 06/06 | 1.595 | B | A | 4 | 8 | AVU, BFQ | | 81702 |
| | 75 | 08/00 → 06/05 | 1.595 | B | A | 4 | 8 | AVU, BFQ, BJH | | 81702 |
| | 78 | 08/03 → 06/05 | 1.595 | B | M | 4 | 20 | AWB | | 81840 |
| | 74 | 02/01 → 06/01 | 1.598 | B | M | 4 | 8 | BAH | | 81702 |
| 1.6 16V | 77 | 02/00 → 06/05 | 1.598 | B | M | 4 | 16 | ATN, AUS, AZD, BCB | | 81840 |
| 1.6 FSI | 81 | 01/02 → 06/05 | 1.598 | B | M | 4 | 16 | BAD | → 09-2003 | 81840 |

KW

cm³

NO. OF VALVES

MAGNETI MARELLI
VOLKSWAGEN
Golf IV, Variant, Cabrio

| | | | | | | | | | | |
|-------------|-----------------|---------------|---------------|-------|----|---|-----|-------------------------|-------------------|------------------|
| 1.8 | 55 | 06/98 → 06/02 | 1.781 | B | M | 4 | 8 | AAM, ANN | (-)COP, 11-1991 → | 81522 |
| | 55 | 06/98 → 06/02 | 1.781 | B | M | 4 | 8 | AAM, ANN | (+)COP | 82080 |
| | 55 | 06/98 → 06/02 | 1.781 | B | M | 4 | 8 | AAM, ANN | (+)COP, 11-1991 → | 82080 |
| | 66 | 06/98 → 06/02 | 1.781 | B | M | 4 | 8 | ADZ, ANP | (-)COP, 11-1991 → | 81522 |
| | 66 | 06/98 → 06/02 | 1.781 | B | M | 4 | 8 | ADZ, ANP | (+)COP | 82080 |
| | 66 | 06/98 → 06/02 | 1.781 | B | M | 4 | 8 | ADZ, ANP | (+)COP, 11-1991 → | 82080 |
| | 92 | 08/97 → 06/05 | 1.781 | B | M | 4 | 20 | AGN, BAF | 10-1997 → | 81703 |
| 1.8 4motion | 92 | 05/98 → 06/05 | 1.781 | B | M | 4 | 20 | AGN | | 81703 |
| 1.8 T | 110 | 08/97 → 06/05 | 1.781 | B | M | 4 | 20 | AGU, AQA, ARZ, AUM, AWD | 10-1997 → | 81703 |
| | 110 | 05/00 → 06/06 | 1.781 | B | M | 4 | 20 | AGU, AQA, ARZ, AUM, AWD | | 81703 |
| 1.8 T GTI | 132 | 08/01 → 06/05 | 1.781 | B | M | 4 | 20 | AUQ | | 81703 |
| 1.9 SDI | 50 | 08/97 → 06/05 | 1.896 | D | M | 4 | 8 | AGP, AQM | M: AQM, M: AGP | 81706 |
| 1.9 TDI | 66 | 10/97 → 05/04 | 1.896 | D | M | 4 | 8 | AGR, ALH | M: ALH, M: AGR | 81706 |
| | 66 | 06/98 → 06/02 | 1.896 | D | M | 4 | 8 | AHU, ALE | (-)COP | 81522 |
| | 66 | 06/98 → 06/02 | 1.896 | D | M | 4 | 8 | AHU, ALE | (+)COP | 82080 |
| | 74 | 09/00 → 06/05 | 1.896 | D | M | 4 | 8 | ATD, AXR | | 81816 |
| | 74 | 09/00 → 06/05 | 1.896 | D | M | 4 | 8 | ATD, AXR | | 84011 NEW |
| | 81 | 06/98 → 06/02 | 1.896 | D | M | 4 | 8 | AFN, AVG | (-)COP | 81522 |
| | 81 | 06/98 → 06/02 | 1.896 | D | M | 4 | 8 | AFN, AVG | (+)COP | 82080 |
| | 81 | 08/97 → 05/04 | 1.896 | D | M | 4 | 8 | AHF, ASV | M: ASF, M: AHF | 81706 |
| | 81 | 05/99 → 06/01 | 1.896 | D | M | 4 | 8 | AHF, ASV | M: ASV, M: AHF | 81706 |
| | 85 | 12/98 → 06/01 | 1.896 | D | AM | 4 | 8 | AJM, AUY | | 81816 |
| | 85 | 12/98 → 06/01 | 1.896 | D | AM | 4 | 8 | AJM, AUY | | 84011 NEW |
| | 96 | 11/00 → 06/05 | 1.896 | D | M | 4 | 8 | ASZ | | 81816 |
| | 96 | 11/00 → 06/05 | 1.896 | D | M | 4 | 8 | ASZ | | 84011 NEW |
| | 110 | 06/01 → 06/06 | 1.896 | D | M | 4 | 8 | ARL | | 81816 |
| | 110 | 05/00 → 06/05 | 1.896 | D | M | 4 | 8 | ARL | M: ARL | 81816 |
| | 1.9 TDI 4motion | 110 | 05/00 → 06/05 | 1.896 | D | M | 4 | 8 | ARL | |
| 66 | | 07/98 → 04/02 | 1.896 | D | M | 4 | 8 | AGR, ALH | M: ALH, M: AGR | 81706 |
| 74 | | 09/00 → 06/05 | 1.896 | D | M | 4 | 8 | ATD | | 81816 |
| 74 | | 09/00 → 06/05 | 1.896 | D | M | 4 | 8 | ATD | | 84011 NEW |
| 85 | | 05/99 → 06/01 | 1.896 | D | M | 4 | 8 | AJM | | 81816 |
| 85 | | 05/99 → 06/01 | 1.896 | D | M | 4 | 8 | AJM | | 84011 NEW |
| 85 | | 09/99 → 06/01 | 1.896 | D | M | 4 | 8 | AJM, AUY | | 81816 |
| 85 | | 09/99 → 06/01 | 1.896 | D | M | 4 | 8 | AJM, AUY | | 84011 NEW |
| 96 | | 11/00 → 06/05 | 1.896 | D | M | 4 | 8 | ASZ | | 81816 |
| 96 | | 11/00 → 06/05 | 1.896 | D | M | 4 | 8 | ASZ | | 84011 NEW |
| 110 | | 05/02 → 06/05 | 1.896 | D | M | 4 | 8 | ARL | | 81816 |
| 110 | 02/00 → 06/05 | 1.896 | D | M | 4 | 8 | ARL | M: ARL | 81816 | |
| 110 | 02/00 → 06/05 | 1.896 | D | M | 4 | 8 | ARL | | 84011 NEW | |

| | | | | | | | | | | |
|--|--|----|--|-----------------|--|--|--|---------------|--|--|
| | | KW | | cm ³ | | | | NO. OF VALVES | | |
|--|--|----|--|-----------------|--|--|--|---------------|--|--|

VOLKSWAGEN

Golf IV, Variant, Cabrio

| | | | | | | | | | | |
|-----------------|-----|---------------|-------|---|---|---|----|-------------------------|-------------------|-------|
| 2.0 | 85 | 06/98 → 06/02 | 1.984 | B | M | 4 | 8 | AGG, AKR, ATU, AWF, AWG | (-)COP, 08-1991 → | 81522 |
| | 85 | 06/98 → 06/02 | 1.984 | B | M | 4 | 8 | AGG, AKR, ATU, AWF, AWG | (+)COP | 82080 |
| | 85 | 06/98 → 06/02 | 1.984 | B | M | 4 | 8 | AGG, AKR, ATU, AWF, AWG | (+)COP, 08-1991 → | 82080 |
| | 85 | 07/98 → 05/04 | 1.984 | B | M | 4 | 8 | APK, AQY, AZG, AZJ, BER | | 81703 |
| | 85 | 05/99 → 06/06 | 1.984 | B | M | 4 | 8 | APK, AQY, AZJ | | 81703 |
| 2.0 4motion | 85 | 10/00 → 06/05 | 1.984 | B | M | 4 | 8 | AZH, AZJ | | 81703 |
| | 88 | 12/99 → 06/06 | 1.984 | B | M | 4 | 8 | ATF | | 81703 |
| 2.0 Bi-Fuel | 85 | 02/02 → 06/06 | 1.984 | | M | 4 | 8 | BEH | | 81703 |
| 2.3 V5 | 110 | 08/97 → 10/00 | 2.324 | B | M | 5 | 10 | AGZ | | 81856 |
| | 125 | 10/00 → 06/05 | 2.324 | B | M | 5 | 20 | AQN | | 81856 |
| 2.3 V5 4motion | 110 | 12/98 → 10/00 | 2.324 | B | M | 5 | 10 | AGZ | | 81856 |
| | 125 | 10/00 → 06/05 | 2.324 | B | M | 5 | 20 | AQN | | 81856 |
| 2.8 V6 4motion | 150 | 03/99 → 06/05 | 2.792 | B | M | 6 | 24 | AQP, AUE, BDE | | 81773 |
| 3.2 R32 4motion | 177 | 09/02 → 06/05 | 3.189 | B | M | 6 | 24 | BFH, BML | | 81866 |

Golf V, Plus, Variant

| | | | | | | | | | | | |
|---------------|---------------|---------------|-------|----|---|---|----------|----------------------|-------|-------|--|
| 1.2 TSI | 63 | 05/10 → 12/13 | 1.197 | B | M | 4 | 8 | CBZA | | 84045 | |
| | 77 | 11/09 → 12/13 | 1.197 | B | M | 4 | 8 | CBZB | | 84045 | |
| 1.4 | 59 | 06/07 → 07/09 | 1.390 | B | M | 4 | 16 | BUD | | 81777 | |
| 1.4 16V | 55 | 01/05 → 11/06 | 1.390 | B | M | 4 | 16 | BCA | | 81777 | |
| | 59 | 05/06 → 11/08 | 1.390 | B | M | 4 | 16 | BUD | | 81777 | |
| | 59 | 05/06 → 12/13 | 1.390 | B | M | 4 | 16 | BUD, CGGA | | 81777 | |
| 1.4 FSI | 66 | 10/03 → 07/06 | 1.390 | B | M | 4 | 16 | BKG, BLN | | 81865 | |
| | 66 | 07/05 → 11/06 | 1.390 | B | M | 4 | 16 | BLN | | 81865 | |
| | 90 | 06/07 → 12/13 | 1.390 | B | M | 4 | 16 | CAXA | | 82097 | |
| 1.6 | 75 | 01/04 → 11/08 | 1.595 | B | M | 4 | 8 | BGU, BSE, BSF | | 81702 | |
| | 75 | 06/07 → 07/09 | 1.595 | B | M | 4 | 8 | BGU, BSE, BSF, CCSA | | 81702 | |
| | 75 | 05/05 → 12/13 | 1.595 | B | M | 4 | 8 | BSE, BSF, CCSA, CMXA | | 81702 | |
| 1.6 BiFuel | 75 | 05/09 → 12/13 | 1.595 | BF | M | 4 | 8 | CHGA | | 81702 | |
| 1.6 FSI | 85 | 10/03 → 07/08 | 1.598 | B | M | 4 | 16 | BAG, BLF, BLP | | 81865 | |
| | 85 | 01/05 → 05/08 | 1.598 | B | M | 4 | 16 | BLF | | 81865 | |
| 1.6 MultiFuel | 75 | 10/07 → 11/08 | 1.595 | | M | 4 | 8 | CCSA | | 81702 | |
| | 75 | 11/07 → 12/13 | 1.595 | | M | 4 | 8 | CCSA, CMXA | | 81702 | |
| 1.6 TDI | 66 | 02/09 → 12/13 | 1.598 | D | M | 4 | 16 | CAYB | | 84001 | |
| | 77 | 03/09 → 12/13 | 1.598 | D | M | 4 | 16 | CAYC | | 84001 | |
| 1.9 TDI | 66 | 05/05 → 12/08 | 1.896 | D | M | 4 | 8 | BRU, BXF, BXJ | | 84010 | |
| | 66 | 05/05 → 12/08 | 1.896 | D | M | 4 | 8 | BRU, BXF, BXJ | | 81791 | |
| | 77 | 01/05 → 01/09 | 1.896 | D | M | 4 | 8 | BKC, BLS, BXE | | 84010 | |
| | 77 | 01/05 → 01/09 | 1.896 | D | M | 4 | 8 | BKC, BLS, BXE | | 81791 | |
| | 77 | 06/07 → 07/09 | 1.896 | D | M | 4 | 8 | BLS, BXE | | 84010 | |
| 77 | 06/07 → 07/09 | 1.896 | D | M | 4 | 8 | BLS, BXE | | 81791 | | |

KW

cm³

NO. OF VALVES

VOLKSWAGEN
Golf V, Plus, Variant

| | | | | | | | | | | |
|---------------------|-----|---------------|-------|---|---|---|----|-----------------------------------|-------|------------|
| 1.9 TDI 4motion | 77 | 08/04 → 11/08 | 1.896 | D | M | 4 | 8 | BKC, BLS, BXE | 84010 | NEW |
| | 77 | 08/04 → 11/08 | 1.896 | D | M | 4 | 8 | BKC, BLS, BXE | 81791 | |
| | 77 | 01/08 → 07/09 | 1.896 | D | M | 4 | 8 | BLS | 84010 | NEW |
| | 77 | 01/08 → 07/09 | 1.896 | D | M | 4 | 8 | BLS | 81791 | |
| 2.0 | 147 | 06/07 → 07/09 | 1.984 | B | M | 4 | 16 | BWA, CAWB, CCTA | 82025 | |
| 2.0 FSI | 110 | 01/04 → 11/08 | 1.984 | B | M | 4 | 16 | AXW, BLR, BLX, BLY, BVX, BVY, BVZ | 81702 | |
| | 110 | 05/05 → 06/08 | 1.984 | B | M | 4 | 16 | BLR, BLY, BVY, BVZ | 81702 | |
| 2.0 FSI 4motion | 110 | 08/04 → 11/08 | 1.984 | B | M | 4 | 16 | BLX, BLY, BVX, BVY, BVZ | 81702 | |
| 2.0 GTI | 147 | 10/04 → 02/09 | 1.984 | B | M | 4 | 16 | AXX, BPY, BWA, CAWB, CBFA, CCTA | 82025 | |
| | 169 | 09/06 → 12/08 | 1.984 | B | M | 4 | 16 | BYD | 82025 | |
| 2.0 SDI | 55 | 01/04 → 11/08 | 1.968 | D | M | 4 | 8 | BDK | 84010 | NEW |
| | 55 | 01/04 → 11/08 | 1.968 | D | M | 4 | 8 | BDK | 81791 | |
| 2.0 TDI | 81 | 01/09 → 12/13 | 1.968 | D | M | 4 | 16 | CBDC, CLCA | 81816 | |
| | 81 | 01/09 → 12/13 | 1.968 | D | M | 4 | 16 | CBDC, CLCA | 84011 | NEW |
| | 96 | 05/05 → 05/07 | 1.968 | D | M | 4 | 16 | BEE | 81816 | |
| | 96 | 05/05 → 05/07 | 1.968 | D | M | 4 | 16 | BEE | 84011 | NEW |
| | 100 | 06/07 → 07/09 | 1.968 | D | M | 4 | 16 | AZV | 81816 | |
| | 100 | 06/07 → 07/09 | 1.968 | D | M | 4 | 16 | AZV | 84011 | NEW |
| | 100 | 10/03 → 11/08 | 1.968 | D | M | 4 | 16 | AZV, CBDA | 81816 | |
| | 100 | 10/03 → 11/08 | 1.968 | D | M | 4 | 16 | AZV, CBDA | 84011 | NEW |
| | 100 | 05/05 → 12/13 | 1.968 | D | M | 4 | 16 | AZV, CBDA, CFHB | 81816 | |
| | 100 | 05/05 → 12/13 | 1.968 | D | M | 4 | 16 | AZV, CBDA, CFHB | 84011 | NEW |
| | 103 | 12/05 → 05/11 | 1.968 | D | M | 4 | 8 | BMM | 81816 | |
| | 103 | 12/05 → 05/11 | 1.968 | D | M | 4 | 8 | BMM | 84011 | NEW |
| | 125 | 11/05 → 11/08 | 1.968 | D | M | 4 | 16 | BMN | 81816 | |
| | 125 | 11/05 → 11/08 | 1.968 | D | M | 4 | 16 | BMN | 84011 | NEW |
| 2.0 TDI 16V | 103 | 10/03 → 11/08 | 1.968 | D | M | 4 | 16 | BKD | 81816 | |
| | 103 | 10/03 → 11/08 | 1.968 | D | M | 4 | 16 | BKD | 84011 | NEW |
| | 103 | 06/07 → 07/09 | 1.968 | D | M | 4 | 16 | BKD, CBDB | 81816 | |
| | 103 | 06/07 → 07/09 | 1.968 | D | M | 4 | 16 | BKD, CBDB | 84011 | NEW |
| | 103 | 01/05 → 12/13 | 1.968 | D | M | 4 | 16 | BKD, CBDB, CFHC | 81816 | |
| | 103 | 01/05 → 12/13 | 1.968 | D | M | 4 | 16 | BKD, CBDB, CFHC | 84011 | NEW |
| 2.0 TDI 16V 4motion | 103 | 08/04 → 11/08 | 1.968 | D | M | 4 | 16 | BKD | 81816 | |
| | 103 | 08/04 → 11/08 | 1.968 | D | M | 4 | 16 | BKD | 84011 | NEW |
| 2.0 TDI 4motion | 100 | 06/07 → 07/09 | 1.968 | D | M | 4 | 16 | AZV | 81816 | |
| | 100 | 06/07 → 07/09 | 1.968 | D | M | 4 | 16 | AZV | 84011 | NEW |
| | 103 | 08/04 → 11/08 | 1.968 | D | M | 4 | 8 | BMM | 81816 | |
| | 103 | 08/04 → 11/08 | 1.968 | D | M | 4 | 8 | BMM | 84011 | NEW |
| 3.2 | 184 | 09/05 → 11/08 | 3.189 | B | M | 6 | 24 | BUB | 81866 | |
| 3.2 R32 4motion | 177 | 01/04 → 11/08 | 3.189 | B | M | 6 | 24 | BJS | 81866 | |
| | 184 | 11/05 → 11/08 | 3.189 | B | M | 6 | 24 | BUB, CBRA | 81866 | |

| | | | | | | | | | | | |
|--|--|----|--|-----------------|--|--|--|---------------|--|--|--|
| | | KW | | cm ³ | | | | NO. OF VALVES | | | |
|--|--|----|--|-----------------|--|--|--|---------------|--|--|--|

VOLKSWAGEN

Golf VI, Variant, Cabrio

| | | | | | | | | | | | |
|-----------------|-----|---------------|-------|----|---|---|----|------------------------|---------|-------|--|
| 1.2 TSI | 63 | 05/10 → 11/12 | 1.197 | B | M | 4 | 8 | CBZA | | 84045 | |
| | 77 | 11/08 → 11/12 | 1.197 | B | M | 4 | 8 | CBZB | | 84045 | |
| 1.2 TSI 16V | 77 | 11/13 → | 1.197 | B | M | 4 | 16 | CYVD | | 84062 | |
| 1.4 | 59 | 07/09 → 07/13 | 1.390 | B | M | 4 | 16 | BUD, CGGA | | 81777 | |
| | 59 | 10/08 → 11/12 | 1.390 | B | M | 4 | 16 | CGGA | | 81777 | |
| 1.4 TSI | 90 | 10/08 → 11/12 | 1.390 | B | M | 4 | 16 | CAXA | | 82097 | |
| | 92 | 11/13 → | 1.395 | B | M | 4 | 16 | CXSB, CZCA | | 84062 | |
| | 110 | 11/13 → | 1.395 | B | M | 4 | 16 | CHPB, CZDA | | 84062 | |
| 1.6 | 75 | 10/08 → 11/12 | 1.595 | B | M | 4 | 8 | BSE, BSF, CCSA, CMXA | | 81702 | |
| 1.6 BiFuel | 75 | 03/09 → 11/12 | 1.595 | BF | M | 4 | 8 | CHGA | | 81702 | |
| 1.6 MultiFuel | 75 | 10/08 → 11/12 | 1.595 | | M | 4 | 8 | CCSA, CMXA | | 81702 | |
| | 75 | 07/10 → 07/13 | 1.595 | | M | 4 | 8 | CMXA | | 81702 | |
| 1.6 TDI | 66 | 02/09 → 11/12 | 1.598 | D | M | 4 | 16 | CAYB | | 84001 | |
| | 77 | 02/09 → 11/12 | 1.598 | D | M | 4 | 16 | CAYC | | 84001 | |
| 1.6 TDI 4motion | 77 | 07/09 → 07/13 | 1.598 | D | M | 4 | 16 | CAYC | | 84001 | |
| 1.8 TSI | 118 | 06/09 → 01/11 | 1.798 | B | M | 4 | 16 | CDAA | | 84016 | |
| 2.0 GTi | 147 | 06/09 → 11/13 | 1.984 | B | M | 4 | 16 | CBFA, CCTA, CCZA | | 82025 | |
| | 155 | 04/09 → 11/12 | 1.984 | B | M | 4 | 16 | CCZB | | 84016 | |
| | 173 | 05/11 → 11/12 | 1.984 | B | M | 4 | 16 | CDLG | | 82025 | |
| 2.0 R | 195 | 01/13 → | 1.984 | B | M | 4 | 16 | CDLA | | 82025 | |
| 2.0 R 4motion | 188 | 11/09 → 11/13 | 1.984 | B | M | 4 | 16 | CDLC, CRZA | | 82025 | |
| | 195 | 11/09 → 05/11 | 1.984 | B | M | 4 | 16 | CDLA | | 82025 | |
| | 199 | 11/09 → 11/12 | 1.984 | B | M | 4 | 16 | CDLF | | 82025 | |
| 2.0 TDI | 81 | 10/08 → 11/12 | 1.968 | D | M | 4 | 16 | CBDC, CLCA | | 81816 | |
| | 81 | 10/08 → 11/12 | 1.968 | D | M | 4 | 16 | CBDC, CLCA | | 84011 | |
| | 81 | 01/10 → 07/13 | 1.968 | D | M | 4 | 16 | CLCA | | 84001 | |
| | 100 | 10/08 → 11/12 | 1.968 | D | M | 4 | 16 | CBAA, CFFA | M: CBAA | 81816 | |
| | 100 | 10/08 → 11/12 | 1.968 | D | M | 4 | 16 | CBAA, CFFA | M: CFFA | 84001 | |
| | 100 | 10/08 → 11/12 | 1.968 | D | M | 4 | 16 | CBAA, CFFA | | 84001 | |
| | 100 | 10/08 → 11/12 | 1.968 | D | M | 4 | 16 | CBAA, CFFA | | 84011 | |
| | 100 | 07/09 → 07/13 | 1.968 | D | M | 4 | 16 | CBDA, CFHB | | 81816 | |
| | 100 | 07/09 → 07/13 | 1.968 | D | M | 4 | 16 | CBDA, CFHB | | 84011 | |
| | 103 | 10/08 → 05/13 | 1.968 | D | M | 4 | 16 | CBAB, CFFB, CJAA | | 81816 | |
| | 103 | 10/08 → 05/13 | 1.968 | D | M | 4 | 16 | CBAB, CFFB, CJAA | | 84011 | |
| | 103 | 11/11 → | 1.968 | D | M | 4 | 16 | CFHC | | 84001 | |
| | 125 | 04/09 → 11/12 | 1.968 | D | M | 4 | 16 | CBBB, CFGB | | 81816 | |
| | 125 | 04/09 → 11/12 | 1.968 | D | M | 4 | 16 | CBBB, CFGB | | 84011 | |
| 2.0 TDI 16V | 103 | 07/09 → 07/13 | 1.968 | D | M | 4 | 16 | CBDB, CFHC, CJAA, CLCB | | 81816 | |
| | 103 | 07/09 → 07/13 | 1.968 | D | M | 4 | 16 | CBDB, CFHC, CJAA, CLCB | | 84011 | |

KW

cm³

NO. OF VALVES

MAGNETI MARELLI
VOLKSWAGEN
Golf VI, Variant, Cabrio

| | | | | | | | | | | |
|-----------------|-----|---------------|-------|---|---|---|----|------------|---------|------------------|
| 2.0 TDI 4motion | 103 | 05/09 → 11/12 | 1.968 | D | M | 4 | 16 | CBAB, CFFB | M: CBAB | 81816 |
| | 103 | 05/09 → 11/12 | 1.968 | D | M | 4 | 16 | CBAB, CFFB | M: CFFB | 84001 |
| | 103 | 05/09 → 11/12 | 1.968 | D | M | 4 | 16 | CBAB, CFFB | | 84001 |
| | 103 | 05/09 → 11/12 | 1.968 | D | M | 4 | 16 | CBAB, CFFB | | 84011 NEW |
| 2.0 TSI | 147 | 07/09 → 07/13 | 1.984 | B | M | 4 | 16 | CCZA | | 84016 NEW |

Golf VII, Variant, Cabrio, AllTrack

| | | | | | | | | | | |
|-------------------|-----|---------|-------|---|---|---|----|------------------|--|------------------|
| 1.0 TSI | 85 | 05/15 → | 999 | B | M | 3 | 12 | CHZD | | 84062 NEW |
| 1.2 TSI | 63 | 08/12 → | 1.197 | B | M | 4 | 16 | CJZB, CYVA | | 84062 NEW |
| | 63 | 05/14 → | 1.197 | B | M | 4 | 16 | CYVA | | 84062 NEW |
| | 77 | 11/12 → | 1.197 | B | M | 4 | 16 | CJZA | | 84062 NEW |
| | 81 | 04/14 → | 1.197 | B | M | 4 | 16 | CYVB | | 84062 NEW |
| 1.4 GTE Hybrid | 110 | 05/14 → | 1.395 | | M | 4 | 16 | CUKB | | 84062 NEW |
| 1.4 TGI CNG | 81 | 06/13 → | 1.395 | | M | 4 | 16 | CPWA, CZBA | | 84062 NEW |
| 1.4 TSI | 90 | 11/12 → | 1.395 | B | M | 4 | 16 | CMBA, CPVA, CXSA | | 84062 NEW |
| | 90 | 05/13 → | 1.395 | B | M | 4 | 16 | CPVA, CXSA | | 84062 NEW |
| | 92 | 04/14 → | 1.395 | B | M | 4 | 16 | CPVB, CZCA | | 84062 NEW |
| | 103 | 05/13 → | 1.395 | B | M | 4 | 16 | CHPA | | 84062 NEW |
| | 103 | 11/12 → | 1.395 | B | M | 4 | 16 | CHPA, CPTA | | 84062 NEW |
| | 110 | 05/14 → | 1.395 | B | M | 4 | 16 | CHPB, CZDA | | 84062 NEW |
| | 110 | 05/14 → | 1.395 | B | M | 4 | 16 | CHPB, CZDA, CZEA | | 84062 NEW |
| | 110 | 02/14 → | 1.395 | B | M | 4 | 16 | CZDA | | 84062 NEW |
| 1.4 TSI MultiFuel | 90 | 04/13 → | 1.395 | | M | 4 | 16 | CPVA | | 84062 NEW |
| | 92 | 04/14 → | 1.395 | | M | 4 | 16 | CPVB | | 84062 NEW |
| 1.6 | 81 | 05/14 → | 1.598 | B | M | 4 | 16 | CWVA | | 84062 NEW |
| 1.8 TSI 4motion | 132 | 12/14 → | 1.798 | B | M | 4 | 16 | CJSB | | 84037 NEW |
| 2.0 GTI | 155 | 11/13 → | 1.984 | B | M | 4 | 16 | CNTA, CXCA | | 84037 NEW |
| | 162 | 04/13 → | 1.984 | B | M | 4 | 16 | CHHB, CXDA | | 84037 NEW |
| | 169 | 04/13 → | 1.984 | B | M | 4 | 16 | CHHA | | 84037 NEW |
| | 195 | 02/16 → | 1.984 | B | M | 4 | 16 | CJXE | | 84037 NEW |
| 2.0 R 4motion | 206 | 11/13 → | 1.984 | B | M | 4 | 16 | CJXB | | 84037 NEW |
| | 221 | 11/13 → | 1.984 | B | M | 4 | 16 | CJXC | | 84037 NEW |

Jetta II

| | | | | | | | | | | |
|----------|----|---------------|-------|---|---|---|---|-------------|--------|-------|
| 1.3 Cat. | 40 | 06/87 → 12/91 | 1.272 | B | M | 4 | 8 | 2G, MH, NZ | | 81520 |
| 1.6 | 51 | 10/86 → 10/91 | 1.595 | B | M | 4 | 8 | PN | (-)COP | 81522 |
| | 51 | 10/86 → 10/91 | 1.595 | B | M | 4 | 8 | PN | (+)COP | 82080 |
| | 53 | 03/86 → 10/91 | 1.595 | B | M | 4 | 8 | RF | (-)COP | 81522 |
| | 53 | 03/86 → 10/91 | 1.595 | B | M | 4 | 8 | RF | (+)COP | 82080 |
| | 55 | 01/84 → 07/92 | 1.595 | B | M | 4 | 8 | ABN, EZ, HM | (-)COP | 81522 |
| | 55 | 01/84 → 07/92 | 1.595 | B | M | 4 | 8 | ABN, EZ, HM | (+)COP | 82080 |
| 1.6 D | 40 | 01/84 → 10/91 | 1.588 | D | M | 4 | 8 | JP, ME | (-)COP | 81522 |
| | 40 | 01/84 → 10/91 | 1.588 | D | M | 4 | 8 | JP, ME | (+)COP | 82080 |

KW

cm³

NO. OF VALVES

VOLKSWAGEN
Jetta II

| | | | | | | | | | | |
|------------|----|---------------|-------|---|---|---|----|------------|--------|-------|
| 1.6 TD | 51 | 01/84 → 10/91 | 1.588 | D | M | 4 | 8 | JR, MF | (-)COP | 81522 |
| | 51 | 01/84 → 10/91 | 1.588 | D | M | 4 | 8 | JR, MF | (+)COP | 82080 |
| | 59 | 04/89 → 10/91 | 1.588 | D | M | 4 | 8 | RA, SB | (-)COP | 81522 |
| | 59 | 04/89 → 10/91 | 1.588 | D | M | 4 | 8 | RA, SB | (+)COP | 82080 |
| | 44 | 01/90 → 10/91 | 1.589 | D | M | 4 | 8 | 1V | (-)COP | 81522 |
| | 44 | 01/90 → 10/91 | 1.589 | D | M | 4 | 8 | 1V | (+)COP | 82080 |
| 1.8 | 62 | 08/86 → 01/90 | 1.781 | B | M | 4 | 8 | RH | (-)COP | 81522 |
| | 62 | 08/86 → 01/90 | 1.781 | B | M | 4 | 8 | RH | (+)COP | 82080 |
| | 66 | 08/84 → 10/91 | 1.781 | B | M | 4 | 8 | GU, GX, HV | (-)COP | 81522 |
| | 66 | 08/84 → 10/91 | 1.781 | B | M | 4 | 8 | GU, GX, HV | (+)COP | 82080 |
| | 82 | 01/84 → 10/91 | 1.781 | B | M | 4 | 8 | EV, GZ, PB | (-)COP | 81522 |
| | 82 | 01/84 → 10/91 | 1.781 | B | M | 4 | 8 | EV, GZ, PB | (+)COP | 82080 |
| 1.8 16V | 95 | 08/86 → 10/91 | 1.781 | B | M | 4 | 16 | PL | (-)COP | 81522 |
| | 95 | 08/86 → 10/91 | 1.781 | B | M | 4 | 16 | PL | (+)COP | 82080 |
| 1.8 Cat. | 66 | 08/87 → 10/91 | 1.781 | B | M | 4 | 8 | GX, RP | (-)COP | 81522 |
| | 66 | 08/87 → 10/91 | 1.781 | B | M | 4 | 8 | GX, RP | (+)COP | 82080 |
| | 79 | 01/87 → 10/91 | 1.781 | B | M | 4 | 8 | PF | (-)COP | 81522 |
| | 79 | 01/87 → 10/91 | 1.781 | B | M | 4 | 8 | PF | (+)COP | 82080 |
| 1.8 Syncro | 72 | 08/88 → 07/91 | 1.781 | B | M | 4 | 8 | 1P | (-)COP | 81522 |
| | 72 | 08/88 → 07/91 | 1.781 | B | M | 4 | 8 | 1P | (+)COP | 82080 |

Jetta III

| | | | | | | | | | | |
|---------------|-----|---------------|-------|---|---|---|----|---------------------------------------|--|------------------|
| 1.4 TSI | 90 | 05/07 → 10/10 | 1.390 | B | M | 4 | 16 | CAXA | | 82097 |
| 1.6 | 75 | 10/05 → 10/10 | 1.595 | B | M | 4 | 8 | BGU, BSE, BSF, CCSA | | 81702 |
| 1.6 FSI | 85 | 09/05 → 10/10 | 1.598 | B | M | 4 | 16 | BLF | | 81865 |
| 1.6 MultiFuel | 75 | 01/08 → 10/10 | 1.595 | | M | 4 | 8 | CCSA | | 81702 |
| 1.6 TDI | 66 | 12/09 → 10/10 | 1.598 | D | M | 4 | 16 | CAYB | | 84001 |
| | 77 | 06/09 → 10/10 | 1.598 | D | M | 4 | 16 | CAYC | | 84001 |
| 1.9 TDI | 77 | 08/05 → 10/10 | 1.896 | D | M | 4 | 8 | BKC, BLS, BXE | | 84010 NEW |
| | 77 | 08/05 → 10/10 | 1.896 | D | M | 4 | 8 | BKC, BLS, BXE | | 81791 |
| 2.0 FSI | 110 | 08/05 → 10/10 | 1.984 | B | M | 4 | 16 | BLR, BLX, BLY, BVY, BVZ | | 81702 |
| 2.0 TDI | 100 | 09/05 → 10/10 | 1.968 | D | M | 4 | 16 | AZV, CBDA | | 81816 |
| | 100 | 09/05 → 10/10 | 1.968 | D | M | 4 | 16 | AZV, CBDA | | 84011 NEW |
| | 103 | 10/05 → 10/10 | 1.968 | D | M | 4 | 8 | BMM | | 81816 |
| | 103 | 10/05 → 10/10 | 1.968 | D | M | 4 | 8 | BMM | | 84011 NEW |
| | 125 | 10/06 → 10/10 | 1.968 | D | M | 4 | 16 | BMN, CEQA | | 81816 |
| | 125 | 10/06 → 10/10 | 1.968 | D | M | 4 | 16 | BMN, CEQA | | 84011 NEW |
| 2.0 TDI 16V | 103 | 08/05 → 10/10 | 1.968 | D | M | 4 | 16 | BKD, CBDB, CBEA, CJAA | | 81816 |
| | 103 | 08/05 → 10/10 | 1.968 | D | M | 4 | 16 | BKD, CBDB, CBEA, CJAA | | 84011 NEW |
| 2.0 TFSI | 147 | 10/05 → 10/10 | 1.984 | B | M | 4 | 16 | AXX, BPY, BWA, CAWB, CBFA, CCTA, CCZA | | 82025 |

KW

cm³

NO. OF VALVES

VOLKSWAGEN
Jetta IV

| | | | | | | | | | | | |
|---------|-----|---------|-------|---|---|---|----|------------------------|--|-------|------------|
| 1.2 TSI | 77 | 02/11 → | 1.197 | B | M | 4 | 8 | CBZB | | 84045 | NEW |
| 1.4 TSI | 90 | 05/11 → | 1.390 | B | M | 4 | 16 | CAXA, CMSB | | 82097 | |
| 1.6 TDI | 77 | 02/11 → | 1.598 | D | M | 4 | 16 | CAYC | | 84001 | |
| 2.0 TDI | 81 | 10/10 → | 1.968 | D | M | 4 | 16 | CLCA | | 84001 | |
| | 103 | 02/11 → | 1.968 | D | M | 4 | 16 | CFFB, CFHC, CJAA, CLCB | | 84001 | |
| 2.0 TSI | 147 | 12/10 → | 1.984 | B | M | 4 | 16 | CBFA, CCTA, CCZA | | 84016 | NEW |
| | 155 | 12/12 → | 1.984 | B | M | 4 | 16 | CPLA, CPPA | | 84037 | NEW |

LT I 28-35, 40-55

| | | | | | | | | | | | |
|------------|----|---------------|-------|---|---|---|----|---------|--|-------|--|
| 2.4 | 66 | 12/82 → 07/92 | 2.383 | B | M | 6 | 12 | DL | | 81833 | |
| 2.4 4WD | 66 | 12/82 → 07/92 | 2.383 | B | M | 6 | 12 | DL | | 81833 | |
| 2.4 D | 51 | 08/89 → 06/96 | 2.383 | D | M | 6 | 12 | 1S, ACT | | 81593 | |
| | 55 | 01/79 → 07/92 | 2.383 | D | M | 6 | 12 | CP, DW | | 81593 | |
| 2.4 i | 69 | 08/89 → 06/96 | 2.383 | B | M | 6 | 12 | 1E | | 81833 | |
| 2.4 TD | 68 | 08/89 → 08/92 | 2.383 | D | M | 6 | 12 | 1G | | 81593 | |
| | 70 | 09/92 → 06/96 | 2.383 | D | M | 6 | 12 | ACL | | 81701 | |
| | 75 | 02/86 → 08/92 | 2.383 | D | M | 6 | 12 | DV | | 81593 | |
| 2.4 TD 4WD | 75 | 08/78 → 07/92 | 2.383 | D | M | 6 | 12 | DV | | 81593 | |

LT II 28-35, 28-46

| | | | | | | | | | | | |
|---------|-----|---------------|-------|---|---|---|----|----------|--|-------|--|
| 2.3 | 105 | 05/96 → 07/06 | 2.295 | B | M | 4 | 16 | AGL | | 81774 | |
| 2.5 SDI | 55 | 07/96 → 07/06 | 2.461 | D | M | 5 | 10 | AGX | | 81701 | |
| 2.5 TDI | 61 | 05/01 → 07/06 | 2.461 | D | M | 5 | 10 | BBE | | 81701 | |
| | 66 | 05/99 → 07/06 | 2.461 | D | M | 5 | 10 | APA | | 81701 | |
| | 70 | 05/01 → 07/06 | 2.461 | D | M | 5 | 10 | BBF | | 81701 | |
| | 75 | 05/96 → 08/99 | 2.461 | D | M | 5 | 10 | AHD | | 81701 | |
| | 80 | 05/99 → 07/06 | 2.461 | D | M | 5 | 10 | ANJ, AVR | | 81701 | |

Lupo I

| | | | | | | | | | | | |
|------------|----|---------------|-------|---|---|---|----|-------------------------|--|-------|------------|
| 1.0 | 37 | 10/98 → 05/00 | 997 | B | M | 4 | 8 | AHT | | 81807 | |
| | 37 | 09/98 → 07/05 | 999 | B | M | 4 | 8 | AER, ALD, ALL, ANV, AUC | M: AHT | 81807 | |
| | 37 | 09/98 → 07/05 | 999 | B | M | 4 | 8 | AER, ALD, ALL, ANV, AUC | M: ALD, M: AUD, M: AUC, M: ALD, M: AER, M: AUC, M: ALL, M: AER, M: AUD, M: AUC, M: ANV, M: ALL, M: ALD, M: AER | 81775 | |
| 1.2 TDI 3L | 45 | 07/99 → 07/05 | 1.191 | D | M | 3 | 6 | ANY, AYZ | | 84010 | NEW |
| | 45 | 07/99 → 07/05 | 1.191 | D | M | 3 | 6 | ANY, AYZ | | 81791 | |
| 1.4 | 44 | 10/00 → 07/05 | 1.390 | B | M | 4 | 8 | AUD | | 81775 | |
| 1.4 16V | 55 | 09/98 → 07/05 | 1.390 | B | M | 4 | 16 | AHW, AKQ, APE, AUA, BBY | 11-1998 → | 81777 | |
| | 74 | 08/99 → 07/05 | 1.390 | B | M | 4 | 16 | AFK, AQQ, AUB | | 81777 | |
| 1.4 FSI | 77 | 02/01 → 07/05 | 1.390 | B | M | 4 | 16 | ARR | | 81777 | |



KW



cm³



NO. OF VALVES



VOLKSWAGEN

Lupo I

| | | | | | | | | | | | |
|---------|----|---------------|-------|---|---|---|----|-----|-----------|-------|------------|
| 1.4 TDI | 55 | 01/99 → 07/05 | 1.422 | D | M | 3 | 6 | AMF | | 84010 | NEW |
| | 55 | 01/99 → 07/05 | 1.422 | D | M | 3 | 6 | AMF | | 81791 | |
| 1.6 GTI | 92 | 09/00 → 07/05 | 1.598 | B | M | 4 | 16 | AVY | | 81840 | |
| 1.7 SDI | 44 | 09/98 → 07/05 | 1.716 | D | M | 4 | 8 | AKU | 11-1998 → | 81528 | |

Multivan V

| | | | | | | | | | | | |
|-------------------|-----|---------------|-------|---|---|---|----|------------|--|-------|------------|
| 1.9 TDI | 62 | 01/06 → 11/09 | 1.896 | D | M | 4 | 8 | BRR | | 84010 | NEW |
| | 62 | 01/06 → 11/09 | 1.896 | D | M | 4 | 8 | BRR | | 81791 | |
| | 63 | 04/03 → 11/09 | 1.896 | D | M | 4 | 8 | AXC | | 84010 | NEW |
| | 63 | 04/03 → 11/09 | 1.896 | D | M | 4 | 8 | AXC | | 81791 | |
| | 75 | 06/06 → 11/09 | 1.896 | D | M | 4 | 8 | BRS | | 84010 | NEW |
| | 75 | 06/06 → 11/09 | 1.896 | D | M | 4 | 8 | BRS | | 81791 | |
| | 77 | 04/03 → 11/09 | 1.896 | D | M | 4 | 8 | AXB | | 84010 | NEW |
| | 77 | 04/03 → 11/09 | 1.896 | D | M | 4 | 8 | AXB | | 81791 | |
| 2.0 | 85 | 11/03 → | 1.984 | B | M | 4 | 8 | AXA | | 81703 | |
| 2.0 BiTDI | 132 | 09/09 → | 1.968 | D | M | 4 | 16 | CFCA | | 84001 | |
| 2.0 BiTDI 4motion | 132 | 09/09 → | 1.968 | D | M | 4 | 16 | CFCA | | 84001 | |
| 2.0 TDI | 62 | 09/09 → | 1.968 | D | M | 4 | 16 | CAAA | | 84001 | |
| | 75 | 09/09 → | 1.968 | D | M | 4 | 16 | CAAB | | 84001 | |
| | 84 | 05/11 → | 1.968 | D | M | 4 | 16 | CAAD | | 84001 | |
| | 100 | 05/10 → | 1.968 | D | M | 4 | 16 | CAAE, CCHB | | 84001 | |
| | 103 | 09/09 → | 1.968 | D | M | 4 | 16 | CAAC, CCHA | | 84001 | |
| 2.0 TDI 4motion | 100 | 05/10 → | 1.968 | D | M | 4 | 16 | CAAE, CCHB | | 84001 | |
| | 103 | 09/09 → | 1.968 | D | M | 4 | 16 | CAAC, CCHA | | 84001 | |
| 2.0 TSI | 110 | 07/12 → | 1.984 | B | M | 4 | 16 | CJKB | | 84016 | NEW |
| | 150 | 05/11 → | 1.984 | B | M | 4 | 16 | CJKA | | 84016 | NEW |
| 2.0 TSI 4motion | 150 | 07/11 → | 1.984 | B | M | 4 | 16 | CJKA | | 84016 | NEW |
| 2.5 TDI | 96 | 04/03 → 11/09 | 2.461 | D | M | 5 | 10 | AXD, BNZ | | 82033 | |
| | 120 | 11/03 → 11/09 | 2.461 | D | M | 5 | 10 | BLJ | | 82033 | |
| | 128 | 04/03 → 11/09 | 2.461 | D | M | 5 | 10 | AXE, BPC | | 82033 | |
| 2.5 TDI 4motion | 96 | 07/04 → 11/09 | 2.461 | D | M | 5 | 10 | AXD, BNZ | | 82033 | |
| | 128 | 07/04 → 11/09 | 2.461 | D | M | 5 | 10 | AXE, BPC | | 82033 | |
| 3.2 V6 | 170 | 02/04 → 06/04 | 3.189 | B | M | 6 | 24 | BDL | | 81866 | |
| | 173 | 02/04 → 11/09 | 3.189 | B | M | 6 | 24 | BKK, CFLA | | 81866 | |
| 3.2 V6 4motion | 173 | 07/04 → 11/09 | 3.189 | B | M | 6 | 24 | BKK, CFLA | | 81866 | |

New Beetle, Cabrio

| | | | | | | | | | | | |
|-------|-----|---------------|-------|---|---|---|----|------------------------------|--|-------|--|
| 1.4 | 55 | 11/01 → 09/10 | 1.390 | B | M | 4 | 16 | BCA | | 81777 | |
| 1.6 | 74 | 10/99 → 09/00 | 1.595 | B | M | 4 | 8 | AWH | | 81702 | |
| | 75 | 06/00 → 09/10 | 1.595 | B | M | 4 | 8 | AYD, BFS | | 81702 | |
| | 75 | 01/03 → 09/10 | 1.595 | B | M | 4 | 8 | BFS | | 81702 | |
| 1.8 T | 110 | 10/99 → 09/10 | 1.781 | B | M | 4 | 20 | AGU, APH, AVC, AWU, AWW, BKF | | 81703 | |
| | 110 | 01/03 → 09/10 | 1.781 | B | M | 4 | 20 | AWU, AWW, BKF | | 81703 | |
| | 132 | 11/01 → 06/05 | 1.781 | B | M | 4 | 20 | AWP, BNU | | 81703 | |

KW

cm³

NO. OF VALVES

VOLKSWAGEN
New Beetle, Cabrio

| | | | | | | | | | | | |
|-----------------|-----|---------------|-------|---|---|---|----|--|--|-------|------------|
| 1.9 TDI | 66 | 01/98 → 06/04 | 1.896 | D | M | 4 | 8 | ALH | | 81706 | |
| | 74 | 02/01 → 09/10 | 1.896 | D | M | 4 | 8 | ATD, BEW | | 84010 | NEW |
| | 74 | 02/01 → 09/10 | 1.896 | D | M | 4 | 8 | ATD, BEW | | 81791 | |
| | 74 | 06/03 → 09/10 | 1.896 | D | M | 4 | 8 | AXR | | 81816 | |
| | 74 | 06/03 → 09/10 | 1.896 | D | M | 4 | 8 | AXR | | 84011 | NEW |
| | 77 | 07/05 → 09/10 | 1.896 | D | M | 4 | 8 | BSW | | 84010 | NEW |
| | 77 | 07/05 → 09/10 | 1.896 | D | M | 4 | 8 | BSW | | 81791 | |
| | 77 | 07/05 → 09/10 | 1.896 | D | M | 4 | 8 | BSW | | 81816 | |
| | 77 | 07/05 → 09/10 | 1.896 | D | M | 4 | 8 | BSW | | 84011 | NEW |
| 2.0 | 85 | 01/98 → 09/10 | 1.984 | B | M | 4 | 8 | AEG, APK, AQY, AVH, AZG, AZJ, BEJ, BER, BEV, BHP, CBPA | | 81703 | |
| | 85 | 09/02 → 10/10 | 1.984 | B | A | 4 | 8 | AQY, AZJ, BDC, BEV, BGD | | 81703 | |
| 2.3 V5 | 125 | 10/00 → 09/10 | 2.324 | B | M | 5 | 20 | AQN | | 81856 | |
| RSI 3.2 4motion | 165 | 04/00 → 05/01 | 3.188 | B | M | 6 | 24 | AXJ | | 81866 | |

Passat III, Variant

| | | | | | | | | | | | |
|----------------|-----|---------------|-------|---|---|---|----|--------------|--------|-------|--|
| 1.6 | 53 | 02/88 → 09/91 | 1.595 | B | M | 4 | 8 | 1F, EZ | (-)COP | 81522 | |
| | 53 | 02/88 → 09/91 | 1.595 | B | M | 4 | 8 | 1F, EZ | (+)COP | 82080 | |
| | 74 | 10/94 → 08/96 | 1.595 | B | M | 4 | 8 | AEK, AFT | (-)COP | 81522 | |
| | 74 | 10/94 → 08/96 | 1.595 | B | M | 4 | 8 | AEK, AFT | (+)COP | 82080 | |
| 1.6 TD | 59 | 08/88 → 09/93 | 1.588 | D | M | 4 | 8 | RA, SB | (-)COP | 81522 | |
| | 59 | 08/88 → 09/93 | 1.588 | D | M | 4 | 8 | RA, SB | (+)COP | 82080 | |
| 1.8 | 55 | 08/90 → 08/96 | 1.781 | B | M | 4 | 8 | AAM | (-)COP | 81522 | |
| | 55 | 08/90 → 08/96 | 1.781 | B | M | 4 | 8 | AAM | (+)COP | 82080 | |
| | 66 | 02/88 → 08/96 | 1.781 | B | M | 4 | 8 | ABS, ADZ, RP | (-)COP | 81522 | |
| | 66 | 02/88 → 08/96 | 1.781 | B | M | 4 | 8 | ABS, ADZ, RP | (+)COP | 82080 | |
| | 79 | 04/88 → 07/93 | 1.781 | B | M | 4 | 8 | PF | (-)COP | 81522 | |
| | 79 | 04/88 → 07/93 | 1.781 | B | M | 4 | 8 | PF | (+)COP | 82080 | |
| | 82 | 04/88 → 07/92 | 1.781 | B | M | 4 | 8 | PB | (-)COP | 81522 | |
| | 82 | 04/88 → 07/92 | 1.781 | B | M | 4 | 8 | PB | (+)COP | 82080 | |
| | 102 | 08/91 → 09/93 | 1.781 | B | M | 4 | 16 | KR | (-)COP | 81522 | |
| | 102 | 08/91 → 09/93 | 1.781 | B | M | 4 | 16 | KR | (+)COP | 82080 | |
| 1.8 G60 Syncro | 118 | 08/88 → 08/96 | 1.781 | B | M | 4 | 8 | PG | (-)COP | 81522 | |
| | 118 | 08/88 → 08/96 | 1.781 | B | M | 4 | 8 | PG | (+)COP | 82080 | |
| 1.8 GL | 102 | 08/91 → 09/93 | 1.781 | B | M | 4 | 16 | KR | (-)COP | 81522 | |
| | 102 | 08/91 → 09/93 | 1.781 | B | M | 4 | 16 | KR | (+)COP | 82080 | |
| 1.9 D | 50 | 05/89 → 10/93 | 1.896 | D | M | 4 | 8 | 1Y | (-)COP | 81522 | |
| | 50 | 05/89 → 10/93 | 1.896 | D | M | 4 | 8 | 1Y | (+)COP | 82080 | |
| 1.9 TD | 55 | 03/91 → 08/96 | 1.896 | D | M | 4 | 8 | AAZ | (-)COP | 81522 | |
| | 55 | 03/91 → 08/96 | 1.896 | D | M | 4 | 8 | AAZ | (+)COP | 82080 | |

| | | | | | | | | | | |
|--|--|----|--|-----------------|--|--|--|---------------|--|--|
| | | KW | | cm ³ | | | | NO. OF VALVES | | |
|--|--|----|--|-----------------|--|--|--|---------------|--|--|

VOLKSWAGEN

Passat III, Variant

| | | | | | | | | | | |
|----------------|-----|---------------|-------|---|---|---|----|-------------------|--------|-------|
| 1.9 TDI | 66 | 10/93 → 08/96 | 1.896 | D | M | 4 | 8 | 1Z, AHU | (-)COP | 81522 |
| | 66 | 10/93 → 08/96 | 1.896 | D | M | 4 | 8 | 1Z, AHU | (+)COP | 82080 |
| | 81 | 03/96 → 08/96 | 1.896 | D | M | 4 | 8 | AFN | (-)COP | 81522 |
| | 81 | 03/96 → 08/96 | 1.896 | D | M | 4 | 8 | AFN | (+)COP | 82080 |
| 2.0 | 79 | 03/95 → 08/96 | 1.984 | B | M | 4 | 8 | AEP | (-)COP | 81522 |
| | 79 | 03/95 → 08/96 | 1.984 | B | M | 4 | 8 | AEP | (+)COP | 82080 |
| | 85 | 02/90 → 10/96 | 1.984 | B | M | 4 | 8 | 2E, ABA, ADY, AGG | (-)COP | 81522 |
| | 85 | 02/90 → 10/96 | 1.984 | B | M | 4 | 8 | 2E, ABA, ADY, AGG | (+)COP | 82080 |
| | 85 | 02/90 → 05/97 | 1.984 | B | M | 4 | 8 | 2E, ADY, AGG | (-)COP | 81522 |
| | 85 | 02/90 → 05/97 | 1.984 | B | M | 4 | 8 | 2E, ADY, AGG | (+)COP | 82080 |
| | 125 | 04/88 → 07/91 | 1.984 | B | M | 4 | 8 | | (-)COP | 81522 |
| | 125 | 04/88 → 07/91 | 1.984 | B | M | 4 | 8 | | (+)COP | 82080 |
| 2.0 16V | 100 | 08/88 → 09/93 | 1.984 | B | M | 4 | 16 | 9A | (-)COP | 81522 |
| | 100 | 08/88 → 09/93 | 1.984 | B | M | 4 | 16 | 9A | (+)COP | 82080 |
| | 110 | 01/94 → 08/96 | 1.984 | B | M | 4 | 16 | ABF | (-)COP | 81522 |
| | 110 | 01/94 → 08/96 | 1.984 | B | M | 4 | 16 | ABF | (+)COP | 82080 |
| 2.0 Syncro | 81 | 09/89 → 07/92 | 1.984 | B | M | 4 | 8 | | (-)COP | 81522 |
| | 81 | 09/89 → 07/92 | 1.984 | B | M | 4 | 8 | | (+)COP | 82080 |
| | 85 | 10/90 → 08/96 | 1.984 | B | M | 4 | 8 | 2E, ADY, AGG | (-)COP | 81522 |
| | 85 | 10/90 → 08/96 | 1.984 | B | M | 4 | 8 | 2E, ADY, AGG | (+)COP | 82080 |
| 2.8 VR6 | 128 | 06/91 → 08/96 | 2.792 | B | M | 6 | 12 | AAA | | 81773 |
| 2.9 VR6 Syncro | 135 | 01/94 → 05/97 | 2.861 | B | M | 6 | 12 | ABV | | 81773 |

Passat IV, Variant

| | | | | | | | | | | |
|--------------------|-----|---------------|-------|---|---|---|----|--------------------|---|-------|
| 1.6 | 74 | 10/96 → 11/00 | 1.595 | B | M | 4 | 8 | ADP, AHL, ANA, ARM | (-)COP, → 12-1997, M: ADP | 81526 |
| | 74 | 10/96 → 11/00 | 1.595 | B | M | 4 | 8 | ADP, AHL, ANA, ARM | (+)COP, → 12-1997, M: ADP | 81529 |
| | 74 | 10/96 → 11/00 | 1.595 | B | M | 4 | 8 | ADP, AHL, ANA, ARM | 01-1998 →, M: ARM, M: ANA, M: ARM, M: AHL, M: ANA | 81702 |
| | 74 | 06/97 → 11/00 | 1.595 | B | M | 4 | 8 | ADP, AHL, ANA, ARM | 01-1998 →, M: AHL, M: ANA, M: AHL, M: ARM, M: ANA | 81702 |
| 1.8 | 85 | 01/97 → 11/00 | 1.781 | B | M | 4 | 20 | AFY | (-)COP | 81526 |
| | 85 | 01/97 → 11/00 | 1.781 | B | M | 4 | 20 | AFY | (+)COP | 81529 |
| | 92 | 10/96 → 11/00 | 1.781 | B | M | 4 | 20 | ADR, APT, ARG | (-)COP | 81526 |
| | 92 | 10/96 → 11/00 | 1.781 | B | M | 4 | 20 | ADR, APT, ARG | (+)COP | 81529 |
| 1.8 Syncro/4motion | 92 | 10/96 → 11/00 | 1.781 | B | M | 4 | 20 | ADR, APT, ARG | (-)COP | 81526 |
| | 92 | 10/96 → 11/00 | 1.781 | B | M | 4 | 20 | ADR, APT, ARG | (+)COP | 81529 |
| 1.8 T | 110 | 10/96 → 11/00 | 1.781 | B | M | 4 | 20 | AEB, ANB, APU | (-)COP, M: ANB, M: AEB, M: ANB | 81526 |
| | 110 | 10/96 → 11/00 | 1.781 | B | M | 4 | 20 | AEB, ANB, APU | (+)COP, M: ANB, M: AEB, M: ANB | 81529 |
| | 110 | 10/96 → 11/00 | 1.781 | B | M | 4 | 20 | AEB, ANB, APU | M: APU | 81702 |

KW

cm³

NO. OF VALVES

VOLKSWAGEN
Passat IV, Variant

| | | | | | | | | | | |
|------------------------|-----|---------------|-------|---|---|---|----|-------------------------|--------|------------------|
| 1.8 T Syncro | 110 | 11/96 → 08/00 | 1.781 | B | M | 4 | 20 | AEB | (-)COP | 81526 |
| | 110 | 11/96 → 08/00 | 1.781 | B | M | 4 | 20 | AEB | (+)COP | 81529 |
| 1.9 TDI | 66 | 10/96 → 11/00 | 1.896 | D | M | 4 | 8 | AHH, AHU | | 81528 |
| | 74 | 02/00 → 11/00 | 1.896 | D | M | 4 | 8 | AVB | | 81816 |
| | 74 | 02/00 → 11/00 | 1.896 | D | M | 4 | 8 | AVB | | 84011 NEW |
| | 81 | 10/96 → 11/00 | 1.896 | D | M | 4 | 8 | AFN, AVG | | 81528 |
| | 85 | 08/98 → 11/00 | 1.896 | D | M | 4 | 8 | AJM, ATJ | | 81816 |
| | 85 | 08/98 → 11/00 | 1.896 | D | M | 4 | 8 | AJM, ATJ | | 84011 NEW |
| 1.9 TDI 4motion | 85 | 08/99 → 11/00 | 1.896 | D | M | 4 | 8 | ATJ | | 81816 |
| | 85 | 08/99 → 11/00 | 1.896 | D | M | 4 | 8 | ATJ | | 84011 NEW |
| 1.9 TDI Syncro/4motion | 81 | 10/96 → 11/00 | 1.896 | D | M | 4 | 8 | AFN, AVG | | 81528 |
| 2.0 | 88 | 04/00 → 11/00 | 1.984 | B | M | 4 | 8 | ASU, AUZ | | 81703 |
| 2.0 4motion | 88 | 04/00 → 11/00 | 1.984 | B | M | 4 | 8 | ASU | | 81703 |
| | 88 | 04/00 → 11/00 | 1.984 | B | M | 4 | 8 | ASU, AUZ | | 81703 |
| 2.3 VR5 | 110 | 10/96 → 11/00 | 2.324 | B | M | 5 | 10 | AGZ | | 81856 |
| 2.3 VR5 Syncro/4motion | 110 | 10/97 → 11/00 | 2.324 | B | M | 5 | 10 | AGZ | | 81856 |
| 2.5 TDI | 110 | 07/98 → 11/00 | 2.496 | D | M | 6 | 24 | AFB, AKN | | 81705 |
| 2.5 TDI Syncro/4motion | 110 | 12/98 → 11/00 | 2.496 | D | M | 6 | 24 | AFB, AKN | | 81705 |
| 2.8 Syncro | 132 | 05/97 → 09/99 | 2.771 | B | M | 6 | 30 | AGE | | 81842 |
| 2.8 V6 | 132 | 05/97 → 09/99 | 2.771 | B | M | 6 | 30 | AGE | | 81842 |
| | 140 | 09/99 → 11/00 | 2.771 | B | M | 6 | 30 | ATX, BBG | | 81842 |
| | 142 | 08/96 → 11/00 | 2.771 | B | M | 6 | 30 | ACK, AHA, APR, AQD | | 81842 |
| 2.8 V6 Syncro/4motion | 142 | 10/96 → 11/00 | 2.771 | B | M | 6 | 30 | ACK, AHA, ALG, APR, AQD | | 81842 |

Passat V, Variant

| | | | | | | | | | | |
|---------------|-----|---------------|-------|---|----|---|----|----------|--------|------------------|
| 1.6 | 75 | 11/00 → 05/05 | 1.595 | B | AM | 4 | 8 | ALZ | | 81702 |
| 1.8 | 92 | 03/03 → 03/05 | 1.781 | B | M | 4 | 20 | APT | (-)COP | 81526 |
| | 92 | 03/03 → 03/05 | 1.781 | B | M | 4 | 20 | APT | (+)COP | 81529 |
| 1.8 T | 125 | 02/01 → 05/05 | 1.781 | B | M | 4 | 20 | AWM | | 81703 |
| 1.8 T 20V | 110 | 11/00 → 05/05 | 1.781 | B | M | 4 | 20 | AWL, AWT | | 81703 |
| | 110 | 11/00 → 05/05 | 1.781 | B | M | 4 | 20 | AWT | | 81703 |
| 1.8 T 4motion | 125 | 03/01 → 05/05 | 1.781 | B | M | 4 | 20 | AWM | | 81703 |
| 1.9 TDI | 74 | 11/00 → 05/05 | 1.896 | D | M | 4 | 8 | AVB | | 81816 |
| | 74 | 11/00 → 05/05 | 1.896 | D | M | 4 | 8 | AVB | | 84011 NEW |
| | 96 | 11/00 → 05/05 | 1.896 | D | AM | 4 | 8 | AVF, AWX | | 81816 |
| | 96 | 11/00 → 05/05 | 1.896 | D | AM | 4 | 8 | AVF, AWX | | 84011 NEW |
| | 96 | 11/00 → 05/05 | 1.896 | D | M | 4 | 8 | AVF, AWX | | 81816 |
| | 96 | 11/00 → 05/05 | 1.896 | D | M | 4 | 8 | AVF, AWX | | 84011 NEW |



KW



cm³



NO. OF VALVES



VOLKSWAGEN

Passat V, Variant

| | | | | | | | | | | |
|-----------------|-----|---------------|-------|---|----|---|----|----------|--|------------------|
| 1.9 TDI 4motion | 96 | 11/00 → 05/05 | 1.896 | D | AM | 4 | 8 | AVF | | 81816 |
| | 96 | 11/00 → 05/05 | 1.896 | D | AM | 4 | 8 | AVF | | 84011 NEW |
| | 96 | 11/00 → 05/05 | 1.896 | D | M | 4 | 8 | AVF | | 81816 |
| | 96 | 11/00 → 05/05 | 1.896 | D | M | 4 | 8 | AVF | | 84011 NEW |
| 2.0 | 85 | 11/00 → 05/05 | 1.984 | B | M | 4 | 8 | AZM | | 81703 |
| | 85 | 11/00 → 05/05 | 1.984 | B | M | 4 | 8 | AZM, BFF | | 81703 |
| | 96 | 11/01 → 05/05 | 1.984 | B | M | 4 | 20 | ALT | | 81702 |
| 2.0 4motion | 85 | 11/00 → 05/05 | 1.984 | B | M | 4 | 8 | AZM | | 81703 |
| 2.0 TDI | 100 | 12/03 → 05/05 | 1.968 | D | M | 4 | 8 | BGW, BHW | | 81816 |
| | 100 | 12/03 → 05/05 | 1.968 | D | M | 4 | 8 | BGW, BHW | | 84011 NEW |
| 2.3 V5 | 125 | 11/00 → 05/05 | 2.324 | B | M | 5 | 20 | AZX | | 81856 |
| 2.3 V5 4motion | 125 | 11/00 → 05/05 | 2.324 | B | M | 5 | 20 | AZX | | 81856 |
| 2.3 VR5 | 125 | 11/00 → 05/05 | 2.324 | B | M | 5 | 20 | AZX | | 81856 |
| 2.3 VR5 4motion | 125 | 11/00 → 05/05 | 2.324 | B | M | 5 | 20 | AZX | | 81856 |
| 2.5 TDI | 110 | 11/00 → 05/05 | 2.496 | D | M | 6 | 24 | AFB, AKN | | 81705 |
| | 120 | 05/03 → 05/05 | 2.496 | D | M | 6 | 24 | BDG | | 81705 |
| 2.5 TDI 4motion | 110 | 11/00 → 05/05 | 2.496 | D | M | 6 | 24 | AFB, AKN | | 81705 |
| | 132 | 01/03 → 05/05 | 2.496 | D | M | 6 | 24 | BAU, BDH | | 81705 |
| 2.8 4motion | 142 | 11/00 → 05/05 | 2.771 | B | M | 6 | 30 | AMX, ATQ | | 81842 |

Passat VI, Variant, CC

| | | | | | | | | | | |
|-----------------|-----|---------------|-------|---|---|---|----|---------------------------------------|--|------------------|
| 1.4 TSI | 90 | 05/07 → 07/10 | 1.390 | B | M | 4 | 16 | CAXA | | 82097 |
| 1.6 | 75 | 05/05 → 07/10 | 1.595 | B | M | 4 | 8 | BSE, BSF | | 81702 |
| 1.6 FSI | 85 | 03/05 → 06/08 | 1.598 | B | M | 4 | 16 | BLF | | 81865 |
| 1.6 TDI | 77 | 08/09 → 07/10 | 1.598 | D | M | 4 | 16 | CAYC | | 84001 |
| 1.8 TSI | 112 | 11/09 → 07/10 | 1.798 | B | M | 4 | 16 | CDAB, CGYA | | 84016 NEW |
| | 118 | 05/07 → 07/10 | 1.798 | B | M | 4 | 16 | BZB, CDA | | 84016 NEW |
| 1.9 TDI | 77 | 03/05 → 11/08 | 1.896 | D | M | 4 | 8 | BKC, BLS, BXE | | 84010 NEW |
| | 77 | 03/05 → 11/08 | 1.896 | D | M | 4 | 8 | BKC, BLS, BXE | | 81791 |
| 2.0 BlueTDI | 105 | 01/09 → 11/10 | 1.968 | D | M | 4 | 16 | CBAC | | 81816 |
| | 105 | 01/09 → 11/10 | 1.968 | D | M | 4 | 16 | CBAC | | 84011 NEW |
| 2.0 FSI | 110 | 03/05 → 07/10 | 1.984 | B | M | 4 | 16 | BLR, BLY, BVY, BVZ | | 81702 |
| | 125 | 08/07 → 07/10 | 1.984 | B | M | 4 | 16 | CCTB | | 84016 NEW |
| | 147 | 07/05 → 07/10 | 1.984 | B | M | 4 | 16 | AXX, BPY, BWA, CAWB, CBFA, CCTA, CCZA | | 82025 |
| 2.0 FSI 4motion | 110 | 09/05 → 07/10 | 1.984 | B | M | 4 | 16 | BLX, BLY, BVX | | 81702 |

KW

cm³

NO. OF VALVES

VOLKSWAGEN
Passat VI, Variant, CC

| | | | | | | | | | | | |
|---------------------|---------------|---------------|-------|---|---|----|------------------|------------------------|-------|------------|------------|
| 2.0 TDI | 81 | 11/08 → 07/10 | 1.968 | D | M | 4 | 16 | CBDC | | 81816 | |
| | 81 | 11/08 → 07/10 | 1.968 | D | M | 4 | 16 | CBDC | | 84011 | NEW |
| | 88 | 11/05 → 05/07 | 1.968 | D | M | 4 | 16 | BWV | | 81816 | |
| | 88 | 11/05 → 05/07 | 1.968 | D | M | 4 | 16 | BWV | | 84011 | NEW |
| | 90 | 08/05 → 07/06 | 1.968 | D | M | 4 | 16 | BVE | | 81816 | |
| | 90 | 08/05 → 07/06 | 1.968 | D | M | 4 | 16 | BVE | | 84011 | NEW |
| | 100 | 03/05 → 11/10 | 1.968 | D | M | 4 | 16 | BMA, CBAA | | 81816 | |
| | 100 | 03/05 → 11/10 | 1.968 | D | M | 4 | 16 | BMA, CBAA | | 84011 | NEW |
| | 100 | 06/08 → 05/11 | 1.968 | D | M | 4 | 16 | CBAA, CFFA | | 81816 | |
| | 100 | 06/08 → 05/11 | 1.968 | D | M | 4 | 16 | CBAA, CFFA | | 84011 | NEW |
| | 103 | 03/05 → 05/09 | 1.968 | D | M | 4 | 8 | BMP | | 81816 | |
| | 103 | 03/05 → 05/09 | 1.968 | D | M | 4 | 8 | BMP | | 84011 | NEW |
| | 103 | 06/08 → 01/12 | 1.968 | D | M | 4 | 16 | CBAB, CFFB | | 81816 | |
| | 103 | 06/08 → 01/12 | 1.968 | D | M | 4 | 16 | CBAB, CFFB | | 84011 | NEW |
| | 120 | 08/05 → 05/09 | 1.968 | D | M | 4 | 16 | BUZ | | 81816 | |
| | 120 | 08/05 → 05/09 | 1.968 | D | M | 4 | 16 | BUZ | | 84011 | NEW |
| | 120 | 05/08 → 05/11 | 1.968 | D | M | 4 | 16 | CBBA | | 84001 | |
| | 125 | 08/05 → 07/10 | 1.968 | D | M | 4 | 16 | BMR, CBBB | | 81816 | |
| | 125 | 08/05 → 07/10 | 1.968 | D | M | 4 | 16 | BMR, CBBB | | 84011 | NEW |
| | 125 | 06/08 → 01/12 | 1.968 | D | M | 4 | 16 | CBBB, CFGB, CLLA | | 81816 | |
| 125 | 06/08 → 01/12 | 1.968 | D | M | 4 | 16 | CBBB, CFGB, CLLA | | 84011 | NEW | |
| 2.0 TDI 16V | 103 | 03/05 → 07/10 | 1.968 | D | M | 4 | 16 | BKP, CBAB | | 81816 | |
| | 103 | 03/05 → 07/10 | 1.968 | D | M | 4 | 16 | BKP, CBAB | | 84011 | NEW |
| 2.0 TDI 16V 4motion | 103 | 03/05 → 08/10 | 1.968 | D | M | 4 | 16 | BKP, CBAB | | 81816 | |
| | 103 | 03/05 → 08/10 | 1.968 | D | M | 4 | 16 | BKP, CBAB | | 84011 | NEW |
| 2.0 TDI 4motion | 103 | 03/05 → 05/09 | 1.968 | D | M | 4 | 8 | BMP | | 81816 | |
| | 103 | 03/05 → 05/09 | 1.968 | D | M | 4 | 8 | BMP | | 84011 | NEW |
| | 103 | 08/09 → 01/12 | 1.968 | D | M | 4 | 16 | CBAB, CFFB | | 81816 | |
| | 103 | 08/09 → 01/12 | 1.968 | D | M | 4 | 16 | CBAB, CFFB | | 84011 | NEW |
| | 125 | 05/09 → 07/10 | 1.968 | D | M | 4 | 16 | CBBB | | 81816 | |
| | 125 | 05/09 → 07/10 | 1.968 | D | M | 4 | 16 | CBBB | | 84011 | NEW |
| | 125 | 11/09 → 01/12 | 1.968 | D | M | 4 | 16 | CBBB, CFGB | | 81816 | |
| | 125 | 11/09 → 01/12 | 1.968 | D | M | 4 | 16 | CBBB, CFGB | | 84011 | NEW |
| | 147 | 06/08 → 01/12 | 1.984 | B | M | 4 | 16 | CAWB, CBFA, CCTA, CCZA | | 82025 | |
| | 155 | 11/10 → 01/12 | 1.984 | B | M | 4 | 16 | CCZB | | 84016 | NEW |
| 3.2 FSI 4motion | 184 | 11/05 → 07/10 | 3.168 | B | M | 6 | 24 | AXZ | | 81866 | |
| 3.6 FSI 4motion | 206 | 06/08 → 01/12 | 3.597 | B | M | 6 | 24 | BLV, CNNA | | 81866 | |
| | 220 | 06/08 → 05/10 | 3.597 | B | M | 6 | 24 | BWS | | 81866 | |
| 3.6 R36 4motion | 220 | 04/07 → 07/10 | 3.597 | B | M | 6 | 24 | BWS | | 81866 | |

KW

cm³

NO. OF VALVES

VOLKSWAGEN
Passat VII, Variant, CC, AllTrack

| | | | | | | | | | | |
|-----------------|-----|---------------|-------|---|---|---|----|------------|-----------|------------------|
| 1.4 TSI | 90 | 08/10 → 12/14 | 1.390 | B | M | 4 | 16 | CAXA | → 01-2009 | 81821 |
| | 90 | 08/10 → 12/14 | 1.390 | B | M | 4 | 16 | CAXA | | 82097 |
| 1.6 TDI | 77 | 08/10 → 12/14 | 1.598 | D | M | 4 | 16 | CAYC | | 84001 |
| 1.8 TSI | 112 | 02/11 → 12/14 | 1.798 | B | M | 4 | 16 | CDAB | | 84016 NEW |
| | 118 | 08/10 → 12/14 | 1.798 | B | M | 4 | 16 | CDAA | | 84016 NEW |
| 2.0 TDI | 100 | 08/10 → 12/14 | 1.968 | D | M | 4 | 16 | CFFA | | 84001 |
| | 103 | 08/10 → 12/14 | 1.968 | D | M | 4 | 16 | CFFB | | 84001 |
| | 125 | 08/10 → 12/14 | 1.968 | D | M | 4 | 16 | CFGB, CLLA | | 84001 |
| | 130 | 12/12 → 12/14 | 1.968 | D | M | 4 | 16 | CFGC | | 84001 |
| 2.0 TDI 4motion | 103 | 08/10 → 12/14 | 1.968 | D | M | 4 | 16 | CFFB | | 84001 |
| | 125 | 01/12 → 12/14 | 1.968 | D | M | 4 | 16 | CFGB | | 84001 |
| | 125 | 08/10 → 01/13 | 1.968 | D | M | 4 | 16 | CFGB, CLLA | | 84001 |
| | 130 | 01/13 → 12/14 | 1.968 | D | M | 4 | 16 | CFGC | | 84001 |
| 2.0 TSI | 155 | 11/10 → 12/14 | 1.984 | B | M | 4 | 16 | CCZB | | 84016 NEW |
| 2.0 TSI 4motion | 155 | 01/12 → 12/14 | 1.984 | B | M | 4 | 16 | CCZB | | 84016 NEW |
| 3.6 FSI 4motion | 220 | 01/11 → 12/14 | 3.597 | B | M | 6 | 24 | BWS | | 81866 |

Passat VIII, Variant, AllTrack

| | | | | | | | | | | |
|-----------------|-----|---------|-------|---|---|---|----|------------|--|------------------|
| 1.4 GTE Hybrid | 115 | 06/15 → | 1.395 | | M | 4 | 16 | CUKC | | 84062 NEW |
| 1.4 TSI | 92 | 11/14 → | 1.395 | B | M | 4 | 16 | CZCA | | 84062 NEW |
| | 110 | 11/14 → | 1.395 | B | M | 4 | 16 | CZDA, CZEA | | 84062 NEW |
| 1.4 TSI 4motion | 110 | 02/15 → | 1.395 | B | M | 4 | 16 | CZEA | | 84062 NEW |
| 1.8 TSI | 132 | 02/15 → | 1.798 | B | M | 4 | 16 | CJSA, CJSC | | 84037 NEW |
| 2.0 TSI | 162 | 02/15 → | 1.984 | B | M | 4 | 16 | CHHB, CXDA | | 84037 NEW |
| 2.0 TSI 4motion | 162 | 07/15 → | 1.984 | B | M | 4 | 16 | CHHB | | 84037 NEW |

Phaeton

| | | | | | | | | | | |
|--------------------|-----|---------|-------|---|----|---|----|------------|--|-------|
| 3.0 V6 TDI 4motion | 165 | 09/04 → | 2.967 | D | M | 6 | 24 | BMK | | 82015 |
| | 171 | 06/07 → | 2.967 | D | M | 6 | 24 | CARA | | 82015 |
| | 176 | 11/08 → | 2.967 | D | M | 6 | 24 | CARB, CEXA | | 82015 |
| 3.2 V6 | 177 | 04/02 → | 3.189 | B | AM | 6 | 24 | AYT, BKL | | 81866 |
| 3.2 V6 4motion | 177 | 02/04 → | 3.189 | B | AM | 6 | 24 | BKL, BRK | | 81866 |
| 3.6 V6 4motion | 206 | 11/08 → | 3.597 | B | M | 6 | 24 | CHNA, CMVA | | 81866 |
| 4.2 V8 4motion | 246 | 05/03 → | 4.172 | B | M | 8 | 40 | BGH, BGJ | | 82081 |

Polo II, Classic, Coupé, Van

| | | | | | | | | | | |
|----------|----|---------------|-------|---|---|---|---|---------------|----------------------------|-------|
| 1.0 | 33 | 01/85 → 09/94 | 1.043 | B | M | 4 | 8 | AAK, AAU, HZ | → 07-1992, → M: 015.867 | 81520 |
| | 33 | 01/85 → 09/94 | 1.043 | B | M | 4 | 8 | AAK, AAU, HZ | 08-1992 →, M →: 015.868 | 81524 |
| | 33 | 08/92 → 07/94 | 1.043 | B | M | 4 | 8 | AAU | | 81524 |
| | 33 | 08/85 → 01/92 | 1.043 | B | M | 4 | 8 | HZ | | 81520 |
| 1.0 Cat. | 33 | 08/89 → 09/94 | 1.043 | B | M | 4 | 8 | AAK, AAU, ACM | → 07-1992, → M: 015.867 | 81520 |
| | 33 | 08/89 → 09/94 | 1.043 | B | M | 4 | 8 | AAK, AAU, ACM | 08-1992 →, M →: 015.868 | 81524 |

KW

cm³

NO. OF VALVES

VOLKSWAGEN
Polo II, Classic, Coupé, Van

| | | | | | | | | | | |
|----------|----|---------------|-------|---|---|---|---|-----------------|----------------------------|-------|
| 1.3 | 40 | 08/92 → 07/94 | 1.272 | B | M | 4 | 8 | AAV | | 81524 |
| | 57 | 03/91 → 09/94 | 1.272 | B | M | 4 | 8 | 3F | → M: 008.526 | 81520 |
| | 57 | 03/91 → 09/94 | 1.272 | B | M | 4 | 8 | 3F | M →: 008.527 | 81524 |
| 1.3 Cat. | 40 | 07/87 → 09/94 | 1.272 | B | M | 4 | 8 | 2G, AAV, MH, NZ | → M: 200.000 | 81520 |
| | 40 | 07/87 → 09/94 | 1.272 | B | M | 4 | 8 | 2G, AAV, MH, NZ | M →: 200.001 | 81524 |
| | 40 | 07/87 → 09/94 | 1.272 | B | M | 4 | 8 | MH, NZ | → M: 200.000 | 81520 |
| | 40 | 07/87 → 09/94 | 1.272 | B | M | 4 | 8 | MH, NZ | M →: 200.001 | 81524 |
| | 55 | 10/89 → 03/91 | 1.272 | B | M | 4 | 8 | 3F | → M: 008.526 | 81520 |
| | 55 | 10/89 → 03/91 | 1.272 | B | M | 4 | 8 | 3F | M →: 008.527 | 81524 |
| 1.3 D | 33 | 08/86 → 07/90 | 1.272 | D | M | 4 | 8 | MN | | 81525 |
| 1.3 G40 | 83 | 08/90 → 09/94 | 1.272 | B | M | 4 | 8 | PY | → 08-1992, → M: 002.177 | 81520 |
| | 83 | 08/90 → 09/94 | 1.272 | B | M | 4 | 8 | PY | 09-1992 →, M →: 002.178 | 81524 |
| | 85 | 01/87 → 08/90 | 1.272 | B | M | 4 | 8 | PY | | 81520 |
| 1.4 D | 35 | 10/90 → 09/94 | 1.398 | D | M | 4 | 8 | 1W | | 81525 |

Polo III (6N1), Classic, Variant, Van

| | | | | | | | | | | |
|---------|----|---------------|-------|---|---|---|----|------------------------------|--|-------|
| 1.0 | 33 | 10/94 → 12/99 | 1.043 | B | M | 4 | 8 | AEV | | 81524 |
| 1.4 | 40 | 12/98 → 09/01 | 1.390 | B | M | 4 | 8 | AKP | | 81775 |
| | 44 | 05/97 → 09/01 | 1.390 | B | M | 4 | 8 | AEX, AKK, AKV, ANW, APQ, AUD | M: AEX, M: ANX, M: AKV, M: AEX, M: APQ, M: ANX | 81527 |
| | 44 | 05/97 → 09/01 | 1.390 | B | M | 4 | 8 | AEX, AKK, AKV, ANW, APQ, AUD | M: AKK, M: AUD, M: ANW, M: AKK | 81775 |
| | 44 | 05/98 → 12/99 | 1.390 | B | M | 4 | 8 | AEX, APQ | | 81527 |
| 1.4 16V | 55 | 10/99 → 09/01 | 1.390 | B | M | 4 | 16 | APE, AUA | | 81777 |
| 1.6 | 74 | 05/97 → 09/01 | 1.595 | B | M | 4 | 8 | AEH, AFT, AKL, APF, AUR | (-)COP, M: AFT | 81522 |
| | 74 | 05/97 → 09/01 | 1.595 | B | M | 4 | 8 | AEH, AFT, AKL, APF, AUR | (+)COP | 82080 |
| | 74 | 05/97 → 09/01 | 1.595 | B | M | 4 | 8 | AEH, AFT, AKL, APF, AUR | (+)COP, M: AFT | 82080 |
| | 74 | 05/97 → 09/01 | 1.595 | B | M | 4 | 8 | AEH, AFT, AKL, APF, AUR | M: AUR, M: AKL, M: AEH, M: AUR, M: APF, M: AKL | 81702 |
| | 55 | 05/97 → 09/01 | 1.598 | B | M | 4 | 8 | AEE, ALM | | 81527 |
| 1.7 SDI | 42 | 04/97 → 10/99 | 1.716 | D | M | 4 | 8 | AHG | | 81528 |
| | 42 | 08/97 → 09/01 | 1.716 | D | M | 4 | 8 | AKW | (-)COP | 81522 |
| | 42 | 08/97 → 09/01 | 1.716 | D | M | 4 | 8 | AKW | (+)COP | 82080 |
| | 44 | 08/97 → 12/99 | 1.716 | D | M | 4 | 8 | AKU | | 81528 |
| 1.8 | 66 | 05/97 → 09/01 | 1.781 | B | M | 4 | 8 | ADZ | (-)COP | 81522 |
| | 66 | 05/97 → 09/01 | 1.781 | B | M | 4 | 8 | ADZ | (+)COP | 82080 |
| 1.9 D | 47 | 10/94 → 12/99 | 1.896 | D | M | 4 | 8 | AEF | | 81528 |

| | | | | | | | | | | | |
|--|--|----|--|-----------------|--|--|--|---------------|--|--|--|
| | | KW | | cm ³ | | | | NO. OF VALVES | | | |
|--|--|----|--|-----------------|--|--|--|---------------|--|--|--|

VOLKSWAGEN

Polo III (6N1), Classic, Variant, Van

| | | | | | | | | | | |
|-----------------|----|---------------|-------|---|---|---|----|------------------------------|--|-------|
| 1.9 SDI | 47 | 06/97 → 09/01 | 1.896 | D | M | 4 | 8 | AEY | (-)COP | 81522 |
| | 47 | 06/97 → 09/01 | 1.896 | D | M | 4 | 8 | AEY | (+)COP | 82080 |
| | 47 | 07/96 → 12/99 | 1.896 | D | M | 4 | 8 | AGD | | 81528 |
| | 48 | 06/96 → 09/01 | 1.896 | D | M | 4 | 8 | AEY | (+)COP | 82080 |
| | 50 | 08/99 → 09/01 | 1.896 | D | M | 4 | 8 | AGP, AQM | | 81706 |
| 1.9 TDI | 66 | 05/97 → 09/01 | 1.896 | D | M | 4 | 8 | AGR, AHU, ALE, ALH | (-)COP, M: ALE | 81522 |
| | 66 | 05/97 → 09/01 | 1.896 | D | M | 4 | 8 | AGR, AHU, ALE, ALH | (+)COP | 82080 |
| | 66 | 05/97 → 09/01 | 1.896 | D | M | 4 | 8 | AGR, AHU, ALE, ALH | (+)COP, M: ALE | 82080 |
| | 66 | 05/97 → 09/01 | 1.896 | D | M | 4 | 8 | AGR, AHU, ALE, ALH | M: AHU | 81528 |
| | 66 | 05/97 → 09/01 | 1.896 | D | M | 4 | 8 | AGR, AHU, ALE, ALH | M: ALH, M: AGR | 81706 |
| | 81 | 06/98 → 09/01 | 1.896 | D | M | 4 | 8 | AFN, ASV | M: AFN | 81528 |
| | 81 | 06/98 → 09/01 | 1.896 | D | M | 4 | 8 | AFN, ASV | M: ASV | 81706 |
| 100 1.4 16V | 74 | 04/96 → 10/99 | 1.390 | B | M | 4 | 16 | AFH | | 81776 |
| 100 1.6 | 74 | 12/95 → 09/01 | 1.595 | B | M | 4 | 8 | AEH, AFT, AKL, APF, AUR | (-)COP, M: AFT | 81522 |
| | 74 | 12/95 → 09/01 | 1.595 | B | M | 4 | 8 | AEH, AFT, AKL, APF, AUR | (+)COP | 82080 |
| | 74 | 12/95 → 09/01 | 1.595 | B | M | 4 | 8 | AEH, AFT, AKL, APF, AUR | (+)COP, M: AFT | 82080 |
| | 74 | 12/95 → 09/01 | 1.595 | B | M | 4 | 8 | AEH, AFT, AKL, APF, AUR | | 81702 |
| 110 1.9 TDI | 81 | 06/98 → 01/02 | 1.896 | D | M | 4 | 8 | AFN, ASV | (-)COP | 81522 |
| | 81 | 06/98 → 01/02 | 1.896 | D | M | 4 | 8 | AFN, ASV | (+)COP | 82080 |
| 120 1.6 16V GTI | 88 | 09/98 → 10/99 | 1.598 | B | M | 4 | 16 | AJV | | 81840 |
| 45 1.0 | 33 | 10/94 → 09/96 | 1.043 | B | M | 4 | 8 | AEV | | 81527 |
| 50 1.0 | 37 | 09/96 → 10/99 | 999 | B | M | 4 | 8 | AER, ALL | | 81775 |
| 54 1.4 | 40 | 01/98 → 08/99 | 1.390 | B | M | 4 | 8 | ANX | | 81527 |
| 55 1.3 | 40 | 10/94 → 07/95 | 1.296 | B | M | 4 | 8 | ADX | | 81527 |
| 55 1.4 | 40 | 08/95 → 10/99 | 1.390 | B | M | 4 | 8 | AEX | | 81527 |
| 57 1.7 SDI | 42 | 07/97 → 09/01 | 1.716 | D | M | 4 | 8 | AKW | (-)COP | 81522 |
| | 42 | 07/97 → 09/01 | 1.716 | D | M | 4 | 8 | AKW | (+)COP | 82080 |
| 60 1.4 | 44 | 12/95 → 09/01 | 1.390 | B | M | 4 | 8 | AEX, AKK, AKV, ANW, APQ, AUD | M: APQ, M: AKV, M: ANX, M: APQ, M: AEX, M: AKV | 81527 |
| | 44 | 12/95 → 09/01 | 1.390 | B | M | 4 | 8 | AEX, AKK, AKV, ANW, APQ, AUD | M: AUD, M: AKK, M: ANW, M: AUD | 81775 |
| | 44 | 07/95 → 10/99 | 1.390 | B | M | 4 | 8 | AEX, AKV, APQ | | 81527 |
| 60 1.7 SDI | 44 | 08/97 → 10/99 | 1.716 | D | M | 4 | 8 | AKU | | 81528 |
| 64 1.9 D | 47 | 01/96 → 10/96 | 1.896 | D | M | 4 | 8 | 1Y | (-)COP | 81522 |
| | 47 | 01/96 → 10/96 | 1.896 | D | M | 4 | 8 | 1Y | (+)COP | 82080 |
| | 47 | 10/94 → 10/99 | 1.896 | D | M | 4 | 8 | AEF | | 81528 |
| 64 1.9 SDI | 47 | 12/95 → 08/99 | 1.896 | D | M | 4 | 8 | 1Y, AEY | (-)COP | 81522 |
| | 47 | 12/95 → 08/99 | 1.896 | D | M | 4 | 8 | 1Y, AEY | (+)COP | 82080 |
| | 47 | 07/96 → 10/99 | 1.896 | D | M | 4 | 8 | AGD | | 81528 |

KW

cm³

NO. OF VALVES

VOLKSWAGEN
Polo III (6N1), Classic, Variant, Van

| | | | | | | | | | | |
|------------|----|---------------|-------|---|---|---|----|--------------------|----------------|-------|
| 68 1.9 SDI | 50 | 08/99 → 01/02 | 1.896 | D | M | 4 | 8 | AGP, AQM | | 81706 |
| 75 1.4 16V | 55 | 10/99 → 09/01 | 1.390 | B | M | 4 | 16 | APE, AUA | | 81777 |
| 75 1.6 | 55 | 11/95 → 09/97 | 1.595 | B | M | 4 | 8 | 1F | (-)COP | 81522 |
| | 55 | 11/95 → 09/97 | 1.595 | B | M | 4 | 8 | 1F | (+)COP | 82080 |
| | 55 | 10/94 → 10/99 | 1.598 | B | M | 4 | 8 | AEA, AEE, AHS | | 81527 |
| | 55 | 11/95 → 09/01 | 1.598 | B | M | 4 | 8 | AEE, ALM | | 81527 |
| 90 1.8 | 66 | 01/97 → 09/01 | 1.781 | B | M | 4 | 8 | ABS, ADD, ADZ | (-)COP | 81522 |
| | 66 | 01/97 → 09/01 | 1.781 | B | M | 4 | 8 | ABS, ADD, ADZ | (+)COP | 82080 |
| 90 1.9 TDI | 66 | 09/96 → 09/01 | 1.896 | D | M | 4 | 8 | AGR, AHU, ALE, ALH | (-)COP, M: ALE | 81522 |
| | 66 | 09/96 → 09/01 | 1.896 | D | M | 4 | 8 | AGR, AHU, ALE, ALH | (+)COP | 82080 |
| | 66 | 09/96 → 09/01 | 1.896 | D | M | 4 | 8 | AGR, AHU, ALE, ALH | (+)COP, M: ALE | 82080 |
| | 66 | 09/96 → 09/01 | 1.896 | D | M | 4 | 8 | AGR, AHU, ALE, ALH | M: AHU | 81528 |
| | 66 | 09/96 → 09/01 | 1.896 | D | M | 4 | 8 | AGR, AHU, ALE, ALH | M: ALH, M: AGR | 81706 |

Polo IV (6N2)

| | | | | | | | | | | |
|-------------|----|---------------|-------|---|---|---|----|---------------|--|------------------|
| 1.0 | 37 | 10/99 → 09/01 | 999 | B | M | 4 | 8 | ALD, AUC | | 81775 |
| 1.4 | 40 | 10/99 → 09/01 | 1.390 | B | M | 4 | 8 | AKP, ANX | | 81775 |
| | 44 | 10/99 → 09/01 | 1.390 | B | M | 4 | 8 | AKK, AUD | | 81775 |
| 1.4 16V | 55 | 10/99 → 09/01 | 1.390 | B | M | 4 | 16 | AHW, APE, AUA | | 81777 |
| | 74 | 10/99 → 09/01 | 1.390 | B | M | 4 | 16 | AFK, AQQ, AUB | | 81777 |
| 1.4 TDI | 55 | 10/99 → 09/01 | 1.422 | D | M | 3 | 6 | AMF | | 84010 NEW |
| | 55 | 10/99 → 09/01 | 1.422 | D | M | 3 | 6 | AMF | | 81791 |
| | 66 | 01/00 → 10/00 | 1.422 | D | M | 3 | 6 | ATL | | 84010 NEW |
| | 66 | 01/00 → 10/00 | 1.422 | D | M | 3 | 6 | ATL | | 81791 |
| 1.6 16V GTI | 92 | 10/99 → 09/01 | 1.598 | B | M | 4 | 16 | ARC, AVY | | 81840 |
| 1.7 SDI | 44 | 10/99 → 09/01 | 1.716 | D | M | 4 | 8 | AKU | | 81528 |
| 1.9 D | 47 | 10/99 → 09/01 | 1.896 | D | M | 4 | 8 | AEF | | 81528 |
| 1.9 SDI | 47 | 10/99 → 09/01 | 1.896 | D | M | 4 | 8 | AGD, ASX | | 81528 |

Polo V (9N)

| | | | | | | | | | | |
|---------|----|---------------|-------|---|----|---|----|---------------|--|-------|
| 1.2 | 40 | 01/02 → 05/07 | 1.198 | B | M | 3 | 6 | AWY, BMD | | 81867 |
| | 44 | 05/07 → 11/09 | 1.198 | B | M | 3 | 6 | BBM | | 81867 |
| 1.2 12V | 47 | 10/01 → 07/07 | 1.198 | B | M | 3 | 12 | AZQ, BME | | 81867 |
| | 51 | 05/07 → 11/09 | 1.198 | B | M | 3 | 12 | BZG | | 81867 |
| 1.4 | 55 | 07/03 → | 1.390 | B | M | 4 | 16 | BBY, BKY | | 81777 |
| | 63 | 06/05 → 11/09 | 1.390 | B | M | 4 | 8 | | | 81777 |
| | 74 | 11/03 → | 1.390 | B | M | 4 | 16 | BBZ | | 81777 |
| 1.4 16V | 55 | 10/01 → 05/08 | 1.390 | B | AM | 4 | 16 | AUA, BBY, BKY | | 81777 |
| | 59 | 05/06 → 11/09 | 1.390 | B | M | 4 | 16 | BUD | | 81777 |
| | 74 | 10/01 → 05/08 | 1.390 | B | M | 4 | 16 | AUB, BBZ | | 81777 |
| 1.4 FSI | 63 | 02/02 → 07/06 | 1.390 | B | M | 4 | 16 | AXU | | 81865 |

KW

cm³

NO. OF VALVES

MAGNETI MARELLI
VOLKSWAGEN
Polo V (9N)

| | | | | | | | | | | | |
|---------------------|-----|---------------|-------|---|---|---|----|----------------|----------------|-------|------------|
| 1.4 TDI | 51 | 04/05 → 11/09 | 1.422 | D | M | 3 | 6 | BNM, BWB | | 84010 | NEW |
| | 51 | 04/05 → 11/09 | 1.422 | D | M | 3 | 6 | BNM, BWB | | 81791 | |
| | 55 | 10/01 → 06/05 | 1.422 | D | M | 3 | 6 | AMF, BAY | | 84010 | NEW |
| | 55 | 10/01 → 06/05 | 1.422 | D | M | 3 | 6 | AMF, BAY | | 81791 | |
| | 55 | 07/03 → | 1.422 | D | M | 3 | 6 | BAY | | 84010 | NEW |
| | 55 | 07/03 → | 1.422 | D | M | 3 | 6 | BAY | | 81791 | |
| | 59 | 04/05 → 11/09 | 1.422 | D | M | 3 | 6 | BMS, BNV | | 84010 | NEW |
| | 59 | 04/05 → 11/09 | 1.422 | D | M | 3 | 6 | BMS, BNV | | 81791 | |
| 1.6 | 74 | 08/02 → 05/05 | 1.598 | B | M | 4 | 8 | BAH | | 81527 | |
| | 74 | 09/02 → | 1.598 | B | M | 4 | 8 | BAH, BPA, CFZA | | 81527 | |
| 1.6 16V | 77 | 05/06 → 11/09 | 1.598 | B | M | 4 | 16 | BTS | | 81865 | |
| 1.8 GTI | 110 | 09/05 → 11/09 | 1.781 | B | M | 4 | 20 | BJX | | 81703 | |
| 1.8 GTI Cup Edition | 132 | 05/06 → 11/09 | 1.781 | B | M | 4 | 20 | BBU | | 81703 | |
| 1.9 SDI | 47 | 10/01 → 11/09 | 1.896 | D | M | 4 | 8 | ASY | → T: 9N2100000 | 84052 | NEW |
| | 47 | 10/01 → 11/09 | 1.896 | D | M | 4 | 8 | ASY | T →: 9N2100001 | 82013 | |
| | 47 | 09/02 → | 1.896 | D | M | 4 | 8 | ASY | | 82013 | |
| 1.9 TDi | 74 | 09/02 → | 1.896 | D | M | 4 | 8 | ATD | | 84010 | NEW |
| | 74 | 09/02 → | 1.896 | D | M | 4 | 8 | ATD | | 81791 | |
| | 74 | 10/01 → 11/09 | 1.896 | D | M | 4 | 8 | ATD, AXR, BMT | | 84010 | NEW |
| | 74 | 10/01 → 11/09 | 1.896 | D | M | 4 | 8 | ATD, AXR, BMT | | 81791 | |
| | 96 | 11/03 → 11/09 | 1.896 | D | M | 4 | 8 | ASZ, BLT | | 84010 | NEW |
| | 96 | 11/03 → 11/09 | 1.896 | D | M | 4 | 8 | ASZ, BLT | | 81791 | |

Polo VI (6R)

| | | | | | | | | | | | |
|-------------|-----|---------------|-------|----|---|---|----|------------------|--|-------|------------|
| 1.0 TSI | 70 | 11/14 → | 999 | B | M | 3 | 12 | CHZB | | 84062 | NEW |
| 1.2 | 44 | 06/09 → | 1.198 | B | M | 3 | 12 | CGPB | | 81867 | |
| | 51 | 06/09 → | 1.198 | B | M | 3 | 12 | CGPA | | 81867 | |
| 1.2 TDI | 55 | 10/09 → | 1.199 | D | M | 3 | 12 | CFWA | | 84001 | |
| 1.2 TSI | 66 | 05/11 → 05/14 | 1.197 | B | M | 4 | 8 | CBZC | | 84045 | NEW |
| | 77 | 11/09 → | 1.197 | B | M | 4 | 8 | CBZB | | 84045 | NEW |
| | 81 | 01/14 → | 1.197 | B | M | 4 | 16 | CJZD | | 84062 | NEW |
| 1.2 TSI 16V | 66 | 02/14 → | 1.197 | B | M | 4 | 16 | CJZC | | 84062 | NEW |
| 1.4 | 63 | 06/09 → | 1.390 | B | M | 4 | 16 | CDDA, CGGB, CLPA | | 81777 | |
| 1.4 BiFuel | 60 | 03/10 → 01/11 | 1.390 | BF | M | 4 | 16 | CMAA | | 81777 | |
| 1.4 TSI | 103 | 10/12 → | 1.395 | B | M | 4 | 16 | CPTA | | 84062 | NEW |
| | 110 | 05/14 → | 1.395 | B | M | 4 | 16 | CZEA | | 84062 | NEW |
| 1.6 | 63 | 11/10 → | 1.598 | B | M | 4 | 16 | CFNB | | 81777 | |
| | 77 | 05/10 → | 1.598 | B | M | 4 | 16 | CFNA, CLSA | | 81865 | |
| | 81 | 07/14 → | 1.598 | B | M | 4 | 16 | CWVA | | 84062 | NEW |
| 1.6 BiFuel | 60 | 01/11 → | 1.598 | BF | M | 4 | 16 | CNKA | | 81777 | |
| 1.6 TDI | 55 | 06/09 → | 1.598 | D | M | 4 | 16 | CAYA | | 84001 | |
| | 66 | 06/09 → | 1.598 | D | M | 4 | 16 | CAYB | | 84001 | |
| | 77 | 06/09 → | 1.598 | D | M | 4 | 16 | CAYC, CLNA | | 84001 | |
| 1.8 GTI | 136 | 11/14 → | 1.798 | B | M | 4 | 16 | CWYA | | 84037 | NEW |
| | 141 | 11/14 → | 1.798 | B | M | 4 | 16 | DAJA, DAJB | | 84037 | NEW |

KW

cm³

NO. OF VALVES

VOLKSWAGEN
Polo VI (6R)

| | | | | | | | | | | |
|-----------|-----|---------|-------|---|---|---|----|------|--|-------|
| 2.0 R WRC | 162 | 08/13 → | 1.984 | B | M | 4 | 16 | CDLJ | | 82025 |
|-----------|-----|---------|-------|---|---|---|----|------|--|-------|

Scirocco II

| | | | | | | | | | | |
|---------|----|---------------|-------|---|---|---|----|----|--------|-------|
| 1.6 | 53 | 04/86 → 07/90 | 1.595 | B | M | 4 | 8 | RE | (-)COP | 81522 |
| | 53 | 04/86 → 07/90 | 1.595 | B | M | 4 | 8 | RE | (+)COP | 82080 |
| 1.8 | 66 | 08/83 → 07/92 | 1.781 | B | M | 4 | 8 | EX | (-)COP | 81522 |
| | 66 | 08/83 → 07/92 | 1.781 | B | M | 4 | 8 | EX | (+)COP | 82080 |
| | 70 | 11/85 → 07/92 | 1.781 | B | M | 4 | 8 | JH | (-)COP | 81522 |
| | 70 | 11/85 → 07/92 | 1.781 | B | M | 4 | 8 | JH | (+)COP | 82080 |
| 1.8 16V | 95 | 03/86 → 07/92 | 1.781 | B | M | 4 | 16 | PL | (-)COP | 81522 |
| | 95 | 03/86 → 07/92 | 1.781 | B | M | 4 | 16 | PL | (+)COP | 82080 |

Scirocco III

| | | | | | | | | | | |
|---------|-----|---------------|-------|---|---|---|----|------------|--|------------------|
| 1.4 TSI | 90 | 08/08 → | 1.390 | B | M | 4 | 16 | CAXA, CMSB | | 82097 |
| 2.0 R | 188 | 11/09 → | 1.984 | B | M | 4 | 16 | CDLC | | 82025 |
| | 195 | 11/09 → | 1.984 | B | M | 4 | 16 | CDLA | | 82025 |
| | 206 | 05/14 → | 1.984 | B | M | 4 | 16 | CDLK | | 84037 NEW |
| 2.0 TDI | 100 | 11/10 → | 1.968 | D | M | 4 | 16 | CFHB | | 84001 |
| | 103 | 08/08 → | 1.968 | D | M | 4 | 16 | CBDB, CFHC | | 81816 |
| | 103 | 08/08 → | 1.968 | D | M | 4 | 16 | CBDB, CFHC | | 84011 NEW |
| | 125 | 05/09 → | 1.968 | D | M | 4 | 16 | CBBB, CFGB | | 81816 |
| | 125 | 05/09 → | 1.968 | D | M | 4 | 16 | CBBB, CFGB | | 84011 NEW |
| | 130 | 01/13 → | 1.968 | D | M | 4 | 16 | CFGC | | 84001 |
| 2.0 TSI | 132 | 11/13 → | 1.984 | B | M | 4 | 16 | CULA | | 84037 NEW |
| | 147 | 05/08 → 11/09 | 1.984 | B | M | 4 | 16 | CAWB | | 84016 NEW |
| | 155 | 11/09 → | 1.984 | B | M | 4 | 16 | CCZB | | 84016 NEW |
| | 162 | 11/13 → | 1.984 | B | M | 4 | 16 | CULC | | 84037 NEW |

Sharan I

| | | | | | | | | | | |
|-----------|-----|---------------|-------|---|---|---|----|--------------|--|------------------|
| 1.8 T 20V | 110 | 09/97 → 03/10 | 1.781 | B | M | 4 | 20 | AJH, AWC | | 81703 |
| 1.9 TDI | 66 | 09/95 → 03/10 | 1.896 | D | M | 4 | 8 | 1Z, AHU, ANU | (-)COP, 09-1995 →, → 0 3-2000, M: AHU, M: 1Z | 81522 |
| | 66 | 09/95 → 03/10 | 1.896 | D | M | 4 | 8 | 1Z, AHU, ANU | (+)COP | 82080 |
| | 66 | 09/95 → 03/10 | 1.896 | D | M | 4 | 8 | 1Z, AHU, ANU | (+)COP, 09-1995 →, → 03-2000, M: 1Z, M: AHU | 82080 |
| | 66 | 09/95 → 03/10 | 1.896 | D | M | 4 | 8 | 1Z, AHU, ANU | 03-2000 →, M: ANU | 81816 |
| | 66 | 09/95 → 03/10 | 1.896 | D | M | 4 | 8 | 1Z, AHU, ANU | | 84011 NEW |
| | 81 | 09/96 → 04/00 | 1.896 | D | M | 4 | 8 | AFN, AVG | (-)COP | 81522 |
| | 81 | 09/96 → 04/00 | 1.896 | D | M | 4 | 8 | AFN, AVG | (+)COP | 82080 |
| | 85 | 04/00 → 03/10 | 1.896 | D | M | 4 | 8 | AUY, BVK | | 81816 |
| | 85 | 04/00 → 03/10 | 1.896 | D | M | 4 | 8 | AUY, BVK | | 84011 NEW |
| | 96 | 11/02 → 03/10 | 1.896 | D | M | 4 | 8 | ASZ | | 84010 NEW |
| | 96 | 11/02 → 03/10 | 1.896 | D | M | 4 | 8 | ASZ | | 81791 |
| | 110 | 06/05 → 03/10 | 1.896 | D | M | 4 | 8 | BTB | | 84010 NEW |
| | 110 | 06/05 → 03/10 | 1.896 | D | M | 4 | 8 | BTB | | 81791 |

KW

cm³

NO. OF VALVES

VOLKSWAGEN
Sharan I

| | | | | | | | | | | |
|--------------------|-----|---------------|-------|---|---|---|----|----------|---|------------------|
| 1.9 TDI 4motion | 85 | 04/00 → 03/10 | 1.896 | D | M | 4 | 8 | AUY, BVK | | 81816 |
| | 85 | 04/00 → 03/10 | 1.896 | D | M | 4 | 8 | AUY, BVK | | 84011 NEW |
| 2.0 | 85 | 09/95 → 03/10 | 1.984 | B | M | 4 | 8 | ADY, ATM | (-)COP, 09-1995 →, → 02-2000, M: ADY | 81522 |
| | 85 | 09/95 → 03/10 | 1.984 | B | M | 4 | 8 | ADY, ATM | (+)COP | 82080 |
| | 85 | 09/95 → 03/10 | 1.984 | B | M | 4 | 8 | ADY, ATM | (+)COP, 09-1995 →, → 02-2000, M: ADY | 82080 |
| | 85 | 09/95 → 03/10 | 1.984 | B | M | 4 | 8 | ADY, ATM | 03-2000 →, M: ATM | 81703 |
| 2.0 LPG | 85 | 04/06 → 03/10 | 1.984 | | M | 4 | 8 | ATM | | 81703 |
| 2.0 TDI | 100 | 11/05 → 03/10 | 1.968 | D | M | 4 | 8 | BVH | | 81816 |
| | 100 | 11/05 → 03/10 | 1.968 | D | M | 4 | 8 | BVH | | 84011 NEW |
| | 103 | 11/05 → 03/10 | 1.968 | D | M | 4 | 8 | BRT | | 81816 |
| | 103 | 11/05 → 03/10 | 1.968 | D | M | 4 | 8 | BRT | | 84011 NEW |
| 2.8 V6 24V | 150 | 04/00 → 03/10 | 2.792 | B | M | 6 | 24 | AYL | → T: 035.000 | 81773 |
| | 150 | 04/00 → 03/10 | 2.792 | B | M | 6 | 24 | AYL | T →: 035.001 | 81866 |
| 2.8 V6 24V 4motion | 150 | 04/00 → 03/10 | 2.792 | B | M | 6 | 24 | AYL | → T: 035.000 | 81773 |
| | 150 | 04/00 → 03/10 | 2.792 | B | M | 6 | 24 | AYL | T →: 035.001 | 81866 |
| 2.8 VR6 | 128 | 09/95 → 04/00 | 2.792 | B | M | 6 | 12 | AAA, AMY | 09-1995 → | 81773 |
| 2.8 VR6 Syncro | 128 | 11/96 → 04/00 | 2.792 | B | M | 6 | 12 | AAA, AMY | 09-1995 → | 81773 |

Sharan II

| | | | | | | | | | | |
|-----------------|-----|---------------|-------|---|---|---|----|------------|--|------------------|
| 1.4 TSI | 110 | 05/15 → | 1.395 | B | M | 4 | 16 | CZDA | | 84062 NEW |
| 2.0 TDI | 85 | 05/11 → | 1.968 | D | M | 4 | 16 | CFFE, CUVA | | 84001 |
| | 100 | 05/10 → | 1.968 | D | M | 4 | 16 | CFFA | | 84001 |
| | 103 | 05/10 → | 1.968 | D | M | 4 | 16 | CFFB | | 84001 |
| | 125 | 08/10 → | 1.968 | D | M | 4 | 16 | CFGB | | 84001 |
| | 130 | 01/13 → | 1.968 | D | M | 4 | 16 | CFGC | | 84001 |
| 2.0 TDI 4motion | 100 | 05/11 → 05/12 | 1.968 | D | M | 4 | 16 | CFFA | | 84001 |
| | 103 | 05/11 → | 1.968 | D | M | 4 | 16 | CFFB | | 84001 |
| 2.0 TSI | 147 | 12/10 → | 1.984 | B | M | 4 | 16 | CCZA | | 84016 NEW |
| | 162 | 05/15 → | 1.984 | B | M | 4 | 16 | DEDA | | 84037 NEW |

Tiguan I

| | | | | | | | | | | |
|---------|-----|---------|-------|---|---|---|----|------------|--|------------------|
| 1.4 TSI | 90 | 08/10 → | 1.390 | B | M | 4 | 16 | CAXA | | 82097 |
| | 92 | 05/15 → | 1.395 | B | M | 4 | 16 | CZDB | | 84062 NEW |
| | 110 | 05/15 → | 1.395 | B | M | 4 | 16 | CZDA | | 84062 NEW |
| 2.0 TDI | 81 | 05/10 → | 1.968 | D | M | 4 | 16 | CFFD | | 84001 |
| | 103 | 03/08 → | 1.968 | D | M | 4 | 16 | CBAB, CFFB | | 81816 |
| | 103 | 03/08 → | 1.968 | D | M | 4 | 16 | CBAB, CFFB | | 84011 NEW |

KW

cm³

NO. OF VALVES

MAGNETI MARELLI
VOLKSWAGEN
Tiguan I

| | | | | | | | | | | | |
|------------------|-----|---------------|-------|---|---|---|----|------------------|--|-------|------------|
| 2.0 TDI 4motion | 100 | 11/07 → | 1.968 | D | M | 4 | 16 | CBAA, CFFA | | 81816 | |
| | 100 | 11/07 → | 1.968 | D | M | 4 | 16 | CBAA, CFFA | | 84011 | NEW |
| | 103 | 09/07 → | 1.968 | D | M | 4 | 16 | CBAB, CFFB, CLJA | | 81816 | |
| | 103 | 09/07 → | 1.968 | D | M | 4 | 16 | CBAB, CFFB, CLJA | | 84011 | NEW |
| | 120 | 02/08 → 08/09 | 1.968 | D | M | 4 | 16 | CBBA | | 81816 | |
| | 120 | 02/08 → 08/09 | 1.968 | D | M | 4 | 16 | CBBA | | 84011 | NEW |
| | 125 | 09/07 → | 1.968 | D | M | 4 | 16 | CBBB, CFGB | | 81816 | |
| | 125 | 09/07 → | 1.968 | D | M | 4 | 16 | CBBB, CFGB | | 84011 | NEW |
| | 130 | 11/12 → | 1.968 | D | M | 4 | 16 | CFGC | | 84001 | |
| 2.0 TFSI 4motion | 125 | 09/07 → | 1.984 | B | M | 4 | 16 | CAWA, CCZC | | 84016 | NEW |
| | 147 | 09/07 → | 1.984 | B | M | 4 | 16 | CAWB, CCTA, CCZA | | 84016 | NEW |
| 2.0 TSI 4motion | 132 | 05/11 → | 1.984 | B | M | 4 | 16 | CCZD | | 84016 | NEW |
| | 155 | 05/11 → | 1.984 | B | M | 4 | 16 | CCZB | | 84016 | NEW |

Tiguan II

| | | | | | | | | | | | |
|-----------------|-----|---------|-------|---|---|---|----|--|--|-------|------------|
| 2.0 TSI 4motion | 132 | 02/16 → | 1.984 | B | M | 4 | 16 | | | 84037 | NEW |
|-----------------|-----|---------|-------|---|---|---|----|--|--|-------|------------|

Touareg I

| | | | | | | | | | | | |
|------------|-----|---------------|-------|---|---|---|----|------------------------------|--|-------|--|
| 2.5 R5 TDI | 120 | 08/03 → 05/10 | 2.461 | D | M | 5 | 10 | BLK, BPD | | 82033 | |
| | 128 | 01/03 → 05/10 | 2.461 | D | M | 5 | 10 | BAC, BPE | | 82033 | |
| 3.0 TDI | 155 | 04/06 → 05/10 | 2.967 | D | M | 6 | 24 | BUN, CASB | | 82015 | |
| 3.0 V6 TDI | 165 | 11/04 → 05/10 | 2.967 | D | M | 6 | 24 | BKS, CATA | | 82015 | |
| | 176 | 11/07 → 05/10 | 2.967 | D | M | 6 | 24 | CASA, CASC | | 82015 | |
| 3.2 V6 | 162 | 10/02 → 11/06 | 3.189 | B | M | 6 | 24 | AZZ, BAA, BKJ, BMV, BMX, BRJ | | 81866 | |
| | 177 | 11/04 → 11/06 | 3.189 | B | M | 6 | 24 | BMV | | 81866 | |
| 3.6 V6 FSI | 206 | 10/05 → 05/10 | 3.597 | B | M | 6 | 24 | BHK, BHL | | 81866 | |
| 4.2 V8 | 228 | 12/02 → 11/06 | 4.172 | B | M | 8 | 40 | AXQ, BHX | | 82081 | |

Touareg II

| | | | | | | | | | | | |
|------------|-----|---------|-------|---|---|---|----|------------------|--|-------|------------|
| 3.0 V6 TDI | 150 | 01/10 → | 2.967 | D | M | 6 | 24 | CASD, CJMA, CVWA | | 84021 | NEW |
| | 165 | 06/10 → | 2.967 | D | M | 6 | 24 | CATA | | 82015 | |
| | 176 | 01/10 → | 2.967 | D | M | 6 | 24 | CASA, CNRB | | 82015 | |
| | 180 | 05/11 → | 2.967 | D | M | 6 | 24 | CJGD, CRCA | | 84021 | NEW |
| | 193 | 09/14 → | 2.967 | D | M | 6 | 24 | CVVA | | 84021 | NEW |

Touran I

| | | | | | | | | | | | |
|---------|---------------|---------------|-------|---|---|---|---------------|---------------|-------|-------|------------|
| 1.2 TSI | 77 | 05/10 → 05/15 | 1.197 | B | M | 4 | 8 | CBZB | | 84045 | NEW |
| 1.6 | 75 | 07/03 → 05/10 | 1.595 | B | M | 4 | 8 | BGU, BSE, BSF | | 81702 | |
| 1.6 FSI | 85 | 02/03 → 01/07 | 1.598 | B | M | 4 | 16 | BAG, BLF, BLP | | 81865 | |
| 1.6 TDI | 66 | 05/10 → 05/15 | 1.598 | D | M | 4 | 16 | CAYB | | 84001 | |
| | 77 | 05/10 → 05/15 | 1.598 | D | M | 4 | 16 | CAYC | | 84001 | |
| 1.9 TDI | 66 | 11/04 → 05/10 | 1.896 | D | M | 4 | 8 | BRU, BXF, BXJ | | 84010 | NEW |
| | 66 | 11/04 → 05/10 | 1.896 | D | M | 4 | 8 | BRU, BXF, BXJ | | 81791 | |
| | 74 | 02/03 → 05/04 | 1.896 | D | M | 4 | 8 | AVQ | | 84010 | NEW |
| | 74 | 02/03 → 05/04 | 1.896 | D | M | 4 | 8 | AVQ | | 81791 | |
| | 77 | 08/03 → 05/10 | 1.896 | D | M | 4 | 8 | BKC, BLS, BXE | | 84010 | NEW |
| 77 | 08/03 → 05/10 | 1.896 | D | M | 4 | 8 | BKC, BLS, BXE | | 81791 | | |

KW

cm³

NO. OF VALVES

VOLKSWAGEN
Touran I

| | | | | | | | | | | |
|-------------|-----|---------------|-------|---|---|---|----|------------------------------|--|------------------|
| 2.0 EcoFuel | 80 | 02/06 → 05/09 | 1.984 | M | M | 4 | 8 | BSX | | 81703 |
| 2.0 FSI | 85 | 10/04 → 05/10 | 1.984 | B | M | 4 | 16 | BJZ | | 81702 |
| | 110 | 10/03 → 01/07 | 1.984 | B | M | 4 | 16 | AXW, BLR, BLX, BLY, BVY, BVZ | | 81702 |
| 2.0 TDI | 81 | 11/10 → 05/15 | 1.968 | D | M | 4 | 16 | CFHF, CLCA | | 84001 |
| | 100 | 02/03 → 05/10 | 1.968 | D | M | 4 | 16 | AZV | | 81816 |
| | 100 | 02/03 → 05/10 | 1.968 | D | M | 4 | 16 | AZV | | 84011 NEW |
| | 103 | 12/05 → 05/10 | 1.968 | D | M | 4 | 8 | BMM | | 81816 |
| | 103 | 12/05 → 05/10 | 1.968 | D | M | 4 | 8 | BMM | | 84011 NEW |
| | 103 | 05/10 → 05/15 | 1.968 | D | M | 4 | 16 | CFHC | | 84001 |
| | 125 | 12/05 → 05/10 | 1.968 | D | M | 4 | 16 | BMN, CFJA | | 81816 |
| | 125 | 12/05 → 05/10 | 1.968 | D | M | 4 | 16 | BMN, CFJA | | 84011 NEW |
| | 125 | 05/10 → 01/13 | 1.968 | D | M | 4 | 16 | CFJA | | 84001 |
| 2.0 TDI 16V | 130 | 01/13 → 05/15 | 1.968 | D | M | 4 | 16 | CFJB | | 84001 |
| | 103 | 08/03 → 05/10 | 1.968 | D | M | 4 | 16 | BKD | | 81816 |
| | 103 | 08/03 → 05/10 | 1.968 | D | M | 4 | 16 | BKD | | 84011 NEW |

Touran II

| | | | | | | | | | | |
|---------|-----|---------|-------|---|---|---|----|------|--|------------------|
| 1.2 TSI | 81 | 05/15 → | 1.197 | B | M | 4 | 16 | CYVB | | 84062 NEW |
| 1.4 TSI | 110 | 05/15 → | 1.395 | B | M | 4 | 16 | CZDA | | 84062 NEW |

Transporter III

| | | | | | | | | | | |
|---------------|----|---------------|-------|---|---|---|---|----|-------------------------|-------|
| 1.6 TD | 51 | 08/84 → 07/92 | 1.589 | D | M | 4 | 8 | JX | (-)COP, → M: 012.052 | 81521 |
| | 51 | 08/84 → 07/92 | 1.589 | D | M | 4 | 8 | JX | (-)COP, M →: 012.053 | 81522 |
| | 51 | 08/84 → 07/92 | 1.589 | D | M | 4 | 8 | JX | (+)COP | 82080 |
| | 51 | 08/84 → 07/92 | 1.589 | D | M | 4 | 8 | JX | (+)COP, → M: 012.052 | 82001 |
| | 51 | 08/84 → 07/92 | 1.589 | D | M | 4 | 8 | JX | (+)COP, M →: 012.053 | 82080 |
| 1.6 TD Syncro | 51 | 03/86 → 07/92 | 1.589 | D | M | 4 | 8 | JX | (-)COP, → M: 012.052 | 81521 |
| | 51 | 03/86 → 07/92 | 1.589 | D | M | 4 | 8 | JX | (-)COP, M →: 012.053 | 81522 |
| | 51 | 03/86 → 07/92 | 1.589 | D | M | 4 | 8 | JX | (+)COP | 82080 |
| | 51 | 03/86 → 07/92 | 1.589 | D | M | 4 | 8 | JX | (+)COP, → M: 012.052 | 82001 |
| | 51 | 03/86 → 07/92 | 1.589 | D | M | 4 | 8 | JX | (+)COP, M →: 012.053 | 82080 |
| 1.7 D | 42 | 10/86 → 07/92 | 1.716 | D | M | 4 | 8 | KY | (-)COP | 81522 |
| | 42 | 10/86 → 07/92 | 1.716 | D | M | 4 | 8 | KY | (+)COP | 82080 |
| 2.1 | 64 | 10/86 → 07/92 | 2.109 | B | M | 4 | 8 | SR | | 81832 |
| | 70 | 08/85 → 07/92 | 2.110 | B | M | 4 | 8 | MV | | 81832 |
| | 82 | 08/84 → 07/92 | 2.110 | B | M | 4 | 8 | DJ | | 81832 |
| 2.1 Cat. | 70 | 06/89 → 07/92 | 2.110 | B | M | 4 | 8 | MV | | 81832 |

KW

cm³

NO. OF VALVES

VOLKSWAGEN
Transporter III

| | | | | | | | | | | |
|------------|----|---------------|-------|---|---|---|---|----|--|-------|
| 2.1 i | 68 | 07/89 → 07/92 | 2.110 | B | M | 4 | 8 | SS | | 81832 |
| 2.1 Syncro | 64 | 10/86 → 07/92 | 2.109 | B | M | 4 | 8 | SR | | 81832 |
| | 70 | 08/85 → 07/92 | 2.110 | B | M | 4 | 8 | MV | | 81832 |
| | 82 | 01/86 → 07/92 | 2.110 | B | M | 4 | 8 | DJ | | 81832 |

Transporter IV

| | | | | | | | | | | |
|--------------|----|---------------|-------|---|---|---|----|--------------------|--|-------|
| 1.8 | 49 | 12/90 → 07/92 | 1.781 | B | M | 4 | 8 | PD | (-)COP | 81522 |
| | 49 | 12/90 → 07/92 | 1.781 | B | M | 4 | 8 | PD | (+)COP | 82080 |
| 1.9 D | 44 | 09/90 → 12/95 | 1.896 | D | M | 4 | 8 | 1X | (-)COP | 81522 |
| | 44 | 09/90 → 12/95 | 1.896 | D | M | 4 | 8 | 1X | (+)COP | 82080 |
| | 45 | 07/90 → 12/95 | 1.896 | D | M | 4 | 8 | 1X | (-)COP | 81522 |
| | 45 | 07/90 → 12/95 | 1.896 | D | M | 4 | 8 | 1X | (+)COP | 82080 |
| 1.9 TD | 50 | 10/92 → 04/03 | 1.896 | D | M | 4 | 8 | ABL | (-)COP | 81522 |
| | 50 | 10/92 → 04/03 | 1.896 | D | M | 4 | 8 | ABL | (+)COP | 82080 |
| 2.0 | 62 | 07/90 → 04/03 | 1.968 | B | M | 4 | 8 | AAC | (-)COP, 09-1990 → | 81522 |
| | 62 | 07/90 → 04/03 | 1.968 | B | M | 4 | 8 | AAC | (+)COP, 09-1990 → | 82080 |
| | 62 | 09/90 → 04/03 | 1.968 | B | M | 4 | 8 | AAC | (-)COP | 81522 |
| | 62 | 09/90 → 04/03 | 1.968 | B | M | 4 | 8 | AAC | (+)COP | 82080 |
| 2.4 D | 55 | 08/97 → 04/03 | 2.370 | D | M | 5 | 10 | AJA | | 81701 |
| | 57 | 07/90 → 04/98 | 2.370 | D | M | 5 | 10 | AAB | 09-1990 →, → 07-1995, T →: F70.N.014.000 | 81772 |
| | 57 | 09/90 → 04/98 | 2.370 | D | M | 5 | 10 | AAB | → 07-1995, → T: F70-N-014.000 | 81772 |
| 2.4 D Syncro | 57 | 09/90 → 04/98 | 2.370 | D | M | 5 | 10 | AAB | 08-1995 →, T →: F70.N.014.001 | 81701 |
| | 57 | 10/92 → 09/98 | 2.370 | D | M | 5 | 10 | AAB | 08-1995 →, T →: F70.N.014.001 | 81701 |
| | 57 | 10/92 → 09/98 | 2.370 | D | M | 5 | 10 | AAB | 09-1990 →, → 07-1995, T →: F70.N.014.000 | 81772 |
| 2.5 | 81 | 11/90 → 04/03 | 2.461 | B | M | 5 | 10 | AAF, ACU, AEN, AEU | → T: F70.N.014.000 | 81772 |
| | 81 | 11/90 → 04/03 | 2.461 | B | M | 5 | 10 | AAF, ACU, AEN, AEU | T →: F70.N.014.001, M: AEN, M: AEU, M: AEN | 81701 |
| | 85 | 08/96 → 04/03 | 2.461 | B | M | 5 | 10 | AET, APL, AVT | | 81701 |
| 2.5 Syncro | 81 | 10/92 → 04/03 | 2.461 | B | M | 5 | 10 | AAF, ACU, AEN, AEU | T →: F70.N.014.001, M: AEN, M: AEU, M: AEN | 81701 |
| | 81 | 11/92 → 04/03 | 2.461 | B | M | 5 | 10 | AAF, ACU, AEN, AEU | → T: F70.N.014.000 | 81772 |
| | 81 | 11/92 → 04/03 | 2.461 | B | M | 5 | 10 | AAF, ACU, AEN, AEU | T →: F70.N.014.001, M: AEU, M: AEN, M: AEU | 81701 |
| | 85 | 07/96 → 04/03 | 2.461 | B | M | 5 | 10 | AET, APL, AVT | | 81701 |

KW

cm³

NO. OF VALVES

VOLKSWAGEN
Transporter IV

| | | | | | | | | | | |
|----------------|-----|---------------|-------|---|---|---|----|--------------------|--|-------|
| 2.5 TDI | 65 | 05/98 → 04/03 | 2.461 | D | M | 5 | 10 | AJT, AYY | | 81701 |
| | 75 | 09/95 → 04/03 | 2.461 | D | M | 5 | 10 | ACV, AUF, AXL, AYC | | 81701 |
| | 75 | 09/95 → 04/03 | 2.461 | D | M | 5 | 10 | ACV, AUF, AYC | | 81701 |
| | 111 | 05/98 → 04/03 | 2.461 | D | M | 5 | 10 | AHY, AXG | | 81701 |
| | 111 | 09/00 → 04/03 | 2.461 | D | M | 5 | 10 | AXG | | 81701 |
| 2.5 TDI Syncro | 75 | 01/96 → 04/03 | 2.461 | D | M | 5 | 10 | ACV, AXL | | 81701 |
| 2.8 | 103 | 05/96 → 05/00 | 2.792 | B | M | 6 | 12 | AES | | 81773 |
| 2.8 VR6 | 103 | 11/95 → 04/00 | 2.792 | B | M | 6 | 12 | AES | | 81773 |
| | 150 | 04/00 → 04/03 | 2.792 | B | M | 6 | 24 | AMV | | 81773 |
| | 150 | 06/00 → 04/03 | 2.792 | B | M | 6 | 24 | AMV | | 81866 |
| 2.8 VR6 Syncro | 103 | 01/96 → 04/96 | 2.792 | B | M | 6 | 12 | AES | | 81773 |

Transporter V

| | | | | | | | | | | | |
|-------------------|-----|---------------|-------|---|---|---|----|------------|--|-------|------------|
| 1.9 TDI | 62 | 01/06 → 11/09 | 1.896 | D | M | 4 | 8 | BRR | | 84010 | NEW |
| | 62 | 01/06 → 11/09 | 1.896 | D | M | 4 | 8 | BRR | | 81791 | |
| | 63 | 04/03 → 11/09 | 1.896 | D | M | 4 | 8 | AXC | | 84010 | NEW |
| | 63 | 04/03 → 11/09 | 1.896 | D | M | 4 | 8 | AXC | | 81791 | |
| | 75 | 06/06 → 11/09 | 1.896 | D | M | 4 | 8 | BRS | | 84010 | NEW |
| | 75 | 06/06 → 11/09 | 1.896 | D | M | 4 | 8 | BRS | | 81791 | |
| | 77 | 04/03 → 11/09 | 1.896 | D | M | 4 | 8 | AXB | | 84010 | NEW |
| | 77 | 04/03 → 11/09 | 1.896 | D | M | 4 | 8 | AXB | | 81791 | |
| 2.0 | 85 | 11/03 → | 1.984 | B | M | 4 | 8 | AXA | | 81703 | |
| 2.0 BITDI | 132 | 09/09 → | 1.968 | D | M | 4 | 16 | CFCA | | 84001 | |
| 2.0 BiTDI 4motion | 132 | 09/09 → | 1.968 | D | M | 4 | 16 | CFCA | | 84001 | |
| 2.0 TDI | 62 | 09/09 → | 1.968 | D | M | 4 | 16 | CAAA | | 84001 | |
| | 75 | 09/09 → | 1.968 | D | M | 4 | 16 | CAAB | | 84001 | |
| | 84 | 05/11 → | 1.968 | D | M | 4 | 16 | CAAD | | 84001 | |
| | 100 | 05/10 → | 1.968 | D | M | 4 | 16 | CAAE | | 84001 | |
| | 100 | 05/10 → | 1.968 | D | M | 4 | 16 | CAAE, CCHB | | 84001 | |
| | 103 | 09/09 → | 1.968 | D | M | 4 | 16 | CAAC | | 84001 | |
| | 103 | 09/09 → | 1.968 | D | M | 4 | 16 | CAAC, CCHA | | 84001 | |
| 2.0 TDI 4motion | 100 | 05/10 → | 1.968 | D | M | 4 | 16 | CAAE, CCHB | | 84001 | |
| | 103 | 09/09 → | 1.968 | D | M | 4 | 16 | CAAC | | 84001 | |
| | 103 | 09/09 → | 1.968 | D | M | 4 | 16 | CAAC, CCHA | | 84001 | |
| 2.0 TSI | 110 | 07/12 → | 1.984 | B | M | 4 | 16 | CJKB | | 84016 | NEW |
| | 150 | 05/11 → | 1.984 | B | M | 4 | 16 | CJKA | | 84016 | NEW |
| 2.0 TSI 4motion | 150 | 07/11 → | 1.984 | B | M | 4 | 16 | CJKA | | 84016 | NEW |
| 2.5 TDI | 96 | 04/03 → 11/09 | 2.461 | D | M | 5 | 10 | AXD, BNZ | | 82033 | |
| | 120 | 11/03 → 11/09 | 2.461 | D | M | 5 | 10 | BLJ | | 82033 | |
| | 128 | 04/03 → 11/09 | 2.461 | D | M | 5 | 10 | AXE, BPC | | 82033 | |
| 2.5 TDI 4motion | 96 | 07/04 → 11/09 | 2.461 | D | M | 5 | 10 | AXD, BNZ | | 82033 | |
| | 128 | 07/04 → 11/09 | 2.461 | D | M | 5 | 10 | AXE, BPC | | 82033 | |
| 3.2 4motion | 173 | 11/03 → 11/09 | 3.189 | B | M | 6 | 24 | BKK, CFLA | | 81866 | |

KW

cm³

NO. OF VALVES

VOLKSWAGEN
Transporter V

| | | | | | | | | | | |
|----------------|-----|---------------|-------|---|---|---|----|-----------|--|-------|
| 3.2 V6 | 170 | 02/04 → 06/04 | 3.189 | B | M | 6 | 24 | BDL | | 81866 |
| | 173 | 08/03 → 05/06 | 3.189 | B | M | 6 | 24 | BKK | | 81866 |
| | 173 | 02/04 → 11/09 | 3.189 | B | M | 6 | 24 | BKK, CFLA | | 81866 |
| 3.2 V6 4motion | 173 | 11/03 → 11/09 | 3.189 | B | M | 6 | 24 | BKK, CFLA | | 81866 |

Vento

| | | | | | | | | | | |
|---------|-----|---------------|-------|---|---|---|----|-------------------|----------------|-------|
| 1.4 | 40 | 11/91 → 09/98 | 1.390 | B | M | 4 | 8 | ABD, AEX | M: ABD | 81524 |
| | 40 | 11/91 → 09/98 | 1.390 | B | M | 4 | 8 | ABD, AEX | M: AEX | 81527 |
| | 44 | 11/91 → 09/98 | 1.390 | B | M | 4 | 8 | ABD, AEX | M: ABD | 81524 |
| | 44 | 11/91 → 09/98 | 1.390 | B | M | 4 | 8 | ABD, AEX | M: AEX | 81527 |
| 1.6 | 74 | 10/94 → 09/98 | 1.595 | B | M | 4 | 8 | AEK, AFT | (-)COP | 81522 |
| | 74 | 10/94 → 09/98 | 1.595 | B | M | 4 | 8 | AEK, AFT | (+)COP | 82080 |
| | 55 | 09/92 → 09/98 | 1.598 | B | M | 4 | 8 | ABU, AEA, AEE | M: ABU | 81524 |
| | 55 | 09/92 → 09/98 | 1.598 | B | M | 4 | 8 | ABU, AEA, AEE | M: AEE, M: AEA | 81527 |
| 1.8 | 55 | 11/91 → 09/98 | 1.781 | B | M | 4 | 8 | AAM | (-)COP | 81522 |
| | 55 | 11/91 → 09/98 | 1.781 | B | M | 4 | 8 | AAM | (+)COP | 82080 |
| | 66 | 11/91 → 09/98 | 1.781 | B | M | 4 | 8 | ABS, ADZ | (-)COP | 81522 |
| | 66 | 11/91 → 09/98 | 1.781 | B | M | 4 | 8 | ABS, ADZ | (+)COP | 82080 |
| 1.9 D | 48 | 11/91 → 09/98 | 1.896 | D | M | 4 | 8 | 1Y | (-)COP | 81522 |
| | 48 | 11/91 → 09/98 | 1.896 | D | M | 4 | 8 | 1Y | (+)COP | 82080 |
| 1.9 SDI | 47 | 04/97 → 09/98 | 1.896 | D | M | 4 | 8 | AEY | (-)COP | 81522 |
| | 47 | 04/97 → 09/98 | 1.896 | D | M | 4 | 8 | AEY | (+)COP | 82080 |
| 1.9 TD | 55 | 11/91 → 09/98 | 1.896 | D | M | 4 | 8 | AAZ | (-)COP | 81522 |
| | 55 | 11/91 → 09/98 | 1.896 | D | M | 4 | 8 | AAZ | (+)COP | 82080 |
| 1.9 TDI | 66 | 09/93 → 09/98 | 1.896 | D | M | 4 | 8 | 1Z, AHU, ALE | (-)COP | 81522 |
| | 66 | 09/93 → 09/98 | 1.896 | D | M | 4 | 8 | 1Z, AHU, ALE | (+)COP | 82080 |
| | 81 | 04/96 → 09/98 | 1.896 | D | M | 4 | 8 | AFN | (-)COP | 81522 |
| | 81 | 04/96 → 09/98 | 1.896 | D | M | 4 | 8 | AFN | (+)COP | 82080 |
| 2.0 | 85 | 11/91 → 09/98 | 1.984 | B | M | 4 | 8 | 2E, ADY, AGG, AKR | (-)COP | 81522 |
| | 85 | 11/91 → 09/98 | 1.984 | B | M | 4 | 8 | 2E, ADY, AGG, AKR | (+)COP | 82080 |
| 2.0 GL | 62 | 11/91 → 07/98 | 1.968 | B | M | 4 | 8 | AAC | (-)COP | 81522 |
| | 62 | 11/91 → 07/98 | 1.968 | B | M | 4 | 8 | AAC | (+)COP | 82080 |
| | 79 | 05/96 → 12/97 | 1.984 | B | M | 4 | 8 | AEP | (-)COP | 81522 |
| | 79 | 05/96 → 12/97 | 1.984 | B | M | 4 | 8 | AEP | (+)COP | 82080 |
| 2.8 VR6 | 120 | 08/95 → 04/96 | 2.792 | B | M | 6 | 12 | AAA | | 81773 |
| | 128 | 01/92 → 09/98 | 2.792 | B | M | 6 | 12 | AAA | | 81773 |

VOLVO
240, Station Wagon

| | | | | | | | | | | |
|------------|-----|---------------|-------|---|---|---|---|-------|-------------------------|-------|
| 2.0 | 86 | 08/83 → 07/93 | 1.986 | B | M | 4 | 8 | B200E | | 81594 |
| 2.3 Cat. | 100 | 08/91 → 07/92 | 2.316 | B | M | 4 | 8 | B230F | | 81594 |
| 2.3 i Cat. | 85 | 08/86 → 07/93 | 2.316 | B | M | 4 | 8 | B230F | 09-1984 →, → 12-1993 | 81594 |
| | 85 | 08/86 → 07/93 | 2.316 | B | M | 4 | 8 | B230F | | 81594 |

KW

cm³

NO. OF VALVES

VOLVO
240, Station Wagon

| | | | | | | | | | | |
|------------|----|---------------|-------|---|---|---|----|-----|-------------------------|-------|
| 2.4 Diesel | 58 | 08/87 → 08/93 | 2.383 | D | M | 6 | 12 | D24 | 01-1979 →, → 12-1993 | 81593 |
| | 58 | 08/88 → 08/93 | 2.383 | D | M | 6 | 12 | D24 | | 81593 |

340 - 360

| | | | | | | | | | | |
|------------|----|---------------|-------|---|---|---|---|-------|--|-------|
| 1.6 Diesel | 40 | 08/84 → 07/91 | 1.596 | D | M | 4 | 8 | D16 | | 81574 |
| 1.7 | 59 | 08/85 → 07/91 | 1.721 | B | M | 4 | 8 | B172K | | 81574 |

440

| | | | | | | | | | | | |
|------------------|-----|---------------|---------------|-------|---|---|---|-------|-------|-------|-------|
| 1.6 | 61 | 09/88 → 12/96 | 1.596 | B | M | 4 | 8 | B16F | | 81574 | |
| | 1.7 | 64 | 09/88 → 12/96 | 1.721 | B | M | 4 | 8 | B18KP | | 81574 |
| | | 75 | 08/89 → 12/96 | 1.721 | B | M | 4 | 8 | B18FP | | 81574 |
| | | 78 | 09/88 → 12/96 | 1.721 | B | M | 4 | 8 | B18EP | | 81574 |
| 1.7 Turbo | 88 | 08/88 → 07/96 | 1.721 | B | M | 4 | 8 | B18FT | | 81574 | |
| | 90 | 01/91 → 12/96 | 1.721 | B | M | 4 | 8 | B18FT | | 81574 | |
| 1.8 | 66 | 08/91 → 12/96 | 1.794 | B | M | 4 | 8 | B18U | | 81574 | |
| 1.9 Turbo-Diesel | 66 | 07/94 → 12/96 | 1.870 | D | M | 4 | 8 | D19T | | 81574 | |
| 2.0 | 80 | 08/93 → 07/96 | 1.998 | B | M | 4 | 8 | B20F | | 81574 | |
| | 81 | 08/92 → 07/95 | 1.998 | B | M | 4 | 8 | B20F | | 81574 | |

460

| | | | | | | | | | | | |
|------------------|-----|---------------|---------------|-------|---|---|---|-------|-------|-------|-------|
| 1.6 | 61 | 07/92 → 07/96 | 1.596 | B | M | 4 | 8 | B16F | | 81574 | |
| | 1.7 | 64 | 09/88 → 07/96 | 1.721 | B | M | 4 | 8 | B18KP | | 81574 |
| | | 66 | 09/90 → 07/96 | 1.721 | B | M | 4 | 8 | B18KP | | 81574 |
| | | 75 | 08/89 → 07/92 | 1.721 | B | M | 4 | 8 | B18EP | | 81574 |
| | | 80 | 08/89 → 07/92 | 1.721 | B | M | 4 | 8 | B18E | | 81574 |
| 1.7 Turbo | 88 | 08/89 → 07/96 | 1.721 | B | M | 4 | 8 | B18FT | | 81574 | |
| | 90 | 01/91 → 07/96 | 1.721 | B | M | 4 | 8 | B18FT | | 81574 | |
| 1.8 | 66 | 08/91 → 07/96 | 1.794 | B | M | 4 | 8 | B18U | | 81574 | |
| 1.9 Turbo-Diesel | 66 | 07/94 → 07/96 | 1.870 | D | M | 4 | 8 | D19T | | 81574 | |
| 2.0 | 80 | 08/93 → 07/96 | 1.998 | B | M | 4 | 8 | B20F | | 81574 | |
| | 81 | 08/92 → 07/95 | 1.998 | B | M | 4 | 8 | B20F | | 81574 | |

480

| | | | | | | | | | | |
|-----------|----|---------------|-------|---|---|---|---|-------|--|-------|
| 1.7 | 75 | 08/89 → 07/96 | 1.721 | B | M | 4 | 8 | B18EP | | 81574 |
| 1.7 Turbo | 88 | 08/87 → 07/96 | 1.721 | B | M | 4 | 8 | B18FT | | 81574 |
| | 90 | 01/91 → 07/96 | 1.721 | B | M | 4 | 8 | B18FT | | 81574 |
| 2.0 | 81 | 08/92 → 09/95 | 1.998 | B | M | 4 | 8 | B20F | | 81574 |

740, Station Wagon

| | | | | | | | | | | |
|-----------|-----|---------------|-------|---|---|---|----|--------------|--|-------|
| 2.0 | 76 | 09/88 → 08/90 | 1.986 | B | M | 4 | 8 | B200K | | 81594 |
| | 82 | 09/90 → 08/92 | 1.986 | B | M | 4 | 8 | B200F | | 81594 |
| | 89 | 08/85 → 07/92 | 1.986 | B | M | 4 | 8 | B200E, B200G | | 81594 |
| | 89 | 08/85 → 07/92 | 1.986 | B | M | 4 | 8 | B200G | | 81594 |
| | 118 | 01/86 → 08/90 | 1.986 | B | M | 4 | 8 | B200ET | | 81594 |
| 2.0 GLE | 103 | 09/87 → 08/90 | 1.986 | B | M | 4 | 16 | B204E | | 81594 |
| 2.0 Turbo | 114 | 09/90 → 08/91 | 1.986 | B | M | 4 | 8 | B200FT | | 81594 |
| | 115 | 09/87 → 08/90 | 1.986 | B | M | 4 | 8 | B200ET | | 81594 |

KW

cm³

NO. OF VALVES

VOLVO
740, Station Wagon

| | | | | | | | | | |
|------------------|-----|---------------|-------|---|---|---|----|----------------|-------|
| 2.3 | 84 | 08/84 → 07/90 | 2.316 | B | M | 4 | 8 | B230F, B23A | 81592 |
| | 84 | 09/85 → 07/90 | 2.316 | B | M | 4 | 8 | B230K | 81594 |
| | 85 | 08/87 → 07/92 | 2.316 | B | M | 4 | 8 | B230F | 81594 |
| | 100 | 08/88 → 07/90 | 2.316 | B | M | 4 | 8 | B230FB | 81594 |
| | 111 | 08/88 → 08/92 | 2.316 | B | M | 4 | 16 | B234F | 81594 |
| | 114 | 08/88 → 07/91 | 2.316 | B | M | 4 | 16 | B234F | 81594 |
| 2.3 Turbo | 121 | 08/89 → 07/90 | 2.316 | B | M | 4 | 8 | B230FT | 81594 |
| | 121 | 08/89 → 07/90 | 2.316 | B | M | 4 | 8 | B230FT, B230GT | 81594 |
| | 125 | 09/89 → 08/91 | 2.316 | B | M | 4 | 8 | B230FT, B230GT | 81594 |
| | 140 | 08/89 → 07/90 | 2.316 | B | M | 4 | 8 | B230FT | 81594 |
| 2.4 Diesel | 60 | 08/84 → 07/92 | 2.383 | D | M | 6 | 12 | D24 | 81593 |
| 2.4 TD | 80 | 08/85 → 12/90 | 2.383 | D | M | 6 | 12 | D24T | 81593 |
| | 83 | 08/84 → 07/90 | 2.383 | D | M | 6 | 12 | D24T | 81593 |
| 2.4 Turbo-Diesel | 80 | 09/85 → 07/92 | 2.383 | D | M | 6 | 12 | D24T | 81593 |

760, Station Wagon

| | | | | | | | | | |
|------------------|-----|---------------|-------|---|---|---|----|--------|-------|
| 2.3 | 121 | 01/88 → 07/92 | 2.316 | B | M | 4 | 8 | B230FT | 81594 |
| 2.3 Turbo | 115 | 09/87 → 08/90 | 2.316 | B | M | 4 | 8 | B230FT | 81594 |
| | 134 | 08/84 → 08/90 | 2.316 | B | M | 4 | 8 | B230ET | 81594 |
| 2.4 D | 60 | 01/82 → 07/92 | 2.383 | D | M | 6 | 12 | D24 | 81593 |
| 2.4 TD Interc. | 85 | 08/87 → 07/92 | 2.383 | D | M | 6 | 12 | D24TIC | 81593 |
| 2.4 Turbo Diesel | 80 | 04/87 → 07/92 | 2.383 | D | M | 6 | 12 | D24T | 81593 |

850, Station Wagon

| | | | | | | | | | |
|-------------|-----|---------------|-------|---|---|---|----|-----------------|-------|
| 2.0 | 93 | 08/94 → 12/96 | 1.984 | B | M | 5 | 10 | B5202S | 82056 |
| | 105 | 06/91 → 12/96 | 1.984 | B | M | 5 | 20 | B5204F | 82056 |
| 2.0 Turbo | 132 | 09/93 → 10/96 | 1.984 | B | M | 5 | 20 | B5204T2 | 82056 |
| | 155 | 08/93 → 12/96 | 1.984 | B | M | 5 | 20 | B5204FT, B5204T | 82056 |
| 2.3 | 106 | 01/96 → 10/96 | 2.319 | B | M | 5 | 20 | B5234FS | 82056 |
| 2.3 T5 | 166 | 08/93 → 07/96 | 2.319 | B | M | 5 | 20 | B5234FT | 82056 |
| 2.3 T5 R | 176 | 04/96 → 10/96 | 2.319 | B | M | 5 | 20 | B5234T2 | 82056 |
| | 184 | 08/95 → 12/96 | 2.319 | B | M | 5 | 20 | B5234T4 | 82056 |
| 2.3 Turbo R | 177 | 06/95 → 10/96 | 2.319 | B | M | 5 | 20 | B5234T5 | 82056 |
| 2.4 GLE | 142 | 09/93 → 10/97 | 2.435 | B | M | 5 | 20 | B5254T | 82056 |
| 2.5 | 103 | 06/91 → 07/94 | 2.435 | B | M | 5 | 10 | B5252 | 82056 |
| | 106 | 08/94 → 12/96 | 2.435 | B | M | 5 | 10 | B5252FS | 82056 |
| | 125 | 08/91 → 12/96 | 2.435 | B | M | 5 | 20 | B5254S | 82056 |
| 2.5 AWD | 142 | 04/96 → 12/96 | 2.435 | B | M | 5 | 20 | B5254T | 82056 |
| 2.5 TDI | 103 | 08/95 → 12/96 | 2.461 | D | M | 5 | 10 | D5252T | 81701 |

940 I, Station Wagon

| | | | | | | | | | |
|-----------|-----|---------------|-------|---|---|---|----|--------------|-------|
| 2.0 | 82 | 01/92 → 07/94 | 1.986 | B | M | 4 | 8 | B200F | 81594 |
| | 89 | 09/90 → 09/93 | 1.986 | B | M | 4 | 8 | B200E, B200G | 81594 |
| | 89 | 09/90 → 09/93 | 1.986 | B | M | 4 | 8 | B200G | 81594 |
| | 102 | 09/90 → 09/93 | 1.986 | B | M | 4 | 16 | B204FT | 81594 |
| 2.0 Turbo | 114 | 08/90 → 12/94 | 1.986 | B | M | 4 | 8 | B200FT | 81594 |

KW

cm³

NO. OF VALVES

VOLVO
940 I, Station Wagon

| | | | | | | | | | | |
|--------------------|-----|---------------|-------|---|---|---|----|---------------|---------------------------|-------|
| 2.3 | 85 | 08/92 → 07/94 | 2.316 | B | M | 4 | 8 | B230FD | | 81594 |
| | 96 | 08/90 → 12/94 | 2.316 | B | M | 4 | 8 | B230FB | | 81594 |
| | 96 | 08/90 → 12/94 | 2.316 | B | M | 4 | 8 | B230FB, B230G | | 81594 |
| | 114 | 08/90 → 07/91 | 2.316 | B | M | 4 | 16 | B234F | | 81594 |
| | 114 | 08/90 → 07/91 | 2.316 | B | M | 4 | 16 | B234F, B234G | | 81594 |
| 2.3 Turbo | 121 | 08/90 → 07/94 | 2.316 | B | M | 4 | 8 | B230FT | | 81594 |
| | 140 | 08/91 → 07/93 | 2.316 | B | M | 4 | 8 | B230FT+ | | 81594 |
| 2.4 D | 60 | 08/90 → 12/94 | 2.383 | D | M | 6 | 12 | D24 | | 81593 |
| 2.4 TD Intercooler | 90 | 08/90 → 12/94 | 2.383 | D | M | 6 | 12 | D24TIC | → 06-1992, → T: 30.003 | 81593 |
| | 90 | 08/90 → 12/94 | 2.383 | D | M | 6 | 12 | D24TIC | 07-1992 →, T →: 30.004 | 81701 |
| 2.4 Turbo Diesel | 80 | 08/90 → 12/94 | 2.383 | D | M | 6 | 12 | D24T | | 81593 |

940 II, Station Wagon

| | | | | | | | | | | |
|----------------|-----|---------------|-------|---|---|---|----|--------|--|-------|
| 2.0 | 89 | 11/94 → 12/95 | 1.986 | B | M | 4 | 8 | B200G | | 81594 |
| | 102 | 10/94 → 05/97 | 1.986 | B | M | 4 | 16 | B204FT | | 81594 |
| 2.0 Turbo | 114 | 04/96 → 10/98 | 1.986 | B | M | 4 | 8 | B200FT | | 81594 |
| 2.3 | 85 | 08/94 → 07/95 | 2.316 | B | M | 4 | 8 | B230FD | | 81594 |
| | 96 | 08/94 → 10/98 | 2.316 | B | M | 4 | 8 | B230FB | | 81594 |
| 2.3 ti | 99 | 01/95 → 10/98 | 2.316 | B | M | 4 | 8 | B230FK | | 81594 |
| 2.3 Turbo | 121 | 08/94 → 10/98 | 2.316 | B | M | 4 | 8 | B230FT | | 81594 |
| | 126 | 08/95 → 10/98 | 2.316 | B | M | 4 | 8 | B230FT | | 81594 |
| 2.4 TD Interc. | 90 | 08/94 → 10/98 | 2.383 | D | M | 6 | 12 | D24TIC | | 81701 |

960 I, Station Wagon

| | | | | | | | | | | |
|----------------|-----|---------------|-------|---|---|---|----|----------------------------|---------------------------|-------|
| 2.0 | 103 | 09/90 → 08/93 | 1.986 | B | M | 4 | 16 | B204E | | 81594 |
| | 140 | 08/90 → 09/93 | 1.986 | B | M | 4 | 16 | B204FT | | 81594 |
| 2.3 Turbo | 121 | 09/90 → 08/93 | 2.316 | B | M | 4 | 8 | B230FT | | 81594 |
| 2.4 TD Interc. | 85 | 09/91 → 07/94 | 2.383 | D | M | 6 | 12 | D24TIC | → 06-1992, → T: 30.003 | 81593 |
| | 85 | 09/91 → 07/94 | 2.383 | D | M | 6 | 12 | D24TIC | 07-1992 →, T →: 30.004 | 81701 |
| 2.9 | 150 | 08/90 → 07/94 | 2.922 | B | M | 6 | 24 | B6304F, B6304FS, B6304G | | 81857 |
| | 150 | 08/90 → 07/94 | 2.922 | B | M | 6 | 24 | B6304F, B6304S | | 81857 |

960 II, Station Wagon

| | | | | | | | | | | |
|-----|-----|---------------|-------|---|---|---|----|--------|-------------------------|-------|
| 2.5 | 125 | 07/94 → 12/96 | 2.473 | B | M | 6 | 24 | B6254S | | 81857 |
| | 125 | 08/94 → 12/96 | 2.473 | B | M | 6 | 24 | B6254S | 07-1994 →, → 10-1996 | 81857 |
| 2.9 | 150 | 07/94 → 12/96 | 2.922 | B | M | 6 | 24 | B6304S | | 81857 |

C 30

| | | | | | | | | | | |
|--------|----|---------------|-------|---|---|---|----|----------|--|-------|
| 1.6 | 74 | 10/06 → 12/12 | 1.596 | B | M | 4 | 16 | B4164S3 | | 81598 |
| 1.6 D | 80 | 10/06 → 12/12 | 1.560 | D | M | 4 | 16 | D4164T | | 81869 |
| 1.6 D2 | 84 | 10/10 → 12/12 | 1.560 | D | M | 4 | 8 | D4162T | | 81869 |
| 1.8 | 92 | 10/06 → 12/12 | 1.798 | B | M | 4 | 16 | B4184S11 | | 81804 |

KW

cm³

NO. OF VALVES

VOLVO

| C 30 | | | | | | | | | | |
|------------------------------|-----|---------------|-------|---|---|---|----|-------------------|--|-------|
| 1.8 FlexFuel | 92 | 01/07 → 12/12 | 1.798 | | M | 4 | 16 | B4184S8 | | 81804 |
| 2.0 | 107 | 10/06 → 12/12 | 1.999 | B | M | 4 | 16 | B4204S3 | | 81804 |
| 2.0 D | 100 | 10/06 → 12/12 | 1.998 | D | M | 4 | 16 | D4204T | | 81800 |
| 2.0 FlexFuel | 107 | 01/10 → 12/12 | 1.999 | | M | 4 | 16 | B4204S4 | | 81804 |
| 2.4 i | 125 | 10/06 → 12/12 | 2.435 | B | M | 5 | 20 | B5244S4 | | 82056 |
| D3 | 110 | 10/10 → 12/12 | 1.984 | D | M | 5 | 20 | D5204T5 | | 81864 |
| D4 | 130 | 10/10 → 12/12 | 1.984 | D | M | 5 | 20 | D5204T | | 81864 |
| D5 | 120 | 10/06 → 12/12 | 2.400 | D | M | 5 | 20 | D5244T9 | | 81864 |
| | 132 | 10/06 → 12/12 | 2.400 | D | M | 5 | 20 | D5244T13, D5244T8 | | 81864 |
| T5 | 162 | 10/06 → 12/12 | 2.521 | B | M | 5 | 20 | B5254T3 | | 82056 |
| | 169 | 03/07 → 12/12 | 2.521 | B | M | 5 | 20 | B5254T7 | | 82056 |
| C 70 I, Cabrio, Coupé | | | | | | | | | | |
| 2.0 | 132 | 03/98 → 10/05 | 1.984 | B | M | 5 | 20 | B5204T2 | | 82056 |
| 2.0 T | 120 | 03/00 → 10/05 | 1.984 | B | M | 5 | 20 | B5204T4 | | 82056 |
| | 166 | 03/98 → 10/05 | 1.984 | B | M | 5 | 20 | B5204T3 | | 82056 |
| 2.3 T5 | 176 | 03/98 → 10/05 | 2.319 | B | M | 5 | 20 | B5234T3 | | 82056 |
| | 180 | 07/02 → 10/05 | 2.319 | B | M | 5 | 20 | B5234T9 | | 82056 |
| 2.3 T-5 | 176 | 03/97 → 09/02 | 2.319 | B | M | 5 | 20 | B5234T3 | | 82056 |
| 2.4 T | 147 | 07/02 → 10/05 | 2.435 | B | M | 5 | 20 | B5244T7 | | 82056 |
| 2.5 | 121 | 03/99 → 09/02 | 2.435 | B | M | 5 | 20 | B5254S | | 82056 |
| | 125 | 05/99 → 09/02 | 2.435 | B | M | 5 | 20 | B5244S, B5254S | | 82056 |
| | 125 | 06/98 → 10/05 | 2.435 | B | M | 5 | 20 | B5254S | | 82056 |
| 2.5 T | 142 | 03/98 → 10/05 | 2.435 | B | M | 5 | 20 | B5244T, B5254T | | 82056 |
| C 70 II | | | | | | | | | | |
| 2.0 D | 100 | 01/08 → 10/09 | 1.997 | D | M | 4 | 16 | D4204T | | 81800 |
| 2.4 | 103 | 03/06 → 10/09 | 2.435 | B | M | 5 | 20 | B5244S5 | | 82056 |
| 2.4 D | 120 | 03/07 → 06/13 | 2.400 | D | M | 5 | 20 | D5244T9 | | 81864 |
| 2.4 i | 125 | 03/06 → 10/09 | 2.435 | B | M | 5 | 20 | B5244S4 | | 82056 |
| D3 | 110 | 10/10 → 06/13 | 1.984 | D | M | 5 | 20 | D5204T5 | | 81864 |
| D4 | 130 | 10/10 → 06/13 | 1.984 | D | M | 5 | 20 | D5204T | | 81864 |
| D5 | 132 | 03/06 → 06/13 | 2.400 | D | M | 5 | 20 | D5244T13, D5244T8 | | 81864 |
| T5 | 162 | 03/06 → 02/07 | 2.521 | B | M | 5 | 20 | B5254T3 | | 82056 |
| | 169 | 03/07 → 10/09 | 2.521 | B | M | 5 | 20 | B5254T7 | | 82056 |
| S 40 I | | | | | | | | | | |
| 1.6 | 80 | 03/99 → 12/03 | 1.587 | B | M | 4 | 16 | B4164S2 | | 82056 |
| | 77 | 09/95 → 08/99 | 1.588 | B | M | 4 | 16 | B4164S | | 82056 |
| 1.8 | 85 | 07/95 → 08/99 | 1.731 | B | M | 4 | 16 | B4184S, B4184S3 | | 82056 |
| | 85 | 06/01 → 08/03 | 1.783 | | M | 4 | 16 | B4184S2 | | 82056 |
| | 90 | 03/99 → 12/03 | 1.783 | B | M | 4 | 16 | B4184S2, B4184S9 | | 82056 |
| 1.8 i | 90 | 06/01 → 12/03 | 1.834 | B | M | 4 | 16 | B4184SJ | | 82056 |

KW

cm³

NO. OF VALVES

MAGNETI MARELLI
VOLVO
S 40 I

| | | | | | | | | | | |
|--------|-----|---------------|-------|---|---|---|----|------------------|-----------|-------|
| 1.9 DI | 70 | 03/99 → 07/00 | 1.870 | D | M | 4 | 8 | D4192T2 | | 81574 |
| | 75 | 07/00 → 12/03 | 1.870 | D | M | 4 | 8 | D4192T4 | | 81814 |
| | 75 | 07/00 → 12/03 | 1.870 | D | M | 4 | 8 | D4192T4 | | 84009 |
| | 85 | 07/00 → 12/03 | 1.870 | D | M | 4 | 8 | D4192T3 | | 81814 |
| | 85 | 07/00 → 12/03 | 1.870 | D | M | 4 | 8 | D4192T3 | | 84009 |
| 1.9 T4 | 147 | 05/97 → 07/00 | 1.855 | B | M | 4 | 16 | B4194T, B4194T2 | | 82056 |
| 1.9 TD | 66 | 07/95 → 08/99 | 1.870 | D | M | 4 | 8 | D4192T | 01-1997 → | 81574 |
| 2.0 | 100 | 07/95 → 12/03 | 1.948 | B | M | 4 | 16 | B4204S, B4204S2 | 11-1995 → | 82056 |
| | 100 | 07/95 → 12/03 | 1.948 | B | M | 4 | 16 | B4204S, B4204S2 | | 82056 |
| | 103 | 07/95 → 08/99 | 1.948 | B | M | 4 | 16 | B4204S | 11-1995 → | 82056 |
| | 103 | 07/95 → 08/99 | 1.948 | B | M | 4 | 16 | B4204S | | 82056 |
| 2.0 T | 118 | 10/97 → 12/03 | 1.948 | B | M | 4 | 16 | B4204T | | 82056 |
| | 120 | 06/01 → 12/03 | 1.948 | B | M | 4 | 16 | B4204T3 | | 82056 |
| | 121 | 07/00 → 06/01 | 1.948 | B | M | 4 | 16 | B4204T2, B4204T3 | | 82056 |
| 2.0 T4 | 147 | 07/00 → 12/03 | 1.948 | B | M | 4 | 16 | B4204T5 | | 82056 |

S 40 II

| | | | | | | | | | | |
|--------------|-----|---------|-------|----|---|---|----|-------------------|--|-------|
| 1.6 | 74 | 01/05 → | 1.596 | B | M | 4 | 16 | B4164S3 | | 82056 |
| 1.6 D | 81 | 01/05 → | 1.560 | D | M | 4 | 16 | D4164T | | 81869 |
| 1.6 D2 | 84 | 10/10 → | 1.560 | D | M | 4 | 8 | D4162T | | 81869 |
| 1.8 | 92 | 04/04 → | 1.798 | B | M | 4 | 16 | B4184S11 | | 82056 |
| 1.8 FlexFuel | 92 | 01/06 → | 1.798 | | M | 4 | 16 | B4184S8 | | 82056 |
| 2.0 | 107 | 10/06 → | 1.999 | B | M | 4 | 16 | B4204S3 | | 81804 |
| 2.0 D | 100 | 01/04 → | 1.998 | D | M | 4 | 16 | D4204T | | 81800 |
| 2.0 D4 | 96 | 07/05 → | 1.998 | D | M | 4 | 16 | D4204T2 | | 81800 |
| 2.0 F | 107 | 10/09 → | 1.999 | FF | M | 4 | 16 | B4204S4 | | 81804 |
| 2.4 | 103 | 01/04 → | 2.435 | B | M | 5 | 20 | B5244S5 | | 82056 |
| | 125 | 01/04 → | 2.435 | B | M | 5 | 20 | B5244S4 | | 82056 |
| 2.4 AWD | 125 | 08/06 → | 2.435 | B | M | 5 | 20 | B5244S4 | | 82056 |
| 2.4 D5 | 132 | 03/06 → | 2.400 | D | M | 5 | 20 | D5244T13, D5244T8 | | 81864 |
| D3 | 110 | 10/10 → | 1.984 | D | M | 5 | 20 | D5204T5 | | 81864 |
| D4 | 130 | 10/10 → | 1.984 | D | M | 5 | 20 | D5204T | | 81864 |
| T5 | 162 | 01/04 → | 2.521 | B | M | 5 | 20 | B5254T3 | | 82056 |
| | 169 | 03/07 → | 2.521 | B | M | 5 | 20 | B5254T7 | | 82056 |
| T5 AWD | 162 | 04/04 → | 2.521 | B | M | 5 | 20 | B5254T3 | | 82056 |
| | 169 | 03/07 → | 2.521 | B | M | 5 | 20 | B5254T7 | | 82056 |

S 60 I

| | | | | | | | | | | |
|------------|-----|---------------|-------|----|----|---|----|----------|--|-------|
| 2.0 T | 132 | 07/00 → 04/10 | 1.984 | B | M | 5 | 20 | B5204T5 | | 82056 |
| 2.3 T5 | 195 | 07/00 → 09/02 | 2.319 | B | M | 5 | 20 | B5234T7 | | 82056 |
| 2.4 | 103 | 11/00 → 04/10 | 2.435 | B | AM | 5 | 20 | B5244S2 | | 82056 |
| | 125 | 11/00 → 04/10 | 2.435 | B | AM | 5 | 20 | B5244S | | 82056 |
| 2.4 AWD | 191 | 02/04 → 04/10 | 2.401 | B | M | 5 | 20 | B5244T5 | | 82056 |
| 2.4 Bifuel | 103 | 06/02 → 04/10 | 2.435 | BF | M | 5 | 20 | B5244SG | | 82056 |
| | 103 | 06/02 → 04/10 | 2.435 | BF | M | 5 | 20 | B5244SG2 | | 82056 |

KW

cm³

NO. OF VALVES

MAGNETI MARELLI
VOLVO
S 60 I

| | | | | | | | | | |
|-------------|-----|---------------|-------|---|----|---|----|---------|-------|
| 2.4 D | 93 | 09/05 → 04/10 | 2.400 | D | M | 5 | 20 | D5244T7 | 81864 |
| | 120 | 09/05 → 01/09 | 2.400 | D | M | 5 | 20 | D5244T5 | 81864 |
| | 96 | 12/01 → 04/10 | 2.401 | D | M | 5 | 20 | D5244T2 | 81864 |
| 2.4 D5 | 120 | 07/01 → 04/10 | 2.401 | D | M | 5 | 20 | D5244T | 81864 |
| | 136 | 09/05 → 04/10 | 2.401 | D | M | 5 | 20 | D5244T4 | 81864 |
| 2.4 T | 147 | 11/00 → 04/10 | 2.435 | B | M | 5 | 20 | B5244T3 | 82056 |
| 2.4 T AWD | 147 | 11/01 → 04/10 | 2.435 | B | M | 5 | 20 | B5244T3 | 82056 |
| 2.4 T5 | 191 | 04/04 → 04/10 | 2.401 | B | M | 5 | 20 | B5244T5 | 82056 |
| 2.5 T | 154 | 02/04 → 04/10 | 2.521 | B | M | 5 | 20 | B5254T2 | 82056 |
| 2.5 T AWD | 154 | 04/04 → 04/10 | 2.521 | B | M | 5 | 20 | B5254T2 | 82056 |
| R 2,5 T AWD | 221 | 03/03 → 04/10 | 2.521 | B | M | 5 | 20 | B5254T4 | 82056 |
| T5 | 184 | 11/00 → 04/10 | 2.319 | B | AM | 5 | 20 | B5234T3 | 82056 |

S 60 II

| | | | | | | | | | |
|------------|-----|---------------|-------|----|---|---|----|--------------------|-------|
| 2.0 T | 132 | 12/13 → | 1.984 | B | M | 5 | 20 | B5204T8 | 82056 |
| | 149 | 04/10 → | 1.999 | B | M | 4 | 16 | B4204T6 | 81804 |
| 2.4 D4 AWD | 140 | 03/15 → | 2.400 | D | M | 5 | 20 | D5244T21 | 81864 |
| 2.5 T5 | 186 | 09/11 → | 2.521 | B | M | 5 | 20 | B5254T5 | 82056 |
| 2.5 T5 AWD | 186 | 09/12 → | 2.521 | B | M | 5 | 20 | B5254T5 | 82056 |
| D3 | 100 | 05/12 → | 1.984 | D | M | 5 | 20 | D5204T7 | 81864 |
| | 120 | 04/10 → 04/12 | 1.984 | D | M | 5 | 20 | D5204T2, D5204T3 | 81864 |
| D4 | 120 | 05/12 → | 1.984 | D | M | 5 | 20 | D5204T3 | 81864 |
| D5 | 151 | 04/10 → | 2.400 | D | M | 5 | 20 | D5244T10 | 81864 |
| | 158 | 06/11 → | 2.400 | D | M | 5 | 20 | D5244T11, D5244T15 | 81864 |
| | 169 | 04/14 → | 2.400 | D | M | 5 | 20 | D5244T15, D5244T23 | 81864 |
| D5 AWD | 151 | 04/10 → | 2.400 | D | M | 5 | 20 | D5244T10 | 81864 |
| | 158 | 06/11 → | 2.400 | D | M | 5 | 20 | D5244T15 | 81864 |
| | 169 | 04/14 → | 2.400 | D | M | 5 | 20 | D5244T15, D5244T23 | 81864 |
| DRIVE / D2 | 84 | 01/11 → | 1.560 | D | M | 4 | 8 | D4162T | 81869 |
| T3 | 110 | 04/10 → | 1.596 | B | M | 4 | 16 | B4164T3 | 82027 |
| T4 | 132 | 04/10 → | 1.596 | B | M | 4 | 16 | B4164T | 82027 |
| T4F | 132 | 04/11 → | 1.596 | FF | M | 4 | 16 | B4164T2 | 82027 |
| T5 | 177 | 04/10 → | 1.999 | B | M | 4 | 16 | B4204T7 | 81804 |
| T6 AWD | 224 | 04/10 → | 2.953 | B | M | 6 | 24 | B6304T4 | 81804 |

S 70

| | | | | | | | | | |
|------------|-----|---------------|-------|---|---|---|----|-----------------|-------|
| 2.0 | 93 | 01/97 → 11/00 | 1.984 | B | M | 5 | 10 | B5202FS, B5202S | 82056 |
| | 105 | 01/97 → 11/00 | 1.984 | B | M | 5 | 20 | B5204F | 82056 |
| | 120 | 01/97 → 11/00 | 1.984 | B | M | 5 | 20 | B5204T4 | 82056 |
| | 132 | 01/97 → 11/00 | 1.984 | B | M | 5 | 20 | B5204T2 | 82056 |
| 2.0 Turbo | 155 | 01/97 → 11/00 | 1.984 | B | M | 5 | 20 | B5204T | 82056 |
| | 166 | 01/97 → 11/00 | 1.984 | B | M | 5 | 20 | B5204T3 | 82056 |
| 2.3 | 195 | 04/99 → 09/00 | 2.319 | B | M | 5 | 20 | B5234T7 | 82056 |
| 2.3 T-5 | 176 | 01/97 → 11/00 | 2.319 | B | M | 5 | 20 | B5234T3 | 82056 |
| 2.3 T5 AWD | 177 | 11/96 → 09/98 | 2.319 | B | M | 5 | 20 | B5234T3 | 82056 |
| | 184 | 07/97 → 09/00 | 2.319 | B | M | 5 | 20 | B5234T4 | 82056 |

| | | | | | | | | | | |
|--|--|-----------|--|-----------------------|--|--|--|----------------------|--|--|
| | | KW | | cm³ | | | | NO. OF VALVES | | |
|--|--|-----------|--|-----------------------|--|--|--|----------------------|--|--|

VOLVO
S 70

| | | | | | | | | | | |
|--------------|-----|---------------|-------|----|---|---|----|------------------|--|-------|
| 2.3 Turbo | 184 | 01/97 → 11/00 | 2.319 | B | M | 5 | 20 | B5234FT+ | | 82056 |
| 2.4 | 103 | 08/99 → 11/00 | 2.435 | B | M | 5 | 20 | B5244S2, B5244SG | | 82056 |
| | 125 | 01/97 → 11/00 | 2.435 | B | M | 5 | 20 | B5244S, B5254S | | 82056 |
| 2.4 AWD | 103 | 04/99 → 09/00 | 2.435 | B | M | 5 | 20 | B5244S2 | | 82056 |
| | 106 | 11/96 → 05/99 | 2.435 | B | M | 5 | 10 | B5252FS | | 82056 |
| | 121 | 10/98 → 05/99 | 2.435 | B | M | 5 | 20 | B5254S | | 82056 |
| | 125 | 04/99 → 09/00 | 2.435 | B | M | 5 | 20 | B5244S | | 82056 |
| 2.4 Blu-Fuel | 103 | 07/97 → 09/00 | 2.435 | G | M | 5 | 20 | B5244S2, B5244SG | | 82056 |
| 2.4 T5 AWD | 142 | 11/96 → 04/99 | 2.435 | B | M | 5 | 20 | B5254T | | 82056 |
| 2.4 Turbo | 142 | 01/97 → 11/00 | 2.435 | B | M | 5 | 20 | B5244T, B5254T | | 82056 |
| 2.5 | 106 | 01/97 → 11/00 | 2.435 | B | M | 5 | 10 | B5252FS | | 82056 |
| | 121 | 06/98 → 11/00 | 2.435 | B | M | 5 | 20 | B5254S | | 82056 |
| 2.5 Bifuel | 103 | 07/99 → 11/00 | 2.435 | BF | A | 5 | 20 | B5244SG | | 82056 |
| | 106 | 10/98 → 11/00 | 2.435 | BF | M | 5 | 10 | GB5252S | | 82056 |
| 2.5 TDI | 103 | 01/97 → 11/00 | 2.461 | D | M | 5 | 10 | D5252T | | 81701 |

S 80 I

| | | | | | | | | | | |
|------------|-----|---------------|-------|----|---|---|----|----------|-----------|-------|
| 2.0 | 120 | 06/98 → 07/06 | 1.984 | B | M | 5 | 20 | B5204T4 | | 82056 |
| 2.0 T | 132 | 12/99 → 07/06 | 1.984 | B | M | 5 | 20 | B5204T5 | | 82056 |
| | 166 | 06/98 → 07/06 | 1.984 | B | M | 5 | 20 | B5204T3 | | 82056 |
| 2.4 | 103 | 01/99 → 07/06 | 2.435 | B | M | 5 | 20 | B5244S2 | | 82056 |
| | 125 | 01/99 → 07/06 | 2.435 | B | M | 5 | 20 | B5244S | | 82056 |
| 2.4 Bifuel | 103 | 09/01 → 07/06 | 2.435 | BF | M | 5 | 20 | B5244SG | | 82056 |
| | 103 | 09/01 → 07/06 | 2.435 | BF | M | 5 | 20 | B5244SG2 | | 82056 |
| 2.4 D | 96 | 10/01 → 07/06 | 2.401 | D | M | 5 | 20 | D5244T2 | | 81864 |
| 2.4 D5 | 120 | 08/01 → 07/06 | 2.401 | D | M | 5 | 20 | D5244T | | 81864 |
| 2.4 LTP | 132 | 06/04 → 07/06 | 2.435 | B | M | 5 | 20 | B5244T4 | | 82056 |
| 2.4 T | 147 | 06/00 → 07/06 | 2.435 | B | M | 5 | 20 | B5244T3 | | 82056 |
| 2.4 T5 AWD | 147 | 04/00 → 09/03 | 2.435 | B | M | 5 | 20 | B5244T3 | | 82056 |
| 2.5 T | 154 | 03/03 → 07/06 | 2.521 | B | M | 5 | 20 | B5254T2 | | 82056 |
| 2.5 T AWD | 154 | 07/03 → 07/06 | 2.521 | B | M | 5 | 20 | B5254T2 | | 82056 |
| 2.5 TDI | 103 | 01/99 → 07/06 | 2.461 | D | M | 5 | 10 | D5252T | → 12-2002 | 81701 |
| 2.8 T6 | 200 | 05/98 → 07/06 | 2.783 | B | M | 6 | 24 | B6284T | → 12-2002 | 81779 |
| | 200 | 05/98 → 07/06 | 2.783 | B | M | 6 | 24 | B6284T | 01-2003 → | 81864 |
| 2.9 | 147 | 03/99 → 07/06 | 2.922 | B | M | 6 | 24 | B6294S | → 12-2002 | 81779 |
| | 147 | 03/99 → 07/06 | 2.922 | B | M | 6 | 24 | B6294S | 01-2003 → | 81864 |
| | 150 | 05/98 → 07/06 | 2.922 | B | M | 6 | 24 | B6304S3 | → 12-2002 | 81779 |
| | 150 | 05/98 → 07/06 | 2.922 | B | M | 6 | 24 | B6304S3 | 01-2003 → | 81864 |
| 3.0 | 144 | 06/01 → 07/06 | 2.922 | B | M | 6 | 24 | B6294S2 | → 12-2002 | 81779 |
| | 144 | 06/01 → 07/06 | 2.922 | B | M | 6 | 24 | B6294S2 | 01-2003 → | 81864 |
| 3.0 T6 | 200 | 06/01 → 07/06 | 2.922 | B | M | 6 | 24 | B6294T | → 12-2002 | 81779 |
| | 200 | 06/01 → 07/06 | 2.922 | B | M | 6 | 24 | B6294T | 01-2003 → | 81864 |

KW

cm³

NO. OF VALVES

MAGNETI MARELLI
VOLVO
S 80 II

| | | | | | | | | | | |
|----------------|-----|---------|-------|----|---|---|----|--------------------|--|-------|
| 1.6 D DRiVe | 80 | 01/10 → | 1.560 | D | M | 4 | 16 | D4164T | | 81869 |
| 1.6 DRiVe | 84 | 06/11 → | 1.560 | D | M | 4 | 8 | D4162T | | 81869 |
| 2.0 | 107 | 01/08 → | 1.999 | B | M | 4 | 16 | B4204S3 | | 81804 |
| 2.0 FlexFuel | 107 | 01/08 → | 1.999 | | M | 4 | 16 | B4204S4 | | 81804 |
| 2.0 T | 149 | 01/10 → | 1.999 | B | M | 4 | 16 | B4204T6 | | 81804 |
| 2.0 TDi | 100 | 02/08 → | 1.997 | D | M | 4 | 16 | D4204T | | 81800 |
| 2.4 D | 120 | 03/06 → | 2.400 | D | M | 5 | 20 | D5244T, D5244T5 | | 81864 |
| | 129 | 01/10 → | 2.400 | D | M | 5 | 20 | D5244T14 | | 81864 |
| 2.5 T | 183 | 09/12 → | 2.497 | B | M | 5 | 20 | B5254T14 | | 82056 |
| | 187 | 01/12 → | 2.497 | B | M | 5 | 20 | B5254T12 | | 82056 |
| | 147 | 03/06 → | 2.521 | B | M | 5 | 20 | B5254T6 | | 82056 |
| | 170 | 01/10 → | 2.521 | B | M | 5 | 20 | B5254T10 | | 82056 |
| 2.5 T AWD | 147 | 10/06 → | 2.521 | B | M | 5 | 20 | B5254T6 | | 82056 |
| 2.5 T FlexFuel | 147 | 05/08 → | 2.521 | | M | 5 | 20 | B5254T8 | | 82056 |
| | 170 | 01/10 → | 2.521 | | M | 5 | 20 | B5254T11 | | 82056 |
| D3 | 100 | 05/12 → | 1.984 | D | M | 5 | 20 | D5204T7 | | 81864 |
| D3 / D4 | 120 | 01/10 → | 1.984 | D | M | 5 | 20 | D5204T2, D5204T3 | | 81864 |
| D5 | 136 | 03/06 → | 2.400 | D | M | 5 | 20 | D5244T4 | | 81864 |
| | 151 | 01/10 → | 2.400 | D | M | 5 | 20 | D5244T10 | | 81864 |
| | 158 | 06/11 → | 2.400 | D | M | 5 | 20 | D5244T11, D5244T15 | | 81864 |
| D5 AWD | 136 | 01/07 → | 2.400 | D | M | 5 | 20 | D5244T4 | | 81864 |
| | 151 | 01/10 → | 2.400 | D | M | 5 | 20 | D5244T10 | | 81864 |
| | 158 | 06/11 → | 2.400 | D | M | 5 | 20 | D5244T15 | | 81864 |
| T4 | 132 | 10/10 → | 1.596 | B | M | 4 | 16 | B4164T | | 82027 |
| T4F | 132 | 05/11 → | 1.596 | FF | M | 4 | 16 | B4164T2 | | 82027 |
| T5 | 177 | 10/10 → | 1.999 | B | M | 4 | 16 | B4204T7 | | 81804 |

S 90

| | | | | | | | | | | |
|-----|-----|---------------|-------|---|---|---|----|---------|-----------|-------|
| 2.5 | 125 | 11/96 → 10/98 | 2.473 | B | M | 6 | 24 | B6254FS | | 81857 |
| | 132 | 11/96 → 10/97 | 2.473 | B | M | 6 | 24 | B6244FS | | 81857 |
| 2.9 | 132 | 01/97 → 05/98 | 2.922 | B | M | 6 | 24 | B6304S2 | 11-1996 → | 81857 |
| | 150 | 01/97 → 05/98 | 2.922 | B | M | 6 | 24 | B6304G | | 81857 |

V 40 I

| | | | | | | | | | | |
|--------|-----|---------------|-------|---|---|---|----|------------------|--|-------|
| 1.6 | 80 | 03/99 → 06/04 | 1.587 | B | M | 4 | 16 | B4164S2 | | 82056 |
| | 77 | 12/95 → 08/99 | 1.588 | B | M | 4 | 16 | B4164S | | 82056 |
| 1.8 | 85 | 07/95 → 08/99 | 1.731 | B | M | 4 | 16 | B4184S, B4184S3 | | 82056 |
| | 90 | 03/99 → 06/04 | 1.783 | B | M | 4 | 16 | B4184S2, B4184S9 | | 82056 |
| 1.8 i | 90 | 06/01 → 06/04 | 1.834 | B | M | 4 | 16 | B4184SJ | | 82056 |
| 1.9 DI | 70 | 03/99 → 07/00 | 1.870 | D | M | 4 | 8 | D4192T2 | | 81574 |
| | 75 | 07/00 → 06/04 | 1.870 | D | M | 4 | 8 | D4192T4 | | 81814 |
| | 75 | 07/00 → 06/04 | 1.870 | D | M | 4 | 8 | D4192T4 | | 84009 |
| | 85 | 07/00 → 06/04 | 1.870 | D | M | 4 | 8 | D4192T3 | | 81814 |
| | 85 | 07/00 → 06/04 | 1.870 | D | M | 4 | 8 | D4192T3 | | 84009 |
| 1.9 T4 | 147 | 05/97 → 07/00 | 1.855 | B | M | 4 | 16 | B4194T | | 82056 |
| 1.9 TD | 66 | 07/95 → 08/99 | 1.870 | D | M | 4 | 8 | D4192T | | 81574 |

KW

cm³

NO. OF VALVES

MAGNETI MARELLI
VOLVO
V 40 I

| | | | | | | | | | | |
|--------|-----|---------------|-------|---|---|---|----|-----------------|--|-------|
| 2.0 | 100 | 07/95 → 06/04 | 1.948 | B | M | 4 | 16 | B4204S, B4204S2 | | 82056 |
| | 103 | 07/95 → 08/99 | 1.948 | B | M | 4 | 16 | B4204S | | 82056 |
| 2.0 T | 118 | 10/97 → 07/00 | 1.948 | B | M | 4 | 16 | B4204T | | 82056 |
| | 120 | 06/01 → 06/04 | 1.948 | B | M | 4 | 16 | B4204T3 | | 82056 |
| | 121 | 07/99 → 06/04 | 1.948 | B | M | 4 | 16 | B4204T2 | | 82056 |
| 2.0 T4 | 147 | 07/00 → 06/04 | 1.948 | B | M | 4 | 16 | B4204T5 | | 82056 |

V 40 II

| | | | | | | | | | | |
|---------|-----|---------------|-------|---|---|---|----|----------|--|-------|
| D2 | 84 | 03/12 → | 1.560 | D | M | 4 | 8 | D4162T | | 81869 |
| D3 | 110 | 03/12 → 03/15 | 1.984 | D | M | 5 | 20 | D5204T6 | | 81864 |
| D4 | 130 | 03/12 → | 1.984 | D | M | 5 | 20 | D5204T4 | | 81864 |
| T2 GTDi | 88 | 03/13 → | 1.596 | B | M | 4 | 16 | B4164T4 | | 82027 |
| | 88 | 03/13 → | 1.596 | B | M | 4 | 16 | B4164T4 | | 81598 |
| T3 GTDi | 110 | 03/12 → | 1.596 | B | M | 4 | 16 | B4164T3 | | 82027 |
| | 110 | 03/12 → | 1.596 | B | M | 4 | 16 | B4164T3 | | 81598 |
| T4 | 147 | 04/14 → | 1.596 | B | M | 4 | 16 | B4164T | | 82027 |
| | 132 | 07/13 → | 1.984 | B | M | 5 | 20 | B5204T8 | | 82056 |
| T4 AWD | 132 | 07/13 → | 1.984 | B | M | 5 | 20 | B5204T8 | | 82056 |
| T4 GTDi | 132 | 03/12 → | 1.596 | B | M | 4 | 16 | B4164T | | 82027 |
| | 132 | 03/12 → | 1.596 | B | M | 4 | 16 | B4164T | | 81598 |
| T5 | 157 | 03/13 → | 1.984 | B | M | 5 | 20 | B5204T9 | | 82056 |
| | 183 | 01/14 → | 2.497 | B | M | 5 | 20 | B5254T14 | | 82056 |
| | 187 | 12/12 → | 2.497 | B | M | 5 | 20 | B5254T12 | | 82056 |
| T5 AWD | 157 | 03/13 → | 1.984 | B | M | 5 | 20 | B5204T9 | | 82056 |
| | 187 | 01/13 → | 2.497 | B | M | 5 | 20 | B5254T12 | | 82056 |

V 50

| | | | | | | | | | | |
|--------------|-----|---------|-------|---|---|---|----|-------------------|--|-------|
| 1.6 | 74 | 01/05 → | 1.596 | B | M | 4 | 16 | B4164S3 | | 81598 |
| 1.6 D | 81 | 01/05 → | 1.560 | D | M | 4 | 16 | D4164T | | 81869 |
| 1.6 D2 | 84 | 01/10 → | 1.560 | D | M | 4 | 8 | D4162T | | 81869 |
| 1.8 | 92 | 04/04 → | 1.798 | B | M | 4 | 16 | B4184S11 | | 81804 |
| 1.8 FlexFuel | 92 | 01/05 → | 1.798 | | M | 4 | 16 | B4184S8 | | 81804 |
| 2.0 | 107 | 10/06 → | 1.999 | B | M | 4 | 16 | B4204S3 | | 81804 |
| 2.0 D | 100 | 04/04 → | 1.998 | D | M | 4 | 16 | D4204T | | 81800 |
| 2.0 FlexFuel | 107 | 01/10 → | 1.999 | | M | 4 | 16 | B4204S4 | | 81804 |
| 2.4 | 103 | 04/04 → | 2.435 | B | M | 5 | 20 | B5244S5 | | 82056 |
| | 125 | 04/04 → | 2.435 | B | M | 5 | 20 | B5244S4 | | 82056 |
| 2.4 AWD | 125 | 08/06 → | 2.435 | B | M | 5 | 20 | B5244S4 | | 82056 |
| 2.4 D5 | 132 | 03/06 → | 2.400 | D | M | 5 | 20 | D5244T13, D5244T8 | | 81864 |
| 2.4 Tdi | 120 | 05/07 → | 2.400 | D | M | 5 | 20 | D5244T9 | | 81864 |
| D3 | 110 | 10/10 → | 1.984 | D | M | 5 | 20 | D5204T5 | | 81864 |
| D4 | 130 | 10/10 → | 1.984 | D | M | 5 | 20 | D5204T | | 81864 |
| T5 | 162 | 04/04 → | 2.521 | B | M | 5 | 20 | B5254T3 | | 82056 |
| | 169 | 03/07 → | 2.521 | B | M | 5 | 20 | B5254T7 | | 82056 |
| T5 AWD | 162 | 04/04 → | 2.521 | B | M | 5 | 20 | B5254T3 | | 82056 |
| | 169 | 03/07 → | 2.521 | B | M | 5 | 20 | B5254T7 | | 82056 |

KW

cm³

NO. OF VALVES

VOLVO

| V 60 | | | | | | | | | | |
|-------------------|-----|---------------|-------|----|---|---|----|--------------------|-----------|-------|
| 1.6 DRIVe | 84 | 06/11 → | 1.560 | D | M | 4 | 8 | D4162T | | 81869 |
| 2.0 T | 149 | 09/10 → | 1.999 | B | M | 4 | 16 | B4204T6 | | 81804 |
| 2.4 D5 | 158 | 06/11 → | 2.400 | D | M | 5 | 20 | D5244T11, D5244T15 | | 81864 |
| 2.4 D5 AWD | 158 | 06/11 → | 2.400 | D | M | 5 | 20 | D5244T15 | | 81864 |
| 2.4 D5 Hybrid AWD | 120 | 03/15 → | 2.400 | | M | 5 | 20 | D87PHEV | | 81864 |
| 2.4 Hybrid D6 AWD | 158 | 06/12 → | 2.400 | | M | 5 | 20 | D82PHEV | | 81864 |
| D3 | 100 | 12/12 → | 1.984 | D | M | 5 | 20 | D5204T7 | | 81864 |
| D3 / D4 | 120 | 09/10 → | 1.984 | D | M | 5 | 20 | D5204T2, D5204T3 | | 81864 |
| D4 AWD | 120 | 12/12 → | 2.400 | D | M | 5 | 20 | D5244T17 | | 81864 |
| | 133 | 10/13 → | 2.400 | D | M | 5 | 20 | D5244T12 | | 81864 |
| | 140 | 03/15 → | 2.400 | D | M | 5 | 20 | D5244T21 | | 81864 |
| D5 | 151 | 09/10 → | 2.400 | D | M | 5 | 20 | D5244T10 | | 81864 |
| | 169 | 04/14 → | 2.400 | D | M | 5 | 20 | D5244T23 | | 81864 |
| D5 AWD | 151 | 09/10 → | 2.400 | D | M | 5 | 20 | D5244T10 | | 81864 |
| | 169 | 04/14 → | 2.400 | D | M | 5 | 20 | D5244T15, D5244T23 | | 81864 |
| D6 Hybrid AWD | 162 | 03/15 → | 2.400 | | M | 5 | 20 | D97PHEV | | 81864 |
| T3 | 110 | 09/10 → | 1.596 | B | M | 4 | 16 | B4164T3 | | 82027 |
| T4 | 132 | 09/10 → | 1.596 | B | M | 4 | 16 | B4164T | | 82027 |
| T4F | 132 | 04/11 → | 1.596 | FF | M | 4 | 16 | B4164T2 | | 82027 |
| T5 | 157 | 04/14 → | 1.984 | B | M | 5 | 20 | B5204T9 | | 82056 |
| | 177 | 09/10 → | 1.999 | B | M | 4 | 16 | B4204T7 | | 81804 |
| V 70 I | | | | | | | | | | |
| 2.0 | 93 | 01/97 → 03/00 | 1.984 | B | M | 5 | 10 | B5202S | | 82056 |
| | 105 | 01/97 → 03/00 | 1.984 | B | M | 5 | 20 | B5204F | 11-1996 → | 82056 |
| | 105 | 01/97 → 03/00 | 1.984 | B | M | 5 | 20 | B5204F | | 82056 |
| | 120 | 01/97 → 03/00 | 1.984 | B | M | 5 | 20 | B5204T4 | | 82056 |
| | 132 | 01/97 → 03/00 | 1.984 | B | M | 5 | 20 | B5204T2 | | 82056 |
| 2.0 Turbo | 155 | 01/97 → 03/00 | 1.984 | B | M | 5 | 20 | B5204T | | 82056 |
| | 166 | 01/97 → 03/00 | 1.984 | B | M | 5 | 20 | B5204T3 | | 82056 |
| 2.0 Turbo AWD | 166 | 01/97 → 03/00 | 1.984 | B | M | 5 | 20 | B5204T3 | | 82056 |
| 2.3 | 177 | 11/96 → 11/00 | 2.319 | B | M | 5 | 20 | B5234T3 | | 82056 |
| 2.3 AWD | 177 | 04/97 → 09/98 | 2.319 | B | M | 5 | 20 | B5234T3 | | 82056 |
| | 195 | 12/98 → 02/00 | 2.319 | B | M | 5 | 20 | B5234T7, B5234T8 | | 82056 |
| 2.3 T AWD | 184 | 04/97 → 03/00 | 2.319 | B | M | 5 | 20 | B5234FT+, B5234T4 | | 82056 |
| 2.3 T-5 | 176 | 01/97 → 03/00 | 2.319 | B | M | 5 | 20 | B5234T3 | | 82056 |
| 2.3 T-5 AWD | 176 | 01/97 → 03/00 | 2.319 | B | M | 5 | 20 | B5234T3 | | 82056 |
| 2.3 Turbo | 184 | 01/97 → 03/00 | 2.319 | B | M | 5 | 20 | B5234FT+ | | 82056 |
| 2.4 | 103 | 08/99 → 05/00 | 2.435 | B | M | 5 | 20 | B5244S2, B5244SG2 | | 82056 |
| | 125 | 01/97 → 05/00 | 2.435 | B | M | 5 | 20 | B5244S, B5254S | | 82056 |
| 2.4 AWD | 121 | 10/98 → 05/99 | 2.435 | B | M | 5 | 20 | B5254S | | 82056 |
| 2.4 Bifuel | 103 | 08/99 → 03/00 | 2.435 | BF | M | 5 | 20 | B5244SG | | 82056 |
| 2.4 Turbo | 142 | 01/97 → 03/00 | 2.435 | B | M | 5 | 20 | B5244T, B5254T | | 82056 |
| 2.5 | 106 | 01/97 → 03/00 | 2.435 | B | M | 5 | 10 | B5252FS | | 82056 |
| | 121 | 06/98 → 03/00 | 2.435 | B | M | 5 | 20 | B5254S | | 82056 |

KW

cm³

NO. OF VALVES

MAGNETI MARELLI
VOLVO
V 70 I

| | | | | | | | | | | |
|---------------|-----|---------------|-------|----|---|---|----|----------------|--|-------|
| 2.5 AWD | 195 | 03/99 → 03/00 | 2.435 | B | M | 5 | 20 | B5244T2 | | 82056 |
| 2.5 Bifuel | 106 | 10/98 → 08/99 | 2.435 | BF | M | 5 | 10 | GB5252S | | 82056 |
| 2.5 TDI | 103 | 01/97 → 05/00 | 2.461 | D | M | 5 | 10 | D5252T | | 81701 |
| 2.5 Turbo AWD | 142 | 01/97 → 05/00 | 2.435 | B | M | 5 | 20 | B5244T, B5254T | | 82056 |

V 70 II

| | | | | | | | | | | |
|-------------|-----|---------------|-------|----|---|---|----|--------------------------|--|-------|
| 2.0 T | 132 | 07/01 → 08/07 | 1.984 | B | M | 5 | 20 | B5204T5 | | 82056 |
| 2.3 | 195 | 10/00 → 09/04 | 2.319 | B | M | 5 | 20 | B5234T7 | | 82056 |
| 2.3 AWD | 195 | 10/00 → 09/04 | 2.319 | B | M | 5 | 20 | B5234T7, B5234T8 | | 82056 |
| 2.3 T5 | 184 | 03/00 → 08/04 | 2.319 | B | M | 5 | 20 | B5234T3, B5234T4 | | 82056 |
| 2.4 | 103 | 03/00 → 08/07 | 2.435 | B | M | 5 | 20 | B5244S2 | | 82056 |
| | 121 | 03/00 → 09/03 | 2.435 | B | M | 5 | 20 | B5254S | | 82056 |
| | 125 | 03/00 → 08/07 | 2.435 | B | M | 5 | 20 | B5244S | | 82056 |
| 2.4 Bifuel | 103 | 09/01 → 08/07 | 2.435 | BF | M | 5 | 20 | B5244SG, B5244SG2 | | 82056 |
| | 103 | 09/01 → 08/07 | 2.435 | BF | M | 5 | 20 | B5244SG2 | | 82056 |
| 2.4 D | 93 | 05/05 → 08/07 | 2.400 | D | M | 5 | 20 | D5244T7 | | 81864 |
| | 96 | 12/01 → 08/07 | 2.401 | D | M | 5 | 20 | D5244T2 | | 81864 |
| 2.4 D5 | 120 | 08/01 → 08/07 | 2.401 | D | M | 5 | 20 | D5244T, D5244T5 | | 81864 |
| | 136 | 12/05 → 08/07 | 2.401 | D | M | 5 | 20 | D5244T4 | | 81864 |
| 2.4 D5 AWD | 120 | 03/03 → 08/07 | 2.401 | D | M | 5 | 20 | D5244T, D5244T2, D5244T5 | | 81864 |
| | 136 | 12/05 → 08/07 | 2.401 | D | M | 5 | 20 | D5244T4 | | 81864 |
| 2.4 T | 147 | 03/00 → 08/03 | 2.435 | B | M | 5 | 20 | B5244T3 | | 82056 |
| 2.4 T AWD | 147 | 09/01 → 08/02 | 2.435 | B | M | 5 | 20 | B5244T3 | | 82056 |
| 2.4 T5 | 191 | 04/04 → 08/07 | 2.401 | B | M | 5 | 20 | B5244T5 | | 82056 |
| 2.5 R Sport | 221 | 12/02 → 08/07 | 2.521 | B | M | 5 | 20 | B5254T4 | | 82056 |
| 2.5 T | 154 | 04/04 → 08/07 | 2.521 | B | M | 5 | 20 | B5254T2 | | 82056 |
| 2.5 T AWD | 154 | 09/02 → 08/07 | 2.521 | B | M | 5 | 20 | B5254T2 | | 82056 |
| R 2,5 T AWD | 221 | 03/03 → 08/07 | 2.521 | B | M | 5 | 20 | B5254T4 | | 82056 |

V 70 III

| | | | | | | | | | | |
|-----------------|-----|---------|-------|----|---|---|----|----------|--|-------|
| 1.6 D | 80 | 01/10 → | 1.560 | D | M | 4 | 16 | D4164T | | 81869 |
| 1.6 DRIVE / D2 | 84 | 06/11 → | 1.560 | D | M | 4 | 8 | D4162T | | 81869 |
| 1.6 T4F | 132 | 01/11 → | 1.596 | FF | M | 4 | 16 | B4164T2 | | 82027 |
| 2.0 | 107 | 10/07 → | 1.999 | B | M | 4 | 16 | B4204S3 | | 81804 |
| 2.0 BiFuel | 157 | 03/13 → | 1.984 | BF | M | 5 | 20 | B5204T9 | | 82056 |
| 2.0 D | 100 | 10/07 → | 1.997 | D | M | 4 | 16 | D4204T | | 81800 |
| 2.0 FlexiFuel | 107 | 01/08 → | 1.999 | | M | 4 | 16 | B4204S4 | | 81804 |
| 2.0 T | 149 | 01/10 → | 1.999 | B | M | 4 | 16 | B4204T6 | | 81804 |
| 2.4 D | 120 | 08/07 → | 2.400 | D | M | 5 | 20 | D5244T5 | | 81864 |
| | 129 | 10/09 → | 2.400 | D | M | 5 | 20 | D5244T14 | | 81864 |
| 2.5 T | 147 | 08/07 → | 2.521 | B | M | 5 | 20 | B5254T6 | | 82056 |
| | 170 | 01/10 → | 2.521 | B | M | 5 | 20 | B5254T10 | | 82056 |
| 2.5 T FlexiFuel | 147 | 05/08 → | 2.521 | | M | 5 | 20 | B5254T8 | | 82056 |
| | 170 | 10/09 → | 2.521 | | M | 5 | 20 | B5254T11 | | 82056 |
| D3 | 100 | 03/10 → | 1.984 | D | M | 5 | 20 | D5204T7 | | 81864 |

KW

cm³

NO. OF VALVES

MAGNETI MARELLI
VOLVO
V 70 III

| | | | | | | | | | |
|---------|-----|---------|-------|---|---|---|----|--------------------|-------|
| D3 / D4 | 120 | 03/10 → | 1.984 | D | M | 5 | 20 | D5204T2, D5204T3 | 81864 |
| D4 AWD | 120 | 01/13 → | 2.400 | D | M | 5 | 20 | D5244T17 | 81864 |
| | 133 | 10/13 → | 2.400 | D | M | 5 | 20 | D5244T12 | 81864 |
| D5 | 136 | 08/07 → | 2.400 | D | M | 5 | 20 | D5244T4 | 81864 |
| | 151 | 12/09 → | 2.400 | D | M | 5 | 20 | D5244T10 | 81864 |
| | 158 | 06/11 → | 2.400 | D | M | 5 | 20 | D5244T11, D5244T15 | 81864 |
| D5 AWD | 136 | 10/07 → | 2.400 | D | M | 5 | 20 | D5244T4 | 81864 |
| | 151 | 12/09 → | 2.400 | D | M | 5 | 20 | D5244T10 | 81864 |
| | 158 | 06/11 → | 2.400 | D | M | 5 | 20 | D5244T11, D5244T15 | 81864 |
| T4 | 132 | 10/10 → | 1.596 | B | M | 4 | 16 | B4164T | 82027 |
| T5 | 177 | 01/10 → | 1.999 | B | M | 4 | 16 | B4204T7 | 81804 |

V 90

| | | | | | | | | | |
|-----|-----|---------------|-------|---|---|---|----|---------|-------|
| 2.5 | 125 | 11/96 → 10/98 | 2.473 | B | M | 6 | 24 | B6254FS | 81857 |
| | 132 | 11/96 → 10/97 | 2.473 | B | M | 6 | 24 | B6244FS | 81857 |
| 2.9 | 132 | 01/97 → 12/98 | 2.922 | B | M | 6 | 24 | B6304S2 | 81857 |
| | 150 | 01/97 → 12/98 | 2.922 | B | M | 6 | 24 | B6304G | 81857 |

XC 60

| | | | | | | | | | |
|---------------------|-----|---------------|-------|---|---|---|----|-----------------------------|-------|
| 2.0 T | 149 | 03/10 → | 1.999 | B | M | 4 | 16 | B4204T6 | 81804 |
| 2.4 D | 129 | 07/09 → | 2.400 | D | M | 5 | 20 | D5244T14 | 81864 |
| 2.4 D / D3 / D4 AWD | 120 | 05/08 → | 2.400 | D | M | 5 | 20 | D5244T16, D5244T17, D5244T5 | 82056 |
| D3 | 100 | 04/12 → | 1.984 | D | M | 5 | 20 | D5204T7 | 81864 |
| D3 / D4 | 120 | 03/10 → | 1.984 | D | M | 5 | 20 | D5204T2, D5204T3 | 81864 |
| D4 AWD | 133 | 10/13 → | 2.400 | D | M | 5 | 20 | D5244T12 | 81864 |
| | 140 | 03/15 → | 2.400 | D | M | 5 | 20 | D5244T21 | 81864 |
| D5 | 158 | 06/11 → | 2.400 | D | M | 5 | 20 | D5244T11, D5244T15 | 81864 |
| D5 AWD | 136 | 05/08 → | 2.400 | D | M | 5 | 20 | D5244T4 | 82056 |
| | 151 | 07/09 → 06/11 | 2.400 | D | M | 5 | 20 | D5244T10 | 81864 |
| | 158 | 06/11 → | 2.400 | D | M | 5 | 20 | D5244T11, D5244T15 | 81864 |
| | 162 | 03/15 → | 2.400 | D | M | 5 | 20 | D5244T20, D5244T22 | 81864 |
| | 169 | 04/14 → | 2.400 | D | M | 5 | 20 | D5244T23 | 81864 |
| T5 | 177 | 09/10 → | 1.999 | B | M | 4 | 16 | B4204T7 | 81804 |
| T5 AWD | 187 | 04/14 → | 2.497 | B | M | 5 | 20 | B5254T12 | 82056 |

XC 70 I Cross Country

| | | | | | | | | | |
|---------------|-----|---------------|-------|---|---|---|----|---------|-------|
| 2.4 D5 AWD | 136 | 12/05 → 08/07 | 2.401 | D | M | 5 | 20 | D5244T4 | 81864 |
| 2.4 D5 XC AWD | 120 | 09/02 → 08/07 | 2.401 | D | M | 5 | 20 | D5244T | 81864 |
| 2.4 T XC AWD | 142 | 11/97 → 09/02 | 2.435 | B | M | 5 | 20 | B5254T | 82056 |
| | 147 | 03/00 → 09/02 | 2.435 | B | M | 5 | 20 | B5244T3 | 82056 |
| | 154 | 09/02 → 08/07 | 2.521 | B | M | 5 | 20 | B5254T2 | 82056 |

XC 70 II

| | | | | | | | | | |
|----------------|-----|---------|-------|---|---|---|----|-----------------------------|-------|
| 2.4 D | 129 | 01/10 → | 2.400 | D | M | 5 | 20 | D5244T14 | 81864 |
| 2.4 D / D4 AWD | 120 | 08/07 → | 2.400 | D | M | 5 | 20 | D5244T16, D5244T17, D5244T5 | 81864 |
| D3 | 120 | 08/11 → | 1.984 | D | M | 5 | 20 | D5204T2, D5204T3 | 81864 |

KW

cm³

NO. OF VALVES

VOLVO
XC 70 II

| | | | | | | | | | | |
|--------|-----|---------|-------|---|---|---|----|--------------------|--|-------|
| D3 AWD | 120 | 08/11 → | 1.984 | D | M | 5 | 20 | D5204T2 | | 81864 |
| D4 AWD | 133 | 10/13 → | 2.400 | D | M | 5 | 20 | D5244T12 | | 81864 |
| D5 AWD | 136 | 08/07 → | 2.400 | D | M | 5 | 20 | D5244T4 | | 81864 |
| | 151 | 12/09 → | 2.400 | D | M | 5 | 20 | D5244T10 | | 81864 |
| | 158 | 06/11 → | 2.400 | D | M | 5 | 20 | D5244T11, D5244T15 | | 81864 |
| | 162 | 03/15 → | 2.400 | D | M | 5 | 20 | D5244T20 | | 81864 |
| T5 AWD | 187 | 08/15 → | 2.497 | B | M | 5 | 20 | B5254T12 | | 82056 |

XC 90 I

| | | | | | | | | | | |
|---------|-----|---------|-------|---|---|---|----|-----------------|--|-------|
| 2.5 T | 154 | 10/02 → | 2.521 | B | M | 5 | 20 | B5254T2 | | 82056 |
| D3 / D5 | 120 | 04/09 → | 2.400 | D | M | 5 | 20 | D5244T5 | | 81864 |
| D5 | 147 | 01/11 → | 2.400 | D | M | 5 | 20 | D5244T18 | | 81864 |
| | 120 | 10/02 → | 2.401 | D | M | 5 | 20 | D5244T, D5244T5 | | 81864 |
| | 136 | 05/06 → | 2.401 | D | M | 5 | 20 | D5244T4 | | 81864 |
| D5 AWD | 120 | 10/07 → | 2.400 | D | M | 5 | 20 | D5244T5 | | 81864 |
| T6 | 200 | 10/02 → | 2.922 | B | M | 6 | 24 | B6294T | | 81864 |

ZASTAVA
101

| | | | | | | | | | | |
|-----|----|---------------|-------|---|---|---|---|-----------|--------|-------|
| 1.3 | 48 | 10/81 → 12/93 | 1.290 | B | M | 4 | 8 | 128AR.000 | (-)COP | 81481 |
|-----|----|---------------|-------|---|---|---|---|-----------|--------|-------|

Yugo

| | | | | | | | | | | |
|--------|----|---------------|-------|---|---|---|---|----------------------|--------|-------|
| 60 EFI | 44 | 08/91 → 06/95 | 1.116 | B | M | 4 | 8 | 100GL.0.64, 11E1.064 | (-)COP | 81481 |
| | 48 | 08/91 → 06/95 | 1.302 | B | M | 4 | 8 | 13E1.064 | (-)COP | 81481 |

Yugo Florida

| | | | | | | | | | | |
|-----|----|---------------|-------|---|---|---|---|-----------|--------|-------|
| 1.3 | 50 | 03/91 → | 1.302 | B | M | 4 | 8 | 13E.3.064 | (-)COP | 81481 |
| 1.4 | 52 | 10/88 → 06/95 | 1.372 | B | M | 4 | 8 | 160A1.000 | (-)COP | 81481 |

Buyers guide



11701T
351170120000

| FLANGIA | |
|-------------------------|-------|
| Numero Fori Flangia | 3 |
| Dimensione Fori Flangia | M6×1 |
| Posizione Attacco | 100 |
| Diametro Mozzo | Ø27 |
| Diametro Centraggio | Ø28 |
| Diametro Girante | Ø65.5 |
| N° Alette Girante | 5 |
| Posizione Girante | 2.5 |

KW

ALFA ROMEO
75

| | | | | | |
|----------------|-----|---------------|---|---------------------|--|
| 1.6 | 81 | 05/89 → 02/92 | B | AR61101 | |
| 1.8 | 95 | 05/89 → 12/92 | B | AR61202 | |
| | 95 | 08/89 → 02/92 | B | AR67101 | |
| | 88 | 09/88 → 02/92 | B | AR06168, AR61102 | |
| | 90 | 08/89 → 02/92 | B | AR61201 | |
| 1.8 Turbo | 110 | 09/86 → 02/92 | B | AR06134 | |
| 1.8 Turbo i.e. | 114 | 02/86 → 01/90 | B | AR06134, AR06158 | |
| 2.0 T.S. | 109 | 05/85 → 02/92 | B | AR06224 | |
| | 107 | 01/87 → 02/92 | B | AR06166, AR06224 | |

Spider III

| | | | | | |
|-------------|----|---------------|---|---------------------|-------------------------|
| 1600 | 76 | 03/76 → 12/90 | B | AR00526 | → 12-1985 |
| | 76 | 03/76 → 12/90 | B | AR00526 | 01-1989 → |
| | 79 | 01/90 → 12/93 | B | AR01563 | |
| 2000 | 85 | 08/86 → 12/90 | B | AR01544 | 01-1989 → |
| | 88 | 01/90 → 12/93 | B | AR01588 | |
| | 92 | 08/86 → 12/90 | B | AR00515 | 01-1989 → |
| 2000 Veloce | 93 | 01/77 → 12/93 | B | AR00515, AR01590 | 01-1978 →, → 12-1985 |
| | 93 | 01/77 → 12/93 | B | AR00515, AR01590 | 01-1989 → |

11706T
351170620000

| FLANGIA | |
|-------------------------|------|
| Numero Fori Flangia | 3 |
| Dimensione Fori Flangia | M6×1 |
| Posizione Attacco | 63.5 |
| Diametro Mozzo | Ø27 |
| Diametro Centraggio | Ø28 |
| Diametro Girante | Ø66 |
| N° Alette Girante | 7 |
| Posizione Girante | 41.3 |

KW

ALFA ROMEO
33 I, Sportwagon

| | | | | | |
|-----|----|---------------|---|---------|--|
| 1.5 | 70 | 05/83 → 12/93 | B | AR30182 | |
|-----|----|---------------|---|---------|--|

33 II, Sportwagon

| | | | | | |
|--------------|-----|---------------|---|---------------------|--|
| 1.4 i.e. | 65 | 06/91 → 09/94 | B | AR30753, AR30755 | |
| | 66 | 06/91 → 09/94 | B | AR30755 | |
| | 65 | 06/91 → 09/94 | B | AR30753, AR30755 | |
| 1.5 | 66 | 06/91 → 09/94 | B | AR30753, AR30755 | |
| | 77 | 01/90 → 04/93 | B | AR30734 | |
| 1.5 i.e. | 71 | 01/90 → 09/94 | B | AR30751 | |
| | 74 | 07/90 → 08/91 | B | AR30750 | |
| 1.7 16V | 101 | 01/90 → 03/92 | B | AR30746 | |
| | 95 | 01/90 → 09/94 | B | AR30747 | |
| | 97 | 01/90 → 03/92 | B | AR30747 | |
| | 101 | 01/90 → 03/92 | B | AR30746 | |
| 1.7 16V 4x4 | 95 | 01/90 → 09/94 | B | AR30747 | |
| | 97 | 01/90 → 09/94 | B | AR30747 | |
| | 101 | 01/90 → 09/94 | B | AR30746 | |
| 1.7 i.e. | 77 | 04/92 → 09/94 | B | AR30737 | |
| | 77 | 04/92 → 09/94 | B | AR30737A | |
| | 79 | 01/90 → 09/94 | B | AR30736, AR30737 | |
| 1.7 i.e. 4x4 | 79 | 01/90 → 03/92 | B | AR30736, AR30737 | |
| | 79 | 01/90 → 03/92 | B | AR30736, AR30737 | |

145

| | | | | | |
|--------------|----|---------------|---|---------|-------------------------|
| 1.4 i.e. | 66 | 07/94 → 12/96 | B | AR33501 | 07-1994 →, → 09-1996 |
| 1.6 i.e. | 76 | 10/94 → 12/96 | B | AR33201 | |
| 1.7 i.e. 16V | 95 | 10/94 → 12/96 | B | AR33401 | |

11706T 351170620000



ALFA ROMEO

146

| | | | | | |
|--------------|----|---------------|---|---------|-------------------------|
| 1.4 i.e. | 66 | 12/94 → 12/96 | B | AR33501 | 05-1995 →, → 09-1996 |
| 1.6 i.e. | 76 | 12/94 → 12/96 | B | AR33201 | 05-1995 →, → 09-1996 |
| 1.7 i.e. 16V | 95 | 12/94 → 12/96 | B | AR33401 | 05-1995 →, → 09-1996 |

11707 350911707000



PULEGGIA

Versione BC

Diametro Puleggia Ø108

Numero Denti/Gole Puleggia 1

Posizione Attacco 70.5

Diametro Girante Ø67

N° Alette Girante 7

Posizione Girante 4.6



ALFA ROMEO

75

| | | | | | |
|-------------|-----|---------------|---|---------------------|----|
| 2.5 V6 Cat. | 113 | 09/86 → 05/90 | B | AR01648 | BC |
| 3.0 V6 | 136 | 01/87 → 02/92 | B | AR06120, AR06124 | BC |

11708T 351170820000



FLANGIA

Numero Fori Flangia 3

Dimensione Fori Flangia M6×1

Posizione Attacco 87

Diametro Mozzo Ø27

Diametro Centraggio Ø28

Diametro Girante Ø65.5

N° Alette Girante 5

Posizione Girante 9.5



ALFA ROMEO

155

| | | | | | |
|----------|----|---------------|---|---------|-------------------------|
| 1.7 T.S. | 83 | 04/93 → 04/96 | B | AR67103 | |
| | 85 | 04/93 → 04/96 | B | AR67105 | |
| 1.8 T.S. | 77 | 02/92 → 12/97 | B | AR67402 | 07-1993 →, → 04-1996 |
| | 95 | 02/92 → 06/93 | B | AR67101 | 03-1992 →, → 06-1993 |

11708T 351170820000



ALFA ROMEO

155

| | | | | | |
|----------------|-----|---------------|---|---------------------|-------------------------|
| 1.8 T.S. Sport | 93 | 01/92 → 12/96 | B | AR67101, AR67102 | 07-1993 →, → 04-1996 |
| 2.0 T.S. | 104 | 02/92 → 02/95 | B | AR67202 | |
| | 106 | 02/92 → 04/93 | B | AR67201 | |

19532/E 351953205000



FLANGIA

Numero Fori Flangia 3

Dimensione Fori Flangia M6×1

Posizione Attacco 90

Diametro Centraggio Ø44.8

Diametro Girante Ø67

N° Alette Girante 7

Posizione Girante 4.6



ALFA ROMEO

75

| | | | | | |
|--------|-----|---------------|---|---------|--|
| 3.0 V6 | 141 | 02/90 → 02/92 | B | AR61503 | |
|--------|-----|---------------|---|---------|--|

164

| | | | | | |
|--------------|-----|---------------|---|---------|--|
| 2.0 V6 Turbo | 148 | 09/92 → 09/98 | B | AR64102 | |
| | 150 | 03/91 → 09/92 | B | AR64101 | |
| 2.5 V6 | 120 | 09/92 → 09/98 | B | AR66201 | |

| | | | | | |
|-------------|-----|---------------|---|---------------------|--|
| 3.0 i.e. QV | 147 | 09/90 → 09/92 | B | AR06430, AR64301 | |
|-------------|-----|---------------|---|---------------------|--|

| | | | | | |
|--------|-----|---------------|---|---|--|
| 3.0 V6 | 132 | 09/92 → 09/98 | B | AR64303, AR64305, AR64399, AR66303 | |
| | | | | AR64303, AR64305, AR64399, AR66303 | |
| | 135 | 06/87 → 09/92 | B | AR06412 | |
| | 141 | 06/87 → 09/92 | B | AR06410 | |

FIAT

Croma I

| | | | | | |
|---------|-----|---------------|---|----------|--|
| 2500 V6 | 119 | 06/93 → 08/96 | B | 834G.000 | |
|---------|-----|---------------|---|----------|--|

81300
350981300000

PULEGGIA

Diametro Puleggia Ø104
 Numero Denti/Gole Puleggia 1
 Posizione Attacco 163.6
 Diametro Girante Ø53.8
 N° Alette Girante 6
 Posizione Girante 40.3

KW

FIAT
Cinquecento

| | | | | | |
|----------|----|---------------|---|-----------|-------|
| 0.9 | 30 | 07/91 → 12/93 | B | 170A1.000 | (-)AC |
| 0.9 i.e. | 30 | 07/91 → 12/93 | B | 170A1.046 | (-)AC |

Panda I, Van

| | | | | | |
|-----|----|---------------|---|-------------------------|-----------|
| 900 | 29 | 04/92 → 12/96 | B | 1170A1.046 | |
| | 33 | 10/80 → 06/94 | B | 100GL3.000, 146A.000 | 01-1992 → |

Seicento, Van

| | | | | | |
|-----|----|---------------|---|------------|--|
| 0.9 | 29 | 01/98 → 01/10 | B | 1170A1.046 | |
|-----|----|---------------|---|------------|--|

81301
350981301000

PULEGGIA

Diametro Puleggia Ø103
 Numero Denti/Gole Puleggia 1
 Posizione Attacco 165
 Diametro Girante Ø53.8
 N° Alette Girante 6
 Posizione Girante 40.3

KW

FIAT
Cinquecento

| | | | | | |
|------------|----|---------------|---|---------------------------|-------|
| 0.9 | 30 | 07/91 → 12/93 | B | 170A1.000 | (+)AC |
| 0.9 i.e. | 30 | 07/91 → 12/93 | B | 170A1.046 | (+)AC |
| 0.9 i.e. S | 29 | 07/91 → 07/99 | B | 1170A1.000, 1170A1.046 | |

81302
350981302000

FLANGIA

Numero Fori Flangia 1
 Dimensione Fori Flangia Ø4
 Posizione Attacco 70
 Diametro Mozzo M26×1.5
 Diametro Centraggio Ø27
 Diametro Girante Ø70.5
 N° Alette Girante 7
 Posizione Girante 29

KW

ALFA ROMEO
33 II, Sportwagon

| | | | | | |
|--------|----|---------------|---|-------|--|
| 1.8 TD | 62 | 07/90 → 09/94 | D | VM96A | |
|--------|----|---------------|---|-------|--|

155

| | | | | | |
|--------|----|---------------|---|-----------------|-----------|
| 2.5 TD | 92 | 04/93 → 12/97 | D | VM07B, VM31B | 04-1993 → |
|--------|----|---------------|---|-----------------|-----------|

164

| | | | | | |
|--------|----|---------------|---|-------|-----------|
| 2.5 TD | 84 | 06/87 → 09/92 | D | VM84A | 10-1989 → |
|--------|----|---------------|---|-------|-----------|

CHRYSLER
Voyager II

| | | | | | |
|--------|----|---------------|---|----------|--|
| 2.5 i | 72 | 01/91 → 09/95 | B | K00 | |
| | 74 | 08/90 → 09/95 | B | K | |
| 2.5 TD | 87 | 01/92 → 09/95 | D | 09B, M00 | |

FORD
Scorpio I, Station Wagon

| | | | | | |
|--------|----|---------------|---|-----|-----------|
| 2.5 TD | 85 | 08/93 → 09/94 | D | SCB | → 09-1993 |
| | 85 | 08/93 → 09/94 | D | SCB | |

Scorpio II, Station Wagon

| | | | | | |
|--------|----|---------------|---|-----|-----------|
| 2.5 TD | 85 | 10/94 → 08/98 | D | SCC | → 09-1996 |
| | 85 | 10/94 → 08/98 | D | SCC | 06-1996 → |

ROVER
800

| | | | | | |
|----------|-----|---------------|---|------------------------|-----------|
| 825 D/SD | 87 | 01/90 → 02/99 | D | 425SL1RR, 4924SHIRG | → 02-1996 |
| 825 SD | 87 | 09/93 → 02/99 | D | 425SL1RR, 4924SHIRG | → 02-1996 |
| 825 Si | 129 | 04/96 → 02/99 | B | 25K4F | |

81303

350981303000



PULEGGIA

Diametro Puleggia Ø118.5
 Numero Denti/Gole Puleggia 6
 Posizione Attacco 73.45
 Diametro Girante Ø60
 N° Alette Girante 8
 Posizione Girante 41.5



FIAT

Punto I, Cabrio, Van

| | | | | | |
|--------|----|---------------|---|-----------|--------|
| 1.4 GT | 96 | 09/96 → 09/99 | B | 176B6.000 | (+)COP |
| Turbo | 98 | 01/94 → 09/96 | B | 176A4.000 | (+)COP |
| 1.6 | 65 | 01/94 → 04/97 | B | 176A9.000 | (+)COP |

Elba

| | | | | | |
|-----|----|---------------|---|-----------|---------------|
| 1.5 | 52 | 04/86 → 10/92 | B | 149C1.000 | (+)COP, (+)AC |
|-----|----|---------------|---|-----------|---------------|

Marea, Weekend

| | | | | | |
|-----------|----|---------------|---|-----------|-------------------|
| 1.9 TD 75 | 55 | 09/96 → 05/02 | D | 182A8.000 | (+)COP, 05-1999 → |
|-----------|----|---------------|---|-----------|-------------------|

Palio I, Weekend

| | | | | | |
|----------|----|---------|---|-----------|---------------|
| 1.4 | 51 | 04/96 → | B | 178B2.000 | (+)COP, (+)AC |
| 1.4 Cat. | 51 | 04/96 → | B | 178B2.016 | (+)COP, (+)AC |

Punto I, Cabrio, Van

| | | | | | |
|--------|----|---------------|---|-----------|--------|
| 90 1.6 | 65 | 04/94 → 04/97 | B | 176A9.000 | (+)COP |
|--------|----|---------------|---|-----------|--------|

Siena I

| | | | | | |
|----------|----|---------------|---|-----------|----------------------|
| 1.4 | 51 | 04/96 → 12/09 | B | 178B2.000 | (+)COP, (+)SS, (+)AC |
| 1.4 Cat. | 51 | 04/96 → 12/09 | B | 178B2.016 | (+)COP, (+)SS, (+)AC |

Tempra, Station Wagon

| | | | | | |
|----------|----|---------------|---|----------------------|--|
| 1.4 i.e. | 51 | 03/92 → 08/96 | B | 160A1.046, 836A4.000 | (+)COP, 01-1993 →, M →: 9.336.693, (+)AC |
| | 51 | 10/92 → 08/96 | B | 160A1.046, 836A4.000 | (+)COP, 01-1993 →, (+)AC |
| | 57 | 03/91 → 08/96 | B | 159A2.000 | (+)COP, 01-1993 →, (+)AC |
| 1.6 i.e. | 55 | 06/92 → 08/96 | B | 159A3.048, 835C1.000 | (+)COP, (+)AC |
| | 57 | 10/90 → 08/96 | B | 159A3.046, 835C1.000 | (+)COP, 01-1993 →, (+)AC |
| | 63 | 06/94 → 08/96 | B | 159B9.000 | (+)COP, (+)AC |
| | 66 | 06/94 → 08/96 | B | 159B9.000 | (+)COP, (+)AC |

81303

350981303000



LANCIA

Dedra, Station Wagon

| | | | | | |
|----------|----|---------------|---|-----------|--------|
| 1.6 | 66 | 10/94 → 07/99 | B | 159B9.000 | (+)COP |
| 1.6 16V | 76 | 01/96 → 07/99 | B | 182A4.000 | (+)COP |
| 1.6 i.e. | 55 | 04/93 → 07/99 | B | 835C1.000 | (+)COP |
| 1.6 LE | 66 | 07/94 → 07/99 | B | 159B9.000 | (+)COP |

Delta II

| | | | | | |
|----------|----|---------------|---|----------------------|---------------------------------|
| 1.4 i.e. | 51 | 10/94 → 08/99 | B | 160A1.046, 836A4.000 | (+)COP, 04-1995 → |
| 1.6 i.e. | 55 | 06/93 → 08/99 | B | 835C1.000 | (+)COP, 04-1995 →, (+)SS, (+)AC |

81304

350981304000



FLANGIA

Numero Fori Flangia 3
 Dimensione Fori Flangia M8x1.25
 Posizione Attacco 61.55
 Diametro Mozzo Ø22
 Diametro Centraggio Ø25.95
 Diametro Girante Ø70
 N° Alette Girante 9
 Posizione Girante 28.4



FIAT

Punto I, Cabrio, Van

| | | | | | |
|--------|----|---------------|---|-----------|-------------------|
| 1.7 TD | 51 | 01/94 → 09/99 | D | 176A3.000 | (+)COP, → 08-1996 |
| | 52 | 01/94 → 09/99 | D | 176A5.000 | (+)COP, → 08-1996 |

Palio I, Weekend

| | | | | | |
|--------|----|---------------|---|-----------|-----------------------------------|
| 1.7 TD | 51 | 04/96 → 03/01 | D | 176A3.000 | (+)COP, → 09-1999, → M: 2.427.906 |
|--------|----|---------------|---|-----------|-----------------------------------|

Punto I, Cabrio, Van

| | | | | | |
|--------|----|---------------|---|-----------|--------|
| 1.7 D | 42 | 04/96 → 02/00 | D | 176B3.000 | (+)COP |
| 1.7 TD | 46 | 09/96 → 09/99 | D | 176B7.000 | (+)COP |
| | 52 | 04/96 → 02/00 | D | 176A5.000 | (+)COP |

Strada

| | | | | | |
|--------|----|---------|---|-----------|------------------------|
| 1.7 TD | 51 | 06/99 → | D | 176A3.000 | (+)COP, → M: 2.427.906 |
|--------|----|---------|---|-----------|------------------------|

JEEP

Wrangler II

| | | | | | |
|-----|-----|---------------|---|-----|--------|
| 2.4 | 105 | 11/02 → 04/07 | B | ED1 | (+)COP |
|-----|-----|---------------|---|-----|--------|

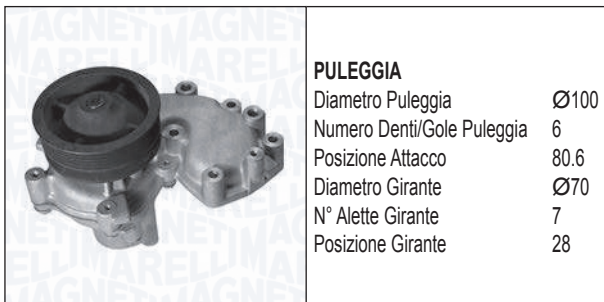
81309
350981309000

PULEGGIA

Diametro Puleggia Ø100
 Numero Denti/Gole Puleggia 6
 Posizione Attacco 80.6
 Diametro Girante Ø70
 N° Alette Girante 7
 Posizione Girante 28

KW

FIAT
Croma I

1900 Turbo D i.d. 66 05/89 → 10/92 D 154C6.000 T →: 286.050

81314
350981314000

PULEGGIA

Diametro Puleggia Ø122.5
 Numero Denti/Gole Puleggia 4
 Posizione Attacco 76.7
 Diametro Girante Ø65
 N° Alette Girante 7
 Posizione Girante 50

KW

FIAT
Fiorino III, Pick Up (Uno)

| | | | | | |
|-------------|----|---------------|---|-------------------------|---------------------------|
| 1.4 | 49 | 05/94 → 05/01 | B | 146D5.000 | (-)COP, → M: 9.470.268 |
| | 52 | 11/92 → 10/96 | B | 146C5.000 | (-)COP, → M: 9.470.268 |
| 1.6 | 55 | 01/94 → 05/01 | B | 146C6.000, 146D6.000 | (-)COP, → M: 9.470.268 |
| 70 i.e. 1.4 | 49 | 05/94 → 05/01 | B | 146C5.000, 146D5.000 | (-)COP, → M: 9.470.268 |
| 75 i.e. 1.6 | 55 | 10/93 → 05/01 | B | 146C6.000, 146D6.000 | (-)COP, → M: 9.470.268 |

Tempra, Station Wagon

| | | | | | |
|----------|----|---------------|---|-------------------------|-------------------------------------|
| 1.4 i.e. | 51 | 03/92 → 08/96 | B | 160A1.046, 836A4.000 | (-)COP, → M: 9.336.692, (+)AC |
| | 57 | 03/91 → 08/96 | B | 159A2.000 | (-)COP, → M: 9.336.692, (+)AC |

81314
350981314000

FIAT
Tempra, Station Wagon

| | | | | | |
|----------|----|---------------|---|-------------------------|--------------------------------|
| 1.6 | 51 | 04/90 → 06/93 | B | 159A3.048 | (-)COP, (+)AC |
| | 63 | 12/90 → 04/93 | B | 159A3.000 | (-)COP, (+)AC |
| | 63 | 03/90 → 04/93 | B | 159A3.000, 159B9.000 | (-)COP, (+)AC |
| 1.6 i.e. | 57 | 06/90 → 07/92 | B | 159A3.046 | (-)COP, (+)AC |
| | 57 | 10/90 → 08/96 | B | 159A3.046, 835C1.000 | (-)COP, → 12-1992, (+)AC |

Tipo I

| | | | | | |
|----------|----|---------------|---|-------------------------|---------------|
| 1.4 i.e. | 57 | 05/89 → 04/95 | B | 159A2.000 | (-)COP, (+)AC |
| | 51 | 05/89 → 04/95 | B | 160A1.046, 836A4.000 | (-)COP, (+)AC |
| 1.6 | 61 | 01/88 → 10/91 | B | 160A2.000 | (-)COP, (+)AC |
| 1.6 i.e. | 55 | 10/92 → 04/95 | B | 159A3.048, 835C1.000 | (-)COP, (+)AC |
| | 57 | 07/90 → 01/93 | B | 159A3.046 | (-)COP, (+)AC |

Uno I

| | | | | | |
|-------------|----|---------------|---|-----------|---------------|
| 70 i.e. 1.4 | 51 | 09/89 → 12/93 | B | 160A1.046 | (-)COP, (+)AC |
| | 53 | 09/89 → 12/93 | B | 146C1.000 | (-)COP, (+)AC |

INNOCENTI
Elba

| | | | | | |
|----------|----|---------------|---|-------------------------|----------------------|
| 1.4 i.e. | 49 | 09/94 → 12/96 | B | 146C5.000, 146D5.000 | (-)COP, → 02-1995 |
| 1.6 i.e. | 55 | 09/94 → 12/96 | B | 146C6.000, 146D6.000 | (-)COP |

LANCIA
Dedra, Station Wagon

| | | | | | |
|----------|----|---------------|---|-----------|--------|
| 1.6 i.e. | 57 | 08/89 → 03/93 | B | 835A1.046 | (-)COP |
| | 66 | 08/89 → 06/94 | B | 835A1.000 | (-)COP |

81315
350981315000

FLANGIA

| | |
|-------------------------|---------|
| Numero Fori Flangia | 3 |
| Dimensione Fori Flangia | M8x1.25 |
| Posizione Attacco | 95.5 |
| Diametro Centraggio | Ø57 |
| Diametro Girante | Ø68 |
| N° Alette Girante | 12 |
| Posizione Girante | 17.2 |

FIAT
Tempra, Station Wagon

| | | | | | |
|--------------|----|---------------|---|-----------|-------------------------|
| 1.8 i.e. | 66 | 09/93 → 08/96 | B | 835C4.000 | |
| | 74 | 10/94 → 08/96 | B | 836A5.000 | 01-1992 →, → 07-1996 |
| | 74 | 10/94 → 08/96 | B | 836A5.000 | |
| | 76 | 09/93 → 08/96 | B | 835C2.000 | 01-1992 →, → 07-1996 |
| | 76 | 09/93 → 08/96 | B | 835C2.000 | |
| | 77 | 03/92 → 08/96 | B | 159A4.046 | 01-1992 →, → 07-1996 |
| | 77 | 03/92 → 12/93 | B | 159A4.046 | |
| | 81 | 03/90 → 08/96 | B | 159A4.000 | 07-1992 → |
| 2.0 i.e. | 83 | 10/90 → 08/96 | B | 159A6.046 | 01-1992 → |
| 2.0 i.e. 4x4 | 83 | 03/92 → 03/95 | B | 159A6.046 | |

Tipo I

| | | | | | |
|----------|---------|---------------|---------------|-------------------------|-----------|
| 1.8 i.e. | 71 | 03/93 → 04/95 | B | 836A5.000 | |
| | 66 | 09/93 → 04/95 | B | 835C4.000 | |
| | 81 | 10/90 → 06/93 | B | 159A4.000 | |
| | 74 | 10/94 → 10/95 | B | 159A4.000, 836A5.000 | |
| | 76 | 04/93 → 04/95 | B | 835C2.000 | |
| | 77 | 10/90 → 06/93 | B | 159A4.046 | |
| | 2.0 16V | 107 | 07/91 → 04/95 | B | 160A8.046 |
| 2.0 i.e. | 80 | 06/90 → 03/92 | B | 159A5.046 | 07-1991 → |
| | 83 | 03/90 → 04/95 | B | 159A6.046 | 07-1991 → |

LANCIA
Dedra, Station Wagon

| | | | | | |
|--------------------------|-----|---------------|---|-----------|-----------|
| 1.8 i.e. | 66 | 08/93 → 07/99 | B | 835C5.000 | |
| | 74 | 07/94 → 07/99 | B | 836A5.000 | |
| | 77 | 09/89 → 07/99 | B | 835A2.046 | 05-1994 → |
| 2.0 HF Integrale | 124 | 11/90 → 07/94 | B | 835A7.046 | |
| 2.0 i.e. | 83 | 09/89 → 07/99 | B | 835A5.046 | 05-1994 → |
| 2.0 i.e. Turbo | 119 | 04/91 → 07/99 | B | 835A8.046 | |
| 2.0 i.e. Turbo Integrale | 121 | 05/90 → 07/94 | B | 835A7.000 | |
| 2.0 Turbo | 130 | 11/90 → 06/94 | B | 835A8.000 | |

81315
350981315000

LANCIA
Delta II

| | | | | | |
|----------|----|---------------|---|---------------------------------------|--|
| 1.8 i.e. | 66 | 07/94 → 08/99 | B | 835C4.000, 836A6.000, 836C4.000 | |
| | 76 | 06/93 → 08/99 | B | 835C2.000 | |

81316
350981316000

FLANGIA

| | |
|-------------------------|---------|
| Numero Fori Flangia | 3 |
| Dimensione Fori Flangia | M8x1.25 |
| Posizione Attacco | 78 |
| Diametro Centraggio | Ø50 |
| Diametro Girante | Ø93.5 |
| N° Alette Girante | 8 |
| Posizione Girante | 14.5 |

CITROËN
Jumper I

| | | | | | |
|-------------|----|---------------|---|----------------|--|
| 2.8 D | 64 | 01/99 → 02/02 | D | 8140.63 (F28D) | |
| 2.8 HDi | 93 | 10/00 → 01/02 | D | 8140.43S | |
| | 94 | 09/00 → 04/02 | D | 8140.43S | |
| 2.8 HDi 4x4 | 94 | 09/00 → 04/02 | D | 8140.43S | |

Jumper II

| | | | | | |
|----------------------------|-----|---------------|---|----------|--|
| 2.8 HDi | 94 | 04/02 → | D | 8140.43S | |
| | 107 | 05/04 → | D | 8140.43N | |
| | 107 | 05/04 → | D | 8140.43N | |
| 2.8 HDi 4x4 | 94 | 04/02 → | D | 8140.43S | |
| | 94 | 02/02 → 06/06 | D | F28TDCR | |
| 2.8 HDi Trazione integrale | 94 | 04/02 → | D | 8140.43S | |

FIAT
Ducato III

| | | | | | |
|-----------------|----|---------------|---|----------|--|
| 2.5 D | 62 | 03/94 → 04/02 | D | 8140.67 | |
| 2.5 D 4x4 | 62 | 03/94 → 04/02 | D | 8140.67 | |
| 2.5 D Combinato | 62 | 08/94 → 04/02 | D | 8140.67 | |
| 2.5 TD | 80 | 06/94 → 08/98 | D | 8140.47 | |
| | 85 | 06/94 → 04/98 | D | 8140.47 | |
| 2.5 TD 4x4 | 80 | 11/94 → 04/98 | D | 8140.47 | |
| | 85 | 11/94 → 04/98 | D | 8140.47 | |
| 2.5 TDI | 80 | 03/94 → 04/02 | D | 8140.47R | |
| | 85 | 03/94 → 04/02 | D | 8140.47 | |

81316 350981316000

FIAT
Ducato III

| | | | | | |
|--------------------------------|----|---------------|---|----------|--|
| 2.5 TDI 4x4 | 85 | 04/97 → 04/02 | D | 8140.47 | |
| 2.5 TDI Panorama/ Combinato | 80 | 07/94 → 04/02 | D | 8140.47R | |
| | 85 | 03/94 → 04/02 | D | 8140.47 | |
| 2.8 D | 64 | 02/98 → 04/02 | D | 8140.63 | |
| 2.8 D 4x4 | 64 | 08/98 → 04/02 | D | 8140.63 | |
| 2.8 iDTD 4x4 | 90 | 05/98 → 09/01 | D | 8140.43 | |
| 2.8 JTD | 94 | 11/00 → 04/02 | D | 8140.43S | |
| | 94 | 03/01 → 04/02 | D | 8140.43S | |
| 2.8 JTD 4x4 | 94 | 11/00 → 04/02 | D | 8140.43S | |
| | 94 | 10/01 → 04/02 | D | 8140.43S | |
| 2.8 TD 4x4 | 64 | 05/98 → 11/01 | D | 8140.63 | |
| | 90 | 05/98 → 09/01 | D | 8140.43 | |
| 2.8 TDI | 90 | 10/97 → 04/02 | D | 8140.43 | |
| 2.8 TDI 4x4 | 90 | 07/99 → 04/02 | D | 8140.43 | |

Ducato IV

| | | | | | |
|---------------|-----|---------------|---|----------|--|
| 2.8 JTD | 94 | 04/02 → | D | 8140.43S | |
| | 107 | 04/04 → 07/06 | D | 8140.43N | |
| 2.8 JTD 4x4 | 94 | 07/02 → | D | 8140.43S | |
| 2.8 JTD Power | 107 | 05/04 → | D | 8140.43N | |

PEUGEOT
Boxer I

| | | | | | |
|----------------------------|----|---------------|---|-----------------------|------------------------|
| 2.5 D | 63 | 08/94 → 04/02 | D | T9A (DJ5) | 01-1999 →, M: SOFIM |
| 2.5 D 4x4 | 63 | 07/96 → 04/02 | D | T9A (DJ5) | M: SOFIM |
| 2.5 TD 4x4 | 76 | 07/96 → 04/02 | D | T8A (DJ5T) | M: SOFIM |
| 2.8 D | 64 | 01/99 → 02/02 | D | 8140.63 (F28D) | |
| 2.8 HDi | 93 | 10/00 → 11/01 | D | 8140.43S (F28DTCR) | |
| | 94 | 11/00 → 04/02 | D | 8140.43S (F28DTCR) | |
| 2.8 HDi 4x4 | 93 | 10/00 → 11/01 | D | 8140.43S (F28DTCR) | |
| | 94 | 10/00 → 04/02 | D | 8140.43S (F28DTCR) | |
| 2.8 HDi Trazione integrale | 93 | 10/00 → 11/01 | D | 8140.43S (F28DTCR) | |

81316 350981316000

PEUGEOT
Boxer II

| | | | | | |
|-------------|-----|---------|---|-----------------------|--|
| 2.8 HDi | 94 | 04/02 → | D | 8140.43S (F28DTCR) | |
| | 107 | 04/04 → | D | 8140.43N | |
| 2.8 HDi 4x4 | 94 | 04/02 → | D | 8140.43S (F28DTCR) | |

81318 350981318000

| | | |
|--|----------------------------|-------|
| | PULEGGIA | |
| | Diametro Puleggia | Ø99.5 |
| | Numero Denti/Gole Puleggia | 6 |
| | Posizione Attacco | 80.6 |
| | Diametro Girante | Ø70 |
| | N° Alette Girante | 9 |
| | Posizione Girante | 28 |

FIAT
Ducato III

| | | | | | |
|-------------------------------|----|---------------|---|-----------|-------|
| 1.9 TD | 60 | 03/94 → 04/02 | D | 230A3.000 | (-)AC |
| 1.9 TD CAT | 59 | 08/94 → 04/02 | D | 230A4.000 | (-)AC |
| 1.9 TD Combinato | 59 | 08/94 → 04/02 | D | 230A4.000 | (-)AC |
| 1.9 TD Panorama/ Combinato | 60 | 03/94 → 04/02 | D | 230A3.000 | (-)AC |

81319 350981319000

| | | |
|--|----------------------------|-------|
| | PULEGGIA | |
| | Diametro Puleggia | Ø99.5 |
| | Numero Denti/Gole Puleggia | 7 |
| | Posizione Attacco | 84.15 |
| | Diametro Girante | Ø70 |
| | N° Alette Girante | 9 |
| | Posizione Girante | 28 |

FIAT
Ducato III

| | | | | | |
|------------------|----|---------------|---|-----------|-------|
| 1.9 TD | 60 | 03/94 → 04/02 | D | 230A3.000 | (+)AC |
| 1.9 TD CAT | 59 | 08/94 → 04/02 | D | 230A4.000 | (+)AC |
| 1.9 TD Combinato | 59 | 08/94 → 04/02 | D | 230A4.000 | (+)AC |

81319 350981319000



FIAT

Ducato III

| | | | | | |
|----------------------------------|----|---------------|---|-----------|-------|
| 1.9 TD Panorama/ Combinato | 60 | 03/94 → 04/02 | D | 230A3.000 | (+)AC |
|----------------------------------|----|---------------|---|-----------|-------|

81320 350981320000



| | |
|-------------------------|---------|
| FLANGIA | |
| Numero Fori Flangia | 3 |
| Dimensione Fori Flangia | M8×1.25 |
| Posizione Attacco | 78.5 |
| Diametro Mozzo | Ø22 |
| Diametro Centraggio | Ø25.95 |
| Diametro Girante | Ø70 |
| N° Alette Girante | 7 |
| Posizione Girante | 28.4 |



FIAT

Ducato III

| | | | | | |
|--------------------|----|---------------|---|-----------|-----------|
| 1.9 D | 51 | 03/94 → 04/02 | D | 230A2.000 | 03-1994 → |
| 1.9 D Combinato | 51 | 06/95 → 04/02 | D | 230A2.000 | |

81322 350981322000

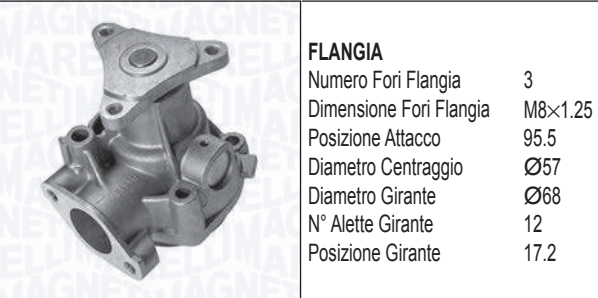

| | |
|-------------------------|---------|
| FLANGIA | |
| Numero Fori Flangia | 3 |
| Dimensione Fori Flangia | M8×1.25 |
| Posizione Attacco | 95.5 |
| Diametro Centraggio | Ø57 |
| Diametro Girante | Ø68 |
| N° Alette Girante | 12 |
| Posizione Girante | 17.2 |



ALFA ROMEO

155

| | | | | | |
|---------------------|-----|---------------|---|---------|-------------------------|
| 2.0 16V Turbo Q4 | 140 | 01/92 → 12/97 | B | AR67203 | 07-1992 →, → 02-1996 |
| | 137 | 01/92 → 12/97 | B | AR67203 | 07-1992 →, → 02-1996 |

FIAT

Coupé

| | | | | | |
|------------------|-----|---------------|---|-----------|-----------|
| 2.0 16V | 102 | 11/93 → 08/96 | B | 836A3.000 | 02-1994 → |
| 2.0 16V Turbo | 140 | 11/93 → 08/96 | B | 175A1.000 | 02-1994 → |

81322 350981322000



FIAT

Tipo I

| | | | | | |
|-----------------------|-----|---------------|---|-----------|--|
| 2.0 i.e. 16V Sport | 102 | 03/93 → 04/95 | B | 836A3.000 | |
|-----------------------|-----|---------------|---|-----------|--|

LANCIA

Dedra, Station Wagon

| | | | | | |
|---------------|-----|---------------|---|-----------|--|
| 2.0 16V | 102 | 07/94 → 07/99 | B | 836A3.000 | |
| 2.0 Integrale | 102 | 07/94 → 07/99 | B | 836A3.000 | |

Delta II

| | | | | | |
|------------------|-----|---------------|---|-----------|--|
| 2.0 16V | 102 | 06/93 → 08/99 | B | 836A3.000 | |
| 2.0 16V Turbo | 137 | 06/93 → 08/99 | B | 836A2.000 | |
| | 142 | 07/96 → 08/99 | B | 175A4.000 | |

81324 350981324000



| | |
|----------------------------|-------|
| PULEGGIA | |
| Diametro Puleggia | Ø131 |
| Numero Denti/Gole Puleggia | 1 |
| Posizione Attacco | 64 |
| Diametro Girante | Ø99 |
| N° Alette Girante | 7 |
| Posizione Girante | 17.35 |



FIAT

Croma I

| | | | | | |
|----------|----|---------------|---|---------------------------|--|
| 2500 TD | 85 | 05/89 → 08/96 | D | 8144.97, | 10-1991 →, → 12-1992, → M: 1.340.163 |
| | | | | 8144.97.2400, 8144.97Y | |
| 2500 TDE | 77 | 12/91 → 08/96 | D | 8144.97S | → 12-1992, M →: 1.340.163 |

LANCIA

Thema I, Station Wagon

| | | | | | |
|------------------|----|---------------|---|----------|-----------|
| 2500 Turbo DS | 85 | 06/88 → 05/92 | D | 8144.97 | 11-1991 → |
| | 77 | 05/88 → 07/92 | D | 8144.97S | 11-1991 → |

81325
350981325000

FLANGIA

| | |
|-------------------------|---------|
| Numero Fori Flangia | 3 |
| Dimensione Fori Flangia | M8x1.25 |
| Posizione Attacco | 62.6 |
| Diametro Centraggio | Ø50 |
| Diametro Girante | Ø95.5 |
| N° Alette Girante | 7 |
| Posizione Girante | 21.1 |

KW

FIAT
Croma I

| | | | | | |
|----------|----|---------------|---|---------------------------------------|-----------|
| 2500 TD | 85 | 05/89 → 08/96 | D | 8144.97, 8144.97.2400, 8144.97Y | 01-1993 → |
| 2500 TDE | 77 | 12/91 → 08/96 | D | 8144.97S | 01-1993 → |

LANCIA
Thema I, Station Wagon

| | | | | | |
|---------------|----|---------------|---|----------|--|
| 2500 Turbo DS | 85 | 05/92 → 07/94 | D | 8144.97Y | |
|---------------|----|---------------|---|----------|--|

RENAULT
Safrane I

| | | | | | |
|--------|----|---------------|---|-------------------|--|
| 2.5 dT | 83 | 12/92 → 07/96 | D | S8U762, S8U763 | |
|--------|----|---------------|---|-------------------|--|

81326
350981326000

PULEGGIA

| | |
|----------------------------|------|
| Diametro Puleggia | Ø100 |
| Numero Denti/Gole Puleggia | 6 |
| Posizione Attacco | 80.6 |
| Diametro Girante | Ø70 |
| N° Alette Girante | 7 |
| Posizione Girante | 28 |

KW

ALFA ROMEO
145

| | | | | | |
|--------|----|---------------|---|---------------------|------------------------------------|
| 1.9 TD | 66 | 10/94 → 02/99 | D | AR33601, AR67501 | (-)COP, 10-1994 →, → 02-1999 |
|--------|----|---------------|---|---------------------|------------------------------------|

146

| | | | | | |
|--------|----|---------------|---|---------------------|------------------------------------|
| 1.9 TD | 66 | 12/94 → 02/99 | D | AR33601, AR67501 | (-)COP, 12-1994 →, → 09-1996 |
|--------|----|---------------|---|---------------------|------------------------------------|

81326
350981326000

KW

ALFA ROMEO
155

| | | | | | |
|--------|----|---------------|---|---------|------------------------------------|
| 1.9 TD | 66 | 04/93 → 12/97 | D | AR67501 | (-)COP, 04-1993 →, → 02-1996 |
|--------|----|---------------|---|---------|------------------------------------|

FIAT
Tempra, Station Wagon

| | | | | | |
|--------|----|---------------|---|-------------------------|-------------------------------------|
| 1.9 TD | 66 | 05/90 → 08/96 | D | 160A6.000, 160D1.000 | (-)COP, → M: 1.071.902, (+)AC |
|--------|----|---------------|---|-------------------------|-------------------------------------|

Tipo I

| | | | | | |
|--------|----|---------------|---|---------------------------------------|---|
| 1.9 TD | 59 | 03/92 → 06/93 | D | 160B6.046 | (-)COP, → 12-1992, (+)SS, (+)AC |
| | 66 | 09/90 → 04/95 | D | 160A6.000, 160A6.046, 160D1.000 | (-)COP, → 12-1992, (+)AC, (+)SS, (+)AC |

LANCIA
Dedra, Station Wagon

| | | | | | |
|---------|----|---------------|---|---------------------------------------|----------------------|
| 1.9 TDS | 66 | 04/89 → 07/99 | D | 160D1.000, 835A4.000, 835A4.046 | (-)COP, → 04-1994 |
|---------|----|---------------|---|---------------------------------------|----------------------|

81329
350981329000

PULEGGIA

| | |
|-------------------|-------|
| Diametro Puleggia | Ø60.5 |
| Altezza Puleggia | 29 |
| Posizione Attacco | 39 |
| Diametro Girante | Ø76 |
| N° Alette Girante | 8 |
| Posizione Girante | 17.2 |

KW

FIAT
Brava

| | | | | | |
|-----|-----|---------------|---|-----------|--|
| 2.0 | 113 | 09/98 → 08/00 | B | 182B7.000 | |
|-----|-----|---------------|---|-----------|--|

Bravo I

| | | | | | |
|----------------|-----|---------------|---|-----------|-----------|
| 2.0 HGT 20V | 108 | 10/95 → 07/98 | B | 182A1.000 | 10-1995 → |
| | 113 | 07/98 → 10/01 | B | 182B7.000 | |

Coupé

| | | | | | |
|------------------|-----|---------------|---|-----------|-----------|
| 2.0 20V | 108 | 08/96 → 04/98 | B | 182A1.000 | 09-1996 → |
| | 113 | 04/98 → 08/00 | B | 182B3.000 | |
| 2.0 20V Turbo | 162 | 08/96 → 08/00 | B | 175A3.000 | 09-1996 → |

81329 350981329000



FIAT

Marea, Weekend

| | | | | | |
|-------------|-----|---------------|---|-----------|-----------|
| 2.0 150 20V | 108 | 09/96 → 04/99 | B | 182A1.000 | 10-1996 → |
| | 110 | 01/01 → 05/02 | B | 185A8.000 | |
| 2.0 155 20V | 113 | 04/99 → 01/01 | B | 182B7.000 | |

Stilo, Station Wagon

| | | | | | |
|---------|-----|---------------|---|-----------|--|
| 2.4 20V | 125 | 10/01 → 11/06 | B | 192A2.000 | |
|---------|-----|---------------|---|-----------|--|

LANCIA

Kappa, Station Wagon, Coupé

| | | | | | |
|---------------|-----|---------------|---|----------------------|--|
| 2.0 20V | 114 | 07/96 → 03/01 | B | 838A6.000 | |
| | 107 | 10/94 → 10/01 | B | 838A1.000 | |
| | 114 | 07/96 → 10/01 | B | 838A6.000 | |
| 2.0 20V Turbo | 162 | 06/98 → 10/01 | B | 175A3.000 | |
| 2.4 20V | 129 | 11/96 → 03/01 | B | 838A2.000 | |
| | 129 | 08/94 → 10/01 | B | 838A2.000, 838A2.027 | |

Lybra, Station Wagon

| | | | | | |
|---------|-----|---------------|---|-----------|--|
| 2.0 20V | 110 | 09/00 → 10/05 | B | 185A8.000 | |
| | 113 | 07/99 → 09/00 | B | 182B7.000 | |
| 2.4 20V | 125 | 10/01 → 10/05 | B | 192A2.000 | |

Thesis

| | | | | | |
|-----------|-----|---------------|---|----------|--|
| 2.0 Turbo | 136 | 07/02 → 07/09 | B | 841E.000 | |
| 2.4 | 125 | 07/02 → 07/09 | B | 841D.000 | |

81330 350981330000



| | |
|-------------------|------|
| PULEGGIA | |
| Diametro Puleggia | Ø48 |
| Altezza Puleggia | 32 |
| Posizione Attacco | 39.2 |
| Diametro Girante | Ø76 |
| N° Alette Girante | 8 |
| Posizione Girante | 17.2 |



FIAT

Brava

| | | | | | |
|--------------|----|---------------|---|-----------|-----------|
| 1.9 JTD | 74 | 09/00 → 10/01 | D | 182B9.000 | |
| 1.9 TD 100 S | 74 | 03/96 → 10/01 | D | 182A7.000 | 09-1996 → |

Bravo I

| | | | | | |
|--------------|----|---------------|---|-----------|-----------|
| 1.9 JTD | 74 | 09/00 → 10/01 | D | 182B9.000 | |
| 1.9 TD 100 S | 74 | 03/96 → 10/01 | D | 182A7.000 | 09-1996 → |

81330 350981330000



FIAT

Marea, Weekend

| | | | | | |
|-------------|----|---------------|---|----------------------|-----------|
| 1.9 TD 100 | 74 | 09/96 → 05/02 | D | 182A7.000 | |
| | 74 | 09/96 → 05/02 | D | 182A7.000, 182B9.000 | |
| 1.9 TD 75 | 55 | 09/96 → 05/02 | D | 182A8.000 | → 04-1999 |
| 2.4 JTD 130 | 96 | 04/99 → 05/02 | D | 185A6.000, 839A5.000 | |
| 2.4 TD 125 | 91 | 09/96 → 04/99 | D | 185A2.000 | 11-1996 → |

LANCIA

Kappa, Station Wagon, Coupé

| | | | | | |
|----------|----|---------------|---|----------------------|-------------------------|
| 2.4 T.DS | 91 | 08/94 → 10/01 | D | 838A3.000, 838A7.000 | → 08-1997, → M: 727.390 |
|----------|----|---------------|---|----------------------|-------------------------|

81331 350981331000



| | |
|-------------------|-------|
| PULEGGIA | |
| Diametro Puleggia | Ø71.1 |
| Altezza Puleggia | 30.3 |
| Posizione Attacco | 38.9 |
| Diametro Girante | Ø76 |
| N° Alette Girante | 8 |
| Posizione Girante | 17.2 |



ALFA ROMEO

145

| | | | | | |
|-------------------|-----|---------------|---|---------------------------|--|
| 1.4 i.e. 16V T.S. | 76 | 12/96 → 01/01 | B | AR33503, AR38501 | |
| 1.8 i.e. 16V | 106 | 03/98 → 01/01 | B | AR32201 | |
| 1.8 i.e. 16V T.S. | 103 | 12/96 → 12/98 | B | AR38401, AR67106, AR67199 | |

| | | | | | |
|----------------------|-----|---------------|---|---------|--|
| 2.0 16V Quadrifoglio | 114 | 03/98 → 01/01 | B | AR32301 | |
|----------------------|-----|---------------|---|---------|--|

| | | | | | |
|--------------|-----|---------------|---|---------|--|
| 2.0 16V T.S. | 110 | 10/95 → 01/01 | B | AR67204 | |
|--------------|-----|---------------|---|---------|--|

146

| | | | | | |
|----------------------|-----|---------------|---|------------------|-----------|
| 1.4 i.e. 16V T.S. | 76 | 11/96 → 01/01 | B | AR33503, AR38501 | |
| 1.8 i.e. 16V T.S. | 103 | 11/96 → 01/01 | B | AR38401, AR67106 | |
| | 106 | 03/98 → 01/01 | B | AR32201 | |
| 2.0 16V Quadrifoglio | 114 | 03/98 → 01/01 | B | AR32301 | |
| 2.0 16V T.S. | 110 | 10/95 → 01/01 | B | AR67204 | 10-1995 → |

81331 350981331000

ALFA ROMEO
147

| | | | | | |
|---------------------|-----|---------------|---|-----------|--|
| 1.6 16V T.SPARK | 88 | 01/01 → 03/10 | B | AR32104 | |
| 1.6 16V T.SPARK ECO | 77 | 01/01 → 03/10 | B | AR37203 | |
| 2.0 | 121 | 07/02 → 05/05 | B | 937A1.000 | |
| 2.0 16V T.SPARK | 110 | 01/01 → 03/10 | B | AR32310 | |

155

| | | | | | |
|--------------|-----|---------------|---|------------------|--|
| 2.0 T.S. 16V | 110 | 03/95 → 12/97 | B | AR67204, AR67299 | |
|--------------|-----|---------------|---|------------------|--|

156, Sportwagon

| | | | | | |
|-----------------|-----|---------------|---|------------------------------------|-----------|
| 1.6 16V T.SPARK | 88 | 09/97 → 09/05 | B | AR32102, AR32103, AR32104, AR67601 | 05-2000 → |
| | 88 | 05/00 → 05/06 | B | AR32102, AR32103, AR32104, AR67601 | |
| 1.8 16V T.SPARK | 106 | 05/00 → 10/00 | B | AR32201 | |
| 2.0 16V T.SPARK | 110 | 10/00 → 03/02 | B | AR32310 | |
| | 114 | 09/97 → 10/00 | B | AR32301 | 11-1997 → |
| | 114 | 05/00 → 06/02 | B | AR32301 | |
| 2.0 JTS | 119 | 11/97 → 09/05 | B | 932A2.000 | |
| 2.0 JTS | 122 | 03/02 → 09/05 | B | 937A1.000 | |

159, Sportwagon

| | | | | | |
|---------|-----|---------------|---|-----------|--|
| 1.8 TBi | 147 | 05/09 → 11/11 | B | 939B1.000 | |
|---------|-----|---------------|---|-----------|--|

166

| | | | | | |
|-------------|-----|---------------|---|---------|--|
| 2.0 T.Spark | 110 | 10/00 → 06/07 | B | AR36301 | |
| | 114 | 09/98 → 10/00 | B | AR34103 | |

Brera

| | | | | | |
|---------|-----|---------------|---|-----------|--|
| 1.8 TBi | 147 | 05/09 → 06/10 | B | 939B1.000 | |
|---------|-----|---------------|---|-----------|--|

Giulietta III

| | | | | | |
|---------|-----|---------|---|-----------|--|
| 1.8 TBi | 173 | 04/10 → | B | 940A1.000 | |
| | 177 | 09/13 → | B | 960A1.000 | |

GT II

| | | | | | |
|---------|-----|---------------|---|----------------------|--|
| 2.0 JTS | 119 | 12/06 → 09/10 | B | 932A2.000 | |
| | 121 | 11/03 → 09/10 | B | 932A2.000, 937A1.000 | |

81331 350981331000

ALFA ROMEO
GTV II

| | | | | | |
|-----------------|-----|---------------|---|------------------|--|
| 1.8 16V | 106 | 05/98 → 10/05 | B | AR32201 | |
| 2.0 JTS | 121 | 04/03 → 10/05 | B | 937A1.000 | |
| 2.0 T.SPARK 16V | 110 | 06/95 → 10/05 | B | AR16201, AR32310 | |
| | 114 | 05/98 → 08/00 | B | AR32301 | |

Spider IV

| | | | | | |
|-----------------|-----|---------------|---|------------------|--|
| 1.8 16V | 106 | 05/98 → 04/05 | B | AR32201 | |
| 2.0 JTS | 121 | 04/03 → 04/05 | B | 937A1.000 | |
| 2.0 T.SPARK 16V | 110 | 06/95 → 04/05 | B | AR16201, AR32310 | |
| | 114 | 05/98 → 08/00 | B | AR32301 | |

Spider V

| | | | | | |
|---------|-----|---------------|---|-----------|--|
| 1.8 TBi | 147 | 05/09 → 06/10 | B | 939B1.000 | |
|---------|-----|---------------|---|-----------|--|

FIAT
Barchetta

| | | | | | |
|---------|----|---------------|---|----------------------|-----------|
| 1.8 16V | 96 | 04/95 → 05/05 | B | 183A1.000, 188A6.000 | → 08-2000 |
|---------|----|---------------|---|----------------------|-----------|

Brava

| | | | | | |
|------------|----|---------------|---|-----------|-----------|
| 1.8 GT 16V | 83 | 10/95 → 10/01 | B | 182A2.000 | 10-1995 → |
|------------|----|---------------|---|-----------|-----------|

Bravo I

| | | | | | |
|--------|----|---------------|---|-----------|-----------|
| 1.8 GT | 83 | 10/95 → 10/01 | B | 182A2.000 | 10-1995 → |
|--------|----|---------------|---|-----------|-----------|

Coupé

| | | | | | |
|---------|----|---------------|---|-----------|--|
| 1.8 16V | 96 | 03/96 → 08/00 | B | 183A1.000 | |
|---------|----|---------------|---|-----------|--|

Marea, Weekend

| | | | | | |
|-------------|----|---------------|---|-----------|--|
| 1.8 115 16V | 83 | 09/96 → 05/02 | B | 182A2.000 | |
|-------------|----|---------------|---|-----------|--|

Punto II, Cabrio, Van

| | | | | | |
|-------------|----|---------|---|----------------------|--------------------------|
| 1.8 130 HGT | 96 | 09/99 → | B | 183A1.000, 188A6.000 | → 08-2000, M: 183 A1.000 |
|-------------|----|---------|---|----------------------|--------------------------|

LANCIA
Dedra, Station Wagon

| | | | | | |
|------------|----|---------------|---|-----------|--|
| 1.8 16V LE | 83 | 03/96 → 07/99 | B | 182A2.000 | |
| 1.8 GT 16V | 96 | 03/96 → 07/99 | B | 183A1.000 | |

Delta II

| | | | | | |
|-----------------|----|---------------|---|-----------|--|
| 1.8 i.e. 16V | 83 | 03/96 → 08/99 | B | 182A2.000 | |
| 1.8 i.e. 16V GT | 96 | 03/96 → 08/99 | B | 183A1.000 | |

Delta III

| | | | | | |
|-----|-----|---------------|---|-----------|--|
| 1.8 | 147 | 01/09 → 08/14 | B | 939B1.000 | |
|-----|-----|---------------|---|-----------|--|

Lybra, Station Wagon

| | | | | | |
|---------|----|---------------|---|---------------------------------|--|
| 1.8 16V | 96 | 07/99 → 10/05 | B | 839A4.000, 839A7.000 | |
| 1.8 16V | 96 | 07/99 → 10/05 | B | 839A4.000, 839A7.000, 839A9.000 | |

81331
350981331000

LANCIA
Thema I, Station Wagon

3000 V6 126 08/92 → 07/94 B 834F.000

81332
350981332000

ALBERINO

 Diametro Alberino M14×1.5 SX
 Tipo Filetto Alberino Maschio
 Posizione Attacco 130
 Diametro Girante Ø93.5
 N° Alette Girante 8
 Posizione Girante 14.5

IVECO
Daily II

| | | | | | |
|---------|----|---------------|---|---|-----------|
| 30-10 | 76 | 01/97 → 05/99 | D | 8140.23. | |
| 30-10 C | 76 | 01/97 → 05/99 | D | 8140.23. | |
| 30-8 | 55 | 01/92 → 08/98 | D | 8140.07.2700 | 01-1996 → |
| | 55 | 01/89 → 08/98 | D | 8140.07.2700, 8140.07.2712 | |
| | 60 | 01/89 → 08/98 | D | 8140.67F., 8140.67F.3710, 8140.67F.3711, 8140.67F.3713, 8140.67F.3721 | |
| | 60 | 01/92 → 08/98 | D | 8140.67F., 8140.67F.3710, 8140.67F.3711, 8140.67F.3713, 8140.67F.3721 | 01-1996 → |
| | 62 | 09/98 → 05/99 | D | 8140.63. | |
| 30-8 V | 62 | 09/98 → 05/99 | D | 8140.63. | |
| 35-10 | 76 | 01/96 → 05/99 | D | 8140.23. | |
| 35-10 K | 76 | 01/97 → 05/99 | D | 8140.23. | |
| 35-12 | 90 | 05/96 → 05/99 | D | 8140.43. | |
| 35-12 K | 90 | 09/96 → 08/98 | D | 8140.43. | |
| 35-8 | 62 | 09/98 → 05/99 | D | 8140.63. | |
| 35-8 K | 62 | 09/98 → 05/99 | D | 8140.63. | |
| 49-10 | 76 | 05/96 → 05/99 | D | 8140.23. | |
| 49-10 K | 76 | 05/96 → 05/99 | D | 8140.23. | |
| 49-12 | 90 | 05/96 → 05/99 | D | 8140.43. | |
| 49-12 K | 90 | 05/96 → 05/99 | D | 8140.43. | |
| 49-12 V | 90 | 05/96 → 05/99 | D | 8140.43. | |
| 59-12 K | 90 | 05/96 → 05/99 | D | 8140.43. | |
| 59-12 V | 90 | 05/96 → 05/99 | D | 8140.43. | |

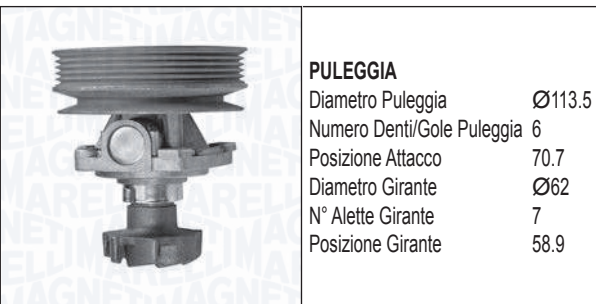
81333
350981333000

PULEGGIA

 Diametro Puleggia Ø113.5
 Numero Denti/Gole Puleggia 6
 Posizione Attacco 70.7
 Diametro Girante Ø62
 N° Alette Girante 7
 Posizione Girante 58.9

FIAT
Tempra, Station Wagon

| | | | | | |
|----------|----|---------------|---|-------------------------|---|
| 1.4 i.e. | 51 | 03/92 → 08/96 | B | 160A1.046, 836A4.000 | → 12-1992, → M: 9.336.692, (+)SS, (+)AC |
| | 51 | 10/92 → 08/96 | B | 160A1.046, 836A4.000 | → 12-1992, → M: 9.336.692 |
| | 57 | 03/91 → 08/96 | B | 159A2.000 | → 12-1992, → M: 9.336.692 |
| 1.6 | 51 | 04/90 → 06/93 | B | 159A3.048 | (+)SS, (+)AC |
| | 63 | 12/90 → 04/93 | B | 159A3.000 | (+)SS, (+)AC |
| | 63 | 03/90 → 04/93 | B | 159A3.000, 159B9.000 | (+)SS, (+)AC |
| 1.6 i.e. | 57 | 06/90 → 07/92 | B | 159A3.046 | (+)SS, (+)AC |
| | 57 | 10/90 → 08/96 | B | 159A3.046, 835C1.000 | → 12-1992, (+)AC, (+)SS, (+)AC |

Tipo I

| | | | | | |
|----------|----|---------------|---|-------------------------|--------------|
| 1.4 i.e. | 57 | 05/89 → 04/95 | B | 159A2.000 | (+)AC, (+)SS |
| | 51 | 05/89 → 04/95 | B | 160A1.046, 836A4.000 | (+)AC, (+)SS |
| 1.6 | 61 | 01/88 → 10/91 | B | 160A2.000 | (+)AC, (+)SS |
| 1.6 i.e. | 55 | 10/92 → 04/95 | B | 159A3.048, 835C1.000 | (+)AC, (+)SS |
| | 57 | 07/90 → 01/93 | B | 159A3.046 | (+)AC, (+)SS |

Uno I

| | | | | | |
|-------------|----|---------------|---|-----------|--------------|
| 70 i.e. 1.4 | 51 | 09/89 → 12/93 | B | 160A1.046 | (+)SS, (+)AC |
| | 53 | 09/89 → 12/93 | B | 146C1.000 | (+)SS, (+)AC |

LANCIA
Dedra, Station Wagon

| | | | | | |
|----------|----|---------------|---|-----------|-------|
| 1.6 i.e. | 57 | 08/89 → 03/93 | B | 835A1.046 | (+)SS |
| | 66 | 08/89 → 06/94 | B | 835A1.000 | (+)SS |

Delta II

| | | | | | |
|----------|----|---------------|---|-------------------------|-----------|
| 1.4 i.e. | 51 | 10/94 → 08/99 | B | 160A1.046, 836A4.000 | → 03-1995 |
| 1.6 i.e. | 55 | 06/93 → 08/99 | B | 835C1.000 | → 03-1995 |

81334
350981334000

FLANGIA

| | |
|-------------------------|---------|
| Numero Fori Flangia | 3 |
| Dimensione Fori Flangia | M8×1.25 |
| Posizione Attacco | 82.75 |
| Diametro Mozzo | Ø27.88 |
| Diametro Girante | Ø93.5 |
| N° Alette Girante | 8 |
| Posizione Girante | 14.5 |

KW

IVECO
Daily II

| | | | | | |
|---------|----|---------------|---|--------------------------------|-------------------------|
| 30-8 | 55 | 01/92 → 08/98 | D | 8140.07.2700 | → 12-1995 |
| | 60 | 01/92 → 08/98 | D | 8140.67F. | → 12-1995 |
| 35-10 | 68 | 01/89 → 12/96 | D | 8140.97.2781 | 01-1991 →, → 12-1995 |
| | 76 | 01/89 → 12/96 | D | 8140.47R.2790 | 01-1991 →, → 12-1995 |
| 40-10 V | 76 | 01/90 → 04/96 | D | 8140.27.2720 | |
| 45-10 | 76 | 01/89 → 04/96 | D | 8140.27.2720 | |
| 45-10 V | 76 | 01/89 → 04/96 | D | 8140.27.2720 | |
| 49-10 | 76 | 01/89 → 04/96 | D | 8140.27.2700, 8140.47R.2790 | |
| 49-10 K | 76 | 01/89 → 04/96 | D | 8140.27.2700, 8140.47R.2790 | |
| 49-10 V | 76 | 01/89 → 04/96 | D | 8140.27.2700, 8140.47R.2790 | |
| A 40-10 | 76 | 01/91 → 12/96 | D | 8140.27.2720 | |
| | 76 | 01/91 → 04/96 | D | 8140.27.2720 | |

RENAULT
Master I

| | | | | | |
|-------------|----|---------------|---|-------------------------|--|
| 28-35 2,5 D | 55 | 08/89 → 07/98 | D | 8140.67.2510, S8U742 | |
| | 52 | 09/80 → 07/98 | D | 8140.61.2300, S8U731 | |
| | 55 | 08/89 → 07/98 | D | 8140.67.2510, S8U742 | |

Trafic I

| | | | | | |
|-------|----|---------------|---|---|--|
| 2.5 D | 51 | 05/89 → 03/01 | D | 8140.61.240, S8U720, S8U722 | |
| | 55 | 05/89 → 03/01 | D | 8140.67.2500, 8140.67.2550, 8140.67.2580, S8U750, S8U752, S8U758 | |

81339
350981339000

PULEGGIA

| | |
|----------------------------|--------|
| Diametro Puleggia | Ø118.5 |
| Numero Denti/Gole Puleggia | 6 |
| Posizione Attacco | 73.45 |
| Diametro Girante | Ø60 |
| N° Alette Girante | 8 |
| Posizione Girante | 41.5 |

KW

FIAT
Punto I, Cabrio, Van

| | | | | | |
|--------|-------|---------------|---------------|-----------|-----------|
| 1.4 GT | 96 | 09/96 → 09/99 | B | 176B6.000 | (-)COP |
| | Turbo | 98 | 01/94 → 09/96 | B | 176A4.000 |
| 1.6 | 65 | 01/94 → 04/97 | B | 176A9.000 | (-)COP |

Palio I, Weekend

| | | | | | |
|----------|----|---------|---|-----------|---------------|
| 1.4 | 51 | 04/96 → | B | 178B2.000 | (-)COP, (+)AC |
| 1.4 Cat. | 51 | 04/96 → | B | 178B2.016 | (-)COP, (+)AC |

Punto I, Cabrio, Van

| | | | | | |
|--------|----|---------------|---|-----------|----------------------|
| 90 1.6 | 65 | 04/94 → 04/97 | B | 176A9.000 | (-)COP, 10-1993 → |
|--------|----|---------------|---|-----------|----------------------|

Siena I

| | | | | | |
|----------|----|---------------|---|-----------|-------------------------|
| 1.4 | 51 | 04/96 → 12/09 | B | 178B2.000 | (-)COP, (+)SS, (+)AC |
| 1.4 Cat. | 51 | 04/96 → 12/09 | B | 178B2.016 | (-)COP, (+)SS, (+)AC |

Tempra, Station Wagon

| | | | | | |
|----------|----|---------------|---|-------------------------|---|
| 1.4 i.e. | 51 | 03/92 → 08/96 | B | 160A1.046, 836A4.000 | (-)COP, 01-1993 →, M →: 9.336.693, (+)AC |
| | 51 | 10/92 → 08/96 | B | 160A1.046, 836A4.000 | (-)COP, 01-1993 →, (+)AC |
| | 57 | 03/91 → 08/96 | B | 159A2.000 | (-)COP, 01-1993 →, (+)AC |
| 1.6 i.e. | 55 | 06/92 → 08/96 | B | 159A3.048, 835C1.000 | (-)COP, (+)AC |
| | 57 | 10/90 → 08/96 | B | 159A3.046, 835C1.000 | (-)COP, 01-1993 →, (+)AC |
| | 63 | 06/94 → 08/96 | B | 159B9.000 | (-)COP, (+)AC |
| | 66 | 06/94 → 08/96 | B | 159B9.000 | (-)COP, (+)AC |

81339
350981339000

LANCIA
Dedra, Station Wagon

| | | | | | |
|----------|----|---------------|---|-----------|--------|
| 1.6 | 66 | 10/94 → 07/99 | B | 159B9.000 | (-)COP |
| 1.6 16V | 76 | 01/96 → 07/99 | B | 182A4.000 | (-)COP |
| 1.6 i.e. | 55 | 04/93 → 07/99 | B | 835C1.000 | (-)COP |
| 1.6 LE | 66 | 07/94 → 07/99 | B | 159B9.000 | (-)COP |

Delta II

| | | | | | |
|----------|----|---------------|---|-------------------------|--|
| 1.4 i.e. | 51 | 10/94 → 08/99 | B | 160A1.046, 836A4.000 | (-)COP, 04-1995 → |
| 1.6 i.e. | 55 | 06/93 → 08/99 | B | 835C1.000 | (-)COP, 04-1995 →, (+) SS, (+)AC |

81340
350981340000

PULEGGIA

| | |
|-------------------|-------|
| Diametro Puleggia | Ø60.5 |
| Altezza Puleggia | 26 |
| Posizione Attacco | 33.5 |
| Diametro Girante | Ø66 |
| N° Alette Girante | 8 |
| Posizione Girante | 17.2 |

FIAT
Brava

| | | | | | |
|----------|----|---------------|---|-----------|----------------------------|
| 1.4 | 55 | 10/95 → 10/01 | B | 182A5.000 | → 12-1997, → M: 705.144 |
| 1.4 12 V | 59 | 10/95 → 08/98 | B | 182A3.000 | → 12-1997, → M: 705.144 |

Bravo I

| | | | | | |
|-----|----|---------------|---|-----------|----------------------------|
| 1.4 | 55 | 10/95 → 10/01 | B | 182A5.000 | → 12-1997, → M: 705.144 |
| | 59 | 10/95 → 10/01 | B | 182A3.000 | → 12-1997, → M: 705.144 |

Marea, Weekend

| | | | | | |
|------------|----|---------------|---|-----------|----------------------------|
| 1.4 80 12V | 59 | 09/96 → 05/02 | B | 182A3.000 | → 12-1997, → M: 705.144 |
|------------|----|---------------|---|-----------|----------------------------|

LANCIA
Y

| | | | | | |
|---------|----|---------------|---|-----------|--------------|
| 1.4 12V | 55 | 03/96 → 09/03 | B | 840A4.000 | → M: 705.144 |
| | 59 | 10/96 → 09/03 | B | 840A2.000 | → M: 705.144 |

81341
350981341000

PULEGGIA

| | |
|----------------------------|------------------|
| Diametro Puleggia | Ø118.5 / Ø107 |
| Numero Denti/Gole Puleggia | 5 / 3 |
| Posizione Attacco | 84.9 |
| Diametro Girante | Ø60 |
| N° Alette Girante | 8 |
| Posizione Girante | 41.5 |

FIAT
Brava

| | | | | | |
|---------|----|---------------|---|-----------|--------|
| 1.6 16V | 66 | 10/95 → 10/01 | B | 182A6.000 | (+)COP |
| | 76 | 02/96 → 10/01 | B | 182A4.000 | (+)COP |
| | 76 | 01/99 → 12/02 | B | 182B6.000 | (+)COP |

Bravo I

| | | | | | |
|---------|----|---------------|---|-----------|----------------------|
| 1.6 | 76 | 09/00 → 10/01 | B | 182B6.000 | (+)COP |
| 1.6 16V | 66 | 10/95 → 10/01 | B | 182A6.000 | (+)COP, 10-1995 → |
| | 76 | 03/96 → 10/01 | B | 182A4.000 | (+)COP |

Doblò I, Cargo

| | | | | | |
|-------------------|----|---------|---|-----------|--------|
| 1.6 | 68 | 09/02 → | B | 182B6.000 | (+)COP |
| 1.6 16V | 76 | 10/01 → | B | 182B6.000 | (+)COP |
| 1.6 Natural Power | 76 | 09/02 → | | 182B6.000 | (+)COP |

Marea, Weekend

| | | | | | |
|-------------|----|---------------|---|-------------------------|--------|
| 1.6 | 68 | 03/99 → 08/00 | B | 185A3.000 | (+)COP |
| | 76 | 09/00 → 08/02 | B | 182B6.000 | (+)COP |
| 1.6 100 16V | 76 | 09/96 → 05/02 | B | 182A4.000 | (+)COP |
| | 76 | 04/99 → 05/02 | | 185A3.000, 186A4.000 | (+)COP |
| 1.6 16V | 75 | 04/97 → 02/99 | B | 185A3.000 | (+)COP |
| 1.6 SX | 72 | 09/00 → 08/02 | B | 182B5.098 | (+)COP |

Multipla

| | | | | | |
|---------------------|----|---------------|---|-----------|--------|
| 1.6 | 68 | 05/04 → 08/05 | G | 182B6.000 | (+)COP |
| | 74 | 03/01 → 08/05 | G | 182B6.000 | (+)COP |
| | 76 | 09/00 → 06/10 | B | 182B6.000 | (+)COP |
| 1.6 100 16V | 76 | 04/99 → 06/10 | B | 182A4.000 | (+)COP |
| 1.6 16V | 70 | 04/02 → 06/10 | B | 182B6.000 | (+)COP |
| 1.6 16V Bipower | 76 | 04/99 → 06/10 | | 186A4.000 | (+)COP |
| | 76 | 10/01 → 06/10 | | 182B6.000 | (+)COP |
| 1.6 16V Blupower | 70 | 04/99 → 06/10 | G | 186A3.000 | (+)COP |

Palio I, Weekend

| | | | | | |
|---------|----|---------------|---|-------------------------|--------|
| 1.5 | 62 | 02/02 → | B | 178E5.022 | (+)COP |
| 1.6 | 68 | 07/97 → 10/03 | B | 178C7.098, 178D2.011 | (+)COP |
| 1.6 16V | 74 | 04/96 → | B | 178B3.000 | (+)COP |

81341 350981341000

FIAT
Palio I, Weekend

| | | | | | |
|---------|----|---------------|---|-----------|----------------------|
| 1.6 16V | 74 | 04/96 → 02/01 | B | 178B3.000 | (+)COP, 07-1997 → |
| | 76 | 02/01 → | B | 182B6.000 | (+)COP |

Siena I

| | | | | | |
|-------------|----|---------------|----|-----------|--------|
| 1.5 Bipower | 57 | 09/03 → 12/05 | BF | 178A6.011 | (+)COP |
| 1.6 | 76 | 11/00 → 12/09 | B | 182B6.000 | (+)COP |
| 1.6 16V | 78 | 09/98 → 12/09 | B | 178B3.000 | (+)COP |

Stilo, Station Wagon

| | | | | | |
|---------|----|---------------|---|-----------|--------|
| 1.6 16V | 76 | 01/03 → 08/08 | B | 182B6.000 | (+)COP |
| | 77 | 05/05 → 11/06 | B | 192B3.000 | (+)COP |
| | 76 | 10/01 → 11/06 | B | 182B6.000 | (+)COP |

LANCIA
Delta II

| | | | | | |
|--------------|----|---------------|---|-----------|--------|
| 1.6 i.e. | 66 | 03/96 → 08/99 | B | 182A6.000 | (+)COP |
| 1.6 i.e. 16V | 76 | 01/96 → 08/99 | B | 182A4.000 | (+)COP |

Lybra, Station Wagon

| | | | | | |
|---------|----|---------------|---|-------------------------|--------|
| 1.6 | 76 | 10/00 → 10/05 | B | 182B6.000 | (+)COP |
| 1.6 16V | 76 | 07/99 → 10/05 | B | 182A4.000, 182B6.000 | (+)COP |

81342 350981342000

PULEGGIA

| | |
|----------------------------|-------|
| Diametro Puleggia | Ø100 |
| Numero Denti/Gole Puleggia | 7 |
| Posizione Attacco | 85.25 |
| Diametro Girante | Ø70 |
| N° Alette Girante | 9 |
| Posizione Girante | 28.4 |

FIAT
Brava

| | | | | | |
|-------|----|---------------|---|-----------|--------|
| 1.9 D | 48 | 10/95 → 10/01 | D | 160A7.000 | (+)COP |
|-------|----|---------------|---|-----------|--------|

Bravo I

| | | | | | |
|-------|----|---------------|---|-----------|--------|
| 1.9 D | 48 | 10/95 → 10/01 | D | 160A7.000 | (+)COP |
|-------|----|---------------|---|-----------|--------|

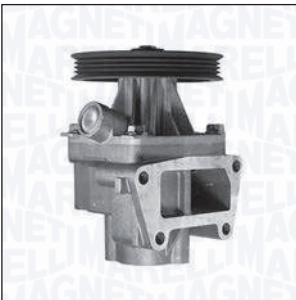
81343 350981343000

PULEGGIA

| | |
|----------------------------|--------|
| Diametro Puleggia | Ø118.5 |
| Numero Denti/Gole Puleggia | 4 |
| Posizione Attacco | 69.9 |
| Diametro Girante | Ø60 |
| N° Alette Girante | 8 |
| Posizione Girante | 41.5 |

FIAT
Fiorino III, Pick Up (Uno)

| | | | | | |
|-------------|----|---------------|---|-------------------------|---------------------------|
| 1.4 | 49 | 05/94 → 05/01 | B | 146D5.000 | (+)COP, M →: 9.470.269 |
| | 52 | 11/92 → 10/96 | B | 146C5.000 | (+)COP, M →: 9.470.269 |
| 1.6 | 55 | 01/94 → 05/01 | B | 146C6.000, 146D6.000 | (+)COP, M →: 9.470.269 |
| 70 i.e. 1.4 | 49 | 05/94 → 05/01 | B | 146C5.000, 146D5.000 | (+)COP, M →: 9.470.269 |
| 75 i.e. 1.6 | 55 | 10/93 → 05/01 | B | 146C6.000, 146D6.000 | (+)COP, M →: 9.470.269 |

Palio I, Weekend

| | | | | | |
|----------|----|---------|---|-----------|---------------|
| 1.4 | 51 | 04/96 → | B | 178B2.000 | (+)COP, (-)SS |
| 1.4 Cat. | 51 | 04/96 → | B | 178B2.016 | (+)COP, (-)SS |

Siena I

| | | | | | |
|----------|----|---------------|---|-----------|-------------------------|
| 1.4 | 51 | 04/96 → 12/09 | B | 178B2.000 | (+)COP, (-)AC, (-)SS |
| 1.4 Cat. | 51 | 04/96 → 12/09 | B | 178B2.016 | (+)COP, (-)AC, (-)SS |

Tempra, Station Wagon

| | | | | | |
|----------|----|---------------|---|-------------------------|-------------------------------------|
| 1.4 i.e. | 51 | 03/92 → 08/96 | B | 160A1.046, 836A4.000 | (+)COP, M →: 9.336.693, (-)SS |
| | 57 | 03/91 → 08/96 | B | 159A2.000 | (+)COP, M →: 9.336.693, (-)SS |

Uno I

| | | | | | |
|-----|----|---------------|---|-----------|--------|
| 1.4 | 51 | 07/91 → 07/96 | B | 160A1.046 | (+)COP |
| | 74 | 01/89 → 12/91 | B | 146A8.000 | (+)COP |

INNOCENTI
Elba

| | | | | | |
|----------|----|---------------|---|-------------------------|----------------------|
| 1.4 i.e. | 49 | 09/94 → 12/96 | B | 146C5.000, 146D5.000 | (+)COP, 03-1995 → |
|----------|----|---------------|---|-------------------------|----------------------|

81344
350981344000

FLANGIA

| | |
|---------------------|------|
| Numero Fori Flangia | 3 |
| Posizione Attacco | 61.5 |
| Diametro Mozzo | Ø23 |
| Diametro Centraggio | Ø26 |
| Diametro Girante | n.v. |
| N° Alette Girante | n.v. |
| Posizione Girante | n.v. |

KW

FIAT
Elba

| | | | | | |
|-------|----|---------------|---|-----------|--------------|
| 1.7 D | 43 | 04/89 → 12/96 | D | 146B2.000 | (+)SS, (+)AC |
|-------|----|---------------|---|-----------|--------------|

Fiorino III, Pick Up (Uno)

| | | | | | |
|-------|----|---------------|---|-----------|--------------|
| 1.7 D | 42 | 10/93 → 10/99 | D | 146B2.000 | (+)SS, (+)AC |
|-------|----|---------------|---|-----------|--------------|

| | | | | | |
|--|----|---------------|---|-----------|--------------|
| | 44 | 01/88 → 10/99 | D | 146B2.000 | (+)SS, (+)AC |
|--|----|---------------|---|-----------|--------------|

| | | | | | |
|--|----|---------------|---|-----------|--------------|
| | 44 | 05/88 → 10/99 | D | 149B3.000 | (+)SS, (+)AC |
|--|----|---------------|---|-----------|--------------|

| | | | | | |
|--------|----|---------------|---|-----------|--|
| 1.7 TD | 46 | 11/96 → 05/00 | D | 146D7.000 | |
|--------|----|---------------|---|-----------|--|

| | | | | | |
|--|----|---------------|---|-----------|--|
| | 46 | 01/97 → 05/01 | D | 146D7.000 | |
|--|----|---------------|---|-----------|--|

| | | | | | |
|----------|----|---------------|---|-----------|--------------|
| 60 1.7 D | 42 | 05/88 → 10/96 | D | 146B2.000 | (+)SS, (+)AC |
|----------|----|---------------|---|-----------|--------------|

| | | | | | |
|--|----|---------------|---|-----------|--------------|
| | 44 | 05/88 → 05/00 | D | 149B3.000 | (+)SS, (+)AC |
|--|----|---------------|---|-----------|--------------|

| | | | | | |
|-----------|----|---------------|---|-----------|--|
| 65 1.7 TD | 46 | 01/97 → 05/01 | D | 146D7.000 | |
|-----------|----|---------------|---|-----------|--|

INNOCENTI
Elba

| | | | | | |
|-------|----|---------------|---|-----------|--------------|
| 1.7 D | 42 | 08/91 → 12/96 | D | 146B2.000 | (+)SS, (+)AC |
|-------|----|---------------|---|-----------|--------------|

81346
350981346000

PULEGGIA

| | |
|----------------------------|--------|
| Diametro Puleggia | Ø118.5 |
| Numero Denti/Gole Puleggia | 7 |
| Posizione Attacco | 77 |
| Diametro Girante | Ø60 |
| N° Alette Girante | 8 |
| Posizione Girante | 41.5 |

KW

CITROËN
Jumpy I

| | | | | | |
|-----|----|---------|---|--------------------|--------|
| 1.6 | 58 | 10/95 → | B | 1580SPI, 220A2.000 | (+)COP |
|-----|----|---------|---|--------------------|--------|

| | | | | | |
|--|----|---------------|---|-----------|--------|
| | 59 | 10/95 → 08/00 | B | 220A2.000 | (+)COP |
|--|----|---------------|---|-----------|--------|

| | | | | | |
|-------|----|---------|---|--------------------|-------------------|
| 1.6 i | 58 | 10/95 → | B | 1580SPI, 220A2.000 | (+)COP, 10-1995 → |
|-------|----|---------|---|--------------------|-------------------|

| | | | | | |
|--|--|--|--|--|--|
| | | | | | |
|--|--|--|--|--|--|

FIAT
Scudo I

| | | | | | |
|-----|----|---------------|---|-----------|--------|
| 1.6 | 58 | 02/96 → 12/06 | B | 220A2.000 | (+)COP |
|-----|----|---------------|---|-----------|--------|

81346
350981346000

KW

PEUGEOT
Expert I

| | | | | | |
|-----|----|---------|---|-----------------|--------|
| 1.6 | 58 | 02/96 → | B | 222A2 (1580SPI) | (+)COP |
|-----|----|---------|---|-----------------|--------|

81347
350981347000

FLANGIA

| | |
|-------------------------|---------|
| Numero Fori Flangia | 3 |
| Dimensione Fori Flangia | M8×1.25 |
| Posizione Attacco | 78.5 |
| Diametro Mozzo | Ø22 |
| Diametro Centraggio | Ø25.95 |
| Diametro Girante | Ø70 |
| N° Alette Girante | 9 |
| Posizione Girante | 28.4 |

KW

ALFA ROMEO
145

| | | | | | |
|--------|----|---------------|---|------------------|------------------------------|
| 1.9 TD | 66 | 10/94 → 02/99 | D | AR33601, AR67501 | (+)COP, 10-1996 →, → 02-1999 |
|--------|----|---------------|---|------------------|------------------------------|

146

| | | | | | |
|--------|----|---------------|---|------------------|------------------------------|
| 1.9 TD | 66 | 12/94 → 02/99 | D | AR33601, AR67501 | (+)COP, 10-1996 →, → 02-1999 |
|--------|----|---------------|---|------------------|------------------------------|

155

| | | | | | |
|--------|----|---------------|---|---------|------------------------------|
| 1.9 TD | 66 | 04/93 → 12/97 | D | AR67501 | (+)COP, 02-1996 →, → 12-1997 |
|--------|----|---------------|---|---------|------------------------------|

FIAT
Tempra, Station Wagon

| | | | | | |
|-------|----|---------------|---|----------------------|--------|
| 1.9 D | 48 | 07/91 → 08/96 | D | 149A1.000, 160A7.000 | (+)COP |
|-------|----|---------------|---|----------------------|--------|

Tipo I

| | | | | | |
|-------|----|---------------|---|-----------|-------------------|
| 1.7 D | 43 | 01/88 → 10/94 | D | 149B4.000 | (+)COP, 01-1993 → |
|-------|----|---------------|---|-----------|-------------------|

| | | | | | |
|-------|----|---------------|---|-----------|-------------------|
| 1.7 D | 45 | 01/88 → 10/95 | D | 149B4.000 | (+)COP, 01-1993 → |
|-------|----|---------------|---|-----------|-------------------|

| | | | | | |
|-------|----|---------------|---|----------------------|-------------------|
| 1.9 D | 48 | 07/91 → 08/95 | D | 149A1.000, 160A7.000 | (+)COP, 01-1993 → |
|-------|----|---------------|---|----------------------|-------------------|

LANCIA
Dedra, Station Wagon

| | | | | | |
|---------|----|---------------|---|----------------------|--------|
| 1.9 TDS | 66 | 07/94 → 07/99 | D | 160D1.000, 835A4.000 | (+)COP |
|---------|----|---------------|---|----------------------|--------|

81347 350981347000

LANCIA
Dedra, Station Wagon

| | | | | | |
|---------|----|---------------|---|---------------------------------------|----------------------|
| 1.9 TDS | 66 | 04/89 → 07/99 | D | 160D1.000, 835A4.000, 835A4.046 | (+)COP, 05-1994 → |
|---------|----|---------------|---|---------------------------------------|----------------------|

Delta II

| | | | | | |
|--------|----|---------------|---|-------------------------|--------|
| 1.9 TD | 66 | 10/94 → 08/99 | D | 160D1.000, 835A4.000 | (+)COP |
|--------|----|---------------|---|-------------------------|--------|

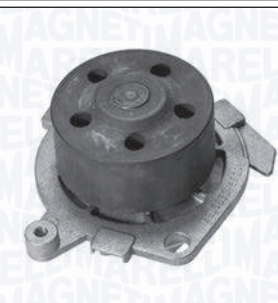
81348 350981348000

PULEGGIA

| | |
|-------------------|-------|
| Diametro Puleggia | Ø68 |
| Altezza Puleggia | 30.5 |
| Posizione Attacco | 38.75 |
| Diametro Girante | Ø76 |
| N° Alette Girante | 8 |
| Posizione Girante | 17.2 |

ALFA ROMEO
145

| | | | | |
|--------------|----|---------------|---|---------|
| 1.6 16V T.S. | 82 | 09/97 → 12/00 | B | AR32102 |
|--------------|----|---------------|---|---------|

| | | | | |
|-------------------|----|---------------|---|---------------------|
| 1.6 i.e. 16V T.S. | 88 | 12/96 → 01/01 | B | AR38201, AR67601 |
|-------------------|----|---------------|---|---------------------|

146

| | | | | |
|--------------|----|---------------|---|---------|
| 1.6 16V T.S. | 82 | 09/97 → 12/00 | B | AR32102 |
|--------------|----|---------------|---|---------|

| | | | | |
|-------------------|----|---------------|---|---------------------|
| 1.6 i.e. 16V T.S. | 88 | 11/96 → 01/01 | B | AR38201, AR67601 |
|-------------------|----|---------------|---|---------------------|

155

| | | | | | |
|--------------|----|---------------|---|---------|-----------|
| 1.6 16V T.S. | 88 | 05/96 → 12/97 | B | AR67601 | 05-1996 → |
|--------------|----|---------------|---|---------|-----------|

| | | | | | |
|--------------|-----|---------------|---|---------|-----------|
| 1.7 T.S. 16V | 103 | 05/96 → 12/97 | B | AR67106 | 05-1996 → |
|--------------|-----|---------------|---|---------|-----------|

156, Sportwagon

| | | | | |
|-----------------|----|---------------|---|---------|
| 1.6 16V T.SPARK | 82 | 09/97 → 09/05 | B | AR32102 |
|-----------------|----|---------------|---|---------|

| | | | | | |
|-----------------|----|---------------|---|---|-------------------------|
| 1.6 16V T.SPARK | 88 | 09/97 → 09/05 | B | AR32102, AR32103, AR32104, AR67601 | 11-1997 →, → 04-2000 |
|-----------------|----|---------------|---|---|-------------------------|

| | | | | |
|-----------------|-----|---------------|---|---------|
| 1.8 16V T.SPARK | 103 | 10/00 → 09/05 | B | AR32205 |
|-----------------|-----|---------------|---|---------|

| | | | | |
|-----------------|-----|---------------|---|---------|
| 1.8 16V T.SPARK | 106 | 09/97 → 10/00 | B | AR32201 |
|-----------------|-----|---------------|---|---------|

GT II

| | | | | |
|--------|-----|---------------|---|---------|
| 1.8 TS | 103 | 11/03 → 09/10 | B | AR32205 |
|--------|-----|---------------|---|---------|

81348 350981348000

FIAT
Barchetta

| | | | | | |
|---------|----|---------------|---|-------------------------|-----------|
| 1.8 16V | 96 | 04/95 → 05/05 | B | 183A1.000, 188A6.000 | 09-2000 → |
|---------|----|---------------|---|-------------------------|-----------|

Punto II, Cabrio, Van

| | | | | | |
|-------------|----|---------|---|-------------------------|-----------------------------|
| 1.8 130 HGT | 96 | 09/99 → | B | 183A1.000, 188A6.000 | 09-2000 →, M: 188 A6.000 |
|-------------|----|---------|---|-------------------------|-----------------------------|

Stilo, Station Wagon

| | | | | |
|---------|----|---------------|---|-----------|
| 1.8 16V | 98 | 01/03 → 08/08 | B | 192A4.000 |
| | 98 | 10/01 → 11/06 | B | 192A4.000 |

81351 350981351000

PULEGGIA

| | |
|-------------------|-------|
| Diametro Puleggia | Ø60.5 |
| Altezza Puleggia | 26 |
| Posizione Attacco | 33.2 |
| Diametro Girante | Ø66 |
| N° Alette Girante | 8 |
| Posizione Girante | 17.2 |

FIAT
Brava

| | | | | | |
|-----|----|---------------|---|-----------|----------------------------|
| 1.4 | 55 | 10/95 → 10/01 | B | 182A5.000 | 01-1998 →, M →: 705.145 |
|-----|----|---------------|---|-----------|----------------------------|

| | | | | | |
|----------|----|---------------|---|-----------|----------------------------|
| 1.4 12 V | 59 | 10/95 → 08/98 | B | 182A3.000 | 01-1998 →, M →: 705.145 |
|----------|----|---------------|---|-----------|----------------------------|

Bravo I

| | | | | | |
|-----|----|---------------|---|-----------|----------------------------|
| 1.4 | 55 | 10/95 → 10/01 | B | 182A5.000 | 01-1998 →, M →: 705.145 |
|-----|----|---------------|---|-----------|----------------------------|

| | | | | | |
|-----|----|---------------|---|-----------|----------------------------|
| 1.4 | 59 | 10/95 → 10/01 | B | 182A3.000 | 01-1998 →, M →: 705.145 |
|-----|----|---------------|---|-----------|----------------------------|

Marea, Weekend

| | | | | | |
|------------|----|---------------|---|-----------|----------------------------|
| 1.4 80 12V | 59 | 09/96 → 05/02 | B | 182A3.000 | 01-1998 →, M →: 705.145 |
|------------|----|---------------|---|-----------|----------------------------|

LANCIA
Y

| | | | | | |
|---------|----|---------------|---|-----------|--------------|
| 1.4 12V | 55 | 03/96 → 09/03 | B | 840A4.000 | M →: 705.145 |
|---------|----|---------------|---|-----------|--------------|

| | | | | | |
|---------|----|---------------|---|-----------|--------------|
| 1.4 12V | 59 | 10/96 → 09/03 | B | 840A2.000 | M →: 705.145 |
|---------|----|---------------|---|-----------|--------------|

81352

350981352000



PULEGGIA

| | |
|-------------------|------|
| Diametro Puleggia | Ø48 |
| Altezza Puleggia | 34 |
| Posizione Attacco | 41.2 |
| Diametro Girante | Ø76 |
| N° Alette Girante | 8 |
| Posizione Girante | 17.2 |



ALFA ROMEO

145

| | | | | |
|---------|----|---------------|---|---------|
| 1.9 JTD | 77 | 02/99 → 01/01 | D | AR32302 |
|---------|----|---------------|---|---------|

146

| | | | | |
|---------|----|---------------|---|---------|
| 1.9 JTD | 77 | 02/99 → 01/01 | D | AR32302 |
|---------|----|---------------|---|---------|

147

| | | | | |
|---------|----|---------------|---|-----------|
| 1.9 JTD | 74 | 06/03 → 03/10 | D | 182B9.000 |
| | 81 | 11/00 → 09/04 | D | AR37101 |
| | 85 | 04/01 → 03/10 | D | 937A2.000 |

| | | | | |
|----------|----|---------------|---|-----------|
| 1.9 JTDM | 85 | 10/04 → 03/10 | D | 939A7.000 |
|----------|----|---------------|---|-----------|

| | | | | |
|-------------|----|---------------|---|-----------|
| 1.9 JTDM 8V | 88 | 07/05 → 03/10 | D | 937A3.000 |
|-------------|----|---------------|---|-----------|

156, Sportwagon

| | | | | |
|---------|----|---------------|---|-----------|
| 1.9 JTD | 77 | 09/97 → 10/00 | D | AR32302 |
| | 81 | 10/00 → 05/01 | D | AR37101 |
| | 85 | 05/01 → 09/05 | D | 937A2.000 |

| | | | | |
|---------|-----|---------------|---|-----------|
| 2.4 JTD | 100 | 09/97 → 09/03 | D | AR32501 |
| | 103 | 10/00 → 09/05 | D | 839A6.000 |
| | 110 | 03/02 → 09/05 | D | 841C000 |

159, Sportwagon

| | | | | |
|-------------|----|---------------|---|----------------------|
| 1.9 JTDM 8V | 85 | 03/06 → 11/11 | D | 937A7.000 |
| | 85 | 09/05 → 11/11 | D | 937A7.000, 939A7.000 |
| | 88 | 09/05 → 11/11 | D | 939A1.000 |

166

| | | | | |
|---------|-----|---------------|---|-----------|
| 2.4 JTD | 110 | 04/02 → 06/07 | D | 841C000 |
| | 100 | 09/98 → 10/00 | D | AR34202 |
| | 103 | 10/00 → 06/07 | D | 839A6.000 |

FIAT

Brava

| | | | | |
|-------------|----|---------------|---|-----------|
| 1.9 JTD 105 | 77 | 12/98 → 10/01 | D | 182B4.000 |
|-------------|----|---------------|---|-----------|

| | | | | | |
|-------------|----|---------------|---|-----------|-----------|
| 1.9 TD 75 S | 55 | 03/96 → 10/01 | D | 182A8.000 | 09-1996 → |
|-------------|----|---------------|---|-----------|-----------|

Bravo I

| | | | | |
|-------------|----|---------------|---|-----------|
| 1.9 JTD 105 | 77 | 12/98 → 10/01 | D | 182B4.000 |
|-------------|----|---------------|---|-----------|

| | | | | | |
|-------------|----|---------------|---|-----------|-----------|
| 1.9 TD 75 S | 55 | 03/96 → 10/01 | D | 182A8.000 | 09-1996 → |
|-------------|----|---------------|---|-----------|-----------|

81352

350981352000



Bravo II, Van

| | | | | |
|----------------|----|---------------|---|----------------------|
| 1.9 D Multijet | 66 | 04/07 → 12/08 | D | 192B5.000 |
| | 85 | 11/06 → | D | 192A1.000, 192B4.000 |
| | 88 | 04/07 → | D | 192A8.000 |

| | | | | |
|----------------|----|---------|---|-----------|
| 1.9 D Multijet | 85 | 06/05 → | D | 939A7.000 |
|----------------|----|---------|---|-----------|

| | | | | |
|----------------|----|---------|---|-----------|
| 1.9 D Multijet | 88 | 06/05 → | D | 939A1.000 |
|----------------|----|---------|---|-----------|

Croma II

| | | | | |
|----------------|----|---------|---|-----------|
| 1.9 D Multijet | 85 | 06/05 → | D | 939A7.000 |
|----------------|----|---------|---|-----------|

| | | | | |
|----------------|----|---------|---|-----------|
| 1.9 D Multijet | 88 | 06/05 → | D | 939A1.000 |
|----------------|----|---------|---|-----------|

Doblò I, Cargo

| | | | | |
|-------|----|---------|---|-----------|
| 1.9 D | 46 | 03/01 → | D | 223A6.000 |
|-------|----|---------|---|-----------|

| | | | | |
|----------------|----|---------|---|-----------|
| 1.9 D Multijet | 88 | 10/05 → | D | 186A9.000 |
|----------------|----|---------|---|-----------|

| | | | | |
|---------|----|---------|---|----------------------|
| 1.9 JTD | 77 | 07/03 → | D | 223A7.000, 223B1.000 |
| | 74 | 10/01 → | D | 182B9.000 |
| | 74 | 10/01 → | D | 182B9.000, 223B2.000 |

| | | | | |
|------------------|----|---------|---|-----------|
| 1.9 JTD Multijet | 88 | 12/06 → | D | 186A9.000 |
|------------------|----|---------|---|-----------|

Grande Punto, Van

| | | | | |
|----------------|----|---------|---|-----------|
| 1.9 D Multijet | 88 | 10/05 → | D | 939A1.000 |
|----------------|----|---------|---|-----------|

| | | | | |
|----------------|----|---------|---|-----------|
| 1.9 D Multijet | 96 | 10/05 → | D | 199A5.000 |
|----------------|----|---------|---|-----------|

Idea

| | | | | |
|---------|----|---------|---|-----------|
| 1.9 JTD | 74 | 01/04 → | D | 188B2.000 |
|---------|----|---------|---|-----------|

Marea, Weekend

| | | | | |
|-------------|----|---------------|---|-----------|
| 1.9 JTD 105 | 77 | 04/99 → 01/01 | D | 182B4.000 |
|-------------|----|---------------|---|-----------|

| | | | | |
|-------------|----|---------------|---|-----------|
| 1.9 JTD 110 | 81 | 01/01 → 05/02 | D | 186A6.000 |
|-------------|----|---------------|---|-----------|

| | | | | | |
|-----------|----|---------------|---|-----------|-----------|
| 1.9 TD 75 | 55 | 09/96 → 05/02 | D | 182A8.000 | 05-1999 → |
|-----------|----|---------------|---|-----------|-----------|

| | | | | |
|-------------|----|---------------|---|----------------------|
| 2.4 JTD 130 | 96 | 04/99 → 05/02 | D | 185A6.000, 839A5.000 |
|-------------|----|---------------|---|----------------------|

Multipla

| | | | | |
|---------|----|---------------|---|-----------|
| 1.9 JTD | 88 | 04/02 → 06/10 | D | 186A9.000 |
|---------|----|---------------|---|-----------|

| | | | | |
|-------------|----|---------------|---|-----------|
| 1.9 JTD 105 | 77 | 04/99 → 06/10 | D | 182B4.000 |
|-------------|----|---------------|---|-----------|

| | | | | |
|-------------|----|---------------|---|-----------|
| 1.9 JTD 110 | 81 | 03/01 → 07/02 | D | 186A6.000 |
|-------------|----|---------------|---|-----------|

| | | | | |
|-------------|----|---------------|---|-----------|
| 1.9 JTD 115 | 85 | 07/02 → 06/10 | D | 186A8.000 |
|-------------|----|---------------|---|-----------|

Palio I, Weekend

| | | | | |
|-------|----|---------|---|-----------|
| 1.9 D | 46 | 03/01 → | D | 223A6.000 |
|-------|----|---------|---|-----------|

| | | | | |
|---------|----|---------|---|-----------|
| 1.9 JTD | 59 | 09/01 → | D | 188A2.000 |
|---------|----|---------|---|-----------|

Punto II, Cabrio, Van

| | | | | |
|----------|----|---------------|---|-----------|
| 1.9 D 60 | 44 | 02/00 → 10/09 | D | 188A3.000 |
|----------|----|---------------|---|-----------|

| | | | | |
|-----------|----|---------|---|-----------|
| 1.9 DS 60 | 44 | 09/99 → | D | 188A3.000 |
|-----------|----|---------|---|-----------|

| | | | | |
|---------|----|---------|---|-----------|
| 1.9 JTD | 63 | 10/01 → | D | 188A7.000 |
| | 74 | 06/03 → | D | 188B2.000 |

| | | | | |
|------------|----|---------|---|-----------|
| 1.9 JTD 80 | 59 | 09/99 → | D | 188A2.000 |
|------------|----|---------|---|-----------|

81352 350981352000

FIAT
Sedici

| | | | | | |
|--------------------|----|---------|---|-------|--|
| 1.9 D Multijet | 88 | 06/06 → | D | D19AA | |
| 1.9 D Multijet 4x4 | 88 | 06/06 → | D | D19AA | |

Siena I

| | | | | | |
|-------|----|---------|---|-----------|--|
| 1.9 D | 46 | 11/00 → | D | 223A6.000 | |
|-------|----|---------|---|-----------|--|

Stilo, Station Wagon

| | | | | | |
|----------|----|---------------|---|----------------------|--|
| 1.9 D | 66 | 09/04 → 08/08 | D | 192B5.000 | |
| 1.9 D | 74 | 09/05 → 11/06 | D | 192A9.000 | |
| Multijet | 88 | 09/05 → 11/06 | D | 192A8.000 | |
| 1.9 JTD | 59 | 01/03 → 08/08 | D | 192A3.000 | |
| | 85 | 01/03 → 08/08 | D | 192A1.000, 937A7.000 | |
| | 59 | 02/02 → 11/06 | D | 192A3.000 | |
| | 66 | 09/04 → 11/06 | D | 192B5.000 | |
| | 85 | 10/01 → 11/06 | D | 192A1.000, 937A7.000 | |

Strada

| | | | | | |
|---------|----|---------|---|-----------|--|
| 1.9 D | 46 | 12/00 → | D | 223A6.000 | |
| 1.9 JTD | 59 | 04/03 → | D | 188A2.000 | |

LANCIA
Kappa, Station Wagon, Coupé

| | | | | | |
|----------|-----|---------------|---|----------------------|-------------------------|
| 2.4 JTD | 100 | 06/98 → 10/01 | D | 838A8.000 | |
| 2.4 T.DS | 91 | 08/94 → 10/01 | D | 838A3.000, 838A7.000 | 09-1997 →, M →: 727.391 |

Lybra, Station Wagon

| | | | | | |
|---------|-----|---------------|---|--------------------|--|
| 1.9 JTD | 85 | 05/01 → 10/05 | D | 937A2.000 | |
| | 77 | 07/99 → 09/00 | D | AR32302 | |
| | 81 | 09/00 → 05/01 | D | AR37101 | |
| 2.4 JTD | 110 | 05/02 → 10/05 | D | 841C.000 | |
| | 99 | 07/99 → 02/01 | D | 839A5.000, AR32501 | |
| | 103 | 09/00 → 05/02 | D | 839A6.000 | |

Musa

| | | | | | |
|----------------|----|---------------|---|-----------|--|
| 1.9 D Multijet | 74 | 10/04 → 09/12 | D | 188B2.000 | |
|----------------|----|---------------|---|-----------|--|

Thesis

| | | | | | |
|---------|-----|---------------|---|----------|--|
| 2.4 JTD | 110 | 07/02 → 07/09 | D | 841C.000 | |
|---------|-----|---------------|---|----------|--|

OPEL
Astra H, Station Wagon, GTC, Twin Top, Van

| | | | | | |
|----------|----|---------|---|--------|--|
| 1.9 CDTI | 74 | 09/05 → | D | Z19DTL | |
| | 88 | 06/04 → | D | Z19DT | |

Signum

| | | | | | |
|----------|----|---------|---|-------|--|
| 1.9 CDTI | 74 | 08/05 → | D | Z19DT | |
| | 88 | 04/04 → | D | Z19DT | |

81352 350981352000

OPEL
Vectra C, Station Wagon

| | | | | | |
|----------|----|---------|---|--------|--|
| 1.9 CDTI | 74 | 10/05 → | D | Z19DT | |
| | 74 | 10/05 → | D | Z19DTL | |
| | 88 | 04/04 → | D | Z19DT | |

Zafira B, Van

| | | | | | |
|----------|----|---------|---|--------|--|
| 1.9 CDTI | 74 | 07/05 → | D | Z19DTL | |
| | 88 | 07/05 → | D | Z19DT | |

SAAB
9-3 II, Station Wagon, Cabrio

| | | | | | |
|---------|----|---------|---|-------|--|
| 1.9 TiD | 88 | 09/04 → | D | Z19DT | |
|---------|----|---------|---|-------|--|

SUZUKI
SX4

| | | | | | |
|--------------|----|---------|---|-------|--|
| 1.9 DDiS | 88 | 06/06 → | D | D19AA | |
| 1.9 DDiS 4x4 | 88 | 06/06 → | D | D19AA | |

81353 350981353000

| | |
|--|---|
| | PULEGGIA Diametro Puleggia Ø59.26 Numero Denti/Gole Puleggia 20 Altezza Puleggia 33.5 Posizione Attacco 64.6 Diametro Girante Ø74 N° Alette Girante 8 Posizione Girante 20.25 |
|--|---|

CITROËN
Evasion

| | | | | | |
|--------|----|---------------|---|----------------|-----------|
| 2.1 TD | 80 | 05/96 → 07/02 | D | P8C (XUD11BTE) | 06-1996 → |
|--------|----|---------------|---|----------------|-----------|

Xantia I, Break

| | | | | | |
|-----------------|----|---------------|---|----------------|-----------|
| 2.1 Turbo D 12V | 80 | 06/95 → 01/98 | D | P8C (XUD11BTE) | 06-1995 → |
| | 80 | 06/96 → 01/98 | D | P8C (XUD11BTE) | 11-1996 → |

Xantia II, Break

| | | | | | |
|-----------------|----|---------------|---|----------------|-----------|
| 2.1 Turbo D 12V | 80 | 01/98 → 02/99 | D | P8C (XUD11BTE) | 11-1996 → |
|-----------------|----|---------------|---|----------------|-----------|

81353
350981353000

KW

CITROËN
XM I, Break

| | | | | | |
|------------|----|---------------|---|---|-------------------------|
| 2.1 TD 12V | 80 | 11/91 → 04/94 | D | P8A (XUD11ATE), P8C (XUD11BTE), PHZ (XUD11ATE), PJZ (XUD11ATE) | 01-1991 →, → 07-1994 |
| | 80 | 05/89 → 06/94 | D | P8A (XUD11ATE), PHZ (XUD11ATE), PJZ (XUD11ATE) | 05-1989 →, → 07-1994 |

XM II, Break

| | | | | | |
|------------|----|---------------|---|---|-----------|
| 2.1 TD 12V | 80 | 05/94 → 10/00 | D | P8A (XUD11ATE), P8C (XUD11BTE), PHZ (XUD11ATE), PJZ (XUD11ATE) | 01-1994 → |
| | 80 | 05/94 → 10/00 | D | P8C (XUD11BTE), PHZ (XUD11ATE), PJZ (XUD11ATE) | 01-1993 → |

FIAT
Ulysse I

| | | | | | |
|--------|----|---------------|---|-----|-----------|
| 2.1 TD | 80 | 03/96 → 10/99 | D | P8C | 04-1996 → |
|--------|----|---------------|---|-----|-----------|

LANCIA
Zeta

| | | | | | |
|--------|----|---------------|---|-----|--|
| 2.1 TD | 80 | 05/96 → 09/99 | D | P8C | |
|--------|----|---------------|---|-----|--|

PEUGEOT
407, Station Wagon, Coupé

| | | | | | |
|------------|----|---------------|---|-------------------|--|
| 2.1 TD 12V | 80 | 01/96 → 05/04 | D | P8C (XUD11BTE) | |
|------------|----|---------------|---|-------------------|--|

605

| | | | | | |
|------------|----|---------------|---|-------------------|--|
| 2.1 TD 12V | 80 | 08/94 → 09/99 | D | P8C (XUD11BTE) | |
|------------|----|---------------|---|-------------------|--|

| | | | | | |
|------------------|----|---------------|---|-------------------|--|
| 2.1 Turbo Diesel | 80 | 06/89 → 09/99 | D | PHZ (XUD11ATE) | |
|------------------|----|---------------|---|-------------------|--|

806

| | | | | | |
|------------|----|---------------|---|-------------------|--|
| 2.1 td 12V | 80 | 06/96 → 08/99 | D | P8C (XUD11BTE) | |
|------------|----|---------------|---|-------------------|--|

81355
350981355000

KW

FLANGIA

| | |
|-------------------------|-------|
| Numero Fori Flangia | 3 |
| Dimensione Fori Flangia | M6×1 |
| Posizione Attacco | 66.5 |
| Diametro Centraggio | Ø48 |
| Diametro Girante | Ø67.5 |
| N° Alette Girante | 7 |
| Posizione Girante | 9.7 |

KW

ALFA ROMEO
147

| | | | | | |
|---------|-----|---------------|---|----------|--|
| 3.2 GTA | 184 | 02/03 → 03/10 | B | 932A.000 | |
|---------|-----|---------------|---|----------|--|

156, Sportwagon

| | | | | | |
|------------|-----|---------------|---|---------------------|-----------|
| 2.5 V6 24V | 140 | 05/00 → 08/03 | B | AR32401 | |
| | 140 | 09/97 → 12/01 | B | AR32401, AR32402 | 11-1997 → |
| | 141 | 10/00 → 09/05 | B | AR32405 | |
| 3.2 GTA | 184 | 03/02 → 09/05 | B | 932A.000 | |

166

| | | | | | |
|------------|-----|---------------|---|---------------------|------------------|
| 2.0 V6 | 151 | 09/98 → 10/00 | B | AR34102 | |
| 2.5 V6 24V | 138 | 10/00 → 06/07 | B | AR36201 | |
| | 140 | 09/98 → 10/00 | B | AR34201 | |
| 3.0 V6 24V | 162 | 10/00 → 06/07 | B | AR36101 | |
| | 166 | 09/98 → 10/00 | B | AR34301, AR34302 | |
| 3.2 V6 24V | 176 | 10/03 → 06/07 | B | 936A.000 | M: AR34301/36101 |

GT II

| | | | | | |
|---------|-----|---------------|---|----------|--|
| 3.2 GTA | 176 | 11/03 → 09/10 | B | 936A.000 | |
|---------|-----|---------------|---|----------|--|

GTV II

| | | | | | |
|------------|-----|---------------|---|-----------|------------|
| 3.0 V6 24V | 162 | 10/96 → 10/00 | B | AR16102 | |
| 3.2 V6 24V | 176 | 04/03 → 10/05 | B | 936A6.000 | M: AR16102 |

Spider IV

| | | | | | |
|------------|-----|---------------|---|-----------|--|
| 3.0 V6 24V | 162 | 01/99 → 10/03 | B | AR16102 | |
| 3.2 V6 24V | 176 | 04/03 → 04/05 | B | 936A6.000 | |

LANCIA
Kappa, Station Wagon, Coupé

| | | | | | |
|---------|-----|---------------|---|----------|--|
| 3.0 24V | 150 | 08/94 → 10/01 | B | 838B.000 | |
|---------|-----|---------------|---|----------|--|

Thesis

| | | | | | |
|--------|-----|---------------|---|----------|--|
| 3.0 V6 | 158 | 07/02 → 07/09 | B | 841A.000 | |
| | 169 | 05/03 → 07/09 | B | 841L.000 | |

81362
350981362000

| FLANGIA | |
|-----------------------------------|---------|
| Numero Fori Flangia | 3 |
| Numero Fori Flangia (Serie 2) | 3 |
| Dimensione Fori Flangia | M8×1.25 |
| Dimensione Fori Flangia (Serie 2) | M7×1 |
| Posizione Attacco | 73.8 |
| Diametro Mozzo | Ø36 |
| Diametro Girante | Ø70.5 |
| N° Alette Girante | 7 |
| Posizione Girante | 29 |

KW

ALFA ROMEO
164

| | | | | | |
|--------|----|---------------|---|-----------------|--------|
| 2.5 TD | 92 | 09/92 → 09/98 | D | VM08B, VM32B | (-)COP |
|--------|----|---------------|---|-----------------|--------|

CHRYSLER
Voyager III

| | | | | | |
|--------|----|---------------|---|--------------------|--------|
| 2.5 TD | 85 | 01/95 → 03/01 | D | 425CLIRS/X, ENC | (-)COP |
|--------|----|---------------|---|--------------------|--------|

FORD
Scorpio II, Station Wagon

| | | | | | |
|--------|----|---------------|---|----|--------|
| 2.5 TD | 92 | 09/96 → 08/98 | D | VM | (-)COP |
|--------|----|---------------|---|----|--------|

JEEP
Cherokee II (XJ)

| | | | | | |
|-----|----|---------------|---|-----|--------|
| 2.5 | 89 | 10/95 → 09/01 | B | EPE | (-)COP |
|-----|----|---------------|---|-----|--------|

| | | | | | |
|--------|----|---------------|---|-----|--------|
| 2.5 TD | 85 | 01/88 → 09/01 | D | ENC | (-)COP |
|--------|----|---------------|---|-----|--------|

Grand Cherokee I

| | | | | | |
|------------|----|---------------|---|----------|--------|
| 2.5 TD 4x4 | 85 | 10/95 → 04/99 | D | M51, M52 | (-)COP |
|------------|----|---------------|---|----------|--------|

| | | | | | |
|------------------|----|---------------|---|--|--------|
| 2.5 TD Laredo | 85 | 10/96 → 09/98 | D | | (-)COP |
|------------------|----|---------------|---|--|--------|

Grand Cherokee II

| | | | | | |
|------------|-----|---------------|---|-----|--------|
| 3.1 TD 4x4 | 103 | 04/99 → 12/01 | D | EXA | (-)COP |
|------------|-----|---------------|---|-----|--------|

OPEL
Frontera A

| | | | | | |
|---------|----|---------------|---|------------------|--------|
| 2.5 TDS | 85 | 09/96 → 10/98 | D | 25TDS (VM41B) | (-)COP |
|---------|----|---------------|---|------------------|--------|

ROVER
800

| | | | | | |
|----------|----|---------------|---|------------------------|----------------------|
| 825 D/SD | 87 | 01/90 → 02/99 | D | 425SL1RR, 4924SHIRG | (-)COP, 03-1996 → |
|----------|----|---------------|---|------------------------|----------------------|

| | | | | | |
|--------|----|---------------|---|------------------------|----------------------|
| 825 SD | 87 | 09/93 → 02/99 | D | 425SL1RR, 4924SHIRG | (-)COP, 03-1996 → |
|--------|----|---------------|---|------------------------|----------------------|

81363
350981363000

| FLANGIA | |
|-------------------------|---------|
| Numero Fori Flangia | 3 |
| Dimensione Fori Flangia | M8×1.25 |
| Posizione Attacco | 78.5 |
| Diametro Mozzo | Ø22 |
| Diametro Centraggio | Ø25.95 |
| Diametro Girante | Ø70 |
| N° Alette Girante | 9 |
| Posizione Girante | 28.4 |

KW

ALFA ROMEO
145

| | | | | | |
|--------|----|---------------|---|---------------------|------------------------------------|
| 1.9 TD | 66 | 10/94 → 02/99 | D | AR33601, AR67501 | (-)COP, 10-1996 →, → 02-1999 |
|--------|----|---------------|---|---------------------|------------------------------------|

146

| | | | | | |
|--------|----|---------------|---|---------------------|----------------------|
| 1.9 TD | 66 | 12/94 → 02/99 | D | AR33601, AR67501 | (-)COP, 10-1995 → |
|--------|----|---------------|---|---------------------|----------------------|

155

| | | | | | |
|--------|----|---------------|---|---------|------------------------------------|
| 1.9 TD | 66 | 04/93 → 12/97 | D | AR67501 | (-)COP, 02-1996 →, → 12-1997 |
|--------|----|---------------|---|---------|------------------------------------|

FIAT
Tempra, Station Wagon

| | | | | | |
|-------|----|---------------|---|-------------------------|--------|
| 1.9 D | 48 | 07/91 → 08/96 | D | 149A1.000, 160A7.000 | (-)COP |
|-------|----|---------------|---|-------------------------|--------|

Tipo I

| | | | | | |
|-------|----|---------------|---|-----------|----------------------|
| 1.7 D | 43 | 01/88 → 10/94 | D | 149B4.000 | (-)COP, 01-1993 → |
|-------|----|---------------|---|-----------|----------------------|

| | | | | | |
|--|----|---------------|---|-----------|----------------------|
| | 45 | 01/88 → 10/95 | D | 149B4.000 | (-)COP, 01-1993 → |
|--|----|---------------|---|-----------|----------------------|

| | | | | | |
|-------|----|---------------|---|-------------------------|----------------------|
| 1.9 D | 48 | 07/91 → 08/95 | D | 149A1.000, 160A7.000 | (-)COP, 01-1993 → |
|-------|----|---------------|---|-------------------------|----------------------|

LANCIA
Debra, Station Wagon

| | | | | | |
|---------|----|---------------|---|-------------------------|--------|
| 1.9 TDS | 66 | 07/94 → 07/99 | D | 160D1.000, 835A4.000 | (-)COP |
|---------|----|---------------|---|-------------------------|--------|

| | | | | | |
|--|----|---------------|---|---------------------------------------|----------------------|
| | 66 | 04/89 → 07/99 | D | 160D1.000, 835A4.000, 835A4.046 | (-)COP, 05-1994 → |
|--|----|---------------|---|---------------------------------------|----------------------|

Delta II

| | | | | | |
|--------|----|---------------|---|-------------------------|--------|
| 1.9 TD | 66 | 10/94 → 08/99 | D | 160D1.000, 835A4.000 | (-)COP |
|--------|----|---------------|---|-------------------------|--------|

81364

350981364000



PULEGGIA

Diametro Puleggia Ø118.5 / Ø107
 Numero Denti/Gole Puleggia 5 / 3
 Posizione Attacco 84.9
 Diametro Girante Ø60
 N° Alette Girante 8
 Posizione Girante 41.5



KW



FIAT

Brava

| | | | | | |
|---------|----|---------------|---|-----------|--------|
| 1.6 16V | 66 | 10/95 → 10/01 | B | 182A6.000 | (-)COP |
| | 76 | 02/96 → 10/01 | B | 182A4.000 | (-)COP |
| | 76 | 01/99 → 12/02 | B | 182B6.000 | (-)COP |

Bravo I

| | | | | | |
|---------|----|---------------|---|-----------|-------------------|
| 1.6 | 76 | 09/00 → 10/01 | B | 182B6.000 | (-)COP |
| 1.6 16V | 66 | 10/95 → 10/01 | B | 182A6.000 | (-)COP, 10-1995 → |
| | 76 | 03/96 → 10/01 | B | 182A4.000 | (-)COP |

Doblò I, Cargo

| | | | | | |
|-------------------|----|---------|---|-----------|--------|
| 1.6 | 68 | 09/02 → | B | 182B6.000 | (-)COP |
| 1.6 16V | 76 | 10/01 → | B | 182B6.000 | (-)COP |
| 1.6 Natural Power | 76 | 09/02 → | | 182B6.000 | (-)COP |

Marea, Weekend

| | | | | | |
|---------------------|----|---------------|---|----------------------|--------|
| 1.6 | 68 | 03/99 → 08/00 | B | 185A3.000 | (-)COP |
| | 76 | 09/00 → 08/02 | B | 182B6.000 | (-)COP |
| 1.6 100 16V | 76 | 09/96 → 05/02 | B | 182A4.000 | (-)COP |
| 1.6 100 16V Bipower | 76 | 04/99 → 05/02 | | 185A3.000, 186A4.000 | (-)COP |
| 1.6 16V | 75 | 04/97 → 02/99 | B | 185A3.000 | (-)COP |
| 1.6 SX | 72 | 09/00 → 08/02 | B | 182B5.098 | (-)COP |

Multipla

| | | | | | |
|------------------|----|---------------|---|-----------|--------|
| 1.6 | 68 | 05/04 → 08/05 | G | 182B6.000 | (-)COP |
| | 74 | 03/01 → 08/05 | G | 182B6.000 | (-)COP |
| | 76 | 09/00 → 06/10 | B | 182B6.000 | (-)COP |
| 1.6 100 16V | 76 | 04/99 → 06/10 | B | 182A4.000 | (-)COP |
| 1.6 16V | 70 | 04/02 → 06/10 | B | 182B6.000 | (-)COP |
| 1.6 16V Bipower | 76 | 04/99 → 06/10 | | 186A4.000 | (-)COP |
| | 76 | 10/01 → 06/10 | | 182B6.000 | (-)COP |
| 1.6 16V Blupower | 70 | 04/99 → 06/10 | G | 186A3.000 | (-)COP |

Palio I, Weekend

| | | | | | |
|-----|----|---------------|---|----------------------|--------|
| 1.5 | 62 | 02/02 → | B | 178E5.022 | (-)COP |
| 1.6 | 68 | 07/97 → 10/03 | B | 178C7.098, 178D2.011 | (-)COP |

81364

350981364000



KW



FIAT

Palio I, Weekend

| | | | | | |
|---------|----|---------------|---|-----------|-------------------|
| 1.6 16V | 74 | 04/96 → | B | 178B3.000 | (-)COP |
| | 74 | 04/96 → 02/01 | B | 178B3.000 | (-)COP, 07-1997 → |
| | 76 | 02/01 → | B | 182B6.000 | (-)COP |

Siena I

| | | | | | |
|-------------|----|---------------|----|-----------|--------|
| 1.5 Bipower | 57 | 09/03 → 12/05 | BF | 178A6.011 | (-)COP |
| 1.6 | 76 | 11/00 → 12/09 | B | 182B6.000 | (-)COP |
| 1.6 16V | 78 | 09/98 → 12/09 | B | 178B3.000 | (-)COP |

Stilo, Station Wagon

| | | | | | |
|---------|----|---------------|---|-----------|--------|
| 1.6 16V | 76 | 01/03 → 08/08 | B | 182B6.000 | (-)COP |
| | 77 | 05/05 → 11/06 | B | 192B3.000 | (-)COP |
| | 76 | 10/01 → 11/06 | B | 182B6.000 | (-)COP |

LANCIA

Delta II

| | | | | | |
|--------------|----|---------------|---|-----------|--------|
| 1.6 i.e. | 66 | 03/96 → 08/99 | B | 182A6.000 | (-)COP |
| 1.6 i.e. 16V | 76 | 01/96 → 08/99 | B | 182A4.000 | (-)COP |

Lybra, Station Wagon

| | | | | | |
|---------|----|---------------|---|----------------------|--------|
| 1.6 | 76 | 10/00 → 10/05 | B | 182B6.000 | (-)COP |
| 1.6 16V | 76 | 07/99 → 10/05 | B | 182A4.000, 182B6.000 | (-)COP |

81365

350981365000



FLANGIA

Numero Fori Flangia 3
 Dimensione Fori Flangia M8x1.25
 Posizione Attacco 61.55
 Diametro Mozzo Ø22
 Diametro Centraggio Ø25.95
 Diametro Girante Ø70
 N° Alette Girante 9
 Posizione Girante 28.4



KW



FIAT

Punto I, Cabrio, Van

| | | | | | |
|--------|----|---------------|---|-----------|-------------------|
| 1.7 TD | 51 | 01/94 → 09/99 | D | 176A3.000 | (-)COP, → 08-1996 |
| | 52 | 01/94 → 09/99 | D | 176A5.000 | (-)COP, → 08-1996 |

Palio I, Weekend

| | | | | | |
|--------|----|---------------|---|-----------|-----------------------------------|
| 1.7 TD | 51 | 04/96 → 03/01 | D | 176A3.000 | (-)COP, → 09-1999, → M: 2.427.906 |
|--------|----|---------------|---|-----------|-----------------------------------|

81365 350981365000

FIAT
Punto I, Cabrio, Van

| | | | | | |
|--------|----|---------------|---|-----------|--------|
| 1.7 D | 42 | 04/96 → 02/00 | D | 176B3.000 | (-)COP |
| 1.7 TD | 52 | 04/96 → 02/00 | D | 176A5.000 | (-)COP |

Strada

| | | | | | |
|--------|----|---------|---|-----------|---------------------------|
| 1.7 TD | 51 | 06/99 → | D | 176A3.000 | (-)COP, → M: 2.427.906 |
|--------|----|---------|---|-----------|---------------------------|

JEEP
Wrangler II

| | | | | | |
|-----|-----|---------------|---|-----|--------|
| 2.4 | 105 | 11/02 → 04/07 | B | ED1 | (-)COP |
|-----|-----|---------------|---|-----|--------|

81366 350981366000

PULEGGIA

| | |
|----------------------------|--------|
| Diametro Puleggia | Ø118.5 |
| Numero Denti/Gole Puleggia | 4 |
| Posizione Attacco | 69.9 |
| Diametro Girante | Ø60 |
| N° Alette Girante | 8 |
| Posizione Girante | 41.5 |

FIAT
Fiorino III, Pick Up (Uno)

| | | | | | |
|-------------|----|---------------|---|-------------------------|---------------------------|
| 1.4 | 49 | 05/94 → 05/01 | B | 146D5.000 | (-)COP, M →: 9.470.269 |
| | 52 | 11/92 → 10/96 | B | 146C5.000 | (-)COP, M →: 9.470.269 |
| 1.6 | 55 | 01/94 → 05/01 | B | 146C6.000, 146D6.000 | (-)COP, M →: 9.470.269 |
| 70 i.e. 1.4 | 49 | 05/94 → 05/01 | B | 146C5.000, 146D5.000 | (-)COP, M →: 9.470.269 |
| 75 i.e. 1.6 | 55 | 10/93 → 05/01 | B | 146C6.000, 146D6.000 | (-)COP, M →: 9.470.269 |

Palio I, Weekend

| | | | | | |
|----------|----|---------|---|-----------|---------------|
| 1.4 | 51 | 04/96 → | B | 178B2.000 | (-)COP, (-)SS |
| 1.4 Cat. | 51 | 04/96 → | B | 178B2.016 | (-)COP, (-)SS |

Siena I

| | | | | | |
|----------|----|---------------|---|-----------|--------------------------|
| 1.4 | 51 | 04/96 → 12/09 | B | 178B2.000 | (-)COP, (-)JAC, (-)SS |
| 1.4 Cat. | 51 | 04/96 → 12/09 | B | 178B2.016 | (-)COP, (-)JAC, (-)SS |

81366 350981366000

FIAT
Tempra, Station Wagon

| | | | | | |
|----------|----|---------------|---|-------------------------|-------------------------------------|
| 1.4 i.e. | 51 | 03/92 → 08/96 | B | 160A1.046, 836A4.000 | (-)COP, M →: 9.336.693, (-)SS |
| | 57 | 03/91 → 08/96 | B | 159A2.000 | (-)COP, M →: 9.336.693, (-)SS |

Uno I

| | | | | | |
|-----|----|---------------|---|-----------|--------|
| 1.4 | 51 | 07/91 → 07/96 | B | 160A1.046 | (-)COP |
| | 74 | 01/89 → 12/91 | B | 146A8.000 | (-)COP |

INNOCENTI
Elba

| | | | | | |
|----------|----|---------------|---|-------------------------|----------------------|
| 1.4 i.e. | 49 | 09/94 → 12/96 | B | 146C5.000, 146D5.000 | (-)COP, 03-1995 → |
|----------|----|---------------|---|-------------------------|----------------------|

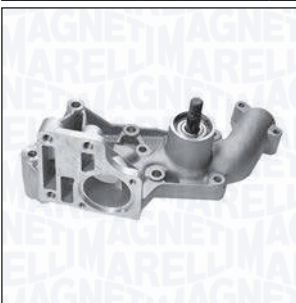
81367 350981367000

ALBERINO

| | |
|-----------------------|---------|
| Diametro Alberino | M14×1.5 |
| Tipo Filetto Alberino | Maschio |
| Posizione Attacco | 105.5 |
| Diametro Girante | Ø56 |
| N° Alette Girante | 6 |
| Posizione Girante | 21 |

CITROËN
C 25

| | | | | |
|---------|----|---------------|---|-----------------------------|
| 1.8 | 50 | 11/81 → 01/94 | B | 169 (XM7T) |
| 1.8 E | 51 | 07/87 → 02/94 | B | 169 (XM7T) |
| 2.0 | 62 | 02/91 → 02/94 | B | 170C (XN1T) |
| 2.0 4x4 | 62 | 01/90 → 01/94 | B | |
| 2.0 E | 58 | 09/81 → 02/94 | B | 170A (XN1T), 170B (XN1T) |

FIAT
Ducato I

| | | | | |
|-----|----|---------------|---|------------|
| 2.0 | 55 | 07/85 → 08/90 | B | 170B |
| | 55 | 07/85 → 08/90 | B | 170B, XN1T |
| | 58 | 01/82 → 08/90 | B | XN1T |
| | 62 | 03/89 → 08/90 | B | 170D |

Ducato II

| | | | | |
|---------|----|---------------|---|------|
| 2.0 | 62 | 07/90 → 03/94 | B | 170D |
| 2.0 4x4 | 63 | 06/90 → 05/94 | B | 170D |

Talento

| | | | | |
|-----|----|---------------|---|------|
| 2.0 | 55 | 03/89 → 03/94 | B | 170B |
|-----|----|---------------|---|------|

81367 350981367000



PEUGEOT

J5 I

| | | | | | |
|-----|----|---------------|---|-------------|--|
| 2.0 | 55 | 09/81 → 09/90 | B | 170B (XN1T) | |
| | 55 | 09/87 → 08/90 | B | XN1T | |
| | 58 | 01/83 → 09/90 | B | 170 (XN1T) | |
| | 58 | 09/81 → 08/90 | B | XN1P | |

J5 II

| | | | | | |
|-----|----|---------------|---|-----------------------|----------------------|
| 2.0 | 62 | 10/90 → 02/94 | B | 170D (XN1TACP) | 09-1981 →, → 01-1994 |
| | 62 | 10/90 → 02/94 | B | 170D (XN1TACP) | |
| | 62 | 09/90 → 01/94 | B | 170D (XN1TACP), XN1TA | |

81368 350981368000



PULEGGIA
 Diametro Puleggia Ø118.5
 Numero Denti/Gole Puleggia 7
 Posizione Attacco 77
 Diametro Girante Ø60
 N° Alette Girante 8
 Posizione Girante 41.5



CITROËN

Jumpy I

| | | | | | |
|-------|----|---------------|---|--------------------|--------|
| 1.6 | 58 | 10/95 → | B | 1580SPI, 220A2.000 | (-)COP |
| 1.6 | 59 | 10/95 → 08/00 | B | 220A2.000 | (-)COP |
| 1.6 i | 58 | 10/95 → | B | 1580SPI, 220A2.000 | (-)COP |

FIAT

Scudo I

| | | | | | |
|-----|----|---------------|---|-----------|--------|
| 1.6 | 58 | 02/96 → 12/06 | B | 220A2.000 | (-)COP |
|-----|----|---------------|---|-----------|--------|

PEUGEOT

Expert I

| | | | | | |
|-----|----|---------|---|-----------------|--------|
| 1.6 | 58 | 02/96 → | B | 222A2 (1580SPI) | (-)COP |
|-----|----|---------|---|-----------------|--------|

81369 350981369000



PULEGGIA
 Versione PIERBURG
 Diametro Puleggia Ø57
 Numero Denti/Gole Puleggia 23
 Altezza Puleggia 23.4
 Posizione Attacco 53.9
 Diametro Girante Ø63
 N° Alette Girante 8
 Posizione Girante 34.5



ABARTH

500

| | | | | | |
|-----|----|---------|---|-----------|----------|
| 1.4 | 99 | 08/08 → | B | 312A1.000 | PIERBURG |
|-----|----|---------|---|-----------|----------|

Grande Punto

| | | | | | |
|-----|-----|---------------|---|----------------------|----------|
| 1.4 | 114 | 12/07 → 06/10 | B | 199A8.000 | PIERBURG |
| | 132 | 12/07 → 12/12 | B | 199A8.000, 955A8.000 | PIERBURG |

ALFA ROMEO

Mito

| | | | | | |
|----------|----|---------|---|-----------|----------|
| 1.4 | 58 | 09/08 → | B | 955A1.000 | PIERBURG |
| | 70 | 09/08 → | B | 199A6.000 | PIERBURG |
| 1.4 TJet | 88 | 09/08 → | B | 198A4.000 | PIERBURG |

CHRYSLER

Delta

| | | | | | |
|---------|-----|---------|---|-----------|----------|
| 1.4 | 88 | 08/11 → | B | 198A4.000 | PIERBURG |
| 1.4 16V | 103 | 08/11 → | B | 198A7.000 | PIERBURG |

Ypsilon

| | | | | | |
|-----|----|---------|---|-----------|----------|
| 1.2 | 51 | 05/11 → | B | 169A4.000 | PIERBURG |
|-----|----|---------|---|-----------|----------|

FIAT

500 II, 500C

| | | | | | |
|-----|----|---------|---|-----------|----------|
| 1.2 | 51 | 10/07 → | B | 169A4.000 | PIERBURG |
| 1.4 | 74 | 10/07 → | B | 169A3.000 | PIERBURG |

Punto I, Cabrio, Van

| | | | | | |
|---------|----|---------------|---|-----------|----------|
| 1.2 16V | 63 | 04/97 → 09/99 | B | 176B9.000 | PIERBURG |
|---------|----|---------------|---|-----------|----------|

Brava

| | | | | | |
|------------|----|---------------|---|-----------|---------------------|
| 1.2 16V 80 | 64 | 12/98 → 12/02 | B | 182B2.000 | PIERBURG |
| | 59 | 10/00 → 10/01 | B | 188A5.000 | PIERBURG |
| | 60 | 12/98 → 12/02 | B | 182B2.000 | → 03-1999 |
| | 60 | 12/98 → 12/02 | B | 182B2.000 | 04-1999 →, PIERBURG |

Bravo I

| | | | | | |
|------------|----|---------------|---|-----------|---------------------|
| 1.2 16V 80 | 59 | 10/00 → 10/01 | B | 188A5.000 | PIERBURG |
| | 60 | 12/98 → 10/00 | B | 182B2.000 | → 03-1999 |
| | 60 | 12/98 → 10/00 | B | 182B2.000 | 04-1999 →, PIERBURG |
| | 64 | 12/98 → 10/01 | B | 182B2.000 | PIERBURG |

81369 350981369000

FIAT
Bravo II, Van

| | | | | | |
|-----------|-----|---------|---|-----------|----------|
| 1.4 | 66 | 04/07 → | B | 192B2.000 | PIERBURG |
| 1.4 T-Jet | 88 | 09/07 → | B | 198A4.000 | PIERBURG |
| | 110 | 09/07 → | B | 198A1.000 | PIERBURG |

Doblò I, Cargo

| | | | | | |
|-----|----|---------|---|-----------|----------|
| 1.4 | 57 | 10/05 → | B | 350A1.000 | PIERBURG |
|-----|----|---------|---|-----------|----------|

Grande Punto, Van

| | | | | | |
|-------------------|----|---------|---|-----------|----------|
| 1.2 | 48 | 10/05 → | B | 199A4.000 | PIERBURG |
| 1.4 | 57 | 10/05 → | B | 350A1.000 | PIERBURG |
| 1.4 16V | 70 | 10/05 → | B | 199A6.000 | PIERBURG |
| 1.4 Natural Power | 57 | 07/08 → | | 350A1.000 | PIERBURG |
| 1.4 T-Jet | 88 | 09/07 → | B | 198A4.000 | PIERBURG |

Idea

| | | | | | |
|---------|----|---------|---|-----------|----------|
| 1.2 16V | 59 | 01/04 → | B | 188A5.000 | PIERBURG |
| 1.4 | 57 | 10/05 → | B | 350A1.000 | PIERBURG |
| | 66 | 12/03 → | B | 192B2.000 | PIERBURG |
| 1.4 16V | 70 | 01/04 → | B | 843A1.000 | PIERBURG |

Linea

| | | | | | |
|-----------|----|---------|---|-----------|----------|
| 1.4 | 57 | 06/07 → | B | 350A1.000 | PIERBURG |
| 1.4 T-Jet | 88 | 09/07 → | B | 198A4.000 | PIERBURG |

Marea, Weekend

| | | | | | |
|---------|----|---------------|---|-----------|----------|
| 1.2 16V | 60 | 10/98 → 05/02 | B | 182B2.000 | PIERBURG |
|---------|----|---------------|---|-----------|----------|

Palio I, Weekend

| | | | | | |
|-----|----|---------|---|-----------|----------|
| 1.2 | 59 | 09/01 → | B | 188A5.000 | PIERBURG |
|-----|----|---------|---|-----------|----------|

Panda I, Van

| | | | | | |
|-----|----|---------------|---|-----------|--------------------------|
| 1.1 | 40 | 09/00 → 02/04 | B | 187A1.000 | M →: 2.533.529, PIERBURG |
|-----|----|---------------|---|-----------|--------------------------|

Panda II, Van

| | | | | | |
|-------------------|----|---------------|---|-----------|--------------------------|
| 1.1 | 40 | 09/03 → | B | 187A1.000 | M →: 2.533.529, PIERBURG |
| | 40 | 09/04 → | B | 187A1.000 | PIERBURG |
| 1.2 | 44 | 09/03 → | B | 188A4.000 | M →: 2.533.529, PIERBURG |
| | 44 | 09/04 → | B | 188A4.000 | M →: 2533529, PIERBURG |
| 1.2 4x4 | 44 | 09/04 → | B | 188A4.000 | M →: 2533529, PIERBURG |
| | 44 | 10/04 → | B | 188A4.000 | M →: 2.533.529, PIERBURG |
| 1.2 LPG | 44 | 04/09 → | | 188A4.000 | PIERBURG |
| 1.2 Natural Power | 44 | 01/07 → 11/09 | | 188A4.000 | PIERBURG |
| 1.4 | 74 | 10/06 → | B | 169A3.000 | PIERBURG |

81369 350981369000

FIAT
Panda III, Van

| | | | | | |
|---------|----|---------|---|-----------|----------|
| 1.2 | 51 | 02/12 → | B | 169A4.000 | PIERBURG |
| 1.2 LPG | 51 | 06/12 → | | 169A4.000 | PIERBURG |

Punto I, Cabrio, Van

| | | | | | |
|------------|----|---------------|---|-----------|----------|
| 85 16V 1.2 | 63 | 04/97 → 06/00 | B | 176B9.000 | PIERBURG |
|------------|----|---------------|---|-----------|----------|

Punto II, Cabrio, Van

| | | | | | |
|-------------------|----|---------|----|-----------|------------------------|
| 1.2 16V 80 | 59 | 09/99 → | B | 188A5.000 | PIERBURG |
| 1.2 Bifuel | 44 | 08/07 → | BF | 188A4.000 | PIERBURG |
| 1.2 Natural Power | 44 | 09/03 → | | 188A4.000 | M →: 2533529, PIERBURG |
| | 70 | 09/03 → | B | 843A1.000 | PIERBURG |
| 1.4 | 71 | 11/05 → | B | 199A6.000 | PIERBURG |

Punto III, Van

| | | | | | |
|-----|----|---------|---|-----------|----------|
| 1.2 | 49 | 02/14 → | B | 199B9.000 | PIERBURG |
|-----|----|---------|---|-----------|----------|

Qubo

| | | | | | |
|-------------------|----|---------|--|-----------|----------|
| 1.4 Natural Power | 57 | 10/09 → | | 350A1.000 | PIERBURG |
|-------------------|----|---------|--|-----------|----------|

Siena I

| | | | | | |
|-----|----|---------------|---|-----------|----------|
| 1.2 | 59 | 09/01 → 12/09 | B | 188A5.000 | PIERBURG |
|-----|----|---------------|---|-----------|----------|

Stilo, Station Wagon

| | | | | | |
|---------|----|---------------|---|-----------|----------|
| 1.2 16V | 59 | 02/02 → 11/06 | B | 188A5.000 | PIERBURG |
| 1.4 16V | 66 | 03/05 → 11/06 | B | 192B2.000 | PIERBURG |
| | 70 | 01/04 → 11/06 | B | 843A1.000 | PIERBURG |

FORD
KA II

| | | | | | |
|-----|----|---------|---|-----|----------|
| 1.2 | 51 | 10/08 → | B | FP4 | PIERBURG |
|-----|----|---------|---|-----|----------|

LANCIA
Delta III

| | | | | | |
|-----|-----|---------------|---|-----------|----------|
| 1.4 | 88 | 09/08 → 08/14 | B | 198A4.000 | PIERBURG |
| | 110 | 09/08 → 08/14 | B | 198A1.000 | PIERBURG |

Musa

| | | | | | |
|-----|----|---------------|---|-----------|----------|
| 1.4 | 57 | 09/05 → 09/12 | B | 350A1.000 | PIERBURG |
| | 70 | 10/04 → 09/12 | B | 843A1.000 | PIERBURG |

Y

| | | | | | |
|---------|----|---------------|---|-----------|----------|
| 1.2 16V | 59 | 10/00 → 09/03 | B | 188A5.000 | PIERBURG |
| | 63 | 04/97 → 09/03 | B | 176B9.000 | PIERBURG |

Ypsilon I

| | | | | | |
|---------|----|---------------|---|-----------|----------|
| 1.2 | 59 | 10/03 → 12/11 | B | 188A5.000 | PIERBURG |
| 1.4 | 57 | 02/06 → 12/11 | B | 350A1.000 | PIERBURG |
| 1.4 16V | 70 | 10/03 → 12/11 | B | 843A1.000 | PIERBURG |

81370
350981370000

PULEGGIA

| | |
|----------------------------|--------|
| Versione | MAGMA |
| Diametro Puleggia | Ø59.24 |
| Numero Denti/Gole Puleggia | 24 |
| Altezza Puleggia | 16 |
| Posizione Attacco | 46.6 |
| Diametro Girante | Ø63 |
| N° Alette Girante | 8 |
| Posizione Girante | 34.5 |

KW

FIAT
Doblò I, Cargo

| | | | | | |
|-----|----|---------|---|-----------|-------|
| 1.2 | 48 | 03/01 → | B | 223A5.000 | MAGMA |
|-----|----|---------|---|-----------|-------|

Palio I, Weekend

| | | | | | |
|----------|----|---------------|---|---------------------------------------|--------------------------|
| 1.2 | 44 | 07/97 → 08/02 | B | 178B7.045, 178C4.066, 188A4.000 | MAGMA |
| | 50 | 06/99 → 10/00 | B | 178E2.000 | M →: 9.042.883, MAGMA |
| | 50 | 06/99 → 10/02 | B | 178E2.000 | MAGMA |
| | 52 | 06/04 → | B | 178E9.011 | MAGMA |
| | 54 | 06/98 → | B | 176A8.000, 178B5.000, 178E2.000 | M →: 9.042.883, MAGMA |
| | 44 | 02/01 → | B | 178C4.066, 188A4.000 | M →: 9.042.883, MAGMA |
| 1.2 Flex | 44 | 07/97 → 08/02 | B | 188A4.000 | MAGMA |
| 1.2 LPG | 44 | 07/97 → 08/02 | B | 188A4.000 | MAGMA |

Panda I, Van

| | | | | | |
|-----|----|---------------|---|-----------|--------------------------|
| 1.1 | 40 | 09/00 → 02/04 | B | 187A1.000 | → M: 2.533.528, MAGMA |
|-----|----|---------------|---|-----------|--------------------------|

Panda II, Van

| | | | | | |
|---------|----|---------|---|-----------|--------------------------|
| 1.1 | 40 | 09/03 → | B | 187A1.000 | → M: 2.533.528, MAGMA |
| | 40 | 09/04 → | B | 187A1.000 | MAGMA |
| 1.2 | 44 | 09/03 → | B | 188A4.000 | → M: 2.533.528, MAGMA |
| | 44 | 09/04 → | B | 188A4.000 | → M: 2533528, MAGMA |
| 1.2 4x4 | 44 | 09/04 → | B | 188A4.000 | → M: 2533528, MAGMA |
| | 44 | 10/04 → | B | 188A4.000 | → M: 2.533.528, MAGMA |

81370
350981370000

KW

FIAT
Punto II, Cabrio, Van

| | | | | | |
|-------------------|----|---------------|---|-----------|------------------------|
| 1.2 60 | 44 | 02/00 → 10/09 | B | 188A4.000 | MAGMA |
| | 44 | 09/99 → | B | 188A4.000 | MAGMA |
| 1.2 Natural Power | 44 | 09/03 → | | 188A4.000 | → M: 2533528, MAGMA |

Seicento, Van

| | | | | | |
|-----|----|---------------|---|-------------------------|--|
| 1.1 | 40 | 01/98 → 01/10 | B | 176B2.000 | 05-1999 →, M →: 9.042.883, MAGMA |
| | 40 | 01/98 → 01/10 | B | 176B2.000, 187A1.000 | 05-1999 →, M →: 9.042.883, MAGMA |

Siena I

| | | | | | |
|-----|----|---------------|---|-------------------------|---------------------|
| 1.2 | 44 | 09/01 → 12/09 | B | 178C4.066, 188A4.000 | MAGMA |
| | 54 | 09/98 → 12/09 | B | 178B5.000 | 07-1999 →, MAGMA |

Strada

| | | | | | |
|-----|----|---------|---|-----------|-------|
| 1.2 | 44 | 04/03 → | B | 188A4.000 | MAGMA |
|-----|----|---------|---|-----------|-------|

Uno I

| | | | | | |
|-----|----|---------------|---|-------------------------|-------|
| 1.1 | 41 | 01/92 → 06/06 | B | 160A3.000 | MAGMA |
| | 43 | 10/88 → 06/06 | B | 146A4.048, 160A3.000 | MAGMA |

LANCIA
Y

| | | | | | |
|-----|----|---------------|---|-------------------------|---------------------|
| 1.2 | 44 | 03/96 → 09/03 | B | 188A4.000, 840A3.000 | 09-2000 →, MAGMA |
|-----|----|---------------|---|-------------------------|---------------------|

Ypsilon I

| | | | | | |
|-----|----|---------------|---|-----------|-------|
| 1.2 | 44 | 10/03 → 12/11 | B | 188A4.000 | MAGMA |
|-----|----|---------------|---|-----------|-------|

81372
350981372000

PULEGGIA

| | |
|----------------------------|-------|
| Diametro Puleggia | Ø100 |
| Numero Denti/Gole Puleggia | 7 |
| Posizione Attacco | 85.25 |
| Diametro Girante | Ø70 |
| N° Alette Girante | 9 |
| Posizione Girante | 28.4 |

KW

FIAT
Brava

| | | | | | |
|-------|----|---------------|---|-----------|--------|
| 1.9 D | 48 | 10/95 → 10/01 | D | 160A7.000 | (-)COP |
|-------|----|---------------|---|-----------|--------|

81372 350981372000

FIAT
Bravo I

| | | | | | |
|-------|----|---------------|---|-----------|--------|
| 1.9 D | 48 | 10/95 → 10/01 | D | 160A7.000 | (-)COP |
|-------|----|---------------|---|-----------|--------|

81415 350981415000

PULEGGIA

| | |
|----------------------------|-------|
| Diametro Puleggia | Ø103 |
| Numero Denti/Gole Puleggia | 1 |
| Posizione Attacco | 163.2 |
| Diametro Girante | Ø53.8 |
| N° Alette Girante | 6 |
| Posizione Girante | 40.3 |

FIAT
Panda I, Van

| | | | | | |
|-----|----|---------------|---|-------------------------|-----------|
| 650 | 22 | 01/82 → 07/04 | B | 141A.000 | |
| 900 | 33 | 10/80 → 06/94 | B | 100GL3.000, 146A.000 | → 12-1991 |

Uno I

| | | | | | |
|--------|----|---------------|---|------------------------|--|
| 45 0.9 | 33 | 03/83 → 09/92 | B | 146A.000, 146A1.000 | |
|--------|----|---------------|---|------------------------|--|

SEAT
Ibiza I

| | | | | | |
|-----|----|---------------|---|-------------------|-------------------------|
| 0.9 | 29 | 08/90 → 05/93 | B | 09NCA, 146A000 | |
| | 32 | 08/86 → 05/93 | B | 146A000 | 09-1984 →, → 12-1992 |

Marbella

| | | | | | | |
|-----|-----|----|---------------|---|-------|--|
| 0.9 | 0.8 | 25 | 08/86 → 12/93 | B | 08NCA | |
| | | 32 | 07/97 → 10/98 | B | 08NCB | |
| | | 29 | 01/87 → 12/93 | B | 09NCA | |

| | | | | | | |
|----------|--|----|---------------|---|---------------------|--|
| 0.9 Cat. | | 29 | 01/87 → 12/93 | B | 09NCA, 100GL7000 | |
| | | 30 | 11/96 → 10/98 | B | 08NCB | |
| | | 29 | 01/87 → 12/93 | B | 09NCB | |

Terra

| | | | | | |
|----------|----|---------------|---|-------|--|
| 0.9 | 29 | 02/87 → 12/96 | B | 09NCA | |
| 0.9 Cat. | 29 | 02/92 → 12/94 | B | 09NCB | |

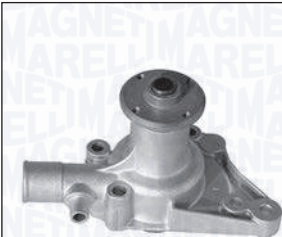
81419 350981419000

FLANGIA

| | |
|-------------------------|-------------|
| Versione | BC |
| Numero Fori Flangia | 4 |
| Dimensione Fori Flangia | 1/4"×28 UNF |
| Posizione Attacco | 94 |
| Diametro Mozzo | Ø23.75 |
| Diametro Girante | Ø53.8 |
| N° Alette Girante | 6 |
| Posizione Girante | 14.5 |

AUSTIN
Metro

| | | | | | |
|--------------|----|---------------|---|----------|----|
| 1.0 | 30 | 10/80 → 04/90 | B | 99H | BC |
| | 33 | 10/80 → 04/90 | B | 99H | BC |
| 1.0 Surf HLE | 35 | 10/80 → 04/90 | B | 99HA65P | BC |
| 1.3 | 51 | 10/80 → 04/90 | B | 12HA83AA | BC |
| 1.3 L,HLE,S | 44 | 10/80 → 04/90 | B | 12H | BC |
| 1.3 Surf | 44 | 11/85 → 04/90 | B | 12HC21AA | BC |
| 1.3 Turbo | 66 | 10/83 → 04/90 | B | 12HA85AA | BC |

Mini

| | | | | | |
|--------------|----|---------------|---|---------------------------------|----|
| 1000 Mayfair | 31 | 08/82 → 06/93 | B | 99H997P, 99HA53P, 99HC20P | BC |
| | 30 | 09/88 → 06/93 | B | 99HD81 | BC |

INNOCENTI
Mini

| | | | | | |
|-----|----|---------------|---|-----|----|
| 1.0 | 27 | 10/85 → 10/91 | B | 99H | BC |
|-----|----|---------------|---|-----|----|

MG
Metro

| | | | | | |
|-------|----|---------------|---|--|----|
| 1300 | 54 | 05/82 → 09/90 | B | | BC |
| Turbo | 69 | 10/82 → 09/90 | B | | BC |

ROVER
Mini, Cabrio

| | | | | | |
|------|----|---------------|---|-----------------|----|
| 1000 | 30 | 01/92 → 06/93 | B | 99HD81 | BC |
| | 37 | 10/92 → 11/00 | B | 12A2B | BC |
| | 39 | 01/92 → 04/95 | B | 12A2D | BC |
| 1300 | 45 | 01/91 → 12/91 | B | 12A2A | BC |
| | 46 | 09/92 → 04/95 | B | 12A2E | BC |
| | 46 | 01/92 → 11/00 | B | 12A2E, 12A2L | BC |

81434

350981434000



| | |
|-------------------------|---------|
| FLANGIA | |
| Numero Fori Flangia | 3 |
| Dimensione Fori Flangia | M8×1.25 |
| Posizione Attacco | 56.8 |
| Diametro Mozzo | Ø23 |
| Diametro Centraggio | Ø26 |
| Diametro Girante | Ø62 |
| N° Alette Girante | 7 |
| Posizione Girante | 44 |



AUTOBIANCHI

| | | | | | |
|-------------|----|---------------|---|-----------|--|
| Y10 | | | | | |
| 1.0 | 41 | 03/85 → 10/95 | B | 156A.000 | |
| 1.0 Turbo | 63 | 03/85 → 10/95 | B | 156A1.000 | |
| 1.3 i.e. GT | 54 | 06/89 → 10/95 | B | 146A5.046 | |
| | 57 | 06/89 → 10/95 | B | 156B.000 | |

FIAT

| | | | | | |
|------------------------|----|---------------|---|-----------|--|
| Duna I, Weekend | | | | | |
| 60 1.1 | 43 | 01/87 → 12/91 | B | 146A6.000 | |
| 70 1.3 | 49 | 01/87 → 12/91 | B | 146A5.000 | |

Elba

| | | | | | |
|-------|----|---------------|---|-----------|--|
| 1.3 | 43 | 04/86 → 12/93 | B | 127A2.011 | |
| 1.3 D | 33 | 04/86 → 10/92 | D | 127A5.000 | |

Fiorino II, Pick Up (147)

| | | | | | |
|-----|----|---------------|---|-----------|--|
| 1.3 | 49 | 12/87 → 08/93 | B | 146A5.000 | |
|-----|----|---------------|---|-----------|--|

Fiorino III, Pick Up (Uno)

| | | | | | |
|--------|----|---------------|---|-----------|--|
| 1.3 | 49 | 01/88 → 12/94 | B | 146A5.000 | |
| 60 1.1 | 40 | 05/88 → 12/93 | B | 146A9.000 | |
| 70 1.3 | 49 | 01/88 → 12/94 | B | 146A5.000 | |

Panda I, Van

| | | | | | |
|--------|----|---------------|---|-----------|--|
| 1300 D | 27 | 04/86 → 12/92 | D | 156A5.000 | |
|--------|----|---------------|---|-----------|--|

Uno I

| | | | | | |
|------------------|----|---------------|---|----------------------|--|
| 1.3 Super Diesel | 33 | 06/83 → 03/92 | D | 127A5.000, 146B1.000 | |
| 55 1.0 | 41 | 11/93 → 08/00 | B | 146C4.011 | |

INNOCENTI

Elba

| | | | | | |
|-----|----|---------------|---|-----------|--|
| 1.3 | 49 | 08/91 → 12/96 | B | 146A5.000 | |
|-----|----|---------------|---|-----------|--|

LANCIA

Y10

| | | | | | |
|----------|----|---------------|---|---------------------|--|
| 1.3 i.e. | 53 | 02/89 → 12/95 | B | 146A5.046, 156B.000 | |
| | 56 | 11/87 → 05/93 | B | 156B.000 | |

81436

350981436000



| | |
|-------------------------|---------|
| FLANGIA | |
| Numero Fori Flangia | 3 |
| Dimensione Fori Flangia | M8×1.25 |
| Posizione Attacco | 65.5 |
| Diametro Centraggio | Ø25.95 |
| Diametro Girante | Ø68 |
| N° Alette Girante | 12 |
| Posizione Girante | 17 |



FIAT

| | | | | | |
|------------------------|----|---------------|---|----------------------|--|
| Regata, Weekend | | | | | |
| 100 Super 1.6 | 74 | 10/83 → 12/90 | B | 149A2.000, 149A4.000 | |

LANCIA

| | | | | | |
|----------------|-----|---------------|---|-----------|--|
| Delta I | | | | | |
| 1.6 GT i.e. | 66 | 05/87 → 08/92 | B | 149C2.000 | |
| 1.6 HF Turbo | 122 | 08/86 → 05/93 | B | | |

Prisma

| | | | | | |
|-----|----|---------------|---|-----------|--|
| 1.6 | 73 | 08/86 → 02/92 | B | 831B6.000 | |
|-----|----|---------------|---|-----------|--|

81443

350981443000

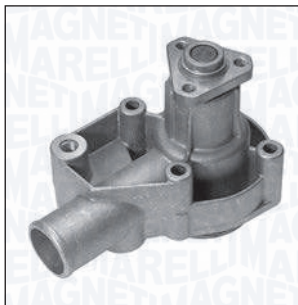

| | |
|-------------------------|---------|
| FLANGIA | |
| Numero Fori Flangia | 3 |
| Dimensione Fori Flangia | M8×1.25 |
| Posizione Attacco | 95.5 |
| Diametro Mozzo | Ø23 |
| Diametro Centraggio | Ø26 |
| Diametro Girante | Ø68 |
| N° Alette Girante | 12 |
| Posizione Girante | 17 |



ALFA ROMEO

| | | | | | |
|------------|-----|---------------|---|---------|--|
| 164 | | | | | |
| 2.0 Turbo | 128 | 10/87 → 09/98 | B | AR06476 | |
| | 129 | 02/88 → 10/92 | B | AR06476 | |

FIAT

| | | | | | |
|----------------|----|---------------|---|----------------------|------------------------------------|
| Croma I | | | | | |
| 2000 CHT | 74 | 01/91 → 09/92 | B | 154A1.000, 154C5.000 | |
| 2000 i.e. | 83 | 03/86 → 09/90 | B | 834B.048 | 08-1986 →, → 02-1991, → T: 285.921 |
| | 85 | 10/87 → 08/96 | B | 154C3.046, 834B.146 | → 02-1991, → T: 285.921 |
| | 88 | 03/87 → 09/92 | B | 154C3.000, 834B.000 | → 02-1991, → T: 285.921 |

81443 350981443000

FIAT
Croma I

| | | | | | |
|--------------------|-----|---------------|---|------------------------|----------------------------|
| 2000 i.e. Turbo | 110 | 06/87 → 08/96 | B | 154C4.046, 834C.146 | → 02-1991, → T: 285.921 |
| | 114 | 12/85 → 06/90 | B | 154A2.000 | |

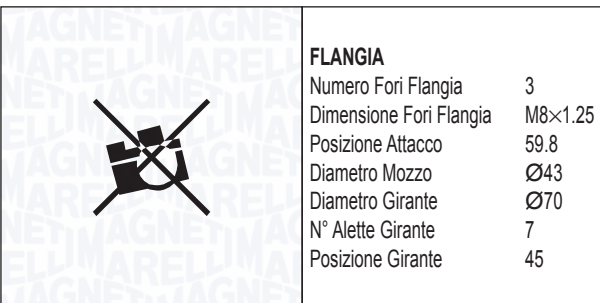
81450 350981450000

FIAT
Uno I

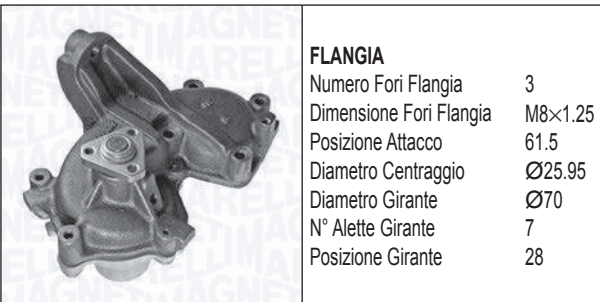
| | | | | | |
|-----------|----|---------------|---|------------------------|--------------------------------------|
| 70 TD 1.4 | 52 | 10/86 → 10/90 | D | 146B.000, 146B3.000 | (+)COP, → 12-1989, M: 146B.000 |
|-----------|----|---------------|---|------------------------|--------------------------------------|

81456 350981456000

FIAT
Duna I, Weekend

| | | | | | |
|--------|----|---------------|---|-----------|--------|
| 1.7 DS | 44 | 01/87 → 12/91 | D | 149B3.000 | (+)COP |
|--------|----|---------------|---|-----------|--------|

Elba

| | | | | | |
|-------|----|---------------|---|-----------|-------------------------|
| 1.7 D | 43 | 04/89 → 12/96 | D | 146B2.000 | (+)COP, (-)SS, (-)AC |
|-------|----|---------------|---|-----------|-------------------------|

Fiorino II, Pick Up (147)

| | | | | | |
|-------|----|---------------|---|-----------|--------|
| 1.7 D | 42 | 01/88 → 10/93 | D | 149B2.000 | (+)COP |
| | 44 | 12/87 → 12/90 | D | 149B3.000 | (+)COP |

81456 350981456000

FIAT
Fiorino III, Pick Up (Uno)

| | | | | | |
|----------|----|---------------|---|-----------|-------------------------|
| 1.7 D | 42 | 10/93 → 10/99 | D | 146B2.000 | (+)COP, (-)SS, (-)AC |
| | 44 | 01/88 → 10/99 | D | 146B2.000 | (+)COP, (-)SS, (-)AC |
| | 44 | 05/88 → 10/99 | D | 149B3.000 | (+)COP, (-)SS, (-)AC |
| 60 1.7 D | 42 | 05/88 → 10/96 | D | 146B2.000 | (+)COP, (-)SS, (-)AC |
| | 44 | 05/88 → 05/00 | D | 149B3.000 | (+)COP, (-)SS, (-)AC |

INNOCENTI
Elba

| | | | | | |
|-------|----|---------------|---|-----------|-------------------------|
| 1.7 D | 42 | 08/91 → 12/96 | D | 146B2.000 | (+)COP, (-)SS, (-)AC |
|-------|----|---------------|---|-----------|-------------------------|

81458 350981458000

FIAT
Panda I, Van

| | | | | | |
|-----|----|---------------|---|----------|--|
| 750 | 25 | 01/86 → 07/92 | B | 141B.000 | |
| | 25 | 01/86 → 01/95 | B | 141B.000 | |

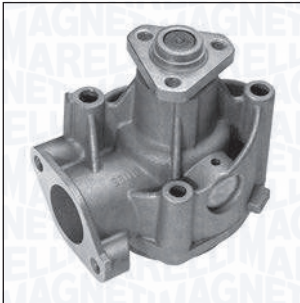
81460
350981460000

| | |
|-------------------------|---------|
| FLANGIA | |
| Numero Fori Flangia | 3 |
| Dimensione Fori Flangia | M8x1.25 |
| Posizione Attacco | 95.5 |
| Diametro Mozzo | Ø25.95 |
| Diametro Girante | Ø68 |
| N° Alette Girante | 12 |
| Posizione Girante | 17 |

FIAT
Croma I

| | | | | | |
|--------------------|-----|---------------|---|------------------------|----------------------------|
| 2000 i.e. | 85 | 10/87 → 08/96 | B | 154C3.046, 834B.146 | 03-1991 →, T →: 285.922 |
| | 88 | 03/87 → 09/92 | B | 154C3.000, 834B.000 | 03-1991 →, T →: 285.922 |
| 2000 i.e. Turbo | 110 | 06/87 → 08/96 | B | 154C4.046, 834C.146 | 04-1991 →, T →: 285.922 |

Tempra, Station Wagon

| | | | | | |
|----------|----|---------------|---|-----------|-----------|
| 2.0 i.e. | 83 | 10/90 → 08/96 | B | 159A6.046 | → 12-1991 |
|----------|----|---------------|---|-----------|-----------|

Tipo I

| | | | | | |
|----------|----|---------------|---|-----------|-----------|
| 2.0 i.e. | 80 | 06/90 → 03/92 | B | 159A5.046 | → 06-1991 |
| | 83 | 03/90 → 04/95 | B | 159A6.046 | → 06-1991 |

LANCIA
Dedra, Station Wagon

| | | | | | |
|----------|----|---------------|---|-----------|-------------------------|
| 1.8 i.e. | 77 | 09/89 → 07/99 | B | 835A2.046 | 09-1989 →, → 04-1994 |
| | 80 | 09/89 → 06/94 | B | 835A2.000 | |
| 2.0 i.e. | 83 | 09/89 → 07/99 | B | 835A5.046 | 09-1989 →, → 04-1994 |
| | 86 | 09/89 → 07/92 | B | 835A5.000 | |

Thema I, Station Wagon

| | | | | | |
|--------------------|-----|---------------|---|-----------|-------------------------|
| 2000 i.e. | 86 | 09/88 → 05/92 | B | 834B1.000 | |
| | 85 | 09/87 → 05/92 | B | 834B.146 | |
| 2000 i.e. Turbo | 110 | 07/86 → 05/90 | B | 834C.146 | 12-1985 →, → 05-1990 |
| 2000 Turbo | 110 | 01/89 → 03/92 | B | 834C.146 | |

81463
350981463000

| | |
|-------------------------|---------|
| FLANGIA | |
| Numero Fori Flangia | 3 |
| Dimensione Fori Flangia | M8x1.25 |
| Posizione Attacco | 78.5 |
| Diametro Mozzo | Ø22 |
| Diametro Centraggio | Ø25.95 |
| Diametro Girante | Ø70 |
| N° Alette Girante | 7 |
| Posizione Girante | 28 |

FIAT
Tipo I

| | | | | | |
|-------|----|---------------|---|-------------------------|----------------------|
| 1.7 D | 43 | 01/88 → 10/94 | D | 149B4.000 | (+)COP, → 12-1992 |
| | 45 | 01/88 → 10/95 | D | 149B4.000 | (+)COP, → 12-1992 |
| 1.9 D | 48 | 07/91 → 08/95 | D | 149A1.000, 160A7.000 | (+)COP, → 12-1992 |

81464
350981464000

| | |
|----------------------------|------|
| PULEGGIA | |
| Diametro Puleggia | Ø100 |
| Numero Denti/Gole Puleggia | 6 |
| Posizione Attacco | 80.6 |
| Diametro Girante | Ø70 |
| N° Alette Girante | 7 |
| Posizione Girante | 28 |

ALFA ROMEO
145

| | | | | | |
|--------|----|---------------|---|---------------------|------------------------------------|
| 1.9 TD | 66 | 10/94 → 02/99 | D | AR33601, AR67501 | (+)COP, 10-1994 →, → 09-1996 |
|--------|----|---------------|---|---------------------|------------------------------------|

146

| | | | | | |
|--------|----|---------------|---|---------------------|------------------------------------|
| 1.9 TD | 66 | 12/94 → 02/99 | D | AR33601, AR67501 | (+)COP, 12-1994 →, → 09-1996 |
|--------|----|---------------|---|---------------------|------------------------------------|

155

| | | | | | |
|--------|----|---------------|---|---------|------------------------------------|
| 1.9 TD | 66 | 04/93 → 12/97 | D | AR67501 | (+)COP, 04-1993 →, → 02-1996 |
|--------|----|---------------|---|---------|------------------------------------|

81464 350981464000

FIAT
Tempra, Station Wagon

| | | | | | |
|--------|----|---------------|---|-------------------------|-------------------------------------|
| 1.9 TD | 66 | 05/90 → 08/96 | D | 160A6.000, 160D1.000 | (+)COP, → M: 1.071.902, (+)AC |
|--------|----|---------------|---|-------------------------|-------------------------------------|

Tipo I

| | | | | | |
|--------|----|---------------|---|---------------------------------------|---|
| 1.9 TD | 59 | 03/92 → 06/93 | D | 160B6.046 | (+)COP, → 12-1992, (+)SS, (+)AC |
| | 66 | 09/90 → 04/95 | D | 160A6.000, 160A6.046, 160D1.000 | (+)COP, → 12-1992, (+)AC, (+)SS, (+)AC |

LANCIA
Dedra, Station Wagon

| | | | | | |
|---------|----|---------------|---|---------------------------------------|----------------------|
| 1.9 TDS | 66 | 04/89 → 07/99 | D | 160D1.000, 835A4.000, 835A4.046 | (+)COP, → 04-1994 |
|---------|----|---------------|---|---------------------------------------|----------------------|

81469 350981469000

FLANGIA

| | |
|-------------------------|---------|
| Numero Fori Flangia | 3 |
| Dimensione Fori Flangia | M8×1.25 |
| Posizione Attacco | 61.5 |
| Diametro Mozzo | Ø22 |
| Diametro Centraggio | Ø25.95 |
| Diametro Girante | Ø70 |
| N° Alette Girante | 7 |
| Posizione Girante | 28 |

FIAT
Uno I

| | | | | | |
|------------------|----|---------------|---|-----------|--------|
| 1.7 D | 43 | 11/94 → 08/00 | D | 146B2.000 | (+)COP |
| 1.9 D | 44 | 09/89 → 03/94 | D | 149B5.046 | (+)COP |
| | 58 | 01/89 → 12/91 | D | | (+)COP |
| 60 Diesel 1.7 | 42 | 09/89 → 12/93 | D | 146B2.000 | (+)COP |

81476 350981476000

PULEGGIA

| | |
|----------------------------|--------|
| Diametro Puleggia | Ø122.5 |
| Numero Denti/Gole Puleggia | 4 |
| Posizione Attacco | 76.7 |
| Diametro Girante | Ø65 |
| N° Alette Girante | 7 |
| Posizione Girante | 50 |

FIAT
Fiorino III, Pick Up (Uno)

| | | | | | |
|-------------|----|---------------|---|-------------------------|---------------------------|
| 1.4 | 49 | 05/94 → 05/01 | B | 146D5.000 | (+)COP, → M: 9.470.268 |
| | 52 | 11/92 → 10/96 | B | 146C5.000 | (+)COP, → M: 9.470.268 |
| 1.6 | 55 | 01/94 → 05/01 | B | 146C6.000, 146D6.000 | (+)COP, → M: 9.470.268 |
| 70 i.e. 1.4 | 49 | 05/94 → 05/01 | B | 146C5.000, 146D5.000 | (+)COP, → M: 9.470.268 |
| 75 i.e. 1.6 | 55 | 10/93 → 05/01 | B | 146C6.000, 146D6.000 | (+)COP, → M: 9.470.268 |

Tempra, Station Wagon

| | | | | | |
|----------|----|---------------|---|-------------------------|-------------------------------------|
| 1.4 i.e. | 51 | 03/92 → 08/96 | B | 160A1.046, 836A4.000 | (+)COP, → M: 9.336.692, (+)AC |
| | 57 | 03/91 → 08/96 | B | 159A2.000 | (+)COP, → M: 9.336.692, (+)AC |
| 1.6 | 51 | 04/90 → 06/93 | B | 159A3.048 | (+)COP, (+)AC |
| | 63 | 12/90 → 04/93 | B | 159A3.000 | (+)COP, (+)AC |
| | 63 | 03/90 → 04/93 | B | 159A3.000, 159B9.000 | (+)COP, (+)AC |
| 1.6 i.e. | 57 | 06/90 → 07/92 | B | 159A3.046 | (+)COP, (+)AC |
| | 57 | 10/90 → 08/96 | B | 159A3.046, 835C1.000 | (+)COP, → 12-1992, (+)AC |

Tipo I

| | | | | | |
|----------|----|---------------|---|-------------------------|---------------|
| 1.4 i.e. | 57 | 05/89 → 04/95 | B | 159A2.000 | (+)COP, (+)AC |
| | 51 | 05/89 → 04/95 | B | 160A1.046, 836A4.000 | (+)COP, (+)AC |
| 1.6 | 61 | 01/88 → 10/91 | B | 160A2.000 | (+)COP, (+)AC |
| 1.6 i.e. | 55 | 10/92 → 04/95 | B | 159A3.048, 835C1.000 | (+)COP, (+)AC |
| | 57 | 07/90 → 01/93 | B | 159A3.046 | (+)COP, (+)AC |

Uno I

| | | | | | |
|-------------|----|---------------|---|-----------|---------------|
| 70 i.e. 1.4 | 51 | 09/89 → 12/93 | B | 160A1.046 | (+)COP, (+)AC |
| | 53 | 09/89 → 12/93 | B | 146C1.000 | (+)COP, (+)AC |

81476
350981476000

INNOCENTI
Elba

| | | | | | |
|----------|----|---------------|---|-------------------------|----------------------|
| 1.4 i.e. | 49 | 09/94 → 12/96 | B | 146C5.000, 146D5.000 | (+)COP, → 02-1995 |
| 1.6 i.e. | 55 | 09/94 → 12/96 | B | 146C6.000, 146D6.000 | (+)COP |

LANCIA
Dedra, Station Wagon

| | | | | | |
|----------|----|---------------|---|-----------|--------|
| 1.6 i.e. | 57 | 08/89 → 03/93 | B | 835A1.046 | (+)COP |
| | 66 | 08/89 → 06/94 | B | 835A1.000 | (+)COP |

81477
350981477000

FLANGIA

| | |
|-------------------------|---------|
| Numero Fori Flangia | 3 |
| Dimensione Fori Flangia | M8×1.25 |
| Posizione Attacco | 83.5 |
| Diametro Mozzo | Ø23 |
| Diametro Centraggio | Ø25.95 |
| Diametro Girante | Ø68 |
| N° Alette Girante | 12 |
| Posizione Girante | 17 |

FIAT
Tempra, Station Wagon

| | | | | | |
|----------|----|---------------|---|-----------|-----------|
| 1.8 i.e. | 81 | 03/90 → 08/96 | B | 159A4.000 | → 06-1992 |
|----------|----|---------------|---|-----------|-----------|

Tipo I

| | | | | | |
|-------------------|-----|---------------|---|-----------|--|
| 1.6 i.e. | 66 | 02/88 → 05/91 | B | 149C2.046 | |
| 1.6 SX DGT | 66 | 05/89 → 10/95 | B | 159A3.000 | |
| 1.8 i.e.16V Sport | 100 | 11/89 → 06/92 | B | 160A5.000 | |

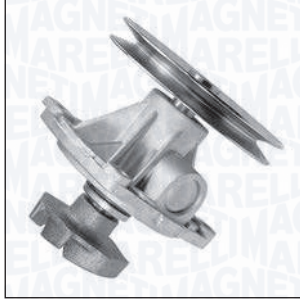
81481
350981481000

PULEGGIA

| | |
|----------------------------|------|
| Diametro Puleggia | Ø115 |
| Numero Denti/Gole Puleggia | 1 |
| Posizione Attacco | 74 |
| Diametro Girante | Ø65 |
| N° Alette Girante | 7 |
| Posizione Girante | 50 |

FIAT
Uno I

| | | | | | |
|----------------|----|---------------|---|-----------|---------------|
| 1.4 Turbo i.e. | 82 | 09/89 → 09/93 | B | 146A8.046 | (-)COP |
| | 87 | 12/89 → 12/96 | B | 146A8.000 | (-)COP |
| 70 i.e. 1.4 | 51 | 09/89 → 12/93 | B | 160A1.046 | (-)COP, (-)AC |
| | 53 | 09/89 → 12/93 | B | 146C1.000 | (-)COP, (-)AC |

INNOCENTI
Koral

| | | | | | |
|----|----|---------------|---|-----------|--------|
| 55 | 40 | 01/90 → 12/92 | B | 146A6.000 | (-)COP |
|----|----|---------------|---|-----------|--------|

LANCIA
Delta I

| | | | | | |
|-----|----|---------------|---|-------------------------|----------------------|
| 1.1 | 47 | 01/86 → 12/90 | B | 831B8.000 | (-)COP |
| | 58 | 09/83 → 08/92 | B | 831A2.000 | (-)COP |
| 1.3 | 55 | 09/79 → 08/92 | B | 831A2.000, 831B.000 | (-)COP |
| | 63 | 09/79 → 12/92 | B | 831A1.000, 831B1.000 | (-)COP, → 03-1986 |

Prisma

| | | | | | |
|-----|----|---------------|---|-----------|--------|
| 1.3 | 58 | 01/83 → 02/92 | B | 831A2.000 | (-)COP |
|-----|----|---------------|---|-----------|--------|

ZASTAVA
101

| | | | | | |
|-----|----|---------------|---|-----------|--------|
| 1.3 | 48 | 10/81 → 12/93 | B | 128AR.000 | (-)COP |
|-----|----|---------------|---|-----------|--------|

Yugo

| | | | | | |
|--------|----|---------------|---|-------------------------|--------|
| 60 EFI | 44 | 08/91 → 06/95 | B | 100GL.0.64, 11E1.064 | (-)COP |
| | 48 | 08/91 → 06/95 | B | 13E1.064 | (-)COP |

Yugo Florida

| | | | | | |
|-----|----|---------------|---|-----------|--------|
| 1.3 | 50 | 03/91 → | B | 13E.3.064 | (-)COP |
| 1.4 | 52 | 10/88 → 06/95 | B | 160A1.000 | (-)COP |

81488
350981488000

FLANGIA

| | |
|-------------------------|---------|
| Numero Fori Flangia | 3 |
| Dimensione Fori Flangia | M8×1.25 |
| Posizione Attacco | 82.75 |
| Diametro Mozzo | Ø27.88 |
| Diametro Girante | Ø93.5 |
| N° Alette Girante | 8 |
| Posizione Girante | 14.5 |

KW

FIAT
Ducato I

| | | | | | |
|------------|----|---------------|---|-------------------------|-----------|
| 2.4 D | 53 | 01/82 → 08/90 | D | 8144.61 | 10-1986 → |
| 2.5 D 4x4 | 55 | 03/89 → 08/90 | D | 8144.67 | |
| 2.5 TD | 68 | 01/86 → 08/90 | D | 8144.21 | |
| | 68 | 01/87 → 08/90 | D | 8144.21, 8144.21.220 | |
| 2.5 TD 4x4 | 68 | 01/86 → 08/90 | D | 8144.21 | |
| | 70 | 09/86 → 05/90 | D | 8140.27 | |

Ducato II

| | | | | | |
|------------|----|---------------|---|---------|--|
| 2.5 D | 55 | 07/90 → 03/94 | D | 8144.67 | |
| 2.5 D 4x4 | 55 | 07/90 → 03/94 | D | 8144.67 | |
| 2.5 TD | 70 | 07/90 → 03/94 | D | 8140.27 | |
| 2.5 TD 4x4 | 70 | 07/90 → 03/94 | D | 8140.27 | |

81489
350981489000

FLANGIA

| | |
|-------------------------|---------|
| Numero Fori Flangia | 3 |
| Dimensione Fori Flangia | M8×1.25 |
| Posizione Attacco | 78.5 |
| Diametro Mozzo | Ø22 |
| Diametro Centraggio | Ø25.95 |
| Diametro Girante | Ø70 |
| N° Alette Girante | 7 |
| Posizione Girante | 28.4 |

KW

FIAT
Ducato I

| | | | | | |
|--------|----|---------------|---|-----------|--|
| 1.9 D | 52 | 01/88 → 08/90 | D | 149B1.000 | |
| 1.9 TD | 60 | 03/89 → 08/90 | D | 280A1.000 | |

Ducato II

| | | | | | |
|--------|----|---------------|---|-----------|--|
| 1.9 D | 52 | 07/90 → 03/94 | D | 149B1.000 | |
| 1.9 TD | 60 | 03/89 → 03/94 | D | 280A1.000 | |

Talento

| | | | | | |
|-------|----|---------------|---|-----------|--|
| 1.9 D | 52 | 03/89 → 03/94 | D | 149B1.000 | |
|-------|----|---------------|---|-----------|--|

81490
350981490000

FLANGIA

| | |
|-------------------------|---------|
| Numero Fori Flangia | 3 |
| Dimensione Fori Flangia | M8×1.25 |
| Posizione Attacco | 95.5 |
| Diametro Mozzo | Ø23 |
| Diametro Centraggio | Ø25.95 |
| Diametro Girante | Ø68 |
| N° Alette Girante | 12 |
| Posizione Girante | 17 |

KW

FIAT
Croma I

| | | | | | |
|----------|-----|---------------|---|-----------|--|
| 2000 16V | 101 | 08/92 → 08/96 | B | 154E1.000 | |
|----------|-----|---------------|---|-----------|--|

LANCIA
Delta I

| | | | | | |
|--------------------------|-----|---------------|---|-------------------------|--|
| 2.0 16V HF Evo Integrale | 155 | 06/93 → 01/94 | B | 831E5.000, 831E5.046 | |
| 2.0 16V HF Integrale | 144 | 03/89 → 09/91 | B | 831D5.000 | |
| 2.0 HF Integrale | 130 | 12/86 → 12/92 | B | 831C5.046 | |

Kappa, Station Wagon, Coupé

| | | | | | |
|---------------|-----|---------------|---|-----------|--|
| 2.0 16V Turbo | 151 | 02/95 → 10/01 | B | 838A4.000 | |
|---------------|-----|---------------|---|-----------|--|

Thema I, Station Wagon

| | | | | | |
|---------------------|-----|---------------|---|-----------|--|
| 2000 16V | 112 | 08/92 → 12/93 | B | 834F1.000 | |
| 2000 16V Turbo | 133 | 12/88 → 06/90 | B | 834C1.000 | |
| | 148 | 10/92 → 07/94 | B | 834F2.000 | |
| 2000 i.e. 16V | 104 | 02/89 → 05/92 | B | 834B2.246 | |
| | 108 | 05/88 → 08/92 | B | 834B2.000 | |
| 2000 i.e. 16V Turbo | 130 | 04/89 → 05/92 | B | 834C1.246 | |
| | 133 | 12/88 → 06/90 | B | 834C1.000 | |
| 2000 Turbo 16V | 148 | 11/92 → 07/94 | B | 834F2.000 | |

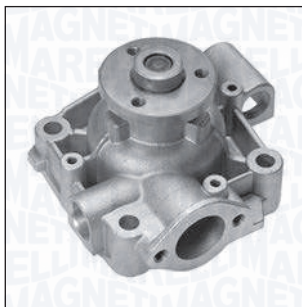
81491
350981491000

FLANGIA

| | |
|-------------------------|---------|
| Numero Fori Flangia | 3 |
| Dimensione Fori Flangia | M8x1.25 |
| Posizione Attacco | 82 |
| Diametro Mozzo | Ø28 |
| Diametro Girante | Ø93.5 |
| N° Alette Girante | 8 |
| Posizione Girante | 14.5 |



KW

IVECO
Daily II

| | | | | | |
|-------|----|---------------|---|---------------|-----------|
| 35-10 | 68 | 01/89 → 12/96 | D | 8140.97.2781 | → 12-1990 |
| | 76 | 01/89 → 12/96 | D | 8140.47R.2790 | → 12-1990 |

RENAULT
Master II

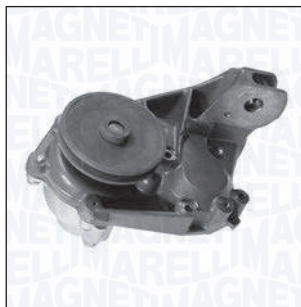
| | | | | | |
|-------|----|---------------|---|--------|-----------|
| 2.5 D | 59 | 07/98 → 01/01 | D | S8U770 | 11-1989 → |
|-------|----|---------------|---|--------|-----------|

81497
350981497000

PULEGGIA

| | |
|----------------------------|------|
| Diametro Puleggia | Ø104 |
| Numero Denti/Gole Puleggia | 1 |
| Posizione Attacco | 65.8 |
| Diametro Girante | Ø69 |
| N° Alette Girante | 7 |
| Posizione Girante | 45.6 |

KW

SEAT
Ibiza I

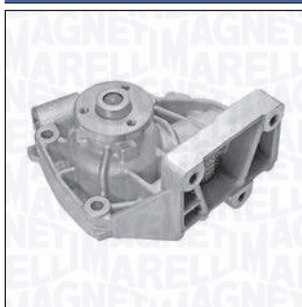
| | | | | | |
|-------|----|---------------|---|-----------|------------------------------------|
| 1.7 D | 40 | 06/84 → 05/93 | D | 022A.5000 | (+)COP, 01-1990 → |
| | 42 | 08/90 → 05/93 | D | 022A.5000 | (+)COP, 01-1990 →, → 12-1993 |

81492
350981492000

FLANGIA

| | |
|-------------------------|---------|
| Numero Fori Flangia | 3 |
| Dimensione Fori Flangia | M8x1.25 |
| Posizione Attacco | 82.8 |
| Diametro Mozzo | Ø28 |
| Diametro Girante | Ø93.5 |
| N° Alette Girante | 8 |
| Posizione Girante | 14.5 |

KW

FIAT
Ducato I

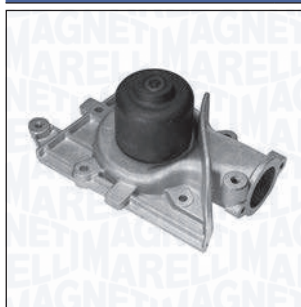
| | | | | | |
|-------|----|---------------|---|---------|-----------|
| 2.4 D | 53 | 01/82 → 08/90 | D | 8144.61 | → 09-1986 |
|-------|----|---------------|---|---------|-----------|

81498
350981498000

PULEGGIA

| | |
|-------------------|-------|
| Diametro Puleggia | Ø58 |
| Posizione Attacco | 78.5 |
| Diametro Girante | Ø67.5 |
| N° Alette Girante | 8 |
| Posizione Girante | 9.5 |

KW

SEAT
Ibiza I

| | | | | | |
|------------|----|---------------|---|-----------|--|
| 1.2 | 44 | 11/84 → 12/93 | B | 021A1000 | |
| | 46 | 11/84 → 12/93 | B | 021A1000 | |
| 1.2 i | 52 | 01/89 → 05/93 | B | 021C.1000 | |
| 1.5 | 63 | 11/84 → 05/93 | B | 021A2000 | |
| 1.5 i | 65 | 10/86 → 05/93 | B | 021D.2000 | |
| | 74 | 10/86 → 05/93 | B | 021B.2000 | |
| 1.5 i Cat. | 66 | 10/86 → 05/93 | B | 021C.2000 | |
| 1.7 | 72 | 01/91 → 05/93 | B | 021A.3000 | |
| | 76 | 01/91 → 05/93 | B | 021B.3000 | |

Malaga

| | | | | | |
|-------|----|---------------|---|-----------|--|
| 1.2 | 44 | 05/85 → 12/93 | B | 021A1000 | |
| | 47 | 11/84 → 12/93 | B | 021A1000 | |
| 1.2 i | 52 | 12/89 → 12/93 | B | 021C.1000 | |
| 1.5 | 63 | 05/85 → 12/93 | B | 021A2000 | |
| 1.5 i | 74 | 01/87 → 12/93 | B | 021B.2000 | |

81498 350981498000

SEAT
Malaga

| | | | | |
|------------|----|---------------|---|---------------------------------------|
| 1.5 i Cat. | 66 | 10/86 → 12/93 | B | 021A.2000, 021C.2000, 021D.2000 |
|------------|----|---------------|---|---------------------------------------|

81499 350981499000

FLANGIA

| | |
|-------------------------|------------|
| Numero Fori Flangia | 4 |
| Dimensione Fori Flangia | M6×1 |
| Posizione Attacco | 80 |
| Diametro Mozzo | M30×1.5 SX |
| Diametro Centraggio | Ø35 |
| Diametro Girante | Ø77 |
| N° Alette Girante | 4 |
| Posizione Girante | 15.4 |

MERCEDES-BENZ
Classe C I (W202), Station Wagon (S202)

| | | | | |
|-----------------------|-----|---------------|---|-----------------------|
| C 180 | 89 | 11/94 → 05/00 | B | M111.921 |
| | 90 | 03/93 → 05/00 | B | M111.920, M111.921 |
| C 180 T | 90 | 06/96 → 09/00 | B | M111.920, M111.921 |
| | 95 | 09/00 → 03/01 | B | M111.952 |
| C 200 | 100 | 01/94 → 05/00 | B | M111.941, M111.945 |
| C 200 CDI | 75 | 03/98 → 05/00 | D | OM611.960 |
| C 200 Kompressor | 132 | 10/95 → 05/00 | B | M111.944 |
| | 141 | 11/96 → 05/00 | B | M111.944 |
| C 200 T | 100 | 06/96 → 03/01 | B | M111.941, M111.945 |
| C 200 T Kompressor | 120 | 09/00 → 03/01 | B | M111.956 |
| | 141 | 11/96 → 03/01 | B | M111.944 |
| C 220 | 110 | 03/93 → 05/00 | B | M111.961 |
| C 220 T D | 70 | 06/96 → 09/98 | D | OM604.910 |
| C 230 | 110 | 06/96 → 06/97 | B | M111.974 |
| C 230 T | 110 | 06/96 → 06/98 | B | M111.974 |

Classe E I (W124), Station Wagon (S124), Cabrio (A124), Coupé (C124)

| | | | | | |
|---------|-----|---------------|---|----------|-------------------------|
| E 200 | 100 | 06/93 → 03/98 | B | M111.940 | 06-1993 → |
| | 100 | 06/93 → 06/95 | B | M111.940 | |
| E 200 T | 100 | 06/93 → 06/96 | B | M111.940 | 06-1993 →, → 01-1996 |
| E 220 | 110 | 06/93 → 03/98 | B | M111.960 | 06-1993 → |
| | 110 | 06/93 → 06/95 | B | M111.960 | |
| E 220 T | 110 | 06/93 → 06/96 | B | M111.960 | |

81499 350981499000

MERCEDES-BENZ
Classe E II (W210), Station Wagon (S210)

| | | | | |
|-----------------------|-----|---------------|---|----------|
| E 200 | 100 | 06/95 → 08/00 | B | M111.942 |
| E 200 Kompressor | 120 | 08/00 → 03/02 | B | M111.957 |
| E 200 T | 100 | 06/96 → 08/00 | B | M111.942 |
| E 200 T Kompressor | 120 | 08/00 → 03/03 | B | M111.957 |
| E 230 | 110 | 06/95 → 06/97 | B | M111.970 |
| E 230 T | 110 | 06/96 → 06/97 | B | M111.970 |

Classe M I (W163)

| | | | | |
|--------|-----|---------------|---|----------|
| ML 230 | 110 | 02/98 → 06/05 | B | M111.977 |
|--------|-----|---------------|---|----------|

Classe S V (W220), Coupé (C215)

| | | | | |
|-------|-----|---------------|---|-----------------------|
| S 500 | 225 | 10/98 → 08/05 | B | M113.960, M113.966 |
|-------|-----|---------------|---|-----------------------|

CLK I (C208), Cabrio (A208)

| | | | | |
|-----|-----|---------------|---|----------|
| 200 | 100 | 06/97 → 06/02 | B | M111.945 |
|-----|-----|---------------|---|----------|

Coupé III (C124)

| | | | | |
|--------|-----|---------------|---|----------|
| 220 CE | 110 | 10/92 → 05/93 | B | M111.960 |
|--------|-----|---------------|---|----------|

Kombi II (S124)

| | | | | |
|--------|-----|---------------|---|----------|
| 220 TE | 110 | 10/92 → 05/93 | B | M111.960 |
|--------|-----|---------------|---|----------|

Saloon (W124)

| | | | | |
|-------|-----|---------------|---|----------|
| 200 E | 100 | 10/92 → 06/93 | B | M111.940 |
| | 110 | 10/92 → 06/93 | B | M111.960 |

SLK I (R170)

| | | | | |
|-----|-----|---------------|---|----------|
| 200 | 100 | 09/96 → 03/00 | B | M111.946 |
|-----|-----|---------------|---|----------|

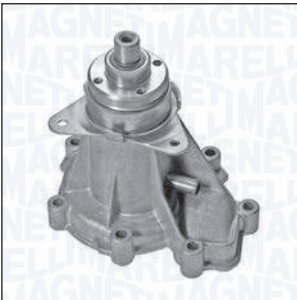
81504 350981504000

FLANGIA

| | |
|-------------------------|------|
| Numero Fori Flangia | 4 |
| Dimensione Fori Flangia | M6×1 |
| Posizione Attacco | 115 |
| Diametro Mozzo | Ø27 |
| Diametro Girante | Ø69 |
| N° Alette Girante | 8 |
| Posizione Girante | 21.5 |

MERCEDES-BENZ
190 (W201)

| | | | | |
|-------|----|---------------|---|-----------|
| D 2.0 | 55 | 08/89 → 08/93 | D | OM601.911 |
|-------|----|---------------|---|-----------|

Classe C I (W202), Station Wagon (S202)

| | | | | | |
|---------|----|---------------|---|-----------|-----------|
| C 200 D | 65 | 10/96 → 05/00 | D | OM604.915 | 06-1993 → |
|---------|----|---------------|---|-----------|-----------|

Classe E I (W124), Station Wagon (S124), Cabrio (A124), Coupé (C124)

| | | | | |
|---------|----|---------------|---|-----------|
| E 200 D | 55 | 06/93 → 06/95 | D | OM601.912 |
|---------|----|---------------|---|-----------|

81504
350981504000

KW

MERCEDES-BENZ
Kombi II (S124)

| | | | | | |
|---------|----|---------------|---|-----------|-------------------------|
| 200 T D | 53 | 09/85 → 08/91 | D | OM601.912 | 01-1985 →, → 05-1993 |
| | 55 | 09/88 → 08/91 | D | OM601.912 | 01-1985 →, → 05-1993 |

Saloon (W124)

| | | | | | |
|-------|----|---------------|---|-----------|--|
| 200 D | 55 | 08/89 → 06/93 | D | OM601.912 | |
|-------|----|---------------|---|-----------|--|

81506
350981506000

FLANGIA

| | |
|-----------------------------------|------|
| Numero Fori Flangia | 4 |
| Numero Fori Flangia (Serie 2) | 2 |
| Dimensione Fori Flangia | M6×1 |
| Dimensione Fori Flangia (Serie 2) | Ø6 |
| Posizione Attacco | 106 |
| Diametro Mozzo | Ø35 |
| Diametro Girante | Ø69 |
| N° Alette Girante | 8 |
| Posizione Girante | 21.5 |

KW

DAEWOO
Korando, Cabrio

| | | | | | |
|--------|----|---------|---|--------------|--|
| 2.9 D | 72 | 01/99 → | D | MB-OM662 | |
| 2.9 TD | 88 | 01/99 → | D | MB-OM60129TD | |

Musso

| | | | | | |
|------------|----|---------------|---|--------------|--|
| 2.2 TD | 74 | 09/99 → | D | MBOM601 | |
| 2.9 D 4x4 | 73 | 01/99 → 09/99 | D | MB-OM662 | |
| 2.9 TD 4x4 | 88 | 01/99 → | D | MB-OM60129TD | |

MERCEDES-BENZ
190 (W201)

| | | | | | |
|-------------|----|---------------|---|-----------|-------------------------|
| D 2.5 | 66 | 04/85 → 08/93 | D | OM602.911 | |
| | 69 | 08/89 → 08/93 | D | OM602.911 | |
| Turbo-D 2.5 | 90 | 02/88 → 08/93 | D | OM602.961 | 01-1985 →, → 05-1993 |
| | 93 | 02/88 → 08/93 | D | OM602.961 | 01-1985 →, → 05-1993 |

Classe C I (W202), Station Wagon (S202)

| | | | | | |
|---------|----|---------------|---|-----------|--|
| C 250 D | 83 | 05/93 → 05/00 | D | OM605.910 | |
|---------|----|---------------|---|-----------|--|

Classe E I (W124), Station Wagon (S124), Cabrio (A124), Coupé (C124)

| | | | | | |
|---------------|-----|---------------|---|-----------|--------------|
| E 250 D | 83 | 07/93 → 06/95 | D | OM605.911 | → M: 033.729 |
| E 250 TD | 83 | 06/93 → 06/96 | D | OM605.911 | 01-1985 → |
| E 250 Turbo-D | 93 | 06/93 → 06/95 | D | OM602.962 | 01-1988 → |
| E 300 D | 100 | 07/93 → 06/95 | D | OM606.910 | 06-1993 → |

81506
350981506000

KW

MERCEDES-BENZ
Classe E I (W124), Station Wagon (S124), Cabrio (A124), Coupé (C124)

| | | | | | |
|-------------------------|-----|---------------|---|-----------|-----------|
| E 300 T Turbo-D | 108 | 06/93 → 06/96 | D | OM603.960 | 01-1987 → |
| E 300 T Turbo-D 4-matic | 108 | 06/93 → 06/96 | D | OM603.963 | 01-1987 → |
| E 300 TD | 100 | 06/93 → 06/96 | D | OM606.910 | 07-1995 → |
| E 300 Turbo-D | 108 | 06/93 → 06/95 | D | OM603.960 | 06-1993 → |
| E 300 Turbo-D 4-matic | 108 | 06/93 → 06/95 | D | OM603.963 | 06-1993 → |

Classe E II (W210), Station Wagon (S210)

| | | | | | |
|-----------------|-----|---------------|---|-----------|-----------|
| E 250 D | 83 | 06/95 → 07/99 | D | OM605.912 | 01-1985 → |
| E 250 T D | 83 | 06/96 → 07/99 | D | OM605.912 | 01-1988 → |
| E 250 T Turbo-D | 110 | 06/97 → 07/99 | D | OM605.962 | 01-1988 → |
| E 250 Turbo-D | 110 | 06/97 → 07/99 | D | OM605.962 | 01-1988 → |
| E 290 T Turbo-D | 95 | 06/96 → 07/99 | D | OM602.982 | |
| E 290 Turbo-D | 95 | 03/96 → 07/99 | D | OM602.982 | |
| E 300 D | 100 | 06/95 → 06/97 | D | OM606.912 | 07-1995 → |
| E 300 T Turbo-D | 130 | 12/96 → 07/99 | D | OM606.962 | 07-1995 → |
| E 300 Turbo-D | 130 | 12/96 → 07/99 | D | OM606.962 | |

Classe G (W460, W461), Cabrio (W463)

| | | | | | |
|----------------|-----|---------------|---|-----------|-------------------------|
| 250 GD | 62 | 10/87 → 12/92 | D | OM602.930 | 07-1982 →, → 10-1991 |
| | 68 | 12/88 → 08/92 | D | OM602.930 | 07-1982 →, → 10-1991 |
| | 68 | 02/90 → | D | OM602.939 | |
| | 69 | 06/90 → | D | OM602.931 | |
| 290 GD/G 290 D | 70 | 04/92 → | D | OM602.942 | 01-1992 → |
| 300 GD | 83 | 12/90 → 09/97 | D | OM603.931 | |
| 350 G Turbo-D | 100 | 09/91 → 09/97 | D | OM603.972 | → M: 004.348 |
| 350 Turbo GD | 100 | 09/91 → | D | OM603.972 | |
| G 290 TD | 88 | 07/97 → | D | OM602.983 | |
| G 300 TD | 130 | 08/96 → | D | OM606.964 | |

81506
350981506000

KW

MERCEDES-BENZ
Classe S IV (W140), Coupé (C140)

| | | | | | |
|---------------|-----|---------------|---|-----------|--|
| S 300 Turbo-D | 130 | 05/96 → 10/98 | D | OM606.961 | |
| S 350 Turbo-D | 110 | 01/93 → 10/98 | D | OM603.971 | |

Classe V

| | | | | | |
|----------|----|---------------|---|-----------|--|
| V 230 TD | 72 | 09/96 → 07/03 | D | OM601.970 | |
|----------|----|---------------|---|-----------|--|

Kombi II (S124)

| | | | | | |
|-----------------------|-----|---------------|---|-----------|--------------|
| 250 T D | 66 | 09/85 → 06/93 | D | OM602.912 | → M: 033.729 |
| | 69 | 01/89 → 06/93 | D | OM602.912 | |
| 300 T D | 80 | 09/86 → 06/93 | D | OM603.912 | 01-1985 → |
| | 81 | 01/89 → 06/93 | D | OM603.912 | 01-1985 → |
| 300 T Turbo-D | 83 | 01/89 → 06/93 | D | OM603.912 | 01-1985 → |
| | 108 | 01/89 → 06/93 | D | OM603.960 | 01-1987 → |
| 300 T Turbo-D 4-matic | 108 | 01/89 → 06/93 | D | OM603.960 | 01-1987 → |

Saloon (W124)

| | | | | | |
|---------------------|-----|---------------|---|-----------|--------------|
| 250 D | 66 | 04/85 → 06/93 | D | OM602.912 | |
| | 69 | 01/89 → 06/93 | D | OM602.912 | |
| 250 Turbo-D | 93 | 09/88 → 06/93 | D | OM602.962 | 01-1985 → |
| 300 D | 81 | 06/90 → 06/93 | D | OM603.912 | 01-1985 → |
| | 83 | 08/89 → 06/93 | D | OM603.912 | → M: 054.122 |
| 300 D 4-matic | 80 | 09/86 → 08/92 | D | OM603.913 | 01-1985 → |
| | 83 | 08/89 → 06/93 | D | OM603.913 | 01-1985 → |
| 300 Turbo-D | 108 | 09/88 → 06/93 | D | OM603.960 | 01-1987 → |
| 300 Turbo-D 4-matic | 108 | 01/88 → 06/93 | D | OM603.963 | 01-1987 → |

Sprinter I (901, 902, 903, 904)

| | | | | | |
|---------------|----|---------------|---|-----------|-----------|
| 208 D | 58 | 02/95 → 04/00 | D | OM601.943 | |
| 210 D | 75 | 03/97 → 04/00 | D | OM602.980 | 12-1994 → |
| 212 D | 90 | 02/95 → 04/00 | D | OM602.980 | 12-1994 → |
| | 90 | 02/95 → 04/00 | D | OM602.980 | |
| 308 D | 60 | 03/97 → 04/00 | D | OM601.943 | |
| 308 D 2.3 | 60 | 02/95 → 04/00 | D | OM601.943 | → 04-1995 |
| 310 D | 75 | 01/97 → 12/99 | D | OM602.980 | |
| 310 D 2.9 | 75 | 02/95 → 04/00 | D | OM602.980 | 12-1994 → |
| 310 D 4x4 | 75 | 05/97 → 08/02 | D | OM602.980 | 12-1994 → |
| 312 D 2.9 | 90 | 02/95 → 04/00 | D | OM602.980 | 12-1994 → |
| | 90 | 02/95 → 04/00 | D | OM602.980 | |
| 312 D 2.9 4x4 | 90 | 05/97 → 08/02 | D | OM602.980 | 12-1994 → |
| | 90 | 05/97 → 08/02 | D | OM602.980 | |

81506
350981506000

KW

MERCEDES-BENZ
Sprinter I (901, 902, 903, 904)

| | | | | | |
|-----------|----|---------------|---|-----------|-----------|
| 410 D | 75 | 02/96 → 05/06 | D | OM602.980 | 12-1994 → |
| 410 D 4x4 | 75 | 05/97 → 05/06 | D | OM602.980 | 12-1994 → |
| 412 D | 85 | 02/96 → 05/06 | D | OM602.980 | 12-1994 → |
| | 90 | 02/96 → 05/06 | D | OM602.980 | 12-1994 → |
| 412 D 4x4 | 85 | 05/97 → 05/06 | D | OM602.980 | 12-1994 → |
| | 90 | 05/97 → 05/06 | D | OM602.980 | 12-1994 → |

T1

| | | | | | |
|-----------|----|---------------|---|-----------|-------------------------|
| 208 D 2.3 | 58 | 10/88 → 02/96 | D | OM601.940 | |
| | 60 | 10/88 → 02/96 | D | OM601.940 | 02-1988 →, → 04-1995 |
| 210 D 2.8 | 60 | 06/89 → 02/96 | D | OM601.940 | |
| | 70 | 11/88 → 02/96 | D | OM602.940 | 01-1983 → |
| 210 D 2.9 | 72 | 11/88 → 02/96 | D | OM602.940 | 01-1983 → |
| | 72 | 11/88 → 02/96 | D | OM602.940 | |
| 308 D 2.3 | 58 | 05/90 → 02/96 | D | OM601.940 | 01-1983 →, → 04-1995 |
| | 60 | 06/89 → 02/96 | D | OM601.940 | 01-1983 →, → 04-1995 |
| 310 D 2.9 | 70 | 06/89 → 02/96 | D | OM602.940 | 01-1983 → |
| | 70 | 06/89 → 02/96 | D | OM602.940 | |
| | 72 | 06/89 → 02/96 | D | OM602.940 | |
| | 72 | 06/90 → 02/96 | D | OM602.940 | 01-1983 → |

Vario

| | | | | | |
|-------|----|---------|---|-------------------------|--|
| 512 D | 90 | 09/96 → | D | OM602.984 | |
| 612 D | 90 | 09/96 → | D | OM602.984, OM602.985 | |
| 812 D | 90 | 09/96 → | D | OM602.984, OM602.985 | |
| O 812 | 90 | 09/96 → | D | OM602.984, OM602.985 | |

Vito I (W638)

| | | | | | |
|------------|----|---------------|---|-----------|-----------|
| 108 D 2.3 | 58 | 02/96 → 07/03 | D | OM601.942 | |
| | 58 | 03/97 → 07/03 | D | OM601.942 | 11-1995 → |
| 110 D 2.3 | 72 | 03/97 → 07/03 | D | OM601.970 | 11-1995 → |
| 110 TD 2.3 | 72 | 02/96 → 07/03 | D | OM601.970 | |

PUCH
G Model

| | | | | | |
|----------------|-----|---------|---|-----------|--|
| 290 GD/G 290 D | 70 | 04/92 → | D | OM602.942 | |
| 350 G Turbo D | 100 | 09/91 → | D | OM603.972 | |
| G 290 TD | 88 | 07/97 → | D | OM602.983 | |

81506
350981506000

KW

SSANGYONG
Korando II, Cabrio

| | | | | | |
|--------|----|---------|---|-----------|--|
| 2.3 D | 58 | 12/96 → | D | OM601.940 | |
| 2.9 D | 72 | 11/97 → | D | MB-OM662 | |
| | 72 | 12/96 → | D | MB-OM662 | |
| 2.9 TD | 88 | 04/98 → | D | | |

Musso

| | | | | | |
|--------|----|---------|---|------------------------|--|
| 2.3 D | 59 | 10/95 → | D | MB-OM661, OM601.940 | |
| 2.9 D | 73 | 03/96 → | D | MB-OM662 | |
| 2.9 TD | 88 | 04/98 → | D | | |

Rexton

| | | | | | |
|--------|----|---------|---|--|--|
| 2.9 TD | 88 | 04/02 → | D | | |
|--------|----|---------|---|--|--|

81507
350981507000

FLANGIA

| | |
|-------------------------|---------|
| Numero Fori Flangia | 3 |
| Dimensione Fori Flangia | M8×1.25 |
| Posizione Attacco | 128.2 |
| Diametro Mozzo | Ø30 |
| Diametro Girante | Ø76 |
| N° Alette Girante | 4 |
| Posizione Girante | 22 |

KW

MERCEDES-BENZ
190 (W201)

| | | | | | |
|-------|-----|---------------|---|----------|--|
| E 2.6 | 118 | 09/86 → 08/93 | B | M103.942 | |
|-------|-----|---------------|---|----------|--|

Classe E I (W124), Station Wagon (S124), Cabrio (A124), Coupé (C124)

| | | | | | |
|--------------------|-----|---------------|---|----------|--|
| E 300 4-matic | 132 | 06/93 → 06/95 | B | M103.985 | 01-1985 →, → 12-1996, M →: 094.339 |
| E 300 T 4-matic | 132 | 06/93 → 06/96 | B | M103.985 | 06-1993 →, → 01-1996 |

Classe G (W460, W461), Cabrio (W463)

| | | | | | |
|--------|-----|---------|---|----------|-----------|
| 300 GE | 125 | 06/90 → | B | M103.987 | 01-1989 → |
| | 128 | 06/90 → | B | M103.987 | 01-1989 → |

Classe S III (W126), Coupé (C126)

| | | | | | |
|------------|-----|---------------|---|----------|--|
| 260 SE | 118 | 09/85 → 06/91 | B | M103.941 | 09-1985 →, → 06-1991, M →: 002.988 |
| | 122 | 09/85 → 06/91 | B | M103.941 | 09-1985 →, → 06-1991, M →: 002.988 |
| 300 SE,SEL | 132 | 01/86 → 06/91 | B | M103.981 | |

81507
350981507000

KW

MERCEDES-BENZ
Coupé III (C124)

| | | | | | |
|--------|-----|---------------|---|----------|--------------|
| 300 CE | 132 | 03/87 → 05/93 | B | M103.983 | M →: 018.293 |
|--------|-----|---------------|---|----------|--------------|

Kombi II (S124)

| | | | | | |
|--------|-----|---------------|---|----------|--------------|
| 300 TE | 132 | 01/86 → 08/92 | B | M103.983 | M →: 018.293 |
|--------|-----|---------------|---|----------|--------------|

| | | | | | |
|-------------------|-----|---------------|---|----------|--|
| 300 TE 4-matic | 132 | 09/86 → 06/93 | B | M103.985 | 01-1985 →, → 05-1996, M →: 094.339 |
|-------------------|-----|---------------|---|----------|--|

Saloon (W124)

| | | | | | |
|-------|-----|---------------|---|----------|--------------|
| 260 E | 118 | 09/85 → 08/92 | B | M103.940 | M →: 016.912 |
|-------|-----|---------------|---|----------|--------------|

| | | | | | |
|------------------|-----|---------------|---|----------|--|
| 260 E 4-matic | 118 | 09/86 → 08/92 | B | M103.943 | 01-1985 →, → 05-1996, M →: 035.732 |
|------------------|-----|---------------|---|----------|--|

| | | | | | |
|-------|-----|---------------|---|-----------------------|---|
| 300 E | 138 | 01/85 → 08/92 | B | M103.980, M103.983 | 01-1985 →, → 05-1996, M →: 018.293, → M: 018.293 |
| | 132 | 08/85 → 08/92 | B | M103.983 | M →: 018.293 |

| | | | | | |
|------------------|-----|---------------|---|----------|--|
| 300 E 4-matic | 138 | 09/86 → 02/92 | B | M103.983 | 01-1985 →, → 05-1993, M →: 094.339 |
| | 132 | 09/86 → 06/93 | B | M103.985 | 02-1985 →, → 05-1993, M →: 094.339 |

SL III (R129)

| | | | | | |
|--------|-----|---------------|---|----------|-------------------------|
| 300 SL | 140 | 03/89 → 08/93 | B | M103.984 | 06-1989 →, → 09-1993 |
|--------|-----|---------------|---|----------|-------------------------|

PUCH
G Model

| | | | | | |
|--------|-----|---------|---|----------|--|
| 300 GE | 125 | 06/90 → | B | M103.987 | |
|--------|-----|---------|---|----------|--|

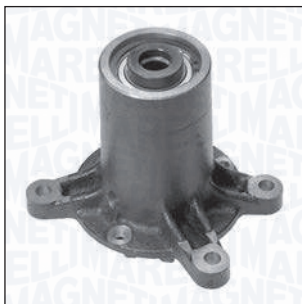
81508
350981508000

ALBERINO

Diametro Alberino M12x1.5
 Tipo Filetto Alberino Femmina
 Posizione Attacco 98
 Diametro Girante Ø68.5
 N° Alette Girante 8
 Posizione Girante 32.5



KW

MERCEDES-BENZ
100

| | | | | |
|---|----|---------------|---|-----------|
| D | 41 | 12/90 → 12/94 | D | OM616 |
| | 53 | 02/88 → 05/92 | D | OM616.963 |
| | 55 | 12/90 → 02/96 | D | OM616.963 |

T1

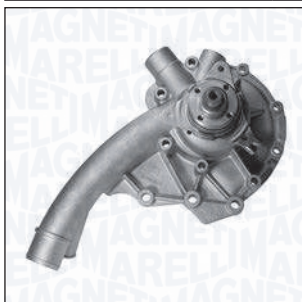
| | | | | |
|-----------|----|---------------|---|-------------------------|
| 207 D 2.4 | 53 | 07/82 → 01/90 | D | |
| | 53 | 06/82 → 01/90 | D | OM616.937, OM616.939 |
| 307 D 2.4 | 53 | 10/82 → 01/90 | D | OM616.937, OM616.939 |

81509
350981509000

FLANGIA

Numero Fori Flangia 4
 Dimensione Fori Flangia M6x1
 Posizione Attacco 98
 Diametro Mozzo Ø27
 Diametro Girante Ø80
 N° Alette Girante 4
 Posizione Girante 20.5

KW

DAEWOO
Korando, Cabrio

| | | | | |
|-----|-----|---------|---|----------|
| 2.3 | 105 | 01/99 → | B | M161.970 |
|-----|-----|---------|---|----------|

Musso

| | | | | |
|-----|-----|---------|---|----------|
| 2.3 | 103 | 01/99 → | B | M111.970 |
|-----|-----|---------|---|----------|

MERCEDES-BENZ
190 (W201)

| | | | | |
|-------|----|---------------|---|-----------------------|
| 2.0 | 75 | 01/86 → 05/90 | B | M102.924 |
| | 77 | 09/84 → 05/90 | B | M102.924 |
| E 1.8 | 80 | 04/90 → 08/93 | B | M102.910 |
| E 2.0 | 87 | 01/85 → 08/93 | B | M102.962 |
| | 93 | 10/82 → 06/93 | B | M102.961 |
| | 90 | 10/82 → 06/93 | B | M102.961, M102.962 |

81509
350981509000

KW

MERCEDES-BENZ
190 (W201)

| | | | | | |
|--------------------|-----|---------------|---|----------|-------------------------|
| E 2.3 | 97 | 09/86 → 08/91 | B | M102.985 | |
| | 100 | 10/86 → 08/93 | B | M102.985 | |
| E 2.5-16 | 143 | 03/89 → 08/93 | B | M102.991 | |
| | 150 | 09/88 → 08/93 | B | M102.990 | 05-1991 →, → 05-1993 |
| E Evolution II 2.5 | 173 | 05/90 → 08/93 | B | M102.992 | 05-1991 →, → 05-1993 |

Coupé III (C124)

| | | | | |
|--------|-----|---------------|---|----------|
| 230 CE | 97 | 03/87 → 12/92 | B | M102.982 |
| | 100 | 03/87 → 12/92 | B | M102.982 |

Kombi II (S124)

| | | | | |
|--------|-----|---------------|---|----------|
| 200 T | 77 | 01/86 → 05/90 | B | M102.922 |
| 200 TE | 87 | 09/88 → 08/92 | B | M102.963 |
| 230 TE | 97 | 09/85 → 08/92 | B | M102.982 |
| | 100 | 09/85 → 08/92 | B | M102.982 |

Saloon (W124)

| | | | | |
|-------|-----|---------------|---|----------|
| 200 | 77 | 01/86 → 05/90 | B | M102.922 |
| | 75 | 01/86 → 05/90 | B | M102.922 |
| | 80 | 12/85 → 05/90 | B | M102.922 |
| 200 E | 87 | 09/88 → 08/92 | B | M102.963 |
| 230 E | 97 | 12/84 → 06/93 | B | M102.982 |
| | 100 | 01/85 → 06/93 | B | M102.982 |

81512
350981512000

PULEGGIA

Diametro Puleggia Ø59.26
 Numero Denti/Gole Puleggia 20
 Altezza Puleggia 33.5
 Posizione Attacco 42.5
 Diametro Girante Ø60
 N° Alette Girante 6
 Posizione Girante 40

KW

CITROËN
Berlingo I, Van

| | | | | | |
|-----------|----|---------------|---|-------------|-----------|
| 1.8 i | 66 | 08/99 → 10/02 | B | LFX (XU7JB) | |
| | 66 | 05/97 → | B | LFX (XU7JB) | 01-1998 → |
| 1.8 i 4WD | 66 | 04/97 → | B | LFX (XU7JB) | 01-1998 → |

BX, Break

| | | | | | |
|-------------|----|---------------|---|-------------|--------------|
| 1.9 GTi 4x4 | 92 | 02/92 → 06/94 | B | | PROD →: 5410 |
| 1.9 TZi | 92 | 02/92 → 12/94 | B | D6A (XU9J2) | PROD →: 5410 |
| 15 | 59 | 10/87 → 05/92 | B | B1E (XU51C) | |

81512
350981512000

KW

CITROËN
BX, Break

| | | | | | |
|----------------|------|---------------|---------------|-----------------------------------|----------------------------|
| 16 | 53 | 01/87 → 02/93 | B | B1E (XU51C) | 02-1992 →, PROD →: 5410 |
| | 55 | 09/88 → 02/93 | B | BAY (XU5CP), BAZ (XU5CP) | 02-1992 →, PROD →: 5410 |
| | 58 | 09/87 → 02/93 | B | B1A (XU51C/K) | 02-1992 →, PROD →: 5410 |
| | 64 | 07/85 → 02/93 | B | 171D | 02-1992 →, PROD →: 5410 |
| | 65 | 05/89 → 12/94 | B | BDY (XU5M), BDZ (XU5M) | 02-1992 →, PROD →: 5410 |
| | 68 | 10/82 → 12/92 | B | XU52C | 02-1992 →, PROD →: 5410 |
| | 76 | 03/86 → 02/93 | B | 180Z | 02-1992 →, PROD →: 5410 |
| | 16 E | 65 | 05/89 → 02/93 | B | BDY (XU5M), BDZ (XU5M) |
| 19 | 75 | 07/86 → 12/94 | B | D2A (XU92C) | 02-1992 →, PROD →: 5410 |
| | 80 | 06/88 → 12/94 | B | DDZ (XU9M) | 02-1992 →, PROD →: 5410 |
| | 88 | 06/88 → 12/94 | B | DKZ (XU9JA) | 02-1992 →, PROD →: 5410 |
| 19 Cat. | 75 | 07/86 → 12/94 | B | DFZ (XU9J1) | 02-1992 →, PROD →: 5410 |
| 19 E | 80 | 06/88 → 02/93 | B | DDZ (XU9M) | 02-1992 →, PROD →: 5410 |
| 19 E 4x4 | 80 | 04/89 → 02/93 | B | D2F | 02-1992 →, PROD →: 5410 |
| 19 GTi | 88 | 06/88 → 02/93 | B | DKZ (XU9JA) | 02-1992 →, PROD →: 5410 |
| | 90 | 07/86 → 02/93 | B | D6A (XU9J2) | 02-1992 →, PROD →: 5410 |
| 19 GTi 16V | 108 | 03/88 → 02/93 | B | DFW (XU9J4) | 02-1992 →, PROD →: 5410 |
| 19 GTi 4x4 | 88 | 06/88 → 02/93 | B | DKZ (XU9JA) | 02-1992 →, PROD →: 5410 |
| Evasion | | | | | |
| 1.8 | 73 | 05/97 → 07/02 | B | LFZ (XU7JP) | 06-1996 → |

81512
350981512000

KW

CITROËN
Visa, Cabrio

| | | | | | |
|--------|----|---------------|---|-------------|----------------------------|
| 16 GTI | 83 | 06/86 → 03/91 | B | B6D | PROD →: 3584 |
| 17 D | 44 | 04/84 → 03/91 | D | 161A (XUD7) | 01-1987 →, PROD →: 3584 |

Xantia I, Break

| | | | | | |
|-------|----|---------------|---|-------------|-------------------------|
| 1.6 i | 65 | 03/93 → 01/98 | B | BFZ (XU5JP) | 11-1996 → |
| | 66 | 04/97 → 01/98 | B | LFX (XU7JB) | |
| 1.8 i | 74 | 03/93 → 01/98 | B | LFZ (XU7JP) | 03-1993 →, → 10-1996 |
| | 74 | 06/95 → 01/98 | B | LFZ (XU7JP) | 11-1996 → |

Xantia II, Break

| | | | | | |
|----------|----|---------------|---|-------------|--|
| 1.6 i SX | 65 | 01/98 → 03/01 | B | BFZ (XU5JP) | |
| 1.8 i | 66 | 01/98 → 04/03 | B | LFX (XU7JB) | |

Xsara, Break, Coupé, Picasso, Van

| | | | | | |
|------------|----|---------------|---|-------------|-----------|
| 1.8 i | 66 | 04/97 → 09/00 | B | LFX (XU7JB) | |
| | 66 | 10/97 → 09/00 | B | LFX (XU7JB) | 07-1997 → |
| | 74 | 02/98 → 09/00 | B | LFZ (XU7JP) | |
| 1.8 i Aut. | 74 | 04/97 → 09/00 | B | LFZ (XU7JP) | 07-1997 → |
| 1.8 SX | 76 | 06/00 → 08/05 | B | | |

ZX, Break

| | | | | | |
|-------|----|---------------|---|----------------------------|-----------------------------|
| 1.6 i | 65 | 03/91 → 06/97 | B | BDY (XU5M), BFZ (XU5JP) | 09-1992 →, PROD →: 5410 |
| | 65 | 10/93 → 10/97 | B | BDY (XU5M), BFZ (XU5JP) | 09-1992 →, PROD →: 5.410 |
| 1.8 i | 74 | 07/92 → 06/97 | B | LFZ (XU7JP) | PROD →: 5410 |
| 1.9 i | 88 | 03/91 → 06/97 | B | DKZ (XU9JA) | 09-1992 →, PROD →: 5410 |

FIAT
Ulysse I

| | | | | | |
|-----|----|---------------|---|-----|--|
| 1.8 | 73 | 05/97 → 08/02 | B | LFW | |
|-----|----|---------------|---|-----|--|

PEUGEOT
205 I, Van, Cabrio

| | | | | | |
|---------|----|---------------|---|-----------------|-----------|
| 1.6 CJ | 65 | 08/92 → 12/94 | B | BDY (XU5M3Z) | |
| 1.9 CTI | 75 | 10/87 → 12/94 | B | DFZ (XU9J1) | 01-1992 → |

205 II, Van

| | | | | | |
|--------------|----|---------------|---|-------------------------------------|-----------|
| 1.6 Aut. | 58 | 10/87 → 09/98 | B | | 01-1992 → |
| | 65 | 05/90 → 09/98 | B | BDY (XU5M2Z), BDY (XU5M3Z) | |
| 1.9 GTI | 88 | 10/87 → 10/94 | B | DKZ (XU9JAZ) | 01-1992 → |
| | 94 | 10/87 → 09/98 | B | D6B (XU9JA) | 01-1992 → |
| 1.9 GTI Cat. | 75 | 10/87 → 07/94 | B | DFZ (XU9J1) | 01-1992 → |

81512 350981512000

PEUGEOT
306, Station Wagon, Coupé, Cabrio, Van

| | | | | | |
|--------|----|---------------|---|-------------|--|
| 1.8 | 74 | 05/93 → 05/01 | B | LFZ (XU7JP) | |
| 1.8 ST | 74 | 06/94 → 05/01 | B | LFZ (XU7JP) | |

309 II

| | | | | | |
|-------------|-----|---------------|---|--|-----------|
| 1.6 | 65 | 07/89 → 12/93 | B | BDY (XU5M2Z), BDY (XU5M3Z), BDZ (XU5M) | 02-1992 → |
| | 68 | 07/89 → 12/93 | B | B2A (XU52C/K) | 02-1992 → |
| | 69 | 07/89 → 12/93 | B | B2A (XU52C/K) | 02-1992 → |
| 1.6 GTi | 85 | 09/89 → 10/93 | B | | 02-1992 → |
| 1.9 | 72 | 08/89 → 12/93 | B | DFZ (XU9J1) | 02-1992 → |
| | 80 | 10/90 → 12/93 | B | DDZ (XU9M) | 02-1992 → |
| 1.9 GTI | 88 | 07/89 → 12/93 | B | DKZ (XU9JAZ) | 02-1992 → |
| 1.9 GTI 16V | 108 | 10/90 → 12/93 | B | DFW (XU9J4Z) | |
| | 116 | 08/89 → 07/90 | B | D6C (XU9J4) | |

405 I, Station Wagon

| | | | | | |
|---------------------|-----|---------------|---|--------------|--|
| 1.9 4x4 | 108 | 07/90 → 07/92 | B | | |
| | 116 | 06/87 → 07/92 | B | D6C (XU9J4) | |
| 1.9 Sport MI-16 | 108 | 04/88 → 12/92 | B | DFW (XU9J4Z) | |
| | 116 | 07/87 → 11/91 | B | D6C (XU9J4) | |
| 1.9 SPort MI-16 4x4 | 108 | 04/88 → 12/92 | B | DFW (XU9J4Z) | |

405 II, Station Wagon

| | | | | | |
|--------|----|---------------|---|--|--|
| 1.6 | 65 | 08/92 → 10/95 | B | BDY (XU5M2Z), BDY (XU5M3Z), BDZ (XU5M), BFZ (XU5JP) | |
| 1.8 | 74 | 08/92 → 10/95 | B | LFZ (XU7JP) | |
| 1.9 D | 47 | 08/92 → 10/95 | D | DJZ (XUD9Y) | |
| | 50 | 06/94 → 10/95 | D | DJY (XUD9A) | |
| 1.9 TD | 66 | 08/92 → 10/95 | D | DHY (XUD9TE) | |

407, Station Wagon, Coupé

| | | | | | |
|-----|----|---------------|---|-------------|-----------|
| 1.6 | 65 | 11/95 → 05/04 | B | BFZ (XU5JP) | |
| 1.8 | 66 | 05/97 → 05/04 | B | LFX (XU7JB) | |
| | 66 | 05/97 → 10/04 | B | LFX (XU7JB) | 06-1997 → |

81512 350981512000

PEUGEOT
806

| | | | | | |
|-----|----|---------------|---|-------------|--|
| 1.8 | 73 | 07/95 → 08/02 | B | LFW (XU7JP) | |
|-----|----|---------------|---|-------------|--|

Expert I

| | | | | | |
|-----|----|---------------|---|-------------|--|
| 1.8 | 74 | 10/96 → 09/00 | B | LFZ (XU7JP) | |
|-----|----|---------------|---|-------------|--|

Partner I

| | | | | | |
|-------|----|---------|---|-------------|-----------|
| 1.8 | 66 | 05/97 → | B | LFX (XU7JB) | 03-1997 → |
| 1.8 D | 43 | 06/96 → | D | A9A (XUD7) | 03-1997 → |

81513 350981513000

CITROËN
AX

| | | | | | |
|------------|------|---------------|---------------|--|--|
| 1.4 Allure | 48 | 08/92 → 04/94 | B | K1F | |
| 1.4 GTi | 66 | 08/91 → 12/96 | B | KFY (TU3FJ2) | 08-1992 → |
| | 69 | 06/91 → 12/96 | B | KFZ (TU3FJ2) | 08-1992 → |
| 1.4 GTi | 74 | 06/91 → 12/92 | B | KFZ (TU3FJ2) | PROD → : 5.279 |
| | 14 | 55 | 04/87 → 04/97 | B | KDX (TU3M/Z), KDY (TU3FM), KDY (TU3M), KDZ (TU3M/Z) |
| 1.4 4x4 | 55 | 08/91 → 12/96 | B | KDX (TU3M/Z), KDY (TU3FM), KDY (TU3M), KDZ (TU3M/Z) | 08-1992 → |
| | 15 D | 40 | 08/94 → 12/97 | D | VJY (TUD5) |
| 15 D | 43 | 08/94 → 12/97 | D | VJY (TUD5), VJZ (TUD5) | |

81513
350981513000

CITROËN
BX, Break

| | | | | | |
|------|----|---------------|---|-----------------------------|----------------------------|
| 14 | 53 | 01/86 → 02/93 | B | 150C | 02-1992 →, PROD →: 5440 |
| | 55 | 01/89 → 02/93 | B | KDY (TU3M) | 02-1992 →, PROD →: 5440 |
| | 55 | 01/89 → 02/93 | B | KDY (TU3M), KDZ (TU3M/Z) | 02-1992 →, PROD →: 5440 |
| 14 E | 49 | 09/85 → 02/93 | B | 150F | 02-1992 →, PROD →: 5440 |
| | 53 | 04/83 → 02/93 | B | 150C | 02-1992 →, PROD →: 5440 |

Saxo

| | | | | | |
|-------------|----|---------------|---|-------------|--|
| 1.5 D | 40 | 09/96 → 09/03 | D | VJY (TU5) | |
| | 42 | 09/96 → 06/01 | D | VJZ (TU5) | |
| 1.6 | 66 | 02/96 → 06/03 | B | NFZ (TU5JP) | |
| | 74 | 02/01 → 04/04 | B | NFT (TU5JP) | |
| 1.6 VTL,VTR | 65 | 05/96 → 06/03 | B | NFZ (TU5JP) | |
| 1.6 VTS | 72 | 09/00 → 09/03 | B | NFT (TU5JP) | |

Xsara, Break, Coupé, Picasso, Van

| | | | | | |
|------------|----|---------------|---|--------------|--------------|
| 1.5 D | 42 | 04/97 → 09/00 | D | VJZ (TU5) | |
| | 42 | 10/97 → 09/00 | D | VJZ (TU5) | → PROD: 8385 |
| 1.6 | 65 | 12/99 → | B | NFZ (TU5JP) | |
| | 67 | 06/02 → | B | NFZ (TU5JP) | |
| | 70 | 12/99 → | B | NFV (TU5JP) | |
| 1.6 16V | 80 | 09/05 → | B | NFU (TU5JP4) | |
| 1.6 Chrono | 74 | 04/01 → 10/04 | B | | |
| 1.6 i | 65 | 04/97 → 09/00 | B | NFZ (TU5JP) | 07-1997 → |
| | 65 | 02/98 → 09/00 | B | NFZ (TU5JP) | |

MEGA
Club I

| | | | | | |
|-----------|----|---------------|---|--|--|
| 1.4 i | 55 | 01/92 → 06/99 | B | | |
| 1.4 i 4x4 | 55 | 01/92 → 06/99 | B | | |
| 1.5 D | 43 | 01/94 → 06/99 | B | | |
| 1.5 D 4x4 | 43 | 01/94 → 06/99 | B | | |

Club II

| | | | | | |
|-------|----|---------|---|--|--|
| 1.4 i | 55 | 06/99 → | B | | |
|-------|----|---------|---|--|--|

NISSAN
Micra II (K11)

| | | | | | |
|-------|----|---------------|---|------|--|
| 1.5 D | 42 | 02/98 → 02/03 | D | TD15 | |
|-------|----|---------------|---|------|--|

81513
350981513000

PEUGEOT
106 I, Van

| | | | | | |
|-------|----|---------------|---|-------------|--|
| 1.5 D | 40 | 06/94 → 04/96 | D | VJY (TU5) | |
| | 42 | 10/00 → 03/01 | D | VJX (TU5) | |
| | 43 | 06/94 → 04/96 | D | VJY (TU5) | |
| 1.6 | 76 | 01/94 → 04/96 | B | NFY (TU5J2) | |

106 II

| | | | | | |
|-------|----|---------|---|-----------------------------|-----------|
| 1.5 D | 40 | 05/96 → | D | VJY (TU5) | 04-1996 → |
| | 42 | 04/98 → | D | VJX (TU5) | |
| 1.6 i | 74 | 05/96 → | B | NFW (TU5J2), NFY (TU5J2) | |

205 II, Van

| | | | | | |
|-------|----|---------------|---|-------------|--|
| 1.6 i | 65 | 09/98 → 12/00 | B | NFZ (TU5JP) | |
|-------|----|---------------|---|-------------|--|

306, Station Wagon, Coupé, Cabrio, Van

| | | | | | |
|--------|----|---------------|---|-------------|--|
| 1.6 | 65 | 05/93 → 10/00 | B | NFZ (TU5JP) | |
| | 72 | 10/00 → 05/01 | B | NFT (TU5JP) | |
| 1.6 SR | 65 | 06/94 → 10/00 | B | NFZ (TU5JP) | |

405 II, Station Wagon

| | | | | | |
|-----|----|---------------|---|-------------|--|
| 1.4 | 55 | 08/92 → 10/95 | B | KDX (TU3MC) | |
|-----|----|---------------|---|-------------|--|

81520
350981520000



PULEGGIA

| | |
|----------------------------|-------|
| Diametro Puleggia | Ø77.5 |
| Numero Denti/Gole Puleggia | 26 |
| Altezza Puleggia | 20.5 |
| Posizione Attacco | 29 |
| Diametro Girante | Ø60 |
| N° Alette Girante | 8 |
| Posizione Girante | 31.5 |

VOLKSWAGEN
Golf II

| | | | | | |
|----------|----|---------------|---|------------|--------------|
| 1.0 | 37 | 08/85 → 10/91 | B | HZ | → M: 786.022 |
| 1.3 Cat. | 40 | 06/86 → 12/92 | B | 2G, MH, NZ | → M: 262.739 |

Jetta II

| | | | | | |
|----------|----|---------------|---|------------|--|
| 1.3 Cat. | 40 | 06/87 → 12/91 | B | 2G, MH, NZ | |
|----------|----|---------------|---|------------|--|

Polo II, Classic, Coupé, Van

| | | | | | |
|----------|----|---------------|---|------------------|----------------------------|
| 1.0 | 33 | 01/85 → 09/94 | B | AAK, AAU, HZ | → 07-1992, → M: 015.867 |
| | 33 | 08/85 → 01/92 | B | HZ | |
| 1.0 Cat. | 33 | 08/89 → 09/94 | B | AAK, AAU, ACM | → 07-1992, → M: 015.867 |
| 1.3 | 57 | 03/91 → 09/94 | B | 3F | → M: 008.526 |

81520 350981520000

VOLKSWAGEN
Polo II, Classic, Coupé, Van

| | | | | | |
|----------|----|---------------|---|-----------------|----------------------------|
| 1.3 Cat. | 40 | 07/87 → 09/94 | B | 2G, AAV, MH, NZ | → M: 200.000 |
| | 40 | 07/87 → 09/94 | B | MH, NZ | → M: 200.000 |
| | 55 | 10/89 → 03/91 | B | 3F | → M: 008.526 |
| 1.3 G40 | 83 | 08/90 → 09/94 | B | PY | → 08-1992, → M: 002.177 |
| | 85 | 01/87 → 08/90 | B | PY | |

81521 350981521000

VOLKSWAGEN
Transporter III

| | | | | | |
|---------------|----|---------------|---|----|-------------------------|
| 1.6 TD | 51 | 08/84 → 07/92 | D | JX | (-)COP, → M: 012.052 |
| 1.6 TD Syncro | 51 | 03/86 → 07/92 | D | JX | (-)COP, → M: 012.052 |

81522 350981522000

AUDI
80 IV

| | | | | | |
|--------|----|---------------|---|--------|--------|
| 1.6 | 51 | 08/87 → 09/91 | B | PP | (-)COP |
| | 55 | 09/86 → 08/91 | B | RN | (-)COP |
| | 75 | 08/90 → 10/91 | B | ABB | (-)COP |
| 1.6 TD | 59 | 09/86 → 08/91 | D | RA, SB | (-)COP |

81522 350981522000

AUDI
80 IV

| | | | | | |
|-------------------|-----|---------------|---|------------|--------|
| 1.8 | 55 | 10/86 → 01/90 | B | RU | (-)COP |
| 1.8 E | 82 | 06/86 → 08/91 | B | DZ | (-)COP |
| 1.8 E quattro | 82 | 09/86 → 08/91 | B | DZ | (-)COP |
| 1.8 quattro | 83 | 09/86 → 08/90 | B | SD | (-)COP |
| 1.8 S | 65 | 08/86 → 01/90 | B | SF | (-)COP |
| | 66 | 09/86 → 10/91 | B | JN, NE, PM | (-)COP |
| 1.8 S quattro | 65 | 09/86 → 07/90 | B | SF | (-)COP |
| | 66 | 09/86 → 09/91 | B | JN, NE, PM | (-)COP |
| 1.9 D | 50 | 08/89 → 08/91 | D | 1Y | (-)COP |
| 2.0 | 82 | 10/90 → 08/91 | B | AAD | (-)COP |
| 2.0 E | 83 | 08/88 → 10/90 | B | 3A | (-)COP |
| 2.0 E 16V | 101 | 03/90 → 09/91 | B | 6A | (-)COP |
| 2.0 E 16V quattro | 101 | 03/90 → 08/91 | B | 6A | (-)COP |
| 2.0 E quattro | 83 | 08/88 → 09/90 | B | 3A | (-)COP |
| 2.0 quattro | 82 | 08/88 → 07/90 | B | 3A | (-)COP |
| | 85 | 10/90 → 08/91 | B | AAD | (-)COP |

80 V, Avant

| | | | | | |
|-------------------|-----|---------------|---|-----|--------|
| 1.6 | 52 | 09/91 → 12/94 | B | ABM | (-)COP |
| 1.6 E | 74 | 06/93 → 12/94 | B | ADA | (-)COP |
| 1.9 TD | 55 | 09/91 → 12/94 | D | AAZ | (-)COP |
| 1.9 TDI | 66 | 09/91 → 12/94 | D | 1Z | (-)COP |
| 2.0 | 66 | 09/91 → 12/94 | B | ABT | (-)COP |
| 2.0 E | 85 | 09/91 → 12/94 | B | ABK | (-)COP |
| 2.0 E 16V | 103 | 08/92 → 12/94 | B | ACE | (-)COP |
| 2.0 E 16V quattro | 103 | 04/92 → 12/94 | B | ACE | (-)COP |
| 2.0 E quattro | 85 | 09/91 → 12/94 | B | ABK | (-)COP |
| 2.0 quattro | 79 | 11/93 → 01/96 | B | ADW | (-)COP |

90 II

| | | | | | |
|-------------|-----|---------------|---|--------|--------|
| 1.6 TD | 59 | 04/87 → 09/91 | D | RA, SB | (-)COP |
| 2.0 quattro | 101 | 08/89 → 07/90 | B | 6A | (-)COP |

100 III, Avant

| | | | | | |
|------------------|----|---------------|---|--------|--------|
| 1.8 | 65 | 02/86 → 07/90 | B | SH | (-)COP |
| 1.8 Cat. | 66 | 03/85 → 11/90 | B | 4B, PH | (-)COP |
| 1.8 quattro | 65 | 08/86 → 07/90 | B | SH | (-)COP |
| 1.8 quattro Cat. | 66 | 08/85 → 11/90 | B | 4B, PH | (-)COP |

100 IV, Avant

| | | | | | |
|-----------|-----|---------------|---|----------|--------|
| 2.0 | 74 | 12/90 → 06/94 | B | AAE | (-)COP |
| 2.0 E | 74 | 09/91 → 06/94 | B | AAE | (-)COP |
| | 85 | 12/90 → 06/94 | B | AAD, ABK | (-)COP |
| 2.0 E 16V | 103 | 01/92 → 06/94 | B | ACE | (-)COP |

81522
350981522000

KW

AUDI
100 IV, Avant

| | | | | | |
|-------------------|-----|---------------|---|-----|--------|
| 2.0 E 16V quattro | 103 | 07/92 → 06/94 | B | ACE | (-)COP |
| 2.0 E quattro | 85 | 12/90 → 07/92 | B | AAD | (-)COP |

A6 I, Avant

| | | | | | |
|-----------------|-----|---------------|---|---------|---------------|
| 1.9 TDI | 66 | 06/94 → 10/97 | D | 1Z, AHU | (-)COP, M: 1Z |
| 2.0 | 74 | 06/94 → 10/97 | B | AAE | (-)COP |
| | 79 | 08/95 → 07/96 | B | ADW | (-)COP |
| | 85 | 06/94 → 10/97 | B | ABK | (-)COP |
| 2.0 16V | 103 | 06/94 → 10/97 | B | ACE | (-)COP |
| 2.0 16V quattro | 103 | 06/94 → 10/97 | B | ACE | (-)COP |

Cabriolet

| | | | | | |
|---------|-----|---------------|---|---------|--------|
| 1.9 TDI | 66 | 06/95 → 08/00 | D | 1Z, AHU | (-)COP |
| 2.0 16V | 103 | 06/95 → 07/96 | B | ACE | (-)COP |
| 2.0 E | 85 | 01/93 → 07/98 | B | ABK | (-)COP |

Coupé II

| | | | | | |
|----------|-----|---------------|---|----------|--------|
| 2.0 | 82 | 03/90 → 07/90 | B | 3A | (-)COP |
| | 83 | 05/89 → 03/90 | B | 3A | (-)COP |
| | 85 | 05/89 → 12/96 | B | AAD, ABK | (-)COP |
| 2.0 16 V | 101 | 01/92 → 07/92 | B | 6A | (-)COP |
| | 103 | 08/92 → 12/96 | B | ACE | (-)COP |

FORD
Galaxy I

| | | | | | |
|---------|----|---------------|---|--------------|-------------------|
| 1.9 TDI | 66 | 03/95 → 05/06 | D | 1Z, AHU, ANU | (-)COP, → 04-2000 |
| | 81 | 08/97 → 04/00 | D | AFN, AVG | (-)COP, → 04-2000 |

SEAT
Alhambra I

| | | | | | |
|---------|----|---------------|---|--------------|---------------------------|
| 1.9 TDI | 66 | 04/96 → 03/10 | D | 1Z, AHU, ANU | (-)COP, → 07-2000 |
| | 81 | 08/96 → 06/00 | D | AFN, AVG | (-)COP |
| 2.0 i | 85 | 04/96 → 03/10 | B | ADY, ATM | (-)COP, → 07-2000, M: ADY |

Cordoba I, Vario

| | | | | | |
|-----------|----|---------------|---|---------------|-------------------|
| 1.6 i | 55 | 05/94 → 06/99 | B | 1F | (-)COP |
| | 74 | 09/96 → 06/99 | B | AFT | (-)COP |
| | 74 | 07/96 → 10/99 | B | AFT, AKL | (-)COP |
| | 55 | 09/96 → 06/99 | B | AEE, ALM | (-)COP |
| 1.8 i | 66 | 02/93 → 06/99 | B | ABS, ACC, ADZ | (-)COP, 10-1993 → |
| 1.8 i 16V | 95 | 10/93 → 08/96 | B | ADL | (-)COP, 10-1993 → |

81522
350981522000

KW

SEAT
Cordoba I, Vario

| | | | | | |
|-----------|-----|---------------|---------------|---------|-------------------|
| 1.9 D | 47 | 01/96 → 08/96 | D | 1Y | (-)COP, 06-1996 → |
| | 50 | 02/93 → 08/96 | D | 1Y | (-)COP, 10-1993 → |
| 1.9 SDI | 47 | 08/96 → 06/99 | D | AEY | (-)COP, 05-1997 → |
| | 47 | 09/96 → 06/99 | D | AEY | (-)COP |
| 1.9 TD | 55 | 02/93 → 08/96 | D | AAZ | (-)COP, 10-1993 → |
| | 66 | 08/96 → 06/99 | D | 1Z, AHU | (-)COP |
| 1.9 TDI | | 66 | 08/96 → 06/99 | D | 1Z, AHU |
| | 81 | 03/97 → 06/99 | D | AFN | (-)COP, 05-1997 → |
| 2.0 i | 81 | 07/97 → 06/99 | D | AFN | (-)COP |
| | 85 | 02/93 → 06/99 | B | 2E, AGG | (-)COP, 10-1993 → |
| 2.0 i 16V | 110 | 08/96 → 06/99 | B | ABF | (-)COP, 02-1997 → |

Ibiza II

| | | | | | |
|-----------|-----|---------------|---|---------------|---------------------------|
| 1.6 i | 55 | 09/94 → 06/99 | B | 1F | (-)COP |
| | 74 | 04/96 → 08/99 | B | AFT | (-)COP |
| | 55 | 03/93 → 08/99 | B | ABU, AEE, ALM | (-)COP, 01-1995 →, M: AEE |
| 1.8 i | 66 | 03/93 → 08/99 | B | ABS, ACC, ADZ | (-)COP, 01-1993 → |
| 1.8 i 16V | 95 | 11/93 → 08/96 | B | ADL | (-)COP |
| 1.9 D | 47 | 04/93 → 08/96 | D | 1Y, AEY | (-)COP |
| | 50 | 10/94 → 08/96 | D | 1Y | (-)COP |
| 1.9 SDI | 47 | 08/96 → 08/99 | D | AEY | (-)COP |
| 1.9 TD | 55 | 03/93 → 08/96 | D | AAZ | (-)COP, 06-1994 → |
| 2.0 i | 85 | 03/93 → 08/99 | B | 2E, AGG | (-)COP |
| 2.0 i 16V | 110 | 08/96 → 08/99 | B | ABF | (-)COP |

Inca

| | | | | | |
|---------|----|---------------|---|--------------|-------------------|
| 1.6 i | 55 | 11/95 → 05/98 | B | 1F | (-)COP, 11-1995 → |
| 1.7 D | 42 | 09/96 → 06/03 | D | AHB | (-)COP |
| 1.9 D | 47 | 11/95 → 06/03 | D | 1Y | (-)COP, 11-1995 → |
| 1.9 SDI | 47 | 11/95 → 06/03 | D | 1Y, AEY, AYQ | (-)COP, 11-1995 → |

81522
350981522000

KW

SEAT
Toledo I

| | | | | | |
|-----------|-----|---------------|---|---------------|-------------------|
| 1.6 i | 52 | 05/91 → 12/93 | B | 1F | (-)COP |
| | 54 | 05/91 → 03/99 | B | 1F, ABN, EZ | (-)COP, 05-1991 → |
| | 55 | 01/93 → 03/99 | B | 1F | (-)COP, 05-1991 → |
| | 74 | 11/96 → 03/99 | B | AFT | (-)COP |
| 1.8 16V | 92 | 05/91 → 03/99 | B | PL | (-)COP, 05-1991 → |
| | 98 | 05/91 → 03/99 | B | KR | (-)COP, 05-1991 → |
| 1.8 GT | 102 | 05/91 → 11/92 | B | KR | (-)COP |
| 1.8 i | 65 | 05/91 → 12/96 | B | RP | (-)COP |
| | 66 | 11/93 → 12/96 | B | ABS, ACC, ADZ | (-)COP |
| 1.9 D | 47 | 12/95 → 03/99 | D | 1Y | (-)COP, 05-1991 → |
| | 50 | 05/91 → 03/99 | D | 1Y | (-)COP, 05-1991 → |
| 1.9 TD | 55 | 05/91 → 03/99 | D | AAZ | (-)COP, 05-1991 → |
| 1.9 TDI | 66 | 08/95 → 03/99 | D | 1Z, AHU | (-)COP, 05-1991 → |
| | 81 | 11/96 → 03/99 | D | AFN | (-)COP, 05-1991 → |
| 2.0 i | 85 | 05/91 → 03/99 | B | 2E, AGG | (-)COP |
| 2.0 i 16V | 110 | 11/93 → 03/99 | B | ABF | (-)COP, 01-1997 → |

VOLKSWAGEN
Caddy I

| | | | | | |
|-------|----|---------------|---|--------|--------|
| 1.6 | 55 | 01/83 → 07/92 | B | EW | (-)COP |
| 1.6 D | 40 | 08/82 → 07/92 | D | JK, ME | (-)COP |
| 1.8 | 70 | 08/85 → 07/92 | B | JH | (-)COP |

Caddy II

| | | | | | |
|---------|----|---------------|---|---------------|----------------|
| 1.6 | 55 | 11/95 → 05/97 | B | 1F | (-)COP |
| 1.7 SDI | 42 | 07/96 → 09/00 | D | AHB | (-)COP |
| 1.9 D | 47 | 11/95 → 01/04 | D | 1Y | (-)COP |
| 1.9 SDI | 47 | 11/95 → 01/04 | D | AEY, AYQ | (-)COP, M: AEY |
| 1.9 TDI | 66 | 09/96 → 01/04 | D | 1Z, AHU, ALH | (-)COP |
| | 66 | 10/96 → 01/04 | D | AHU, ALE, ALH | (-)COP |
| 75 1.6 | 55 | 11/95 → 05/97 | B | 1F | (-)COP |

81522
350981522000

KW

VOLKSWAGEN
Corrado

| | | | | | |
|-----------|-----|---------------|---|---------|--------|
| 1.8 16V | 100 | 04/89 → 07/92 | B | KR | (-)COP |
| 1.8 G60 | 118 | 09/88 → 09/93 | B | PG | (-)COP |
| 2.0 i | 85 | 04/93 → 12/95 | B | 2E, ADY | (-)COP |
| 2.0 i 16V | 100 | 08/91 → 12/95 | B | 9A | (-)COP |

Golf I, Cabrio

| | | | | | |
|-----|----|---------------|---|--------|--------|
| 1.6 | 53 | 04/86 → 02/90 | B | RE | (-)COP |
| | 55 | 08/83 → 04/92 | B | EW, HN | (-)COP |
| 1.8 | 66 | 08/83 → 09/92 | B | EX | (-)COP |
| | 70 | 08/83 → 04/93 | B | JH | (-)COP |
| | 72 | 08/89 → 03/93 | B | 2H | (-)COP |

Golf II

| | | | | | |
|--------------------|-----|---------------|---|----------------|--------|
| 1.6 | 51 | 10/86 → 12/92 | B | PN | (-)COP |
| | 53 | 02/86 → 10/91 | B | RF | (-)COP |
| | 55 | 08/83 → 07/92 | B | ABN, EZ, HM | (-)COP |
| 1.6 D | 37 | 08/83 → 10/91 | D | | (-)COP |
| | 40 | 08/83 → 10/91 | D | JP, ME | (-)COP |
| 1.6 TD | 51 | 08/83 → 10/91 | D | JR, MF | (-)COP |
| | 59 | 04/89 → 10/91 | D | RA, SB | (-)COP |
| | 44 | 08/89 → 10/91 | D | 1V | (-)COP |
| 1.8 | 62 | 08/86 → 01/90 | B | RH | (-)COP |
| | 66 | 08/84 → 10/91 | B | GU, GX, HV | (-)COP |
| 1.8 GTI | 82 | 08/83 → 10/91 | B | DX, EV, GZ, PB | (-)COP |
| 1.8 GTI 16V | 95 | 02/86 → 10/91 | B | PL | (-)COP |
| | 102 | 02/86 → 06/90 | B | KR | (-)COP |
| 1.8 GTI Cat. | 79 | 01/87 → 10/91 | B | PF | (-)COP |
| 1.8 GTI G60 | 118 | 04/90 → 07/91 | B | PG | (-)COP |
| 1.8 GTI G60 Syncro | 118 | 08/88 → 12/91 | B | 1H, PG | (-)COP |
| 1.8 i Cat. | 66 | 08/87 → 10/91 | B | GX, RP | (-)COP |
| 1.8 i Syncro Cat. | 66 | 08/87 → 10/91 | B | RP | (-)COP |
| 1.8 Syncro | 66 | 02/86 → 07/91 | B | GU, GX | (-)COP |
| | 72 | 08/88 → 07/91 | B | 1P | (-)COP |
| 2.0 | 57 | 08/85 → 07/92 | B | | (-)COP |

Golf III, Variant, Cabrio

| | | | | | |
|-----|----|---------------|---|---------------|-------------------|
| 1.6 | 74 | 10/94 → 05/98 | B | AEK, AFT, AKS | (-)COP, 05-1996 → |
| | 74 | 07/95 → 08/97 | B | AEK, AFT, AKS | (-)COP |

81522
350981522000

KW

VOLKSWAGEN
Golf III, Variant, Cabrio

| | | | | | |
|----------------|-----|---------------|---|------------------------|-------------------|
| 1.8 | 55 | 11/91 → 08/97 | B | AAM | (-)COP |
| | 55 | 07/93 → 04/99 | B | AAM, ANN | (-)COP |
| | 66 | 11/91 → 08/97 | B | ABS, ACC, ADZ | (-)COP |
| | 66 | 07/93 → 05/98 | B | ABS, ADZ | (-)COP |
| | 66 | 07/93 → 04/99 | B | ABS, ADZ, ANP | (-)COP |
| 1.8 Syncro | 66 | 10/94 → 04/99 | B | ADZ | (-)COP |
| | 66 | 01/93 → 08/97 | B | ABS, ADZ | (-)COP |
| 1.9 D | 48 | 11/91 → 08/97 | D | 1Y | (-)COP, → 07-1995 |
| 1.9 SDI | 47 | 07/95 → 08/97 | D | AEY | (-)COP |
| 1.9 TD | 55 | 07/93 → 04/99 | D | AAZ | (-)COP, → 07-1995 |
| 1.9 TD, GTD | 55 | 11/91 → 08/97 | D | AAZ | (-)COP, → 07-1995 |
| 1.9 TDI | 66 | 09/93 → 08/97 | D | 1Z, AHU, ALE | (-)COP, → 07-1995 |
| | 66 | 08/95 → 05/98 | D | 1Z, AHU, ALE | (-)COP, M: 1Z |
| | 81 | 04/96 → 08/97 | D | AFN | (-)COP |
| 1.9 TDI Syncro | 66 | 07/95 → 04/99 | D | 1Z, AHU, ALE | (-)COP, → 07-1995 |
| 2.0 | 85 | 11/91 → 08/97 | B | 2E, ABA, ADY, AGG, AKR | (-)COP |
| | 85 | 07/93 → 05/98 | B | 2E, ADY, AGG, AKR | (-)COP, 08-1991 → |
| 2.0 GTI 16V | 110 | 08/92 → 08/97 | B | ABF | (-)COP, 08-1991 → |
| 2.0 Syncro | 85 | 08/95 → 04/99 | B | AGG | (-)COP, 08-1991 → |
| | 85 | 08/95 → 08/97 | B | AGG | (-)COP, 08-1991 → |

Golf IV, Variant, Cabrio

| | | | | | |
|---------|----|---------------|---|----------|-------------------|
| 1.6 | 74 | 06/98 → 06/02 | B | AFT, AKS | (-)COP, 05-1996 → |
| 1.8 | 55 | 06/98 → 06/02 | B | AAM, ANN | (-)COP, 11-1991 → |
| | 66 | 06/98 → 06/02 | B | ADZ, ANP | (-)COP, 11-1991 → |
| 1.9 TDI | 66 | 06/98 → 06/02 | D | AHU, ALE | (-)COP |
| | 81 | 06/98 → 06/02 | D | AFN, AVG | (-)COP |

81522
350981522000

KW

VOLKSWAGEN
Golf IV, Variant, Cabrio

| | | | | | |
|-----------------|----|---------------|---|-------------------------|-------------------|
| 2.0 | 85 | 06/98 → 06/02 | B | AGG, AKR, ATU, AWF, AWG | (-)COP, 08-1991 → |
| Jetta II | | | | | |
| 1.6 | 51 | 10/86 → 10/91 | B | PN | (-)COP |
| | 53 | 03/86 → 10/91 | B | RF | (-)COP |
| | 55 | 01/84 → 07/92 | B | ABN, EZ, HM | (-)COP |
| 1.6 D | 40 | 01/84 → 10/91 | D | JP, ME | (-)COP |
| 1.6 TD | 51 | 01/84 → 10/91 | D | JR, MF | (-)COP |
| | 59 | 04/89 → 10/91 | D | RA, SB | (-)COP |
| | 44 | 01/90 → 10/91 | D | 1V | (-)COP |
| 1.8 | 62 | 08/86 → 01/90 | B | RH | (-)COP |
| | 66 | 08/84 → 10/91 | B | GU, GX, HV | (-)COP |
| | 82 | 01/84 → 10/91 | B | EV, GZ, PB | (-)COP |
| 1.8 16V | 95 | 08/86 → 10/91 | B | PL | (-)COP |
| 1.8 Cat. | 66 | 08/87 → 10/91 | B | GX, RP | (-)COP |
| | 79 | 01/87 → 10/91 | B | PF | (-)COP |
| 1.8 Syncro | 72 | 08/88 → 07/91 | B | 1P | (-)COP |

Passat III, Variant

| | | | | | |
|----------------|-----|---------------|---|-------------------|--------|
| 1.6 | 53 | 02/88 → 09/91 | B | 1F, EZ | (-)COP |
| | 74 | 10/94 → 08/96 | B | AEK, AFT | (-)COP |
| 1.6 TD | 59 | 08/88 → 09/93 | D | RA, SB | (-)COP |
| 1.8 | 55 | 08/90 → 08/96 | B | AAM | (-)COP |
| | 66 | 02/88 → 08/96 | B | ABS, ADZ, RP | (-)COP |
| | 79 | 04/88 → 07/93 | B | PF | (-)COP |
| | 82 | 04/88 → 07/92 | B | PB | (-)COP |
| | 102 | 08/91 → 09/93 | B | KR | (-)COP |
| 1.8 G60 Syncro | 118 | 08/88 → 08/96 | B | PG | (-)COP |
| 1.8 GL | 102 | 08/91 → 09/93 | B | KR | (-)COP |
| 1.9 D | 50 | 05/89 → 10/93 | D | 1Y | (-)COP |
| 1.9 TD | 55 | 03/91 → 08/96 | D | AAZ | (-)COP |
| 1.9 TDI | 66 | 10/93 → 08/96 | D | 1Z, AHU | (-)COP |
| | 81 | 03/96 → 08/96 | D | AFN | (-)COP |
| 2.0 | 79 | 03/95 → 08/96 | B | AEP | (-)COP |
| | 85 | 02/90 → 10/96 | B | 2E, ABA, ADY, AGG | (-)COP |
| | 85 | 02/90 → 05/97 | B | 2E, ADY, AGG | (-)COP |
| | 125 | 04/88 → 07/91 | B | | (-)COP |
| 2.0 16V | 100 | 08/88 → 09/93 | B | 9A | (-)COP |
| | 110 | 01/94 → 08/96 | B | ABF | (-)COP |

81522 350981522000

VOLKSWAGEN
Passat III, Variant

| | | | | | |
|------------|----|---------------|---|--------------|--------|
| 2.0 Syncro | 81 | 09/89 → 07/92 | B | | (-)COP |
| | 85 | 10/90 → 08/96 | B | 2E, ADY, AGG | (-)COP |

Polo III (6N1), Classic, Variant, Van

| | | | | | |
|-------------|----|---------------|---|-------------------------|----------------|
| 1.6 | 74 | 05/97 → 09/01 | B | AEH, AFT, AKL, APF, AUR | (-)COP, M: AFT |
| 1.7 SDI | 42 | 08/97 → 09/01 | D | AKW | (-)COP |
| 1.8 | 66 | 05/97 → 09/01 | B | ADZ | (-)COP |
| 1.9 SDI | 47 | 06/97 → 09/01 | D | AEY | (-)COP |
| 1.9 TDI | 66 | 05/97 → 09/01 | D | AGR, AHU, ALE, ALH | (-)COP, M: ALE |
| 100 1.6 | 74 | 12/95 → 09/01 | B | AEH, AFT, AKL, APF, AUR | (-)COP, M: AFT |
| 110 1.9 TDI | 81 | 06/98 → 01/02 | D | AFN, ASV | (-)COP |
| 57 1.7 SDI | 42 | 07/97 → 09/01 | D | AKW | (-)COP |
| 64 1.9 D | 47 | 01/96 → 10/96 | D | 1Y | (-)COP |
| 64 1.9 SDI | 47 | 12/95 → 08/99 | D | 1Y, AEY | (-)COP |
| 75 1.6 | 55 | 11/95 → 09/97 | B | 1F | (-)COP |
| 90 1.8 | 66 | 01/97 → 09/01 | B | ABS, ADD, ADZ | (-)COP |
| 90 1.9 TDI | 66 | 09/96 → 09/01 | D | AGR, AHU, ALE, ALH | (-)COP, M: ALE |

Scirocco II

| | | | | | |
|---------|----|---------------|---|----|--------|
| 1.6 | 53 | 04/86 → 07/90 | B | RE | (-)COP |
| 1.8 | 66 | 08/83 → 07/92 | B | EX | (-)COP |
| | 70 | 11/85 → 07/92 | B | JH | (-)COP |
| 1.8 16V | 95 | 03/86 → 07/92 | B | PL | (-)COP |

Sharan I

| | | | | | |
|---------|----|---------------|---|--------------|---|
| 1.9 TDI | 66 | 09/95 → 03/10 | D | 1Z, AHU, ANU | (-)COP, 09-1995 →, → 03-2000, M: AHU, M: 1Z |
| | 81 | 09/96 → 04/00 | D | AFN, AVG | (-)COP |
| 2.0 | 85 | 09/95 → 03/10 | B | ADY, ATM | (-)COP, 09-1995 →, → 02-2000, M: ADY |

Transporter III

| | | | | | |
|---------------|----|---------------|---|----|----------------------|
| 1.6 TD | 51 | 08/84 → 07/92 | D | JX | (-)COP, M →: 012.053 |
| 1.6 TD Syncro | 51 | 03/86 → 07/92 | D | JX | (-)COP, M →: 012.053 |
| 1.7 D | 42 | 10/86 → 07/92 | D | KY | (-)COP |

81522 350981522000

VOLKSWAGEN
Transporter IV

| | | | | | |
|--------|----|---------------|---|-----|-------------------|
| 1.8 | 49 | 12/90 → 07/92 | B | PD | (-)COP |
| 1.9 D | 44 | 09/90 → 12/95 | D | 1X | (-)COP |
| | 45 | 07/90 → 12/95 | D | 1X | (-)COP |
| 1.9 TD | 50 | 10/92 → 04/03 | D | ABL | (-)COP |
| 2.0 | 62 | 07/90 → 04/03 | B | AAC | (-)COP, 09-1990 → |
| | 62 | 09/90 → 04/03 | B | AAC | (-)COP |

Vento

| | | | | | |
|---------|----|---------------|---|-------------------|--------|
| 1.6 | 74 | 10/94 → 09/98 | B | AEK, AFT | (-)COP |
| 1.8 | 55 | 11/91 → 09/98 | B | AAM | (-)COP |
| | 66 | 11/91 → 09/98 | B | ABS, ADZ | (-)COP |
| 1.9 D | 48 | 11/91 → 09/98 | D | 1Y | (-)COP |
| 1.9 SDI | 47 | 04/97 → 09/98 | D | AEY | (-)COP |
| 1.9 TD | 55 | 11/91 → 09/98 | D | AAZ | (-)COP |
| 1.9 TDI | 66 | 09/93 → 09/98 | D | 1Z, AHU, ALE | (-)COP |
| | 81 | 04/96 → 09/98 | D | AFN | (-)COP |
| 2.0 | 85 | 11/91 → 09/98 | B | 2E, ADY, AGG, AKR | (-)COP |
| 2.0 GL | 62 | 11/91 → 07/98 | B | AAC | (-)COP |
| | 79 | 05/96 → 12/97 | B | AEP | (-)COP |

81524 350981524000

| | | |
|-------------------|----------------------------|------|
| | PULEGGIA | |
| | Diametro Puleggia | Ø75 |
| | Numero Denti/Gole Puleggia | 30 |
| | Altezza Puleggia | 21 |
| | Posizione Attacco | 53.4 |
| | Diametro Girante | Ø60 |
| | N° Alette Girante | 8 |
| Posizione Girante | 31.5 | |

SEAT
Cordoba I, Vario

| | | | | | |
|-------|----|---------------|---|--------------------|-----------|
| 1.4 i | 44 | 06/94 → 06/99 | B | ABD, AEX, AKV, APQ | → 05-1996 |
| 1.6 i | 55 | 02/93 → 06/99 | B | ABU, AEE, ALM | |

Ibiza II

| | | | | | |
|-------|----|---------------|---|--------------------|-------------------|
| 1.0 | 33 | 03/93 → 09/96 | B | AAU | |
| 1.3 i | 40 | 03/93 → 08/99 | B | 2G, AAV | |
| 1.4 i | 44 | 09/93 → 08/99 | B | ABD, AEX, AKV, APQ | → 07-1996, M: ABD |

81524
350981524000

KW

SEAT
Ibiza II

| | | | | | |
|-------|----|---------------|---|---------------|-------------------|
| 1.6 i | 55 | 03/93 → 08/99 | B | ABU, AEE, ALM | → 12-1994, M: ABU |
|-------|----|---------------|---|---------------|-------------------|

VOLKSWAGEN
Golf II

| | | | | | |
|----------|----|---------------|---|------------|---------------|
| 1.0 | 37 | 08/85 → 10/91 | B | HZ | M → : 786.023 |
| 1.3 Cat. | 40 | 06/86 → 12/92 | B | 2G, MH, NZ | M → : 262.740 |

Golf III, Variant, Cabrio

| | | | | | |
|-----|----|---------------|---|---------------|-------------------------------|
| 1.3 | 40 | 08/91 → 07/92 | B | 2G | |
| 1.4 | 40 | 07/93 → 04/99 | B | ABD | → 07-1995 |
| | 40 | 11/91 → 08/97 | B | ABD, AEX | 11-1991 → , → 07-1995, M: ABD |
| | 44 | 10/91 → 08/97 | B | ABD, AEX | → 07-1995, M: ABD |
| | 44 | 07/93 → 04/99 | B | ABD, AEX, APQ | → 07-1995 |
| 1.6 | 55 | 09/92 → 08/97 | B | ABU, AEA, AEE | → 07-1995, M: ABU |

Polo II, Classic, Coupé, Van

| | | | | | |
|----------|----|---------------|---|-----------------|---------------------------|
| 1.0 | 33 | 01/85 → 09/94 | B | AAK, AAU, HZ | 08-1992 → , M → : 015.868 |
| | 33 | 08/92 → 07/94 | B | AAU | |
| 1.0 Cat. | 33 | 08/89 → 09/94 | B | AAK, AAU, ACM | 08-1992 → , M → : 015.868 |
| 1.3 | 40 | 08/92 → 07/94 | B | AAV | |
| | 57 | 03/91 → 09/94 | B | 3F | M → : 008.527 |
| 1.3 Cat. | 40 | 07/87 → 09/94 | B | 2G, AAV, MH, NZ | M → : 200.001 |
| | 40 | 07/87 → 09/94 | B | MH, NZ | M → : 200.001 |
| | 55 | 10/89 → 03/91 | B | 3F | M → : 008.527 |
| 1.3 G40 | 83 | 08/90 → 09/94 | B | PY | 09-1992 → , M → : 002.178 |

Polo III (6N1), Classic, Variant, Van

| | | | | | |
|-----|----|---------------|---|-----|--|
| 1.0 | 33 | 10/94 → 12/99 | B | AEV | |
|-----|----|---------------|---|-----|--|

Vento

| | | | | | |
|-----|----|---------------|---|---------------|--------|
| 1.4 | 40 | 11/91 → 09/98 | B | ABD, AEX | M: ABD |
| | 44 | 11/91 → 09/98 | B | ABD, AEX | M: ABD |
| 1.6 | 55 | 09/92 → 09/98 | B | ABU, AEA, AEE | M: ABU |

81525
350981525000

PULEGGIA

| | |
|----------------------------|-------|
| Diametro Puleggia | Ø53.3 |
| Numero Denti/Gole Puleggia | 18 |
| Altezza Puleggia | 22 |
| Posizione Attacco | 53.5 |
| Diametro Girante | Ø60 |
| N° Alette Girante | 8 |
| Posizione Girante | 31.5 |

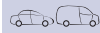
KW

SEAT
Terra

| | | | | | |
|-------|----|---------------|---|----|--|
| 1.3 D | 33 | 03/90 → 12/94 | D | MN | |
| 1.4 D | 35 | 10/90 → 12/95 | D | 1W | |

VOLKSWAGEN
Polo II, Classic, Coupé, Van

| | | | | | |
|-------|----|---------------|---|----|--|
| 1.3 D | 33 | 08/86 → 07/90 | D | MN | |
| 1.4 D | 35 | 10/90 → 09/94 | D | 1W | |

81526
350981526000

FLANGIA

| | |
|-------------------------|---------|
| Numero Fori Flangia | 3 |
| Dimensione Fori Flangia | M8×1.25 |
| Posizione Attacco | 74 |
| Diametro Mozzo | Ø30 |
| Diametro Girante | Ø64 |
| N° Alette Girante | 7 |
| Posizione Girante | 29.5 |

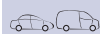
KW

AUDI
A4 I, Avant

| | | | | | |
|-------------|----|---------------|---|--------------------|-------------------------------|
| 1.6 | 74 | 11/94 → 09/01 | B | ADP, AHL, ANA, ARM | (-)COP, 03-1996 → , → 12-1997 |
| | 74 | 11/94 → 10/00 | B | ADP, AHL, ANA, ARM | (-)COP, 01-1995 → , → 12-1997 |
| 1.8 | 85 | 04/95 → 11/00 | B | AFY | (-)COP |
| | 92 | 01/95 → 11/00 | B | ADR, APT, ARG, AVV | (-)COP |
| | 95 | 01/95 → 11/00 | B | ADR | (-)COP |
| 1.8 quattro | 85 | 07/95 → 11/00 | B | AFY | (-)COP |
| | 92 | 01/95 → 11/00 | B | ADR, APT, ARG | (-)COP |

81526
350981526000

KW

AUDI
A4 I, Avant

| | | | | | |
|-------|-----|---------------|---|-------------------------|--------|
| 1.8 T | 110 | 01/95 → 11/00 | B | AEB, ANB, APU, ARK, AWT | (-)COP |
| | 132 | 12/97 → 11/00 | B | AJL | (-)COP |

| | | | | | |
|---------------|-----|---------------|---|-------------------------|--------|
| 1.8 T quattro | 110 | 01/95 → 11/00 | B | AEB, ANB, APU, ARK, AWT | (-)COP |
| | 132 | 12/97 → 11/00 | B | AJL | (-)COP |

A6 I, Avant

| | | | | | |
|-------------|----|---------------|---|-----|--------|
| 1.8 | 92 | 12/95 → 10/97 | B | ADR | (-)COP |
| 1.8 quattro | 92 | 12/95 → 10/97 | B | ADR | (-)COP |

A6 II, Avant

| | | | | | |
|---------------|-----|---------------|---|------------------------------|-----------------------|
| 1.8 | 85 | 05/97 → 01/05 | B | AFY | (-)COP |
| 1.8 T | 110 | 01/97 → 01/05 | B | AEB, ANB, APU, ARK, AWL, AWT | (-)COP, NOT FOR: MAWT |
| | 110 | 12/97 → 01/05 | B | AEB, ANB, APU, ARK, AWT | (-)COP, NOT FOR: MAWT |
| | 132 | 12/97 → 01/05 | B | AJL | (-)COP |
| 1.8 T quattro | 110 | 02/97 → 01/05 | B | AEB, ANB, APU, ARK, AWT | (-)COP, NOT FOR: MAWT |
| | 132 | 12/97 → 01/05 | B | AJL | (-)COP |

Cabriolet

| | | | | | |
|-----|----|---------------|---|-----|--------|
| 1.8 | 92 | 01/97 → 08/00 | B | ADR | (-)COP |
|-----|----|---------------|---|-----|--------|

VOLKSWAGEN
Passat IV, Variant

| | | | | | |
|--------------------|-----|---------------|---|--------------------|--------------------------------|
| 1.6 | 74 | 10/96 → 11/00 | B | ADP, AHL, ANA, ARM | (-)COP, → 12-1997, M: ADP |
| 1.8 | 85 | 01/97 → 11/00 | B | AFY | (-)COP |
| | 92 | 10/96 → 11/00 | B | ADR, APT, ARG | (-)COP |
| 1.8 Syncro/4motion | 92 | 10/96 → 11/00 | B | ADR, APT, ARG | (-)COP |
| 1.8 T | 110 | 10/96 → 11/00 | B | AEB, ANB, APU | (-)COP, M: ANB, M: AEB, M: ANB |
| 1.8 T Syncro | 110 | 11/96 → 08/00 | B | AEB | (-)COP |

Passat V, Variant

| | | | | | |
|-----|----|---------------|---|-----|--------|
| 1.8 | 92 | 03/03 → 03/05 | B | APT | (-)COP |
|-----|----|---------------|---|-----|--------|

81527
350981527000

PULEGGIA

| | |
|----------------------------|--------|
| Diametro Puleggia | Ø67.24 |
| Numero Denti/Gole Puleggia | 27 |
| Altezza Puleggia | 20.7 |
| Posizione Attacco | 51.7 |
| Diametro Girante | Ø63.6 |
| N° Alette Girante | 8 |
| Posizione Girante | 40.5 |

KW

SEAT
Arosa

| | | | | | |
|-----|----|---------------|---|------------------------------|-----------|
| 1.4 | 44 | 05/97 → 06/04 | B | AEX, AKK, AKV, ANW, APQ, AUD | → 11-1999 |
|-----|----|---------------|---|------------------------------|-----------|

Cordoba I, Vario

| | | | | | |
|-------|----|---------------|---|--------------------|-----------|
| 1.4 i | 44 | 06/94 → 06/99 | B | ABD, AEX, AKV, APQ | 06-1996 → |
| | 44 | 09/96 → 06/99 | B | AEX, AKV, APQ | 05-1997 → |

Cordoba II, Vario

| | | | | | |
|-----|----|---------------|---|----------|--|
| 1.6 | 55 | 06/99 → 12/02 | B | ABU, ALM | |
| | 55 | 06/99 → 10/02 | B | ALM | |

Cordoba III, Vario

| | | | | | |
|-----|----|---------------|---|-----|--|
| 1.6 | 74 | 04/03 → 11/09 | B | BAH | |
|-----|----|---------------|---|-----|--|

Ibiza II

| | | | | | |
|-----------|----|---------------|---|--------------------|-------------------|
| 1.4 | 40 | 12/97 → 04/99 | B | ANX | |
| 1.4 i | 44 | 09/93 → 08/99 | B | ABD, AEX, AKV, APQ | 08-1996 →, M: AEX |
| 1.4 i 16V | 74 | 06/97 → 08/99 | B | AFH | |

Ibiza III

| | | | | | |
|-----|----|---------------|---|-----|--|
| 1.6 | 55 | 08/99 → 02/02 | B | ALM | |
|-----|----|---------------|---|-----|--|

Ibiza IV

| | | | | | |
|-----|----|---------------|---|-----|--|
| 1.6 | 74 | 02/03 → 11/09 | B | BAH | |
|-----|----|---------------|---|-----|--|

Inca

| | | | | | |
|-------|----|---------------|---|--------------------|-----------|
| 1.4 i | 44 | 11/95 → 06/03 | B | AEX, AKV, APQ, AUD | 01-1998 → |
| 1.6 i | 55 | 06/97 → 09/00 | B | AEE, ALM | |

SKODA
Felicia I, Station Wagon

| | | | | | |
|---------|----|---------------|---|------------|--|
| 1.6 | 55 | 06/97 → 04/02 | B | AEE | |
| 1.6 GLX | 55 | 08/95 → 03/98 | B | AEE | |
| 1.6 LX | 55 | 08/95 → 03/98 | B | AEE, EA111 | |

Felicia II, Station Wagon

| | | | | | |
|-----|----|---------------|---|-----|--|
| 1.6 | 55 | 01/98 → 06/01 | B | AEE | |
|-----|----|---------------|---|-----|--|

Octavia I, Station Wagon

| | | | | | |
|-----|----|---------------|---|-----|--|
| 1.6 | 55 | 09/96 → 09/04 | B | AEE | |
|-----|----|---------------|---|-----|--|

81527
350981527000

KW

VOLKSWAGEN
Caddy II

| | | | | | |
|--------|----|---------------|---|--------------------|--|
| 1.4 | 44 | 11/95 → 01/04 | B | AEX, AKV, APQ, AUD | |
| 1.6 | 55 | 06/96 → 12/00 | B | AEE | |
| 60 1.4 | 44 | 11/95 → 01/04 | B | AEX, APQ, AUD | |
| 75 1.6 | 55 | 11/95 → 09/00 | B | AEE | |

Fox I

| | | | | | |
|----------------|----|---------|---|--------------------------------|--|
| 1.4 | 55 | 04/05 → | B | BKR | |
| 1.6 | 74 | 10/03 → | B | BAH, BJA, BLH, BPA, CCRA, CFZA | |
| 1.6 Total Flex | 74 | 10/03 → | | BJA, BPA, CCRA | |

Golf III, Variant, Cabrio

| | | | | | |
|-----|----|---------------|---|---------------|-----------------------------------|
| 1.4 | 40 | 07/93 → 04/99 | B | ABD | 08-1995 → |
| | 40 | 11/91 → 08/97 | B | ABD, AEX | 08-1995 →, M: AEX |
| | 44 | 10/91 → 08/97 | B | ABD, AEX | 08-1995 →, M: AEX |
| | 44 | 07/93 → 04/99 | B | ABD, AEX, APQ | 08-1995 → |
| 1.6 | 55 | 09/92 → 08/97 | B | ABU, AEA, AEE | 05-1996 →, M: AEE, M: AEA, M: AEE |

Polo III (6N1), Classic, Variant, Van

| | | | | | |
|--------|----|---------------|---|------------------------------|--|
| 1.4 | 44 | 05/97 → 09/01 | B | AEX, AKK, AKV, ANW, APQ, AUD | M: AEX, M: ANX, M: AKV, M: AEX, M: APQ, M: ANX |
| | 44 | 05/98 → 12/99 | B | AEX, APQ | |
| 1.6 | 55 | 05/97 → 09/01 | B | AEE, ALM | |
| 45 1.0 | 33 | 10/94 → 09/96 | B | AEV | |
| 54 1.4 | 40 | 01/98 → 08/99 | B | ANX | |
| 55 1.3 | 40 | 10/94 → 07/95 | B | ADX | |
| 55 1.4 | 40 | 08/95 → 10/99 | B | AEX | |
| 60 1.4 | 44 | 12/95 → 09/01 | B | AEX, AKK, AKV, ANW, APQ, AUD | M: APQ, M: AKV, M: ANX, M: APQ, M: AEX, M: AKV |
| | 44 | 07/95 → 10/99 | B | AEX, AKV, APQ | |
| 75 1.6 | 55 | 10/94 → 10/99 | B | AEA, AEE, AHS | |
| | 55 | 11/95 → 09/01 | B | AEE, ALM | |

81527
350981527000

KW

VOLKSWAGEN
Polo V (9N)

| | | | | | |
|-----|----|---------------|---|----------------|--|
| 1.6 | 74 | 08/02 → 05/05 | B | BAH | |
| | 74 | 09/02 → | B | BAH, BPA, CFZA | |

Vento

| | | | | | |
|-----|----|---------------|---|---------------|----------------|
| 1.4 | 40 | 11/91 → 09/98 | B | ABD, AEX | M: AEX |
| | 44 | 11/91 → 09/98 | B | ABD, AEX | M: AEX |
| 1.6 | 55 | 09/92 → 09/98 | B | ABU, AEA, AEE | M: AEE, M: AEA |

81528
350981528000

FLANGIA

| | |
|-------------------------|---------|
| Numero Fori Flangia | 3 |
| Dimensione Fori Flangia | M8x1.25 |
| Posizione Attacco | 74.4 |
| Diametro Mozzo | Ø30 |
| Diametro Girante | Ø62 |
| N° Alette Girante | 6 |
| Posizione Girante | 25.8 |

KW

AUDI
A4 I, Avant

| | | | | | |
|-----------------|----|---------------|---|--------------|----------------|
| 1.9 DUO | 66 | 03/98 → 09/01 | | AHU | M: AHU, M: AHH |
| | 55 | 12/95 → 11/00 | D | AFF | |
| 1.9 TDI | 66 | 01/95 → 11/00 | D | 1Z, AHH, AHU | |
| | 81 | 10/95 → 11/00 | D | AFN, AVG | |
| 1.9 TDI quattro | 81 | 09/96 → 11/00 | D | AFN, AVG | |

A6 I, Avant

| | | | | | |
|---------|----|---------------|---|---------|--------|
| 1.9 TDI | 66 | 06/94 → 10/97 | D | 1Z, AHU | M: AHU |
|---------|----|---------------|---|---------|--------|

A6 II, Avant

| | | | | | |
|---------|----|---------------|---|----------|--|
| 1.9 TDI | 81 | 04/97 → 10/00 | D | AFN, AVG | |
|---------|----|---------------|---|----------|--|

SEAT
Arosa

| | | | | | |
|---------|----|---------------|---|-----|--|
| 1.7 SDI | 44 | 08/97 → 06/04 | D | AKU | |
|---------|----|---------------|---|-----|--|

Ibiza II

| | | | | | |
|---------|----|---------------|---|---------|--|
| 1.9 TDI | 66 | 08/96 → 08/99 | D | 1Z, AHU | |
| | 81 | 02/97 → 08/99 | D | AFN | |

81528 350981528000

SKODA
Felicia I, Station Wagon

1.9 D 47 10/95 → 03/98 D AEF

Felicia II, Station Wagon

1.9 D 47 01/98 → 06/01 D AEF

VOLKSWAGEN
Caddy II

1.9 D 47 06/96 → 12/00 D AEF

Golf III, Variant, Cabrio

1.9 D 48 11/91 → 08/97 D 1Y 08-1995 →

 1.9 D 48 07/93 → 04/99 D 1Y 08-1995 →,
→ 04-1996

1.9 SDI 47 07/95 → 04/99 D AEY

 1.9 TD 55 07/93 → 04/99 D AAZ 08-1995 →,
→ 12-1997

1.9 TD,GTD 55 11/91 → 08/97 D AAZ 08-1995 →

1.9 TDI 66 09/93 → 08/97 D 1Z,AHU,ALE 08-1995 →

 1.9 TDI 66 03/94 → 04/99 D 1Z,AHU,ALE 07-1995 →,
→ 12-1997,
M: AHU

1.9 TDI 66 08/95 → 05/98 D 1Z,AHU,ALE M: AHU

1.9 TDI 66 07/95 → 04/99 D 1Z,AHU,ALE 08-1995 →

Syncro 66 08/95 → 08/97 D 1Z,AHU,ALE

Lupo I

1.7 SDI 44 09/98 → 07/05 D AKU 11-1998 →

Passat IV, Variant

1.9 TDI 66 10/96 → 11/00 D AHH, AHU

81 10/96 → 11/00 D AFN, AVG

1.9 TDI 81 10/96 → 11/00 D AFN, AVG

 Syncro/
4motion

Polo III (6N1), Classic, Variant, Van

1.7 SDI 42 04/97 → 10/99 D AHG

44 08/97 → 12/99 D AKU

1.9 D 47 10/94 → 12/99 D AEF

1.9 SDI 47 07/96 → 12/99 D AGD

 1.9 TDI 66 05/97 → 09/01 D AGR, AHU,
ALE, ALH M: AHU

81 06/98 → 09/01 D AFN, ASV M: AFN

60 1.7 SDI 44 08/97 → 10/99 D AKU

64 1.9 D 47 10/94 → 10/99 D AEF

64 1.9 SDI 47 07/96 → 10/99 D AGD

 90 1.9 TDI 66 09/96 → 09/01 D AGR, AHU,
ALE, ALH M: AHU

81528 350981528000

VOLKSWAGEN
Polo IV (6N2)

1.7 SDI 44 10/99 → 09/01 D AKU

1.9 D 47 10/99 → 09/01 D AEF

1.9 SDI 47 10/99 → 09/01 D AGD, ASX

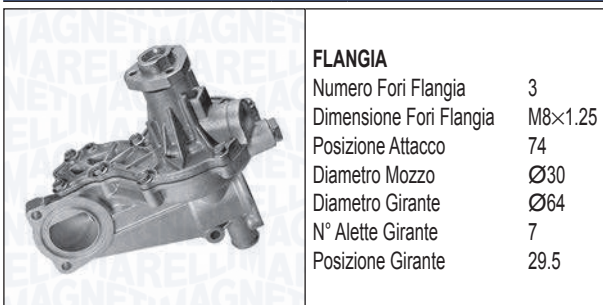
81529 350981529000

FLANGIA

| | |
|-------------------------|---------|
| Numero Fori Flangia | 3 |
| Dimensione Fori Flangia | M8×1.25 |
| Posizione Attacco | 74 |
| Diametro Mozzo | Ø30 |
| Diametro Girante | Ø64 |
| N° Alette Girante | 7 |
| Posizione Girante | 29.5 |

AUDI
A4 I, Avant

| | | | | | |
|-----|----|---------------|---|-----------------------|------------------------------------|
| 1.6 | 74 | 11/94 → 09/01 | B | ADP, AHL, ANA, ARM | (+)COP, 03-1996 →, → 12-1997 |
| | 74 | 11/94 → 10/00 | B | ADP, AHL, ANA, ARM | (+)COP, 01-1995 →, → 12-1997 |

| | | | | | |
|-----|----|---------------|---|-----------------------|--------|
| 1.8 | 85 | 04/95 → 11/00 | B | AFY | (+)COP |
| | 92 | 01/95 → 11/00 | B | ADR, APT, ARG, AVV | (+)COP |

| | | | | | |
|-------------|----|---------------|---|-----|--------|
| 1.8 quattro | 95 | 01/95 → 11/00 | B | ADR | (+)COP |
| | 85 | 07/95 → 11/00 | B | AFY | (+)COP |

| | | | | | |
|-------|-----|---------------|---|-------------------------------|--------|
| 1.8 T | 92 | 01/95 → 11/00 | B | ADR, APT, ARG | (+)COP |
| | 110 | 01/95 → 11/00 | B | AEB, ANB, APU, ARK, AWT | (+)COP |

| | | | | | |
|---------------|-----|---------------|---|-------------------------------|--------|
| 1.8 T quattro | 132 | 12/97 → 11/00 | B | AJL | (+)COP |
| | 110 | 01/95 → 11/00 | B | AEB, ANB, APU, ARK, AWT | (+)COP |

| | | | | | |
|---------------|-----|---------------|---|-------------------------------|--------|
| 1.8 T quattro | 132 | 12/97 → 11/00 | B | AJL | (+)COP |
| | 110 | 01/95 → 11/00 | B | AEB, ANB, APU, ARK, AWT | (+)COP |

| | | | | | |
|---------------|-----|---------------|---|-------------------------------|--------|
| 1.8 T quattro | 132 | 12/97 → 11/00 | B | AJL | (+)COP |
| | 110 | 01/95 → 11/00 | B | AEB, ANB, APU, ARK, AWT | (+)COP |

A6 I, Avant

| | | | | | |
|-----|----|---------------|---|-----|--------|
| 1.8 | 92 | 12/95 → 10/97 | B | ADR | (+)COP |
|-----|----|---------------|---|-----|--------|

| | | | | | |
|-------------|----|---------------|---|-----|--------|
| 1.8 quattro | 92 | 12/95 → 10/97 | B | ADR | (+)COP |
|-------------|----|---------------|---|-----|--------|

81529
350981529000

AUDI
A6 I, Avant

| | | | | | |
|-----|-----|---------------|---|-----|--|
| 2.6 | 102 | 06/94 → 02/97 | B | ACZ | (+)COP, 08-1996 →, → 02-1997, T →: F44-S-026.715 |
|-----|-----|---------------|---|-----|--|

A6 II, Avant

| | | | | | |
|-----|----|---------------|---|-----|--------|
| 1.8 | 85 | 05/97 → 01/05 | B | AFY | (+)COP |
|-----|----|---------------|---|-----|--------|

| | | | | | |
|-------|-----|---------------|---|------------------------------------|---------------------------|
| 1.8 T | 110 | 01/97 → 01/05 | B | AEB, ANB, APU, ARK, AWL, AWT | (+)COP, NOT FOR: M AWT |
| | 110 | 12/97 → 01/05 | B | AEB, ANB, APU, ARK, AWT | (+)COP, NOT FOR: M AWT |

| | | | | | |
|---------------|-----|---------------|---|-------------------------------|---------------------------|
| 1.8 T quattro | 132 | 12/97 → 01/05 | B | AJL | (+)COP |
| | 110 | 02/97 → 01/05 | B | AEB, ANB, APU, ARK, AWT | (+)COP, NOT FOR: M AWT |

| | | | | | |
|---------------|-----|---------------|---|-------------------------------|---------------------------|
| 1.8 T quattro | 132 | 12/97 → 01/05 | B | AJL | (+)COP |
| | 110 | 02/97 → 01/05 | B | AEB, ANB, APU, ARK, AWT | (+)COP, NOT FOR: M AWT |

Cabriolet

| | | | | | |
|-----|----|---------------|---|-----|--------|
| 1.8 | 92 | 01/97 → 08/00 | B | ADR | (+)COP |
|-----|----|---------------|---|-----|--------|

VOLKSWAGEN
Passat IV, Variant

| | | | | | |
|-----|----|---------------|---|-----------------------|---------------------------------|
| 1.6 | 74 | 10/96 → 11/00 | B | ADP, AHL, ANA, ARM | (+)COP, → 12-1997, M: ADP |
|-----|----|---------------|---|-----------------------|---------------------------------|

| | | | | | |
|-----|----|---------------|---|------------------|--------|
| 1.8 | 85 | 01/97 → 11/00 | B | AFY | (+)COP |
| | 92 | 10/96 → 11/00 | B | ADR, APT, ARG | (+)COP |

| | | | | | |
|------------------------|----|---------------|---|------------------|--------|
| 1.8 Syncro/ 4motion | 92 | 10/96 → 11/00 | B | ADR, APT, ARG | (+)COP |
|------------------------|----|---------------|---|------------------|--------|

| | | | | | |
|-------|-----|---------------|---|------------------|-----------------------------------|
| 1.8 T | 110 | 10/96 → 11/00 | B | AEB, ANB, APU | (+)COP, M: ANB, M: AEB, M: ANB |
|-------|-----|---------------|---|------------------|-----------------------------------|

| | | | | | |
|--------------|-----|---------------|---|-----|--------|
| 1.8 T Syncro | 110 | 11/96 → 08/00 | B | AEB | (+)COP |
|--------------|-----|---------------|---|-----|--------|

Passat V, Variant

| | | | | | |
|-----|----|---------------|---|-----|--------|
| 1.8 | 92 | 03/03 → 03/05 | B | APT | (+)COP |
|-----|----|---------------|---|-----|--------|

81531
350981531000

FLANGIA

| | |
|-------------------------|-------|
| Numero Fori Flangia | 3 |
| Dimensione Fori Flangia | M6×1 |
| Posizione Attacco | 70 |
| Diametro Mozzo | Ø23.5 |
| Diametro Girante | Ø57 |
| N° Alette Girante | 6 |
| Posizione Girante | 11.7 |

FORD
Escort IV, Station Wagon, Cabrio, Express

| | | | | | |
|-----|----|---------------|---|-----|-----------|
| 1.1 | 37 | 12/85 → 07/90 | B | GSG | → 12-1988 |
| | 37 | 05/86 → 07/90 | B | GSG | |

Orion II

| | | | | | |
|-----|----|---------------|---|------------------|--|
| 1.3 | 44 | 12/85 → 07/90 | B | JBB, JLA, JLB | |
|-----|----|---------------|---|------------------|--|

81532
350981532000

FLANGIA

| | |
|-------------------------|---------|
| Numero Fori Flangia | 4 |
| Dimensione Fori Flangia | M8×1.25 |
| Posizione Attacco | 95.5 |
| Diametro Mozzo | Ø23.5 |
| Diametro Girante | Ø71 |
| N° Alette Girante | 7 |
| Posizione Girante | 12.5 |

FORD
Sierra II, Station Wagon

| | | | | | |
|------------|----|---------------|---|----------|-------|
| 1.6 | 53 | 01/88 → 02/93 | B | LSF | (-)SS |
| | 53 | 01/88 → 02/93 | B | LSF | |
| | 55 | 01/87 → 02/93 | B | LSE | |
| 1.6 i | 59 | 10/89 → 02/93 | B | L6B | |
| | 59 | 10/89 → 02/93 | B | L6B | |
| 2.0 | 77 | 01/87 → 02/93 | B | N8C, NES | |
| | 80 | 07/89 → 12/92 | B | N8A | |
| 2.0 4x4 | 88 | 01/90 → 02/93 | B | N9C | |
| 2.0 i | 74 | 01/87 → 02/93 | B | NE5, NEJ | |
| | 80 | 06/89 → 02/93 | B | N8A | |
| 2.0 i Cat. | 74 | 01/87 → 02/93 | B | N4B | |

Transit IV

| | | | | | |
|-----|----|---------------|---|----------|--|
| 1.6 | 46 | 09/85 → 09/92 | B | LAT | |
| 2.0 | 57 | 12/85 → 09/92 | B | N6T | |
| | 57 | 11/85 → 09/92 | B | NAT, NAV | |

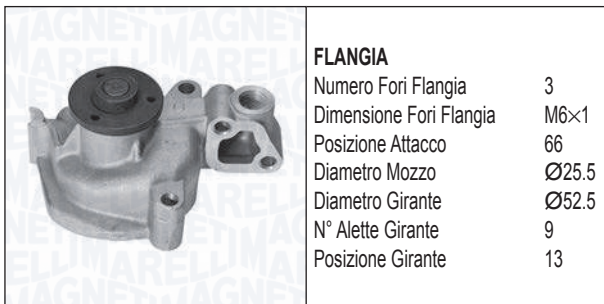
81536
350981536000

FLANGIA

| | |
|-------------------------|-------|
| Numero Fori Flangia | 3 |
| Dimensione Fori Flangia | M6×1 |
| Posizione Attacco | 66 |
| Diametro Mozzo | Ø25.5 |
| Diametro Girante | Ø52.5 |
| N° Alette Girante | 9 |
| Posizione Girante | 13 |

KW

FORD
Escort IV, Station Wagon, Cabrio, Express

| | | | | |
|-------|----|---------------|---|-----|
| 1.6 D | 40 | 02/86 → 07/90 | D | LTA |
|-------|----|---------------|---|-----|

81538
350981538000

PULEGGIA

| | |
|----------------------------|-------|
| Diametro Puleggia | Ø59.2 |
| Numero Denti/Gole Puleggia | 20 |
| Altezza Puleggia | 28 |
| Posizione Attacco | 51.5 |
| Diametro Girante | Ø71 |
| N° Alette Girante | 8 |
| Posizione Girante | 12 |

KW

FORD
Escort IV, Station Wagon, Cabrio, Express

| | | | | | |
|--------------|----|---------------|---|---------------|----------------------|
| 1.4 | 51 | 10/85 → 10/90 | B | FUAA | |
| | 54 | 01/86 → 07/90 | B | F6B, F6D, FUC | |
| | 55 | 01/86 → 07/90 | B | FUA | 01-1986 → |
| | 55 | 01/86 → 07/90 | B | FUA | |
| 1.4 i | 54 | 02/86 → 07/90 | B | F6B, F6D, FUC | |
| 1.6 | 58 | 01/86 → 07/90 | B | LP2 | |
| | 60 | 02/86 → 07/90 | B | LUC | |
| | 65 | 04/89 → 07/90 | B | LUG | 02-1982 →, → 12-1992 |
| 1.6 i | 66 | 01/86 → 07/90 | B | L4B | |
| | 75 | 08/89 → 07/90 | B | LJB | 02-1982 →, → 12-1992 |
| | 75 | 08/89 → 07/90 | B | LJB | |
| | 66 | 01/86 → 05/90 | B | L4B | |
| 1.6 Turbo RS | 97 | 01/86 → 07/90 | B | LNB | 02-1982 →, → 12-1992 |
| 1.6 XR3i | 77 | 01/86 → 07/90 | B | LR2, LRB | |

81538
350981538000

KW

FORD
Escort V, Station Wagon, Cabrio, Express

| | | | | | |
|-----|----|---------------|---|----------|--|
| 1.4 | 52 | 07/90 → 12/94 | B | F6F, F6G | |
| | 52 | 07/90 → 09/92 | B | F6F, F6G | |
| 1.6 | 66 | 07/90 → 08/92 | B | LUJ, LUK | |
| | 77 | 07/90 → 12/92 | B | LJF | |

Escort VI, Station Wagon, Cabrio

| | | | | | |
|-------|----|---------------|---|----------|--|
| 1.4 | 52 | 09/92 → 01/95 | B | F6F, F6G | |
| | 52 | 12/92 → 04/94 | B | F6F, F6G | |
| | 55 | 01/94 → 01/95 | B | F4B, FUH | |
| 1.4 i | 55 | 07/93 → 01/95 | B | F4B | |

Escort VII, Station Wagon, Cabrio, Express

| | | | | | |
|-----|----|---------------|---|----------|-----------|
| 1.4 | 54 | 01/95 → | B | F4B | |
| | 55 | 01/95 → 10/98 | B | F4B | |
| | 55 | 02/95 → 08/98 | B | F4B | 01-1986 → |
| | 55 | 01/95 → 02/99 | B | F4B, FUH | |

Fiesta III, Van

| | | | | | |
|-----------|----|---------------|---|----------|--|
| 1.4 | 52 | 03/89 → 12/95 | B | F6E | |
| | 54 | 03/89 → 12/95 | B | FUG, FUJ | |
| 1.4 Cat. | 54 | 03/89 → 12/95 | B | F4A | |
| 1.6 | 65 | 01/89 → 01/94 | B | LUH | |
| 1.6 Turbo | 96 | 03/90 → 10/92 | B | LHA | |
| 1.6 XR2i | 81 | 03/89 → 01/94 | B | LJC | |
| | 76 | 03/89 → 03/93 | B | LJD | |

Orion II

| | | | | | |
|------------|----|---------------|---|----------|--|
| 1.4 | 52 | 03/86 → 07/90 | B | FUAA | |
| | 54 | 01/86 → 07/90 | B | FUC | |
| | 55 | 12/85 → 07/90 | B | FUA | |
| 1.4 Cat. | 54 | 02/87 → 07/90 | B | F6B, F6D | |
| 1.6 | 66 | 12/85 → 07/90 | B | LUC | |
| 1.6 i | 75 | 08/89 → 07/90 | B | LJB | |
| | 77 | 03/86 → 07/90 | B | LRB | |
| 1.6 i Cat. | 66 | 03/86 → 07/90 | B | L4B | |

Orion III

| | | | | | |
|-------|----|---------------|---|----------|--|
| 1.4 | 52 | 07/90 → 12/93 | B | F6F, F6G | |
| | 54 | 07/90 → 12/93 | B | FUH | |
| 1.6 | 66 | 07/90 → 12/92 | B | LUJ, LUK | |
| 1.6 i | 77 | 07/90 → 09/92 | B | LJF | |

81543

350981543000



PULEGGIA
 Diametro Puleggia Ø62.2
 Numero Denti/Gole Puleggia 19
 Posizione Attacco 59.5
 Diametro Girante Ø55
 N° Alette Girante 9
 Posizione Girante 35



OPEL

Corsa A, Van

| | | | | |
|--------|----|---------------|---|------|
| 1.3 GL | 55 | 09/82 → 03/93 | B | 13S |
| 1.3 i | 44 | 09/86 → 09/90 | B | C13N |

Kadett E, Station Wagon, Coupé, Cabrio, Van

| | | | | |
|------------|----|---------------|---|-----------|
| 1.3 i Cat. | 44 | 09/85 → 08/91 | B | C13N |
| 1.3 N | 44 | 09/84 → 08/91 | B | 13N |
| | 44 | 09/84 → 08/91 | B | 13N, 13NB |
| 1.3 S | 55 | 03/87 → 02/93 | B | 13S |

VAUXHALL

ASTRA

| | | | | |
|-----|----|---------------|---|-----|
| 1.3 | 55 | 09/85 → 08/91 | B | 13S |
|-----|----|---------------|---|-----|

81544

350981544000



FLANGIA
 Numero Fori Flangia 3
 Dimensione Fori Flangia M6×1
 Posizione Attacco 86.5
 Diametro Mozzo Ø22
 Diametro Girante Ø60.9
 N° Alette Girante 8
 Posizione Girante -0.5



OPEL

Corsa A, Van

| | | | | |
|-----|----|---------------|---|-------------|
| 1.0 | 33 | 09/82 → 03/93 | B | 10S |
| 1.2 | 33 | 09/82 → 08/90 | B | 12NC, E12GV |

81549

350981549000

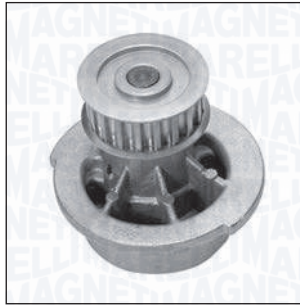

PULEGGIA
 Diametro Puleggia Ø56.3
 Numero Denti/Gole Puleggia 19
 Altezza Puleggia 20
 Posizione Attacco 59
 Diametro Girante Ø55
 N° Alette Girante 9
 Posizione Girante 35



DAEWOO

Cielo

| | | | | |
|-----|----|---------------|---|------|
| 1.5 | 66 | 06/94 → 07/98 | B | V15L |
|-----|----|---------------|---|------|

Nexia I

| | | | | |
|-----|----|---------------|---|-------|
| 1.5 | 44 | 08/96 → 08/97 | B | G15MF |
| | 52 | 02/95 → 08/97 | B | G15MF |
| | 55 | 02/95 → 08/97 | B | G15MF |

OPEL

Astra F Classic

| | | | | |
|-------|----|---------------|---|--------|
| 1.4 i | 44 | 01/98 → 08/02 | B | X14NZ |
| 1.6 i | 55 | 01/98 → 08/02 | B | X16SZR |

Astra F, Station Wagon, Cabrio, Van

| | | | | |
|--------|----|---------------|---|---------------|
| 1.4 | 55 | 09/91 → 09/93 | B | 14NV |
| | 60 | 09/92 → 09/98 | B | 14SE |
| 1.4 i | 44 | 03/92 → 01/98 | B | C14NZ |
| | 44 | 09/91 → 09/98 | B | C14NZ, X14NZ |
| 1.4 Si | 60 | 03/92 → 09/98 | B | C14SE |
| 1.6 i | 52 | 05/93 → 07/96 | B | X16SZ |
| | 55 | 10/91 → 04/93 | B | C16NZ |
| | 55 | 03/92 → 09/98 | B | C16NZ, X16SZR |
| 1.6 Si | 55 | 01/96 → 03/01 | B | X16SZR |
| | 74 | 05/92 → 12/94 | B | C16SE |

Astra G, Station Wagon, Coupé, Cabrio, Van

| | | | | |
|-----|----|---------------|---|----------------------------------|
| 1.6 | 55 | 02/98 → 09/00 | B | X16SZR |
| | 55 | 09/98 → 09/00 | B | X16SZR 09-1996 → |
| | 62 | 09/00 → 01/05 | B | Z16SE →M: 02MZ5253, →M: 20U75998 |
| | 62 | 09/00 → 04/05 | B | Z16SE →M: 20U75998, →M: 02MZ5253 |

Combo A

| | | | | |
|-----|----|---------------|---|-----------------------------------|
| 1.2 | 33 | 07/94 → 10/01 | B | C12NZ, X12SZ |
| 1.4 | 44 | 07/94 → 10/01 | B | C14NZ, X14SZ 09-1995 →, → 08-1996 |
| | 60 | 07/94 → 10/01 | B | C14SE |

81549 350981549000

OPEL
Corsa A, Van

| | | | | | |
|--------------|----|---------------|---|--------|-----------------|
| 1.2 | 44 | 09/82 → 08/90 | B | 12S | |
| 1.2 i | 33 | 09/89 → 03/93 | B | C12NZ | |
| 1.2 N | 38 | 01/90 → 03/93 | B | 12NV | |
| 1.2 S | 40 | 09/82 → 02/90 | B | 12ST | |
| 1.4 i | 44 | 01/90 → 03/93 | B | C14NZ | M →: 19.311.738 |
| 1.4 S | 53 | 01/90 → 03/93 | B | 14NV | M →: 19.307.807 |
| 1.4 Si | 60 | 09/91 → 03/93 | B | C14SE | |
| 1.6 GSI | 55 | 08/88 → 09/92 | B | C16NZ | T →: 02J22350 |
| | 72 | 09/89 → 03/93 | B | C16SEI | M →: 19.311.739 |
| | 74 | 05/88 → 03/92 | B | E16SE | T →: 02J22350 |
| 1.6 GSI Cat. | 74 | 02/92 → 03/93 | B | C16SE | |

Corsa B, Station Wagon, Van

| | | | | | |
|--------|----|---------------|---|--------------------------|--|
| 1.2 i | 33 | 03/93 → 09/00 | B | 12NZ, C12NZ, X12SZ | |
| 1.4 | 54 | 04/93 → 08/94 | B | C14SE | |
| 1.4 i | 40 | 03/93 → 09/00 | B | C14NZ, X14SZ | |
| | 44 | 03/93 → 09/00 | B | C14NZ, X14SZ | |
| 1.4 Si | 60 | 03/93 → 09/00 | B | C14SE | |

Kadett E, Station Wagon, Coupé, Cabrio, Van

| | | | | | |
|------------|----|---------------|---|-----------------|-----------------|
| 1.4 i | 44 | 01/90 → 08/91 | B | C14NZ | M →: 19.311.738 |
| 1.4 S | 55 | 01/90 → 08/91 | B | 14NV | |
| | 60 | 09/89 → 08/91 | B | C14SE | M →: 19.311.738 |
| 1.6 | 60 | 09/86 → 12/91 | B | 16SV | M →: 19.311.738 |
| 1.6 i | 55 | 08/91 → 07/94 | B | C16NZ | M →: 19.311.738 |
| | 55 | 09/86 → 08/91 | B | E16NZ | M →: 19.311.738 |
| | 60 | 07/89 → 02/93 | B | 16SV | M →: 19.311.738 |
| 1.6 i Cat. | 55 | 09/86 → 08/91 | B | C16LZ, C16NZ | M →: 19.311.738 |
| 1.6 S | 60 | 09/86 → 08/91 | B | 16SV | M →: 19.311.738 |

Vectra A

| | | | | | |
|------------|----|---------------|---|---|-----------------|
| 1.4 S | 55 | 09/88 → 06/92 | B | 14NV | M →: 19.307.806 |
| 1.6 | 60 | 09/88 → 05/93 | B | 16SV | M →: 2.122.350 |
| 1.6 i | 52 | 09/93 → 11/95 | B | X16SZ | M →: 2.122.350 |
| | 55 | 09/93 → 11/95 | B | 16LZ2 | M →: 2.122.350 |
| | 55 | 09/88 → 11/95 | B | 16LZ2, C16LZ2, C16NZ, C16NZ2, E16NZ | M →: 2.122.350 |
| 1.6 i Cat. | 55 | 09/88 → 11/95 | B | C16NZ, C16NZ2 | M →: 2.122.350 |
| 1.6 S | 60 | 09/88 → 05/93 | B | 16SV | M →: 2.122.350 |

81549 350981549000

OPEL
Vectra B, Station Wagon

| | | | | | |
|-------|----|---------------|---|--------|-----------------------------|
| 1.6 i | 55 | 10/95 → 04/02 | B | X16SZR | → 12-1999, → M: 02MZ5253 |
| | 55 | 10/95 → 07/03 | B | X16SZR | → M: 02MZ5253 |

VAUXHALL
CORSA

| | | | | | |
|---------|----|---------------|---|-------|-----------|
| 1.2 16V | 55 | 09/00 → 10/06 | B | Z12XE | 09-1996 → |
|---------|----|---------------|---|-------|-----------|

81550 350981550000



PULEGGIA

Diametro Puleggia Ø62.3

Numero Denti/Gole Puleggia 25

Altezza Puleggia 26

Posizione Attacco 66.4

Diametro Girante Ø65

N° Alette Girante 8

Posizione Girante 29

CHEVROLET
Captiva

| | | | | | |
|-------------|-----|---------|---|--------|--|
| 2.4 | 100 | 06/06 → | B | Z24SED | |
| 2.4 4WD | 100 | 06/06 → | B | Z24SED | |
| 2.4 LPG | 100 | 01/07 → | | Z24SED | |
| 2.4 LPG 4WD | 100 | 01/07 → | | Z24SED | |

Epica

| | | | | | |
|-----|----|---------------|---|--------|--|
| 2.0 | 94 | 01/05 → 12/06 | B | C20SED | |
| | 98 | 01/05 → 12/06 | B | T20SED | |

Evanda

| | | | | | |
|-----|----|---------|---|--------|--|
| 2.0 | 96 | 03/05 → | B | X20SED | |
|-----|----|---------|---|--------|--|

Lacetti

| | | | | | |
|-----|----|---------------|---|--------|--|
| 1.8 | 67 | 03/05 → 12/09 | B | F18D2 | |
| | 89 | 08/05 → | B | T18SED | |

Rezzo

| | | | | | |
|-----|----|---------|---|--------|--|
| 2.0 | 89 | 03/05 → | B | T20SED | |
| | 90 | 08/05 → | B | T20SED | |

DAEWOO
Evanda

| | | | | | |
|-----|----|---------|---|----------------|--|
| 2.0 | 96 | 08/02 → | B | L88, X20SED | |
|-----|----|---------|---|----------------|--|

Lacetti III, Hatchback

| | | | | | |
|---------|----|---------------|---|--------|--|
| 1.8 | 90 | 02/04 → | B | T18SED | |
| 1.8 CDX | 90 | 08/03 → 12/04 | B | T18SED | |

81550

350981550000



KW



DAEWOO

Leganza

| | | | | | |
|---------|-----|---------------|---|--------|--|
| 2.0 16V | 93 | 07/00 → 04/04 | B | T20SED | |
| | 98 | 06/97 → 12/02 | B | X20SED | |
| 2.2 16V | 100 | 04/99 → 12/02 | B | T22SED | |

Magnus

| | | | | | |
|-----|----|---------|---|--------|--|
| 2.0 | 96 | 07/99 → | B | X20SED | |
|-----|----|---------|---|--------|--|

Nubira I, Station Wagon

| | | | | | |
|---------|----|---------------|---|-----------------|--|
| 2.0 | 81 | 06/99 → 07/03 | B | C20SED | |
| 2.0 16V | 93 | 12/00 → | B | T20SED | |
| | 98 | 05/97 → | B | X20SED | |
| | 98 | 05/97 → | B | X20SED, Z20L | |

Rezzo

| | | | | | |
|-----|----|---------|---|--------|--|
| 2.0 | 89 | 09/01 → | B | X20SED | |
| | 94 | 09/00 → | B | T20SED | |

LADA

110

| | | | | | |
|-------|-----|---------|---|-------|--|
| 2.0 i | 110 | 08/96 → | B | C20XE | |
|-------|-----|---------|---|-------|--|

OPEL

Antara

| | | | | | |
|-------------|-----|---------|---|--------|--|
| 2.4 | 103 | 09/08 → | B | Z24XE | |
| | 104 | 05/06 → | B | Z24XED | |
| 2.4 4x4 | 103 | 01/07 → | B | Z24XE | |
| 2.4 LPG | 103 | 10/08 → | | Z24XE | |
| 2.4 LPG 4x4 | 103 | 10/08 → | | Z24XE | |

Astra F, Station Wagon, Cabrio, Van

| | | | | | |
|-------------|-----|---------------|---|------------------|-------------------------------|
| 1.7 D | 44 | 07/92 → 09/98 | D | 17DR | 01-1993 →, M →: 14.363.652 |
| 1.7 TD | 50 | 11/94 → 09/98 | D | X17DTL | |
| 1.8 i 16V | 85 | 11/94 → 09/98 | B | C18XEL, X18XE | |
| | 92 | 06/93 → 10/94 | B | C18XE | |
| 2.0 GSI 16V | 110 | 09/91 → 01/98 | B | C20XE | 01-1993 →, M →: 14.142.840 |
| 2.0 i 16V | 100 | 02/95 → 09/98 | B | X20XEV | |
| | 110 | 03/93 → 01/98 | B | C20XE | M →: 14.142.840 |

Astra G, Station Wagon, Coupé, Cabrio, Van

| | | | | | |
|-------------|-----|---------------|---|-------------------|-----------------|
| 1.7 TD | 50 | 02/98 → 08/00 | D | X17DTL | |
| 1.8 16V | 85 | 09/98 → 09/00 | B | X18XE1 | |
| 2.0 16V | 100 | 02/98 → 01/05 | B | C20SEL, X20XEV | |
| | 100 | 02/98 → 07/04 | B | X20XEV | |
| | 100 | 09/98 → 01/05 | B | X20XEV | M →: 14.142.840 |
| 2.0 16V OPC | 118 | 11/99 → 09/02 | B | X20XER | |

81550

350981550000



KW



OPEL

Astra G, Station Wagon, Coupé, Cabrio, Van

| | | | | | |
|---------------|-----|---------------|---|-------------------|--|
| 2.0 16V Turbo | 140 | 09/00 → 08/01 | B | Z20LET | |
| | 141 | 08/01 → 05/05 | B | Z20LET | |
| | 147 | 11/02 → 10/05 | B | Z20LER, Z20LET | |
| | 147 | 11/02 → 05/05 | B | Z20LET | |
| 2.0 OPC | 141 | 09/02 → 01/05 | B | Z20LET | |
| | 147 | 11/02 → 01/05 | B | Z20LET | |

Astra H, Station Wagon, GTC, Twin Top, Van

| | | | | | |
|-----------|-----|---------|---|--------|--|
| 2.0 Turbo | 125 | 03/04 → | B | Z20LEL | |
| | 147 | 09/04 → | B | Z20LER | |
| | 177 | 03/05 → | B | Z20LEH | |

Calibra

| | | | | | |
|-----------|-----|---------------|---|--------|-------------------------------|
| 2.0 i 16V | 100 | 02/94 → 07/97 | B | X20XEV | M →: 14.142.840 |
| | 110 | 06/90 → 02/94 | B | C20XE | 01-1993 →, M →: 14.142.839 |

Calibra

| | | | | | |
|-----------------|-----|---------------|---|--------|-------------------------------|
| 2.0 i 16V 4x4 | 100 | 02/94 → 07/97 | B | X20XEV | M →: 14.142.840 |
| | 110 | 06/90 → 02/94 | B | C20XE | 01-1993 →, M →: 14.142.839 |
| 2.0 i Turbo 4x4 | 150 | 03/92 → 07/97 | B | C20LET | 01-1993 →, M →: 14.002.935 |

Frontera A

| | | | | | |
|-------|-----|---------------|---|-------|--|
| 2.2 i | 100 | 03/95 → 10/98 | B | X22XE | |
|-------|-----|---------------|---|-------|--|

Frontera B

| | | | | | |
|-------|-----|---------|---|-----------------|--|
| 2.2 i | 100 | 10/98 → | B | X22SE, Y22SE | |
|-------|-----|---------|---|-----------------|--|

Omega B, Station Wagon

| | | | | | |
|---------|-----|---------------|---|-----------------|--|
| 2.0 16V | 100 | 03/94 → 09/99 | B | X20XEV | |
| 2.2 16V | 106 | 09/99 → 07/03 | B | Y22XE, Z22XE | |

Sintra

| | | | | | |
|-----------|-----|---------------|---|-------|--|
| 2.2 i 16V | 104 | 11/96 → 04/99 | B | X22XE | |
|-----------|-----|---------------|---|-------|--|

Speedster

| | | | | | |
|-----------|-----|---------|---|--------|--|
| 2.0 Turbo | 147 | 04/03 → | B | Z20LET | |
|-----------|-----|---------|---|--------|--|

Vectra A

| | | | | | |
|----------------|-----|---------------|---|--------|-------------------------------|
| 1.7 D | 42 | 10/88 → 09/92 | D | 17D | M →: 14.333.450 |
| | 44 | 07/92 → 11/95 | D | 17DR | 01-1993 →, M →: 14.333.450 |
| | 44 | 07/92 → 11/95 | D | 17DR | M →: 14.333.450 |
| 2.0 i 16V | 100 | 06/94 → 11/95 | B | X20XEV | M →: 14.142.839 |
| | 110 | 02/89 → 10/90 | B | 20XEJ | M →: 14.142.839 |
| 2.0 i 16V 4x4 | 100 | 06/94 → 11/95 | B | X20XEV | M →: 14.142.839 |
| 2.0 i 16V Cat. | 110 | 02/90 → 11/95 | B | C20XE | M →: 14.142.839 |

81550 350981550000

OPEL
Vectra A

| | | | | | |
|----------------------|-----|---------------|---|--------|-----------------|
| 2.0 i Turbo 4x4 | 150 | 06/94 → 11/95 | B | C20LET | M →: 14.002.935 |
| 2000 16V 4x4 | 110 | 01/89 → 10/90 | B | 20XEJ | M →: 14.142.839 |
| 2000/GT 16V | 110 | 01/89 → 06/94 | B | 20XEJ | M →: 14.142.839 |
| 2000/GT 16V 4x4 Cat. | 110 | 02/90 → 11/95 | B | C20XE | M →: 14.142.839 |
| 2000/GT 16V Cat. | 110 | 02/90 → 11/95 | B | C20XE | M →: 14.142.839 |

Vectra B, Station Wagon

| | | | | | |
|-----------|-----|---------------|---|----------------|---------------------|
| 1.8 i 16V | 85 | 10/95 → 09/00 | B | X18XE1, Z18XEL | → 12-1998, M: X18XE |
| | 85 | 10/95 → 09/00 | B | X18XE | |
| 2.0 i 16V | 100 | 10/95 → 09/00 | B | C20SEL, X20XEV | |

Zafira A

| | | | | | |
|---------|-----|---------------|---|----------------|--|
| 2.0 OPC | 141 | 09/01 → 06/05 | B | Z20LET | |
| | 147 | 11/02 → 06/05 | B | Z20LER, Z20LET | |

Zafira B, Van

| | | | | | |
|-----|-----|---------|---|--------|--|
| 2.0 | 147 | 07/05 → | B | Z20LER | |
| | 177 | 01/06 → | B | Z20LEH | |

81551 350981551000

| | |
|----------------------------|-------|
| PULEGGIA | |
| Diametro Puleggia | Ø62.3 |
| Numero Denti/Gole Puleggia | 25 |
| Altezza Puleggia | 21 |
| Posizione Attacco | 64.4 |
| Diametro Girante | Ø65 |
| N° Alette Girante | 8 |
| Posizione Girante | 29 |

OPEL
Astra F, Station Wagon, Cabrio, Van

| | | | | | |
|-------|----|---------------|---|--------------|----------------------------|
| 1.6 | 55 | 09/95 → 09/98 | B | 16LZ2, 16NZR | |
| 1.8 i | 66 | 03/92 → 09/98 | B | C18NZ | 11-1992 →, M →: 14.254.439 |

81551 350981551000

OPEL
Astra F, Station Wagon, Cabrio, Van

| | | | | | |
|-------|----|---------------|---|-------|----------------------------|
| 2.0 i | 85 | 09/91 → 07/94 | B | C20NE | 01-1992 →, M →: 14.608.701 |
| | 85 | 03/92 → 09/98 | B | C20NE | 11-1992 →, M →: 14.608.701 |

Astra F, Station Wagon, Cabrio, Van

| | | | | | |
|-------|----|---------------|---|-------|-----------------|
| 2.0 i | 85 | 03/93 → 10/94 | B | C20NE | M →: 14.608.701 |
|-------|----|---------------|---|-------|-----------------|

Calibra

| | | | | | |
|-----------|----|---------------|---|-------|----------------------------|
| 2.0 i | 85 | 06/90 → 07/97 | B | C20NE | 01-1993 →, M →: 14.608.701 |
| 2.0 i 4x4 | 85 | 06/90 → 07/97 | B | C20NE | 01-1993 →, M →: 14.608.701 |

Frontera A

| | | | | | |
|-------|----|---------------|---|--------------|----------|
| 2.0 i | 85 | 03/92 → 10/98 | B | C20NE, X20SE | M: X20SE |
|-------|----|---------------|---|--------------|----------|

Omega A, Station Wagon

| | | | | | |
|-------|----|---------------|---|--------|----------------------------|
| 2.0 | 73 | 09/90 → 03/94 | B | C20NEJ | |
| | 74 | 09/90 → 03/94 | B | C20NEF | M →: 14.608.701 |
| | 74 | 09/90 → 03/94 | B | C20NEF | |
| 2.0 | 90 | 09/86 → 03/94 | B | 20SE | 01-1990 →, M →: 14.608.701 |
| | 90 | 09/86 → 03/94 | B | 20SE | 01-1990 →, M →: 14.608.701 |
| 2.0 i | 73 | 09/90 → 03/94 | B | C20NEJ | |
| | 85 | 09/86 → 03/94 | B | C20NE | 01-1990 →, M →: 14.608.701 |

Omega B, Station Wagon

| | | | | | |
|-----|----|---------------|---|-------------|--|
| 2.0 | 85 | 03/94 → 12/00 | B | 20SE, X20SE | |
| | 85 | 03/94 → 09/99 | B | X20SE | |

Vectra A

| | | | | | |
|----------------|----|---------------|---|-------|----------------------------|
| 1.8 i | 66 | 09/88 → 10/90 | B | 18SV | T →: P1.000.001 |
| 1.8 i Cat. | 66 | 03/90 → 11/95 | B | C18NZ | 01-1993 →, T →: P1.000.001 |
| 1.8 S | 66 | 09/89 → 10/90 | B | 18SV | T →: P1.000.001 |
| 2.0 i | 85 | 09/88 → 10/90 | B | 20NE | T →: P1.000.001 |
| | 95 | 09/88 → 09/92 | B | 20SEH | T →: P1.000.001 |
| 2.0 i 4x4 | 85 | 01/89 → 10/90 | B | 20NE | T →: P1.000.001 |
| | 95 | 01/89 → 09/92 | B | 20SEH | T →: P1.000.001 |
| 2.0 i 4x4 Cat. | 85 | 01/89 → 11/95 | B | C20NE | T →: P1.000.001 |
| 2.0 i Cat. | 85 | 09/88 → 11/95 | B | C20NE | 01-1993 →, T →: P1.000.001 |
| 2.0 i GT | 95 | 09/88 → 11/95 | B | 20SEH | 01-1993 →, T →: P1.000.001 |

81551 350981551000



OPEL

Vectra B, Station Wagon

| | | | | | |
|-------|----|---------------|---|-------|--|
| 1.6 i | 55 | 10/95 → 04/02 | B | 16LZ2 | |
| 2.0 i | 82 | 10/95 → 04/02 | B | 20NEJ | |

VAUXHALL

OMEGA

| | | | | | |
|-----|----|---------------|---|------|--|
| 2.0 | 85 | 09/95 → 09/96 | B | 20SE | |
|-----|----|---------------|---|------|--|

81552 350981552000



ALBERINO

| | |
|-----------------------|---------|
| Versione | BC |
| Diametro Alberino | M14×1.5 |
| Tipo Filetto Alberino | Maschio |
| Posizione Attacco | 148 |
| Diametro Girante | Ø56 |
| N° Alette Girante | 6 |
| Posizione Girante | 12 |



PEUGEOT

305 II, Station Wagon

| | | | | | |
|-----|----|---------------|---|------------|--------|
| 1.5 | 50 | 09/85 → 07/90 | B | 142 (XR5A) | VA, BC |
|-----|----|---------------|---|------------|--------|

81554 350981554000



PULEGGIA

| | |
|----------------------------|--------|
| Diametro Puleggia | Ø59.26 |
| Numero Denti/Gole Puleggia | 20 |
| Altezza Puleggia | 33.5 |
| Posizione Attacco | 42.5 |
| Diametro Girante | Ø60 |
| N° Alette Girante | 6 |
| Posizione Girante | 40 |



CITROËN

BX, Break

| | | | | | |
|---------|-----|---------------|---|------------|----------------------------|
| 1.6 | 85 | 01/87 → 01/92 | B | B6D, B6E | |
| 1.8 D | 44 | 10/85 → 09/93 | D | 161 (XUD7) | → 12-1986, → PROD: 3583 |
| 1.9 GTi | 117 | 01/90 → 01/92 | B | | → PROD: 5409 |

81554 350981554000



CITROËN

BX, Break

| | | | | | |
|------------|-----|---------------|---|-------------------------------------|----------------------------|
| 16 | 53 | 01/87 → 02/93 | B | B1E (XU51C) | → 01-1992, → PROD: 5409 |
| | 55 | 09/88 → 02/93 | B | BAY (XU5CP), BAZ (XU5CP) | → 01-1992, → PROD: 5409 |
| | 58 | 09/87 → 02/93 | B | B1A (XU51C/K) | → 01-1992, → PROD: 5409 |
| | 64 | 07/85 → 02/93 | B | 171D | → 01-1992, → PROD: 5409 |
| | 65 | 05/89 → 12/94 | B | BDY (XU5M), BDZ (XU5M) | → 01-1992, → PROD: 5409 |
| | 68 | 10/82 → 12/92 | B | XU52C | → 01-1992, → PROD: 5409 |
| | 76 | 03/86 → 02/93 | B | 180Z | → 01-1992, → PROD: 5409 |
| 16 E | 65 | 05/89 → 02/93 | B | BDY (XU5M), BDZ (XU5M) | → 01-1992, → PROD: 5409 |
| 18 D | 44 | 10/85 → 09/93 | D | 161A (XUD7) | → 12-1986, → PROD: 3583 |
| 19 | 75 | 07/86 → 12/94 | B | D2A (XU92C) | → 01-1992, → PROD: 5409 |
| | 80 | 06/88 → 12/94 | B | DDZ (XU9M) | → 01-1992, → PROD: 5409 |
| | 88 | 06/88 → 12/94 | B | DKZ (XU9JA) | → 01-1992, → PROD: 5409 |
| 19 4x4 | 80 | 10/90 → 05/91 | B | DDZ (XU9M) | → PROD: 5.409 |
| 19 Cat. | 75 | 07/86 → 12/94 | B | DFZ (XU9J1) | → 01-1992, → PROD: 5409 |
| 19 D | 47 | 09/83 → 09/93 | D | 162 (XUD9), D9A (XUD9), DJZ (XUD9Y) | → 12-1986, → PROD: 3583 |
| 19 E | 80 | 06/88 → 02/93 | B | DDZ (XU9M) | → 01-1992, → PROD: 5409 |
| 19 E 4x4 | 80 | 04/89 → 02/93 | B | D2F | → 01-1992, → PROD: 5409 |
| 19 GTi | 88 | 06/88 → 02/93 | B | DKZ (XU9JA) | → 01-1992, → PROD: 5409 |
| | 90 | 07/86 → 02/93 | B | D6A (XU9J2) | → 01-1992, → PROD: 5409 |
| 19 GTi 16V | 108 | 03/88 → 02/93 | B | DFW (XU9J4) | → 01-1992, → PROD: 5409 |
| 19 GTi 4x4 | 88 | 06/88 → 02/93 | B | DKZ (XU9JA) | → 01-1992, → PROD: 5409 |

81554 350981554000

CITROËN
C 15

| | | | | | |
|-------|----|---------------|---|------------|--------------|
| 1.8 D | 44 | 07/86 → 12/00 | D | 161A(XUD7) | → PROD: 3583 |
|-------|----|---------------|---|------------|--------------|

Visa, Cabrio

| | | | | | |
|------|----|---------------|---|------------|----------------------------|
| 17 D | 44 | 04/84 → 03/91 | D | 161A(XUD7) | → 12-1986, → PROD: 3583 |
|------|----|---------------|---|------------|----------------------------|

ZX, Break

| | | | | | |
|-------|----|---------------|---|----------------------------|----------------------------|
| 1.6 i | 65 | 03/91 → 06/97 | B | BDY (XU5M), BFZ (XU5JP) | → 08-1992, → PROD: 5409 |
|-------|----|---------------|---|----------------------------|----------------------------|

| | | | | | |
|-------|----|---------------|---|-------------|--------------|
| 1.8 i | 74 | 07/92 → 06/97 | B | LFZ (XU7JP) | → PROD: 5409 |
|-------|----|---------------|---|-------------|--------------|

| | | | | | |
|-------|----|---------------|---|-------------|----------------------------|
| 1.9 i | 88 | 03/91 → 06/97 | B | DKZ (XU9JA) | → 08-1992, → PROD: 5409 |
|-------|----|---------------|---|-------------|----------------------------|

PEUGEOT
205 I, Van, Cabrio

| | | | | | |
|-----|----|---------------|---|-------------|--|
| 1.6 | 85 | 08/87 → 07/92 | B | B6D (XU5JA) | |
|-----|----|---------------|---|-------------|--|

| | | | | | |
|---------|----|---------------|---|-----------------------------|--|
| 1.6 CTI | 76 | 04/86 → 10/90 | B | 180A (XU5J), 180Z (XU5J) | |
|---------|----|---------------|---|-----------------------------|--|

| | | | | | |
|---------|----|---------------|---|-------------|-----------|
| 1.9 CTI | 75 | 10/87 → 12/94 | B | DFZ (XU9J1) | → 12-1991 |
|---------|----|---------------|---|-------------|-----------|

| | | | | | |
|---------|----|---------------|---|--------------|--|
| 1.9 CTi | 92 | 08/90 → 07/92 | B | DKZ (XU9JAZ) | |
|---------|----|---------------|---|--------------|--|

205 II, Van

| | | | | | |
|--|----|---------------|---|-------------|--|
| | 53 | 10/87 → 09/98 | B | B1E (XU51C) | |
|--|----|---------------|---|-------------|--|

| | | | | | |
|-----|----|---------------|---|----------------------------|--|
| 1.6 | 55 | 10/87 → 09/98 | B | B1A(XU51C), BAZ (XU5CP) | |
|-----|----|---------------|---|----------------------------|--|

| | | | | | |
|----------|----|---------------|---|--|-----------|
| 1.6 Aut. | 58 | 10/87 → 09/98 | B | | → 12-1991 |
|----------|----|---------------|---|--|-----------|

| | | | | | |
|---------|----|---------------|---|--------------|-----------|
| 1.9 GTI | 88 | 10/87 → 10/94 | B | DKZ (XU9JAZ) | → 12-1991 |
|---------|----|---------------|---|--------------|-----------|

| | | | | | |
|--|----|---------------|---|-------------|-----------|
| | 94 | 10/87 → 09/98 | B | D6B (XU9JA) | → 12-1991 |
|--|----|---------------|---|-------------|-----------|

| | | | | | |
|--------------|----|---------------|---|-------------|-----------|
| 1.9 GTI Cat. | 75 | 10/87 → 07/94 | B | DFZ (XU9J1) | → 12-1991 |
|--------------|----|---------------|---|-------------|-----------|

309 II

| | | | | | |
|-----|----|---------------|---|--|-----------|
| 1.6 | 65 | 07/89 → 12/93 | B | BDY (XU5M2Z), BDY (XU5M3Z), BDZ (XU5M) | → 01-1992 |
|-----|----|---------------|---|--|-----------|

| | | | | | |
|--|----|---------------|---|---------------|-----------|
| | 68 | 07/89 → 12/93 | B | B2A (XU52C/K) | → 01-1992 |
|--|----|---------------|---|---------------|-----------|

| | | | | | |
|--|----|---------------|---|---------------|-----------|
| | 69 | 07/89 → 12/93 | B | B2A (XU52C/K) | → 01-1992 |
|--|----|---------------|---|---------------|-----------|

| | | | | | |
|---------|----|---------------|---|--|-----------|
| 1.6 GTi | 85 | 09/89 → 10/93 | B | | → 01-1992 |
|---------|----|---------------|---|--|-----------|

| | | | | | |
|-----|----|---------------|---|-------------|-----------|
| 1.9 | 72 | 08/89 → 12/93 | B | DFZ (XU9J1) | → 01-1992 |
|-----|----|---------------|---|-------------|-----------|

| | | | | | |
|--|----|---------------|---|------------|-----------|
| | 80 | 10/90 → 12/93 | B | DDZ (XU9M) | → 01-1992 |
|--|----|---------------|---|------------|-----------|

| | | | | | |
|---------|----|---------------|---|--------------|-----------|
| 1.9 GTI | 88 | 07/89 → 12/93 | B | DKZ (XU9JAZ) | → 01-1992 |
|---------|----|---------------|---|--------------|-----------|

81554 350981554000

CITROËN
405 I, Station Wagon

| | | | | | |
|--|----|---------------|---|-------------|--|
| | 53 | 07/87 → 12/92 | B | B1E (XU51C) | |
|--|----|---------------|---|-------------|--|

| | | | | | |
|--|----|---------------|---|-------------|--|
| | 55 | 10/88 → 08/92 | B | BAZ (XU5CP) | |
|--|----|---------------|---|-------------|--|

| | | | | | |
|-----|----|---------------|---|--|--|
| 1.6 | 65 | 10/88 → 08/92 | B | BDY (XU5M2Z), BDY (XU5M3Z), BDZ (XU5M) | |
|-----|----|---------------|---|--|--|

| | | | | | |
|--|----|---------------|---|-----------------------------|--|
| | 65 | 07/87 → 12/92 | B | BDY (XU5M2Z), BDZ (XU5M) | |
|--|----|---------------|---|-----------------------------|--|

| | | | | | |
|--|----|---------------|---|------------|--|
| | 66 | 10/89 → 12/92 | B | BDZ (XU5M) | |
|--|----|---------------|---|------------|--|

| | | | | | |
|--|----|---------------|---|---------------|--|
| | 69 | 01/87 → 12/92 | B | B2A (XU52C/K) | |
|--|----|---------------|---|---------------|--|

| | | | | | |
|--|----|---------------|---|--|--|
| | 69 | 10/88 → 08/92 | B | | |
|--|----|---------------|---|--|--|

| | | | | | |
|---------|----|---------------|---|------------|--|
| 1.6 4x4 | 65 | 04/88 → 07/92 | B | BDZ (XU5M) | |
|---------|----|---------------|---|------------|--|

| | | | | | |
|-------------|----|---------------|---|------------|--|
| 1.6 SRi 4x4 | 65 | 04/88 → 07/92 | B | BDZ (XU5M) | |
|-------------|----|---------------|---|------------|--|

| | | | | | |
|--|----|---------------|---|-------------|--|
| | 70 | 07/87 → 12/92 | B | D2C (XU92C) | |
|--|----|---------------|---|-------------|--|

| | | | | | |
|--|----|---------------|---|-------------|--|
| | 77 | 10/88 → 08/92 | B | DFZ (XU9J1) | |
|--|----|---------------|---|-------------|--|

| | | | | | |
|-----|----|---------------|---|------------|--|
| 1.9 | 80 | 07/88 → 12/92 | B | DDZ (XU9M) | |
|-----|----|---------------|---|------------|--|

| | | | | | |
|--|----|---------------|---|--------------|--|
| | 88 | 07/88 → 12/92 | B | DKZ (XU9JAZ) | |
|--|----|---------------|---|--------------|--|

| | | | | | |
|--|----|---------------|---|-------------|--|
| | 93 | 07/87 → 12/93 | B | D6A (XU9J2) | |
|--|----|---------------|---|-------------|--|

| | | | | | |
|---------|----|---------------|---|------------|--|
| 1.9 4x4 | 80 | 07/88 → 12/92 | B | DDZ (XU9M) | |
|---------|----|---------------|---|------------|--|

| | | | | | |
|--|----|---------------|---|--------------|--|
| | 88 | 06/87 → 07/92 | B | DKZ (XU9JAZ) | |
|--|----|---------------|---|--------------|--|

| | | | | | |
|--|----|---------------|---|--|--|
| | 93 | 07/90 → 07/92 | B | | |
|--|----|---------------|---|--|--|

| | | | | | |
|---------------|----|---------------|---|-------------|--|
| 1.9 Injection | 77 | 07/87 → 12/92 | B | DFZ (XU9J1) | |
|---------------|----|---------------|---|-------------|--|

81556 350981556000

| | |
|--|---|
| | PULEGGIA Diametro Puleggia Ø59.26 Numero Denti/Gole Puleggia 20 Altezza Puleggia 33.5 Posizione Attacco 43 Diametro Girante Ø53.3 N° Alette Girante 6 Posizione Girante 41.85 |
|--|---|

CITROËN
AX

| | | | | | |
|---------|----|---------------|---|-----|--|
| 1.4 4x4 | 62 | 09/86 → 07/92 | B | K2A | |
|---------|----|---------------|---|-----|--|

| | | | | | |
|-----------|----|---------------|---|------------|--|
| 1.4 D 4x4 | 39 | 06/91 → 07/92 | D | K9A (TUD3) | |
|-----------|----|---------------|---|------------|--|

| | | | | | |
|---------|----|---------------|---|--------------|---------------|
| 1.4 GTi | 74 | 06/91 → 12/92 | B | KFZ (TU3FJ2) | → PROD: 5.278 |
|---------|----|---------------|---|--------------|---------------|

81556
350981556000

KW

CITROËN
AX

| | | | | | |
|--------|----|---------------|---|---|-----------|
| 10 | 32 | 09/86 → 06/92 | B | C1A | |
| | 33 | 07/86 → 12/98 | B | CDY (TU9M) | |
| | 37 | 02/87 → 12/98 | B | CDZ (TU9M) | |
| 11 | 40 | 12/86 → 04/94 | B | H1A, H1B | 12-1986 → |
| | 44 | 09/86 → 12/97 | B | H1B, HDZ (TU1M) | |
| 11 4x4 | 40 | 06/91 → 07/92 | B | H1A | |
| 14 | 55 | 04/87 → 04/97 | B | KDX (TU3M/Z), KDY (TU3FM), KDY (TU3M), KDZ (TU3M/Z) | → 12-1993 |
| | 62 | 01/88 → 12/92 | B | K2A, K2B | |
| 14 D | 37 | 08/91 → 12/97 | D | K9Y (TUD3Y) | 01-1993 → |
| | 38 | 09/88 → 06/92 | D | K9A (TUD3) | |

Berlingo I, Van

| | | | | | |
|-------|----|---------|---|--------------------------|----------------|
| 1.1 i | 44 | 07/96 → | B | HDZ (TU1M), HFX (TU1JP) | → M: 3.762.433 |
| 1.4 i | 55 | 07/96 → | B | KFW (TU3JP), KFX (TU3JP) | → M: 3.666.765 |

BX, Break

| | | | | | |
|----|----|---------------|---|--------------------------|--|
| 11 | 40 | 10/88 → 06/92 | B | HDZ (TU1M) | 10-1989 →, PROD →: 4193 |
| | 42 | 10/86 → 06/92 | B | H1A | 10-1989 →, PROD →: 4193 |
| 14 | 53 | 01/86 → 02/93 | B | 150C | 10-1989 →, → 01-1992, PROD →: 4193, → PROD: 5440 |
| 14 | 55 | 01/89 → 02/93 | B | KDY (TU3M) | 10-1989 →, → 01-1992, PROD →: 4193, → PROD: 5440 |
| | 55 | 01/89 → 02/93 | B | KDY (TU3M), KDZ (TU3M/Z) | 10-1989 →, → 01-1992, PROD →: 4193, → PROD: 5440 |

81556
350981556000

KW

CITROËN
BX, Break

| | | | | | |
|------|----|---------------|---|------|--|
| 14 E | 49 | 09/85 → 02/93 | B | 150F | 10-1989 →, → 01-1992, PROD →: 4193, → PROD: 5440 |
| | 53 | 04/83 → 02/93 | B | 150C | 10-1989 →, → 01-1992, PROD →: 4193, → PROD: 5440 |

C 15

| | | | | | |
|-------|----|---------------|---|-------------------------|-------------------------|
| 1.0 | 33 | 10/84 → 12/97 | B | TU9, XV8 | 01-1989 →, PROD →: 4193 |
| 1.0 E | 37 | 11/92 → 07/96 | B | TU9K | PROD →: 4193 |
| 1.1 | 35 | 10/84 → 12/96 | B | 109K, E1A | 01-1989 →, PROD →: 4193 |
| | 40 | 11/88 → 07/96 | B | H1A | |
| 1.1 i | 44 | 07/88 → 12/96 | B | HDZ (TU1M) | |
| 1.4 | 49 | 07/87 → 12/96 | B | K1H (TU3A) | PROD →: 4193 |
| 1.4 E | 40 | 07/87 → 12/96 | B | K3A | PROD →: 4193 |
| | 44 | 05/87 → 12/96 | B | 150D (XY7) | PROD →: 4193 |
| 1.4 i | 55 | 05/91 → 12/96 | B | KDY (TU3FM), KDY (TU3M) | PROD →: 4193 |

Saxo

| | | | | | |
|-----------|----|---------------|---|--------------------------|---------------------------|
| 1.0 X | 33 | 05/96 → 11/98 | B | CDZ (TU9M) | |
| | 37 | 05/98 → 06/03 | B | CDZ (TU9M) | |
| 1.1 X, SX | 40 | 05/96 → 09/03 | B | HDZ (TU1M) | → 07-2000, → M: 3.666.765 |
| | 44 | 05/96 → 09/03 | B | HDZ (TU1M), HFX (TU1JP) | → 07-2000, → M: 3.666.765 |
| 1.4 VTS | 55 | 05/96 → 06/03 | B | KFW (TU3JP), KFX (TU3JP) | → 07-2000, → M: 3.666.765 |

Xsara, Break, Coupé, Picasso, Van

| | | | | | |
|-------|----|---------------|---|--------------------------|---------------------------|
| 1.4 i | 55 | 04/97 → 03/05 | B | KFW (TU3JP), KFX (TU3JP) | → 08-2000, → M: 3.666.765 |
| | 55 | 10/97 → 08/05 | B | KFW (TU3JP), KFX (TU3JP) | → M: 3.666.765 |

ZX, Break

| | | | | | |
|-----|----|---------------|---|--------------|--|
| 1,1 | 40 | 03/91 → 08/93 | B | H1A, H1B | |
| | 44 | 03/91 → 06/97 | B | HDZ (TU1M) | |
| 1.4 | 55 | 03/91 → 06/97 | B | KDZ (TU3M/Z) | |

81556 350981556000

CITROËN
ZX, Break

| | | | | | |
|-------|----|---------------|---|---|----------------------|
| 1.4 D | 37 | 07/94 → 10/97 | D | K9Y (TUD3Y) | |
| 1.4 i | 55 | 10/93 → 10/97 | B | KDX (TU3M/Z), KDY (TU3M), KFX (TU3JP) | 07-1994 →, → 07-1995 |
| | 55 | 03/91 → 06/97 | B | KDX (TU3M/Z), KDZ (TU3M/Z), KFX (TU3JP) | |

MEGA
Club I

| | | | | | |
|-------|----|---------------|---|-------|--|
| 1.1 i | 44 | 01/92 → 06/99 | B | TU1MC | |
|-------|----|---------------|---|-------|--|

PEUGEOT
106 I, Van

| | | | | | |
|-------|----|---------------|---|-------------------------|--|
| 1.0 | 33 | 09/91 → 04/96 | B | CDY (TU9M), TU9 | |
| | 37 | 09/91 → 04/96 | B | CDZ (TU9M) | |
| 1.1 | 44 | 09/91 → 04/96 | B | HDZ (TU1M) | |
| 1.3 | 72 | 10/93 → 04/96 | B | TU2J2 | |
| 1.4 | 51 | 08/91 → 03/96 | B | K5A (TU3) | |
| | 55 | 09/91 → 04/96 | B | KDX (TU3MC), KDY (TU3M) | |
| | 69 | 09/91 → 04/96 | B | KFZ (TU3J2/Z) | |
| 1.4 D | 37 | 09/92 → 04/96 | D | K9Y (TUD3Y) | |
| 1.6 | 65 | 06/93 → 04/96 | B | NFZ (TU5JP) | |

106 II

| | | | | | |
|-------|----|---------|---|--------------------------|--|
| 1.0 i | 33 | 05/96 → | B | CDY (TU9M) | |
| | 37 | 01/97 → | B | CDZ (TU9M) | |
| 1.1 i | 40 | 01/97 → | B | HDY (TU1M) | |
| | 44 | 05/96 → | B | HDZ (TU1M), HFX (TU1JP) | |
| 1.4 i | 55 | 05/96 → | B | KFW (TU3JP), KFX (TU3JP) | |
| 1.6 i | 65 | 05/96 → | B | NFZ (TU5JP) | |

205 I, Van, Cabrio

| | | | | | |
|--------|----|---------------|---|------------------------|--|
| 1.1 CJ | 44 | 10/89 → 12/94 | B | HDZ (TU1M) | |
| | 49 | 03/89 → 12/94 | B | K1D (TU3A) | |
| 1.4 CJ | 55 | 05/91 → 12/94 | B | KDY (TU3M), KDZ (TU3M) | |

81556 350981556000

PEUGEOT
205 II, Van

| | | | | | |
|------------|----|---------------|---|-------------------------------------|----------------|
| 1.0 | 33 | 10/87 → 09/98 | B | TU9 | |
| | 37 | 08/92 → 05/97 | B | CDZ (TU9M) | |
| 1.1 | 40 | 10/87 → 10/90 | B | H1B (TU1) | |
| | 40 | 08/98 → 07/00 | B | HFX (TU1JP) | → M: 3.762.433 |
| | 44 | 07/89 → 09/98 | B | HDZ (TU1M) | |
| 1.1 i | 44 | 09/98 → | B | HFX (TU1JP), HFZ (TU1JP) | → M: 3.762.433 |
| 1.3 Rallye | 74 | 10/87 → 10/90 | B | TU24 | |
| | 49 | 10/87 → 10/90 | B | K1D (TU3A) | |
| 1.4 | 55 | 07/88 → 09/98 | B | KDY (TU3M), KDZ (TU3M), KFX (TU3JP) | |
| | 44 | 08/87 → 09/93 | B | KAY (TU3CP) | |
| 1.4 Cat. | 44 | 08/87 → 09/93 | B | KAY (TU3CP) | |
| 1.4 i | 55 | 09/98 → | B | KFW (TU3JP), KFX (TU3JP) | → M: 3.666.765 |
| 1.4 LPG | 55 | 05/06 → 09/07 | | KFV (TU3JP) | |

206, CC, Van

| | | | | | |
|-----|----|---------|---|-------------------------|----------------|
| 1.1 | 44 | 07/02 → | B | HFX (TU1JP) | → M: 3.762.433 |
| 1.4 | 55 | 07/02 → | B | KFV (TU3A), KFW (TU3JP) | → M: 3.666.765 |

306, Station Wagon, Coupé, Cabrio, Van

| | | | | | |
|--------|----|---------------|---|---------------------------------------|----------------|
| 1.1 | 44 | 06/94 → 05/01 | B | HDZ (TU1M) | |
| 1.4 | 55 | 05/93 → 05/01 | B | KDX (TU3MC), KFW (TU3JP), KFX (TU3JP) | → M: 3.666.765 |
| | 55 | 03/97 → 04/02 | B | KFW (TU3JP), KFX (TU3JP) | → M: 3.666.765 |
| 1.4 SL | 55 | 06/94 → 05/01 | B | KDX (TU3MC), KFW (TU3JP), KFX (TU3JP) | → M: 3.666.765 |

307, Station Wagon, CC

| | | | | | |
|-----|----|---------|---|-------------|----------------|
| 1.4 | 55 | 08/00 → | B | KFW (TU3JP) | → M: 3.666.765 |
|-----|----|---------|---|-------------|----------------|

309 II

| | | | | | |
|-----|----|---------------|---|------------------------|--|
| 1.1 | 44 | 08/90 → 12/93 | B | HDZ (TU1M) | |
| | 49 | 07/90 → 12/93 | B | K1D (TU3A) | |
| 1.4 | 55 | 07/89 → 12/93 | B | KDY (TU3M), KDZ (TU3M) | |

81556
350981556000

PEUGEOT
405 I, Station Wagon

| | | | | | |
|-----|----|---------------|---|-----------|--|
| 1.4 | 47 | 01/87 → 07/92 | B | K5A (TU3) | |
|-----|----|---------------|---|-----------|--|

Partner I

| | | | | | |
|-----|----|---------|---|-------------------------|-----------|
| 1.1 | 44 | 06/96 → | B | HDZ (TU1M) | → 10-2002 |
| | 44 | 06/96 → | B | HDZ (TU1M), HFX (TU1JP) | → 10-2002 |

| | | | | | |
|-----|----|---------|---|--------------------------------|-----------|
| 1.4 | 55 | 06/96 → | B | KFW (TU3JP), KFX (TU3JP), TU32 | → 10-2002 |
| | 55 | 06/96 → | B | KFX (TU3JP), TU32 | → 10-2002 |

| | | | | | |
|------------|----|---------|----|-------------|----------------|
| 1.4 BiFuel | 55 | 04/03 → | BF | KFW (TU3JP) | → M: 3.666.765 |
|------------|----|---------|----|-------------|----------------|

| | | | | | |
|-------|----|---------------|---|------|--|
| 114 D | 38 | 10/92 → 12/94 | D | TUD3 | |
| 115 D | 42 | 12/94 → 12/98 | D | TUD5 | |

| | | | | | |
|--------|---------------|---------------|--------------------|---------------|--|
| 51 | 09/91 → 08/94 | D | 4AB, 4BC, 4CC, 4FA | | |
| 2.5 DI | 51 | 08/91 → 07/94 | D | 4BC, 4CC, 4FA | |
| | 59 | 09/91 → 07/94 | D | 4DA | |
| 2.5 TD | 63 | 10/92 → 06/94 | D | 4GA | |
| | 63 | 10/92 → 07/94 | D | 4GA, 4GB, 4GC | |
| 74 | 09/91 → 07/94 | D | 4EA | | |

| | | | | | |
|--------|---------------|---------------|--------------------|------------------------------|--|
| 51 | 08/94 → 03/00 | D | 4FA, 4FB, 4FC, 4FD | | |
| 2.5 DI | 56 | 07/94 → 03/00 | D | 4HB, 4HC | |
| | 85 | 08/97 → 03/00 | D | 4ED | |
| 2.5 TD | 55 | 08/94 → 06/00 | D | 4HA, 4HD | |
| | 63 | 01/95 → 03/00 | D | 4GA, 4GB, 4GC, 4GD, 4GE, 4GF | |
| 74 | 07/94 → 03/00 | D | 4EB, 4EC | | |

| | | | | | |
|---------|----|---------------|---|----------|--|
| 2.5 TDI | 74 | 06/94 → 03/00 | D | 4EB, 4EC | |
|---------|----|---------------|---|----------|--|

81559
350981559000

| | |
|-------------------------|--------|
| FLANGIA | |
| Numero Fori Flangia | 4 |
| Dimensione Fori Flangia | M6×1 |
| Posizione Attacco | 83.5 |
| Diametro Mozzo | Ø28.05 |
| Diametro Girante | Ø60 |
| N° Alette Girante | 6 |
| Posizione Girante | 14 |

FORD
Transit IV

| | | | | | |
|-------|----|---------------|---|---------------|--|
| 2.5 D | 50 | 01/86 → 09/91 | D | 4AB | |
| | 52 | 09/88 → 09/92 | D | 4AB, 4BA, 4CA | |
| | 52 | 10/88 → 09/91 | D | 4BA, 4CA | |

| | | | | | |
|--------|----|---------------|---|----------|--|
| 2.5 DI | 52 | 09/88 → 09/92 | D | 4BA, 4CA | |
|--------|----|---------------|---|----------|--|

| | | | | | |
|--------|----|---------------|---|--------------------|--|
| 2.4 D | 55 | 08/94 → 06/00 | D | 4HA | |
| 2.5 DI | 51 | 11/94 → 12/00 | D | 4FA, 4FB, 4FC, 4FD | |
| | 56 | 11/94 → 12/00 | D | 4HA, 4HB, 4HC | |

| | | | | | |
|--------|----|---------------|---|---------------|--|
| 2.5 TD | 63 | 11/94 → 12/00 | D | 4GA, 4GB, 4GC | |
|--------|----|---------------|---|---------------|--|

81559
350981559000

CITROËN
Transit Tourneo I

| | | | | | |
|--------|----|---------------|---|----------|--|
| 2.5 TD | 74 | 04/98 → 12/00 | D | 4EB, 4EC | |
|--------|----|---------------|---|----------|--|

Transit V

| | | | | | |
|--------|----|---------------|---|--------------------|--|
| 2.5 DI | 51 | 09/91 → 08/94 | D | 4AB, 4BC, 4CC, 4FA | |
| | 51 | 08/91 → 07/94 | D | 4BC, 4CC, 4FA | |
| 2.5 TD | 59 | 09/91 → 07/94 | D | 4DA | |
| | 63 | 10/92 → 06/94 | D | 4GA | |
| 2.5 TD | 63 | 10/92 → 07/94 | D | 4GA, 4GB, 4GC | |
| | 74 | 09/91 → 07/94 | D | 4EA | |

| | | | | | |
|--------|---------------|---------------|--------------------|------------------------------|--|
| 51 | 08/94 → 03/00 | D | 4FA, 4FB, 4FC, 4FD | | |
| 2.5 DI | 56 | 07/94 → 03/00 | D | 4HB, 4HC | |
| | 85 | 08/97 → 03/00 | D | 4ED | |
| 2.5 TD | 55 | 08/94 → 06/00 | D | 4HA, 4HD | |
| | 63 | 01/95 → 03/00 | D | 4GA, 4GB, 4GC, 4GD, 4GE, 4GF | |
| 74 | 07/94 → 03/00 | D | 4EB, 4EC | | |

| | | | | | |
|---------|----|---------------|---|----------|--|
| 2.5 TDI | 74 | 06/94 → 03/00 | D | 4EB, 4EC | |
|---------|----|---------------|---|----------|--|

| | | | | | |
|--------|---------------|---------------|--------------------|------------------------------|--|
| 51 | 08/94 → 03/00 | D | 4FA, 4FB, 4FC, 4FD | | |
| 2.5 DI | 56 | 07/94 → 03/00 | D | 4HB, 4HC | |
| | 85 | 08/97 → 03/00 | D | 4ED | |
| 2.5 TD | 55 | 08/94 → 06/00 | D | 4HA, 4HD | |
| | 63 | 01/95 → 03/00 | D | 4GA, 4GB, 4GC, 4GD, 4GE, 4GF | |
| 74 | 07/94 → 03/00 | D | 4EB, 4EC | | |

| | | | | | |
|---------|----|---------------|---|----------|--|
| 2.5 TDI | 74 | 06/94 → 03/00 | D | 4EB, 4EC | |
|---------|----|---------------|---|----------|--|

| | | | | | |
|--------|---------------|---------------|--------------------|------------------------------|--|
| 51 | 08/94 → 03/00 | D | 4FA, 4FB, 4FC, 4FD | | |
| 2.5 DI | 56 | 07/94 → 03/00 | D | 4HB, 4HC | |
| | 85 | 08/97 → 03/00 | D | 4ED | |
| 2.5 TD | 55 | 08/94 → 06/00 | D | 4HA, 4HD | |
| | 63 | 01/95 → 03/00 | D | 4GA, 4GB, 4GC, 4GD, 4GE, 4GF | |
| 74 | 07/94 → 03/00 | D | 4EB, 4EC | | |

| | | | | | |
|---------|----|---------------|---|----------|--|
| 2.5 TDI | 74 | 06/94 → 03/00 | D | 4EB, 4EC | |
|---------|----|---------------|---|----------|--|

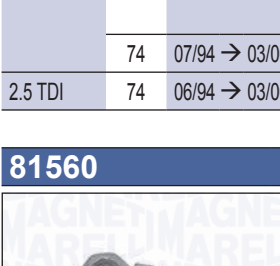
81560
350981560000

| | |
|-------------------------|-------|
| FLANGIA | |
| Numero Fori Flangia | 3 |
| Dimensione Fori Flangia | M7×1 |
| Posizione Attacco | 70 |
| Diametro Girante | Ø51.5 |
| N° Alette Girante | 6 |
| Posizione Girante | 33 |

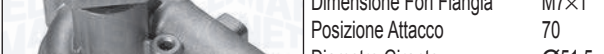
CITROËN
C 15

| | | | | | |
|-----|----|---------------|---|-----------|----------------------------|
| 1.1 | 35 | 10/84 → 12/96 | B | 109K, E1A | → 12-1988, → PROD: 4237 |
|-----|----|---------------|---|-----------|----------------------------|

| | | | | | |
|---------|----|---------------|---|-----|--|
| 1.2 | 47 | 01/87 → 12/90 | B | F1 | |
| 1.3 | 47 | 08/90 → 07/92 | B | G1A | |
| 1.6 GTX | 69 | 01/87 → 10/91 | B | | |

| | | | | | |
|---------|----|---------------|---|-----|--|
| 1.2 | 47 | 01/87 → 12/90 | B | F1 | |
| 1.3 | 47 | 08/90 → 07/92 | B | G1A | |
| 1.6 GTX | 69 | 01/87 → 10/91 | B | | |

| | | | | | |
|---------|----|---------------|---|-----|--|
| 1.2 | 47 | 01/87 → 12/90 | B | F1 | |
| 1.3 | 47 | 08/90 → 07/92 | B | G1A | |
| 1.6 GTX | 69 | 01/87 → 10/91 | B | | |

| | | | | | |
|---------|----|---------------|---|-----|--|
| 1.2 | 47 | 01/87 → 12/90 | B | F1 | |
| 1.3 | 47 | 08/90 → 07/92 | B | G1A | |
| 1.6 GTX | 69 | 01/87 → 10/91 | B | | |

81560 350981560000

PEUGEOT
309 II

| | | | | |
|-----|----|---------------|---|-----------|
| 1.1 | 40 | 09/89 → 10/93 | B | H1B (TU1) |
|-----|----|---------------|---|-----------|

81572 350981572000

PULEGGIA

| | |
|----------------------------|------|
| Diametro Puleggia | Ø121 |
| Numero Denti/Gole Puleggia | 1 |
| Posizione Attacco | 106 |
| Diametro Girante | Ø53 |
| N° Alette Girante | 6 |
| Posizione Girante | 11.5 |

CITROËN
BX, Break

| | | | | | |
|----|----|---------------|---|------------|----------------------------|
| 11 | 40 | 10/88 → 06/92 | B | HDZ (TU1M) | → 09-1989, → PROD: 4192 |
| | 42 | 10/86 → 06/92 | B | H1A | → 09-1989, → PROD: 4192 |

| | | | | | |
|----|----|---------------|---|------------|----------------------------|
| 14 | 53 | 01/86 → 02/93 | B | 150C | → 09-1989, → PROD: 4192 |
| | 55 | 01/89 → 02/93 | B | KDY (TU3M) | → 09-1989, → PROD: 4192 |

| | | | | | |
|----|----|---------------|---|-----------------------------|----------------------------|
| 14 | 55 | 01/89 → 02/93 | B | KDY (TU3M), KDZ (TU3M/Z) | → 09-1989, → PROD: 4192 |
|----|----|---------------|---|-----------------------------|----------------------------|

| | | | | | |
|------|----|---------------|---|------|----------------------------|
| 14 E | 49 | 09/85 → 02/93 | B | 150F | → 09-1989, → PROD: 4192 |
| | 53 | 04/83 → 02/93 | B | 150C | → 09-1989, → PROD: 4192 |

| | | | | | |
|------|----|---------------|---|------|----------------------------|
| 14 E | 53 | 04/83 → 02/93 | B | 150C | → 09-1989, → PROD: 4192 |
|------|----|---------------|---|------|----------------------------|

| | | | | | |
|------|----|---------------|---|------|----------------------------|
| 14 E | 53 | 04/83 → 02/93 | B | 150C | → 09-1989, → PROD: 4192 |
|------|----|---------------|---|------|----------------------------|

| | | | | | |
|------|----|---------------|---|------|----------------------------|
| 14 E | 53 | 04/83 → 02/93 | B | 150C | → 09-1989, → PROD: 4192 |
|------|----|---------------|---|------|----------------------------|

| | | | | | |
|------|----|---------------|---|------|----------------------------|
| 14 E | 53 | 04/83 → 02/93 | B | 150C | → 09-1989, → PROD: 4192 |
|------|----|---------------|---|------|----------------------------|

| | | | | | |
|-----|----|---------------|---|----------|----------------------------|
| 1.0 | 33 | 10/84 → 12/97 | B | TU9, XV8 | → 12-1988, → PROD: 4192 |
|-----|----|---------------|---|----------|----------------------------|

| | | | | | |
|-------|----|---------------|---|------|--------------|
| 1.0 E | 37 | 11/92 → 07/96 | B | TU9K | → PROD: 4192 |
|-------|----|---------------|---|------|--------------|

| | | | | | |
|-----|----|---------------|---|-----------|--------------|
| 1.1 | 35 | 10/84 → 12/96 | B | 109K, E1A | → PROD: 4192 |
|-----|----|---------------|---|-----------|--------------|

| | | | | | |
|-----|----|---------------|---|------------|--------------|
| 1.4 | 49 | 07/87 → 12/96 | B | K1H (TU3A) | → PROD: 4192 |
|-----|----|---------------|---|------------|--------------|

| | | | | | |
|-------|----|---------------|---|------------|--------------|
| 1.4 E | 40 | 07/87 → 12/96 | B | K3A | → PROD: 4192 |
| | 44 | 05/87 → 12/96 | B | 150D (XY7) | → PROD: 4192 |

| | | | | | |
|-------|----|---------------|---|----------------------------|--------------|
| 1.4 i | 55 | 05/91 → 12/96 | B | KDY (TU3FM), KDY (TU3M) | → PROD: 4192 |
|-------|----|---------------|---|----------------------------|--------------|

81572 350981572000

CITROËN
Visa, Cabrio

| | | | | |
|------|----|---------------|---|--------|
| 11 E | 37 | 07/82 → 03/91 | B | 109/5F |
|------|----|---------------|---|--------|

| | | | | |
|----|----|---------------|---|------------|
| 14 | 44 | 07/84 → 03/91 | B | 150D (XY7) |
|----|----|---------------|---|------------|

| | | | | |
|-------|----|---------------|---|------------|
| 14 GT | 58 | 03/82 → 03/91 | B | 150B (XY8) |
|-------|----|---------------|---|------------|

PEUGEOT
205 I, Van, Cabrio

| | | | | |
|-----|----|---------------|---|------------|
| 1.4 | 62 | 08/87 → 06/94 | B | K2B (TU3S) |
|-----|----|---------------|---|------------|

| | | | | |
|-------------|----|---------------|---|-------------|
| 1.4 CJ Cat. | 44 | 01/89 → 09/93 | B | KAY (TU3CP) |
|-------------|----|---------------|---|-------------|

205 II, Van

| | | | | |
|-----|----|---------------|---|------------|
| 1.1 | 36 | 10/87 → 10/90 | B | 109N (XW7) |
|-----|----|---------------|---|------------|

81573 350981573000

PULEGGIA

| | |
|----------------------------|------|
| Diametro Puleggia | Ø144 |
| Numero Denti/Gole Puleggia | 1 |
| Posizione Attacco | 29.5 |
| Diametro Girante | Ø67 |
| N° Alette Girante | 8 |
| Posizione Girante | 18 |

RENAULT
19 I, Chamade, Cabrio

| | | | | | |
|-----|----|---------------|---|--------|--------|
| 1.2 | 40 | 01/88 → 12/92 | B | C1G730 | (-)COP |
|-----|----|---------------|---|--------|--------|

| | | | | | |
|-----|----|---------------|---|-------------------|------------------------------------|
| 1.4 | 43 | 07/88 → 04/92 | B | C2J772, C3J710 | (-)COP |
| | 43 | 01/89 → 04/92 | B | C2J772, C3J710 | (-)COP, 07-1988 →, → 04-1992 |

| | | | | | |
|-----|----|---------------|---|-------------------|------------------------------------|
| 1.4 | 43 | 01/89 → 04/92 | B | C2J772, C3J710 | (-)COP, 07-1988 →, → 04-1992 |
|-----|----|---------------|---|-------------------|------------------------------------|

| | | | | | |
|-----|----|---------------|---|-------------------|------------------------------------|
| 1.4 | 43 | 01/89 → 04/92 | B | C2J772, C3J710 | (-)COP, 07-1988 →, → 04-1992 |
|-----|----|---------------|---|-------------------|------------------------------------|

| | | | | | |
|-----|----|---------------|---|-------------------|------------------------------------|
| 1.4 | 43 | 01/89 → 04/92 | B | C2J772, C3J710 | (-)COP, 07-1988 →, → 04-1992 |
|-----|----|---------------|---|-------------------|------------------------------------|

| | | | | | |
|-----|----|---------------|---|-------------------|------------------------------------|
| 1.4 | 43 | 01/89 → 04/92 | B | C2J772, C3J710 | (-)COP, 07-1988 →, → 04-1992 |
|-----|----|---------------|---|-------------------|------------------------------------|

| | | | | | |
|-----|----|---------------|---|-------------------|------------------------------------|
| 1.4 | 43 | 01/89 → 04/92 | B | C2J772, C3J710 | (-)COP, 07-1988 →, → 04-1992 |
|-----|----|---------------|---|-------------------|------------------------------------|

| | | | | | |
|-----|----|---------------|---|--------|--------|
| 1.2 | 40 | 04/92 → 12/95 | B | C1G730 | (-)COP |
|-----|----|---------------|---|--------|--------|

| | | | | | |
|-----|----|---------------|---|--------|--------|
| 1.4 | 43 | 04/92 → 12/95 | B | C3J710 | (-)COP |
|-----|----|---------------|---|--------|--------|

| | | | | | |
|-----|----|---------------|---|--------|--------|
| 1.4 | 43 | 04/92 → 12/95 | B | C3J710 | (-)COP |
|-----|----|---------------|---|--------|--------|

| | | | | | |
|-----|----|---------------|---|--------|--------|
| 1.4 | 51 | 09/89 → 05/93 | B | C2J770 | (-)COP |
|-----|----|---------------|---|--------|--------|

| | | | | | |
|-----|----|---------------|---|--------|--------|
| 1.4 | 51 | 09/89 → 05/93 | B | C2J770 | (-)COP |
|-----|----|---------------|---|--------|--------|

| | | | | | |
|-----|----|---------------|---|--------|--------|
| 1.4 | 51 | 09/89 → 05/93 | B | C2J770 | (-)COP |
|-----|----|---------------|---|--------|--------|

| | | | | | |
|-----|----|---------------|---|--------|--------|
| 1.4 | 51 | 09/89 → 05/93 | B | C2J770 | (-)COP |
|-----|----|---------------|---|--------|--------|

| | | | | | |
|-----|----|---------------|---|--------|--------|
| 1.4 | 51 | 09/89 → 05/93 | B | C2J770 | (-)COP |
|-----|----|---------------|---|--------|--------|

| | | | | | |
|-----|----|---------------|---|--------|--------|
| 1.4 | 51 | 09/89 → 05/93 | B | C2J770 | (-)COP |
|-----|----|---------------|---|--------|--------|

| | | | | | |
|-----|----|---------------|---|--------|--------|
| 1.4 | 51 | 09/89 → 05/93 | B | C2J770 | (-)COP |
|-----|----|---------------|---|--------|--------|

| | | | | | |
|-----|----|---------------|---|--------|--------|
| 1.4 | 51 | 09/89 → 05/93 | B | C2J770 | (-)COP |
|-----|----|---------------|---|--------|--------|

| | | | | | |
|-----|----|---------------|---|--------|--------|
| 1.4 | 51 | 09/89 → 05/93 | B | C2J770 | (-)COP |
|-----|----|---------------|---|--------|--------|

81573
350981573000

KW

RENAULT
Rapid

| | | | | | |
|-----|----|---------------|---|--|---------------|
| 1.0 | 27 | 02/86 → 05/92 | B | C1C706 | (-)COP, (-)AC |
| 1.1 | 33 | 07/85 → 04/95 | B | C1E750, C1E752, C1E754, C1E756, C1E760, C1E762, C1E792 | (-)COP, (-)AC |
| 1.2 | 40 | 09/91 → 03/98 | B | C3G710, C3G712 | (-)COP, (-)AC |
| 1.4 | 43 | 07/85 → 03/98 | B | C1J768, C1J780, C3J700, C3J702, C3J760, C3J762 | (-)COP, (-)AC |
| | 44 | 03/86 → 08/91 | B | C2J784 | (-)COP, (-)AC |

Super 5

| | | | | | |
|--------------|-----|---------------|---|--|---------------|
| 1.1 | 33 | 01/86 → 03/95 | B | C1E750, C1E752, C1E756, C1E760 | (-)COP, (-)AC |
| | 34 | 10/84 → 12/96 | B | C1E750, C1E752, C1E754 | (-)COP, (-)AC |
| 1.2 | 40 | 01/87 → 08/90 | B | C1G702, C1G720, C1G722 | (-)COP, (-)AC |
| | 44 | 01/87 → 12/96 | B | C1G702 | (-)COP, (-)AC |
| 1.4 | 43 | 10/84 → 12/96 | B | C1J768, C1J780, C3J700, C3J702, C3J760 | (-)COP, (-)AC |
| | 44 | 06/87 → 08/90 | B | C2J784 | (-)COP, (-)AC |
| 1.4 Turbo | 88 | 04/85 → 08/90 | B | C1J782, C1J784, C1J788 | (-)COP, (-)AC |
| 1.4 Turbo GT | 118 | 01/85 → 05/91 | B | 840730 | (-)COP, (-)AC |

81574
350981574000

KW

FLANGIA

| | |
|-------------------------|---------|
| Numero Fori Flangia | 3 |
| Dimensione Fori Flangia | M8x1.25 |
| Posizione Attacco | 57 |
| Diametro Mozzo | Ø28 |
| Diametro Centraggio | Ø50 |
| Diametro Girante | Ø61.8 |
| N° Alette Girante | 8 |
| Posizione Girante | 24 |

KW

DACIA
Solenza

| | | | | |
|-------|----|---------|---|--------|
| 1.9 D | 46 | 02/03 → | D | F8Q630 |
|-------|----|---------|---|--------|

MITSUBISHI
Carisma

| | | | | |
|--------|----|---------------|---|------|
| 1.9 TD | 66 | 10/96 → 09/00 | D | F8QT |
|--------|----|---------------|---|------|

OPEL
Arena

| | | | | |
|-------|----|---------------|---|-------------------|
| 1.9 D | 44 | 01/97 → 12/01 | D | 19DJ, 19DL |
| | 44 | 03/98 → 08/01 | D | F8Q600, F8Q606 |

Movano A

| | | | | |
|---------|----|---------------|---|--------|
| 1.9 DTI | 59 | 09/00 → 10/01 | D | F9Q770 |
|---------|----|---------------|---|--------|

RENAULT
19 I, Chamade, Cabrio

| | | | | |
|---------|-----|---------------|---|-------------------|
| 1.7 | 55 | 07/91 → 04/92 | B | F2N724 |
| | 70 | 07/91 → 04/92 | B | F3N742, F3N743 |
| | 54 | 09/88 → 04/92 | B | F3N740, F3N741 |
| | 66 | 09/88 → 04/92 | B | F3N742, F3N743 |
| | 79 | 08/88 → 12/92 | B | F3N746 |
| 1.8 16V | 99 | 06/89 → 04/92 | B | F7P704 |
| | 101 | 07/91 → 04/92 | B | F7P700, F7P704 |
| 1.9 D | 48 | 01/88 → 12/92 | D | F8Q706, F8Q742 |
| | 47 | 09/88 → 04/92 | D | F8Q706, F8Q742 |
| 1.9 DT | 68 | 09/90 → 04/92 | D | F8Q610 |
| 1.9 TD | 68 | 09/90 → 04/92 | D | F8Q740 |

19 II, Chamade, Cabrio

| | | | | |
|-----|----|---------------|---|-------------------|
| 1.7 | 54 | 04/92 → 12/95 | B | F3N740, F3N741 |
| | 66 | 04/92 → 09/93 | B | F3N742, F3N743 |
| | 66 | 04/92 → 12/95 | B | F3N743 |

81574
350981574000

KW

RENAULT
19 II, Chamade, Cabrio

| | | | | |
|---------|----|---------------|---|---|
| 1.8 | 79 | 05/94 → 12/95 | B | F3P682 |
| | 65 | 04/92 → 06/96 | B | F3P704, F3P705, F3P706, F3P707, F3P708, F3P760 |
| | 65 | 04/92 → 12/95 | B | F3P706, F3P707, F3P708, F3P760 |
| | 66 | 04/92 → 12/95 | B | F3P706, F3P760 |
| | 79 | 07/94 → 06/96 | B | F3P682, F3P764, F3P765 |
| | 79 | 05/94 → 12/95 | B | F3P682, F3P765 |
| | 81 | 04/92 → 05/94 | B | F3P700 |
| 1.8 16V | 99 | 04/92 → 12/95 | B | F7P704 |
| 1.9 D | 48 | 03/92 → 12/95 | D | F8Q706, F8Q742 |
| | 47 | 04/92 → 12/95 | D | F8Q742 |
| 1.9 dT | 68 | 03/92 → 12/95 | D | F8Q740 |
| | 66 | 04/92 → 12/95 | D | F8Q744 |

21, Station Wagon

| | | | | |
|-------|----|---------------|---|-------------------|
| 1.7 | 65 | 06/86 → 04/95 | B | F2N710 |
| | 54 | 06/86 → 06/93 | B | F2N750, F3N726 |
| | 54 | 09/89 → 10/92 | B | F3N726 |
| | 55 | 06/86 → 03/93 | B | F2N712 |
| | 65 | 03/86 → 03/93 | B | F2N710 |
| | 66 | 09/89 → 06/94 | B | F3N722, F3N723 |
| 1.9 D | 69 | 03/86 → 02/94 | B | F3N722, F3N723 |
| | 47 | 06/86 → 08/94 | D | F8Q710 |
| | 47 | 09/89 → 01/94 | D | F8Q710 |

Clio I

| | | | | |
|---------|----|---------------|---|-------------------|
| 1.7 | 68 | 01/91 → 12/93 | B | F2N770 |
| 1.8 | 70 | 01/91 → 09/98 | B | F3P710 |
| | 65 | 01/91 → 09/98 | B | F3P710, F3P714 |
| | 66 | 08/94 → 09/98 | B | F3P754, F3P755 |
| 1.8 16V | 99 | 01/91 → 03/96 | B | F7P722 |

81574
350981574000

KW

RENAULT
Clio I

| | | | | |
|----------|-----|---------------|---|-------------------|
| 1.8 Rsi | 79 | 08/95 → 09/98 | B | F3P758 |
| | 80 | 01/93 → 08/95 | B | F3P712 |
| 1.9 D | 40 | 01/97 → 09/98 | D | F8Q678 |
| | 48 | 01/91 → 09/98 | D | F8Q730, F8Q732 |
| | 47 | 01/91 → 09/98 | D | F8Q730, F8Q732 |
| 1.9 RND | 40 | 04/96 → 02/98 | D | F8Q678 |
| Williams | 108 | 01/94 → 09/98 | B | F7R700 |

Clio II

| | | | | |
|---------------|-----|---------------|---|-------------------|
| 1.9 D | 47 | 09/98 → 05/05 | D | F8Q630 |
| | 48 | 02/00 → 05/01 | D | F8Q630, F8Q632 |
| | 48 | 02/00 → 05/01 | D | F8Q632 |
| 1.9 dTi | 59 | 12/99 → 05/05 | D | F9Q780 |
| 2.0 16V Sport | 132 | 01/04 → | B | F4R738 |
| | 124 | 02/00 → | B | F4R730, F4R736 |

Espace III

| | | | | |
|---------|-----|---------------|---|--|
| 1.9 dTi | 72 | 02/99 → 10/02 | D | F9Q722 |
| 2.0 | 102 | 09/01 → 10/02 | B | F4R700, F4R701 |
| | 84 | 11/96 → 10/00 | B | F3R728, F3R729, F3R742, F3R768, F3R769 |
| 2.0 16V | 103 | 10/98 → 10/02 | B | F4R700, F4R701 |

Kangoo I, Van

| | | | | |
|-------------|----|---------------|---|-------------------|
| 1.9 D | 48 | 09/99 → 06/03 | D | F8Q632 |
| 1.9 dCi | 62 | 07/03 → | D | F9Q782, F9Q790 |
| | 62 | 10/03 → | D | F9Q790 |
| 1.9 dCi 4x4 | 59 | 10/01 → | D | F9Q782, F9Q790 |
| | 62 | 07/03 → | D | F9Q790 |
| | 59 | 02/00 → | D | F9Q780 |
| 1.9 dTi | 59 | 02/00 → | D | F9Q780, F9Q782 |
| | 48 | 09/99 → 06/01 | D | F8Q630, F8Q632 |
| D 55 1.9 | 40 | 08/97 → | D | F8Q662 |
| D 65 1.9 | 47 | 08/97 → | D | F8Q630, F8Q632 |

81574
350981574000

KW

RENAULT
Laguna I, Grantour

| | | | | | |
|---------|-----|---------------|---|------------------------------|--|
| 1.8 | 69 | 06/95 → 02/01 | B | F3P674 | |
| | 70 | 06/95 → 06/98 | B | F3P676 | |
| | 66 | 08/95 → 03/01 | B | F3P670, F3P678 | |
| | 66 | 11/93 → 03/01 | B | F3P720, F3P724 | |
| 1.8 16V | 69 | 08/95 → 03/01 | B | F3P720, F3P724 | |
| | 88 | 04/98 → 03/01 | B | F4P760 | |
| 1.8 16V | 88 | 04/98 → 03/01 | B | F4P760, F4P770 | |
| | 72 | 10/97 → 03/01 | D | F9Q710, F9Q716, F9Q717 | |
| 2.0 | 70 | 11/93 → 03/01 | B | | |
| | 80 | 03/99 → 03/01 | B | F3R611 | |
| | 84 | 06/95 → 02/01 | B | F3R722, F3R768 | |
| | 84 | 10/98 → 01/01 | B | F3R728, F3R768 | |
| | 83 | 11/93 → 03/01 | B | F3R722, F3R723 | |
| | 102 | 09/99 → 02/01 | B | F4R780 | |

Master II

1.9 dTi 59 09/00 → D F9Q770

Megane I, Coach, Cabrio, Scénic, Station Wagon

| | | | | | |
|-----------|----|---------------|---|-------------------|--|
| 1.8 16V | 85 | 01/01 → 08/03 | B | F4P720, F4P722 | |
| 1.9 D | 69 | 04/96 → 02/01 | D | F8Q784 | |
| | 47 | 09/96 → 08/03 | D | F8Q620, F8Q624 | |
| | 47 | 04/99 → 08/03 | D | F8Q622, F8Q790 | |
| 1.9 D | 47 | 03/97 → 09/99 | D | F8Q790 | |
| | 47 | 01/96 → 08/03 | D | F8Q620, F8Q624 | |
| 1.9 D Eco | 47 | 01/96 → 08/03 | D | F8Q620, F8Q624 | |
| 1.9 dCi | 77 | 03/99 → 09/00 | D | F9Q733 | |
| 1.9 dT | 66 | 01/96 → 08/03 | D | F8Q784, F8Q786 | |
| 1.9 DTi | 60 | 02/00 → 09/00 | D | F9Q730 | |

81574
350981574000

KW

RENAULT
Megane I, Coach, Cabrio, Scénic, Station Wagon

| | | | | | |
|-------------|-----|---------------|---|--|-----------|
| 1.9 dTi | 59 | 02/01 → 08/03 | D | F9Q744 | |
| | 72 | 03/97 → 02/01 | D | F9Q730, F9Q731, F9Q734, F9Q736 | |
| | 72 | 04/97 → 09/99 | D | F9Q730, F9Q734 | |
| | 72 | 03/97 → 02/01 | D | F9Q731, F9Q734, F9Q736 | |
| 1.9 dTi | 72 | 03/99 → 02/01 | D | F9Q731, F9Q736 | |
| | 69 | 09/96 → 08/03 | D | F8Q784 | 10-1996 → |
| 1.9 TDI | 69 | 09/96 → 08/03 | D | F8Q784 | |
| | 84 | 04/97 → 08/03 | B | F3R750, F3R798 | |
| 2.0 16V | 102 | 01/02 → 08/03 | B | F4R746 | |
| | 102 | 01/02 → 08/03 | B | F4R746, F4R770 | |
| | 108 | 07/96 → 08/03 | B | F7R710, F7R714 | |
| 2.0 16V IDE | 103 | 11/99 → 08/03 | B | F4R746, F5R740 | |
| | 103 | 11/99 → 08/03 | B | F5R740 | |
| 2.0 i | 80 | 03/99 → 08/03 | B | F3R750, F3R751 | |
| | 80 | 03/99 → 08/03 | B | F3R791, F3R796 | |
| | 80 | 03/99 → 08/03 | B | F3R750, F3R751, F3R752, F3R791, F3R796, F3R797, F3R798 | |
| | 80 | 03/99 → 08/03 | B | F3R791, F3R796 | |
| 2.0 i | 80 | 01/99 → 09/99 | B | F3R796 | |
| | 84 | 01/96 → 08/03 | B | F3R750, F3R751 | |
| | 84 | 09/96 → 08/03 | B | F3R750, F3R751, F3R752, F3R791, F3R796, F3R797, F3R798 | |
| 2.0 i | 84 | 03/96 → 08/03 | B | F3R750, F3R751, F3R798 | |

81574 **350981574000**

KW

RENAULT
Megane I, Coach, Cabrio, Scénic, Station Wagon

2.0RXE 4x4 84 05/97 → 10/99 B F3R750

Rapid

40 09/93 → 04/95 D F8M736

1.6 D 40 03/86 → 08/98 D F8M720, F8M730, F8M736, F8M760

1.9 D 40 09/94 → 03/98 D F8Q640, F8Q682

1.9 D 47 09/91 → 03/98 D F8Q646, F8Q722, F8Q724, F8Q774, F8Q776

Scénic I

1.6 75 03/01 → 08/03 B K4M708, K4M709

1.8 16V 85 01/01 → 08/03 B F4P720, F4P722

1.8 4x4 85 07/00 → 04/01 B F4P722

1.9 D 47 09/99 → 03/01 D F8Q790

1.9 dCi 75 09/99 → 08/03 D F9Q732, F9Q733

1.9 dCi RX4 74 12/02 → 08/03 D F9Q732, F9Q748, F9Q796

75 11/00 → 08/03 D F9Q740

59 02/01 → 08/03 D F9Q744

1.9 dTi 72 09/99 → 08/03 D F9Q731, F9Q734, F9Q736

2.0 16V 103 09/99 → 08/03 B F4R740, F4R741, F4R744, F4R747 10-1996 →

2.0 16V 102 07/00 → 08/03 B F4R740, F4R741, F4R746

2.0 16V RX4 102 06/00 → 08/03 B F4R744, F4R746

Sport Spider

2.0 16V 110 03/95 → 10/99 B F7R710

81574
350981574000

KW

RENAULT
Super 5

40 10/84 → 12/96 D F8M720

1.6 D 40 08/85 → 12/96 D F8M720, F8M730

1.7 54 10/86 → 03/95 B F3N716, F3N717

1.7 64 06/87 → 03/95 B F2N740, F2N742

1.7 i 69 10/86 → 08/91 B F3N702, F3N722

Thalia I

1.9 D 48 02/98 → 05/01 D F8Q630

2.0 124 09/01 → B F4R738

Trafic I

1.7 50 08/92 → 08/94 B F1N720 01-1986 →, → 12-1995

1.7 50 08/92 → 08/94 B F1N724 01-1986 →, → 12-1995

1.9 D 44 06/97 → 03/01 D F8Q606

VOLVO
340 - 360

1.6 Diesel 40 08/84 → 07/91 D D16

1.7 59 08/85 → 07/91 B B172K

440

1.6 61 09/88 → 12/96 B B16F

64 09/88 → 12/96 B B18KP

1.7 75 08/89 → 12/96 B B18FP

78 09/88 → 12/96 B B18EP

1.7 Turbo 88 08/88 → 07/96 B B18FT

90 01/91 → 12/96 B B18FT

1.8 66 08/91 → 12/96 B B18U

1.9 Turbo-Diesel 66 07/94 → 12/96 D D19T

2.0 80 08/93 → 07/96 B B20F

81 08/92 → 07/95 B B20F

460

1.6 61 07/92 → 07/96 B B16F

64 09/88 → 07/96 B B18KP

1.7 66 09/90 → 07/96 B B18KP

75 08/89 → 07/92 B B18EP

80 08/89 → 07/92 B B18E

1.7 Turbo 88 08/89 → 07/96 B B18FT

90 01/91 → 07/96 B B18FT

1.8 66 08/91 → 07/96 B B18U

81574
350981574000

KW

VOLVO
460

| | | | | | |
|------------------|----|---------------|---|------|--|
| 1.9 Turbo-Diesel | 66 | 07/94 → 07/96 | D | D19T | |
| 2.0 | 80 | 08/93 → 07/96 | B | B20F | |
| | 81 | 08/92 → 07/95 | B | B20F | |

480

| | | | | | |
|-----------|----|---------------|---|-------|--|
| 1.7 | 75 | 08/89 → 07/96 | B | B18EP | |
| 1.7 Turbo | 88 | 08/87 → 07/96 | B | B18FT | |
| | 90 | 01/91 → 07/96 | B | B18FT | |
| 2.0 | 81 | 08/92 → 09/95 | B | B20F | |

S 40 I

| | | | | | |
|--------|----|---------------|---|---------|-----------|
| 1.9 DI | 70 | 03/99 → 07/00 | D | D4192T2 | |
| 1.9 TD | 66 | 07/95 → 08/99 | D | D4192T | 01-1997 → |

V 40 I

| | | | | | |
|--------|----|---------------|---|---------|--|
| 1.9 DI | 70 | 03/99 → 07/00 | D | D4192T2 | |
| 1.9 TD | 66 | 07/95 → 08/99 | D | D4192T | |

81576
350981576000

ALBERINO

| | |
|-------------------|------|
| Diametro Alberino | Ø18 |
| Posizione Attacco | 56.5 |
| Diametro Girante | Ø69 |
| N° Alette Girante | 9 |
| Posizione Girante | 17.3 |



KW

RENAULT
Espace I

| | | | | | |
|--------------|----|---------------|---|------------------------------|--|
| 2.0 | 74 | 01/88 → 12/90 | B | J6R734 | |
| | 80 | 07/84 → 12/90 | B | J6R234, J6R236 | |
| 2.0 i | 87 | 01/89 → 12/90 | B | J7R760 | |
| 2.0 i Quadra | 87 | 03/88 → 12/92 | B | J7R760 | |
| 2.1 TD | 65 | 10/84 → 12/90 | D | J8S240, J8S774, J8S776 | |
| 2.2 | 79 | 07/86 → 12/90 | B | J7T770 | |
| 2.2 Quadra | 79 | 01/88 → 12/90 | B | J7T770 | |

Master I

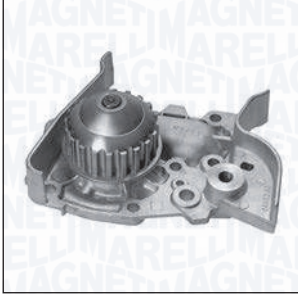
| | | | | | |
|-------------|----|---------------|---|--------|--|
| 28-35 2.1 D | 44 | 08/80 → 07/98 | D | J8S330 | |
|-------------|----|---------------|---|--------|--|

81578
350981578000

PULEGGIA

| | |
|----------------------------|--------|
| Diametro Puleggia | Ø59.26 |
| Numero Denti/Gole Puleggia | 20 |
| Altezza Puleggia | 20.8 |
| Posizione Attacco | 46.1 |
| Diametro Girante | Ø60 |
| N° Alette Girante | 6 |
| Posizione Girante | 19.5 |

KW

DACIA
Solenza

| | | | | | |
|-----|----|---------|---|--------|--|
| 1.4 | 55 | 02/03 → | B | K7J710 | |
|-----|----|---------|---|--------|--|

RENAULT
Clio II

| | | | | | |
|-----|----|---------------|---|------------------------------|--|
| 1.4 | 55 | 09/98 → 05/05 | B | E7J634, E7J780, K7J700 | |
| | | | | | |

Kangoo I, Van

| | | | | | |
|-----|----|---------|---|--|---|
| 1.4 | 55 | 08/97 → | B | E7J634, E7J635, E7J780, K7J700, K7J701 | M: E7J 634, M: E7J 780, M: E7J 635, M: E7J 634 |
| | 55 | 08/97 → | B | E7J634, E7J635, E7J780, K7J701 | M: E7J 634, M: E7J 780, M: E7J 635, M: E7J 634 |

Megane I, Coach, Cabrio, Scénic, Station Wagon

| | | | | | |
|---------|----|---------------|---|-------------------|--|
| 1.4 | 55 | 09/96 → 08/03 | B | E7J626, E7J764 | |
| | 55 | 03/99 → 08/03 | B | E7J626 | |
| 1.4 e | 55 | 01/96 → 08/03 | B | E7J626, E7J764 | |
| | | | | | |
| 1.4 Eco | 52 | 01/96 → 03/99 | B | E7J624 | |
| 1.4 i | 55 | 01/97 → 09/99 | B | E7J764 | |

Rapid

| | | | | | |
|-----|----|---------------|---|---|-----------|
| 1.4 | 55 | 09/91 → 03/98 | B | E7J720, E7J724, E7J726, E7J773 | 01-1996 → |
| | | | | | |

Thalia I

| | | | | | |
|-----|----|---------|---|--------|--|
| 1.4 | 55 | 08/00 → | B | K7J700 | |
|-----|----|---------|---|--------|--|

81579
350981579000

| | | |
|-------------------|----------------------------|--------|
| | PULEGGIA | |
| | Diametro Puleggia | Ø59.26 |
| | Numero Denti/Gole Puleggia | 20 |
| | Altezza Puleggia | 20.8 |
| | Posizione Attacco | 40.6 |
| | Diametro Girante | Ø60.5 |
| | N° Alette Girante | 8 |
| Posizione Girante | 26 | |

KW

DACIA
Logan MCV

| | | | | |
|------------|----|---------|----|--------|
| 1.4 | 55 | 02/07 → | B | K7J710 |
| 1.6 | 64 | 02/07 → | B | K7M710 |
| 1.6 Bifuel | 64 | 11/08 → | BF | K7M710 |

Logan, Station Wagon, Van

| | | | | |
|-------------|----|---------|----|-------------------|
| 1.4 | 55 | 03/09 → | B | K7J710 |
| | 55 | 09/04 → | B | K7J710 |
| 1.4 MPI LPG | 55 | 02/06 → | | K7J710, K7J714 |
| 1.6 | 64 | 03/09 → | B | K7M710 |
| | 64 | 09/04 → | B | K7M710 |
| 1.6 Bifuel | 62 | 05/10 → | BF | K7M718 |

Sandero I

| | | | | |
|-------------|----|---------|---|--------|
| 1.4 | 55 | 06/08 → | B | K7J710 |
| 1.4 MPI LPG | 53 | 01/09 → | | K7J714 |
| 1.6 | 64 | 06/08 → | B | K7M710 |

RENAULT
Clio II

| | | | | |
|-----|----|---------------|---|-------------------|
| 1.6 | 66 | 09/98 → 05/05 | B | K7M744, K7M745 |
|-----|----|---------------|---|-------------------|

Kangoo I, Van

| | | | | | |
|-----|----|---------------|---|--|---------------------------|
| 1.4 | 55 | 08/97 → | B | E7J634, E7J635, E7J780, K7J700, K7J701 | M: K7J 701, M: K7J 700 |
| | 55 | 08/97 → | B | E7J634, E7J635, E7J780, K7J701 | M: K7J 701, M: K7J 700 |
| 1.6 | 66 | 09/99 → 06/01 | B | K7M746 | |

Kangoo II, Be Bop, Van

| | | | | |
|-----|----|---------|---|--------|
| 1.6 | 64 | 02/08 → | B | K7M750 |
| | 64 | 02/08 → | B | K7M750 |

Logan I, Station Wagon

| | | | | |
|-----|----|---------|---|--------|
| 1.4 | 55 | 09/04 → | B | K7J710 |
| 1.6 | 64 | 09/04 → | B | K7M710 |

81579
350981579000

KW

RENAULT
Logan I, Station Wagon, Express

| | | | | |
|-----|----|---------|---|--------|
| 1.4 | 55 | 10/07 → | B | K7J710 |
| 1.6 | 64 | 04/07 → | B | K7M710 |

Megane I, Coach, Cabrio, Scénic, Station Wagon

| | | | | |
|-------|----|---------------|---|------------------------------|
| 1.6 e | 66 | 10/96 → 03/99 | B | K7M702, K7M703 |
| | 66 | 01/96 → 03/99 | B | K7M702, K7M703, K7M790 |
| 1.6 i | 55 | 01/96 → 03/99 | B | K7M720 |

Sandero I

| | | | | |
|-----|----|---------|---|--------|
| 1.4 | 55 | 02/09 → | B | K7J710 |
| 1.6 | 62 | 11/10 → | B | K7M718 |
| | 64 | 02/09 → | B | K7M710 |
| | 75 | 12/07 → | B | K7M710 |
| | 76 | 12/07 → | B | K4M690 |

Thalia I

| | | | | |
|-----|----|---------|---|--------|
| 1.6 | 66 | 03/98 → | B | K7M746 |
|-----|----|---------|---|--------|

81584
350981584000

FLANGIA

| | |
|-------------------------|------------|
| Numero Fori Flangia | 4 |
| Dimensione Fori Flangia | M6×1 |
| Posizione Attacco | 91.5 |
| Diametro Mozzo | M24×1.5 SX |
| Diametro Centraggio | Ø40 |
| Diametro Girante | Ø59 |
| N° Alette Girante | 9 |
| Posizione Girante | 14.5 |

KW

BMW
3 II (E30), Touring, Cabrio

| | | | | | |
|-------|----|---------------|---|---|-----------|
| 316 | 66 | 09/82 → 12/90 | B | M10B18 (184VC), M10B18 (184VD) | → 09-1987 |
| | 73 | 09/87 → 06/91 | B | M40B16 (164E1) | → 09-1988 |
| 316 i | 75 | 07/88 → 06/91 | B | M40B16 (164E1) | → 09-1988 |

81586

350981586000



FLANGIA

| | |
|-------------------------|------------|
| Numero Fori Flangia | 4 |
| Dimensione Fori Flangia | M6×1 |
| Posizione Attacco | 106.5 |
| Diametro Mozzo | M24×1.5 SX |
| Diametro Centraggio | Ø40 |
| Diametro Girante | Ø70 |
| N° Alette Girante | 7 |
| Posizione Girante | 10.5 |



BMW

3 II (E30), Touring, Cabrio

| | | | | | |
|---------|-----|---------------|---|--|-----------|
| 320 i | 95 | 04/86 → 10/93 | B | M20B20 (206KA) | → 09-1987 |
| | 110 | 12/85 → 06/90 | B | M20B20 (206KA) | → 09-1987 |
| | 95 | 12/85 → 06/91 | B | M20B20 (206KA), M20B20 (L-Jetronic) | → 09-1987 |
| 325 i | 125 | 12/86 → 06/91 | B | M20B25 (256E1), M20B25 (256E2), M20B25 (256EX), M20B25 (256K1) | → 09-1987 |
| 325 i X | 125 | 12/86 → 08/91 | B | M20B25 (256E1), M20B25 (256E2), M20B25 (256EX), M20B25 (256K1) | → 09-1987 |
| M3 2.3 | 143 | 06/88 → 06/91 | B | S14B23 (234EA) | |
| | 143 | 07/86 → 06/91 | B | S14B23 (234EA), S14B23 (234S1), S14B23 (234S2) | |
| | 158 | 06/89 → 06/91 | B | S14B23 (234EA) | |

81587

350981587000



FLANGIA

| | |
|-------------------------|------------|
| Numero Fori Flangia | 4 |
| Dimensione Fori Flangia | M6×1 |
| Posizione Attacco | 54.5 |
| Diametro Mozzo | M24×1.5 SX |
| Diametro Centraggio | Ø38 |
| Diametro Girante | Ø62 |
| N° Alette Girante | 7 |
| Posizione Girante | 64.3 |



BMW

3 II (E30), Touring, Cabrio

| | | | | | |
|-----------------------------|-----|---------------|---|--------------------------------|----------------------|
| 316 | 66 | 09/82 → 12/90 | B | M10B18 (184VC), M10B18 (184VD) | 10-1987 → |
| | 73 | 09/87 → 06/91 | B | M40B16 (164E1) | 10-1988 → |
| | 73 | 09/91 → 06/94 | B | M40B16 (164E1) | |
| 316 i | 75 | 07/88 → 06/91 | B | M40B16 (164E1) | 10-1988 → |
| | 75 | 09/91 → 06/94 | B | M40B16 (164E1) | |
| 318 i | 83 | 09/87 → 06/91 | B | M40B18 (184E1) | |
| | 83 | 04/89 → 06/94 | B | M40B18 (184E1) | M: M40B16 |
| | 85 | 09/87 → 06/91 | B | M40B18 (184E1) | |
| | 103 | 06/88 → 02/92 | B | M40B18C | |
| 5 III (E34), Touring | | | | | |
| 518 i | 83 | 08/89 → 09/95 | B | M40B18 (184E1) | 04-1989 →, → 08-1991 |
| | 85 | 08/89 → 09/95 | B | M43B18 (184E2) | → 09-1991, DST:CND |

81588
350981588000

FLANGIA

Numero Fori Flangia 4
 Dimensione Fori Flangia M6×1
 Posizione Attacco 47.7
 Diametro Mozzo M24×1.5 SX
 Diametro Centraggio Ø40
 Diametro Girante Ø74
 N° Alette Girante 7
 Posizione Girante 60.55

KW

BMW
3 III (E36), Touring, Cabrio, Coupé, Compact

| | | | | | |
|-----------|-----|---------------|---|--|-----------|
| 320 i | 110 | 09/90 → 02/98 | B | M50B20, M50B20 (206S1), M50B20 (206S2), M50B20TU, M52B20, M52B20 (206S3) | |
| | 110 | 12/93 → 04/99 | B | M50B20, M50B20 (206S2), M50B20TU, M52B20, M52B20 (206S3) | |
| | 110 | 01/95 → 10/99 | B | M50B20, M50B20TU, M52B20, M52B20 (206S3) | |
| 323 i | 125 | 03/95 → 04/99 | B | M52B25 (256S3) | 04-1995 → |
| | 125 | 06/95 → 04/99 | B | M52B25 (256S3) | |
| 323 i 2.5 | 125 | 03/95 → 02/98 | B | M52B25 (256S3) | 04-1995 → |
| 323 ti | 125 | 08/97 → 08/00 | B | M52B25 (256S3) | |
| 325 i | 141 | 09/90 → 09/95 | B | M50B25 (256S1), M50B25 (256S2), M50B25TU | |
| | 141 | 03/93 → 03/95 | B | M50B25 (256S2), M50B25TU | |
| 328 i | 142 | 01/95 → 02/98 | B | M52B28 (286S1), M52B28TU | |

81588
350981588000

KW

BMW
3 IV (E46), Touring, Cabrio, Coupé, Compact

| | | | | | |
|--------|-----|---------------|---|--------------------------------|------|
| 320 Ci | 110 | 08/99 → 09/00 | B | M52B20, M52B20 (206S4) | C: M |
| | 120 | 01/06 → 12/07 | B | M54B22 (226S1) | |
| | 125 | 09/00 → 12/07 | B | M54226S1, M54B22 (226S1) | |
| | 125 | 09/00 → 07/06 | B | M54B22, M54B22 (226S1) | |
| 320 i | 110 | 03/98 → 09/00 | B | M52B20, M52B20 (206S4) | |
| | 125 | 09/00 → 02/05 | B | M54B22, M54B22 (226S1) | |
| 323 Ci | 125 | 04/00 → 09/00 | B | M52B25 (256S4) | |
| 323 i | 125 | 03/98 → 09/00 | B | M52B25 (256S4), M52B25TU | |
| 325 Ci | 141 | 09/00 → 07/06 | B | M54256S5, M54B25 (256S5) | |
| | 141 | 09/00 → 12/07 | B | M54256S5, M54B25 (256S5) | |
| 325 i | 141 | 09/00 → 02/05 | B | M54B25, M54B25 (256S5) | |
| 325 ti | 141 | 06/01 → 02/05 | B | M54B25, M54B25 (256S5) | |
| 325 xi | 141 | 09/00 → 02/05 | B | M54256S5, M54B25 (256S5) | |
| 328 Ci | 142 | 04/99 → 06/00 | B | M52B28 (286S2) | |
| 328 i | 142 | 02/98 → 06/00 | B | M52B28 (286S2) | |
| 330 Ci | 170 | 06/00 → 12/07 | B | M54306S3, M54B30 (306S3) | |

81588
350981588000

KW

BMW
3 IV (E46), Touring, Cabrio, Coupé, Compact

| | | | | |
|--------|-----|---------------|---|------------------------------|
| 330 Ci | 170 | 06/00 → 07/06 | B | M54B30 (306S3) |
| 330 i | 170 | 06/00 → 02/05 | B | M54B30, M54B30 (306S3) |
| 330 xi | 170 | 06/00 → 02/05 | B | M54B30 (306S3) |

5 III (E34), Touring

| | | | | |
|------------|-----|---------------|---|---|
| 520 i | 110 | 11/91 → 01/97 | B | M50B20, M50B20 (206S1), M50B20 (206S2), M50B20TU |
| 520 i 24V | 110 | 09/89 → 09/95 | B | M50B20, M50B20 (206S1), M50B20 (206S2), M50B20TU |
| 525 i | 141 | 11/91 → 01/97 | B | M50B25 (256S1), M50B25 (256S2) |
| 525 i 24V | 141 | 09/89 → 09/95 | B | M50B25 (256S2), M50B25TU, M52B25 (Vanos) |
| 525 ix | 141 | 02/92 → 01/97 | B | M50B25 (256S1), M50B25 (256S2) |
| 525 ix 24V | 141 | 10/91 → 09/95 | B | M50B25 (256S1), M50B25 (256S2) |

5 IV (E39), Touring

| | | | | |
|-------|-----|---------------|---|--|
| 520 i | 100 | 04/99 → 06/03 | B | M52B20 (206S3) |
| | 110 | 01/96 → 09/00 | B | M52B (206S4), M52B20, M52B20 (206S3) |
| | 125 | 09/00 → 06/03 | B | M54B22 (226S1) |
| | 125 | 09/00 → 05/04 | B | M54B22, M54B22 (226S1) |

81588
350981588000

KW

BMW
5 IV (E39), Touring

| | | | | |
|-------|-----|---------------|---|---|
| 523 i | 125 | 11/95 → 09/00 | B | M52B25 (256S3), M52B25TU |
| 525 i | 141 | 09/00 → 05/04 | B | M54256S5, M54B25, M54B25 (256S5) |
| | 141 | 09/00 → 06/03 | B | M54B25, M54B25 (256S5) |
| 528 i | 142 | 11/95 → 09/00 | B | M52B28 (286S1), M52B28 (286S2) |
| 530 i | 170 | 09/00 → 05/04 | B | M54B30 (306S3) |
| 530 i | 170 | 09/00 → 06/03 | B | M54B30, M54B30 (306S3) |

5 V (E60), Touring (E61)

| | | | | |
|-------|-----|---------------|---|---|
| 520 i | 125 | 07/03 → 03/10 | B | M54B22, M54B22 (226S1) |
| 525 i | 141 | 09/03 → 03/10 | B | M54256S5, M54B25, M54B25 (256S5) |
| | 141 | 06/04 → 12/10 | B | M54B25, M54B25 (256S5) |
| 530 i | 170 | 07/03 → 03/10 | B | M54306S3, M54B30, M54B30 (306S3) |

7 III (E38)

| | | | | |
|----------|-----|---------------|---|---|
| 728 i,iL | 142 | 08/95 → 11/01 | B | M52B28 (286S1), M52B28 (286S2) |
| 728i X | 142 | 11/95 → 09/01 | B | M52B28 (286S1), M52B28TU |

81588 350981588000

BMW
7 IV (E65, E66)

| | | | | | |
|----------|-----|---------------|---|------------------------------|--|
| 730 i,Li | 170 | 03/03 → 07/08 | B | M54B30, M54B30 (306S3) | |
|----------|-----|---------------|---|------------------------------|--|

X3 I (E83)

| | | | | | |
|-------|-----|---------------|---|---|--|
| 2.5 i | 141 | 01/04 → 08/06 | B | M54256S5, M54B25, M54B25 (256S5) | |
|-------|-----|---------------|---|---|--|

| | | | | | |
|--------------|-----|---------------|---|---|--|
| 3.0 i xDrive | 170 | 01/04 → 08/06 | B | M54306S3, M54B30, M54B30 (306S3) | |
|--------------|-----|---------------|---|---|--|

X5 I (E53)

| | | | | | |
|-------|-----|---------------|---|-------------------|--|
| 3.0 i | 163 | 05/00 → 12/06 | B | M54B30 (306S3) | |
|-------|-----|---------------|---|-------------------|--|

| | | | | | |
|--|-----|---------------|---|---|--|
| | 170 | 05/00 → 12/06 | B | M54306S3, M54B30, M54B30 (306S3) | |
|--|-----|---------------|---|---|--|

Z3 (E36), Coupé

| | | | | | |
|-----|-----|---------------|---|------------------------------|-----------|
| 2.0 | 110 | 04/99 → 01/03 | B | M52B20, M52B20 (206S4) | 04-1999 → |
|-----|-----|---------------|---|------------------------------|-----------|

| | | | | | |
|-----|-----|---------------|---|---|--|
| 2.2 | 125 | 08/00 → 01/03 | B | M54226S1, M54B22, M54B22 (226S1) | |
|-----|-----|---------------|---|---|--|

| | | | | | |
|-----|-----|---------------|---|-------------------|--|
| 2.8 | 141 | 07/97 → 06/00 | B | M52B28 (286S1) | |
|-----|-----|---------------|---|-------------------|--|

| | | | | | |
|-----|-----|---------------|---|--------------------------------|--|
| 2.8 | 141 | 04/97 → 06/00 | B | M52B28 (286S1), M52B28TU | |
|-----|-----|---------------|---|--------------------------------|--|

| | | | | | |
|-----|-----|---------------|---|--------------------------------|--|
| 3.0 | 170 | 06/00 → 06/03 | B | M54306S3, M54B30 (306S3) | |
|-----|-----|---------------|---|--------------------------------|--|

| | | | | | |
|--|-----|---------------|---|------------------------------|--|
| | 170 | 06/00 → 01/03 | B | M54B30, M54B30 (306S3) | |
|--|-----|---------------|---|------------------------------|--|

Z4 I (E85), Coupé (E86)

| | | | | | |
|-------|-----|---------------|---|------------------------------|--|
| 2.2 i | 125 | 10/03 → 10/05 | B | M54B22, M54B22 (226S1) | |
|-------|-----|---------------|---|------------------------------|--|

81588 350981588000

BMW
Z4 I (E85), Coupé (E86)

| | | | | | |
|-------|-----|---------------|---|------------------------------|--|
| 2.5 i | 141 | 02/03 → 12/05 | B | M54B25, M54B25 (256S5) | |
|-------|-----|---------------|---|------------------------------|--|

| | | | | | |
|-------|-----|---------------|---|------------------------------|--|
| 3.0 i | 170 | 02/03 → 10/05 | B | M54B30, M54B30 (306S3) | |
|-------|-----|---------------|---|------------------------------|--|

81589 350981589000

| | | |
|--|-------------------------|------------|
| | FLANGIA | |
| | Numero Fori Flangia | 4 |
| | Dimensione Fori Flangia | M6×1 |
| | Posizione Attacco | 56 |
| | Diametro Mozzo | M24×1.5 SX |
| | Diametro Centraggio | Ø38 |
| | Diametro Girante | Ø62 |
| | N° Alette Girante | 7 |
| | Posizione Girante | 59.5 |

BMW
3 III (E36), Touring, Cabrio, Coupé, Compact

| | | | | | |
|-------|----|---------------|---|-------------------|-----------|
| 316 i | 73 | 09/90 → 09/93 | B | M40B16 (164E1) | M: M40B16 |
|-------|----|---------------|---|-------------------|-----------|

| | | | | | |
|--|----|---------------|---|------------------------------|--|
| | 75 | 09/90 → 09/93 | B | M43B16, M43B16 (164E2) | |
|--|----|---------------|---|------------------------------|--|

| | | | | | |
|-------|----|---------------|---|-------------------|-----------|
| 318 i | 83 | 12/90 → 10/93 | B | M40B18 (184E1) | M: M40B16 |
|-------|----|---------------|---|-------------------|-----------|

5 III (E34), Touring

| | | | | | |
|-------|----|---------------|----|-------------------|--|
| 518 g | 85 | 11/95 → 06/96 | BF | M43B18 (184E2) | |
|-------|----|---------------|----|-------------------|--|

| | | | | | |
|-------|----|---------------|---|-------------------|--|
| 518 i | 83 | 03/93 → 09/94 | B | M43B18 (184E2) | |
|-------|----|---------------|---|-------------------|--|

| | | | | | |
|--|----|---------------|---|-------------------|-----------------------|
| | 85 | 08/89 → 09/95 | B | M43B18 (184E2) | 10-1991 →, DST:CND |
|--|----|---------------|---|-------------------|-----------------------|

| | | | | | |
|--|----|---------------|---|-------------------|-----------|
| | 85 | 09/94 → 01/97 | B | M43B18 (184E2) | → 12-1995 |
|--|----|---------------|---|-------------------|-----------|

81590
350981590000

FLANGIA

Numero Fori Flangia 4
 Dimensione Fori Flangia M6×1
 Posizione Attacco 56.5
 Diametro Mozzo M24×1.5 SX
 Diametro Centraggio Ø38
 Diametro Girante Ø62
 N° Alette Girante 7
 Posizione Girante 59.5

KW

BMW
3 II (E30), Touring, Cabrio

| | | | | | |
|--------|-----|---------------|---|----------------|--|
| 318 is | 100 | 09/89 → 08/91 | B | M42B18 (184S1) | |
|--------|-----|---------------|---|----------------|--|

3 III (E36), Touring, Cabrio, Coupé, Compact

| | | | | | |
|-------|----|---------------|----|----------------|--|
| 316 g | 75 | 03/94 → 08/00 | BF | M43B16 (164E2) | |
|-------|----|---------------|----|----------------|--|

| | | | | | |
|-------|----|---------------|---|----------------|-------------------|
| 316 i | 73 | 09/90 → 09/93 | B | M40B16 (164E1) | M: M43B16 / C / K |
|-------|----|---------------|---|----------------|-------------------|

| | | | | | |
|--|----|---------------|---|----------------|--|
| | 75 | 07/93 → 02/98 | B | M43B16 (164E2) | |
|--|----|---------------|---|----------------|--|

| | | | | | |
|--|----|---------------|---|----------------|-------------------|
| | 75 | 03/94 → 08/00 | B | M43B16 (164E2) | M: M43B16 / C / K |
|--|----|---------------|---|----------------|-------------------|

| | | | | | |
|--|----|---------------|---|----------------|--|
| | 77 | 12/98 → 08/00 | B | M43B19 (194E1) | |
|--|----|---------------|---|----------------|--|

| | | | | | |
|-------|----|---------------|---|----------------|-----------|
| 318 i | 85 | 10/93 → 02/98 | B | M43B18 (184E2) | M: M40B16 |
|-------|----|---------------|---|----------------|-----------|

| | | | | | |
|--|----|---------------|---|----------------|------------|
| | 85 | 01/94 → 04/99 | B | M43B18 (184E2) | M: M43B19C |
|--|----|---------------|---|----------------|------------|

| | | | | | |
|--|----|---------------|---|----------------|---------------|
| | 85 | 07/95 → 10/99 | B | M43B18 (184E2) | M: M43B18 / C |
|--|----|---------------|---|----------------|---------------|

| | | | | | |
|--------|-----|---------------|---|----------------|--|
| 318 is | 103 | 03/93 → 02/98 | B | M42B18 (184S1) | |
|--------|-----|---------------|---|----------------|--|

| | | | | | |
|--|-----|---------------|---|----------------|--|
| | 103 | 09/95 → 02/98 | B | M44B19 (194S1) | |
|--|-----|---------------|---|----------------|--|

| | | | | | |
|--------|-----|---------------|---|----------------|--|
| 318 ti | 103 | 11/94 → 08/95 | B | M42B18 (184S1) | |
|--------|-----|---------------|---|----------------|--|

| | | | | | |
|--|-----|---------------|---|----------------|---------------|
| | 103 | 07/95 → 08/00 | B | M44B19 (194S1) | M: M44B19 / C |
|--|-----|---------------|---|----------------|---------------|

| | | | | | |
|--|-----|---------------|---|----------------|---------------|
| | 103 | 07/95 → 08/00 | B | M44B19 (194S1) | M: M44B19 / C |
|--|-----|---------------|---|----------------|---------------|

3 IV (E46), Touring, Cabrio, Coupé, Compact

| | | | | | |
|--------|----|---------------|---|----------------|-----------|
| 316 Ci | 77 | 04/00 → 07/06 | B | M43B16 (164E3) | → 06-2001 |
|--------|----|---------------|---|----------------|-----------|

| | | | | | |
|-------|----|---------------|---|------------------------|--|
| 316 i | 77 | 04/00 → 02/05 | B | M43B16, M43B16 (164E3) | |
|-------|----|---------------|---|------------------------|--|

| | | | | | |
|-------|----|---------------|---|--------------------------|--|
| 316 i | 77 | 09/98 → 02/05 | B | M43B19 (194E1), M43B19TU | |
|-------|----|---------------|---|--------------------------|--|

81590
350981590000

KW

BMW
3 IV (E46), Touring, Cabrio, Coupé, Compact

| | | | | | |
|--------|----|---------------|---|----------------|--|
| 318 Ci | 87 | 11/99 → 09/01 | B | M43B19 (194E1) | |
|--------|----|---------------|---|----------------|--|

| | | | | | |
|-------|----|---------------|---|----------------|--|
| 318 i | 85 | 10/99 → 09/01 | B | M43B19 (194E1) | |
|-------|----|---------------|---|----------------|--|

| | | | | | |
|--|----|---------------|---|--------------------------|--|
| | 87 | 02/98 → 09/01 | B | M43B19 (194E1), M43B19TU | |
|--|----|---------------|---|--------------------------|--|

5 III (E34), Touring

| | | | | | |
|-------|----|---------------|---|----------------|--------------------|
| 518 i | 85 | 08/89 → 09/95 | B | M43B18 (184E2) | 01-1993 →, DST:CTN |
|-------|----|---------------|---|----------------|--------------------|

Z3 (E36), Coupé

| | | | | | |
|-----|----|---------------|---|----------------|-----------|
| 1.8 | 85 | 10/95 → 10/98 | B | M43B18 (184E2) | M: M42B18 |
|-----|----|---------------|---|----------------|-----------|

| | | | | | |
|-----|----|---------------|---|--------------------------|-------------|
| 1.9 | 85 | 01/99 → 01/03 | B | M43194E1, M43B19 (194E1) | M: M44B19 C |
|-----|----|---------------|---|--------------------------|-------------|

| | | | | | |
|--|----|---------------|---|------------------------------------|--|
| | 87 | 07/98 → 01/03 | B | M43194E1, M43B19 (194E1), M43B19TU | |
|--|----|---------------|---|------------------------------------|--|

| | | | | | |
|--|-----|---------------|---|----------------|-------------|
| | 103 | 10/95 → 03/99 | B | M44B19 (194S1) | M: M44B19 C |
|--|-----|---------------|---|----------------|-------------|

| | | | | | |
|--|-----|---------------|---|----------------|-------------|
| | 103 | 10/95 → 03/99 | B | M44B19 (194S1) | M: M44B19 C |
|--|-----|---------------|---|----------------|-------------|

| | | | | | |
|--|-----|---------------|---|----------------|-------------|
| | 103 | 10/95 → 03/99 | B | M44B19 (194S1) | M: M44B19 C |
|--|-----|---------------|---|----------------|-------------|

| | | | | | |
|--|-----|---------------|---|----------------|-------------|
| | 103 | 10/95 → 03/99 | B | M44B19 (194S1) | M: M44B19 C |
|--|-----|---------------|---|----------------|-------------|

81592
350981592000

FLANGIA

Numero Fori Flangia 4
 Dimensione Fori Flangia M6×1
 Posizione Attacco 131.5
 Diametro Girante Ø70
 N° Alette Girante 6
 Posizione Girante -0.5

KW

VOLVO
740, Station Wagon

| | | | | | |
|-----|----|---------------|---|-------------|--|
| 2.3 | 84 | 08/84 → 07/90 | B | B230F, B23A | |
|-----|----|---------------|---|-------------|--|

81593
350981593000

| | | |
|-------------------|----------------------------|--------|
| | PULEGGIA | |
| | Diametro Puleggia | Ø59.17 |
| | Numero Denti/Gole Puleggia | 20 |
| | Altezza Puleggia | 27.5 |
| | Posizione Attacco | 29 |
| | Diametro Girante | Ø72 |
| | N° Alette Girante | 7 |
| Posizione Girante | 33 | |

KW

AUDI
100 III, Avant

| | | | | | |
|-------------|----|---------------|---|----|--------------------------------|
| 2.0 D | 51 | 03/83 → 11/90 | D | CN | → 05-1990, → T: F-L-100.000 |
| 2.0 D Turbo | 74 | 03/88 → 11/90 | D | NC | → 05-1990, → T: F-L-100.000 |
| 2.0 TD | 74 | 03/88 → 11/90 | D | NC | → 05-1990, → T: F-L-100.000 |
| 2.4 D | 60 | 08/89 → 07/91 | D | 3D | → 05-1990, → T: F-L-100.000 |

VOLKSWAGEN
LT I 28-35, 40-55

| | | | | | |
|------------|----|---------------|---|---------|--|
| 2.4 D | 51 | 08/89 → 06/96 | D | 1S, ACT | |
| | 55 | 01/79 → 07/92 | D | CP, DW | |
| 2.4 TD | 68 | 08/89 → 08/92 | D | 1G | |
| | 75 | 02/86 → 08/92 | D | DV | |
| 2.4 TD 4WD | 75 | 08/78 → 07/92 | D | DV | |

VOLVO
240, Station Wagon

| | | | | | |
|------------|----|---------------|---|-----|-------------------------|
| 2.4 Diesel | 58 | 08/87 → 08/93 | D | D24 | 01-1979 →, → 12-1993 |
| | 58 | 08/88 → 08/93 | D | D24 | |

740, Station Wagon

| | | | | | |
|------------------|----|---------------|---|------|--|
| 2.4 Diesel | 60 | 08/84 → 07/92 | D | D24 | |
| 2.4 TD | 80 | 08/85 → 12/90 | D | D24T | |
| | 83 | 08/84 → 07/90 | D | D24T | |
| 2.4 Turbo-Diesel | 80 | 09/85 → 07/92 | D | D24T | |

760, Station Wagon

| | | | | | |
|------------------|----|---------------|---|--------|--|
| 2.4 D | 60 | 01/82 → 07/92 | D | D24 | |
| 2.4 TD Interc. | 85 | 08/87 → 07/92 | D | D24TIC | |
| 2.4 Turbo Diesel | 80 | 04/87 → 07/92 | D | D24T | |

81593
350981593000

VOLVO
940 I, Station Wagon

| | | | | | |
|--------------------|----|---------------|---|--------|---------------------------|
| 2.4 D | 60 | 08/90 → 12/94 | D | D24 | |
| 2.4 TD Intercooler | 90 | 08/90 → 12/94 | D | D24TIC | → 06-1992, → T: 30.003 |
| 2.4 Turbo Diesel | 80 | 08/90 → 12/94 | D | D24T | |
| 2.4 TD Interc. | 85 | 09/91 → 07/94 | D | D24TIC | → 06-1992, → T: 30.003 |

81594
350981594000

| | | |
|-------------------|-------------------------|------|
| | FLANGIA | |
| | Numero Fori Flangia | 4 |
| | Dimensione Fori Flangia | M6×1 |
| | Posizione Attacco | 131 |
| | Diametro Girante | Ø70 |
| | N° Alette Girante | 6 |
| Posizione Girante | -0.5 | |

KW

VOLVO
240, Station Wagon

| | | | | | |
|------------|-----|---------------|---|-------|-------------------------|
| 2.0 | 86 | 08/83 → 07/93 | B | B200E | |
| 2.3 Cat. | 100 | 08/91 → 07/92 | B | B230F | |
| 2.3 i Cat. | 85 | 08/86 → 07/93 | B | B230F | 09-1984 →, → 12-1993 |
| | 85 | 08/86 → 07/93 | B | B230F | |

740, Station Wagon

| | | | | | |
|-----------|---------------|---------------|-------|-----------------|--|
| 2.0 | 76 | 09/88 → 08/90 | B | B200K | |
| | 82 | 09/90 → 08/92 | B | B200F | |
| | 89 | 08/85 → 07/92 | B | B200E, B200G | |
| | 89 | 08/85 → 07/92 | B | B200G | |
| 2.0 GLE | 103 | 09/87 → 08/90 | B | B204E | |
| 2.0 Turbo | 114 | 09/90 → 08/91 | B | B200FT | |
| | 115 | 09/87 → 08/90 | B | B200ET | |
| 2.3 | 84 | 09/85 → 07/90 | B | B230K | |
| | 85 | 08/87 → 07/92 | B | B230F | |
| | 100 | 08/88 → 07/90 | B | B230FB | |
| | 111 | 08/88 → 08/92 | B | B234F | |
| 114 | 08/88 → 07/91 | B | B234F | | |

81594
350981594000

KW

VOLVO
740, Station Wagon

| | | | | |
|-----------|-----|---------------|---|-------------------|
| 2.3 Turbo | 121 | 08/89 → 07/90 | B | B230FT |
| | 121 | 08/89 → 07/90 | B | B230FT, B230GT |
| | 125 | 09/89 → 08/91 | B | B230FT, B230GT |
| | 140 | 08/89 → 07/90 | B | B230FT |

760, Station Wagon

| | | | | |
|-----------|-----|---------------|---|--------|
| 2.3 | 121 | 01/88 → 07/92 | B | B230FT |
| 2.3 Turbo | 115 | 09/87 → 08/90 | B | B230FT |
| | 134 | 08/84 → 08/90 | B | B230ET |

940 I, Station Wagon

| | | | | |
|-----------|-----|---------------|---|------------------|
| 2.0 | 82 | 01/92 → 07/94 | B | B200F |
| | 89 | 09/90 → 09/93 | B | B200E, B200G |
| | 89 | 09/90 → 09/93 | B | B200G |
| | 102 | 09/90 → 09/93 | B | B204FT |
| 2.0 Turbo | 114 | 08/90 → 12/94 | B | B200FT |
| 2.3 | 85 | 08/92 → 07/94 | B | B230FD |
| | 96 | 08/90 → 12/94 | B | B230FB |
| | 96 | 08/90 → 12/94 | B | B230FB, B230G |
| | 114 | 08/90 → 07/91 | B | B234F |
| 2.3 Turbo | 114 | 08/90 → 07/91 | B | B234F, B234G |
| | 121 | 08/90 → 07/94 | B | B230FT |
| | 140 | 08/91 → 07/93 | B | B230FT+ |

940 II, Station Wagon

| | | | | |
|-----------|-----|---------------|---|--------|
| 2.0 | 89 | 11/94 → 12/95 | B | B200G |
| | 102 | 10/94 → 05/97 | B | B204FT |
| 2.0 Turbo | 114 | 04/96 → 10/98 | B | B200FT |
| 2.3 | 85 | 08/94 → 07/95 | B | B230FD |
| | 96 | 08/94 → 10/98 | B | B230FB |
| 2.3 ti | 99 | 01/95 → 10/98 | B | B230FK |
| 2.3 Turbo | 121 | 08/94 → 10/98 | B | B230FT |
| | 126 | 08/95 → 10/98 | B | B230FT |

960 I, Station Wagon

| | | | | |
|-----------|-----|---------------|---|--------|
| 2.0 | 103 | 09/90 → 08/93 | B | B204E |
| | 140 | 08/90 → 09/93 | B | B204FT |
| 2.3 Turbo | 121 | 09/90 → 08/93 | B | B230FT |

81596
350981596000

KW

PULEGGIA

| | |
|----------------------------|------|
| Diametro Puleggia | Ø144 |
| Numero Denti/Gole Puleggia | 1 |
| Posizione Attacco | 29.5 |
| Diametro Girante | Ø67 |
| N° Alette Girante | 8 |
| Posizione Girante | 18 |

KW

RENAULT
Clio I

| | | | | | |
|-----|----|---------------|---|--------|--------|
| 1.2 | 40 | 06/94 → 02/98 | B | C3G720 | (-)COP |
| | 40 | 01/96 → 12/96 | B | C3G720 | (-)COP |

Rapid

| | | | | | |
|-----|----|---------------|---|-------------------|--------|
| 1.2 | 40 | 09/91 → 03/98 | B | C3G710, C3G712 | (-)COP |
|-----|----|---------------|---|-------------------|--------|

Twingo I

| | | | | | |
|-----|----|---------------|---|-------------------|---------------|
| 1.2 | 40 | 03/93 → 10/96 | B | C3G700, C3G702 | (-)COP, (-)AC |
|-----|----|---------------|---|-------------------|---------------|

81597
350981597000

KW

FLANGIA

| | |
|-------------------------|------------|
| Numero Fori Flangia | 4 |
| Dimensione Fori Flangia | M6×1 |
| Posizione Attacco | 55.85 |
| Diametro Mozzo | M24×1.5 SX |
| Diametro Centraggio | Ø40 |
| Diametro Girante | Ø74 |
| N° Alette Girante | 7 |
| Posizione Girante | 60.55 |

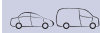
KW

BMW
3 III (E36), Touring, Cabrio, Coupé, Compact

| | | | | |
|---------|-----|---------------|---|-------------------|
| 318 tds | 66 | 01/95 → 02/98 | D | M41D17 (174T1) |
| 325 td | 85 | 09/91 → 02/98 | D | M51D25 (256T1) |
| 325 tds | 105 | 05/93 → 02/98 | D | M51D25 (256T1) |

5 III (E34), Touring

| | | | | |
|---------|-----|---------------|---|-------------------|
| 525 td | 85 | 04/93 → 09/95 | D | M51D25 (256T1) |
| 525 tds | 105 | 09/91 → 09/95 | D | M51D25 (256T1) |

81597 350981597000

BMW
5 IV (E39), Touring

| | | | | | |
|---------|-----|---------------|---|-------------------|--|
| 525 td | 85 | 01/97 → 06/03 | D | M51D25 (256T1) | |
| 525 tds | 105 | 01/96 → 06/03 | D | M51D25 (256T1) | |

7 III (E38)

| | | | | | |
|---------|-----|---------------|---|-------------------|--|
| 725 tds | 105 | 04/96 → 11/01 | D | M51D25 (256T1) | |
|---------|-----|---------------|---|-------------------|--|

LAND ROVER
Range Rover II

| | | | | | |
|-----------|-----|---------------|---|------------|--|
| 2.5 D 4x4 | 100 | 07/94 → 03/02 | D | 256T (BMW) | |
|-----------|-----|---------------|---|------------|--|

OPEL
Omega B, Station Wagon

| | | | | | |
|--------|----|---------------|---|--------------------------|--|
| 2.5 D | 96 | 05/94 → 05/99 | D | X25TD | |
| 2.5 TD | 96 | 04/94 → 07/03 | D | 25DT, X25DT, X25TD | |

81598 350981598000

| | | |
|--|-------------------------|---------|
| | FLANGIA | |
| | Numero Fori Flangia | 4 |
| | Dimensione Fori Flangia | M8x1.25 |
| | Posizione Attacco | 93 |
| | Diametro Girante | Ø55.5 |
| | N° Alette Girante | 6 |
| | Posizione Girante | 12.5 |

FORD
Fiesta IV, Van

| | | | | | |
|---------------|----|---------------|---|--|--|
| 1.25 i 16V | 55 | 08/95 → 01/02 | B | DHA, DHB, DHC, DHD, DHE, DHF, DHG | |
| 1.4 i | 66 | 04/96 → 10/99 | B | FHA | |
| 1.4 i 16V | 66 | 04/96 → 01/02 | B | FHA, FHE | |
| 1.6 16V Sport | 76 | 02/00 → 01/02 | B | L1T, L1V | |

Fiesta V, Van

| | | | | | |
|----------|----|---------------|---|---------------|-----------|
| 1.25 16V | 51 | 03/03 → 06/08 | B | M7JA, M7JB | → 04-2005 |
| | 55 | 05/02 → 06/08 | B | FUJA, FUJB | → 04-2005 |
| 1.4 16V | 59 | 11/01 → 06/08 | B | FXJA, FXJB | → 04-2005 |
| 1.6 16V | 74 | 11/01 → 06/08 | B | FYJA, FYJB | → 04-2005 |

81598 350981598000

FORD
Focus C-Max

| | | | | | |
|--------|----|---------------|---|---------------|-----------|
| 1.6 | 74 | 10/03 → 03/07 | B | HWDA, HWDB | → 04-2005 |
| 1.6 Ti | 85 | 08/04 → 03/07 | B | HXDA, SIDA | → 04-2005 |

Focus I, Station Wagon

| | | | | | |
|-------------------|----|---------------|---|--|-----------|
| 1.4 16V | 55 | 10/98 → 11/04 | B | FXDA, FXDB, FXDC, FXDD | 10-1998 → |
| | 55 | 02/99 → 11/04 | B | FXDA, FXDB, FXDC, FXDD | |
| 1.6 16V | 74 | 10/98 → 11/04 | B | FYDA, FYDB, FYDC, FYDD, FYDH | 10-1998 → |
| | 74 | 02/99 → 11/04 | B | FYDA, FYDB, FYDC, FYDD, FYDH | |
| 1.6 16V Flexifuel | 75 | 01/02 → 11/04 | | FYDH | |

Focus II, Station Wagon, Cabrio

| | | | | | |
|--------|----|---------------|---|--|-----------|
| 1.4 | 59 | 07/04 → 09/12 | B | ASDA, ASDB | → 04-2005 |
| 1.6 | 74 | 07/04 → 09/12 | B | HWDA, HWDB, SHDA, SHDB, SHDC | → 04-2005 |
| | 85 | 07/04 → 09/12 | B | HXDA, HXDB | → 04-2005 |
| 1.6 Ti | 85 | 07/04 → 09/12 | B | HXDA, HXDB, SIDA | → 04-2005 |

Fusion

| | | | | | |
|---------|----|---------------|---|---------------------|-----------|
| 1.25 | 55 | 08/04 → 12/12 | B | FUJA, FUJB | → 04-2005 |
| 1.4 | 59 | 08/02 → 12/12 | B | FXJA, FXJB, FXJC | → 04-2005 |
| 1.4 LPG | 59 | 01/10 → 12/12 | | UTJA | |
| 1.6 | 74 | 08/02 → 11/08 | B | FYJA, FYJB, FYJC | → 04-2005 |

81598
350981598000

FORD
Puma

| | | | | |
|---------|-----|---------------|---|----------|
| 1.4 16V | 66 | 11/97 → 10/00 | B | FHD, FHF |
| 1.6 16V | 76 | 08/00 → 06/02 | B | L1W |
| 1.7 16V | 92 | 03/97 → 06/02 | B | MHA, MHB |
| ST 160 | 118 | 06/99 → 06/02 | B | |

MAZDA
2 I

| | | | | |
|-------|----|---------------|---|------|
| 1.25 | 55 | 04/03 → | B | FUJA |
| 1.3 L | 67 | 04/03 → 06/07 | B | ZJ04 |
| 1.4 | 59 | 02/03 → | B | FXJA |
| 1.6 | 74 | 02/03 → | B | FYJA |

121

| | | | | |
|-----------|----|---------------|---|----------|
| 1.25 | 55 | 03/96 → 04/03 | B | DHF, DHG |
| 1.3 i 16V | 53 | 11/90 → 03/96 | B | B3 (16V) |

2 I

| | | | | |
|-----|----|---------|---|------|
| 1.2 | 55 | 02/03 → | B | FUJA |
|-----|----|---------|---|------|

VOLVO
C 30

| | | | | |
|-----|----|---------------|---|---------|
| 1.6 | 74 | 10/06 → 12/12 | B | B4164S3 |
|-----|----|---------------|---|---------|

V 40 II

| | | | | |
|---------|-----|---------|---|---------|
| T2 GTDi | 88 | 03/13 → | B | B4164T4 |
| T3 GTDi | 110 | 03/12 → | B | B4164T3 |
| T4 GTDi | 132 | 03/12 → | B | B4164T |

V 50

| | | | | |
|-----|----|---------|---|---------|
| 1.6 | 74 | 01/05 → | B | B4164S3 |
|-----|----|---------|---|---------|

81602
350981602000

FLANGIA

| | |
|-------------------------|------------|
| Numero Fori Flangia | 4 |
| Dimensione Fori Flangia | M8x1.25 |
| Posizione Attacco | 95.5 |
| Diametro Mozzo | M24x1.5 SX |
| Diametro Centraggio | Ø32.2 |
| Diametro Girante | Ø71 |
| N° Alette Girante | 7 |
| Posizione Girante | 12.5 |

FORD
P 100 II

| | | | | |
|-----|----|---------------|---|-----|
| 2.0 | 57 | 10/87 → 12/92 | B | NAE |
|-----|----|---------------|---|-----|

Scorpio I, Station Wagon

| | | | | | |
|-------|----|---------------|---|----------|-----------------------------|
| 1.8 | 66 | 04/85 → 02/92 | B | REC | 10-1984 →, → 12-1990, VA |
| 2.0 i | 74 | 10/85 → 12/90 | B | NRC | |
| | 85 | 04/85 → 02/92 | B | NRA, NRI | → 12-1988 |

81602
350981602000

FORD
Sierra II, Station Wagon

| | | | | | |
|---------------------------------|-----|---------------|---|----------|-----------|
| 1.6 | 53 | 01/88 → 02/93 | B | LSF | (+)SS |
| | 53 | 01/88 → 02/93 | B | LSF | (+)SS, VA |
| | 55 | 01/87 → 02/93 | B | LSE | (+)SS |
| 1.6 i | 59 | 10/89 → 02/93 | B | L6B | (+)SS |
| | 59 | 10/89 → 02/93 | B | L6B | (+)SS |
| 2.0 | 77 | 01/87 → 02/93 | B | N8C, NES | (+)SS |
| | 80 | 07/89 → 12/92 | B | N8A | (+)SS |
| 2.0 16V Cosworth 4x4 | 162 | 01/90 → 02/93 | B | N5D | |
| 2.0 16V Cosworth 4x4 Cat. | 162 | 01/90 → 02/93 | B | N5C | |
| 2.0 4x4 | 88 | 01/90 → 02/93 | B | N9C | (+)SS |
| 2.0 i | 74 | 01/87 → 02/93 | B | NE5, NEJ | (+)SS |
| | 85 | 01/87 → 02/93 | B | N4A, N4I | (+)SS |
| | 80 | 06/89 → 02/93 | B | N8A | (+)SS |
| 2.0 i Cat. | 74 | 01/87 → 02/93 | B | N4B | (+)SS |
| 2.0 RS Cosworth | 150 | 11/87 → 01/90 | B | N5B | |

Transit IV

| | | | | | |
|-----|----|---------------|---|----------|----|
| 1.6 | 46 | 09/85 → 09/92 | B | LAT | VA |
| 2.0 | 57 | 12/85 → 09/92 | B | N6T | VA |
| | 57 | 11/85 → 09/92 | B | NAT, NAV | VA |

Transit Tourneo I

| | | | | | |
|-----|----|---------------|---|-----|--|
| 2.0 | 84 | 11/94 → 12/00 | B | NSH | |
|-----|----|---------------|---|-----|--|

Transit V

| | | | | | |
|-------|----|---------------|---|-----|--|
| 2.0 | 66 | 09/91 → 09/94 | B | NBA | |
| | 72 | 09/91 → 08/94 | B | NCA | |
| 2.0 i | 72 | 09/91 → 07/94 | B | NCA | |

Transit VI

| | | | | | |
|---------|----|---------------|---|----------|--|
| 2.0 | 84 | 09/95 → 03/00 | B | NSF, NSG | |
| 2.0 CNG | 84 | 06/94 → 03/00 | | NSH | |

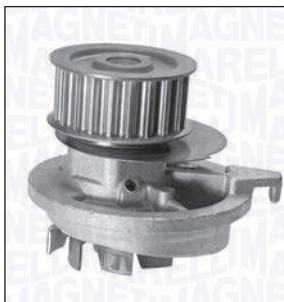
81605
350981605000

PULEGGIA

Diametro Puleggia Ø62.3
 Numero Denti/Gole Puleggia 21
 Altezza Puleggia 26
 Posizione Attacco 37
 Diametro Girante Ø65
 N° Alette Girante 8
 Posizione Girante 29

KW

OPEL
Astra F, Station Wagon, Cabrio, Van

| | | | | | |
|-------|----|---------------|---|------|-------------------------------|
| 1.7 D | 42 | 03/92 → 09/92 | D | 17D | |
| | 44 | 07/92 → 09/98 | D | 17DR | → 12-1992, → M: 14.363.651 |

Kadett E, Station Wagon, Coupé, Cabrio, Van

| | | | | | |
|-------|----|---------------|---|------|-------------------------|
| 1.7 D | 42 | 02/89 → 08/91 | D | 17D | 09-1989 →, → 05-1992 |
| | 42 | 02/89 → 08/91 | D | 17D | |
| | 44 | 07/92 → 07/94 | D | 17DR | |

Vectra A

| | | | | | |
|-------|----|---------------|---|------|-------------------------------|
| 1.7 D | 42 | 10/88 → 09/92 | D | 17D | → M: 14.333.449 |
| | 44 | 07/92 → 11/95 | D | 17DR | → 12-1992, → M: 14.333.449 |

81606
350981606000

PULEGGIA

Diametro Puleggia Ø62.3
 Numero Denti/Gole Puleggia 21
 Altezza Puleggia 21.5
 Posizione Attacco 40
 Diametro Girante Ø65
 N° Alette Girante 8
 Posizione Girante 29

KW

DAEWOO
Espero

| | | | | | |
|-----|----|---------------|---|-------|-----------|
| 1.8 | 66 | 02/95 → 09/99 | B | C18LE | → 10-1995 |
| | 70 | 02/95 → 06/99 | B | C18LE | → 10-1995 |
| 2.0 | 74 | 10/91 → 09/93 | B | C20LZ | |
| | 77 | 02/95 → 06/99 | B | C20LE | → 10-1995 |
| | 81 | 10/93 → 09/94 | B | C20LE | |

81606
350981606000

KW

OPEL
Astra F, Station Wagon, Cabrio, Van

| | | | | | |
|-------|----|---------------|---|-------|-------------------------------|
| 1.8 i | 66 | 03/92 → 09/98 | B | C18NZ | → 10-1992, → M: 14.254.438 |
| 2.0 i | 85 | 03/92 → 09/98 | B | C20NE | → 10-1992, → M: 14.608.700 |
| | 85 | 03/93 → 10/94 | B | C20NE | → M: 14.608.700 |

Calibra

| | | | | | |
|-----------|----|---------------|---|-------|-------------------------------|
| 2.0 i | 85 | 06/90 → 07/97 | B | C20NE | → 12-1992, → M: 14.608.700 |
| 2.0 i 4x4 | 85 | 06/90 → 07/97 | B | C20NE | → 12-1992, → M: 14.608.700 |

Frontera A

| | | | | | |
|-------|----|---------------|---|-----------------|----------|
| 2.0 i | 85 | 03/92 → 10/98 | B | C20NE, X20SE | M: C20NE |
|-------|----|---------------|---|-----------------|----------|

Kadett E, Station Wagon, Coupé, Cabrio, Van

| | | | | | |
|-----|----|---------------|---|-----|-------------------------------|
| 1.8 | 84 | 09/87 → 08/90 | B | 18E | 09-1988 →, M →: 14.237.770 |
|-----|----|---------------|---|-----|-------------------------------|

| | | | | | |
|-------|----|---------------|---|---------------------------|--|
| 1.8 i | 66 | 06/85 → 08/91 | B | C18NT, C18NZ, S18NV | |
|-------|----|---------------|---|---------------------------|--|

| | | | | | |
|-------|----|---------------|---|-----------------|--|
| 1.8 S | 62 | 09/87 → 08/91 | B | E18NV | |
| | 62 | 09/87 → 08/91 | B | E18NV, S18NV | |

| | | | | | |
|-------|----|---------------|---|-------|--|
| 1.8 S | 62 | 09/87 → 08/91 | B | E18NV | |
|-------|----|---------------|---|-------|--|

| | | | | | |
|---------|----|---------------|---|-------|--|
| 2.0 GSI | 85 | 09/86 → 08/91 | B | 20NE | |
| | 95 | 09/86 → 08/91 | B | 20SEH | |

| | | | | | |
|--------------|----|---------------|---|-------|--|
| 2.0 GSI Cat. | 85 | 09/86 → 08/91 | B | C20NE | |
|--------------|----|---------------|---|-------|--|

| | | | | | |
|-------|----|---------------|---|------------|--|
| 2.0 i | 85 | 10/86 → 02/93 | B | 20NE | |
| | 85 | 03/87 → 08/91 | B | 20NE, 20SE | |

| | | | | | |
|------------|----|---------------|---|-------|--|
| 2.0 i Cat. | 85 | 03/87 → 08/91 | B | C20NE | |
|------------|----|---------------|---|-------|--|

Omega A, Station Wagon

| | | | | | |
|-----|----|---------------|---|--------|--|
| 1.8 | 65 | 09/87 → 03/94 | B | E18NVR | |
| | 85 | 09/86 → 03/94 | B | 18SEH | |

| | | | | | |
|-------|----|---------------|---|------|--|
| 1.8 S | 66 | 09/86 → 03/94 | B | 18SV | |
|-------|----|---------------|---|------|--|

| | | | | | |
|-----|----|---------------|---|------|-------------------------------|
| 2.0 | 90 | 09/86 → 03/94 | B | 20SE | → 12-1989, → M: 14.608.700 |
|-----|----|---------------|---|------|-------------------------------|

| | | | | | |
|-------|----|---------------|---|-------|-------------------------------|
| 2.0 i | 85 | 09/86 → 03/94 | B | C20NE | → 12-1989, → M: 14.608.700 |
|-------|----|---------------|---|-------|-------------------------------|

Vectra A

| | | | | | |
|-------|----|---------------|---|------|-----------------|
| 1.8 i | 66 | 09/88 → 10/90 | B | 18SV | → T: N5.999.999 |
|-------|----|---------------|---|------|-----------------|

| | | | | | |
|------------|----|---------------|---|-------|-------------------------------|
| 1.8 i Cat. | 66 | 03/90 → 11/95 | B | C18NZ | → 12-1992, → T: N5.999.999 |
|------------|----|---------------|---|-------|-------------------------------|

| | | | | | |
|-------|----|---------------|---|------|-----------------|
| 1.8 S | 66 | 09/89 → 10/90 | B | 18SV | → T: N5.999.999 |
|-------|----|---------------|---|------|-----------------|

| | | | | | |
|-------|----|---------------|---|------|-----------------|
| 2.0 i | 85 | 09/88 → 10/90 | B | 20NE | → T: N5.999.999 |
|-------|----|---------------|---|------|-----------------|

81606
350981606000

OPEL
Vectra A

| | | | | | |
|-------------------|----|---------------|---|-------|---|
| 2.0 i | 95 | 09/88 → 09/92 | B | 20SEH | 08-1988 →, → 12-1992, → T: N5.999.999 |
| 2.0 i 4x4 | 85 | 01/89 → 10/90 | B | 20NE | → T: N5.999.999 |
| | 95 | 01/89 → 09/92 | B | 20SEH | 08-1988 →, → 12-1992, → T: N5.999.999 |
| 2.0 i 4x4 Cat. | 85 | 01/89 → 11/95 | B | C20NE | 08-1988 →, → 12-1992, → T: N5.999.999 |
| 2.0 i Cat. | 85 | 09/88 → 11/95 | B | C20NE | → 12-1992, → T: N5.999.999 |
| 2.0 i GT | 95 | 09/88 → 11/95 | B | 20SEH | → 12-1992, → T: N5.999.999 |

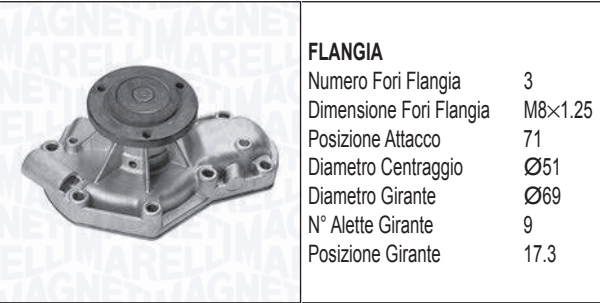
81608
350981608000

RENAULT
21, Station Wagon

| | | | | | |
|---------|----|---------------|---|---|----------------|
| 2.0 | 78 | 05/91 → 10/93 | B | J6R758 | → M: F.197.763 |
| | 75 | 03/86 → 10/93 | B | J6R758, J6R759, J6R792, J6R793 | → M: F.197.763 |
| | 88 | 09/89 → 12/93 | B | J7R746, J7R747 | → M: F.197.763 |
| | 99 | 02/90 → 10/92 | B | J7R740 | → M: F.197.763 |
| 2.0 4x4 | 88 | 03/89 → 12/93 | B | J7R746, J7R747 | → M: F.197.763 |
| | 99 | 09/90 → 10/92 | B | J7R740 | → M: F.197.763 |
| 2.1 D | 49 | 06/86 → 08/94 | D | J8S704 | |
| | 48 | 10/86 → 09/90 | D | J8S704 | |
| | 51 | 04/92 → 06/94 | D | J8S784 | |
| | 53 | 09/89 → 12/92 | D | J8S600, J8S740 | |

81608
350981608000

RENAULT
21, Station Wagon

| | | | | | |
|-------------|----|---------------|---|------------------------------|---------------|
| 2.1 D 4x4 | 48 | 10/88 → 05/92 | D | J8S704 | |
| 2.1 Turbo-D | 65 | 09/89 → 06/94 | D | J8S714, J8S786, J8S788 | |
| | | | | J7T754, J7T755 | → M: F241.442 |
| 2.2 | 79 | 09/89 → 06/94 | B | J7T754, J7T755 | → M: F241.442 |
| 2.2 4x4 | 79 | 07/90 → 06/94 | B | J7T754, J7T755 | → M: F241.442 |

Trafic I

| | | | | | |
|-------|----|---------------|---|-------------------|-----------|
| 2.1 D | 47 | 06/94 → 10/97 | D | J8S620, J8S758 | 09-1994 → |
|-------|----|---------------|---|-------------------|-----------|

81611
350981611000

HONDA
Civic IV, Hatchback

| | | | | | |
|----------|----|---------------|---|-------|--|
| 1.3 16 V | 55 | 09/89 → 09/91 | B | D13B2 | |
|----------|----|---------------|---|-------|--|

81613
350981613000

HONDA
Civic II Shuttle

| | | | | | |
|-----------|----|---------------|---|----------------|--|
| 1.4 i 16V | 66 | 01/88 → 12/92 | B | D14A1 | |
| 1.5 i 16V | 69 | 01/88 → 11/91 | B | D15B2 | |
| 1.6 4x4 | 85 | 01/88 → 12/92 | B | D16A, D16A7 | |

81613 350981613000

HONDA
Civic II Shuttle

| | | | | |
|------------------|----|---------------|---|-------|
| 1.6 i 16V 4WD | 81 | 01/88 → 02/95 | B | D16A6 |
|------------------|----|---------------|---|-------|

Civic IV, Hatchback

| | | | | |
|-----------|----|---------------|---|-------|
| 1.5 i 16V | 66 | 10/88 → 09/91 | B | D15B2 |
| | 69 | 10/88 → 09/91 | B | D15B2 |

| | | | | |
|---------|-----|---------------|---|-------|
| 1.6 4x4 | 110 | 01/88 → 12/91 | B | D16W4 |
|---------|-----|---------------|---|-------|

| | | | | |
|-----------|----|---------------|---|-------|
| 1.6 i 16V | 96 | 09/87 → 09/91 | B | D16A7 |
|-----------|----|---------------|---|-------|

| | | | | |
|--|----|---------------|---|-----------------|
| | 96 | 09/87 → 09/91 | B | D16A7, D16A9 |
|--|----|---------------|---|-----------------|

| | | | | |
|--|----|---------------|---|-------|
| | 80 | 10/87 → 09/91 | B | D16A6 |
|--|----|---------------|---|-------|

| | | | | |
|--|----|---------------|---|-------|
| | 81 | 10/87 → 09/91 | B | D16Z2 |
|--|----|---------------|---|-------|

| | | | | |
|---------------|----|---------------|---|-------|
| 1.6 i 16V 4x4 | 80 | 10/89 → 09/91 | B | D16A6 |
|---------------|----|---------------|---|-------|

| | | | | |
|-------------------|-----|---------------|---|-------|
| 1.6 i 16V Vtec | 110 | 10/89 → 09/91 | B | B16A1 |
|-------------------|-----|---------------|---|-------|

Civic V, Hatchback, Coupé

| | | | | |
|---------|----|---------------|---|-------|
| 1.3 16V | 55 | 10/91 → 11/95 | B | D13B2 |
|---------|----|---------------|---|-------|

| | | | | |
|-----|----|---------------|---|-------|
| 1.5 | 61 | 01/92 → 12/92 | B | D15B2 |
|-----|----|---------------|---|-------|

| | | | | |
|--|----|---------------|---|-------|
| | 66 | 10/93 → 12/95 | B | D15B2 |
|--|----|---------------|---|-------|

| | | | | |
|--|----|---------------|---|-----------------|
| | 74 | 10/93 → 12/95 | B | D15B2, D15Z1 |
|--|----|---------------|---|-----------------|

| | | | | |
|-----------|----|---------------|---|-----------------|
| 1.5 i 16V | 66 | 10/91 → 11/95 | B | D15B2, D15Z2 |
|-----------|----|---------------|---|-----------------|

| | | | | |
|--|----|---------------|---|-----------------|
| | 69 | 10/91 → 11/95 | B | D15B2, D15Z1 |
|--|----|---------------|---|-----------------|

| | | | | |
|-----------|----|---------------|---|-------|
| 1.5 i LSi | 74 | 08/93 → 11/95 | B | D15B7 |
|-----------|----|---------------|---|-------|

| | | | | |
|--------------|----|---------------|---|-------|
| 1.6 16V Vtec | 92 | 10/91 → 11/95 | B | D16Z6 |
|--------------|----|---------------|---|-------|

| | | | | |
|---------|----|---------------|---|-------|
| 1.6 4x4 | 92 | 01/92 → 10/95 | B | D16Z7 |
|---------|----|---------------|---|-------|

| | | | | |
|--------|----|---------------|---|-------|
| 1.6 EX | 88 | 08/93 → 10/95 | B | D16A7 |
|--------|----|---------------|---|-------|

| | | | | |
|-------|----|---------------|---|-------|
| 1.6 i | 77 | 01/94 → 11/95 | B | D16Y7 |
|-------|----|---------------|---|-------|

| | | | | |
|------------|----|---------------|---|-----------------|
| 1.6 i Vtec | 92 | 01/94 → 03/96 | B | D16Y6, D16Z9 |
|------------|----|---------------|---|-----------------|

Civic VI, Hatchback, Aerodeck, Fastback, Coupé

| | | | | |
|-----|----|---------------|---|-------|
| 1.4 | 55 | 11/95 → 10/98 | B | D14A4 |
|-----|----|---------------|---|-------|

| | | | | |
|-------|----|---------------|---|---------------------------|
| 1.4 i | 55 | 09/95 → 02/01 | B | D14A5, D14A7, D14Z3 |
|-------|----|---------------|---|---------------------------|

| | | | | |
|--|----|---------------|---|-------------------------------------|
| | 66 | 09/94 → 02/01 | B | D14A2, D14A6, D14A8, D14Z4 |
|--|----|---------------|---|-------------------------------------|

| | | | | |
|--|----|---------------|---|---------------------------|
| | 66 | 11/95 → 02/01 | B | D14A4, D14Z2, D14Z4 |
|--|----|---------------|---|---------------------------|

81613 350981613000

HONDA
Civic VI, Hatchback, Aerodeck, Fastback, Coupé

| | | | | |
|---------|----|---------------|---|---------------------------|
| 1.4 i S | 66 | 11/95 → 02/01 | B | D14A4, D14Z2, D14Z4 |
|---------|----|---------------|---|---------------------------|

| | | | | |
|--------------|----|---------------|---|-------|
| 1.5 i Vtec-E | 66 | 09/94 → 01/97 | B | D15Z3 |
|--------------|----|---------------|---|-------|

| | | | | |
|-----|----|---------------|---|-------|
| 1.6 | 93 | 10/95 → 09/00 | B | D16Y2 |
|-----|----|---------------|---|-------|

| | | | | |
|-------|----|---------------|---|-------|
| 1.6 i | 83 | 09/94 → 01/97 | B | D16Y3 |
|-------|----|---------------|---|-------|

| | | | | |
|------------|----|---------------|---|-------|
| 1.6 i Vtec | 93 | 09/94 → 01/97 | B | D16Y2 |
|------------|----|---------------|---|-------|

Concerto

| | | | | |
|-----|----|---------------|---|-------|
| 1.4 | 61 | 10/89 → 10/92 | B | D14A1 |
|-----|----|---------------|---|-------|

| | | | | |
|--|----|---------------|---|-----------------|
| | 66 | 08/89 → 10/91 | B | D14A1, D14A8 |
|--|----|---------------|---|-----------------|

| | | | | |
|-----------|----|---------------|---|-------|
| 1.5 i 16V | 66 | 08/89 → 03/95 | B | D15B2 |
|-----------|----|---------------|---|-------|

| | | | | |
|-----|----|---------------|---|-------|
| 1.6 | 96 | 10/89 → 10/92 | B | D16A9 |
|-----|----|---------------|---|-------|

| | | | | |
|---------|----|---------------|---|-------|
| 1.6 16V | 78 | 08/89 → 03/95 | B | D16Z2 |
|---------|----|---------------|---|-------|

| | | | | |
|-----------|----|---------------|---|-------|
| 1.6 i 16V | 82 | 08/89 → 03/95 | B | D16Z2 |
|-----------|----|---------------|---|-------|

| | | | | |
|--|----|---------------|---|-------|
| | 90 | 08/89 → 03/95 | B | D16A8 |
|--|----|---------------|---|-------|

CRX II

| | | | | |
|-----------|----|---------------|---|-------|
| 1.6 i 16V | 91 | 10/87 → 02/92 | B | D16Z5 |
|-----------|----|---------------|---|-------|

CRX II

| | | | | |
|-------------------|-----|---------------|---|-------|
| 1.6 i 16V Vtec | 110 | 10/89 → 02/92 | B | B16A1 |
|-------------------|-----|---------------|---|-------|

| | | | | |
|---------|----|---------------|---|-----------------|
| 1.6 ESi | 92 | 03/92 → 12/98 | B | D16Y8, D16Z6 |
|---------|----|---------------|---|-----------------|

| | | | | |
|-----------|-----|---------------|---|-------|
| 1.6 i VTi | 118 | 03/92 → 12/98 | B | B16A2 |
|-----------|-----|---------------|---|-------|

ROVER
200 II, Coupé

| | | | | |
|-----|----|---------------|---|-------|
| 216 | 90 | 10/92 → 06/99 | B | D16A8 |
|-----|----|---------------|---|-------|

| | | | | |
|---------|----|---------------|---|-------|
| 216 GSi | 82 | 10/89 → 10/95 | B | D16Z2 |
|---------|----|---------------|---|-------|

| | | | | |
|--|----|---------------|---|-------|
| | 85 | 10/89 → 10/95 | B | D16A7 |
|--|----|---------------|---|-------|

| | | | | |
|---------|----|---------------|---|-------|
| 216 GTi | 90 | 09/90 → 10/95 | B | D16A8 |
|---------|----|---------------|---|-------|

| | | | | |
|--|----|---------------|---|-------|
| | 96 | 09/90 → 10/95 | B | D16A9 |
|--|----|---------------|---|-------|

400 I, Station Wagon

| | | | | | |
|-------|----|---------------|---|-------|-----------|
| 1.6 i | 82 | 05/94 → 11/98 | B | D16Z2 | → 02-1996 |
|-------|----|---------------|---|-------|-----------|

| | | | | | |
|--|----|---------------|---|-------|-----------|
| | 90 | 05/94 → 11/98 | B | D16A8 | → 02-1996 |
|--|----|---------------|---|-------|-----------|

| | | | | |
|---------|----|---------------|---|-------|
| 416 GSi | 82 | 04/90 → 04/95 | B | D16Z2 |
|---------|----|---------------|---|-------|

| | | | | |
|-----------------|----|---------------|---|-------|
| 416 GSi/ GSE | 85 | 04/90 → 04/95 | B | D16A7 |
|-----------------|----|---------------|---|-------|

| | | | | |
|---------|----|---------------|---|-------|
| 416 GTi | 90 | 04/90 → 04/95 | B | D16A8 |
|---------|----|---------------|---|-------|

| | | | | |
|-----------------|----|---------------|---|-------|
| 416 GTi/ GTE | 96 | 04/90 → 04/95 | B | D16A9 |
|-----------------|----|---------------|---|-------|

Cabriolet

| | | | | |
|----------|----|---------------|---|-------|
| 216 1.6i | 90 | 01/92 → 11/99 | B | D16A8 |
|----------|----|---------------|---|-------|

| | | | | |
|--------------|----|---------------|---|-------|
| 216 1.6i 16V | 82 | 01/96 → 11/99 | B | 16K4F |
|--------------|----|---------------|---|-------|

81614
350981614000

PULEGGIA

Diametro Puleggia Ø59.45
 Numero Denti/Gole Puleggia 24
 Altezza Puleggia 32.5
 Posizione Attacco 45
 Diametro Girante Ø58.5
 N° Alette Girante 6
 Posizione Girante 16.5

KW

ROVER
100

| | | | | | |
|-----|----|---------------|---|-----------------|--|
| 111 | 44 | 04/94 → 10/97 | B | 11K2D | |
| 114 | 55 | 04/94 → 10/97 | B | 14K2A, 14K2D | |

100 (Metro)

| | | | | | |
|-----------------|----|---------------|---|-----------------|--|
| 111 C/L/S | 44 | 03/90 → 12/98 | B | 11K2A, 11K2D | |
| 114 S/L/ GTA | 55 | 03/90 → 12/98 | B | 14K2A, 14K2D | |

200 II, Coupé

| | | | | | |
|-----|----|---------------|---|-----------------|--|
| 214 | 55 | 09/93 → 10/95 | B | 14K2A, 14K2D | |
|-----|----|---------------|---|-----------------|--|

200 III

| | | | | | |
|-------|----|---------------|---|-------|-----------|
| 211 | 44 | 01/98 → 03/00 | B | 11K2D | |
| 214 i | 55 | 11/95 → 03/00 | B | 14K2F | 03-1996 → |

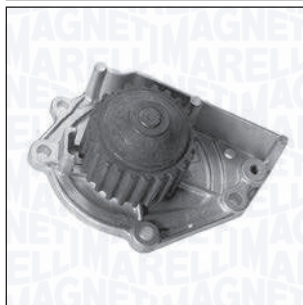
81615
350981615000

PULEGGIA

Diametro Puleggia Ø59.45
 Numero Denti/Gole Puleggia 24
 Altezza Puleggia 32.5
 Posizione Attacco 45
 Diametro Girante Ø58.5
 N° Alette Girante 6
 Posizione Girante 16.5

KW

LOTUS
Elise I

| | | | | | |
|-------|-----|---------------|---|-------|--|
| 1.8 | 88 | 08/95 → 11/00 | B | 18K4F | |
| 111 S | 107 | 03/99 → 11/00 | B | 18K4K | |

MG
MG TF

| | | | | | |
|-----|-----|---------------|---|-------|--|
| 115 | 85 | 03/02 → 12/09 | B | 16K4F | |
| 120 | 88 | 03/02 → 12/09 | B | 18K4F | |
| 135 | 100 | 03/02 → 12/09 | B | 18K4F | |
| 160 | 118 | 03/02 → 12/09 | B | 18K4K | |

81615
350981615000

KW

MG
MG ZR

| | | | | | |
|-----|-----|---------------|---|-------|--|
| 105 | 76 | 06/01 → 04/05 | B | 14K4F | |
| 120 | 86 | 06/01 → 04/05 | B | 18K4F | |
| 160 | 118 | 06/01 → 04/05 | B | 18K4K | |

MG ZS

| | | | | | |
|-----|----|---------------|---|-------|--|
| 120 | 86 | 07/01 → 04/05 | B | 18K4F | |
|-----|----|---------------|---|-------|--|

MGF

| | | | | | |
|-----------|-----|---------------|---|-------|--|
| 1.8 i VVC | 118 | 10/01 → 03/02 | B | 18K4K | |
| 1.6 | 82 | 02/00 → 03/02 | B | 16K4F | |
| 1.8 i 16V | 88 | 03/95 → 03/02 | B | 18K4F | |
| 1.8 i VVC | 107 | 03/95 → 03/02 | B | 18K4K | |

ROVER
25

| | | | | | |
|---------|-----|---------------|---|-------|--|
| 1.1 16V | 55 | 01/04 → 05/05 | B | 11K4F | |
| 1.4 16V | 62 | 10/99 → 05/05 | B | 14K4M | |
| | 76 | 10/99 → 05/05 | B | 14K4F | |
| 1.6 16V | 80 | 10/99 → 05/05 | B | 16K4F | |
| 1.8 16V | 85 | 10/99 → 05/05 | B | 18K4F | |
| | 107 | 02/00 → 05/05 | B | 18K4K | |

45

| | | | | | |
|-----|----|---------------|---|-------|--|
| 1.4 | 76 | 02/00 → 05/05 | B | 14K4F | |
| 1.6 | 80 | 02/00 → 05/05 | B | 16K4F | |
| 1.8 | 86 | 02/00 → 05/05 | B | 18K4F | |

75, Station Wagon

| | | | | | |
|-----------|-----|---------------|---|-------|--|
| 1.8 | 88 | 02/99 → 05/05 | B | K1.8 | |
| 1.8 Turbo | 110 | 05/03 → 05/05 | B | 18K4G | |

100

| | | | | | |
|-----|----|---------------|---|-------|--|
| 114 | 75 | 03/97 → 10/98 | B | 14K4F | |
|-----|----|---------------|---|-------|--|

100 (Metro)

| | | | | | |
|------------------------|----|---------------|---|-----------------|--|
| 114 GSi | 76 | 10/94 → 10/95 | B | 14K4F | |
| 114 GTI 16V | 69 | 03/90 → 08/91 | B | 14K4C, 14K4D | |
| 114 GTI 16V | 76 | 08/91 → 12/98 | B | 14K4F | |
| 114 GTI/GT 16V Cat. | 66 | 03/90 → 12/98 | B | 14K4C, 14K4D | |

200 II, Coupé

| | | | | | |
|------------|----|---------------|---|-----------------|--|
| 214 GSi/Si | 70 | 01/90 → 10/95 | B | 14K4C | |
| | 76 | 12/92 → 10/95 | B | 14K4F | |
| 214 Si/Gsi | 66 | 10/89 → 10/95 | B | 14K4C, 14K4D | |

200 III

| | | | | | |
|----------|-----|---------------|---|-------|--|
| 214 Si | 76 | 11/95 → 03/00 | B | 14K4F | |
| 216 Si | 82 | 11/95 → 03/00 | B | 16K4F | |
| 218 K Vi | 107 | 11/95 → 03/00 | B | 18K4K | |

81615
350981615000

KW

ROVER
400 I, Station Wagon

| | | | | | |
|--------------------|-----|---------------|---|-----------------|-----------|
| 1.6 i | 82 | 05/94 → 11/98 | B | D16Z2 | 03-1996 → |
| | 90 | 05/94 → 11/98 | B | D16A8 | 03-1996 → |
| 1.8 i | 107 | 06/96 → 11/98 | B | 18K4K | |
| 414 | 70 | 01/93 → 04/95 | B | 14K4C | |
| 414 GSI/SI | 66 | 04/90 → 04/95 | B | 14K4C, 14K4D | |
| 414 GSI/SI Cat. | 76 | 01/93 → 04/95 | B | 14K4F | |

400 II

| | | | | | |
|--------|----|---------------|---|-------|--|
| 414 Si | 76 | 05/95 → 03/00 | B | 14K4F | |
| 416 Si | 82 | 05/95 → 03/00 | B | 16K4F | |
| | 83 | 05/95 → 03/00 | B | D16Y2 | |

Cabriolet

| | | | | | |
|--------------|----|---------------|---|-----------------|--|
| 214 1.4 | 66 | 01/92 → 11/99 | B | 14K4C, 14K4D | |
| | 70 | 04/90 → 09/92 | B | 14K4C | |
| 214 1.4i 16V | 76 | 01/93 → 11/99 | B | 14K4F | |

Coupé

| | | | | | |
|----------|-----|---------------|---|-------|--|
| 1.6 16 V | 82 | 03/96 → 11/99 | B | 16K4F | |
| 1.8 16 V | 107 | 03/96 → 11/99 | B | 18K4K | |

Streetwise

| | | | | | |
|-----|----|---------------|---|-------|--|
| 1.4 | 62 | 08/03 → 05/05 | B | 14K4M | |
| | 76 | 08/03 → 05/05 | B | 14K4F | |

81616
350981616000

KW

FLANGIA

| | |
|-------------------------|------------|
| Numero Fori Flangia | 4 |
| Dimensione Fori Flangia | M6×1 |
| Posizione Attacco | 106.8 |
| Diametro Mozzo | M24×1.5 SX |
| Diametro Centraggio | Ø40 |
| Diametro Girante | Ø70 |
| N° Alette Girante | 7 |
| Posizione Girante | 10.5 |

KW

BMW
3 II (E30), Touring, Cabrio

| | | | | | |
|---------|-----|---------------|---|---|-----------|
| 320 i | 95 | 04/86 → 10/93 | B | M20B20 (206KA) | 10-1987 → |
| | 110 | 12/85 → 06/90 | B | M20B20 (206KA) | 10-1987 → |
| 320 i | 95 | 01/88 → 12/91 | B | M20B20 (206KA) | |
| | 95 | 12/85 → 06/91 | B | M20B20 (206KA), M20B20 (L-Jetronic) | 10-1987 → |
| 320 is | 141 | 05/88 → 12/90 | B | S14B20 (204EA) | |
| 325 i | 125 | 12/86 → 06/91 | B | M20B25 (256E1), M20B25 (256E2), M20B25 (256EX), M20B25 (256K1) | 10-1987 → |
| | 125 | 09/87 → 10/93 | B | M20B25 (256E2), M20B25 (256EX), M20B25 (256K1) | |
| | 125 | 07/87 → 03/93 | B | M20B25 (256K1) | |
| 325 i X | 125 | 12/86 → 08/91 | B | M20B25 (256E1), M20B25 (256E2), M20B25 (256EX), M20B25 (256K1) | 10-1987 → |
| | 125 | 06/88 → 10/93 | B | M20B25 (256K1) | |

81616 350981616000



BMW

5 III (E34), Touring

| | | | | | |
|-------|-----|---------------|---|-------------------|--|
| 520 i | 95 | 01/88 → 08/91 | B | M20B20 (206KA) | |
| 525 i | 125 | 01/88 → 08/91 | B | M20B25 (256K1) | |

Z1

| | | | | | |
|-----|-----|---------------|---|-------------------|-------------------------|
| 2.5 | 125 | 06/88 → 06/91 | B | M20B25 (256K1) | 11-1988 →, → 10-1991 |
|-----|-----|---------------|---|-------------------|-------------------------|

81617 350981617000

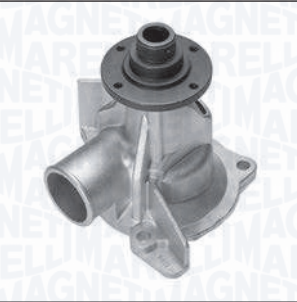

FLANGIA

| | |
|-------------------------|------------|
| Numero Fori Flangia | 4 |
| Dimensione Fori Flangia | M6×1 |
| Posizione Attacco | 107 |
| Diametro Mozzo | M24×1.5 SX |
| Diametro Centraggio | Ø40 |
| Diametro Girante | Ø74 |
| N° Alette Girante | 7 |
| Posizione Girante | 11 |



BMW

5 III (E34), Touring

| | | | | | |
|--------|----|---------------|---|------------------------------|-------------------------|
| 524 td | 85 | 03/88 → 09/95 | D | M21D24, M21D24 (246TB) | 03-1988 →, → 09-1991 |
|--------|----|---------------|---|------------------------------|-------------------------|

81618 350981618000



FLANGIA

| | |
|-------------------------|------------|
| Numero Fori Flangia | 4 |
| Dimensione Fori Flangia | M6×1 |
| Posizione Attacco | 99.5 |
| Diametro Mozzo | M24×1.5 SX |
| Diametro Centraggio | Ø40 |
| Diametro Girante | Ø75 |
| N° Alette Girante | 7 |
| Posizione Girante | -0.5 |



BMW

5 III (E34), Touring

| | | | | | |
|-------|-----|---------------|---|-------------------|-------------------------|
| 530 i | 138 | 01/88 → 08/91 | B | M30B30 (306KA) | 03-1988 →, → 08-1990 |
| 535 i | 155 | 01/88 → 09/95 | B | M30B34 (346KB) | |
| M5 | 232 | 10/88 → 05/92 | B | S38B36 (366S1) | |

81618 350981618000



BMW

5 III (E34), Touring

| | | | | | |
|---------|-----|---------------|---|-------------------|-------------------------|
| M5 Cat. | 232 | 10/88 → 05/92 | B | S38B36 (366S1) | 03-1988 →, → 06-1994 |
|---------|-----|---------------|---|-------------------|-------------------------|

6 I (E24)

| | | | | | |
|---------|-----|---------------|---|--------|-------------------------|
| 635 CSi | 141 | 04/85 → 09/90 | B | M30B35 | 09-1979 →, → 12-1988 |
|---------|-----|---------------|---|--------|-------------------------|

7 II (E32)

| | | | | | |
|----------|-----|---------------|---|-------------------|--|
| 730 i,iL | 138 | 12/86 → 09/94 | B | M30B30 (306KA) | |
| | 145 | 12/86 → 09/94 | B | M30B30 (306EA) | |
| 735 i,iL | 155 | 09/86 → 09/92 | B | M30B34 (346KB) | |

81619 350981619000



PULEGGIA

| | |
|----------------------------|-------|
| Diametro Puleggia | Ø62.3 |
| Numero Denti/Gole Puleggia | 21 |
| Altezza Puleggia | 26.5 |
| Posizione Attacco | 47 |
| Diametro Girante | Ø63 |
| N° Alette Girante | 6 |
| Posizione Girante | 52.5 |



LADA

Samara

| | | | | | |
|------|----|---------------|---|----------|-----------|
| 1100 | 39 | 02/88 → 12/94 | B | BA321081 | → 02-1992 |
| 1300 | 45 | 09/91 → | B | BA32108 | → 02-1992 |
| | 48 | 01/86 → 12/94 | B | BA32108 | → 02-1992 |
| 1500 | 50 | 09/91 → | B | BA321083 | → 02-1992 |

Samara Forma

| | | | | | |
|------|----|---------------|---|----------|-----------|
| 1100 | 39 | 07/91 → | B | BA321081 | → 02-1992 |
| 1300 | 45 | 07/91 → | B | BA32108 | → 02-1992 |
| | 46 | 05/90 → | B | BA32108 | → 02-1992 |
| | 48 | 05/89 → 07/97 | B | BA32108 | → 02-1992 |
| 1500 | 50 | 07/91 → | B | BA321083 | → 02-1992 |
| | 53 | 09/91 → | B | BA321083 | → 02-1992 |

81642
350981642000

PULEGGIA

Diametro Puleggia Ø59.26
 Numero Denti/Gole Puleggia 20
 Altezza Puleggia 33.5
 Posizione Attacco 42.5
 Diametro Girante Ø69
 N° Alette Girante 8
 Posizione Girante 41.3

KW

CITROËN
Berlingo I, Van

| | | | | | |
|-------|----|---------|---|------------|-----------|
| 1.8 D | 43 | 07/96 → | D | A9A (XUD7) | 07-1996 → |
| | 43 | 07/98 → | D | A9A (XUD7) | |

| | | | | | |
|-------|----|---------------|---|----------------------------|-----------|
| 1.9 D | 50 | 07/96 → | D | D9B (XUD9A/L), DJY (XUD9A) | 07-1996 → |
| | 51 | 07/96 → 10/99 | D | DJY (XUD9A) | |
| | 51 | 07/96 → | D | DJY (XUD9A) | 07-1996 → |

C 15

| | | | | | |
|-------|----|---------------|---|-------------|--------------|
| 1.8 D | 44 | 07/86 → 12/00 | D | 161A (XUD7) | PROD →: 6265 |
|-------|----|---------------|---|-------------|--------------|

Evasion

| | | | | | |
|----------------|-----|---------------|---|--------------------------------|-----------|
| 1.9 TD | 66 | 11/94 → 07/02 | D | D8B (XUD9TF), DHX (XUD9TF/BTF) | |
| | 68 | 10/95 → 12/98 | D | D8B (XUD9TF) | |
| 2.0 | 89 | 06/94 → 07/02 | B | RFU (XU10J2/C) | 06-1994 → |
| 2.0 Turbo C.T. | 108 | 06/94 → 07/02 | B | RGX (XU10J2TE) | 06-1994 → |

Jumper I

| | | | | | |
|--------|----|---------------|---|------------------|--|
| 1.9 D | 50 | 07/99 → 04/02 | D | DJY (XUD9A) | |
| | 51 | 01/99 → 04/02 | D | D9B (XUD9A/U) | |
| 1.9 TD | 66 | 08/94 → 04/02 | D | D8C (XUD9UTF) | |
| | 66 | 03/94 → 04/02 | D | DHX (XUD9TF/BTF) | |
| | 68 | 02/94 → 04/02 | D | D8C (XUD9UTF) | |

81642
350981642000

KW

CITROËN
Jumper I

| | | | | | |
|------------|----|---------------|---|---------------|--|
| 1.9 TD 4x4 | 68 | 08/96 → 04/02 | D | D8C (XUD9UTF) | |
| 2.0 | 80 | 02/94 → 04/02 | B | RFW (XU10J2U) | |
| 2.0 4x4 | 80 | 08/96 → 04/02 | B | RFW (XU10J2U) | |

Jumper II

| | | | | | |
|--------------|----|---------|---|--------|--|
| 2.0 | 81 | 04/02 → | B | XU10J2 | |
| 2.0 bivalent | 81 | 02/03 → | | XU10J2 | |

Jumpy I

| | | | | | |
|--------|----|---------------|---|------------------|-----------|
| 1.9 D | 51 | 10/95 → 04/98 | D | D9B (XUD9A/U) | 10-1995 → |
| | 51 | 10/95 → 08/98 | D | D9B (XUD9A/U) | |
| 1.9 DT | 65 | 10/95 → 08/00 | D | | |
| 1.9 TD | 66 | 10/95 → | D | DHX (XUD9TF/BTF) | 10-1995 → |
| | 66 | 10/95 → | D | DHX (XUD9TF/BTF) | |
| | 68 | 04/96 → | D | D8B (XUD9TF) | |

Jumpy II

| | | | | | |
|--------|----|---------|---|--------------|--|
| 1.9 TD | 68 | 10/99 → | D | D8B (XUD9TF) | |
|--------|----|---------|---|--------------|--|

Xantia I, Break

| | | | | | |
|-------------|----|---------------|---|--|--------------|
| 1.9 D | 50 | 06/94 → 01/98 | D | DJZ (XUD9Y) | PROD →: 6265 |
| | 51 | 06/94 → 01/98 | D | D9B (XUD9A/L) | PROD →: 6265 |
| 1.9 SD | 55 | 02/96 → 01/98 | D | DHW (XUD9SD) | PROD →: 6265 |
| 1.9 Turbo D | 66 | 06/95 → 01/98 | D | D8B (XUD9TF), DHX (XUD9TF/BTF), DHY (XUD9TE/Y) | PROD →: 6265 |
| | 66 | 10/94 → 01/98 | D | DHX (XUD9TF/BTF), DHY (XUD9TE/Y) | PROD →: 6265 |

81642
350981642000

KW

CITROËN
Xantia I, Break

| | | | | | |
|-----------|-----|---------------|---|-------------------|-------------------------|
| 2.0 i | 89 | 03/93 → 01/98 | B | RFX (XU10J2C) | 03-1993 →, → 05-1995 |
| | 89 | 06/95 → 01/98 | B | RFX (XU10J2C) | |
| 2.0 i 16V | 97 | 06/95 → 01/98 | B | RFV (XU10J4R) | → 10-1996 |
| | 110 | 06/94 → 01/98 | B | RFT (XU10J4Z) | 06-1995 →, → 10-1996 |
| | 112 | 03/93 → 01/98 | B | RFY (XU10J4Z) | 03-1993 → |
| 2.0 Turbo | 108 | 06/95 → 01/98 | B | RGX (XU10J2TE) | 06-1995 → |

Xantia II, Break

| | | | | | |
|-------------|-----|---------------|---|---|--|
| 1.9 SD | 55 | 01/98 → 04/03 | D | DHW (XUD9SD) | |
| 1.9 Turbo D | 66 | 01/98 → 04/03 | D | D8B (XUD9TF), DHX (XUD9TF/ BTF) | |
| | 66 | 01/98 → 04/03 | D | DHX (XUD9TF/ BTF), DHY (XUD9TE/Y) | |
| 2.0 i | 89 | 01/98 → 04/03 | B | RFX (XU10J2C) | |
| 2.0 Turbo | 108 | 01/98 → 04/03 | B | RGX (XU10J2TE) | |

XM I, Break

| | | | | | |
|-------------|-----|---------------|---|--------------------|-------------------------|
| 2.0 | 84 | 05/89 → 04/94 | B | | |
| 2.0 i | 79 | 05/89 → 04/94 | B | RDZ (XU10MZ) | |
| | 89 | 05/89 → 06/94 | B | RFZ (XU10J2) | |
| 2.0 i Turbo | 104 | 09/92 → 06/94 | B | RGY (XU10J2TEZ) | 01-1993 →, → 05-1994 |
| 2.0 Turbo | 104 | 09/92 → 04/94 | B | RGY (XU10J2TEZ) | |
| 2.1 D 12V | 60 | 05/89 → 06/94 | D | P9A (XUD11A) | |

81642
350981642000

KW

CITROËN
XM II, Break

| | | | | | |
|----------------|-----|---------------|---|---|--|
| 2.0 Turbo | 108 | 05/94 → 10/00 | B | RGX (XU10J2TE) | |
| | 108 | 05/94 → 10/00 | B | RGX (XU10J2TE), RGY (XU10J2TE/Z) | |
| 2.1 D12 | 60 | 07/94 → 06/96 | D | P9A (XUD11A) | |
| 2.1 D12 VSX | 60 | 03/96 → 08/96 | D | P9A (XUD11A) | |

Xsara, Break, Coupé, Picasso, Van

| | | | | | |
|--------|----|---------------|---|---------------------------|--|
| 1.8 D | 43 | 04/97 → 09/00 | D | 161A(XUD7), A9A (XUD7) | |
| | 43 | 10/97 → 09/00 | D | A9A (XUD7) | |
| 1.8 TD | 66 | 10/97 → 09/00 | D | | |
| 1.9 D | 50 | 04/97 → 09/00 | D | DJY (XUD9A) | |
| | 55 | 01/98 → 09/00 | D | DHV (XUD9BSD) | |
| 1.9 SD | 55 | 01/98 → 09/00 | D | DHV (XUD9BSD) | |
| 1.9 TD | 66 | 04/97 → 09/00 | D | DHY (XUD9TE/Y) | |

ZX, Break

| | | | | | |
|--------|----|---------------|---|----------------------------------|-----------------------------|
| 1.8 D | 44 | 06/93 → 06/97 | D | 161A(XUD7) | |
| 1.9 D | 47 | 03/91 → 06/97 | D | DJZ (XUD9Y) | 07-1994 →, PROD →: 6171 |
| | 50 | 06/94 → 10/97 | D | D9B (XUD9A/U) | 07-1994 →, PROD →: 6.171 |
| | 50 | 07/93 → 06/97 | D | D9B (XUD9A/U), DJY (XUD9A) | 07-1994 →, PROD →: 6.171 |
| 1.9 TD | 66 | 07/92 → 06/97 | D | DHY (XUD9TE/Y) | 07-1994 →, PROD →: 6171 |
| 2.0 i | 89 | 07/92 → 06/97 | B | RFX (XU10J2C) | |

FIAT
Ducato III

| | | | | | |
|--------|----|---------------|---|-----------------------------|--|
| 1.9 D | 50 | 04/98 → 04/02 | D | D9B, D9B (XUD9A), DJY | |
| | 50 | 04/98 → 04/02 | D | DJY | |
| 1.9 TD | 66 | 04/98 → 04/02 | D | DHX (XUD9TF/L) | |
| 2.0 | 80 | 03/94 → 04/02 | B | RFW | |

81642 350981642000

FIAT
Ducato III

| | | | | | |
|----------------------------|----|---------------|---|-----|--|
| 2.0 4x4 | 80 | 11/94 → 11/01 | B | RFW | |
| 2.0 Panorama/ Combinato | 80 | 03/94 → 04/02 | B | RFW | |

Ducato IV

| | | | | | |
|-------------|----|---------------|---|-----|--|
| 2.0 | 81 | 04/02 → | B | RFL | |
| 2.0 4x4 | 81 | 05/02 → 07/06 | B | RFL | |
| 2.0 Bipower | 81 | 11/02 → | | RFL | |

Scudo I

| | | | | | |
|------------|----|---------------|---|--------------------------|--|
| 1.9 D | 51 | 04/98 → 12/06 | D | WJY (DW8B), WJZ (DW8) | |
| | 51 | 04/98 → 12/06 | D | WJZ (DW8) | |
| | 51 | 02/96 → 04/98 | D | D9B | |
| 1.9 TD | 66 | 02/96 → 12/06 | D | DHX (XUD9TF/L) | |
| | 68 | 02/96 → 12/06 | D | D8B | |
| 1.9 TD Eco | 66 | 02/96 → 12/06 | D | DHX (XUD9TF/L) | |

Ulysse I

| | | | | | |
|-----------|-----|---------------|---|-----------------|-----------|
| 1.9 TD | 66 | 02/95 → 08/02 | D | DHX (XUD9TF/L) | 05-1995 → |
| 2.0 | 89 | 06/94 → 08/02 | B | RFU (XU10J2C) | |
| 2.0 Turbo | 108 | 06/94 → 08/02 | B | RGX (XU10J2CTE) | |

HYUNDAI
Lantra II, Station Wagon

| | | | | | |
|-------|----|---------------|---|-----|--|
| 1.9 D | 50 | 03/98 → 09/00 | D | DJY | |
|-------|----|---------------|---|-----|--|

LANCIA
Zeta

| | | | | | |
|-----------|-----|---------------|---|----------------|--|
| 2.0 Turbo | 108 | 05/95 → 09/02 | B | RGX (XU10J2TE) | |
|-----------|-----|---------------|---|----------------|--|

PEUGEOT
205 II, Van

| | | | | | |
|------------|----|---------|---|-------------|--|
| 1.7 Diesel | 44 | 03/94 → | D | 161A (XUD7) | |
|------------|----|---------|---|-------------|--|

306, Station Wagon, Coupé, Cabrio, Van

| | | | | | |
|--------|----|---------------|---|---------------|--------------|
| 1.8 D | 43 | 05/93 → 05/01 | D | A9A (XUD7) | PROD →: 7391 |
| 1.9 D | 47 | 05/93 → 05/01 | D | DJZ (XUD9Y) | PROD →: 7391 |
| | 50 | 06/94 → 05/01 | D | DJY (XUD9A) | PROD →: 7391 |
| | 55 | 03/98 → 05/01 | D | DHV (XUD9BSD) | PROD →: 7391 |
| 1.9 DT | 66 | 05/93 → 05/01 | D | DHY (XUD9TE) | PROD →: 7391 |

81642 350981642000

PEUGEOT
306, Station Wagon, Coupé, Cabrio, Van

| | | | | | |
|----------|-----|---------------|---|---------------|--------------|
| 1.9 SLD | 47 | 06/94 → 05/01 | D | DJZ (XUD9Y) | PROD →: 7391 |
| | 50 | 06/94 → 05/01 | D | DJY (XUD9A) | PROD →: 7391 |
| 1.9 SRDT | 66 | 06/94 → 05/01 | D | DHY (XUD9TE) | PROD →: 7391 |
| 1.9 TD | 66 | 02/97 → 04/02 | D | DHY (XUD9TE) | PROD →: 7391 |
| 2.0 | 89 | 03/94 → 04/02 | B | RFX (XU10J2) | |
| 2.0 S16 | 110 | 06/94 → 05/01 | B | RFT (XU10J4) | |
| | 112 | 06/94 → 05/01 | B | RFY (XU10J4Z) | |
| 2.0 ST | 89 | 07/94 → 05/01 | B | RFX (XU10J2) | |
| 2.0 XSi | 89 | 05/93 → 05/01 | B | RFX (XU10J2) | |

405 II, Station Wagon

| | | | | | |
|-------------|-----|---------------|---|-----------------|--|
| 2.0 | 89 | 08/92 → 10/95 | B | RFX (XU10J2) | |
| 2.0 16V | 110 | 06/94 → 10/95 | B | RFT (XU10J4) | |
| 2.0 4x4 | 89 | 08/92 → 10/96 | B | RFX (XU10J2) | |
| 2.0 MI-16 | 112 | 08/92 → 10/95 | B | RFY (XU10J4Z) | |
| 2.0 T 16 X4 | 144 | 08/92 → 10/95 | B | RGZ (XU10J4TEZ) | |
| 2.0 X4 | 89 | 08/92 → 10/95 | B | RFX (XU10J2) | |

407, Station Wagon, Coupé

| | | | | | |
|-----------|-----|---------------|---|----------------|--|
| 1.9 D | 55 | 10/96 → 05/04 | D | DHW (XUD9SD) | |
| 1.9 TD | 66 | 01/96 → 05/04 | D | DHX (XUD9TE) | |
| | 68 | 01/96 → 05/04 | D | DHY (XUD9TE) | |
| 2.0 Turbo | 108 | 04/96 → 05/04 | B | RGX (XU10J2TE) | |

605

| | | | | | |
|-----|----|---------------|---|---------------|--|
| 2.0 | 79 | 02/90 → 09/99 | B | | |
| | 84 | 06/89 → 09/99 | B | R5A (XU102C) | |
| | 89 | 06/89 → 09/99 | B | RFZ (XU10J2Z) | |

81642
350981642000

KW

PEUGEOT
605

| | | | | |
|-----------|-----|---------------|---|----------------|
| 2.0 Turbo | 104 | 07/92 → 09/99 | B | RGY (XU10J2TE) |
| | 108 | 07/91 → 09/99 | B | RGX (XU10J2TE) |
| 2.1 D | 60 | 06/89 → 07/95 | D | P9A (XUD11A) |

806

| | | | | |
|-----------|-----|---------------|---|----------------|
| 1.9 TD | 66 | 07/95 → 08/02 | D | DHX (XUD9TE) |
| | 68 | 05/97 → 08/02 | D | DHY (XUD9TE) |
| 2.0 | 89 | 06/94 → 08/02 | B | RFU (XU10J2) |
| 2.0 Turbo | 108 | 06/94 → 08/02 | B | RGX (XU10J2TE) |

Boxer I

| | | | | |
|------------|----|---------------|---|-----------------------|
| 1.9 D | 50 | 07/99 → 04/02 | D | DJY (XUD9A) |
| | 51 | 03/94 → 04/02 | D | D9B (XUD9AU) |
| 1.9 DT 4x4 | 66 | 03/96 → 09/98 | D | XUD9TE |
| 1.9 TD | 66 | 08/94 → 04/02 | D | DHY (XUD9TE) |
| 1.9 TD | 66 | 06/94 → 04/02 | D | DHY (XUD9TE), XUD9TE |
| | 66 | 07/99 → 04/02 | D | XUD9TE |
| | 68 | 03/94 → 04/02 | D | D8C (XUD9UTF) |
| | 68 | 07/94 → 04/02 | D | D8C (XUD9UTF), XUD9TE |
| 1.9 TD 4x4 | 68 | 07/96 → 04/02 | D | D8C (XUD9UTF) |
| 2.0 | 81 | 12/01 → 04/02 | B | RFL (XU10J2U) |
| 2.0 4x4 | 80 | 03/96 → 09/98 | B | |
| 2.0 i | 80 | 03/94 → 04/02 | B | RFW (XU10J2) |
| 2.0 i 4x4 | 80 | 08/96 → 04/02 | B | RFW (XU10J2) |

Boxer II

| | | | | |
|-----|----|---------|---|---------------|
| 2.0 | 81 | 04/02 → | B | RFL (XU10J2U) |
|-----|----|---------|---|---------------|

81642
350981642000

KW

PEUGEOT
Expert I

| | | | | |
|--------|----|---------------|---|-----------------------|
| 1.9 D | 51 | 06/98 → 11/03 | D | WJY (DW8B), WJZ (DW8) |
| | 51 | 02/96 → | D | D9B (XUD9AU) |
| 1.9 TD | 66 | 02/96 → | D | DHX (XUD9TE) |
| | 68 | 02/96 → | D | D8B (XUD9TE) |

Partner I

| | | | | |
|-------|----|---------------|---|-----------------------|
| 1.8 D | 44 | 11/96 → 02/98 | D | A9A (XUD7) |
| 1.9 D | 51 | 12/98 → | D | WJY (DW8B), WJZ (DW8) |
| | 50 | 06/96 → | D | DJY (XUD9A) |
| | 51 | 06/96 → | D | DJY (XUD9A) |
| | 51 | 05/96 → 12/98 | D | XUD9 |

SUZUKI
Baleno, Station Wagon

| | | | | |
|--------|----|---------------|---|-----------------------------|
| 1.9 TD | 55 | 04/98 → 05/02 | D | DHV (XUD9BSD), DHW (XUD9SD) |
| | 55 | 04/98 → 05/02 | D | DHW (XUD9SD) |

Samurai

| | | | | |
|--------|----|---------------|---|------|
| 1.9 TD | 46 | 11/98 → 12/04 | D | XUD9 |
|--------|----|---------------|---|------|

Vitara

| | | | | |
|--------------------------|----|---------------|---|--------|
| 1.9 D | 50 | 01/95 → 03/98 | D | XUD9A |
| | 55 | 08/96 → 03/99 | D | XUD9SD |
| 1.9 D Trazione integrale | 50 | 01/95 → 03/98 | D | XUD9A |
| | 55 | 08/96 → 03/98 | D | XUD9SD |

81650
350981650000

FLANGIA

| | |
|-------------------------|-------|
| Numero Fori Flangia | 3 |
| Dimensione Fori Flangia | M6×1 |
| Posizione Attacco | 69.7 |
| Diametro Mozzo | Ø23.5 |
| Diametro Girante | Ø57 |
| N° Alette Girante | 8 |
| Posizione Girante | 12 |

KW

FORD
Escort IV, Station Wagon, Cabrio, Express

| | | | | | |
|-----|----|---------------|---|---------------|----------------------|
| 1.3 | 44 | 02/86 → 07/90 | B | JBB, JLA, JLB | |
| | 46 | 07/88 → 07/90 | B | JBA | |
| | 46 | 07/88 → 10/90 | B | JBA | 02-1986 →, → 04-1991 |

Escort V, Station Wagon, Cabrio, Express

| | | | | | |
|-----|----|---------------|---|----------|-----------|
| 1.3 | 44 | 07/90 → 09/92 | B | J4B, J6A | → 04-1991 |
|-----|----|---------------|---|----------|-----------|

Fiesta III, Van

| | | | | | |
|-----|----|---------------|---|----------|-----------|
| 1.0 | 33 | 03/89 → 12/95 | B | TLB | → 04-1991 |
| 1.1 | 37 | 03/89 → 12/95 | B | G6A | → 04-1991 |
| | 40 | 03/89 → 12/95 | B | GUD, GUE | → 04-1991 |
| 1.3 | 44 | 03/89 → 12/92 | B | JBC | → 04-1991 |

Orion III

| | | | | | |
|-----|----|---------------|---|----------|-----------|
| 1.3 | 44 | 07/90 → 12/93 | B | J4B, J6A | → 04-1991 |
|-----|----|---------------|---|----------|-----------|

81651
350981651000

PULEGGIA

| | |
|-------------------|-------|
| Diametro Puleggia | Ø50 |
| Altezza Puleggia | 23 |
| Posizione Attacco | 38.5 |
| Diametro Girante | Ø71.5 |
| N° Alette Girante | 9 |
| Posizione Girante | 12.5 |

KW

FORD
Escort IV, Station Wagon, Cabrio, Express

| | | | | | |
|-------|----|---------------|---|----------|-----------|
| 1.8 D | 44 | 07/88 → 07/90 | D | RTA, RTB | |
| | 44 | 01/89 → 07/90 | D | RTA, RTB | 01-1990 → |

Escort V, Station Wagon, Cabrio, Express

| | | | | | |
|-------|----|---------------|---|---------------|--|
| 1.8 D | 44 | 07/90 → 12/92 | D | RTE, RTF, RTH | |
| | 44 | 07/90 → 12/94 | D | RTH | |

81651
350981651000

KW

FORD
Escort VI, Station Wagon, Cabrio

| | | | | | |
|-------|----|---------------|---|---------------|-----------|
| 1.8 D | 44 | 09/92 → 01/95 | D | RTE, RTF, RTH | |
| | 44 | 08/93 → 01/95 | D | RTE, RTF, RTH | 01-1990 → |
| | 44 | 09/92 → 01/95 | D | RTH | 01-1990 → |

Escort VII, Station Wagon, Cabrio, Express

| | | | | | |
|-------|----|---------------|---|---------------|--|
| 1.8 D | 44 | 01/95 → 12/96 | D | RTE, RTF, RTH | |
| | 44 | 01/95 → | D | RTF, RTH | |

Fiesta II, Van

| | | | | | |
|-------|----|---------------|---|---------------|--|
| 1.8 D | 43 | 03/89 → 12/95 | D | RTC, RTD, RTG | |
|-------|----|---------------|---|---------------|--|

Fiesta III, Van

| | | | | | |
|-------|----|---------------|---|---------------|--|
| 1.8 D | 44 | 09/91 → 02/96 | D | RTC, RTD, RTG | |
|-------|----|---------------|---|---------------|--|

Fiesta IV, Van

| | | | | | |
|-------|----|---------------|---|----------|-----------|
| 1.8 D | 44 | 08/95 → 04/00 | D | RTJ, RTK | |
| | 44 | 02/96 → 04/02 | D | RTK | 01-1989 → |
| D 1.8 | 44 | 05/98 → 04/02 | D | RTJ, RTK | |

Orion II

| | | | | | |
|-------|----|---------------|---|----------|--|
| 1.8 D | 44 | 01/89 → 07/90 | D | RTA, RTB | |
|-------|----|---------------|---|----------|--|

Orion III

| | | | | | |
|-------|----|---------------|---|---------------|--|
| 1.8 D | 44 | 11/90 → 12/93 | D | RTE, RTF, RTH | |
|-------|----|---------------|---|---------------|--|

MAZDA
121

| | | | | | |
|-------|----|---------------|---|----------|--|
| 1.8 D | 44 | 03/96 → 04/03 | D | RTJ, RTK | |
|-------|----|---------------|---|----------|--|

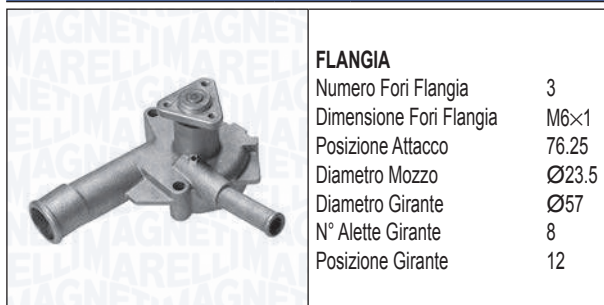
81653
350981653000

FLANGIA

| | |
|-------------------------|-------|
| Numero Fori Flangia | 3 |
| Dimensione Fori Flangia | M6×1 |
| Posizione Attacco | 76.25 |
| Diametro Mozzo | Ø23.5 |
| Diametro Girante | Ø57 |
| N° Alette Girante | 8 |
| Posizione Girante | 12 |

KW

FORD
Escort V, Station Wagon, Cabrio, Express

| | | | | | |
|-----|----|---------------|---|----------|-----------|
| 1.3 | 44 | 07/90 → 09/92 | B | J4B, J6A | 05-1991 → |
| | 44 | 09/91 → 09/92 | B | J4B, J6A | |
| | 46 | 07/90 → 12/94 | B | JBD | 05-1991 → |

81653
350981653000

FORD
Escort VI, Station Wagon, Cabrio

| | | | | | |
|-----|----|---------------|---|----------|--|
| 1.3 | 44 | 09/92 → 01/95 | B | J4B, J6A | |
|-----|----|---------------|---|----------|--|

Escort VII, Station Wagon, Cabrio, Express

| | | | | | |
|-----|----|---------------|---|----------|--|
| 1.3 | 44 | 01/95 → 10/98 | B | J4B, J6A | |
|-----|----|---------------|---|----------|--|

Fiesta III, Van

| | | | | | |
|-----|----|---------------|---|-----|-----------|
| 1.0 | 33 | 03/89 → 12/95 | B | TLB | 05-1991 → |
|-----|----|---------------|---|-----|-----------|

| | | | | | |
|-----|----|---------------|---|----------|-----------|
| 1.1 | 37 | 03/89 → 12/95 | B | G6A | 05-1991 → |
| | 40 | 03/89 → 12/95 | B | GUD, GUE | 05-1991 → |

| | | | | | |
|-----|----|---------------|---|-----|-----------|
| 1.3 | 44 | 09/91 → 02/96 | B | J6B | |
| | 44 | 03/89 → 12/92 | B | JBC | 05-1991 → |

| | | | | | |
|----------|----|---------------|---|-----|--|
| 1.3 Cat. | 44 | 05/91 → 01/97 | B | J6B | |
|----------|----|---------------|---|-----|--|

Fiesta IV, Van

| | | | | | |
|-----|----|---------|---|-----|--|
| 1.3 | 44 | 02/96 → | B | J4C | |
|-----|----|---------|---|-----|--|

Orion III

| | | | | | |
|-----|----|---------------|---|----------|-----------|
| 1.3 | 44 | 07/90 → 12/93 | B | J4B, J6A | 05-1991 → |
|-----|----|---------------|---|----------|-----------|

81654
350981654000

FORD
Sierra II, Station Wagon

| | | | | | |
|-------|----|---------------|---|----------|-----------|
| 2.0 i | 85 | 01/87 → 02/93 | B | N4A, N4I | → 01-1991 |
| | 88 | 01/90 → 02/93 | B | N9C | → 01-1991 |
| | 92 | 06/89 → 02/93 | B | N9B | → 01-1991 |
| | 92 | 01/90 → 02/93 | B | N9C | → 01-1991 |

Transit VII

| | | | | | |
|-----|-----|---------------|---|------|--|
| 2.3 | 105 | 03/01 → 03/06 | B | E5FC | |
| | 107 | 08/00 → 03/06 | B | E5FA | |

| | | | | | |
|---------|-----|---------------|---|------------|--|
| 2.3 16V | 107 | 04/01 → 05/06 | B | E5FA, E5FC | |
|---------|-----|---------------|---|------------|--|

| | | | | | |
|---------------|-----|---------------|---|------------|--|
| 2.3 16V [RWD] | 107 | 08/00 → 05/06 | B | E5FA, E5FC | |
|---------------|-----|---------------|---|------------|--|

Transit XIII

| | | | | | |
|---------------|-----|---------------|---|------------------|--|
| 2.3 16V [RWD] | 107 | 04/06 → 08/14 | B | GZFA, GZFB, GZFC | |
|---------------|-----|---------------|---|------------------|--|

81654
350981654000

FLANGIA

| | |
|-------------------------|---------|
| Numero Fori Flangia | 4 |
| Dimensione Fori Flangia | M8×1.25 |
| Posizione Attacco | 102.6 |
| Diametro Mozzo | Ø23.4 |
| Diametro Girante | Ø65 |
| N° Alette Girante | 8 |
| Posizione Girante | 34.25 |

FORD
Escort V, Station Wagon, Cabrio, Express

| | | | | | |
|---------|-----|---------------|---|-----|-----------|
| RS 2000 | 110 | 05/91 → 12/92 | B | N7A | → 06-1991 |
|---------|-----|---------------|---|-----|-----------|

Scorpio I, Station Wagon

| | | | | | |
|-----|----|---------------|---|-----|-----------|
| 2.0 | 77 | 03/90 → 08/92 | B | N8B | → 01-1991 |
| | 80 | 11/88 → 10/92 | B | N8A | → 01-1991 |
| | 80 | 06/89 → 03/93 | B | N8B | → 01-1991 |

| | | | | | |
|-------|----|---------------|---|----------|----------------------|
| 2.0 i | 85 | 04/85 → 02/92 | B | NRA, NRI | 01-1989 →, → 01-1991 |
| | 88 | 05/89 → 09/94 | B | N9D | → 01-1991 |
| | 92 | 05/89 → 02/92 | B | N9B | → 01-1991 |

Scorpio II, Station Wagon

| | | | | | |
|-----------|-----|---------------|---|-----|--|
| 2.3 i 16V | 108 | 06/96 → 08/98 | B | Y5A | |
|-----------|-----|---------------|---|-----|--|

Sierra II, Station Wagon

| | | | | | |
|-----|----|---------------|---|----------|-----------|
| 2.0 | 77 | 01/87 → 02/93 | B | N8C, NES | → 01-1991 |
|-----|----|---------------|---|----------|-----------|

| | | | | | |
|---------|----|---------------|---|-----|-----------|
| 2.0 4x4 | 88 | 02/90 → 02/93 | B | N9C | → 01-1991 |
| | 92 | 01/90 → 02/93 | B | N9C | → 01-1991 |

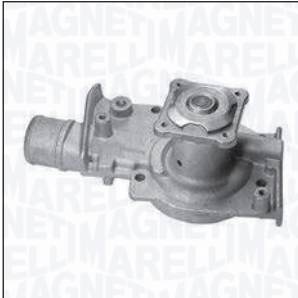
81655
350981655000

FLANGIA

| | |
|-------------------------|-------|
| Numero Fori Flangia | 4 |
| Dimensione Fori Flangia | M6×1 |
| Posizione Attacco | 82.85 |
| Diametro Centraggio | Ø58 |
| Diametro Girante | Ø82 |
| N° Alette Girante | 6 |
| Posizione Girante | 9.5 |

FORD
Escort V, Station Wagon, Cabrio, Express

| | | | | | |
|---------|----|---------------|---|-----|--|
| 1.8 16V | 77 | 02/92 → 12/92 | B | RDA | |
|---------|----|---------------|---|-----|--|

| | | | | | |
|--------------|----|---------------|---|-----|--|
| 1.8 16V XR3i | 77 | 02/92 → 12/92 | B | RDA | |
| | 96 | 02/92 → 12/92 | B | RQB | |

| | | | | | |
|--------------|----|---------------|---|-----|--|
| 1.8 16V XR3i | 96 | 02/92 → 12/92 | B | RQB | |
|--------------|----|---------------|---|-----|--|

Escort VI, Station Wagon, Cabrio

| | | | | | |
|--------------|----|---------------|---|-----|--|
| 1.6 16V XR3i | 66 | 12/92 → 01/95 | B | L1E | |
| | 65 | 01/94 → 01/95 | B | L1H | |

| | | | | | |
|-----------|----|---------------|---|----------|--|
| 1.6 i 16V | 66 | 09/92 → 01/95 | B | L1E | |
| | 66 | 08/93 → 01/95 | B | L1E, L1K | |

| | | | | | |
|--------------|----|---------------|---|-----|--|
| 1.8 16V XR3i | 77 | 12/92 → 01/95 | B | RDA | |
| | 96 | 09/92 → 01/95 | B | RQB | |

| | | | | | |
|-----------|----|---------------|---|-----|-----------|
| 1.8 i 16V | 77 | 09/92 → 01/95 | B | RDA | |
| | 77 | 01/93 → 01/95 | B | RDA | 01-1990 → |

| | | | | | |
|-----------|----|---------------|---|-----|--|
| 1.8 i 16V | 96 | 02/93 → 01/95 | B | RQB | |
| | 77 | 08/93 → 01/95 | B | RDA | |

| | | | | | |
|------------------|----|---------------|---|-----|--|
| 1.8 XR3i 16V 4x4 | 77 | 08/93 → 01/95 | B | RDA | |
| | 96 | 08/93 → 01/95 | B | RQB | |

81655 **350981655000**

FORD
Escort VII, Station Wagon, Cabrio, Express

| | | | | |
|--------------|----|---------------|---|----------|
| 1.6 16V | 66 | 01/95 → 10/98 | B | L1E |
| 1.6 16V 4x4 | 66 | 01/95 → 10/98 | B | L1E |
| 1.6 16V XR3i | 65 | 02/95 → 12/96 | B | L1H |
| | 66 | 02/95 → 09/99 | B | L1E |
| 1.6 i 16V | 65 | 01/95 → 08/95 | B | L1H |
| | 66 | 01/95 → 02/99 | B | L1E, L1K |
| 1.8 16V | 77 | 01/95 → 08/95 | B | RDA |
| | 85 | 01/95 → 10/98 | B | RKC |
| 1.8 16V XR3i | 77 | 02/95 → 08/98 | B | RDA |
| | 85 | 10/95 → 08/98 | B | RKC |
| | 96 | 02/95 → 08/00 | B | RQB |

Fiesta III, Van

| | | | | |
|--------------|----|---------------|---|-----|
| 1.6 i 16V | 65 | 01/94 → 12/95 | B | L1G |
| 1.8 16V | 77 | 02/92 → 12/95 | B | RDB |
| 1.8 XR2i 16V | 96 | 02/92 → 12/95 | B | RQC |

Orion III

| | | | | |
|-----------|----|---------------|---|----------|
| 1.6 i 16V | 66 | 07/92 → 12/93 | B | L1E, L1K |
| 1.8 i 16V | 77 | 02/92 → 12/93 | B | RDA |
| | 96 | 01/92 → 12/93 | B | RQB |

81656 **350981656000**

FORD
Mondeo I, Station Wagon

| | | | | |
|--------|----|---------------|---|----------|
| 1.8 TD | 65 | 06/93 → 08/96 | D | RFM, RFN |
| | 66 | 10/95 → 08/96 | D | RFM, RFN |

Mondeo II, Station Wagon

| | | | | |
|--------|----|---------------|---|-----|
| 1.8 TD | 66 | 08/96 → 09/00 | D | RFN |
|--------|----|---------------|---|-----|

81657 **350981657000**

FORD
Escort Classic

| | | | | |
|--------|----|---------------|---|----------|
| 1.8 TD | 66 | 10/98 → 07/00 | D | RFD, RFK |
|--------|----|---------------|---|----------|

Escort VI, Station Wagon, Cabrio

| | | | | |
|--------|----|---------------|---|---------------|
| 1.8 TD | 66 | 02/93 → 01/95 | D | RFD, RFK |
| | 66 | 02/93 → 01/95 | D | RFD, RFK, RFS |

Escort VII, Station Wagon, Cabrio, Express

| | | | | |
|-------------|----|---------------|---|----------|
| 1.8 TD | 66 | 01/95 → 10/98 | D | RFD, RFK |
| 1.8 Turbo D | 51 | 12/95 → 06/01 | D | RVA |

Fiesta III, Van

| | | | | |
|--------|----|---------------|---|-----|
| 1.8 TD | 55 | 03/93 → 12/95 | D | RFL |
|--------|----|---------------|---|-----|

Orion III

| | | | | |
|--------|----|---------------|---|----------|
| 1.8 TD | 66 | 03/92 → 12/93 | D | RFD, RFK |
|--------|----|---------------|---|----------|

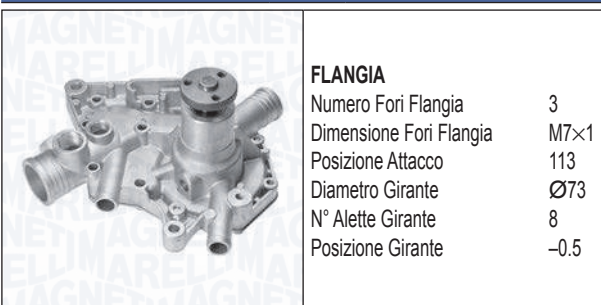
81660 **350981660000**

RENAULT
4

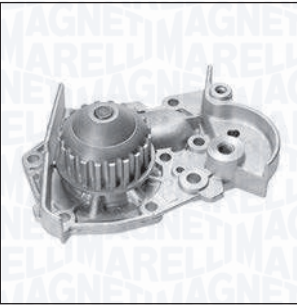
| | | | | |
|-----|----|---------------|---|--------|
| 1.0 | 25 | 06/87 → 12/93 | B | C1C708 |
| | 31 | 12/85 → 06/93 | B | 689710 |
| | 25 | 06/87 → 06/93 | B | C1C708 |
| 1.1 | 32 | 06/86 → 06/90 | B | C1E714 |

81661
350981661000

PULEGGIA

Diametro Puleggia Ø59.26
 Numero Denti/Gole Puleggia 20
 Altezza Puleggia 20.8
 Posizione Attacco 46.1
 Diametro Girante Ø60
 N° Alette Girante 6
 Posizione Girante 19.5

RENAULT
19 I, Chamade, Cabrio

| | | | | |
|-----|----|---------------|---|-------------------|
| 1.4 | 55 | 09/90 → 04/92 | B | E7J700 |
| | 57 | 07/88 → 08/90 | B | E6J700, E6J701 |
| | 59 | 01/88 → 12/92 | B | E6J700 |
| | 59 | 01/88 → 12/92 | B | E6J700, E6J701 |

19 II, Chamade, Cabrio

| | | | | |
|-----|----|---------------|---|-------------------|
| 1.2 | 44 | 05/92 → 09/94 | B | E7F730 |
| | 40 | 03/92 → 12/95 | B | C1G730 |
| 1.4 | 59 | 03/92 → 12/95 | B | E6J700 |
| | 59 | 01/92 → 12/95 | B | E6J700, E7J706 |
| | 59 | 10/94 → 11/95 | B | E7J706 |
| | 55 | 01/92 → 12/95 | B | E7J742 |

Clio I

| | | | | |
|-----|----|---------------|---|------------------------------|
| 1.2 | 40 | 01/91 → 09/98 | B | E7F706 |
| | 44 | 01/91 → 09/98 | B | E7F750 |
| | 40 | 01/91 → 06/96 | B | E7F706 |
| | 43 | 05/90 → 09/98 | B | E7F700, E7F708, E7F750 |
| | 44 | 05/90 → 03/96 | B | E5F710 |

| | | | | |
|-----|----|---------------|---|---|
| 1.4 | 59 | 01/91 → 09/98 | B | E7J710, E7J711 |
| | 55 | 01/91 → 09/98 | B | E7J756, E7J757 |
| | 58 | 01/91 → 09/98 | B | E7J601, E7J718, E7J719, E7J754 |

Rapid

| | | | | |
|-----|----|---------------|---|---|
| 1.4 | 55 | 09/91 → 03/98 | B | E7J720, E7J724, E7J726, E7J773 |
| | 58 | 01/94 → 03/98 | B | E7J728 |

81661
350981661000

RENAULT
Thalia I

| | | | | |
|-----|----|---------------|---|-------------------|
| 1.2 | 43 | 02/98 → 10/03 | B | D7F744, D7F746 |
|-----|----|---------------|---|-------------------|

81664
350981664000

FLANGIA

Numero Fori Flangia 4
 Dimensione Fori Flangia M8×1.25
 Posizione Attacco 90
 Diametro Mozzo Ø23.8
 Diametro Girante Ø69
 N° Alette Girante 9
 Posizione Girante 17.3

RENAULT
Trafic I

| | | | | |
|-------|----|---------------|---|-------------------------|
| 2.1 D | 43 | 05/89 → 06/94 | D | 852720, 852750 |
| 2.1 D | 43 | 05/89 → 06/94 | D | 852750 |
| | | | | 01-1981 →, → 12-1995 |

81666
350981666000

FLANGIA

Numero Fori Flangia 3
 Dimensione Fori Flangia M8×1.25
 Posizione Attacco 71
 Diametro Centraggio Ø51
 Diametro Girante Ø68
 N° Alette Girante 8
 Posizione Girante 17.3

RENAULT
21, Station Wagon

| | | | | | |
|-----|----|---------------|---|---|----------------|
| 2.0 | 78 | 05/91 → 10/93 | B | J6R758 | M →: F.197.764 |
| | 75 | 03/86 → 10/93 | B | J6R758, J6R759, J6R792, J6R793 | M →: F.197.764 |
| | 88 | 09/89 → 12/93 | B | J7R746, J7R747 | M →: F.197.764 |
| | 99 | 02/90 → 10/92 | B | J7R740 | M →: F.197.764 |

81666 350981666000

RENAULT
Sierra II, Station Wagon

| | | | | | |
|---------|----|---------------|---|-------------------|----------------|
| 2.0 4x4 | 88 | 03/89 → 12/93 | B | J7R746, J7R747 | M →: F.197.764 |
| | 99 | 09/90 → 10/92 | B | J7R740 | M →: F.197.764 |
| 2.2 | 79 | 09/89 → 06/94 | B | J7T754, J7T755 | M →: F241.443 |
| 2.2 4x4 | 79 | 07/90 → 06/94 | B | J7T754, J7T755 | M →: F241.443 |

25

| | | | | | |
|---------|-----|---------------|---|------------------------------|--|
| 2.0 | 88 | 03/87 → 12/93 | B | J7R722, J7R723 | |
| 2.0 12V | 103 | 06/88 → 12/93 | B | J7R720, J7R721 | |
| | 99 | 06/89 → 12/92 | B | J7R726 | |
| 2.2 | 79 | 09/86 → 12/92 | B | J7T708, J7T732, J7T733 | |

Espace II

| | | | | | |
|---------|----|---------------|---|------------------------------|--|
| 2.0 | 76 | 01/91 → 10/96 | B | J7R768 | |
| 2.2 | 79 | 01/91 → 10/96 | B | J7T772, J7T773, J7T776 | |
| 2.2 4x4 | 79 | 03/91 → 12/96 | B | J7T772, J7T773 | |

Master I

| | | | | | |
|--------|----|---------------|---|-------------------|---------------|
| 30 2,2 | 67 | 08/80 → 07/98 | B | J7T782, J7T788 | M →: F305.273 |
|--------|----|---------------|---|-------------------|---------------|

Trafic I

| | | | | | |
|-----|----|---------------|---|--------|-----------------------------|
| 2.0 | 59 | 05/89 → 08/90 | B | J5R716 | 01-1981 →, M →: F029.329 |
| 2.2 | 74 | 06/94 → 10/97 | B | J7T600 | 01-1981 →, M →: F305.273 |

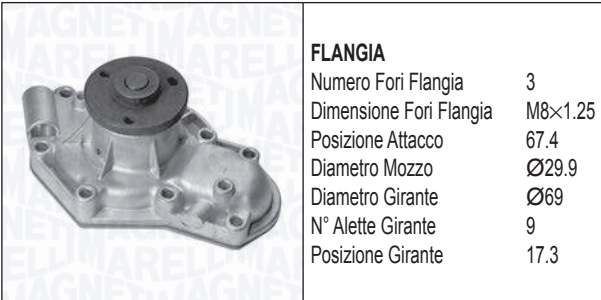
81667 350981667000

FLANGIA

| | |
|-------------------------|---------|
| Numero Fori Flangia | 3 |
| Dimensione Fori Flangia | M8×1.25 |
| Posizione Attacco | 67.4 |
| Diametro Mozzo | Ø29.9 |
| Diametro Girante | Ø69 |
| N° Alette Girante | 9 |
| Posizione Girante | 17.3 |

RENAULT
Espace II

| | | | | | |
|--------------------|----|---------------|---|---|--|
| 2.1 RTDT Quadra | 65 | 01/91 → 05/92 | D | J8S772 | |
| 2.1 TD | 65 | 01/91 → 10/96 | D | J8S610, J8S772, J8S776, J8S778 | |
| | 66 | 11/94 → 10/96 | D | J8S612 | |

81671 350981671000

ALBERINO

| | |
|-----------------------|---------|
| Versione | BC |
| Diametro Alberino | M14×1.5 |
| Tipo Filetto Alberino | Maschio |
| Posizione Attacco | 134 |
| Diametro Girante | Ø56 |
| N° Alette Girante | 6 |
| Posizione Girante | 12 |

PEUGEOT
305 II, Station Wagon

| | | | | | |
|-----|----|---------------|---|------------|--------|
| 1.5 | 50 | 09/85 → 07/90 | B | 142 (XR5A) | VF, BC |
|-----|----|---------------|---|------------|--------|

81672

350981672000



PULEGGIA
 Diametro Puleggia Ø59.26
 Numero Denti/Gole Puleggia 20
 Altezza Puleggia 33.5
 Posizione Attacco 42.5
 Diametro Girante Ø69
 N° Alette Girante 8
 Posizione Girante 41.3



CITROËN

BX, Break

| | | | | | |
|------------|----|---------------|---|---|----------------------------|
| 1.8 D | 44 | 10/85 → 09/93 | D | 161 (XUD7) | 01-1987 →, PROD →: 3584 |
| 1.9 DT TXD | 66 | 02/92 → 12/94 | D | | |
| 1.9 RD 4x4 | 52 | 01/87 → 01/92 | D | | PROD →: 3584 |
| 18 D | 44 | 10/85 → 09/93 | D | 161A (XUD7) | 01-1987 →, PROD →: 3584 |
| 19 D | 47 | 09/83 → 09/93 | D | 162 (XUD9), D9A (XUD9), DJZ (XUD9Y) | 01-1987 →, PROD →: 3584 |
| | 51 | 03/87 → 02/93 | D | D9B (XUD9A/U) | PROD →: 3584 |
| TRD Turbo | 66 | 03/88 → 02/93 | D | A8A (XUD7TE), AJZ (XUD7TE) | |
| | 66 | 03/88 → 12/94 | D | A8A (XUD7TE), AJZ (XUD7TE) | PROD →: 3584 |

C 15

| | | | | | |
|-------|----|---------------|---|-------------|-------------------------------|
| 1.8 D | 44 | 07/86 → 12/00 | D | 161A (XUD7) | PROD →: 3584, → PROD: 6264 |
|-------|----|---------------|---|-------------|-------------------------------|

Xantia I, Break

| | | | | | |
|-------------|----|---------------|---|---|--------------|
| 1.9 D | 50 | 06/94 → 01/98 | D | DJZ (XUD9Y) | → PROD: 6264 |
| | 51 | 06/94 → 01/98 | D | D9B (XUD9A/L) | → PROD: 6264 |
| 1.9 SD | 55 | 02/96 → 01/98 | D | DHW (XUD9SD) | → PROD: 6264 |
| 1.9 Turbo D | 66 | 06/95 → 01/98 | D | D8B (XUD9TF), DHX (XUD9TF/ BTF), DHY (XUD9TE/Y) | → PROD: 6264 |

81672

350981672000



CITROËN

Xantia I, Break

| | | | | | |
|-------------|----|---------------|---|--------------------------------------|--------------|
| 1.9 Turbo D | 66 | 10/94 → 01/98 | D | DHX (XUD9TF/ BTF), DHY (XUD9TE/Y) | → PROD: 6264 |
|-------------|----|---------------|---|--------------------------------------|--------------|

ZX, Break

| | | | | | |
|-----------|-----|---------------|---|-----------------------------------|----------------------------|
| 1.9 D | 47 | 03/91 → 06/97 | D | DJZ (XUD9Y) | → 06-1994, → PROD: 6170 |
| 1.9 TD | 66 | 07/92 → 06/97 | D | DHY (XUD9TE/Y) | → 06-1994, → PROD: 6170 |
| | 110 | 06/94 → 06/97 | B | RFT (XU10J4/Z) | |
| 2.0 i 16V | 112 | 07/92 → 10/94 | B | RFT (XU10J4/Z), RFY (XU10J4/Z) | |
| | 120 | 05/96 → 06/97 | B | RFS (XU10J4RS) | |

FIAT

Ulysse I

| | | | | | |
|--------|----|---------------|---|----------------|-----------|
| 1.9 TD | 66 | 02/95 → 08/02 | D | DHX (XUD9TF/L) | → 04-1995 |
|--------|----|---------------|---|----------------|-----------|

LADA

Niva I

| | | | | | |
|-------------|----|---------|---|--------|--|
| 1900 Diesel | 47 | 01/93 → | D | XUD9A | |
| 1900 Diesel | 55 | 01/99 → | D | XUD9SD | |

PEUGEOT

205 II, Van

| | | | | | |
|------------|----|---------------|---|--------------|--|
| 1.7 Diesel | 44 | 07/87 → 09/98 | D | 161A (XUD7) | |
| 1.8 TD | 57 | 01/90 → 09/98 | D | A8B (XUD7TE) | |
| 1.9 Diesel | 47 | 10/87 → 09/98 | D | DJZ (XUD9Y) | |

306, Station Wagon, Coupé, Cabrio, Van

| | | | | | |
|----------|----|---------------|---|---------------|--------------|
| 1.8 D | 43 | 05/93 → 05/01 | D | A9A (XUD7) | → PROD: 7390 |
| | 47 | 05/93 → 05/01 | D | DJZ (XUD9Y) | → PROD: 7390 |
| | 50 | 06/94 → 05/01 | D | DJY (XUD9A) | → PROD: 7390 |
| 1.9 D | 55 | 03/98 → 05/01 | D | DHV (XUD9BSD) | → PROD: 7390 |
| | 66 | 05/93 → 05/01 | D | DHY (XUD9TE) | → PROD: 7390 |
| 1.9 SLD | 47 | 06/94 → 05/01 | D | DJZ (XUD9Y) | → PROD: 7390 |
| | 50 | 06/94 → 05/01 | D | DJY (XUD9A) | → PROD: 7390 |
| 1.9 SRDT | 66 | 06/94 → 05/01 | D | DHY (XUD9TE) | → PROD: 7390 |

81672 **350981672000**

PEUGEOT
306, Station Wagon, Coupé, Cabrio, Van

| | | | | | |
|--------|----|---------------|---|--------------|--------------|
| 1.9 TD | 66 | 02/97 → 04/02 | D | DHY (XUD9TE) | → PROD: 7390 |
|--------|----|---------------|---|--------------|--------------|

309 II

| | | | | | |
|------------|----|---------------|---|------------|--|
| 1.8 Diesel | 44 | 07/89 → 12/93 | D | 161A(XUD7) | |
|------------|----|---------------|---|------------|--|

| | | | | | |
|--------|----|---------------|---|--------------|--|
| 1.8 TD | 57 | 08/89 → 12/93 | D | A8B (XUD7TE) | |
|--------|----|---------------|---|--------------|--|

| | | | | | |
|------------|----|---------------|---|---|--|
| 1.9 Diesel | 47 | 07/89 → 12/93 | D | 162 (XUD9), D9A (XUD9), DJZ (XUD9Y) | |
|------------|----|---------------|---|---|--|

405 I, Station Wagon

| | | | | | |
|---------|----|---------------|---|--|--|
| 1.8 GLD | 44 | 04/90 → 07/92 | D | | |
|---------|----|---------------|---|--|--|

| | | | | | |
|--------|----|---------------|---|--------------------------------|--|
| 1.8 TD | 66 | 10/88 → 08/92 | D | A8A (XUD7TE), AJZ (XUD7TEY) | |
|--------|----|---------------|---|--------------------------------|--|

| | | | | | |
|------------------|----|---------------|---|--------------------------------|--|
| 1.8 Turbo Diesel | 66 | 03/88 → 12/92 | D | A8A (XUD7TE), AJZ (XUD7TEY) | |
|------------------|----|---------------|---|--------------------------------|--|

| | | | | | |
|-------|----|---------------|---|-------------|-----------|
| 1.9 D | 47 | 10/88 → 08/92 | D | DJZ (XUD9Y) | → 07-1992 |
|-------|----|---------------|---|-------------|-----------|

| | | | | | |
|-------|----|---------------|---|-----------------------------|-----------|
| 1.9 D | 51 | 10/88 → 08/92 | D | D9B (XUD9A), DJY (XUD9A) | → 07-1992 |
|-------|----|---------------|---|-----------------------------|-----------|

| | | | | | |
|------------|----|---------------|---|-------------|--|
| 1.9 Diesel | 47 | 07/88 → 09/92 | D | DJZ (XUD9Y) | |
| | 51 | 03/88 → 12/92 | D | D9B (XUD9A) | |

J5 II

| | | | | | |
|-------|----|---------------|---|-------------|--|
| 1.9 D | 51 | 10/90 → 02/94 | D | D9B (XUD9A) | |
|-------|----|---------------|---|-------------|--|

ROVER
200 II, Coupé

| | | | | | |
|-------|----|---------------|---|------|--|
| 218 D | 52 | 09/91 → 10/95 | D | XUD9 | |
|-------|----|---------------|---|------|--|

| | | | | | |
|--------|----|---------------|---|--------|--|
| 218 TD | 65 | 09/91 → 10/95 | D | XUD7TE | |
|--------|----|---------------|---|--------|--|

400 I, Station Wagon

| | | | | | |
|--------|----|---------------|---|--------|--|
| 1.8 TD | 65 | 09/93 → 11/98 | D | XUD7TE | |
|--------|----|---------------|---|--------|--|

| | | | | | |
|-------|----|---------------|---|------|--|
| 418 D | 49 | 09/91 → 04/95 | D | XUD9 | |
|-------|----|---------------|---|------|--|

| | | | | | |
|--------|----|---------------|---|--------|--|
| 418 TD | 65 | 09/91 → 04/95 | D | XUD7TE | |
|--------|----|---------------|---|--------|--|

81681 **350981681000**

OPEL
Corsa A, Van

| | | | | | |
|-------|----|---------------|---|-------|-----------------|
| 1.4 i | 44 | 01/90 → 03/93 | B | C14NZ | → M: 19.311.737 |
|-------|----|---------------|---|-------|-----------------|

| | | | | | |
|-------|----|---------------|---|------|-----------------|
| 1.4 S | 53 | 01/90 → 03/93 | B | 14NV | → M: 19.307.806 |
|-------|----|---------------|---|------|-----------------|

| | | | | | |
|---------|----|---------------|---|-------|---------------|
| 1.6 GSI | 55 | 08/88 → 09/92 | B | C16NZ | → T: 02J22349 |
|---------|----|---------------|---|-------|---------------|

| | | | | | |
|---------|----|---------------|---|--------|-----------------|
| 1.6 GSI | 72 | 09/89 → 03/93 | B | C16SEI | → M: 19.311.738 |
|---------|----|---------------|---|--------|-----------------|

| | | | | | |
|---------|----|---------------|---|-------|---------------|
| 1.6 GSI | 74 | 05/88 → 03/92 | B | E16SE | → T: 02J22349 |
|---------|----|---------------|---|-------|---------------|

Kadett E, Station Wagon, Coupé, Cabrio, Van

| | | | | | |
|-------|----|---------------|---|-------|-----------------|
| 1.4 i | 44 | 01/90 → 08/91 | B | C14NZ | → M: 19.311.737 |
|-------|----|---------------|---|-------|-----------------|

| | | | | | |
|-------|----|---------------|---|-------|-----------------|
| 1.4 S | 60 | 09/89 → 08/91 | B | C14SE | → M: 19.311.737 |
|-------|----|---------------|---|-------|-----------------|

| | | | | | |
|-----|----|---------------|---|------|-----------------|
| 1.6 | 60 | 09/86 → 12/91 | B | 16SV | → M: 19.311.737 |
|-----|----|---------------|---|------|-----------------|

| | | | | | |
|-------|----|---------------|---|-------|-----------------|
| 1.6 i | 55 | 08/91 → 07/94 | B | C16NZ | → M: 19.311.737 |
|-------|----|---------------|---|-------|-----------------|

| | | | | | |
|-------|----|---------------|---|-------|-----------------|
| 1.6 i | 55 | 09/86 → 08/91 | B | E16NZ | → M: 19.311.737 |
|-------|----|---------------|---|-------|-----------------|

| | | | | | |
|-------|----|---------------|---|------|-----------------|
| 1.6 i | 60 | 07/89 → 02/93 | B | 16SV | → M: 19.311.737 |
|-------|----|---------------|---|------|-----------------|

| | | | | | |
|------------|----|---------------|---|-----------------|-----------------|
| 1.6 i Cat. | 55 | 09/86 → 08/91 | B | C16LZ, C16NZ | → M: 19.311.737 |
|------------|----|---------------|---|-----------------|-----------------|

| | | | | | |
|-------|----|---------------|---|------|-----------------|
| 1.6 S | 60 | 09/86 → 08/91 | B | 16SV | → M: 19.311.737 |
|-------|----|---------------|---|------|-----------------|

Vectra A

| | | | | | |
|-------|----|---------------|---|------|-----------------|
| 1.4 S | 55 | 09/88 → 06/92 | B | 14NV | → M: 19.307.805 |
|-------|----|---------------|---|------|-----------------|

| | | | | | |
|-----|----|---------------|---|------|----------------|
| 1.6 | 60 | 09/88 → 05/93 | B | 16SV | → M: 2.122.349 |
|-----|----|---------------|---|------|----------------|

| | | | | | |
|-------|----|---------------|---|-------|----------------|
| 1.6 i | 52 | 09/93 → 11/95 | B | X16SZ | → M: 2.122.349 |
|-------|----|---------------|---|-------|----------------|

| | | | | | |
|-------|----|---------------|---|-------|----------------|
| 1.6 i | 55 | 09/93 → 11/95 | B | 16LZ2 | → M: 2.122.349 |
|-------|----|---------------|---|-------|----------------|

| | | | | | |
|-------|----|---------------|---|---|----------------|
| 1.6 i | 55 | 09/88 → 11/95 | B | 16LZ2, C16LZ2, C16NZ, C16NZ2, E16NZ | → M: 2.122.349 |
|-------|----|---------------|---|---|----------------|

| | | | | | |
|------------|----|---------------|---|------------------|----------------|
| 1.6 i Cat. | 55 | 09/88 → 11/95 | B | C16NZ, C16NZ2 | → M: 2.122.349 |
|------------|----|---------------|---|------------------|----------------|

| | | | | | |
|-------|----|---------------|---|------|----------------|
| 1.6 S | 60 | 09/88 → 05/93 | B | 16SV | → M: 2.122.349 |
|-------|----|---------------|---|------|----------------|

81683

350981683000



PULEGGIA
 Diametro Puleggia Ø72.5
 Numero Denti/Gole Puleggia 29
 Altezza Puleggia 24.5
 Posizione Attacco 57
 Diametro Girante Ø72
 N° Alette Girante 7
 Posizione Girante 33



AUDI

90 II

| | | | | | |
|-------------------|-----|---------------|---|----|-----------------------|
| 2.0 | 85 | 07/88 → 09/91 | B | PS | T →: F89-J-394.743 |
| 2.0 20 V | 118 | 08/89 → 07/91 | B | NM | |
| 2.0 20 V quattro | 118 | 08/88 → 09/91 | B | NM | |
| 2.2 E | 100 | 04/87 → 07/91 | B | KV | T →: F89-J-394.743 |
| 2.2 E quattro | 100 | 04/87 → 09/91 | B | KV | T →: F89-J-394.743 |
| 2.3 E | 98 | 04/87 → 09/91 | B | NG | T →: F89-J-394.743 |
| | 100 | 04/87 → 07/91 | B | NG | T →: F89-J-394.743 |
| 2.3 E 20V | 123 | 04/90 → 07/91 | B | 7A | |
| | 125 | 08/88 → 07/91 | B | 7A | |
| 2.3 E 20V quattro | 123 | 04/90 → 09/91 | B | 7A | |
| | 125 | 06/88 → 09/91 | B | 7A | |
| 2.3 E quattro | 98 | 04/87 → 09/91 | B | NG | T →: F89-J-394.743 |
| | 100 | 04/87 → 07/91 | B | NG | T →: F89-J-394.743 |

100 III, Avant

| | | | | | |
|---------------------|-----|---------------|---|--------|----------------------------|
| 2.0 Cat. | 85 | 01/88 → 11/90 | B | RT | M →: 010.236 |
| 2.0 E Cat. | 85 | 01/88 → 11/90 | B | RT | M →: 010.236 |
| 2.2 Cat. | 101 | 06/89 → 11/90 | B | HX, KU | |
| 2.2 E Turbo quattro | 121 | 08/86 → 11/90 | B | MC | 05-1988 →, M →: 039.951 |
| 2.2 quattro Cat. | 101 | 06/89 → 11/90 | B | HX, KU | |
| 2.2 Turbo | 121 | 08/86 → 11/90 | B | MC | 05-1988 →, M →: 039.951 |
| 2.2 Turbo quattro | 121 | 08/86 → 11/90 | B | MC | 05-1988 →, M →: 039.951 |
| 2.3 | 98 | 03/90 → 11/90 | B | NF | |
| | 100 | 08/86 → 11/90 | B | NF | 05-1988 →, M →: 063.969 |

81683

350981683000



AUDI

100 III, Avant

| | | | | | |
|---------------|-----|---------------|---|----|----------------------------|
| 2.3 E | 98 | 01/90 → 11/90 | B | NF | |
| | 100 | 10/86 → 11/90 | B | NF | 05-1988 →, M →: 063.969 |
| 2.3 E quattro | 100 | 08/86 → 11/90 | B | NF | 05-1988 →, M →: 063.969 |
| 2.3 quattro | 98 | 01/90 → 11/90 | B | NF | |

200 II, Avant

| | | | | | |
|-----------------------|-----|---------------|---|----|-----------------------|
| 2.2 20V Turbo quattro | 162 | 03/89 → 12/90 | B | 3B | T →: F44-J-246.282 |
| 2.2 Turbo | 121 | 08/85 → 09/91 | B | MC | M →: 039.951 |
| | 140 | 02/88 → 12/90 | B | 2B | M →: 001.069 |
| | 147 | 02/88 → 12/90 | B | 1B | M →: 001.571 |
| 2.2 Turbo quattro | 121 | 01/85 → 12/91 | B | MC | M →: 039.951 |
| | 147 | 02/88 → 11/90 | B | 1B | M →: 001.571 |
| 2.3 | 100 | 11/86 → 09/91 | B | NF | |

Coupé II

| | | | | | |
|------------------|-----|---------------|---|----|--------------------------------|
| 1.8 | 82 | 08/89 → 07/91 | B | DZ | →12-1990, →T: F88-M-033.000 |
| 2.0 20 V | 118 | 08/89 → 07/91 | B | NM | →T: F88-M-033.000 |
| 2.0 20 V quattro | 118 | 08/89 → 07/91 | B | NM | →T: F88-M-033.000 |
| 2.2 quattro | 100 | 11/88 → 07/91 | B | KV | |
| 2.3 | 98 | 03/90 → 12/96 | B | NG | →12-1990, →T: F88-M-033.000 |
| | 100 | 10/88 → 07/94 | B | NG | →12-1990, →T: F88-M-033.000 |
| 2.3 20V | 123 | 08/90 → 07/91 | B | 7A | →12-1990, →T: F88-M-033.000 |
| | 125 | 08/89 → 07/91 | B | 7A | →12-1990, →T: F88-M-033.000 |
| 2.3 20V quattro | 123 | 05/90 → 12/96 | B | 7A | →12-1990, →T: F88-M-033.000 |
| | 125 | 11/88 → 07/91 | B | 7A | →12-1990, →T: F88-M-033.000 |
| 2.3 quattro | 98 | 05/90 → 12/96 | B | NG | →12-1990, →T: F88-M-033.000 |
| | 100 | 11/88 → 12/92 | B | NG | →12-1990, →T: F88-M-033.000 |

Quattro

| | | | | | |
|---------------|-----|---------------|---|----|--|
| 2.2 20V Turbo | 162 | 08/89 → 07/91 | B | RR | |
|---------------|-----|---------------|---|----|--|

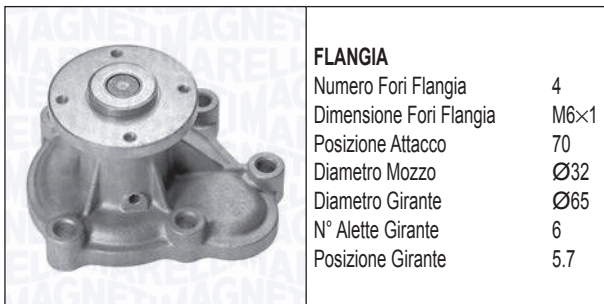
81684
350981684000

KW

OPEL
Corsa A, Van

| | | | | | |
|-------|----|---------------|---|------------|--------------|
| 1.5 D | 37 | 09/87 → 03/93 | D | 15D (4EC1) | → M: 804.794 |
|-------|----|---------------|---|------------|--------------|

| | | | | | |
|--------|----|---------------|---|--------------|--------------|
| 1.5 TD | 49 | 03/88 → 03/93 | D | 15DT (T4EC1) | → M: 804.794 |
|--------|----|---------------|---|--------------|--------------|

Kadett E, Station Wagon, Coupé, Cabrio, Van

| | | | | | |
|--------|----|---------------|---|--------------|--------------|
| 1.5 TD | 53 | 07/88 → 08/91 | D | 15DT (T4EC1) | → M: 804.794 |
|--------|----|---------------|---|--------------|--------------|

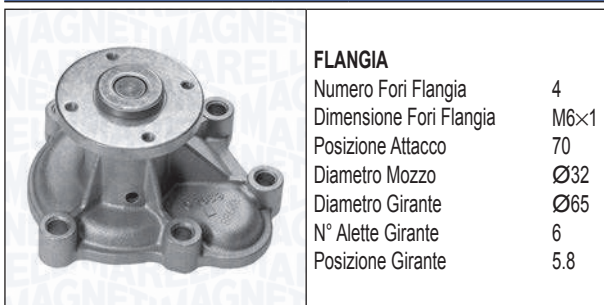
81685
350981685000

KW

OPEL
Corsa A, Van

| | | | | | |
|-------|----|---------------|---|------------|----------------------------|
| 1.5 D | 37 | 09/87 → 03/93 | D | 15D (4EC1) | 09-1990 →, M →: 910.000 |
|-------|----|---------------|---|------------|----------------------------|

| | | | | | |
|--------|----|---------------|---|--------------|----------------------------|
| 1.5 TD | 49 | 03/88 → 03/93 | D | 15DT (T4EC1) | 09-1990 →, M →: 910.000 |
|--------|----|---------------|---|--------------|----------------------------|

Corsa B, Station Wagon, Van

| | | | | | |
|-------|----|---------------|---|------------|----------------------------|
| 1.5 D | 37 | 03/93 → 09/00 | D | 15D (4EC1) | → 08-1994, → M: 877.697 |
|-------|----|---------------|---|------------|----------------------------|

| | | | | | |
|--------|----|---------------|---|--------------------------------|--------------|
| 1.5 TD | 49 | 03/93 → 09/00 | D | 15DT (T4EC1), X15DT (T4EC1) | → M: 877.697 |
|--------|----|---------------|---|--------------------------------|--------------|

Kadett E, Station Wagon, Coupé, Cabrio, Van

| | | | | | |
|--------|----|---------------|---|--------------|--------------|
| 1.5 TD | 53 | 07/88 → 08/91 | D | 15DT (T4EC1) | M →: 804.795 |
|--------|----|---------------|---|--------------|--------------|

81685
350981685000

KW

VAUXHALL
CORSA

| | | | | | |
|-------|----|---------------|---|-----|--------------|
| 1.5 D | 37 | 12/92 → 12/96 | D | 15D | → M: 877.697 |
|-------|----|---------------|---|-----|--------------|

| | | | | | |
|--------|----|---------------|---|--------------------------------|----------------------------|
| 1.5 TD | 49 | 03/93 → 10/96 | D | 15DT (T4EC1), X15DT (T4EC1) | 03-1993 →, → M: 877.697 |
|--------|----|---------------|---|--------------------------------|----------------------------|

81687
350981687000

KW

OPEL
Astra F, Station Wagon, Cabrio, Van

| | | | | | |
|--------|----|---------------|---|----------------|--|
| 1.7 TD | 60 | 03/95 → 02/98 | D | X17DT (TC4EE1) | |
|--------|----|---------------|---|----------------|--|

| | | | | | |
|---------|----|---------------|---|----------------------------------|----------------------------|
| 1.7 TDS | 60 | 03/92 → 09/98 | D | 17DT (TC4EE1), X17DT (TC4EE1) | → 12-1992, → M: 855.805 |
|---------|----|---------------|---|----------------------------------|----------------------------|

Astra G, Station Wagon, Coupé, Cabrio, Van

| | | | | | |
|--------|----|---------------|---|--------|--|
| 1.7 TD | 50 | 09/98 → 08/00 | D | X17DTL | |
|--------|----|---------------|---|--------|--|

Combo A

| | | | | | |
|-------|----|---------------|---|----------------------------|--------------|
| 1.7 D | 44 | 07/94 → 10/01 | D | 17D (4EE1), X17D (4EE1) | → M: 877.697 |
|-------|----|---------------|---|----------------------------|--------------|

Corsa A, Van

| | | | | | |
|-------|----|---------------|---|------------|---|
| 1.5 D | 37 | 09/87 → 03/93 | D | 15D (4EC1) | → 08-1990, M →: 804.795, → M: 909.999 |
|-------|----|---------------|---|------------|---|

| | | | | | |
|--------|----|---------------|---|--------------|---|
| 1.5 TD | 49 | 03/88 → 03/93 | D | 15DT (T4EC1) | → 08-1990, M →: 804.795, → M: 909.999 |
|--------|----|---------------|---|--------------|---|

Corsa B, Station Wagon, Van

| | | | | | |
|-------|----|---------------|---|----------------------------|--------------|
| 1.7 D | 44 | 02/96 → 09/00 | D | 17D (4EE1), X17D (4EE1) | → M: 877.697 |
|-------|----|---------------|---|----------------------------|--------------|

81687
350981687000

OPEL
Vectra A

| | | | | |
|--------|----|---------------|---|--|
| 1.7 TD | 60 | 03/90 → 11/95 | D | 17DT (TC4EE1), X17DT (TC4EE1) |
|--------|----|---------------|---|--|

VAUXHALL
CORSA

| | | | | |
|-------------|----|---------------|---|--------|
| 1.7 DI 16V | 48 | 08/00 → 09/06 | D | Y17DTL |
| 1.7 DTI 16V | 55 | 08/00 → 09/06 | D | Y17DT |

81700
350981700000

PULEGGIA

| | |
|-------------------|-------|
| Diametro Puleggia | Ø72.5 |
| Posizione Attacco | 56.7 |
| Diametro Girante | Ø71.5 |
| N° Alette Girante | 7 |
| Posizione Girante | 32.6 |

AUDI
80 V, Avant

| | | | | |
|---------------|-----|---------------|---|-----|
| 2.3 E | 98 | 09/91 → 12/94 | B | NG |
| 2.3 E quattro | 98 | 09/91 → 12/94 | B | NG |
| RS2 quattro | 232 | 03/94 → 05/95 | B | ADU |
| S2 quattro | 169 | 02/93 → 12/94 | B | ABY |

100 IV, Avant

| | | | | |
|------------------|-----|---------------|---|-----|
| 2.3 E | 98 | 12/90 → 06/94 | B | AAR |
| 2.3 E quattro | 98 | 12/90 → 06/94 | B | AAR |
| S4 Turbo quattro | 169 | 08/91 → 06/94 | B | AAN |

A6 I, Avant

| | | | | |
|------------------|-----|---------------|---|-----|
| 2.3 | 98 | 06/94 → 12/95 | B | AAR |
| 2.3 quattro | 98 | 06/94 → 12/95 | B | AAR |
| S6 Turbo quattro | 169 | 06/94 → 10/97 | B | AAN |

Cabriolet

| | | | | |
|-------|----|---------------|---|----|
| 2.3 E | 98 | 05/91 → 07/94 | B | NG |
|-------|----|---------------|---|----|

Coupé II

| | | | | | |
|----------|-----|---------------|---|----|----------------------------------|
| 1.8 | 82 | 08/89 → 07/91 | B | DZ | 01-1991 →, T →: F88-M-033-001 |
| 2.0 20 V | 118 | 08/89 → 07/91 | B | NM | T →: F88-M-033.001 |

81700
350981700000

AUDI
Coupé II

| | | | | | |
|------------------|-----|---------------|---|-----|----------------------------------|
| 2.0 20 V quattro | 118 | 08/89 → 07/91 | B | NM | T →: F88-M-033-001 |
| 2.3 | 98 | 03/90 → 12/96 | B | NG | 01-1991 →, T →: F88-M-033-001 |
| | 100 | 10/88 → 07/94 | B | NG | 01-1991 →, T →: F88-M-033-001 |
| 2.3 20V | 123 | 08/90 → 07/91 | B | 7A | 01-1991 →, T →: F88-M-033-001 |
| | 125 | 08/89 → 07/91 | B | 7A | 01-1991 →, T →: F88-M-033-001 |
| 2.3 20V quattro | 123 | 05/90 → 12/96 | B | 7A | 01-1991 →, T →: F88-M-033-001 |
| | 125 | 11/88 → 07/91 | B | 7A | 01-1991 →, T →: F88-M-033-001 |
| 2.3 quattro | 98 | 05/90 → 12/96 | B | NG | 01-1991 →, T →: F88-M-033-001 |
| | 100 | 11/88 → 12/92 | B | NG | 01-1991 →, T →: F88-M-033-001 |
| S2 quattro | 162 | 09/90 → 09/92 | B | 3B | → T: F88-M-033.000 |
| | 169 | 10/92 → 12/96 | B | ABY | |

81701
350981701000

PULEGGIA

| | |
|----------------------------|-------|
| Diametro Puleggia | Ø59.2 |
| Numero Denti/Gole Puleggia | 20 |
| Altezza Puleggia | 27.4 |
| Posizione Attacco | 56.45 |
| Diametro Girante | Ø71.5 |
| N° Alette Girante | 7 |
| Posizione Girante | 32.6 |

AUDI
100 IV, Avant

| | | | | |
|---------|----|---------------|---|----------|
| 2.4 D | 60 | 12/90 → 06/94 | D | AAS |
| 2.5 TDI | 85 | 12/90 → 06/94 | D | AAT, ABP |

A6 I, Avant

| | | | | |
|-----------------|-----|---------------|---|-----|
| 2.5 TDI | 84 | 01/95 → 10/97 | D | AAT |
| | 85 | 06/94 → 10/97 | D | AAT |
| | 103 | 08/94 → 10/97 | D | AEL |
| 2.5 TDI quattro | 103 | 10/95 → 10/97 | D | AEL |

81701 350981701000

VOLKSWAGEN
LT I 28-35, 40-55

2.4 TD 70 09/92 → 06/96 D ACL

LT II 28-35, 28-46

2.5 SDI 55 07/96 → 07/06 D AGX

61 05/01 → 07/06 D BBE

66 05/99 → 07/06 D APA

2.5 TDI 70 05/01 → 07/06 D BBF

75 05/96 → 08/99 D AHD

80 05/99 → 07/06 D ANJ, AVR

Transporter IV

2.4 D 55 08/97 → 04/03 D AJA

57 09/90 → 04/98 D AAB 08-1995 →, T →: F70.N.014.001

2.4 D Syncro 57 10/92 → 09/98 D AAB 08-1995 →, T →: F70.N.014.001

2.5 81 11/90 → 04/03 B AAF, ACU, AEN, AEU T →: F70.N.014.001, M: AEN, M: AEU, M: AEN

85 08/96 → 04/03 B AET, APL, AVT

2.5 Syncro 81 10/92 → 04/03 B AAF, ACU, AEN, AEU T →: F70.N.014.001, M: AEN, M: AEU, M: AEN

81 11/92 → 04/03 B AAF, ACU, AEN, AEU T →: F70.N.014.001, M: AEU, M: AEN, M: AEU

85 07/96 → 04/03 B AET, APL, AVT

2.5 TDI 65 05/98 → 04/03 D AJT, AYY

75 09/95 → 04/03 D ACV, AUF, AXL, AYC

75 09/95 → 04/03 D ACV, AUF, AYC

111 05/98 → 04/03 D AHY, AXG

111 09/00 → 04/03 D AXG

2.5 TDI Syncro 75 01/96 → 04/03 D ACV, AXL

81701 350981701000

VOLVO
850, Station Wagon

2.5 TDI 103 08/95 → 12/96 D D5252T

940 I, Station Wagon

2.4 TD Intercooler 90 08/90 → 12/94 D D24TIC 07-1992 →, T →: 30.004

940 II, Station Wagon

2.4 TD Interc. 90 08/94 → 10/98 D D24TIC

960 I, Station Wagon

2.4 TD Interc. 85 09/91 → 07/94 D D24TIC 07-1992 →, T →: 30.004

S 70

2.5 TDI 103 01/97 → 11/00 D D5252T

S 80 I

2.5 TDI 103 01/99 → 07/06 D D5252T → 12-2002

V 70 I

2.5 TDI 103 01/97 → 05/00 D D5252T

81702 350981702000

AUDI
A3 I

1.6 74 09/96 → 05/03 B AEH, AKL, APF

75 08/00 → 05/03 B AVU, BFQ

A3 II, Sportback, Cabriolet

1.6 75 05/03 → 08/12 B BGU, BSE, BSF, CCSA, CMXA

75 09/08 → 05/10 B BSE

1.6 E-Power 75 01/11 → 08/12 FF CCSA, CMXA

1.8 T 110 08/06 → 08/12 B BPU

2.0 FSI 110 05/03 → 06/08 B AXW, BLR, BLX, BLY, BMB, BVY, BVZ

81702 350981702000

AUDI
A4 I, Avant

| | | | | | |
|-----|----|---------------|---|--------------------|--------------------------------------|
| 1.6 | 74 | 11/94 → 10/00 | B | ADP, AHL, ANA, ARM | 12-1997 →, → 07-2000, M: AHL/ANA/ARM |
| | 75 | 07/00 → 11/00 | B | ALZ | |

A4 II, Avant, Cabriolet

| | | | | | |
|---------|-----|---------------|---|-----|--------|
| 1.6 | 75 | 11/00 → 12/04 | B | ALZ | |
| 2.0 | 96 | 09/04 → 12/05 | B | ALT | M: ALT |
| | 96 | 11/00 → 12/04 | B | ALT | |
| 2.0 FSI | 110 | 07/02 → 12/04 | B | AWA | |

A4 III, Avant

| | | | | | |
|-----|----|---------------|---|-----|--|
| 1.6 | 75 | 11/04 → 06/08 | B | ALZ | |
| 2.0 | 96 | 11/04 → 06/08 | B | ALT | |

A6 II, Avant

| | | | | | |
|-----|----|---------------|---|--------------------|--|
| 1.8 | 92 | 07/97 → 01/05 | B | AJP, ANQ, AQE, ARH | |
| | 92 | 12/97 → 01/05 | B | AJP, AQE, ARH | |
| 2.0 | 96 | 08/01 → 01/05 | B | ALT | |

SEAT
Altea, Altea XL

| | | | | | |
|---------------|-----|---------------|---|---------------------------|--|
| 1.6 | 75 | 03/04 → | B | BGU, BSE, BSF, CCSA, CMXA | |
| | 75 | 10/06 → | B | BSE, BSF, CCSA, CMXA | |
| 1.6 LPG | 75 | 09/09 → | | CHGA | |
| 1.6 Multifuel | 75 | 10/06 → | | CCSA | |
| 2.0 FSI | 110 | 05/04 → 03/09 | B | BLR, BLY, BVY, BVZ | |
| 2.0 FSI | 110 | 10/06 → 03/09 | B | BVY, BVZ | |

Cordoba II, Vario

| | | | | | |
|-----|----|---------------|---|--------------------|--|
| 1.6 | 74 | 06/99 → 10/02 | B | AEH, AKL, APF, AUR | |
|-----|----|---------------|---|--------------------|--|

Exeo, Exeo ST

| | | | | | |
|-------|-----|---------------|---|------|--|
| 1.6 | 75 | 03/09 → 09/10 | B | ALZ | |
| 1.8 T | 110 | 12/08 → 05/10 | B | CFMA | |

Ibiza III

| | | | | | |
|-----|----|---------------|---|--------------------|--|
| 1.6 | 74 | 08/99 → 02/02 | B | AEH, AKL, APF, AUR | |
|-----|----|---------------|---|--------------------|--|

Leon I

| | | | | | |
|-----|----|---------------|---|---------------|--|
| 1.6 | 74 | 11/99 → 06/06 | B | AEH, AKL, APF | |
| | 75 | 10/05 → 06/06 | B | BFQ, BGU | |

81702 350981702000

SEAT
Leon II

| | | | | | |
|---------------|-----|---------------|---|----------------------|--|
| 1.6 | 75 | 07/05 → 12/12 | B | BSE, BSF, CCSA, CMXA | |
| 1.6 LPG | 75 | 12/09 → 12/12 | | CHGA | |
| 1.6 MultiFuel | 75 | 11/10 → 12/12 | | BSE, CMXA | |
| 2.0 FSI | 110 | 07/05 → 05/10 | B | BLR, BLY, BVY, BVZ | |

Toledo II

| | | | | | |
|-----|----|---------------|---|---------------|-----------|
| 1.6 | 74 | 10/98 → 07/04 | B | AEH, AKL, APF | 08-1995 → |
|-----|----|---------------|---|---------------|-----------|

Toledo III

| | | | | | |
|---------|-----|---------------|---|---------------------|--|
| 1.6 | 75 | 10/04 → 05/09 | B | BGU, BSE, BSF, CCSA | |
| 2.0 FSI | 110 | 10/04 → 05/09 | B | BLR, BLY, BVY, BVZ | |

SKODA
Octavia I, Station Wagon

| | | | | | |
|-----|----|---------------|---|----------|--|
| 1.6 | 74 | 02/97 → 12/07 | B | AEH, AKL | |
| | 74 | 07/98 → 12/07 | B | AEH, AKL | |
| | 75 | 11/00 → 12/10 | B | AVU, BFQ | |

Octavia II, Station Wagon

| | | | | | |
|---------------|-----|---------------|---|---------------------------|--|
| 1.6 | 75 | 06/04 → 06/13 | B | BGU, BSE, BSF, CCSA, CMXA | |
| 1.6 LPG | 75 | 08/09 → 11/12 | | CHGA | |
| 1.6 MultiFuel | 75 | 01/08 → 06/13 | | CCSA, CMXA | |
| 2.0 FSI | 110 | 11/04 → 10/08 | B | BLR, BLY, BVY, BVZ | |
| 2.0 FSI 4x4 | 110 | 11/04 → 10/08 | B | BLX, BVX | |

VOLKSWAGEN
Bora, Station Wagon

| | | | | | |
|-----|----|---------------|---|---------------|--|
| 1.6 | 74 | 10/98 → 05/05 | B | AEH, AKL, APF | |
| | 75 | 08/00 → 05/05 | B | AVU, BFQ | |
| | 75 | 08/00 → 05/05 | B | AVU, BFQ, BJH | |
| | 78 | 06/02 → 10/04 | B | AWB | |

Caddy III

| | | | | | |
|-----|------------|---------|---------|---------------|------|
| 1.6 | 74 | 03/05 → | B | BRY | |
| | 75 | 04/04 → | B | BGU, BSE, BSF | |
| | 1.6 BiFuel | 75 | 05/11 → | BF | CHGA |

81702 350981702000

VOLKSWAGEN
Eos

2.0 FSI 110 03/06 → 05/08 B BVY, BVZ

Golf IV, Variant, Cabrio

| | | | | |
|-----|----|---------------|---|---------------|
| 1.6 | 74 | 08/97 → 05/04 | B | AEH, AKL, APF |
| | 75 | 08/00 → 06/06 | B | AVU, BFQ |
| | 75 | 08/00 → 06/05 | B | AVU, BFQ, BJH |
| | 74 | 02/01 → 06/01 | B | BAH |

Golf V, Plus, Variant

| | | | | |
|-----|----|---------------|---|----------------------|
| 1.6 | 75 | 01/04 → 11/08 | B | BGU, BSE, BSF |
| | 75 | 06/07 → 07/09 | B | BGU, BSE, BSF, CCSA |
| | 75 | 05/05 → 12/13 | B | BSE, BSF, CCSA, CMXA |

1.6 BiFuel 75 05/09 → 12/13 BF CHGA

1.6 MultiFuel 75 10/07 → 11/08 CCSA

1.6 MultiFuel 75 11/07 → 12/13 CCSA, CMXA

| | | | | |
|---------|-----|---------------|---|-----------------------------------|
| 2.0 FSI | 110 | 01/04 → 11/08 | B | AXW, BLR, BLX, BLY, BVX, BVY, BVZ |
| | 110 | 05/05 → 06/08 | B | BLR, BLY, BVY, BVZ |

| | | | | |
|-----------------|-----|---------------|---|-------------------------|
| 2.0 FSI 4motion | 110 | 08/04 → 11/08 | B | BLX, BLY, BVX, BVY, BVZ |
|-----------------|-----|---------------|---|-------------------------|

Golf VI, Variant, Cabrio

| | | | | |
|-----|----|---------------|---|----------------------|
| 1.6 | 75 | 10/08 → 11/12 | B | BSE, BSF, CCSA, CMXA |
|-----|----|---------------|---|----------------------|

1.6 BiFuel 75 03/09 → 11/12 BF CHGA

| | | | | |
|---------------|----|---------------|--|------------|
| 1.6 MultiFuel | 75 | 10/08 → 11/12 | | CCSA, CMXA |
| | 75 | 07/10 → 07/13 | | CMXA |

Jetta III

| | | | | |
|-----|----|---------------|---|---------------------|
| 1.6 | 75 | 10/05 → 10/10 | B | BGU, BSE, BSF, CCSA |
|-----|----|---------------|---|---------------------|

1.6 MultiFuel 75 01/08 → 10/10 CCSA

81702 350981702000

VOLKSWAGEN
Jetta III

| | | | | |
|---------|-----|---------------|---|-------------------------|
| 2.0 FSI | 110 | 08/05 → 10/10 | B | BLR, BLX, BLY, BVY, BVZ |
|---------|-----|---------------|---|-------------------------|

New Beetle, Cabrio

| | | | | |
|-----|----|---------------|---|----------|
| 1.6 | 74 | 10/99 → 09/00 | B | AWH |
| | 75 | 06/00 → 09/10 | B | AYD, BFS |
| | 75 | 01/03 → 09/10 | B | BFS |

Passat IV, Variant

| | | | | | |
|-----|----|---------------|---|--------------------|---|
| 1.6 | 74 | 10/96 → 11/00 | B | ADP, AHL, ANA, ARM | 01-1998 →, M: ARM, M: ANA, M: ARM, M: AHL, M: ANA |
| | 74 | 06/97 → 11/00 | B | ADP, AHL, ANA, ARM | 01-1998 →, M: AHL, M: ANA, M: AHL, M: ARM, M: ANA |

| | | | | | |
|-------|-----|---------------|---|---------------|--------|
| 1.8 T | 110 | 10/96 → 11/00 | B | AEB, ANB, APU | M: APU |
|-------|-----|---------------|---|---------------|--------|

Passat V, Variant

| | | | | |
|-----|----|---------------|---|-----|
| 1.6 | 75 | 11/00 → 05/05 | B | ALZ |
|-----|----|---------------|---|-----|

| | | | | |
|-----|----|---------------|---|-----|
| 2.0 | 96 | 11/01 → 05/05 | B | ALT |
|-----|----|---------------|---|-----|

Passat VI, Variant, CC

| | | | | |
|-----|----|---------------|---|----------|
| 1.6 | 75 | 05/05 → 07/10 | B | BSE, BSF |
|-----|----|---------------|---|----------|

| | | | | |
|---------|-----|---------------|---|--------------------|
| 2.0 FSI | 110 | 03/05 → 07/10 | B | BLR, BLY, BVY, BVZ |
|---------|-----|---------------|---|--------------------|

| | | | | |
|-----------------|-----|---------------|---|---------------|
| 2.0 FSI 4motion | 110 | 09/05 → 07/10 | B | BLX, BLY, BVX |
|-----------------|-----|---------------|---|---------------|

Polo III (6N1), Classic, Variant, Van

| | | | | | |
|-----|----|---------------|---|-------------------------|--|
| 1.6 | 74 | 05/97 → 09/01 | B | AEH, AFT, AKL, APF, AUR | M: AUR, M: AKL, M: AEH, M: AUR, M: APF, M: AKL |
|-----|----|---------------|---|-------------------------|--|

| | | | | |
|---------|----|---------------|---|-------------------------|
| 100 1.6 | 74 | 12/95 → 09/01 | B | AEH, AFT, AKL, APF, AUR |
|---------|----|---------------|---|-------------------------|

Touran I

| | | | | |
|-----|----|---------------|---|---------------|
| 1.6 | 75 | 07/03 → 05/10 | B | BGU, BSE, BSF |
|-----|----|---------------|---|---------------|

| | | | | |
|---------|----|---------------|---|-----|
| 2.0 FSI | 85 | 10/04 → 05/10 | B | BJZ |
|---------|----|---------------|---|-----|

| | | | | |
|---------|-----|---------------|---|------------------------------|
| 2.0 FSI | 110 | 10/03 → 01/07 | B | AXW, BLR, BLX, BLY, BVY, BVZ |
|---------|-----|---------------|---|------------------------------|

81703
350981703000

PULEGGIA

Diametro Puleggia Ø57.19
 Numero Denti/Gole Puleggia 23
 Altezza Puleggia 26.5
 Posizione Attacco 45.7
 Diametro Girante Ø60.1
 N° Alette Girante 8
 Posizione Girante 48

KW

AUDI
A3 I

| | | | | | |
|---------------|-----|---------------|---|--------------------|--|
| 1.8 | 92 | 09/96 → 05/03 | B | AGN, APG | |
| 1.8 T | 110 | 12/96 → 05/03 | B | AGU, AQA, ARZ, AUM | |
| | 132 | 12/98 → 05/03 | B | AJQ, APP, ARY, AUQ | |
| 1.8 T quattro | 110 | 12/96 → 05/03 | B | AGU, AQA, ARX | |
| | 132 | 10/98 → 05/03 | B | AJQ, ARY | |
| S3 quattro | 154 | 03/99 → 04/02 | B | AMK, APY, AUL | |
| | 165 | 10/01 → 05/03 | B | BAM | |

A4 II, Avant, Cabriolet

| | | | | | |
|---------------|-----|---------------|---|----------|--|
| 1.8 T | 110 | 11/00 → 07/02 | B | AVJ | |
| | 120 | 07/02 → 12/04 | B | BFB | |
| | 120 | 07/02 → 12/04 | B | BFB, BKB | |
| | 125 | 07/01 → 12/04 | B | AMB | |
| 1.8 T quattro | 140 | 11/02 → 12/04 | B | BEX | |
| | 110 | 11/00 → 07/02 | B | AVJ | |
| | 120 | 07/02 → 12/04 | B | BFB | |
| | 125 | 07/01 → 12/04 | B | AMB | |
| | 140 | 11/02 → 12/04 | B | BEX | |

A4 III, Avant

| | | | | | |
|---------------|-----|---------------|---|-----|--|
| 1.8 T | 120 | 11/04 → 06/08 | B | BFB | |
| 1.8 T quattro | 120 | 11/04 → 06/08 | B | BFB | |

A6 II, Avant

| | | | | | |
|---------------|-----|---------------|---|------------------------------|------------------------------|
| 1.8 T | 110 | 01/97 → 01/05 | B | AEB, ANB, APU, ARK, AWL, AWT | 05-2000 →, → 07-2004, M: AWT |
| | 110 | 12/97 → 01/05 | B | AEB, ANB, APU, ARK, AWT | 02-2000 →, → 07-2004, M: AWT |
| 1.8 T quattro | 110 | 02/97 → 01/05 | B | AEB, ANB, APU, ARK, AWT | 05-2000 →, → 07-2004, M: AWT |

81703
350981703000

KW

AUDI
TT I, Roadster

| | | | | | |
|---------------|-----|---------------|---|-------------------------|--|
| 1.8 T | 110 | 09/02 → 06/06 | B | AUM | |
| | 120 | 09/05 → 06/06 | B | BVP | |
| | 132 | 10/99 → 06/06 | B | AJQ, APP, ATC, AUQ | |
| | 132 | 10/98 → 06/06 | B | AJQ, APP, ATC, AUQ, AWP | |
| | 140 | 09/05 → 06/06 | B | BVR | |
| 1.8 T quattro | 132 | 10/98 → 06/06 | B | AJQ, ARY, AUQ, AWP | |
| | 140 | 09/05 → 06/06 | B | BVR | |
| | 165 | 10/98 → 06/06 | B | APX, BAM | |
| | 176 | 03/05 → 06/06 | B | BFV | |

SEAT
Alhambra I

| | | | | | |
|-----------|-----|---------------|---|----------|-------------------|
| 1.8 T 20V | 110 | 10/97 → 03/10 | B | AJH, AWC | |
| 2.0 i | 85 | 04/96 → 03/10 | B | ADY, ATM | 08-2000 →, M: ATM |

Cordoba II, Vario

| | | | | | |
|-----------------|-----|---------------|---|----------|--|
| 1.8 T 20V Cupra | 115 | 07/00 → 10/02 | B | AQX, AYP | |
|-----------------|-----|---------------|---|----------|--|

Cordoba III, Vario

| | | | | | |
|-----|----|---------------|---|----------|--|
| 2.0 | 85 | 09/02 → 11/09 | B | AZL, BBX | |
|-----|----|---------------|---|----------|--|

Ibiza III

| | | | | | |
|-----------------|-----|---------------|---|----------|--|
| 1.8 T 20V Cupra | 115 | 07/00 → 02/02 | B | AQX, AYP | |
|-----------------|-----|---------------|---|----------|--|

Ibiza IV

| | | | | | |
|---------------|-----|---------------|---|----------|--|
| 1.8 T Cupra R | 132 | 01/04 → 02/08 | B | BBU, BLZ | |
| 1.8 T FR | 110 | 12/03 → 05/08 | B | BJX, BKV | |
| 2.0 | 85 | 04/02 → 11/09 | B | AZL, BBX | |

Ibiza V

| | | | | | |
|-----|----|---------|---|------|--|
| 2.0 | 85 | 10/08 → | B | CEKA | |
|-----|----|---------|---|------|--|

Leon I

| | | | | | |
|---------------|-----|---------------|---|----------|--|
| 1.8 20V | 92 | 11/99 → 06/06 | B | AGN, APG | |
| 1.8 20V T | 132 | 11/99 → 06/06 | B | APP, AUQ | |
| 1.8 20V T 4 | 132 | 11/99 → 06/06 | B | AJQ, ARY | |
| 1.8 T Cupra R | 154 | 02/02 → 06/06 | B | AMK | |
| | 165 | 07/03 → 06/06 | B | BAM | |

Toledo II

| | | | | | |
|----------|-----|---------------|---|----------|--|
| 1.8 20V | 92 | 10/98 → 07/04 | B | AGN, APG | |
| 1.8 20VT | 132 | 09/00 → 07/04 | B | APP, AUQ | |

81703 350981703000

SKODA
Fabia I, Station Wagon, Van

| | | | | |
|-----|----|---------------|---|-----|
| 2.0 | 85 | 12/99 → 03/08 | B | AZL |
|-----|----|---------------|---|-----|

Octavia I, Station Wagon

| | | | | |
|-----|----|---------------|---|-----|
| 1.8 | 92 | 09/96 → 07/00 | B | AGN |
|-----|----|---------------|---|-----|

| | | | | |
|---------|----|---------------|---|-----|
| 1.8 20V | 92 | 07/98 → 07/00 | B | AGN |
|---------|----|---------------|---|-----|

| | | | | |
|-------|-----|---------------|---|--------------------|
| 1.8 T | 110 | 08/97 → 12/10 | B | AGU, ARX, ARZ, AUM |
|-------|-----|---------------|---|--------------------|

| | | | | |
|--|-----|---------------|---|--------------------|
| | 110 | 07/98 → 12/10 | B | AGU, ARX, ARZ, AUM |
|--|-----|---------------|---|--------------------|

| | | | | |
|-----------|-----|---------------|---|---------------|
| 1.8 T 4x4 | 110 | 05/01 → 05/06 | B | AGU, ARX, AUM |
|-----------|-----|---------------|---|---------------|

| | | | | |
|--|-----|---------------|---|----------|
| | 110 | 05/01 → 05/06 | B | ARX, AUM |
|--|-----|---------------|---|----------|

| | | | | |
|-----|----|---------------|---|-------------------------|
| 2.0 | 85 | 04/99 → 05/07 | B | AEG, APK, AQY, AZH, AZJ |
|-----|----|---------------|---|-------------------------|

| | | | | |
|--|----|---------------|---|-------------------------|
| | 85 | 04/99 → 05/07 | B | AEG, APK, AQY, AZH, AZJ |
|--|----|---------------|---|-------------------------|

| | | | | |
|---------|----|---------------|---|----------|
| 2.0 4x4 | 85 | 08/00 → 09/04 | B | AZH, AZJ |
|---------|----|---------------|---|----------|

| | | | | |
|--|----|---------------|---|-----|
| | 88 | 01/00 → 12/10 | B | ATF |
|--|----|---------------|---|-----|

| | | | | |
|----------|-----|---------------|---|-----|
| RS 1.8 T | 132 | 05/01 → 01/06 | B | AUQ |
|----------|-----|---------------|---|-----|

Superb I

| | | | | |
|-------|-----|---------------|---|-----|
| 1.8 T | 110 | 12/01 → 03/08 | B | AWT |
|-------|-----|---------------|---|-----|

| | | | | |
|-----|----|---------------|---|-----|
| 2.0 | 85 | 12/01 → 03/08 | B | AZM |
|-----|----|---------------|---|-----|

VOLKSWAGEN
Bora, Station Wagon

| | | | | |
|-----|----|---------------|---|----------|
| 1.8 | 92 | 10/98 → 05/05 | B | AGN, BAF |
|-----|----|---------------|---|----------|

| | | | | |
|-------------|----|---------------|---|-----|
| 1.8 4motion | 92 | 02/99 → 05/05 | B | AGN |
|-------------|----|---------------|---|-----|

| | | | | |
|-------|-----|---------------|---|---------------|
| 1.8 T | 110 | 05/00 → 05/05 | B | AGU, ARX, AUM |
|-------|-----|---------------|---|---------------|

| | | | | |
|--|-----|---------------|---|--------------------|
| | 110 | 05/00 → 05/05 | B | AGU, ARX, AUM, BAE |
|--|-----|---------------|---|--------------------|

| | | | | |
|--|-----|---------------|---|-----|
| | 132 | 03/02 → 05/05 | B | AUQ |
|--|-----|---------------|---|-----|

| | | | | |
|-----|----|---------------|---|-------------------------|
| 2.0 | 85 | 05/99 → 05/05 | B | APK, AQY, AZG, AZH, AZJ |
|-----|----|---------------|---|-------------------------|

| | | | | |
|--|----|---------------|---|------------------------------|
| | 85 | 10/98 → 05/05 | B | APK, AQY, AZG, AZH, AZJ, BBW |
|--|----|---------------|---|------------------------------|

| | | | | |
|-------------|----|---------------|---|----------|
| 2.0 4motion | 85 | 04/00 → 05/05 | B | AZH, AZJ |
|-------------|----|---------------|---|----------|

Caddy III

| | | | | |
|-------------|----|---------|---|-----|
| 2.0 EcoFuel | 80 | 04/06 → | M | BSX |
|-------------|----|---------|---|-----|

81703 350981703000

VOLKSWAGEN
Golf IV, Variant, Cabrio

| | | | | | |
|-----|----|---------------|---|----------|-----------|
| 1.8 | 92 | 08/97 → 06/05 | B | AGN, BAF | 10-1997 → |
|-----|----|---------------|---|----------|-----------|

| | | | | | |
|-------------|----|---------------|---|-----|--|
| 1.8 4motion | 92 | 05/98 → 06/05 | B | AGN | |
|-------------|----|---------------|---|-----|--|

| | | | | | |
|-------|-----|---------------|---|-------------------------|-----------|
| 1.8 T | 110 | 08/97 → 06/05 | B | AGU, AQA, ARZ, AUM, AWD | 10-1997 → |
|-------|-----|---------------|---|-------------------------|-----------|

| | | | | | |
|--|-----|---------------|---|-------------------------|--|
| | 110 | 05/00 → 06/06 | B | AGU, AQA, ARZ, AUM, AWD | |
|--|-----|---------------|---|-------------------------|--|

| | | | | | |
|-----------|-----|---------------|---|-----|--|
| 1.8 T GTI | 132 | 08/01 → 06/05 | B | AUQ | |
|-----------|-----|---------------|---|-----|--|

| | | | | | |
|-----|----|---------------|---|-------------------------|--|
| 2.0 | 85 | 07/98 → 05/04 | B | APK, AQY, AZG, AZJ, BER | |
|-----|----|---------------|---|-------------------------|--|

| | | | | | |
|--|----|---------------|---|---------------|--|
| | 85 | 05/99 → 06/06 | B | APK, AQY, AZJ | |
|--|----|---------------|---|---------------|--|

| | | | | | |
|-------------|----|---------------|---|----------|--|
| 2.0 4motion | 85 | 10/00 → 06/05 | B | AZH, AZJ | |
|-------------|----|---------------|---|----------|--|

| | | | | | |
|--|----|---------------|---|-----|--|
| | 88 | 12/99 → 06/06 | B | ATF | |
|--|----|---------------|---|-----|--|

| | | | | | |
|-------------|----|---------------|--|-----|--|
| 2.0 Bi-Fuel | 85 | 02/02 → 06/06 | | BEH | |
|-------------|----|---------------|--|-----|--|

Multivan V

| | | | | | |
|-----|----|---------|---|-----|--|
| 2.0 | 85 | 11/03 → | B | AXA | |
|-----|----|---------|---|-----|--|

New Beetle, Cabrio

| | | | | | |
|-------|-----|---------------|---|------------------------------|--|
| 1.8 T | 110 | 10/99 → 09/10 | B | AGU, APH, AVC, AWU, AWV, BKF | |
|-------|-----|---------------|---|------------------------------|--|

| | | | | | |
|--|-----|---------------|---|---------------|--|
| | 110 | 01/03 → 09/10 | B | AWU, AWV, BKF | |
|--|-----|---------------|---|---------------|--|

| | | | | | |
|--|-----|---------------|---|----------|--|
| | 132 | 11/01 → 06/05 | B | AWP, BNU | |
|--|-----|---------------|---|----------|--|

| | | | | | |
|-----|----|---------------|---|--|--|
| 2.0 | 85 | 01/98 → 09/10 | B | AEG, APK, AQY, AVH, AZG, AZJ, BEJ, BER, BEV, BHP, CBPA | |
|-----|----|---------------|---|--|--|

| | | | | | |
|--|----|---------------|---|-------------------------|--|
| | 85 | 09/02 → 10/10 | B | AQY, AZJ, BDC, BEV, BGD | |
|--|----|---------------|---|-------------------------|--|

| | | | | | |
|-----|----|---------------|---|----------|--|
| 2.0 | 88 | 04/00 → 11/00 | B | ASU, AUZ | |
|-----|----|---------------|---|----------|--|

| | | | | | |
|--|----|---------------|---|-----|--|
| | 88 | 04/00 → 11/00 | B | ASU | |
|--|----|---------------|---|-----|--|

| | | | | | |
|-------------|----|---------------|---|----------|--|
| 2.0 4motion | 88 | 04/00 → 11/00 | B | ASU, AUZ | |
|-------------|----|---------------|---|----------|--|

| | | | | | |
|-------------|----|---------------|---|----------|--|
| 2.0 4motion | 88 | 04/00 → 11/00 | B | ASU, AUZ | |
|-------------|----|---------------|---|----------|--|

| | | | | | |
|-------------|----|---------------|---|----------|--|
| 2.0 4motion | 88 | 04/00 → 11/00 | B | ASU, AUZ | |
|-------------|----|---------------|---|----------|--|

Passat V, Variant

| | | | | | |
|-------|-----|---------------|---|-----|--|
| 1.8 T | 125 | 02/01 → 05/05 | B | AWM | |
|-------|-----|---------------|---|-----|--|

| | | | | | |
|-----------|-----|---------------|---|----------|--|
| 1.8 T 20V | 110 | 11/00 → 05/05 | B | AWL, AWT | |
|-----------|-----|---------------|---|----------|--|

| | | | | | |
|--|-----|---------------|---|-----|--|
| | 110 | 11/00 → 05/05 | B | AWT | |
|--|-----|---------------|---|-----|--|

| | | | | | |
|-------|-----|---------------|---|-----|--|
| 1.8 T | 125 | 03/01 → 05/05 | B | AWM | |
|-------|-----|---------------|---|-----|--|

| | | | | | |
|---------|-----|---------------|---|-----|--|
| 4motion | 125 | 03/01 → 05/05 | B | AWM | |
|---------|-----|---------------|---|-----|--|

81703 350981703000



VOLKSWAGEN

Passat V, Variant

| | | | | | |
|-------------|----|---------------|---|----------|--|
| 2.0 | 85 | 11/00 → 05/05 | B | AZM | |
| | 85 | 11/00 → 05/05 | B | AZM, BFF | |
| 2.0 4motion | 85 | 11/00 → 05/05 | B | AZM | |

Polo V (9N)

| | | | | | |
|---------------------|-----|---------------|---|-----|--|
| 1.8 GTI | 110 | 09/05 → 11/09 | B | BJX | |
| 1.8 GTI Cup Edition | 132 | 05/06 → 11/09 | B | BBU | |

Sharan I

| | | | | | |
|-----------|-----|---------------|---|----------|-------------------|
| 1.8 T 20V | 110 | 09/97 → 03/10 | B | AJH, AWC | |
| 2.0 | 85 | 09/95 → 03/10 | B | ADY, ATM | 03-2000 →, M: ATM |
| 2.0 LPG | 85 | 04/06 → 03/10 | | ATM | |

Touran I

| | | | | | |
|-------------|----|---------------|---|-----|--|
| 2.0 EcoFuel | 80 | 02/06 → 05/09 | M | BSX | |
|-------------|----|---------------|---|-----|--|

Transporter V

| | | | | | |
|-----|----|---------|---|-----|--|
| 2.0 | 85 | 11/03 → | B | AXA | |
|-----|----|---------|---|-----|--|

81705 350981705000



PULEGGIA

Diametro Puleggia Ø57.1

Altezza Puleggia 33

Posizione Attacco 61

Diametro Girante Ø79

N° Alette Girante 5

Posizione Girante 29.4



AUDI

A4 I, Avant

| | | | | | |
|-----------------|-----|---------------|---|----------|--|
| 2.5 TDI | 110 | 09/97 → 11/00 | D | AFB, AKN | |
| 2.5 TDI quattro | 110 | 09/97 → 11/00 | D | AFB, AKN | |

A4 II, Avant, Cabriolet

| | | | | | |
|-----------------|-----|---------------|---|---------------|--|
| 2.5 TDI | 114 | 08/01 → 07/02 | D | AYM | |
| | 120 | 07/02 → 12/04 | D | BCZ, BDG, BFC | |
| | 132 | 10/00 → 05/03 | D | AKE | |
| 2.5 TDI quattro | 132 | 11/00 → 12/04 | D | AKE, BAU, BDH | |

A4 III, Avant

| | | | | | |
|---------|-----|---------------|---|-----|--|
| 2.5 TDI | 120 | 11/04 → 05/06 | D | BDG | |
|---------|-----|---------------|---|-----|--|

81705 350981705000



AUDI

A6 II, Avant

| | | | | | |
|-----------------|-----|---------------|---|--------------------|--|
| 2.5 TDI | 110 | 07/97 → 01/05 | D | AFB, AKN | |
| | 114 | 08/01 → 01/05 | D | AYM | |
| | 120 | 07/02 → 01/05 | D | BCZ, BDG, BFC | |
| | 132 | 02/00 → 01/05 | D | AKE, BAU, BDH | |
| | 132 | 02/00 → 01/05 | D | AKE, BAU, BDH, BND | |
| 2.5 TDI quattro | 110 | 07/97 → 01/05 | D | AFB, AKN | |
| | 132 | 02/00 → 01/05 | D | AKE, BAU, BDH | |

A8 I

| | | | | | |
|-----------------|-----|---------------|---|----------|--|
| 2.5 TDI | 110 | 01/97 → 04/00 | D | AFB, AKN | |
| | 132 | 09/00 → 09/02 | D | AKE | |
| 2.5 TDI quattro | 110 | 07/97 → 04/00 | D | AFB, AKN | |
| | 132 | 09/00 → 09/02 | D | AKE | |

Allroad

| | | | | | |
|-----------------|-----|---------------|---|----------|--|
| 2.5 TDI quattro | 120 | 05/03 → 08/05 | D | BCZ | |
| | 132 | 05/00 → 08/05 | D | AKE, BAU | |

SKODA

Superb I

| | | | | | |
|---------|-----|---------------|---|-----|--|
| 2.5 TDI | 114 | 12/01 → 08/03 | D | AYM | |
| 2.5 TDI | 120 | 06/03 → 03/08 | D | BDG | |

VOLKSWAGEN

Passat IV, Variant

| | | | | | |
|------------------------|-----|---------------|---|----------|--|
| 2.5 TDI | 110 | 07/98 → 11/00 | D | AFB, AKN | |
| 2.5 TDI Syncro/4motion | 110 | 12/98 → 11/00 | D | AFB, AKN | |

Passat V, Variant

| | | | | | |
|-----------------|-----|---------------|---|----------|--|
| 2.5 TDI | 110 | 11/00 → 05/05 | D | AFB, AKN | |
| 2.5 TDI | 120 | 05/03 → 05/05 | D | BDG | |
| 2.5 TDI 4motion | 110 | 11/00 → 05/05 | D | AFB, AKN | |
| | 132 | 01/03 → 05/05 | D | BAU, BDH | |

81706
350981706000

PULEGGIA

Diametro Puleggia Ø56.1
 Numero Denti/Gole Puleggia 19
 Altezza Puleggia 28.5
 Posizione Attacco 47.2
 Diametro Girante Ø63.8
 N° Alette Girante 8
 Posizione Girante 46

KW

AUDI
A3 I

| | | | | | |
|---------|----|---------------|---|----------|-----------------------|
| 1.9 TDI | 66 | 09/96 → 07/01 | D | AGR, ALH | T →: F8L-V-115.001 |
| | 81 | 08/97 → 07/01 | D | AHF, ASV | T →: F8L-V-115.001 |

SEAT
Cordoba II, Vario

| | | | | | |
|---------|----|---------------|---|---------------|--|
| 1.9 SDI | 50 | 06/99 → 10/02 | D | AGP, AQM | |
| 1.9 TDI | 66 | 06/99 → 10/02 | D | AGR, AHU, ALH | |
| | 66 | 06/99 → 12/02 | D | AGR, ALH | |
| | 81 | 06/99 → 10/02 | D | ASK, ASV | |

Ibiza III

| | | | | | |
|---------|----|---------------|---|----------|--|
| 1.9 SDI | 50 | 08/99 → 02/02 | D | AGP, AQM | |
| 1.9 TDI | 66 | 08/99 → 02/02 | D | AGR, ALH | |
| | 81 | 08/99 → 02/02 | D | ASK, ASV | |

Inca

| | | | | | |
|---------|----|---------------|---|-----|-----------|
| 1.9 TDI | 66 | 09/96 → 06/03 | D | ALH | 11-1995 → |
|---------|----|---------------|---|-----|-----------|

Leon I

| | | | | | |
|---------|----|---------------|---|----------|--|
| 1.9 SDI | 50 | 11/99 → 06/06 | D | AQM | |
| 1.9 TDI | 66 | 11/99 → 06/06 | D | AGR, ALH | |
| | 81 | 11/99 → 06/06 | D | AHF, ASV | |

Toledo II

| | | | | | |
|---------|----|---------------|---|----------|-----------|
| 1.9 SDI | 50 | 11/99 → 06/04 | D | AQM | |
| 1.9 TDI | 66 | 03/99 → 07/04 | D | AGR, ALH | 05-1991 → |
| | 81 | 10/98 → 07/04 | D | AHF, ASV | 05-1991 → |

SKODA
Octavia I, Station Wagon

| | | | | | |
|-------------|----|---------------|---|----------|--|
| 1.9 SDI | 50 | 06/97 → 12/03 | D | AGP, AQM | |
| 1.9 TDI | 66 | 09/96 → 03/10 | D | AGR, ALH | |
| | 66 | 07/98 → 03/10 | D | AGR, ALH | |
| | 81 | 08/97 → 01/06 | D | AHF, ASV | |
| 1.9 TDI 4x4 | 66 | 11/99 → 02/06 | D | AGR | |

81706
350981706000

KW

VOLKSWAGEN
Bora, Station Wagon

| | | | | | |
|-----------------|----|---------------|---|----------|--|
| 1.9 SDI | 50 | 10/98 → 05/05 | D | AGP, AQM | |
| 1.9 TDI | 66 | 10/98 → 05/05 | D | AGR, ALH | |
| | 81 | 10/98 → 06/01 | D | AHF, ASV | |
| 1.9 TDI 4motion | 66 | 11/98 → 04/02 | D | AGR | |

Caddy II

| | | | | | |
|---------|----|---------------|---|----------|--------|
| 1.9 SDI | 47 | 11/95 → 01/04 | D | AEY, AYQ | M: AYQ |
|---------|----|---------------|---|----------|--------|

Golf IV, Variant, Cabrio

| | | | | | |
|-----------------|----|---------------|---|----------|----------------|
| 1.9 SDI | 50 | 08/97 → 06/05 | D | AGP, AQM | M: AQM, M: AGP |
| 1.9 TDI | 66 | 10/97 → 05/04 | D | AGR, ALH | M: ALH, M: AGR |
| | 81 | 08/97 → 05/04 | D | AHF, ASV | M: ASF, M: AHF |
| | 81 | 05/99 → 06/01 | D | AHF, ASV | M: ASV, M: AHF |
| 1.9 TDI 4motion | 66 | 07/98 → 04/02 | D | AGR, ALH | M: ALH, M: AGR |

New Beetle, Cabrio

| | | | | | |
|---------|----|---------------|---|-----|--|
| 1.9 TDI | 66 | 01/98 → 06/04 | D | ALH | |
|---------|----|---------------|---|-----|--|

Polo III (6N1), Classic, Variant, Van

| | | | | | |
|------------|----|---------------|---|--------------------|----------------|
| 1.9 SDI | 50 | 08/99 → 09/01 | D | AGP, AQM | |
| 1.9 TDI | 66 | 05/97 → 09/01 | D | AGR, AHU, ALE, ALH | M: ALH, M: AGR |
| | 81 | 06/98 → 09/01 | D | AFN, ASV | M: ASV |
| 68 1.9 SDI | 50 | 08/99 → 01/02 | D | AGP, AQM | |
| 90 1.9 TDI | 66 | 09/96 → 09/01 | D | AGR, AHU, ALE, ALH | M: ALH, M: AGR |

81707
350981707000

FLANGIA

Posizione Attacco 65
 Diametro Mozzo Ø28
 Diametro Girante Ø85.5
 N° Alette Girante 6
 Posizione Girante 0

KW

HONDA
Accord V, Aerodeck, Coupé

| | | | | | |
|---------|----|---------------|---|-------|--|
| 2.0 TDi | 77 | 04/96 → 10/98 | D | 20T2N | |
|---------|----|---------------|---|-------|--|

Accord VI, Aerodeck, Hatchback, Coupé

| | | | | | |
|--------------|----|---------------|---|-------|--|
| 2.0 TDi | 77 | 12/99 → 10/00 | D | 20T2N | |
| 2.0 Turbo DI | 77 | 02/99 → 12/02 | D | 20T2N | |

81707
350981707000

KW

HONDA
Civic VI, Hatchback, Aerodeck, Fastback, Coupé

| | | | | | |
|----------|----|---------------|---|-------|--|
| 2.0 i D | 77 | 04/98 → 02/01 | D | 20T2N | |
| 2.0 i TD | 63 | 01/97 → 02/01 | D | 20T2R | |
| 2.0 TDiC | 77 | 11/98 → 10/00 | D | 20T2N | |
| | 74 | 11/98 → 10/00 | D | 20T2N | |

LAND ROVER
Discovery I

| | | | | | |
|--------------|----|---------------|---|-------|--|
| 2.0 16 V 4x4 | 99 | 06/89 → 10/98 | B | 20T4H | |
|--------------|----|---------------|---|-------|--|

Freelander I

| | | | | | |
|------------|----|---------------|---|-------|--|
| 2.0 DI 4x4 | 72 | 02/98 → 11/00 | D | 20T2N | |
|------------|----|---------------|---|-------|--|

MG
MG ZR

| | | | | | |
|--------|----|---------------|---|-------|--|
| 2.0 TD | 74 | 06/01 → 04/05 | D | 20T2N | |
|--------|----|---------------|---|-------|--|

MG ZS

| | | | | | |
|--------|----|---------------|---|-------|--|
| 2.0 TD | 74 | 01/04 → 04/05 | D | 20T2N | |
| | 83 | 01/04 → 04/05 | D | 20T2N | |

ROVER
25

| | | | | | |
|---------|----|---------------|---|-------|--|
| 2.0 iDT | 74 | 10/99 → 05/05 | D | 20T2N | |
|---------|----|---------------|---|-------|--|

45

| | | | | | |
|---------|----|---------------|---|-------|--|
| 2.0 iDT | 74 | 02/00 → 05/05 | D | 20T2N | |
|---------|----|---------------|---|-------|--|

200 II, Coupé

| | | | | | |
|-----------|-----|---------------|---|-------|--|
| 2.0 | 152 | 10/92 → 09/97 | B | | |
| 220 GSi | 100 | 05/94 → 06/99 | B | 20T4H | |
| 220 GTi | 100 | 01/93 → 10/95 | B | 20T4H | |
| | 103 | 09/91 → 10/95 | B | 20M4F | |
| 220 Turbo | 147 | 01/93 → 10/95 | B | 20T4G | |

200 III

| | | | | | |
|----------|----|---------------|---|-------|--|
| 220 D/SD | 63 | 11/95 → 03/00 | D | 20T2R | |
| 220 SDi | 77 | 11/95 → 03/00 | D | 20T2N | |

400 I, Station Wagon

| | | | | | |
|-----------------------|-----|---------------|---|-------|-----------|
| 2.0 i | 100 | 05/94 → 11/98 | B | 20T4H | |
| 2.0 Turbo GSi Sport | 152 | 10/92 → 04/95 | B | | |
| 420 GSi/SLI/ GTI/Vite | 100 | 01/93 → 04/95 | B | 20T4H | |
| 420 GTI/ GSi/Vitesse | 103 | 02/92 → 04/95 | B | 20M4F | 10-1992 → |
| 420 Turbo | 147 | 01/93 → 04/95 | B | 20T4G | |

400 II

| | | | | | |
|------------|-----|---------------|---|-------|--|
| 420 D | 63 | 11/95 → 03/00 | D | 20T2R | |
| 420 Di | 77 | 05/95 → 03/00 | D | 20T2N | |
| 420 Si Lux | 100 | 12/95 → 03/00 | B | 20T4H | |

81707
350981707000

KW

HONDA
600

| | | | | | |
|----------------|-----|---------------|---|-------|--|
| 620 Sdi | 77 | 12/94 → 02/99 | D | 20T2N | |
| 620 Ti Vitesse | 147 | 07/94 → 02/99 | B | 20T4G | |

800

| | | | | | |
|---------------|-----|---------------|---|-------|--|
| 820 16V Turbo | 132 | 01/92 → 02/99 | B | T16 | |
| 820 I/SI | 100 | 01/92 → 02/99 | B | 20T4H | |
| 820 Sport | 145 | 04/94 → 03/96 | B | 20T4G | |

Streetwise

| | | | | | |
|--------|----|---------------|---|-------|--|
| 2.0 TD | 74 | 08/03 → 05/05 | D | 20T2N | |
|--------|----|---------------|---|-------|--|

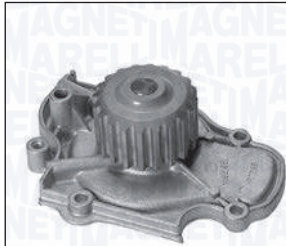
81708
350981708000

PULEGGIA

| | |
|----------------------------|--------|
| Diametro Puleggia | Ø59.26 |
| Numero Denti/Gole Puleggia | 20 |
| Altezza Puleggia | 28.5 |
| Posizione Attacco | 56 |
| Diametro Girante | Ø56.5 |
| N° Alette Girante | 7 |
| Posizione Girante | 20.3 |

KW

ACURA
CL

| | | | | | |
|----------|-----|---------------|---|-------|--|
| 2.2 | 108 | 10/96 → 09/97 | B | F22B2 | |
| 2.3 Vtec | 112 | 10/98 → 09/00 | B | F23A7 | |

HONDA
Accord IV, Aerodeck, Coupé

| | | | | | |
|---------------------|-----|---------------|---|--------------|--|
| 2.0 16V | 66 | 01/90 → 03/93 | B | F20A6 | |
| | 81 | 01/90 → 03/93 | B | F20A2, F20A3 | |
| 2.0 i 16V | 98 | 01/90 → 03/93 | B | F20A4, F20A8 | |
| | 98 | 01/92 → 09/93 | B | F20A7 | |
| | 98 | 03/93 → 12/93 | B | F20Z3 | |
| | 108 | 01/91 → 12/93 | B | F22A8 | |
| | 110 | 01/90 → 03/93 | B | F22A3 | |
| | 110 | 01/91 → 12/93 | B | F22A7 | |
| 2.2 i 16V Automatic | 108 | 01/90 → 03/93 | B | F22A3 | |

81708 350981708000

HONDA
Accord V, Aerodeck, Coupé

| | | | | |
|-------------|-----|---------------|---|-------|
| 1.9 i | 85 | 02/96 → 10/98 | B | F18A3 |
| 2.0 | 100 | 09/93 → 12/97 | B | F20B3 |
| 2.0 i | 85 | 03/93 → 01/96 | B | F20Z2 |
| 2.0 iLS | 96 | 02/96 → 10/98 | B | F20Z1 |
| 2.0 iLS 16V | 100 | 09/93 → 02/98 | B | F20B3 |
| 2.0 iS | 96 | 03/93 → 01/96 | B | F20Z1 |
| 2.2 i ES | 110 | 09/93 → 02/98 | B | F22B5 |
| 2.2 i VTEC | 110 | 02/96 → 10/98 | B | F22Z2 |

Accord VI, Aerodeck, Hatchback, Coupé

| | | | | |
|------------------------|-----|---------------|---|-----------------|
| 2.0 | 108 | 12/99 → 12/02 | B | F20B6 |
| 2.0 i | 108 | 10/98 → 01/01 | B | F20B6 |
| 2.0 i 16V | 108 | 02/98 → 06/03 | B | F20B5, F20B7 |
| 2.3 | 113 | 01/01 → 06/03 | B | F23A1, F23Z5 |
| | 113 | 11/00 → 12/02 | B | F23Z5 |
| 2.3 16 V | 118 | 02/98 → | B | F23A7 |
| 2.3 VTi | 113 | 02/98 → 10/02 | B | F23A3 |
| 2.0 | 114 | 02/03 → 05/08 | B | K20A6 |
| | 114 | 04/03 → 05/08 | B | K20A6 |
| 2.0 Trazione integrale | 114 | 02/03 → 05/08 | B | K20A6 |

Prelude IV

| | | | | |
|----------------|-----|---------------|---|-------|
| 2.0 i 16V | 98 | 02/92 → 09/96 | B | F20A4 |
| 2.2 i 16V Vtec | 136 | 02/93 → 09/96 | B | H22A2 |

Prelude V

| | | | | |
|---------|-----|---------------|---|-----------------|
| 2.0 16V | 98 | 10/96 → 10/00 | B | F20A4 |
| 2.2 16V | 147 | 10/96 → 10/00 | B | H22A5 |
| | 136 | 10/96 → 10/00 | B | H22A2, H22A5 |

Shuttle

| | | | | |
|-------------|-----|---------------|---|-------|
| 2.2 16V | 110 | 10/94 → 02/98 | B | F22B8 |
| 2.2 4x4 | 102 | 06/94 → 09/97 | B | F22B9 |
| 2.3 16V | 110 | 10/97 → 06/04 | B | F23A7 |
| 2.3 16V 4x4 | 110 | 10/97 → 06/02 | B | F23A |

ROVER
600

| | | | | |
|----------|----|---------------|---|-------|
| 618 i/Si | 85 | 03/96 → 02/99 | B | F18A3 |
| 620 i | 85 | 08/93 → 06/96 | B | F20Z2 |
| 620 Si | 96 | 08/93 → 02/99 | B | F20Z1 |

81709 350981709000

PULEGGIA

| | |
|----------------------------|-------|
| Diametro Puleggia | Ø56.3 |
| Numero Denti/Gole Puleggia | 19 |
| Altezza Puleggia | 26.5 |
| Posizione Attacco | 56 |
| Diametro Girante | Ø59.5 |
| N° Alette Girante | 7 |
| Posizione Girante | 20.2 |

HONDA
Accord V, Aerodeck, Coupé

| | | | | |
|----------|-----|---------------|---|-------|
| 2.3 i SR | 116 | 03/93 → 01/96 | B | H23A3 |
|----------|-----|---------------|---|-------|

HONDA
Prelude IV

| | | | | |
|-----------|-----|---------------|---|-------|
| 2.3 i 16V | 118 | 02/92 → 09/96 | B | H23A2 |
|-----------|-----|---------------|---|-------|

ROVER
600

| | | | | |
|--------|-----|---------------|---|-------|
| 623 Si | 116 | 08/93 → 02/99 | B | H23A3 |
|--------|-----|---------------|---|-------|

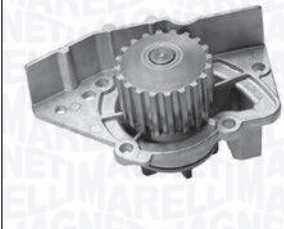
81710 350981710000

PULEGGIA

| | |
|----------------------------|--------|
| Diametro Puleggia | Ø59.31 |
| Numero Denti/Gole Puleggia | 20 |
| Altezza Puleggia | 33.8 |
| Posizione Attacco | 42.5 |
| Diametro Girante | Ø60 |
| N° Alette Girante | 6 |
| Posizione Girante | 40 |

CITROËN
Xantia I, Break

| | | | | | |
|-----------|----|---------------|---|--------------|-----------|
| 1.8 i 16V | 81 | 06/95 → 01/98 | B | LFY (XU7JP4) | 11-1996 → |
|-----------|----|---------------|---|--------------|-----------|

Xantia II, Break

| | | | | |
|-----------|----|---------------|---|--------------|
| 1.8 i 16V | 81 | 01/98 → 04/03 | B | LFY (XU7JP4) |
|-----------|----|---------------|---|--------------|

Xsara, Break, Coupé, Picasso, Van

| | | | | | |
|-----------|----|---------------|---|--------------|-----------|
| 1.8 i 16V | 81 | 04/97 → 09/00 | B | LFY (XU7JP4) | 07-1997 → |
| | 81 | 10/97 → 09/00 | B | LFY (XU7JP4) | |
| 1.8 LPG | 81 | 05/98 → 08/00 | | LFY (XU7JP4) | |

ZX, Break

| | | | | |
|-----------|----|---------------|---|--------------|
| 1.8 i 16V | 81 | 01/96 → 06/97 | B | LFY (XU7JP4) |
|-----------|----|---------------|---|--------------|

81710 350981710000



PEUGEOT

306, Station Wagon, Coupé, Cabrio, Van

| | | | | | |
|---------|----|---------------|---|-----------------|--|
| 1.8 16V | 81 | 03/97 → 05/01 | B | LFY (XU7JP4) | |
|---------|----|---------------|---|-----------------|--|

407, Station Wagon, Coupé

| | | | | | |
|---------|----|---------------|---|-----------------|--|
| 1.8 16V | 85 | 10/00 → 05/04 | B | 6FZ (EW7J4) | |
| | 81 | 11/95 → 10/00 | B | LFY (XU7JP4) | |

81711 350981711000

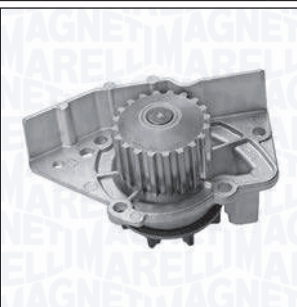

PULEGGIA

| | |
|----------------------------|--------|
| Diametro Puleggia | Ø59.31 |
| Numero Denti/Gole Puleggia | 20 |
| Altezza Puleggia | 33.8 |
| Posizione Attacco | 42.5 |
| Diametro Girante | Ø69 |
| N° Alette Girante | 8 |
| Posizione Girante | 41.3 |



CITROËN

Evasion

| | | | | | |
|---------|----|---------------|---|------------------|--|
| 2.0 16V | 97 | 05/98 → 04/00 | B | RFV (XU10J4R) | |
|---------|----|---------------|---|------------------|--|

Xantia I, Break

| | | | | | |
|-----------|----|---------------|---|------------------|-----------|
| 2.0 i 16V | 97 | 06/95 → 01/98 | B | RFV (XU10J4R) | 11-1996 → |
|-----------|----|---------------|---|------------------|-----------|

Xantia II, Break

| | | | | | |
|-----------|----|---------------|---|------------------|--|
| 2.0 i 16V | 97 | 01/98 → 04/03 | B | RFV (XU10J4R) | |
|-----------|----|---------------|---|------------------|--|

XM II, Break

| | | | | | |
|-----------|----|---------------|---|------------------|-----------|
| 2.0 i 16V | 97 | 05/94 → 10/00 | B | RFV (XU10J4R) | 08-1994 → |
|-----------|----|---------------|---|------------------|-----------|

Xsara, Break, Coupé, Picasso, Van

| | | | | | |
|-----------|-----|---------------|---|-------------------|-----------|
| 2.0 16V | 97 | 07/98 → 09/00 | B | RFV (XU10J4R) | |
| | 120 | 04/97 → 09/00 | B | RFS (XU10J4RS) | 01-1998 → |
| 2.0 i 16V | 120 | 02/98 → 03/05 | B | RFS (XU10J4RS) | |

FIAT

Ulysse I

| | | | | | |
|---------|-----|---------------|---|-----------------|--|
| 2.0 16V | 100 | 09/00 → 08/02 | B | RFN (EW10J4) | |
| | 97 | 05/98 → 09/00 | B | RFV | |

81711 350981711000



LANCIA

Zeta

| | | | | | |
|---------|----|---------------|---|------------------|--|
| 2.0 16V | 97 | 05/98 → 07/00 | B | RFV (XU10J4R) | |
|---------|----|---------------|---|------------------|--|

PEUGEOT

306, Station Wagon, Coupé, Cabrio, Van

| | | | | | |
|---------|-----|---------------|---|-------------------|--|
| 2.0 | 97 | 03/97 → 05/01 | B | RFV (XU10J4R) | |
| 2.0 16V | 97 | 03/97 → 05/01 | B | RFV (XU10J4R) | |
| | 99 | 03/97 → 06/00 | B | RFV (XU10J4R) | |
| 2.0 S16 | 120 | 03/96 → 05/01 | B | RFS (XU10J4RS) | |

407, Station Wagon, Coupé

| | | | | | |
|---------|-----|---------------|---|-------------------|-----------|
| 2.0 | 104 | 11/96 → 03/99 | B | RGY (XU10J2TE) | |
| 2.0 16V | 97 | 11/95 → 05/04 | B | RFV (XU10J4R) | → 03-1999 |
| | 97 | 03/97 → 12/04 | B | RFV (XU10J4R) | → 12-1999 |
| 2.0 16V | 99 | 04/99 → 09/04 | B | RFV (XU10J4R) | |

605

| | | | | | |
|---------|----|---------------|---|------------------|--|
| 2.0 16V | 97 | 07/94 → 09/99 | B | RFV (XU10J4R) | |
|---------|----|---------------|---|------------------|--|

806

| | | | | | |
|---------|----|---------------|---|------------------|--|
| 2.0 16V | 97 | 05/98 → 09/00 | B | RFV (XU10J4R) | |
|---------|----|---------------|---|------------------|--|

81712
350981712000

PULEGGIA

| | |
|----------------------------|-------|
| Diametro Puleggia | Ø75 |
| Numero Denti/Gole Puleggia | 3 |
| Altezza Puleggia | 19 |
| Posizione Attacco | 60 |
| Diametro Girante | Ø79.5 |
| N° Alette Girante | 8 |
| Posizione Girante | 29.25 |

KW

CITROËN
Jumper I

| | | | | | |
|-------------|----|---------------|---|--------------|-----------|
| 2.5 D | 63 | 08/94 → 04/02 | D | T9A (DJ5) | 05-1996 → |
| 2.5 D 4x4 | 63 | 08/96 → 04/02 | D | T9A (DJ5) | |
| 2.5 DT 4x4 | 76 | 10/96 → 08/97 | D | THZ (DJ5T) | |
| 2.5 TD | 76 | 08/94 → 04/02 | D | T8A (DJ5T) | 05-1996 → |
| 2.5 TD 4x4 | 76 | 08/96 → 04/02 | D | T8A (DJ5T) | |
| 2.5 TDi | 79 | 12/96 → 11/00 | D | THX (DJ5TED) | |
| 2.5 TDi 4x4 | 79 | 12/96 → 11/00 | D | THX (DJ5TED) | |

XM II, Break

| | | | | | |
|--------|----|---------------|---|--------------|---------------|
| 2.5 TD | 95 | 05/94 → 10/00 | D | THY (DK5ATE) | PROD → : 7144 |
|--------|----|---------------|---|--------------|---------------|

PEUGEOT
605

| | | | | | |
|------------------|----|---------------|---|--------------|--------------------------|
| 2.5 Turbo Diesel | 95 | 07/94 → 09/99 | D | THY (DK5ATE) | 04-1995 →, PROD → : 7144 |
|------------------|----|---------------|---|--------------|--------------------------|

Boxer I

| | | | | | |
|-------------|----|---------------|---|--------------|--------------------------|
| 2.5 D | 63 | 08/94 → 04/02 | D | T9A (DJ5) | 06-1996 →, PROD → : 7144 |
| 2.5 D 4x4 | 63 | 07/96 → 04/02 | D | T9A (DJ5) | |
| 2.5 DT | 62 | 10/97 → 11/01 | D | | |
| 2.5 TD | 76 | 07/94 → 04/02 | D | T8A (DJ5T) | 06-1996 →, PROD → : 7144 |
| 2.5 TD 4x4 | 76 | 07/96 → 04/02 | D | T8A (DJ5T) | |
| 2.5 TDi | 79 | 01/97 → 04/02 | D | THX (DJ5TED) | |
| 2.5 TDi 4x4 | 79 | 01/97 → 04/02 | D | THX (DJ5TED) | |

81713
350981713000

PULEGGIA

| | |
|----------------------------|-------|
| Diametro Puleggia | Ø59.3 |
| Numero Denti/Gole Puleggia | 20 |
| Altezza Puleggia | 33.8 |
| Posizione Attacco | 42.5 |
| Diametro Girante | Ø69 |
| N° Alette Girante | 7 |
| Posizione Girante | 42 |

KW

CITROËN
Berlingo I, Van

| | | | | | |
|----------------|----|---------------|---|-----------------------|--|
| 1.9 D | 51 | 07/98 → 10/05 | D | WJY (DW8B), WJZ (DW8) | |
| 1.9 D 4WD | 51 | 07/98 → | D | WJY (DW8B), WJZ (DW8) | |
| 1.9 D 70 | 51 | 04/99 → | D | WJY (DW8B), WJZ (DW8) | |
| 1.9 D 70 4WD | 51 | 07/98 → | D | WJY (DW8B), WJZ (DW8) | |
| 2.0 HDi 4x4 | 66 | 11/02 → 10/05 | D | RHY (DW10TD) | |
| 2.0 HDi 90 | 66 | 12/99 → | D | RHY (DW10TD) | |
| 2.0 HDi 90 4WD | 66 | 11/00 → | D | RHY (DW10TD) | |

C 15

| | | | | | |
|-------|----|---------------|---|------------|--|
| 1.9 D | 44 | 12/00 → 12/05 | D | WJX (DW8B) | |
|-------|----|---------------|---|------------|--|

C 4 I, Coupé, Picasso, Grand Picasso

| | | | | | |
|---------|----|---------------|---|----------------|--|
| 2.0 HDi | 81 | 04/07 → 07/08 | D | RHZ (DW10ATED) | |
|---------|----|---------------|---|----------------|--|

C 5 I, Break

| | | | | | |
|---------|----|---------------|---|--------------------------------|--|
| 2.0 HDi | 79 | 03/01 → 08/04 | D | RHS (DW10ATED), RHZ (DW10ATED) | |
| | 80 | 06/01 → 08/04 | D | RHZ (DW10ATED) | |
| | 66 | 03/01 → 08/04 | D | RHY (DW10TD) | |
| | 79 | 06/01 → 08/04 | D | RHS (DW10ATED), RHZ (DW10ATED) | |
| | 80 | 03/01 → 08/04 | D | RHZ (DW10ATED) | |

81713
350981713000

KW

CITROËN
C 8

| | | | | |
|---------|----|---------|---|---|
| 2.0 HDi | 79 | 07/02 → | D | RHM (DW10ATED4), RHT (DW10ATED4) |
|---------|----|---------|---|---|

Evasion

| | | | | |
|----------------|----|---------------|---|--------------------|
| 2.0 HDI | 80 | 08/99 → 07/02 | D | RHZ (DW10ATED) |
| 2.0 HDI 16V | 80 | 09/99 → 07/02 | D | RHW (DW10ATED4) |

Jumper I

| | | | | |
|---------|----|---------------|---|------------------|
| 2.0 HDI | 62 | 11/01 → 04/02 | D | RHV (DW10UTD) |
|---------|----|---------------|---|------------------|

Jumper II

| | | | | |
|---------|----|---------|---|--------------------------------------|
| 2.0 HDi | 62 | 04/02 → | D | RHV (DW10TD), RHV (DW10UTD) |
| | 62 | 04/02 → | D | RHV (DW10UTD) |

Jumpy I

| | | | | |
|-------------|----|---------|---|--------------------------|
| 1.9 D 70 | 51 | 04/98 → | D | WJY (DW8B), WJZ (DW8) |
| 2.0 HDi 110 | 80 | 03/00 → | D | RHW (DW10ATED4) |
| | 80 | 03/00 → | D | RHZ (DW10ATED) |
| 2.0 HDi 95 | 69 | 10/99 → | D | RHX (DW10BTED) |

Jumpy II

| | | | | |
|--------------------|----|---------------|---|--------------------|
| 2.0 HDi 110 | 80 | 12/03 → 10/06 | D | RHZ (DW10ATED) |
| 2.0 HDi 110 16V | 80 | 12/03 → 10/06 | D | RHW (DW10ATED4) |
| 2.0 HDi 95 | 69 | 10/99 → | D | RHX (DW10BTED) |

Xantia II, Break

| | | | | |
|----------------|----|---------------|---|-------------------|
| 2.0 HDI 109 | 80 | 02/99 → 04/03 | D | RHZ (DW10ATED) |
| 2.0 HDI 90 | 66 | 03/99 → 04/03 | D | RHY (DW10TD) |

81713
350981713000

KW

CITROËN
Xsara, Break, Coupé, Picasso, Van

| | | | | |
|-------------|----|---------------|---|--------------------------|
| 1.9 D | 51 | 07/98 → 03/05 | D | WJY (DW8B), WJZ (DW8) |
| 2.0 HDi | 66 | 09/00 → 03/05 | D | RHY (DW10TD) |
| 2.0 HDi 109 | 80 | 05/01 → 03/05 | D | RHZ (DW10ATED) |
| 2.0 HDi 90 | 66 | 02/99 → 03/05 | D | RHY (DW10TD) |

FIAT
Ducato III

| | | | | |
|---------|----|---------------|---|------------|
| 2.0 JTD | 62 | 10/01 → 04/02 | D | RHV (DW10) |
|---------|----|---------------|---|------------|

Ducato IV

| | | | | |
|---------|----|---------|---|------------|
| 2.0 JTD | 62 | 04/02 → | D | RHV (DW10) |
|---------|----|---------|---|------------|

Scudo I

| | | | | |
|----------------|----|---------------|---|-------------------|
| 2.0 JTD | 69 | 01/04 → 12/06 | D | RHX |
| | 80 | 12/99 → 12/06 | D | RHZ |
| 2.0 JTD 16V | 80 | 05/99 → 12/06 | D | RHW (DW10ATED) |

Ulysse I

| | | | | |
|----------------|----|---------------|---|-------------------|
| 2.0 JTD | 80 | 10/99 → 08/02 | D | RHZ |
| 2.0 JTD 16V | 80 | 05/99 → 08/02 | D | RHW (DW10ATED) |

Ulysse II

| | | | | |
|---------|----|---------------|---|-------------------|
| 2.0 JTD | 79 | 05/03 → 08/06 | D | RHM (DW10ATED) |
| | 80 | 08/02 → 08/06 | D | RHW (DW10ATED) |

LANCIA
Phedra

| | | | | |
|---------|----|---------------|---|-------------------|
| 2.0 JTD | 79 | 07/03 → 11/10 | D | RHM (DW10ATED) |
| | 80 | 09/02 → 11/10 | D | RHW (DW10ATED) |

Zeta

| | | | | |
|-------------|----|---------------|---|------------------------|
| 2.0 JTD | 80 | 04/00 → 09/02 | D | RHZ (DW10ATED) |
| 2.0 JTD 16V | 80 | 09/99 → 09/02 | D | RHW, RHW (DW10ATED) |

81713 350981713000

PEUGEOT
205 II, Van

| | | | | |
|------------|----|---------------|---|-----------------------|
| 1.9 D | 51 | 09/98 → 11/01 | D | WJY (DW8B), WJZ (DW8) |
| 2.0 HDI 90 | 66 | 12/99 → | D | RHY (DW10TD) |

206, CC, Van

| | | | | |
|---------|----|---------------|---|--------------|
| 1.9 D | 51 | 04/99 → 05/07 | D | WJZ (DW8) |
| 2.0 HDi | 66 | 07/02 → | D | RHY (DW10TD) |

306, Station Wagon, Coupé, Cabrio, Van

| | | | | |
|------------|----|---------------|---|-----------------------|
| 1.9 D | 51 | 09/98 → 05/01 | D | WJY (DW8B), WJZ (DW8) |
| 2.0 HDI 90 | 66 | 06/99 → 05/01 | D | RHY (DW10TD) |

307, Station Wagon, CC

| | | | | |
|-------------|----|---------|---|----------------|
| 2.0 HDi 110 | 79 | 08/00 → | D | RHS (DW10ATED) |
| 2.0 HDi 90 | 66 | 08/00 → | D | RHY (DW10TD) |

407, Station Wagon, Coupé

| | | | | |
|-------------|----|---------------|---|--------------------------------|
| 2.0 HDi 110 | 79 | 08/01 → 05/04 | D | RHS (DW10ATED), RHZ (DW10ATED) |
| 2.0 HDi 110 | 80 | 06/98 → 08/01 | D | RHZ (DW10ATED) |
| 2.0 HDi 90 | 66 | 02/99 → 05/04 | D | RHY (DW10TD) |

607

| | | | | |
|---------|----|---------------|---|----------------|
| 2.0 HDi | 79 | 03/01 → 07/04 | D | RHS (DW10ATED) |
| 2.0 HDI | 80 | 05/00 → | D | RHZ (DW10ATED) |

806

| | | | | |
|-------------|----|---------------|---|-----------------|
| 2.0 HDI | 80 | 08/99 → 08/02 | D | RHZ (DW10ATED) |
| 2.0 HDI 16V | 80 | 08/99 → 08/02 | D | RHW (DW10ATED4) |

807

| | | | | |
|---------|----|---------|---|---|
| 2.0 HDi | 79 | 06/02 → | D | RHM (DW10ATED4), RHT (DW10ATED4), RHW (DW10ATED4) |
|---------|----|---------|---|---|

81713 350981713000

PEUGEOT
Boxer I

| | | | | |
|---------|----|---------------|---|-----------------------------|
| 2.0 HDI | 62 | 08/01 → 04/02 | D | RHV (DW10UTD) |
| 2.0 HDi | 62 | 04/02 → | D | RHV (DW10TD), RHV (DW10UTD) |

Expert I

| | | | | |
|-------------|----|---------------|---|--|
| 1.9 D | 51 | 12/03 → | D | WJY (DW8B), WJZ (DW8) |
| 1.9 D 70 | 51 | 12/98 → | D | WJY (DW8B), WJZ (DW8) |
| 2.0 HDi | 69 | 10/00 → 11/03 | D | RHX (DW10BTED) |
| | 80 | 10/00 → 10/06 | D | RHW (DW10ATED4) |
| | 80 | 07/00 → | D | RHZ (DW10ATED), RHZ (DW10BTED), RHZ (DW10CTED) |
| 2.0 HDI 16V | 80 | 07/00 → | D | RHW (DW10ATED4) |

Partner I

| | | | | |
|-------------|----|---------------|---|-----------------------|
| 1.9 D | 51 | 06/96 → | D | WJY (DW8B), WJZ (DW8) |
| 1.9 D 4x4 | 51 | 04/04 → 08/05 | D | WJY (DW8B) |
| 2.0 HDI | 66 | 02/00 → | D | RHY (DW10TD) |
| 2.0 HDi 4x4 | 66 | 04/04 → | D | RHY (DW10TD) |

SUZUKI
Grand Vitara I

| | | | | |
|-----------------|----|---------------|---|----------|
| 2.0 HDI 110 16V | 80 | 07/01 → 09/05 | D | RHW, RHZ |
|-----------------|----|---------------|---|----------|

81714
350981714000

| FLANGIA | |
|-------------------------|-------|
| Numero Fori Flangia | 4 |
| Dimensione Fori Flangia | M6×1 |
| Posizione Attacco | 87.5 |
| Diametro Mozzo | Ø23.5 |
| Diametro Girante | Ø61 |
| N° Alette Girante | 7 |
| Posizione Girante | 2 |

DAIHATSU
Applause I

| | | | | |
|-------------|----|---------------|---|------|
| 1.6 16V | 66 | 06/89 → 07/97 | B | HD |
| | 77 | 06/89 → 07/97 | B | HD-E |
| 1.6 16V 4WD | 77 | 06/89 → 07/97 | B | HD-E |

Applause II

| | | | | |
|---------|----|---------------|---|------|
| 1.6 16V | 73 | 07/97 → 05/00 | B | HD-E |
|---------|----|---------------|---|------|

Charade III

| | | | | |
|-----------|----|---------------|---|------|
| 1.3 | 56 | 09/88 → 01/92 | B | HC-C |
| | 66 | 11/90 → 02/93 | B | HCE |
| 1.3 i | 66 | 06/88 → 12/92 | B | HCE |
| 1.3 i 4WD | 66 | 06/88 → 01/93 | B | HCE |

Charade IV

| | | | | |
|-----------|----|---------------|---|-----------|
| 1.0 | 38 | 09/94 → 03/96 | B | CB22 |
| 1.3 | 44 | 09/96 → 11/99 | B | HC |
| 1.3 16V | 55 | 05/96 → 11/99 | B | HCE |
| 1.3 i 16V | 62 | 01/93 → 09/00 | B | HC, HCE |
| 1.5 16V | 55 | 10/94 → | B | HEE |
| 1.5 HG | 55 | 06/94 → 03/96 | B | HEE, HEEG |
| 1.5 i 16V | 66 | 08/94 → | B | HEE |
| | 66 | 01/97 → 11/99 | B | HEE, HEEG |
| 1.6 GTi | 77 | 03/93 → 11/99 | B | HD-E |

Gran Move

| | | | | |
|---------|----|---------------|---|------|
| 1.5 16V | 66 | 10/96 → 07/98 | B | HEEG |
| 1.6 16V | 67 | 05/98 → | B | HDEP |
| 1.6 GLX | 77 | 06/98 → 07/02 | B | HDEP |
| 1.6 GX | 67 | 06/98 → 07/02 | B | HDEP |

Hijet IV

| | | | | |
|-----------|----|---------|---|-----|
| 1.3 i 16V | 48 | 05/98 → | B | HCE |
|-----------|----|---------|---|-----|

Rocky Soft Top, Hard Top

| | | | | |
|--------|----|---------------|---|-----------|
| 2.8 TD | 67 | 12/87 → 04/93 | D | DL51 |
| | 75 | 09/91 → 12/98 | D | DL52, DLT |

81715
350981715000

| FLANGIA | |
|-------------------------|------|
| Numero Fori Flangia | 4 |
| Dimensione Fori Flangia | M6×1 |
| Posizione Attacco | 87.4 |
| Diametro Mozzo | Ø32 |
| Diametro Girante | Ø61 |
| N° Alette Girante | 7 |
| Posizione Girante | 2 |

DAIHATSU
Feroza Soft Top, Hard Top

| | | | | |
|---------------|----|---------------|---|------|
| 1.6 16V | 63 | 10/88 → 12/99 | B | HDC |
| 1.6 i 16V | 70 | 10/88 → 12/99 | B | HD-E |
| 1.6 i 16V 4x4 | 70 | 10/88 → 12/99 | B | HD-E |

Terios I

| | | | | |
|---------|----|---------------|---|-------|
| 1.3 4WD | 61 | 10/97 → 10/00 | B | HC-EJ |
|---------|----|---------------|---|-------|

81716
350981716000

| FLANGIA | |
|-------------------------|-------|
| Numero Fori Flangia | 3 |
| Dimensione Fori Flangia | M6×1 |
| Posizione Attacco | 76.3 |
| Diametro Mozzo | Ø23.5 |
| Diametro Girante | Ø57 |
| N° Alette Girante | 8 |
| Posizione Girante | 12 |

FORD
Fiesta IV, Van

| | | | | |
|-------|----|---------------|---|-----------------------------------|
| 1.3 i | 37 | 08/95 → 01/02 | B | JJA, JJC, JJE, JJJ, JJK, JJM |
| | 44 | 08/95 → 01/02 | B | J4C, J4J, J4L, J4Q, J4R, J4T, JBC |

KA I, StreetKa, Van

| | | | | |
|-------|----|---------------|---|-----------------------------------|
| 1.0 i | 38 | 07/97 → 09/99 | B | ZH10JRB |
| | 48 | 09/99 → 11/08 | B | |
| 1.3 i | 36 | 06/98 → 11/08 | B | JJD, JJF, JJG, JJH, JJJ |
| | 37 | 09/96 → 10/02 | B | JJB |
| | 44 | 09/96 → 11/08 | B | BAA, J4D, J4K, J4M, J4N, J4P, J4S |

M: J4P, M: J4D, M: J4K, M: J4P

81716
350981716000

MAZDA
121

| | | | | |
|-----|----|---------------|---|----------|
| 1.3 | 37 | 03/96 → 04/03 | B | JJK, JJM |
| | 44 | 03/96 → 04/03 | B | J4R, J4T |

81717
350981717000

PULEGGIA

Diametro Puleggia Ø62.35

Numero Denti/Gole Puleggia 21

Altezza Puleggia 26.5

Posizione Attacco 47

Diametro Girante Ø63

N° Alette Girante 6

Posizione Girante 52.5

LADA
110

| | | | | |
|-----|----|---------|---|----------|
| 1.5 | 54 | 01/95 → | B | BA32111 |
| | 56 | 10/00 → | B | VAZ-2111 |
| | 57 | 01/95 → | B | VAZ-2111 |

Samara

| | | | | |
|------|----|---------------|---|--------------------|
| 1.5 | 57 | 04/96 → | B | VAZ-2111 |
| 1100 | 43 | 02/96 → | B | BA321081 |
| | 39 | 02/88 → 12/94 | B | BA321081 03-1992 → |
| 1300 | 45 | 09/91 → | B | BA32108 03-1992 → |
| | 48 | 01/86 → 12/94 | B | BA32108 03-1992 → |
| | 50 | 02/96 → | B | BA321115 |
| 1500 | 52 | 02/95 → | B | BA32111 |
| | 50 | 09/91 → | B | BA321083 03-1992 → |

Samara Forma

| | | | | |
|------|----|---------------|---|--------------------|
| 1.5 | 57 | 01/00 → | B | VAZ-2111 |
| 1100 | 39 | 07/91 → | B | BA321081 03-1992 → |
| 1300 | 45 | 07/91 → | B | BA32108 03-1992 → |
| | 46 | 05/90 → | B | BA32108 03-1992 → |
| | 48 | 05/89 → 07/97 | B | BA32108 03-1992 → |
| | 50 | 02/96 → | B | BA321115 |
| 1500 | 52 | 11/94 → | B | BA32111 |
| | 50 | 07/91 → | B | BA321083 03-1992 → |
| | 53 | 09/91 → | B | BA321083 03-1992 → |

81722
350981722000

FLANGIA

Numero Fori Flangia 3

Dimensione Fori Flangia M8x1.25

Posizione Attacco 128.2

Diametro Mozzo Ø30

Diametro Girante Ø77

N° Alette Girante 4

Posizione Girante 22

DAEWOO
Korando, Cabrio

| | | | | |
|---------|-----|---------|---|----------|
| 3.2 4x4 | 156 | 01/99 → | B | M104.995 |
|---------|-----|---------|---|----------|

Musso

| | | | | |
|---------|-----|---------|---|----------|
| 3.2 4x4 | 162 | 01/99 → | B | M104.992 |
|---------|-----|---------|---|----------|

MERCEDES-BENZ
Classe C I (W202), Station Wagon (S202)

| | | | | |
|---------|-----|---------------|---|-------------------|
| C 200 D | 55 | 03/93 → 05/00 | D | OM601.913 |
| | 142 | 05/93 → 05/00 | B | M104.941 |
| C 280 | 145 | 06/97 → 05/00 | B | M112.920 |
| | 145 | 06/97 → 03/01 | B | M112.920 |
| C 280 T | 206 | 05/94 → 05/00 | B | M104.941 (AMG3.6) |

Classe E I (W124), Station Wagon (S124), Cabrio (A124), Coupé (C124)

| | | | | |
|----------|-----|---------------|---|-------------------------------|
| E 280 | 142 | 06/93 → 06/95 | B | M104.942 06-1993 →, → 06-1995 |
| | 145 | 06/93 → 06/95 | B | M104.942 06-1993 →, → 06-1995 |
| E 280 T | 142 | 06/93 → 06/96 | B | M104.942 06-1993 →, → 01-1996 |
| | 145 | 06/93 → 06/96 | B | M104.942 06-1993 →, → 01-1996 |
| E 320 | 162 | 06/93 → 06/95 | B | M104.992 06-1993 → |
| | 162 | 06/93 → 03/98 | B | M104.992, M104.995 06-1993 → |
| E 320 T | 162 | 06/93 → 06/96 | B | M104.992 06-1993 → |
| E 36 AMG | 200 | 05/94 → 03/98 | B | M104.992 (AMG3.6) |

Classe E II (W210), Station Wagon (S210)

| | | | | |
|-----------------|-----|---------------|---|----------|
| E 280 | 142 | 01/96 → 06/97 | B | M104.945 |
| | 150 | 12/96 → 03/02 | B | M112.921 |
| E 280 4-matic | 150 | 12/96 → 03/02 | B | M112.921 |
| E 280 T | 150 | 12/96 → 03/03 | B | M112.921 |
| E 280 T 4-matic | 150 | 12/96 → 03/03 | B | M112.921 |

81722
350981722000

MERCEDES-BENZ
Classe E II (W210), Station Wagon (S210)

| | | | | | |
|--------------------|-----|---------------|---|-----------------------|--|
| E 320 | 162 | 06/95 → 06/97 | B | M104.992, M104.995 | |
| | 165 | 06/97 → 03/02 | B | M112.941 | |
| E 320 4-matic | 165 | 06/97 → 03/02 | B | M112.941 | |
| E 320 T | 165 | 12/96 → 03/03 | B | M112.941 | |
| E 320 T 4-matic | 165 | 12/96 → 03/03 | B | M112.941 | |

Coupé III (C124)

| | | | | | |
|--------|-----|---------------|---|----------|--|
| 320 CE | 162 | 10/92 → 05/93 | B | M104.992 | |
|--------|-----|---------------|---|----------|--|

Kombi II (S124)

| | | | | | |
|--------|-----|---------------|---|----------|--|
| 280 TE | 145 | 10/92 → 06/93 | B | M104.942 | |
| 320 TE | 162 | 10/92 → 06/93 | B | M104.992 | |

Saloon (W124)

| | | | | | |
|-------|-----|---------------|---|----------|-----------|
| 280 E | 145 | 10/92 → 06/93 | B | M104.942 | 01-1993 → |
| 320 E | 162 | 10/92 → 06/93 | B | M104.992 | |

SL III (R129)

| | | | | | |
|-----|-----|---------------|---|-----------------------|-----------|
| 280 | 142 | 08/93 → 10/01 | B | M104.943 | 09-1994 → |
| | 150 | 05/98 → 10/01 | B | M112.923, M112.925 | |

81723
350981723000

FLANGIA

| | |
|-------------------------|------------|
| Numero Fori Flangia | 4 |
| Dimensione Fori Flangia | M6×1 |
| Posizione Attacco | 106 |
| Diametro Mozzo | M30×1.5 SX |
| Diametro Centraggio | Ø35 |
| Diametro Girante | Ø69 |
| N° Alette Girante | 8 |
| Posizione Girante | 21.5 |

MERCEDES-BENZ
100

| | | | | | |
|---|----|---------------|---|---------------------|--|
| D | 55 | 12/90 → 02/96 | D | OM616, OM616.963 | |
|---|----|---------------|---|---------------------|--|

Classe C I (W202), Station Wagon (S202)

| | | | | | |
|-----------|----|---------------|---|-----------|--|
| C 200 T D | 65 | 10/96 → 03/01 | D | OM604.915 | |
| C 220 D | 55 | 07/96 → 05/00 | D | OM604.910 | |
| | 70 | 08/93 → 05/00 | D | OM604.910 | |

Classe E II (W210), Station Wagon (S210)

| | | | | | |
|---------|----|---------------|---|-----------|--|
| E 200 D | 65 | 01/96 → 03/02 | D | OM604.917 | |
| | 55 | 05/96 → 03/02 | D | OM604.912 | |
| | 70 | 06/95 → 07/99 | D | OM604.912 | |

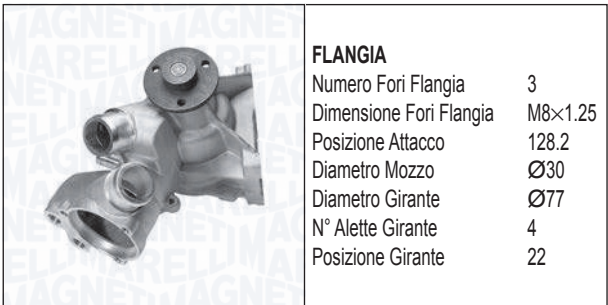
81724
350981724000

FLANGIA

| | |
|-------------------------|---------|
| Numero Fori Flangia | 3 |
| Dimensione Fori Flangia | M8×1.25 |
| Posizione Attacco | 128.2 |
| Diametro Mozzo | Ø30 |
| Diametro Girante | Ø77 |
| N° Alette Girante | 4 |
| Posizione Girante | 22 |

MERCEDES-BENZ
Classe G (W460, W461), Cabrio (W463)

| | | | | | |
|----------|-----|---------------|---|----------------------|-----------|
| 320 GE | 155 | 09/94 → 11/97 | B | M104.996 | 01-1995 → |
| G 320 | 155 | 09/94 → 12/97 | B | M104.996 | 01-1995 → |
| | 158 | 07/97 → | B | M112.945 | |
| G 36 AMG | 200 | 01/95 → | B | M104.996 (AMG3,6) | |

Classe S IV (W140), Coupé (C140)

| | | | | | |
|---------------------|-----|---------------|---|-----------------------|--|
| 300 SE 2.8 | 145 | 01/93 → 10/98 | B | M104.944 | |
| 300 SE,SEL/ S320 | 170 | 03/91 → 10/98 | B | M104.990, M104.994 | |
| S 280 | 142 | 02/93 → 10/98 | B | M104.944 | |

Classe S V (W220), Coupé (C215)

| | | | | | |
|-------|-----|---------------|---|----------|--|
| S 320 | 165 | 10/98 → 08/05 | B | M112.944 | |
|-------|-----|---------------|---|----------|--|

CLK I (C208), Cabrio (A208)

| | | | | | |
|-------------------|-----|---------------|---|----------|--|
| 200 Kompressor | 141 | 03/98 → 06/00 | B | M111.944 | |
|-------------------|-----|---------------|---|----------|--|

SL III (R129)

| | | | | | |
|-----|-----|---------------|---|----------|--|
| 320 | 170 | 09/93 → 10/01 | B | M104.991 | |
|-----|-----|---------------|---|----------|--|

SSANGYONG
Korando II, Cabrio

| | | | | | |
|-----|-----|---------|---|----------|--|
| 3.2 | 156 | 01/99 → | B | M104.995 | |
| | 162 | 06/97 → | B | M104.992 | |
| | 154 | 12/96 → | B | M104.995 | |

Musso

| | | | | | |
|-----|-----|---------|---|----------|--|
| 3.2 | 162 | 06/96 → | B | M104.992 | |
|-----|-----|---------|---|----------|--|

Rexton

| | | | | | |
|-----|-----|---------|---|------|--|
| 3.2 | 162 | 04/02 → | B | G32D | |
|-----|-----|---------|---|------|--|

81725
350981725000

FLANGIA

Numero Fori Flangia 4
 Dimensione Fori Flangia M6×1
 Posizione Attacco 109
 Diametro Mozzo M30×1.5 SX
 Diametro Centraggio Ø35
 Diametro Girante Ø77
 N° Alette Girante 4
 Posizione Girante 15.4

KW

MERCEDES-BENZ
Classe C I (W202), Station Wagon (S202)

C 230 Kompressor 142 10/95 → 05/00 B M111.975

C 230 T Kompressor 142 06/97 → 09/00 B M111.975

Classe E II (W210), Station Wagon (S210)

E 200 Kompressor 137 06/97 → 03/02 B M111.947

E 200 T Kompressor 137 06/97 → 03/03 B M111.947

CLK I (C208), Cabrio (A208)

200 100 03/98 → 03/02 B M111.941, M111.945

200 120 06/00 → 06/02 B M111.956

200 Kompressor 141 06/97 → 06/00 B M111.944

230 142 06/97 → 06/00 B M111.973, M111.975

230 Kompressor 145 06/00 → 06/02 B M111.982

CLK II (C209), Cabrio (A209)

CLK200 CGI 125 07/03 → 03/10 B M271.942

SLK I (R170)

200 Kompressor 141 10/96 → 03/00 B M111.943

230 Kompressor 142 09/96 → 03/00 B M111.973

81726
350981726000

FLANGIA

Numero Fori Flangia 4
 Numero Fori Flangia (Serie 2) 2
 Dimensione Fori Flangia M6×1
 Dimensione Fori Flangia (Serie 2) Ø6
 Posizione Attacco 106
 Diametro Mozzo Ø35
 Diametro Girante Ø70
 N° Alette Girante 10
 Posizione Girante 21.5

KW

MERCEDES-BENZ
Classe C I (W202), Station Wagon (S202)

C 250 Turbo-D 110 10/95 → 05/00 D OM605.960 01-1997 →

Classe E I (W124), Station Wagon (S124), Cabrio (A124), Coupé (C124)

E 250 D 83 07/93 → 06/95 D OM605.911 M →: 033.730

Classe G (W460, W461), Cabrio (W463)

350 G Turbo-D 100 09/91 → 09/97 D OM603.972 01-1997 →, M →: 004.349

G 300 TD 130 09/96 → D OM606.964

Kombi II (S124)

250 T D 66 09/85 → 06/93 D OM602.912 M →: 033.730

Saloon (W124)

300 D 83 08/89 → 06/93 D OM603.912 M →: 054.123

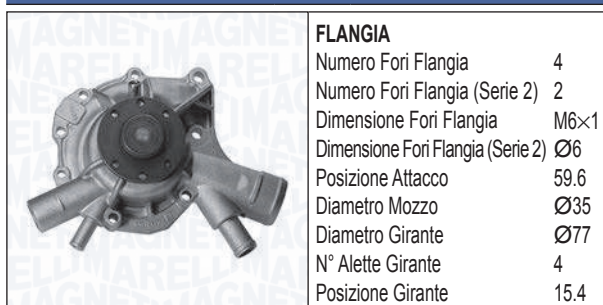
81728
350981728000

FLANGIA

Numero Fori Flangia 4
 Numero Fori Flangia (Serie 2) 2
 Dimensione Fori Flangia M6×1
 Dimensione Fori Flangia (Serie 2) Ø6
 Posizione Attacco 59.6
 Diametro Mozzo Ø35
 Diametro Girante Ø77
 N° Alette Girante 4
 Posizione Girante 15.4

KW

MERCEDES-BENZ
Classe V

V 200 95 02/97 → 07/03 B M111.948, M111.950 → M: 002.353

V 230 105 10/96 → 07/03 B M111.978 → M: 001.594

Vito I (W638)

113 2.0 95 02/96 → 07/03 B M111.948, M111.950 → M: 002.353

114 2.3 105 12/96 → 07/03 B M111.978, M111.980 → M: 001.954

81728 350981728000



MERCEDES-BENZ

Vito I (W638)

| | | | | | |
|---------|-----|---------------|---|-----------------------|--------------|
| 114 2.3 | 105 | 03/97 → 07/03 | B | M111.978, M111.980 | → M: 001.594 |
|---------|-----|---------------|---|-----------------------|--------------|

81729 350981729000



FLANGIA

| | |
|-----------------------------------|------|
| Numero Fori Flangia | 4 |
| Numero Fori Flangia (Serie 2) | 2 |
| Dimensione Fori Flangia | M6×1 |
| Dimensione Fori Flangia (Serie 2) | Ø6 |
| Posizione Attacco | 59.6 |
| Diametro Mozzo | Ø35 |
| Diametro Girante | Ø77 |
| N° Alette Girante | 4 |
| Posizione Girante | 15.4 |



MERCEDES-BENZ

Classe V

| | | | | | |
|-------|----|---------------|---|-----------------------|--------------|
| V 200 | 95 | 02/97 → 07/03 | B | M111.948, M111.950 | M →: 002.354 |
|-------|----|---------------|---|-----------------------|--------------|

| | | | | | |
|-------|-----|---------------|---|----------|--------------|
| V 230 | 105 | 10/96 → 07/03 | B | M111.978 | M →: 001.595 |
|-------|-----|---------------|---|----------|--------------|

Vito I (W638)

| | | | | | |
|---------|----|---------------|---|-----------------------|--------------|
| 113 2.0 | 95 | 02/96 → 07/03 | B | M111.948, M111.950 | M →: 002.354 |
|---------|----|---------------|---|-----------------------|--------------|

| | | | | | |
|---------|-----|---------------|---|-----------------------|--------------|
| 114 2.3 | 105 | 12/96 → 07/03 | B | M111.978, M111.980 | M →: 001.595 |
|---------|-----|---------------|---|-----------------------|--------------|

81730 350981730000



FLANGIA

| | |
|-------------------------|------------|
| Numero Fori Flangia | 4 |
| Dimensione Fori Flangia | M6×1 |
| Posizione Attacco | 83.5 |
| Diametro Mozzo | M30×1.5 SX |
| Diametro Centraggio | Ø35 |
| Diametro Girante | Ø77.7 |
| N° Alette Girante | 6 |
| Posizione Girante | 13.35 |



MERCEDES-BENZ

Classe C I (W202), Station Wagon (S202)

| | | | | | |
|-------|-----|---------------|---|----------|--|
| C 240 | 125 | 06/97 → 05/00 | B | M112.910 | |
|-------|-----|---------------|---|----------|--|

| | | | | | |
|---------|-----|---------------|---|----------|--|
| C 240 T | 125 | 06/97 → 09/00 | B | M112.910 | |
| | 125 | 09/00 → 03/01 | B | M112.915 | |

| | | | | | |
|----------|-----|---------------|---|----------|-----------|
| C 43 AMG | 225 | 08/97 → 05/00 | B | M113.944 | 01-1998 → |
|----------|-----|---------------|---|----------|-----------|

81730 350981730000



MERCEDES-BENZ

Classe C II (W203), Station Wagon (S203), Coupé (CL203)

| | | | | | |
|-------|-----|---------------|---|----------|--|
| C 240 | 125 | 05/00 → 02/07 | B | M112.912 | |
|-------|-----|---------------|---|----------|--|

| | | | | | |
|---------------|-----|---------------|---|----------|--|
| C 240 4-matic | 125 | 07/02 → 02/07 | B | M112.916 | |
| | 160 | 09/02 → 05/08 | B | M112.946 | |

| | | | | | |
|-------|-----|---------------|---|----------|--|
| C 320 | 160 | 05/00 → 02/07 | B | M112.946 | |
| | 160 | 07/02 → 02/07 | B | M112.953 | |

| | | | | | |
|---------------|-----|---------------|---|----------|--|
| C 320 4-matic | 160 | 07/02 → 02/07 | B | M112.953 | |
|---------------|-----|---------------|---|----------|--|

| | | | | | |
|----------|-----|---------------|---|----------|--|
| C 55 AMG | 270 | 02/04 → 02/07 | B | M113.988 | |
|----------|-----|---------------|---|----------|--|

Classe E II (W210), Station Wagon (S210)

| | | | | | |
|-------|-----|---------------|---|----------|--|
| E 240 | 125 | 06/97 → 08/00 | B | M112.911 | |
| | 125 | 08/00 → 03/02 | B | M112.914 | |

| | | | | | |
|---------|-----|---------------|---|----------|--|
| E 240 T | 125 | 06/97 → 03/03 | B | M112.911 | |
| | 125 | 08/00 → 03/03 | B | M112.914 | |

| | | | | | |
|-------|-----|---------------|---|----------|--|
| E 430 | 205 | 06/97 → 03/02 | B | M113.940 | |
|-------|-----|---------------|---|----------|--|

| | | | | | |
|---------------|-----|---------------|---|----------|--|
| E 430 4-matic | 205 | 05/99 → 03/02 | B | M113.940 | |
|---------------|-----|---------------|---|----------|--|

| | | | | | |
|---------|-----|---------------|---|----------|--|
| E 430 T | 205 | 06/97 → 03/03 | B | M113.940 | |
|---------|-----|---------------|---|----------|--|

| | | | | | |
|-----------------|-----|---------------|---|----------|--|
| E 430 T 4-matic | 205 | 05/99 → 03/03 | B | M113.940 | |
|-----------------|-----|---------------|---|----------|--|

| | | | | | |
|----------|-----|---------------|---|----------|--|
| E 55 AMG | 260 | 08/97 → 03/02 | B | M113.980 | |
|----------|-----|---------------|---|----------|--|

| | | | | | |
|------------|-----|---------------|---|----------|-----------|
| E 55 T AMG | 260 | 08/97 → 03/03 | B | M113.980 | 01-1998 → |
|------------|-----|---------------|---|----------|-----------|

Classe E III (W211), Station Wagon (S211)

| | | | | | |
|-------|-----|---------------|---|-----------------------|--------------|
| E 240 | 130 | 03/02 → 12/08 | B | M112.913, M112.917 | → M: 036.808 |
|-------|-----|---------------|---|-----------------------|--------------|

| | | | | | |
|---------------|-----|---------------|---|----------|--|
| E 240 4-matic | 130 | 03/03 → 12/08 | B | M112.917 | |
|---------------|-----|---------------|---|----------|--|

| | | | | | |
|---------|-----|---------------|---|----------|--|
| E 240 T | 130 | 03/03 → 07/09 | B | M112.913 | |
|---------|-----|---------------|---|----------|--|

| | | | | | |
|-----------------|-----|---------------|---|----------|--|
| E 240 T 4-matic | 130 | 07/03 → 07/09 | B | M112.917 | |
|-----------------|-----|---------------|---|----------|--|

| | | | | | |
|-------|-----|---------------|---|----------|--|
| E 320 | 165 | 03/02 → 12/08 | B | M112.949 | |
|-------|-----|---------------|---|----------|--|

| | | | | | |
|---------------|-----|---------------|---|----------|--|
| E 320 4-matic | 165 | 03/03 → 12/08 | B | M112.954 | |
|---------------|-----|---------------|---|----------|--|

| | | | | | |
|---------|-----|---------------|---|----------|--|
| E 320 T | 165 | 03/03 → 07/09 | B | M112.949 | |
|---------|-----|---------------|---|----------|--|

| | | | | | |
|-----------------|-----|---------------|---|----------|--|
| E 320 T 4-matic | 165 | 07/03 → 07/09 | B | M112.954 | |
|-----------------|-----|---------------|---|----------|--|

| | | | | | |
|-------|-----|---------------|---|----------|--|
| E 500 | 225 | 03/02 → 12/08 | B | M113.967 | |
| | 285 | 04/06 → 12/08 | B | M273.960 | |

| | | | | | |
|---------------|-----|---------------|---|----------|--|
| E 500 4-matic | 225 | 10/03 → 12/08 | B | M113.969 | |
| | 285 | 04/06 → 12/08 | B | M273.962 | |

| | | | | | |
|---------|-----|---------------|---|----------|--|
| E 500 T | 225 | 10/03 → 07/09 | B | M113.967 | |
| | 285 | 04/06 → 07/09 | B | M273.960 | |

| | | | | | |
|-----------------|-----|---------------|---|----------|--|
| E 500 T 4-matic | 225 | 10/03 → 07/09 | B | M113.969 | |
| | 285 | 04/06 → 07/09 | B | M273.962 | |

81730 350981730000

MERCEDES-BENZ
Classe G (W460, W461), Cabrio (W463)

| | | | | |
|----------|-----|---------|---|----------|
| G 320 | 158 | 11/97 → | B | M112.945 |
| G 500 | 218 | 04/98 → | B | M113.962 |
| G 55 AMG | 260 | 04/99 → | B | M113.982 |

Classe M I (W163)

| | | | | |
|----------------|-----|---------------|---|------------------------|
| ML 320 | 160 | 02/98 → 08/02 | B | M112.942 |
| ML 350 | 180 | 08/02 → 06/05 | B | M112.970 |
| ML 350 4-matic | 173 | 02/03 → 06/05 | B | M112.970 |
| ML 430 | 200 | 02/98 → 06/05 | B | M113.942 |
| ML 500 | 215 | 09/01 → 06/05 | B | M113.964, M113.965 |
| ML 55 AMG | 255 | 02/00 → 06/05 | B | M113.981 → M: M036.808 |

Classe M II (W164)

| | | | | |
|----------------|-----|---------|---|----------|
| ML 500 4-matic | 225 | 07/05 → | B | M113.964 |
|----------------|-----|---------|---|----------|

Classe S V (W220), Coupé (C215)

| | | | | |
|---------------|-----|---------------|---|-----------------------|
| CL 500 | 225 | 03/99 → 03/06 | B | M113.960 → M: 036.808 |
| CL 55 AMG | 265 | 10/99 → 03/06 | B | M113.986 |
| S 280 | 150 | 10/98 → 08/05 | B | M112.922 |
| S 350 | 180 | 09/02 → 08/05 | B | M112.972 |
| S 350 4-matic | 180 | 06/03 → 08/05 | B | M112.975 |
| S 430 | 205 | 10/98 → 08/05 | B | M113.941 → M: 036.808 |
| S 430 4-matic | 205 | 09/02 → 08/05 | B | M113.948 |
| S 500 4-matic | 225 | 09/02 → 08/05 | B | M113.966 |
| S 55 AMG | 265 | 04/99 → 08/05 | B | M113.986 |

CLK I (C208), Cabrio (A208)

| | | | | |
|--------|-----|---------------|---|--------------------|
| 320 | 160 | 06/97 → 06/02 | B | M112.940 |
| 320 | 160 | 03/98 → 03/02 | B | M112.940 |
| 430 | 205 | 07/98 → 06/02 | B | M113.943 |
| 55 AMG | 255 | 08/99 → 06/02 | B | M113.981, M113.984 |

CLK II (C209), Cabrio (A209)

| | | | | |
|------------|-----|---------------|---|----------|
| 240 | 120 | 06/02 → 05/09 | B | M112.912 |
| | 125 | 06/02 → 05/09 | B | M112.912 |
| 320 | 160 | 06/02 → 05/09 | B | M112.955 |
| 500 | 225 | 06/02 → 05/09 | B | M113.968 |
| 55 AMG | 270 | 09/02 → 05/09 | B | M113.987 |
| CLK 240 | 125 | 02/03 → 03/10 | B | M112.912 |
| CLK 320 | 160 | 02/03 → 03/10 | B | M112.955 |
| CLK 500 | 225 | 02/03 → 03/10 | B | M113.968 |
| CLK 55 AMG | 270 | 02/03 → 03/10 | B | M113.987 |

81730 350981730000

MERCEDES-BENZ
CLK II (C209), Cabrio (A209)

| | | | | |
|-------------|-----|---------------|---|----------|
| CLK AMG DTM | 428 | 06/04 → 03/10 | B | M113.994 |
| DTM AMG | 428 | 06/04 → 05/09 | B | M113.994 |

CLS I (C219)

| | | | | |
|---------|-----|---------------|---|----------|
| CLS 500 | 225 | 10/04 → 12/10 | B | M113.967 |
|---------|-----|---------------|---|----------|

SL III (R129)

| | | | | |
|-----|-----|---------------|---|----------|
| 320 | 165 | 05/98 → 10/01 | B | M112.943 |
|-----|-----|---------------|---|----------|

SL IV (R230)

| | | | | |
|-----|-----|---------------|---|-----------------------|
| 350 | 180 | 03/03 → 01/12 | B | M112.973 |
| 500 | 225 | 10/01 → 01/12 | B | M113.963 → M: 036.808 |

SLK I (R170)

| | | | | |
|-----|-----|---------------|---|----------|
| 320 | 160 | 03/00 → 04/04 | B | M112.947 |
|-----|-----|---------------|---|----------|

Vito II (W639) - Viano

| | | | | |
|-----|-----|---------------|---|--------------------------|
| 119 | 140 | 09/03 → | B | M112.951 |
| 122 | 160 | 09/03 → | B | M112.951 |
| 123 | 170 | 06/04 → | B | M112.976 → M: 31.000.000 |
| | 170 | 06/04 → 07/08 | B | M112.976 → M: 31.000.000 |
| 3,0 | 140 | 09/03 → | B | M112.951 |
| 3.2 | 160 | 09/03 → | B | M112.951 |
| 3.7 | 170 | 06/04 → | B | M112.976 → M: 31.000.000 |

81731 350981731000

| | | |
|--|----------------------------|-------|
| | PULEGGIA | |
| | Diametro Puleggia | Ø59.8 |
| | Numero Denti/Gole Puleggia | 24 |
| | Altezza Puleggia | 32.5 |
| | Posizione Attacco | 65.7 |
| | Diametro Girante | Ø59 |
| | N° Alette Girante | 8 |
| | Posizione Girante | 1 |

MITSUBISHI
Colt IV

| | | | | |
|--------------|-----|---------------|---|--------------------------------|
| 1.6 4WD | 84 | 08/93 → 08/95 | B | 4G92 (SOHC16V) |
| 1.6 GLXi 16V | 83 | 04/92 → 04/96 | B | 4G92 (SOHC16V) |
| 1.8 GTi 16V | 103 | 04/92 → 04/96 | B | 4G93 (DOHC16V), 4G93 (SOHC16V) |

81731
350981731000

MITSUBISHI
Galant V, Station Wagon

| | | | | | |
|----------|----|---------------|---|-------------------|-----------|
| 1.8 | 85 | 02/94 → 08/96 | B | 4G93 (SOHC16V) | |
| 1.8 GLSI | 93 | 11/92 → 08/96 | B | 4G93 (SOHC16V) | 01-1993 → |
| | 93 | 11/92 → 08/96 | B | 4G93 (SOHC16V) | |

Lancer III, Station Wagon

| | | | | | |
|---------|----|---------------|---|------|-----------|
| 1.8 4WD | 69 | 08/90 → 06/92 | B | 4G37 | 01-1992 → |
|---------|----|---------------|---|------|-----------|

Lancer IV, Station Wagon

| | | | | | |
|-------------|-----|---------------|---|---|--|
| 1.6 16V | 83 | 06/92 → 05/94 | B | 4G92 (SOHC16V) | |
| 1.6 4WD | 84 | 06/92 → 11/93 | B | 4G92 (SOHC16V) | |
| 1.8 GTi 16V | 103 | 06/92 → 12/93 | B | 4G93 (DOHC16V), 4G93 (SOHC16V) | |

Lancer V, Station Wagon, Hatchback, Coupé

| | | | | | |
|----------------|-----|---------------|---|-------------------|-----------|
| 1.6 | 66 | 02/94 → 12/96 | B | 4G92 (SOHC16V) | |
| 1.6 16V | 83 | 06/92 → 12/96 | B | 4G92 (SOHC16V) | |
| | 83 | 12/92 → 10/03 | B | 4G92 (SOHC16V) | → 02-1996 |
| 1.6 16V 4WD | 83 | 06/92 → 12/96 | B | 4G92 (SOHC16V) | |
| | 83 | 12/92 → 10/03 | B | 4G92 (SOHC16V) | → 02-1996 |
| 1.8 16V | 103 | 06/92 → 12/93 | B | 4G93 (DOHC16V) | |

Space Runner I

| | | | | | |
|---------|----|---------------|---|-------------------|--|
| 1.8 | 85 | 06/96 → 08/99 | B | 4G93 (SOHC16V) | |
| | 90 | 10/91 → 08/99 | B | 4G93 (SOHC16V) | |
| 1.8 4WD | 85 | 06/96 → 08/99 | B | 4G93 (SOHC16V) | |
| | 90 | 10/91 → 08/99 | B | 4G93 (SOHC16V) | |

Space Wagon II

| | | | | | |
|---------|----|---------------|---|-------------------|--|
| 1.8 | 90 | 10/91 → 10/98 | B | 4G93 (SOHC16V) | |
| 1.8 4WD | 90 | 10/91 → 10/98 | B | 4G93 (SOHC16V) | |

81731
350981731000

PROTON
Persona 400

| | | | | | |
|-------|----|---------|---|------|--|
| 416 i | 70 | 12/95 → | B | 4G92 | |
|-------|----|---------|---|------|--|

81733
350981733000

PULEGGIA

| | |
|----------------------------|--------|
| Diametro Puleggia | Ø59.35 |
| Numero Denti/Gole Puleggia | 20 |
| Altezza Puleggia | 35 |
| Posizione Attacco | 60 |
| Diametro Girante | Ø68.3 |
| N° Alette Girante | 6 |
| Posizione Girante | 12 |

CHRYSLER
Neon I

| | | | | | |
|---------|-----|---------------|---|------|--|
| 1.8 16V | 85 | 09/97 → 08/99 | B | EBD | |
| | 98 | 05/94 → 08/99 | B | 420H | |
| 2.0 16V | 107 | 06/94 → 08/99 | B | ECC | |
| | 109 | 04/96 → 08/99 | B | 420T | |

Neon II

| | | | | | |
|-------------|-----|---------------|---|-----------|--|
| 1.6 | 85 | 11/01 → 12/06 | B | EJD | |
| 2.0 16V | 98 | 08/99 → 12/06 | B | 420H, ECB | |
| 2.0 16V R/T | 110 | 10/01 → 12/06 | B | ECH | |

PT Cruiser, Cabrio

| | | | | | |
|-----|-----|---------------|---|-----|--|
| 1.6 | 85 | 11/01 → 12/10 | B | EJD | |
| | 100 | 10/04 → 12/10 | B | ECC | |
| 2.0 | 104 | 06/00 → 12/10 | B | ECC | |

Sebring II, Cabrio

| | | | | | |
|-----|-----|---------------|---|-----|--|
| 2.0 | 104 | 04/01 → 06/07 | B | ECC | |
|-----|-----|---------------|---|-----|--|

Stratus, Cabrio

| | | | | | |
|---------|----|---------------|---|------|--|
| 2.0 16V | 98 | 12/95 → 04/01 | B | ECB | |
| | 96 | 06/96 → 04/01 | B | 420X | |
| 2.0 LE | 96 | 12/95 → 04/01 | B | C00 | |

Voyager III

| | | | | | |
|-------|----|---------------|---|-----|--|
| 2.0 i | 98 | 01/95 → 03/01 | B | C00 | |
|-------|----|---------------|---|-----|--|

MITSUBISHI
Eclipse II, Cabrio

| | | | | | |
|------------------|-----|---------------|---|--------------------|--|
| 2.0 Turbo | 147 | 04/94 → 04/99 | B | 4G63T (DOHC16V) | |
| 2.0 Turbo 4WD | 157 | 12/95 → 04/99 | B | 4G63T (DOHC16V) | |
| | 147 | 04/94 → 04/99 | B | 4G63T (DOHC16V) | |

81733 350981733000

MITSUBISHI
Eclipse II, Cabrio

| | | | | |
|-------------|-----|---------------|---|-----------------|
| 2000 GS 16V | 107 | 12/95 → 04/99 | B | 4G63 (DOHC16V) |
| 2000 GT 16V | 157 | 12/95 → 04/99 | B | 4G63T (DOHC16V) |

81736 350981736000

NISSAN
Sunny III

| | | | | |
|---------------|-----|---------------|---|---------|
| 2.0 GTI 16V | 105 | 10/90 → 05/95 | B | SR20DE |
| 2.0 GTI-R 4x4 | 162 | 10/90 → 05/95 | B | SR20DET |
| 2.0 i 16V | 105 | 10/90 → 05/95 | B | SR20DE |

81736 350981736000

FLANGIA

| | |
|-------------------------|-------|
| Numero Fori Flangia | 4 |
| Dimensione Fori Flangia | M6×1 |
| Posizione Attacco | 51 |
| Diametro Mozzo | Ø17.3 |
| Diametro Girante | Ø72 |
| N° Alette Girante | 6 |
| Posizione Girante | 17.3 |

NISSAN
100 NX

| | | | | |
|---------|-----|---------------|---|--------|
| 2.0 | 110 | 10/90 → 10/94 | B | SR20DE |
| 2.0 GTI | 105 | 03/91 → 10/94 | B | SR20DE |

200 SX III

| | | | | |
|-----------|-----|---------------|---|--------|
| 2.0 i 16V | 118 | 10/93 → 12/99 | B | SR20DE |
|-----------|-----|---------------|---|--------|

Almera I, Hatchback

| | | | | |
|---------|-----|---------------|---|--------|
| 2.0 D | 55 | 11/95 → 07/00 | D | CD20 |
| 2.0 GTi | 105 | 07/96 → 03/00 | B | SR20DE |

Almera Tino

| | | | | |
|-----|-----|---------|---|--------|
| 2.0 | 100 | 08/00 → | B | SR20DE |
|-----|-----|---------|---|--------|

Primera I, Hatchback, Station Wagon

| | | | | |
|-------------|-----|---------------|---|--------|
| 2.0 | 105 | 06/90 → 04/93 | B | SR20DE |
| | 110 | 06/90 → 01/96 | B | SR20DE |
| 2.0 16V | 85 | 06/90 → 01/96 | B | SR20DI |
| 2.0 16V 4x4 | 85 | 04/91 → 06/96 | B | SR20DI |
| 2.0 GT | 110 | 06/90 → 01/96 | B | SR20DE |
| 2.0 GT 4x4 | 105 | 03/91 → 04/93 | B | SR20DE |
| 2.0 i | 85 | 07/90 → 03/98 | B | SR20DI |
| | 92 | 01/95 → 06/96 | B | SR20DE |

Primera II, Hatchback, Station Wagon

| | | | | |
|---------|-----|---------------|---|--------|
| 2.0 16V | 85 | 09/96 → 12/01 | B | SR20De |
| | 96 | 09/96 → 12/01 | B | SR20DE |
| | 103 | 08/99 → 12/01 | B | SR20DE |
| | 110 | 09/96 → 12/01 | B | SR20DE |

Serena I

| | | | | |
|---------|----|---------------|---|--------|
| 2.0 16V | 93 | 11/92 → 09/01 | B | SR20DE |
|---------|----|---------------|---|--------|

81742 350981742000

FLANGIA

| | |
|-------------------------|-------|
| Numero Fori Flangia | 3 |
| Dimensione Fori Flangia | M6×1 |
| Posizione Attacco | 51 |
| Diametro Mozzo | Ø17.2 |
| Diametro Girante | Ø57 |
| N° Alette Girante | 8 |
| Posizione Girante | 19.5 |

NISSAN
Micra II (K11)

| | | | | |
|-----------|----|---------------|---|--------|
| 1.0 i 16V | 40 | 08/92 → 09/00 | B | CG10DE |
| | 44 | 09/00 → 02/03 | B | CG10DE |
| 1.3 i 16V | 55 | 08/92 → 09/00 | B | CG13DE |
| 1.4 i 16V | 60 | 09/00 → 02/03 | B | CGA3DE |

81743 350981743000

PULEGGIA

| | |
|----------------------------|-------|
| Diametro Puleggia | Ø57.4 |
| Numero Denti/Gole Puleggia | 23 |
| Posizione Attacco | 35 |
| Diametro Girante | Ø57 |
| N° Alette Girante | 8 |
| Posizione Girante | 12.7 |

NISSAN
Micra I (K10)

| | | | | | |
|-----|----|---------------|---|-------|----------------------------|
| 1.0 | 43 | 12/82 → 05/91 | B | | 01-1989 →, M →: 945.693 |
| | 40 | 07/86 → 07/92 | B | MA12S | 01-1989 →, M →: 945.693 |
| 1.2 | 44 | 07/86 → 07/92 | B | MA12S | 01-1989 →, M →: 945.693 |

81744

350981744000

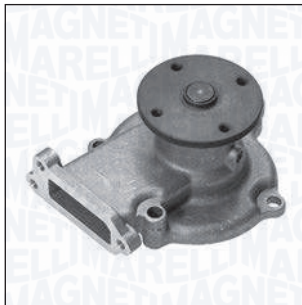

FLANGIA

| | |
|-------------------------|--------|
| Numero Fori Flangia | 4 |
| Dimensione Fori Flangia | M6x1 |
| Posizione Attacco | 60.5 |
| Diametro Mozzo | Ø17.25 |
| Diametro Girante | Ø58 |
| N° Alette Girante | 6 |
| Posizione Girante | 10.5 |



KW



NISSAN

100 NX

| | | | | |
|--------|----|---------------|---|--------|
| 1.6 | 66 | 03/90 → 10/94 | B | GA16DS |
| 1.6 SR | 75 | 09/93 → 10/94 | B | GA16DE |

Almera I, Hatchback

| | | | | |
|-------------|----|---------------|---|--------|
| 1.4 | 64 | 09/95 → 07/00 | B | GA14DE |
| 1.4 GX,LX | 55 | 09/95 → 07/00 | B | GA14DE |
| 1.4 S,GX,LX | 55 | 09/95 → 03/00 | B | GA14DE |
| 1.6 | 73 | 09/95 → 07/00 | B | GA16DE |
| 1.6 SLX | 66 | 09/95 → 07/00 | B | GA16DE |
| 1.6 SR,SLX | 66 | 09/95 → 03/00 | B | GA16DE |

Primera I, Hatchback, Station Wagon

| | | | | |
|-------|----|---------------|---|--------|
| 1.6 | 66 | 06/90 → 01/96 | B | GA16DS |
| | 71 | 06/90 → 01/96 | B | GA16DS |
| | 75 | 06/93 → 01/96 | B | GA16DE |
| 1.6 i | 66 | 07/90 → 03/98 | B | GA16DS |
| | 75 | 02/91 → 03/98 | B | GA16DE |

Primera II, Hatchback, Station Wagon

| | | | | |
|---------|----|---------------|---|--------|
| 1.6 16V | 66 | 09/96 → 12/01 | B | GA16DE |
| | 73 | 09/96 → 10/00 | B | GA16DE |
| | 78 | 06/96 → 12/01 | B | QG16DE |
| | 80 | 04/98 → 12/01 | B | QG16DE |

Serena I

| | | | | |
|---------|----|---------------|---|--------|
| 1.6 | 75 | 10/94 → 08/00 | B | GA16DE |
| 1.6 16V | 71 | 02/93 → 09/01 | B | GA16DE |

Sunny III

| | | | | |
|-------------|----|---------------|---|-------------------------------|
| 1.4 | 60 | 10/90 → 06/95 | B | GA14DS |
| 1.4 i | 55 | 10/90 → 05/95 | B | GA14DE, GA14DS |
| 1.4 i 16V | 64 | 10/90 → 06/95 | B | GA14DE |
| 1.6 16V 4x4 | 66 | 11/90 → 05/95 | B | GA16DS |
| 1.6 i | 66 | 10/90 → 05/95 | B | GA16DE, GA16DEL, GA16DS |
| | 66 | 06/91 → 03/00 | B | GA16DE, GA16DS |
| 1.6 i 16V | 66 | 10/92 → 03/00 | B | GA16DE |
| | 75 | 10/92 → 05/95 | B | GA16DE |

81744

350981744000



KW



NISSAN

Sunny III

| | | | | |
|------------|----|---------------|---|---------|
| 1.6 i 16V | 66 | 10/90 → 05/95 | B | GA16DS |
| 4WD | 75 | 10/92 → 05/95 | B | GA16DE |
| 1.6 L | 75 | 11/92 → 04/96 | B | GA16DE |
| 1.6 SR 4x4 | 66 | 01/92 → 06/95 | B | GA16DEL |

Vanette III Cargo

| | | | | |
|-------|----|---------|---|--------|
| 1.6 i | 71 | 01/95 → | B | GA16DE |
| | 72 | 01/96 → | B | GA16DE |

81745

350981745000



FLANGIA

| | |
|-------------------------|------|
| Numero Fori Flangia | 4 |
| Dimensione Fori Flangia | M6x1 |
| Posizione Attacco | 84.6 |
| Diametro Girante | Ø70 |
| N° Alette Girante | 8 |
| Posizione Girante | 0.5 |



KW



NISSAN

Almera I, Hatchback

| | | | | |
|-------|----|---------------|---|------|
| 2.0 D | 55 | 11/95 → 03/00 | D | CD20 |
|-------|----|---------------|---|------|

Primera I, Hatchback, Station Wagon

| | | | | |
|-------|----|---------------|---|------|
| 2.0 D | 55 | 01/91 → 01/96 | D | CD20 |
|-------|----|---------------|---|------|

Primera II, Hatchback, Station Wagon

| | | | | |
|--------|----|---------------|---|-------|
| 2.0 TD | 66 | 09/96 → 12/01 | D | CD20T |
|--------|----|---------------|---|-------|

Sunny III

| | | | | |
|-------|----|---------------|---|------|
| 2.0 D | 55 | 10/90 → 05/95 | D | CD20 |
|-------|----|---------------|---|------|

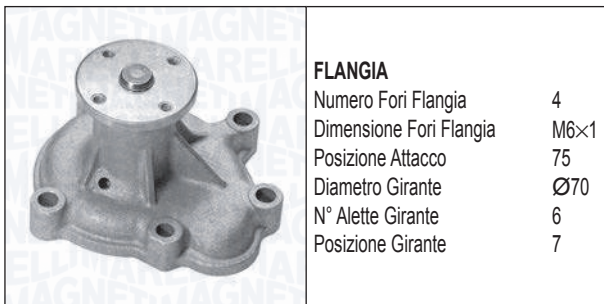
81746
350981746000

FLANGIA

| | |
|-------------------------|------|
| Numero Fori Flangia | 4 |
| Dimensione Fori Flangia | M6×1 |
| Posizione Attacco | 75 |
| Diametro Girante | Ø70 |
| N° Alette Girante | 6 |
| Posizione Girante | 7 |

KW

OPEL
Astra F, Station Wagon, Cabrio, Van

| | | | | | |
|---------|----|---------------|---|-------------------------------|-------------------------|
| 1.7 TDS | 60 | 03/92 → 09/98 | D | 17DT (TC4EE1), X17DT (TC4EE1) | 01-1993 →, M →: 855.806 |
|---------|----|---------------|---|-------------------------------|-------------------------|

Astra G, Station Wagon, Coupé, Cabrio, Van

| | | | | | |
|-------------|----|---------------|---|-------|------------------------|
| 1.7 DTI 16V | 55 | 02/00 → 01/05 | D | Y17DT | → 09-2000, → M: 073532 |
| | 55 | 02/00 → 07/04 | D | Y17DT | → 08-2000, → M: 073532 |

Combo A

| | | | | | |
|-------|----|---------------|---|-------------------------|--------------|
| 1.7 D | 44 | 07/94 → 10/01 | D | 17D (4EE1), X17D (4EE1) | M →: 877.698 |
|-------|----|---------------|---|-------------------------|--------------|

Corsa B, Station Wagon, Van

| | | | | | |
|-------|----|---------------|---|-------------------------|--------------|
| 1.7 D | 44 | 02/96 → 09/00 | D | 17D (4EE1), X17D (4EE1) | M →: 877.698 |
| | 44 | 08/99 → 09/00 | D | 17D (4EE1), X17D (4EE1) | |
| | 44 | 01/99 → | D | X17D (4EE1) | |

Vectra B, Station Wagon

| | | | | | |
|--------|----|---------------|---|----------------|--|
| 1.7 TD | 60 | 10/95 → 12/98 | D | X17DT (TC4EE1) | |
|--------|----|---------------|---|----------------|--|

81747
350981747000

FLANGIA

| | |
|-------------------------|---------|
| Numero Fori Flangia | 3 |
| Dimensione Fori Flangia | M8×1.25 |
| Posizione Attacco | 33 |
| Diametro Mozzo | Ø30 |
| Diametro Girante | Ø70 |
| N° Alette Girante | 8 |
| Posizione Girante | 52.3 |

KW

OPEL
Astra G, Station Wagon, Coupé, Cabrio, Van

| | | | | | |
|-------------|----|---------------|---|----------------|--|
| 2.0 DI | 60 | 01/99 → 04/05 | D | X20DTL | |
| | 60 | 02/98 → 01/05 | D | X20DTL, Y20DTL | |
| 2.0 DTI 16V | 74 | 08/99 → 01/05 | D | X20DTH, Y20DTH | |
| 2.2 DTI | 86 | 09/02 → 01/05 | D | Y22DTR | |
| | 92 | 09/02 → 01/05 | D | Y22DTR | |

Frontera B

| | | | | | |
|---------|----|---------------|---|----------------|--|
| 2.2 DTI | 88 | 09/02 → | D | Y22DTH | |
| | 85 | 10/98 → 09/02 | D | X22DTH, Y22DTH | |

Omega B, Station Wagon

| | | | | | |
|-------------|----|---------------|---|--------|--|
| 2.0 DTI 16V | 74 | 09/97 → 09/00 | D | X20DTH | |
| | 81 | 09/00 → 07/03 | D | Y22DTH | |
| | 88 | 09/00 → 07/03 | D | Y22DTH | |

Signum

| | | | | | |
|---------|----|---------|---|--------|--|
| 2.0 DTI | 74 | 05/03 → | D | Y20DTH | |
| 2.2 DTI | 92 | 05/03 → | D | Y22DTR | |

Sintra

| | | | | | |
|---------|----|---------------|---|--------|--|
| 2.2 DTI | 85 | 07/97 → 04/99 | D | X22DTH | |
|---------|----|---------------|---|--------|--|

Vectra B, Station Wagon

| | | | | | |
|-------------|----|---------------|---|----------------|--|
| 2.0 DI 16V | 60 | 11/96 → 04/02 | D | X20DTL | |
| 2.0 DTI 16V | 74 | 06/97 → 04/02 | D | X20DTH, Y20DTH | |
| | 88 | 09/00 → 04/02 | D | Y22DTR | |
| | 92 | 09/00 → 04/02 | D | Y22DTR | |

Vectra C, Station Wagon

| | | | | | |
|-------------|----|---------------|---|--------|--|
| 2.0 DTI | 74 | 10/03 → | D | Y20DTH | |
| 2.0 DTI 16V | 74 | 04/02 → | D | Y20DTH | |
| 2.2 DTI | 92 | 10/03 → | D | Y22DTR | |
| 2.2 DTI 16V | 86 | 04/02 → 12/04 | D | Y22DTR | |
| | 92 | 04/02 → | D | Y22DTR | |

81747
350981747000

OPEL
Zafira A

| | | | | |
|-------------|----|---------------|---|--------|
| 2.0 DI | 63 | 07/99 → 06/00 | D | X20DTL |
| 2.0 DI 16V | 60 | 07/99 → 06/05 | D | X20DTL |
| 2.0 DTI 16V | 74 | 09/00 → 06/05 | D | Y20DTH |
| | 86 | 01/02 → 06/05 | D | Y22DTR |
| | 92 | 01/02 → 06/05 | D | Y22DTR |

SAAB
9-3 I, Cabrio

| | | | | |
|---------|----|---------------|---|------------------|
| 2.2 TiD | 85 | 02/98 → 11/00 | D | D223L, X22DTH |
| | 92 | 11/00 → 09/02 | D | D223L |

9-3 II, Station Wagon, Cabrio

| | | | | |
|---------|----|---------|---|-------|
| 2.2 TiD | 92 | 09/02 → | D | D223L |
|---------|----|---------|---|-------|

9-5 I, Station Wagon

| | | | | |
|---------|----|---------------|---|-------|
| 2.2 TiD | 88 | 03/02 → 12/09 | D | D223L |
|---------|----|---------------|---|-------|

VAUXHALL
ZAFIRA

| | | | | |
|---------------|-----|---------------|---|--------|
| 2.0 GSi Turbo | 141 | 09/01 → 06/05 | B | Z20LET |
|---------------|-----|---------------|---|--------|

81748
350981748000

FLANGIA

| | |
|-------------------------|-------|
| Numero Fori Flangia | 4 |
| Dimensione Fori Flangia | M6×1 |
| Posizione Attacco | 75 |
| Diametro Girante | Ø64.5 |
| N° Alette Girante | 6 |
| Posizione Girante | 5.8 |

OPEL
Corsa B, Station Wagon, Van

| | | | | | |
|--------|----|---------------|---|--------------------------------------|---|
| 1.5 D | 37 | 03/93 → 09/00 | D | 15D (4EC1) | 09-1994 →, M →: 877.698 |
| 1.5 TD | 49 | 03/93 → 09/00 | D | 15DT (T4EC1), X15DT (T4EC1) | → 08-1994, M →: 877.698, → M: 076.350 |

VAUXHALL
CORSA

| | | | | | |
|--------|----|---------------|---|--------------------------------------|----------------------------|
| 1.5 D | 37 | 12/92 → 12/96 | D | 15D | M →: 877.698 |
| 1.5 TD | 49 | 03/93 → 10/96 | D | 15DT (T4EC1), X15DT (T4EC1) | 03-1993 →, M →: 877.698 |

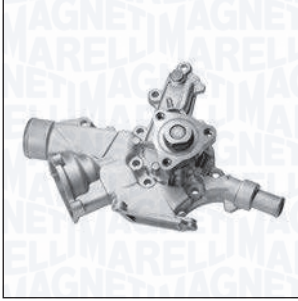
81749
350981749000

FLANGIA

| | |
|-------------------------|---------|
| Numero Fori Flangia | 3 |
| Dimensione Fori Flangia | M8×1.25 |
| Posizione Attacco | 55.6 |
| Diametro Mozzo | Ø29.9 |
| Diametro Girante | Ø50 |
| N° Alette Girante | 8 |
| Posizione Girante | 21.45 |

OPEL
Agila A

| | | | | |
|---------|----|---------------|---|-------|
| 1.0 12V | 43 | 09/00 → 12/07 | B | Z10XE |
| 1.2 16V | 55 | 09/00 → 12/07 | B | Z12XE |

Astra G, Station Wagon, Coupé, Cabrio, Van

| | | | | |
|---------|----|---------------|---|-------|
| 1.2 16V | 48 | 02/98 → 09/00 | B | X12XE |
| | 55 | 09/00 → 01/05 | B | Z12XE |

Corsa B, Station Wagon, Van

| | | | | |
|-----------|----|---------------|---|-------|
| 1.0 i 12V | 40 | 11/96 → 09/00 | B | X10XE |
| 1.2 i 16V | 48 | 03/98 → 09/00 | B | X12XE |

Corsa C, Van

| | | | | |
|---------|----|---------------|---|-------|
| 1.0 | 43 | 09/00 → 06/03 | B | Z10XE |
| 1.2 | 55 | 09/00 → 12/09 | B | Z12XE |
| 1.2 16V | 55 | 09/00 → | B | Z12XE |

VAUXHALL
CORSA

| | | | | |
|-----------|----|---------------|---|-------|
| 1.0 12V | 43 | 09/00 → 10/03 | B | Z10XE |
| 1.0 i 12V | 40 | 11/96 → 09/00 | B | X10XE |

81750
350981750000

FLANGIA

| | |
|-------------------------|-------|
| Numero Fori Flangia | 4 |
| Dimensione Fori Flangia | M6×1 |
| Posizione Attacco | 75 |
| Diametro Girante | Ø64.5 |
| N° Alette Girante | 6 |
| Posizione Girante | 6.5 |

OPEL
Corsa B, Station Wagon, Van

| | | | | | |
|--------|----|---------------|---|--------------------------------------|----------------------------|
| 1.5 TD | 49 | 03/93 → 09/00 | D | 15DT (T4EC1), X15DT (T4EC1) | 09-1994 →, M →: 076.351 |
|--------|----|---------------|---|--------------------------------------|----------------------------|

81751
350981751000

KW

OPEL
Astra G, Station Wagon, Coupé, Cabrio, Van

| | | | | | |
|---------|----|---------------|---|--------|--|
| 1.8 16V | 85 | 02/98 → 09/00 | B | X18XE1 | |
| | 92 | 09/00 → 01/05 | B | Z18XE | |

Corsa C, Van

| | | | | | |
|-----|----|---------------|---|-------|--|
| 1.8 | 92 | 09/00 → 12/09 | B | Z18XE | |
|-----|----|---------------|---|-------|--|

Meriva A

| | | | | | |
|-----|----|---------------|---|-------|--|
| 1.8 | 92 | 05/03 → 05/10 | B | Z18XE | |
|-----|----|---------------|---|-------|--|

Signum

| | | | | | |
|-----|----|---------|---|-------|--|
| 1.8 | 90 | 05/03 → | B | Z18XE | |
|-----|----|---------|---|-------|--|

Tigra II Twin Top

| | | | | | |
|-----|----|---------|---|-------|--|
| 1.8 | 92 | 06/04 → | B | Z18XE | |
|-----|----|---------|---|-------|--|

Vectra B, Station Wagon

| | | | | | |
|-----------|----|---------------|---|----------------|----------------------|
| 1.8 i 16V | 85 | 10/95 → 09/00 | B | X18XE1, Z18XEL | 01-1999 →, M: X18XE1 |
| | 92 | 09/00 → 04/02 | B | Z18XE | |

Vectra C, Station Wagon

| | | | | | |
|---------|----|---------------|---|--------|--|
| 1.8 | 81 | 04/02 → | B | Z18XEL | |
| | 90 | 10/03 → | B | Z18XE | |
| 1.8 16V | 81 | 08/02 → 12/06 | B | Z18XEL | |
| | 90 | 04/02 → | B | Z18XE | |

Zafira A

| | | | | | |
|---------|----|---------------|---|--------|--|
| 1.8 16V | 85 | 04/99 → 09/00 | B | X18XE1 | |
| | 92 | 09/00 → 06/05 | B | Z18XE | |

SAAB
9-3 II, Station Wagon, Cabrio

| | | | | | |
|-------|----|---------|---|-------|--|
| 1.8 i | 90 | 01/04 → | B | Z18XE | |
|-------|----|---------|---|-------|--|

VAUXHALL
VECTRA

| | | | | | |
|---------|----|---------------|---|-------|--|
| 1.8 16V | 90 | 04/02 → 07/08 | B | Z18XE | |
|---------|----|---------------|---|-------|--|

81752
350981752000

KW

CITROËN
Jumper I

| | | | | | |
|--------|----|---------------|---|------------|-----------|
| 2.5 D | 63 | 08/94 → 04/02 | D | T9A (DJ5) | → 04-1996 |
| 2.5 TD | 76 | 08/94 → 04/02 | D | T8A (DJ5T) | → 04-1996 |

XM II, Break

| | | | | | |
|--------|----|---------------|---|--------------|--------------|
| 2.5 TD | 95 | 05/94 → 10/00 | D | THY (DK5ATE) | → PROD: 7143 |
|--------|----|---------------|---|--------------|--------------|

PEUGEOT
605

| | | | | | |
|------------------|----|---------------|---|--------------|-------------------------|
| 2.5 Turbo Diesel | 95 | 07/94 → 09/99 | D | THY (DK5ATE) | → 03-1995, → PROD: 7143 |
|------------------|----|---------------|---|--------------|-------------------------|

Boxer I

| | | | | | |
|--------|----|---------------|---|------------|-------------------------|
| 2.5 D | 63 | 08/94 → 04/02 | D | T9A (DJ5) | → 05-1996, → PROD: 7143 |
| 2.5 TD | 76 | 07/94 → 04/02 | D | T8A (DJ5T) | → 05-1996, → PROD: 7143 |

81753
350981753000

KW

CITROËN
Berlingo I, Van

| | | | | | |
|---------|----|---------|---|--------------|--|
| 1.6 16V | 80 | 10/00 → | B | NFU (TU5JP4) | |
| | 81 | 11/02 → | B | NFU (TU5JP4) | |

81753
350981753000

CITROËN
Berlingo II, Van

| | | | | |
|-------------|----|---------|---|---------------|
| 1.6 | 66 | 04/08 → | B | NFR (TU5JP4B) |
| | 80 | 04/08 → | B | NFU (TU5JP4) |
| 1.6 VTi 120 | 88 | 11/09 → | B | 5FS (EP6C) |

C 2, Van

| | | | | |
|---------|----|---------|---|---------------|
| 1.6 | 80 | 09/03 → | B | NFU (TU5JP4) |
| 1.6 VTS | 90 | 01/05 → | B | NFS (TU5JP4S) |

C 3 I, Pluriel

| | | | | |
|---------|----|---------------|---|--------------|
| 1.6 | 80 | 05/03 → | B | NFU (TU5JP4) |
| 1.6 16V | 80 | 02/02 → | B | NFU (TU5JP4) |
| | 81 | 05/03 → 09/05 | B | NFU (TU5JP4) |

C 4 I, Coupé, Picasso, Grand Picasso

| | | | | |
|------------------|----|---------------|---|--------------|
| 1.6 16V | 80 | 11/04 → 07/11 | B | NFU (TU5JP4) |
| 1.6 16V Bio-Flex | 80 | 09/07 → 07/08 | | NFU (TU5JP4) |

C-Elysee

| | | | | |
|-------------|----|---------|---|-----------|
| 1.6 VTi 115 | 85 | 11/12 → | B | NFP (EC5) |
|-------------|----|---------|---|-----------|

Saxo

| | | | | |
|---------|----|---------------|---|--------------|
| 1.5 D | 43 | 07/01 → 04/04 | D | |
| 1.6 | 88 | 02/96 → 04/04 | B | NFX (TU5JP4) |
| 1.6 VTS | 87 | 06/96 → 09/03 | B | NFX (TU5JP4) |

Xsara, Break, Coupé, Picasso, Van

| | | | | |
|---------|----|---------------|---|--------------|
| 1.6 16V | 80 | 09/00 → 03/05 | B | NFU (TU5JP4) |
| | 80 | 09/00 → 03/05 | B | NFU (TU5JP4) |
| | 81 | 06/05 → 09/06 | B | NFU (TU5JP4) |

PEUGEOT
106 II

| | | | | |
|---------|----|---------|---|-------------|
| 1.6 S16 | 87 | 05/96 → | B | NFX (TU5J4) |
|---------|----|---------|---|-------------|

205 II, Van

| | | | | |
|---------|----|---------|---|--------------|
| 1.6 16V | 80 | 12/00 → | B | NFU (TU5JP4) |
|---------|----|---------|---|--------------|

81753
350981753000

PEUGEOT
206, CC, Van

| | | | | |
|---------|----|---------|---|--------------|
| 1.6 16V | 80 | 07/02 → | B | NFU (TU5JP4) |
| | 80 | 09/00 → | B | NFU (TU5JP4) |

207, Station Wagon, CC, Van

| | | | | |
|-------------|----|---------|---|--------------|
| 1.6 | 81 | 08/08 → | B | N6A (TU5JP4) |
| 1.6 16V | 80 | 02/06 → | B | NFU (TU5JP4) |
| 1.6 Bioflex | 83 | 01/08 → | | N6A (TU5JP4) |

301

| | | | | |
|-------------|----|---------|---|-----------|
| 1.6 VTi 115 | 85 | 11/12 → | B | NFP (EC5) |
|-------------|----|---------|---|-----------|

307, Station Wagon, CC

| | | | | |
|-------------|----|---------|---|--------------|
| 1.6 | 81 | 07/06 → | B | NFU (TU5JP4) |
| 1.6 16V | 80 | 08/00 → | B | NFU (TU5JP4) |
| 1.6 BioFlex | 80 | 09/07 → | | NFU (TU5JP4) |

308 I, Station Wagon, CC

| | | | | |
|-------------|----|---------|--|--------------|
| 1.6 BioFlex | 80 | 04/08 → | | NFU (TU5JP4) |
|-------------|----|---------|--|--------------|

308 II Station Wagon

| | | | | |
|---------|----|---------|---|--|
| 1.6 VTi | 85 | 03/14 → | B | |
|---------|----|---------|---|--|

1007

| | | | | |
|---------|----|---------|---|--------------|
| 1.6 16V | 80 | 04/05 → | B | NFU (TU5JP4) |
|---------|----|---------|---|--------------|

Partner I

| | | | | |
|---------|----|---------------|---|--------------|
| 1.6 | 80 | 09/00 → 10/02 | B | NFU (TU5JP4) |
| 1.6 16V | 80 | 07/01 → | B | NFU (TU5JP4) |

Partner II, Tepee

| | | | | |
|-----|----|---------|---|---------------|
| 1.6 | 66 | 04/08 → | B | NFR (TU5JP4B) |
| | 80 | 04/08 → | B | NFU (TU5JP4) |
| | 72 | 08/10 → | B | 5FK (EP6CB) |
| | 88 | 04/10 → | B | 5FS (EP6C) |

81754
350981754000

FLANGIA

| | |
|-------------------------|---------|
| Numero Fori Flangia | 3 |
| Dimensione Fori Flangia | M8×1.25 |
| Posizione Attacco | 74 |
| Diametro Centraggio | Ø51 |
| Diametro Girante | Ø69 |
| N° Alette Girante | 9 |
| Posizione Girante | 14.3 |

KW

RENAULT
21, Station Wagon

| | | | | | |
|------------------|-----|---------------|---|--------|----------------|
| 2.0 Turbo | 119 | 02/90 → 10/92 | B | J7R756 | M →: F.209.863 |
| | 129 | 04/87 → 03/90 | B | J7R752 | M →: F.209.863 |
| 2.0 Turbo 4x4 | 129 | 08/89 → 10/93 | B | J7R752 | M →: F.209.863 |
| | 119 | 02/90 → 10/92 | B | J7R756 | M →: F.209.863 |

25

| | | | | | |
|-----|----|---------------|---|--|----------------|
| 2.0 | 74 | 04/84 → 12/92 | B | J6R706, J6R707, J6R760, J6R762, J6R763 | M →: F.308.132 |
|-----|----|---------------|---|--|----------------|

Master I

| | | | | | |
|-----------|----|---------------|---|--------|----------------|
| 28-35 2.0 | 58 | 10/86 → 07/98 | B | J5R718 | M →: F.029.329 |
| | 58 | 10/86 → 07/98 | B | J5R728 | M →: F.029.329 |

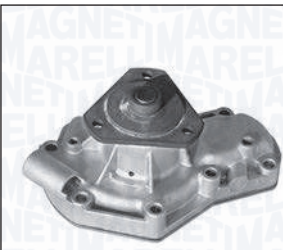
81755
350981755000

FLANGIA

| | |
|-------------------------|------------|
| Numero Fori Flangia | 3 |
| Dimensione Fori Flangia | M8×1.25 |
| Posizione Attacco | 63 |
| Diametro Mozzo | M24×1.5 SX |
| Diametro Centraggio | Ø54 |
| Diametro Girante | Ø69 |
| N° Alette Girante | 9 |
| Posizione Girante | 17 |

KW

RENAULT
25

| | | | | | |
|--------------------|----|---------------|---|-------------------|----------------|
| 2.1 Turbo-D FWD | 63 | 04/84 → 12/92 | D | J8S708, J8S738 | M →: F.397.290 |
|--------------------|----|---------------|---|-------------------|----------------|

81756
350981756000

PULEGGIA

| | |
|----------------------------|--------|
| Diametro Puleggia | Ø147.2 |
| Numero Denti/Gole Puleggia | 6 |
| Posizione Attacco | 40 |
| Diametro Girante | Ø67 |
| N° Alette Girante | 8 |
| Posizione Girante | 18 |

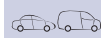
KW

RENAULT
Rapid

| | | | | | |
|-----|----|---------------|---|--|---------------|
| 1.0 | 27 | 02/86 → 05/92 | B | C1C706 | (-)COP, (+)AC |
| 1.1 | 33 | 07/85 → 04/95 | B | C1E750, C1E752, C1E754, C1E756, C1E760, C1E762, C1E792 | (-)COP, (+)AC |
| | | | | C3G710, C3G712 | (-)COP, (+)AC |
| 1.2 | 40 | 09/91 → 03/98 | B | C1J768, C1J780, C3J700, C3J702, C3J760, C3J762 | (-)COP, (+)AC |
| | | | | C2J784 | (-)COP, (+)AC |
| 1.4 | 43 | 07/85 → 03/98 | B | C1E750, C1E752, C1E754 | (-)COP, (+)AC |
| | | | | C2J784 | (-)COP, (+)AC |

Super 5

| | | | | | |
|--------------|-----|---------------|---|--|---------------|
| 1.1 | 33 | 01/86 → 03/95 | B | C1E750, C1E752, C1E756, C1E760 | (-)COP, (+)AC |
| | | | | C1E750, C1E752, C1E754 | (-)COP, (+)AC |
| 1.2 | 40 | 01/87 → 08/90 | B | C1G702, C1G720, C1G722 | (-)COP, (+)AC |
| | | | | C1G702 | (-)COP, (+)AC |
| 1.4 | 43 | 10/84 → 12/96 | B | C1J768, C1J780, C3J700, C3J702, C3J760 | (-)COP, (+)AC |
| | | | | C2J784 | (-)COP, (+)AC |
| 1.4 Turbo | 88 | 04/85 → 08/90 | B | C1J782, C1J784, C1J788 | (-)COP, (+)AC |
| 1.4 Turbo GT | 118 | 01/85 → 05/91 | B | 840730 | (-)COP, (+)AC |

81757

350981757000



| | |
|-------------------------|---------|
| FLANGIA | |
| Numero Fori Flangia | 3 |
| Dimensione Fori Flangia | M8x1.25 |
| Posizione Attacco | 71.6 |
| Diametro Centraggio | Ø51 |
| Diametro Girante | Ø68 |
| N° Alette Girante | 8 |
| Posizione Girante | 18.6 |



RENAULT

Safrane I

| | | | | | |
|--------|----|---------------|---|--------|---------------------|
| 2.1 dT | 65 | 11/93 → 07/96 | D | J8S760 | → M: 920.501, (-)AC |
|--------|----|---------------|---|--------|---------------------|

81758

350981758000



| | |
|-------------------------|---------|
| FLANGIA | |
| Numero Fori Flangia | 3 |
| Dimensione Fori Flangia | M8x1.25 |
| Posizione Attacco | 73.3 |
| Diametro Centraggio | Ø51 |
| Diametro Girante | Ø68 |
| N° Alette Girante | 8 |
| Posizione Girante | 17.3 |



RENAULT

Safrane I

| | | | | | |
|--------|----|---------------|---|--------|----------------------------|
| 2.1 dT | 65 | 11/93 → 07/96 | D | J8S760 | M →: 920.502, (+)AC, (-)AC |
|--------|----|---------------|---|--------|----------------------------|

81759

350981759000

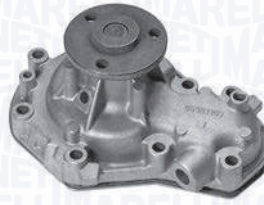

| | |
|-------------------------|---------|
| FLANGIA | |
| Numero Fori Flangia | 3 |
| Dimensione Fori Flangia | M8x1.25 |
| Posizione Attacco | 74.5 |
| Diametro Mozzo | Ø30 |
| Diametro Girante | Ø68 |
| N° Alette Girante | 8 |
| Posizione Girante | 18.6 |



RENAULT

Safrane I

| | | | | | |
|---------|-----|---------------|---|----------------|--|
| 2.0 | 77 | 11/92 → 07/96 | B | J7R732, J7R733 | |
| 2.0 12V | 97 | 04/92 → 07/96 | B | J7R734, J7R735 | |
| 2.2 | 79 | 04/92 → 07/96 | B | J7T762 | |
| | 101 | 04/92 → 07/96 | B | J7T760, J7T761 | |

Safrane II

| | | | | | |
|---------|-----|---------------|---|----------------|--|
| 2.0 16V | 100 | 07/96 → 12/00 | B | N7Q710, N7Q711 | |
|---------|-----|---------------|---|----------------|--|

81760

350981760000



| | |
|-------------------------|---------|
| FLANGIA | |
| Numero Fori Flangia | 3 |
| Dimensione Fori Flangia | M8x1.25 |
| Posizione Attacco | 98.9 |
| Diametro Centraggio | Ø51 |
| Diametro Girante | Ø60 |
| N° Alette Girante | 8 |
| Posizione Girante | 20.5 |



RENAULT

Laguna I, Grantour

| | | | | | |
|-------|----|---------------|---|--------------------------------|--|
| 2.2 D | 61 | 11/93 → 03/01 | D | G8T706, G8T752, G8T790, G8T794 | |
|-------|----|---------------|---|--------------------------------|--|

81761
350981761000

| | | | |
|-------------------|----------------------------|------|--------|
| | PULEGGIA | | |
| | Diametro Puleggia | | Ø56.24 |
| | Numero Denti/Gole Puleggia | | 19 |
| | Altezza Puleggia | | 36 |
| | Posizione Attacco | | 50.2 |
| | Diametro Girante | | Ø70 |
| | N° Alette Girante | | 6 |
| Posizione Girante | | 22.3 | |

KW

RENAULT
Espace III

| | | | | |
|------------|----|---------------|---|------------------------------|
| 2.2 12V TD | 83 | 11/96 → 10/00 | D | G8T714, G8T716, G8T760 |
| 2.2 D | 84 | 11/97 → 01/00 | D | G8T716 |

Laguna I, Grandtour

| | | | | |
|--------|----|---------------|---|--------|
| 2.2 dT | 83 | 03/96 → 03/01 | D | G8T760 |
|--------|----|---------------|---|--------|

Safrane II

| | | | | |
|--------|----|---------------|---|--------|
| 2.2 dT | 83 | 07/96 → 12/00 | D | G8T740 |
|--------|----|---------------|---|--------|

81762
350981762000

| | | | |
|--|-------------------|--|-------|
| | PULEGGIA | | |
| | Diametro Puleggia | | Ø56.2 |
| | Altezza Puleggia | | 26 |
| | Posizione Attacco | | 52.6 |
| | Diametro Girante | | Ø60 |
| | N° Alette Girante | | 6 |
| | Posizione Girante | | 5 |

KW

NISSAN
Kubistar

| | | | | |
|-----|----|---------------|---|--------|
| 1.2 | 44 | 08/03 → 10/09 | B | D7F764 |
|-----|----|---------------|---|--------|

RENAULT
Clio I

| | | | | |
|-----|----|---------------|---|--------|
| 1.2 | 40 | 01/96 → 09/98 | B | D7F730 |
| | 43 | 01/96 → 09/98 | B | D7F730 |

Clio II

| | | | | |
|-----|----|---------|---|------------------------------|
| 1.1 | 43 | 09/98 → | B | D7F720, D7F726, D7F746 |
|-----|----|---------|---|------------------------------|

81762
350981762000

KW

RENAULT
Clio II

| | | | | |
|-----|----|---------------|---|--|
| 1.2 | 55 | 06/01 → | B | |
| | 43 | 09/98 → | B | D7F720, D7F726, D7F746, D7F764, D7F766 → 12-2003 |
| | 44 | 03/99 → 05/01 | B | D7F722 |
| | 44 | 03/99 → 10/03 | B | D7F722, D7F726, D7F746 |

Clio III, Grandtour

| | | | | |
|---------|----|---------|---|--------|
| 1.2 16V | 76 | 09/10 → | B | D4F786 |
|---------|----|---------|---|--------|

| | | | | |
|-------------|----|---------|--|--|
| 1.2 Ethanol | 55 | 07/08 → | | |
|-------------|----|---------|--|--|

Clio IV, Grandtour

| | | | | |
|---------|----|---------|---|-------------------|
| 1.2 16V | 54 | 11/12 → | B | D4F728, D4F740 |
| | 54 | 01/13 → | B | D4F740 |

Kangoo I, Van

| | | | | |
|------------|----|---------------|----|---|
| 1.2 | 43 | 08/97 → | B | D7F710, D7F720, D7F722, D7F726, D7F744, D7F746 |
| | 44 | 07/98 → 07/01 | B | D7F764, D7F766 |
| 1.2 BiFuel | 43 | 07/98 → 07/01 | BF | D7F710, D7F744 |

Twingo I

| | | | | |
|-----|----|---------------|---|---|
| 1.2 | 44 | 09/98 → 08/00 | B | D7F702, D7F703, D7F704 |
| | 40 | 05/96 → | B | D7F700, D7F701 |
| | 43 | 05/96 → | B | D7F700, D7F701, D7F702, D7F703, D7F704 |
| 1.2 | 43 | 05/96 → | B | D7F700, D7F701, D7F702, D7F703, D7F704, D7F706 |
| | 44 | 10/03 → | | D7F702, D7F708 |

81764

350981764000



PULEGGIA

| | |
|-------------------|--------|
| Diametro Puleggia | Ø131.8 |
| Altezza Puleggia | 25 |
| Posizione Attacco | 104.9 |
| Diametro Girante | Ø70 |
| N° Alette Girante | 8 |
| Posizione Girante | 6.9 |



RENAULT

Safrane I

| | | | | |
|-----------------|-----|---------------|---|---|
| 3.0 Biturbo 4x4 | 193 | 02/93 → 07/96 | B | Z7X726 |
| 3.0 V6 | 123 | 12/92 → 07/96 | B | Z7X721, Z7X722, Z7X723, Z7X753 |
| 3.0 V6 4x4 | 123 | 12/92 → 07/96 | B | Z7X721, Z7X722, Z7X723 |

SAAB

9-3 I, Cabrio

| | | | | |
|--------------|-----|---------------|---|---------------------------|
| 2.0 i | 96 | 02/98 → 09/02 | B | B204I |
| 2.0 SE Turbo | 147 | 02/98 → 09/02 | B | B204R |
| 2.0 Turbo | 110 | 01/01 → 09/02 | B | B205E |
| | 113 | 10/98 → 09/02 | B | B204E |
| | 136 | 02/98 → 09/02 | B | B204L, B205E, B205L |
| 2.3 | 169 | 09/99 → 01/02 | B | B235R |
| 2.3 i | 110 | 02/98 → 09/02 | B | B234I |
| 2.3 Turbo | 165 | 10/98 → 09/02 | B | B235R |

9-5 I, Station Wagon

| | | | | |
|----------------|-----|---------------|---|-------|
| 2.0 t | 110 | 09/97 → 12/09 | B | B205E |
| | 136 | 07/00 → 12/09 | B | B205L |
| | 141 | 10/98 → 12/09 | B | B204R |
| 2.0 t Biopower | 132 | 09/05 → 12/09 | | B205E |
| 2.0 Turbo SE | 141 | 10/98 → 07/00 | B | B205E |
| 2.3 t | 125 | 09/97 → 12/09 | B | B235E |
| | 136 | 01/01 → 12/09 | B | B235E |

81764

350981764000



SAAB

9-5 I, Station Wagon

| | | | | |
|-----------|-----|---------------|---|-------|
| 2.3 Turbo | 162 | 07/03 → 12/09 | B | B235L |
| | 169 | 10/99 → 09/01 | B | B235R |
| | 184 | 09/01 → 12/09 | B | B235R |
| | 191 | 11/05 → 12/09 | B | B235R |
| | 224 | 06/03 → 08/05 | B | B235R |

900 II, Cabrio, Coupé

| | | | | |
|---------------|-----|---------------|---|-------|
| 2.0 -16 Turbo | 136 | 07/93 → 02/98 | B | B204L |
| 2.0 i | 96 | 08/94 → 02/98 | B | B204I |
| | 98 | 07/93 → 07/94 | B | B206I |
| 2.3 -16 | 110 | 07/93 → 02/98 | B | B234I |

81766

350981766000



FLANGIA

| | |
|-------------------------|------|
| Numero Fori Flangia | 4 |
| Dimensione Fori Flangia | M6x1 |
| Posizione Attacco | 76.5 |
| Diametro Mozzo | Ø28 |
| Diametro Girante | Ø58 |
| N° Alette Girante | 7 |
| Posizione Girante | 10 |



TOYOTA

Carina E (T19), Station Wagon

| | | | | | |
|---------|----|---------------|---|-------|----------------------|
| 1.6 | 73 | 12/93 → 09/97 | B | 4A-FE | (+)COP, → 12-1994 |
| | 79 | 01/93 → 09/97 | B | 4A-FE | (+)COP, → 12-1994 |
| | 85 | 12/93 → 09/97 | B | 4A-FE | (+)COP, → 12-1994 |
| 1.6 GLI | 79 | 04/92 → 09/97 | B | 4A-FE | (+)COP, → 12-1994 |

Celica V

| | | | | | |
|---------|----|---------------|---|-------|--------|
| 1.6 STI | 77 | 10/89 → 11/93 | B | 4A-FE | (+)COP |
|---------|----|---------------|---|-------|--------|

Corolla V, Liftback, Station Wagon, Compact

| | | | | | |
|---------|----|---------------|---|-------|--------|
| 1.6 GLI | 84 | 07/92 → 04/97 | B | 4A-FE | (+)COP |
| 1.6 Si | 84 | 09/95 → 04/97 | B | 4A-FE | (+)COP |

Corolla VI, Liftback, Station Wagon, Compact

| | | | | | |
|----------|----|---------------|---|-------|--------|
| 1.6 Aut. | 81 | 04/97 → 02/00 | B | 4A-FE | (+)COP |
| | 79 | 04/97 → 02/00 | B | 4A-FE | (+)COP |
| | 79 | 04/97 → 02/00 | B | 4A-FE | (+)COP |

81767 350981767000

| | |
|-------------------------|------|
| FLANGIA | |
| Numero Fori Flangia | 4 |
| Dimensione Fori Flangia | M6x1 |
| Posizione Attacco | 76.5 |
| Diametro Mozzo | Ø28 |
| Diametro Girante | Ø60 |
| N° Alette Girante | 6 |
| Posizione Girante | 8 |

TOYOTA
Avensis I, Liftback, Station Wagon

| | | | | | |
|-----|----|---------------|---|-------|--------|
| 1.6 | 74 | 09/97 → 10/00 | B | 4A-FE | (+)COP |
| | 81 | 09/97 → 10/00 | B | 4A-FE | (+)COP |

Carina E (T19), Station Wagon

| | | | | | |
|---------|----|---------------|---|-------|-------------------|
| 1.6 | 73 | 12/93 → 09/97 | B | 4A-FE | (+)COP, 01-1995 → |
| | 73 | 01/95 → 09/97 | B | 4A-FE | (+)COP |
| | 78 | 10/95 → 09/97 | B | 4A-FE | (+)COP |
| | 79 | 01/93 → 09/97 | B | 4A-FE | (+)COP, 01-1995 → |
| 1.6 16V | 78 | 10/95 → 09/97 | B | 4A-FE | (+)COP |
| | 85 | 12/94 → 09/97 | B | 4A-FE | (+)COP |
| 1.6 GLI | 79 | 04/92 → 09/97 | B | 4A-FE | (+)COP, 01-1995 → |
| 1.6 i | 73 | 02/95 → 09/97 | B | 4A-FE | (+)COP |

81768 350981768000

| | |
|-------------------------|------|
| FLANGIA | |
| Numero Fori Flangia | 4 |
| Dimensione Fori Flangia | M6x1 |
| Posizione Attacco | 76.5 |
| Diametro Mozzo | Ø28 |
| Diametro Girante | Ø60 |
| N° Alette Girante | 6 |
| Posizione Girante | 8 |

TOYOTA
Avensis I, Liftback, Station Wagon

| | | | | | |
|-----|----|---------------|---|-------|------------------|
| 1.8 | 81 | 09/97 → 10/00 | B | 7A-FE | (+)COP, OEM: SEM |
|-----|----|---------------|---|-------|------------------|

81768 350981768000

TOYOTA
Carina E (T19), Station Wagon

| | | | | | |
|-----------|----|---------------|---|-------|------------------------------|
| 1.8 | 85 | 04/92 → 09/97 | B | 7A-FE | (+)COP, 01-1995 →, → 12-1995 |
| | 79 | 01/95 → 09/97 | B | 7A-FE | (+)COP, → 12-1995 |
| 1.8 GL | 92 | 10/94 → 09/97 | B | 7A-FE | (+)COP, → 12-1995 |
| 1.8 i | 79 | 02/95 → 09/97 | B | 7A-FE | (+)COP |
| 1.8 i 16V | 79 | 01/95 → 09/97 | B | 7A-FE | (+)COP, → 12-1995 |

81769 350981769000

| | |
|-------------------------|------|
| FLANGIA | |
| Numero Fori Flangia | 4 |
| Dimensione Fori Flangia | M6x1 |
| Posizione Attacco | 76.5 |
| Diametro Mozzo | Ø28 |
| Diametro Girante | Ø58 |
| N° Alette Girante | 7 |
| Posizione Girante | 10 |

TOYOTA
Avensis I, Liftback, Station Wagon

| | | | | | |
|-----|----|---------------|---|-------|--------------------|
| 1.8 | 81 | 09/97 → 10/00 | B | 7A-FE | (+)COP, OEM: AISIN |
|-----|----|---------------|---|-------|--------------------|

Carina E (T19), Station Wagon

| | | | | | |
|-----------|----|---------------|---|-------|-------------------|
| 1.8 | 85 | 04/92 → 09/97 | B | 7A-FE | (+)COP, 01-1996 → |
| | 79 | 01/95 → 09/97 | B | 7A-FE | (+)COP, 01-1996 → |
| 1.8 GL | 92 | 10/94 → 09/97 | B | 7A-FE | (+)COP, 01-1996 → |
| 1.8 i 16V | 79 | 01/95 → 09/97 | B | 7A-FE | (+)COP, 01-1996 → |

Celica VI

| | | | | | |
|-----------|----|---------------|---|-------|--------|
| 1.8 i 16V | 85 | 11/93 → 11/99 | B | 7A-FE | (+)COP |
|-----------|----|---------------|---|-------|--------|

Corolla V, Liftback, Station Wagon, Compact

| | | | | | |
|-------------|----|---------------|---|-------|--------|
| 1.8 16V 4WD | 81 | 09/95 → 04/97 | B | 7A-FE | (+)COP |
| 1.8 GT | 86 | 11/92 → 05/95 | B | 7A-FE | (+)COP |

Corolla VI, Liftback, Station Wagon, Compact

| | | | | | |
|---------|----|---------------|---|-------|--------|
| 1.8 | 81 | 10/97 → 10/01 | B | 7A-FE | (+)COP |
| 1.8 4WD | 81 | 04/97 → 10/01 | B | 7A-FE | (+)COP |

81770

350981770000



PULEGGIA
 Diametro Puleggia Ø56.8
 Numero Denti/Gole Puleggia 23
 Altezza Puleggia 29
 Posizione Attacco 48
 Diametro Girante Ø67
 N° Alette Girante 8
 Posizione Girante 17



TOYOTA

Avensis I, Liftback, Station Wagon

| | | | | | |
|-----|----|---------------|---|-------|----------------------|
| 2.0 | 94 | 09/97 → 10/00 | B | 3S-FE | (-)COP, 01-1997 → |
|-----|----|---------------|---|-------|----------------------|

Camry I, Liftback, Station Wagon

| | | | | | |
|-------------|----|---------------|---|-------|--------|
| 2.0 | 94 | 11/86 → 05/91 | B | 3S-FE | (-)COP |
| 2.0 Gli 16V | 89 | 11/86 → 05/91 | B | 3S-FE | (-)COP |

Camry II, Liftback, Station Wagon

| | | | | | |
|-----|-----|---------------|---|-------|--------|
| 2.2 | 100 | 06/91 → 08/96 | B | 5S-FE | (-)COP |
|-----|-----|---------------|---|-------|--------|

Camry III, Station Wagon

| | | | | | |
|-----|----|---------------|---|-------|----------------------|
| 2.2 | 93 | 11/00 → 11/01 | B | 5S-FE | (-)COP |
| | 96 | 08/96 → 11/01 | B | 5S-FE | (-)COP, 01-1993 → |

Carina E (T19), Station Wagon

| | | | | | |
|-------------|-----|---------------|---|-------|----------------------|
| 1.8 | 85 | 04/92 → 09/97 | B | 7A-FE | (-)COP, → 12-1994 |
| 2.0 | 98 | 01/93 → 09/97 | B | 3S-FE | (-)COP |
| 2.0 GLI | 98 | 04/92 → 09/97 | B | 3S-FE | (-)COP |
| 2.0 GTi | 116 | 04/92 → 02/94 | B | 3S-GE | (-)COP |
| 2.0 GTi 16V | 129 | 03/94 → 09/97 | B | 3S-GE | (-)COP |
| 2.0 i | 93 | 12/93 → 09/97 | B | 3S-FE | (-)COP |

Picnic I

| | | | | | |
|---------|----|---------------|---|-------|--------|
| 2.0 | 90 | 01/01 → 12/01 | B | 3S-FE | (-)COP |
| 2.0 16V | 94 | 05/96 → 12/01 | B | 3S-FE | (-)COP |

RAV 4 I

| | | | | | |
|-------------|----|---------------|---|-------|--------|
| 2.0 16V 4WD | 94 | 12/97 → 06/00 | B | 3S-FE | (-)COP |
| 2.0 4WD | 95 | 06/94 → 06/00 | B | 3S-FE | (-)COP |

81771

350981771000



PULEGGIA
 Diametro Puleggia Ø102
 Numero Denti/Gole Puleggia 4
 Posizione Attacco 70.6
 Diametro Girante Ø55
 N° Alette Girante 7
 Posizione Girante 16.3



TOYOTA

Carina E (T19), Station Wagon

| | | | | | |
|--------|----|---------------|---|-------|--------|
| 1.5 SG | 77 | 04/92 → 09/97 | B | 5A-FE | (-)COP |
|--------|----|---------------|---|-------|--------|

Corolla V, Liftback, Station Wagon, Compact

| | | | | | |
|-------------|----|---------------|---|-------|--------|
| 1.3 XLI | 55 | 09/95 → 04/97 | B | 4E-FE | (-)COP |
| | 65 | 07/92 → 04/97 | B | 4E-FE | (-)COP |
| 1.3 XLI 16V | 65 | 07/92 → 09/95 | B | 4E-FE | (-)COP |

Corolla VI, Liftback, Station Wagon, Compact

| | | | | | |
|-----|----|---------------|---|-------|--------|
| 1.3 | 55 | 05/97 → 10/01 | B | 2E | (-)COP |
| 1.4 | 63 | 04/97 → 02/00 | B | 4E-FE | (-)COP |

Paseo II

| | | | | | |
|---------|----|---------------|---|-------|--------|
| 1.5 | 66 | 10/96 → 01/98 | B | 5E-FE | (-)COP |
| 1.5 16V | 66 | 08/95 → 07/99 | B | 5E-FE | (-)COP |

Starlet IV

| | | | | | |
|-----|----|---------------|---|-------|--------|
| 1.3 | 55 | 04/96 → 03/99 | B | 4E-FE | (-)COP |
|-----|----|---------------|---|-------|--------|

81772

350981772000



PULEGGIA
 Diametro Puleggia Ø53.05
 Numero Denti/Gole Puleggia 18
 Altezza Puleggia 28
 Posizione Attacco 60.4
 Diametro Girante Ø72
 N° Alette Girante 7
 Posizione Girante 33



VOLKSWAGEN

Transporter IV

| | | | | | |
|-------|----|---------------|---|-----|---|
| 2.4 D | 57 | 07/90 → 04/98 | D | AAB | 09-1990 →, → 07-1995, T →: F70-N.014.000 |
| | 57 | 09/90 → 04/98 | D | AAB | → 07-1995, → T: F70-N-014.000 |

81772 350981772000

VOLKSWAGEN
Transporter IV

| | | | | | |
|--------------|----|---------------|---|-----------------------|---|
| 2.4 D Syncro | 57 | 10/92 → 09/98 | D | AAB | 09-1990 →, → 07-1995, T →: F70.N.014.000 |
| 2.5 | 81 | 11/90 → 04/03 | B | AAF, ACU, AEN, AEU | → T: F70.N.014.000 |
| 2.5 Syncro | 81 | 11/92 → 04/03 | B | AAF, ACU, AEN, AEU | → T: F70.N.014.000 |

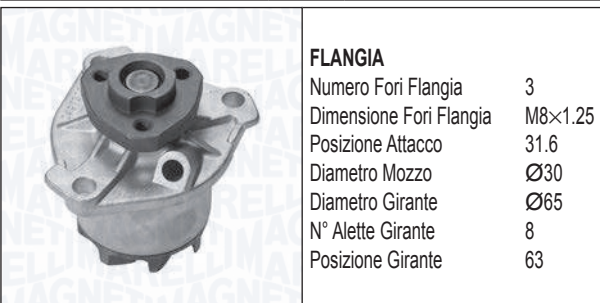
81773 350981773000

FLANGIA

| | |
|-------------------------|---------|
| Numero Fori Flangia | 3 |
| Dimensione Fori Flangia | M8×1.25 |
| Posizione Attacco | 31.6 |
| Diametro Mozzo | Ø30 |
| Diametro Girante | Ø65 |
| N° Alette Girante | 8 |
| Posizione Girante | 63 |

FORD
Galaxy I

| | | | | |
|--------------|-----|---------------|---|----------|
| 2.8 i V6 | 128 | 11/95 → 04/00 | B | AAA, AMY |
| 2.8 i V6 4x4 | 128 | 04/96 → 04/00 | B | AAA, AMY |
| 2.8 V6 | 150 | 04/00 → 05/06 | B | AYL |

MERCEDES-BENZ
Classe V

| | | | | |
|-------|-----|---------------|---|----------|
| V 280 | 128 | 08/97 → 07/03 | B | M104.900 |
|-------|-----|---------------|---|----------|

SEAT
Leon I

| | | | | | |
|-------------|-----|---------------|---|-----|-----------|
| 2.8 Cupra 4 | 150 | 02/01 → 06/06 | B | AUE | → 09-2001 |
|-------------|-----|---------------|---|-----|-----------|

VOLKSWAGEN
Bora, Station Wagon

| | | | | | |
|-------------------|-----|---------------|---|------------------|----------------|
| 2.8 V6 4motion | 150 | 03/99 → 05/05 | B | AQP, AUE, BDE | M: AUE, M: AQP |
|-------------------|-----|---------------|---|------------------|----------------|

Corrado

| | | | | |
|---------|-----|---------------|---|-----|
| 2.9 VR6 | 140 | 08/91 → 12/95 | B | ABV |
|---------|-----|---------------|---|-----|

Golf III, Variant, Cabrio

| | | | | | |
|---------|-----|---------------|---|-----|-----------|
| 2.8 VR6 | 128 | 01/92 → 08/97 | B | AAA | |
| 2.9 VR6 | 140 | 10/94 → 04/99 | B | ABV | 01-1993 → |
| Syncro | 140 | 10/94 → 08/97 | B | ABV | 01-1993 → |

Golf IV, Variant, Cabrio

| | | | | |
|-------------------|-----|---------------|---|------------------|
| 2.8 V6 4motion | 150 | 03/99 → 06/05 | B | AQP, AUE, BDE |
|-------------------|-----|---------------|---|------------------|

81773 350981773000

VOLKSWAGEN
Passat III, Variant

| | | | | | |
|-------------------|-----|---------------|---|-----|--|
| 2.8 VR6 | 128 | 06/91 → 08/96 | B | AAA | |
| 2.9 VR6 Syncro | 135 | 01/94 → 05/97 | B | ABV | |

Sharan I

| | | | | | |
|-----------------------|-----|---------------|---|----------|--------------|
| 2.8 V6 24V | 150 | 04/00 → 03/10 | B | AYL | → T: 035.000 |
| 2.8 V6 24V 4motion | 150 | 04/00 → 03/10 | B | AYL | → T: 035.000 |
| 2.8 VR6 | 128 | 09/95 → 04/00 | B | AAA, AMY | 09-1995 → |
| 2.8 VR6 Syncro | 128 | 11/96 → 04/00 | B | AAA, AMY | 09-1995 → |

Transporter IV

| | | | | | |
|-------------------|-----|---------------|---|-----|--|
| 2.8 | 103 | 05/96 → 05/00 | B | AES | |
| 2.8 VR 6 | 103 | 11/95 → 04/00 | B | AES | |
| 2.8 VR6 | 150 | 04/00 → 04/03 | B | AMV | |
| 2.8 VR6 Syncro | 103 | 01/96 → 04/96 | B | AES | |

Vento

| | | | | | |
|---------|-----|---------------|---|-----|--|
| 2.8 VR6 | 120 | 08/95 → 04/96 | B | AAA | |
| 2.8 VR6 | 128 | 01/92 → 09/98 | B | AAA | |

81774 350981774000

FLANGIA

| | |
|-------------------------|------------|
| Numero Fori Flangia | 4 |
| Dimensione Fori Flangia | M6×1 |
| Posizione Attacco | 80 |
| Diametro Mozzo | M30×1.5 SX |
| Diametro Centraggio | Ø35 |
| Diametro Girante | Ø76 |
| N° Alette Girante | 4 |
| Posizione Girante | 15.4 |

MERCEDES-BENZ
Sprinter I (901, 902, 903, 904)

| | | | | | |
|-----------|-----|---------------|---|-----------------------|-----------|
| 208 D | 58 | 02/95 → 04/00 | D | OM601.943 | 01-1996 → |
| | 60 | 10/96 → 04/00 | D | OM601.943 | 01-1996 → |
| 214 | 105 | 02/95 → 05/06 | B | M111.979, M111.984 | 01-1996 → |
| 214 NGT | 92 | 04/00 → 05/06 | | M111.984 | |
| 308 D | 58 | 02/95 → 04/00 | D | OM601.943 | 01-1996 → |
| 308 D 2.3 | 58 | 02/95 → 04/00 | D | OM601.943 | 01-1996 → |
| | 60 | 11/96 → 04/00 | D | OM601.943 | 01-1996 → |
| 314 | 105 | 02/95 → 05/06 | B | M111.979, M111.984 | 01-1996 → |
| | 105 | 02/95 → 05/06 | B | M111.984 | 01-1996 → |

81774 350981774000



MERCEDES-BENZ

Sprinter I (901, 902, 903, 904)

| | | | | | |
|---------|-----|---------------|---|--------------------|-----------|
| 314 4x4 | 105 | 08/02 → 05/06 | B | M111.984 | |
| 314 NGT | 92 | 04/00 → 05/06 | | M111.984 | |
| | 92 | 04/00 → 05/06 | | | |
| 408 D | 58 | 02/96 → 05/06 | D | OM601.943 | 01-1996 → |
| 414 | 105 | 02/96 → 05/06 | B | M111.979, M111.984 | 01-1996 → |
| | 105 | 02/96 → 05/06 | B | M111.979, M111.984 | |
| 414 4x4 | 105 | 05/97 → 05/06 | B | M111.979, M111.984 | 01-1996 → |

VOLKSWAGEN

LT II 28-35, 28-46

| | | | | | |
|-----|-----|---------------|---|-----|--|
| 2.3 | 105 | 05/96 → 07/06 | B | AGL | |
|-----|-----|---------------|---|-----|--|

81775 350981775000



PULEGGIA

Diametro Puleggia Ø67.3

Numero Denti/Gole Puleggia 27

Altezza Puleggia 20.7

Posizione Attacco 50.8

Diametro Girante Ø63.6

N° Alette Girante 8

Posizione Girante 41



SEAT

Arosa

| | | | | | |
|-----|----|---------------|---|------------------------------|--|
| 1.0 | 37 | 05/97 → 06/04 | B | AER, ALD, ALL, ANV, AUC | M: ALD, M: AER, M: ALL, M: ALD, M: AUC, M: AER |
| 1.4 | 44 | 05/97 → 06/04 | B | AEX, AKK, AKV, ANW, APQ, AUD | 12-1999 → , M: AUD, M: ANW, M: AUD |

Cordoba I, Vario

| | | | | | |
|-------|----|---------------|---|-----|--|
| 1.0 i | 37 | 09/96 → 06/99 | B | AER | |
|-------|----|---------------|---|-----|--|

Cordoba II, Vario

| | | | | | |
|-----|----|---------------|---|---------------|--|
| 1.0 | 37 | 06/99 → 10/02 | B | ALD, ANV, AUC | |
| 1.4 | 44 | 06/99 → 10/02 | B | AKK, ANW, AUD | |

Ibiza II

| | | | | | |
|-------|----|---------------|---|-----|--|
| 1.0 i | 37 | 09/96 → 08/99 | B | AER | |
|-------|----|---------------|---|-----|--|

81775 350981775000



SEAT

Ibiza III

| | | | | | |
|-----|----|---------------|---|---------------|--|
| 1.0 | 37 | 08/99 → 02/02 | B | ALD, ANV, AUC | |
| 1.4 | 44 | 08/99 → 02/02 | B | AKK, ANW, AUD | |

VOLKSWAGEN

Lupo I

| | | | | | |
|-----|----|---------------|---|-------------------------|--|
| 1.0 | 37 | 09/98 → 07/05 | B | AER, ALD, ALL, ANV, AUC | M: ALD, M: AUD, M: AUC, M: ALD, M: AER, M: AUC, M: ALL, M: AER, M: AUD, M: AUC, M: ANV, M: ALL, M: ALD, M: AER |
| 1.4 | 44 | 10/00 → 07/05 | B | AUD | |

Polo III (6N1), Classic, Variant, Van

| | | | | | |
|--------|----|---------------|---|------------------------------|--------------------------------|
| 1.4 | 40 | 12/98 → 09/01 | B | AKP | |
| | 44 | 05/97 → 09/01 | B | AEX, AKK, AKV, ANW, APQ, AUD | M: AKK, M: AUD, M: ANW, M: AKK |
| 50 1.0 | 37 | 09/96 → 10/99 | B | AER, ALL | |
| 60 1.4 | 44 | 12/95 → 09/01 | B | AEX, AKK, AKV, ANW, APQ, AUD | M: AUD, M: AKK, M: ANW, M: AUD |

Polo IV (6N2)

| | | | | | |
|-----|----|---------------|---|----------|--|
| 1.0 | 37 | 10/99 → 09/01 | B | ALD, AUC | |
| 1.4 | 40 | 10/99 → 09/01 | B | AKP, ANX | |
| | 44 | 10/99 → 09/01 | B | AKK, AUD | |

81776 350981776000



PULEGGIA

Diametro Puleggia Ø67.3

Numero Denti/Gole Puleggia 27

Altezza Puleggia 27

Posizione Attacco 56.8

Diametro Girante Ø63.6

N° Alette Girante 8

Posizione Girante 40.5



SEAT

Cordoba I, Vario

| | | | | | |
|-----------|----|---------------|---|-----|--|
| 1.4 i 16V | 74 | 09/96 → 06/99 | B | AFH | |
|-----------|----|---------------|---|-----|--|

Ibiza III

| | | | | | |
|---------|----|---------------|---|----------|--|
| 1.0 16V | 51 | 10/99 → 02/02 | B | AST, AVZ | |
|---------|----|---------------|---|----------|--|

81776 350981776000

VOLKSWAGEN
Polo III (6N1), Classic, Variant, Van

100 1.4 16V 74 04/96 → 10/99 B AFH

81777 350981777000

PULEGGIA

| | |
|----------------------------|-------|
| Diametro Puleggia | Ø67.3 |
| Numero Denti/Gole Puleggia | 27 |
| Altezza Puleggia | 21 |
| Posizione Attacco | 55.4 |
| Diametro Girante | Ø63.6 |
| N° Alette Girante | 8 |
| Posizione Girante | 41 |

AUDI
A2

1.4 55 02/00 → 08/05 B AUA, BBY

SEAT
Altea, Altea XL

1.4 16V 63 05/06 → B BXW, CGGB

Arosa

1.4 16V 74 01/00 → 06/04 B AFK, AQQ, AUB

Cordoba II, Vario

1.4 16V 55 05/00 → 10/02 B APE, AUA

74 02/00 → 10/02 B AQQ, AUB

Cordoba III, Vario

1.4 16V 55 09/02 → 12/07 B BBY, BKY

63 05/06 → 11/09 B BXW

74 10/02 → 11/09 B AUB, BBZ

Ibiza III

1.4 16V 55 05/00 → 02/02 B APE, AUA

74 08/99 → 02/02 B AQQ, AUB

Ibiza IV

1.4 16V 55 02/02 → 12/07 B BBY, BKY

63 05/06 → 11/09 B BXW

74 02/02 → 11/09 B AUB, BBZ

Ibiza V

1.4 63 03/08 → B BXW, CGGB

63 03/10 → B CGGB

1.6 77 05/08 → B BTS T →: 6J9002801

77 02/12 → B BTS

1.6 LPG 60 05/11 → CNKA

81777 350981777000

SEAT
Inca

1.4 16V 55 04/00 → 06/03 B AUA

Leon I

1.4 16V 55 11/99 → 06/06 B AHW, APE, AUA, AXP, BCA

Leon II

1.4 16V 63 06/06 → 12/12 B BXW, CGGB

Toledo II

1.4 16V 55 01/00 → 05/02 B AHW, APE, AUA, AXP, BCA

SKODA
Fabia I, Station Wagon, Van

1.4 16V 55 12/99 → 03/08 B AUA, BBY, BKY

59 04/06 → 12/07 B BUD

74 12/99 → 03/08 B AUB, BBZ

74 04/00 → 12/07 B AUB, BBZ

Fabia II, Station Wagon, Van

1.4 63 01/07 → 12/14 B BXW, CGGB

Octavia I, Station Wagon

1.4 16V 55 09/00 → 12/10 B AXP, BCA

Octavia II, Station Wagon

1.4 55 05/04 → 05/06 B BCA

59 06/04 → 04/13 B BUD, CGGA

Roomster, Van

1.4 63 09/06 → 05/15 B BXW, CGGB

VOLKSWAGEN
Bora, Station Wagon

1.4 16V 55 03/00 → 05/05 B AHW, AKQ, APE, AXP, BCA 04-1998 →

55 09/01 → 05/05 B AHW, AXP, BCA

Caddy II

1.4 55 08/00 → 01/04 B AUA

1.4 16V 55 08/00 → 01/04 B AUA

Caddy III

1.4 55 03/04 → 05/06 B BCA

59 05/06 → 08/10 B BUD

81777
350981777000

KW

VOLKSWAGEN
Golf IV, Variant, Cabrio

| | | | | | |
|---------|----|---------------|---|-------------------------|-----------|
| 1.4 16V | 55 | 08/97 → 06/05 | B | AHW, AKQ, APE, AXP, BCA | |
| | 55 | 05/99 → 06/06 | B | AHW, AKQ, APE, AXP, BCA | 01-1997 → |

Golf V, Plus, Variant

| | | | | | |
|---------|----|---------------|---|-----------|--|
| 1.4 | 59 | 06/07 → 07/09 | B | BUD | |
| | 55 | 01/05 → 11/06 | B | BCA | |
| 1.4 16V | 59 | 05/06 → 11/08 | B | BUD | |
| | 59 | 05/06 → 12/13 | B | BUD, CGGA | |

Golf VI, Variant, Cabrio

| | | | | | |
|-----|----|---------------|---|-----------|--|
| 1.4 | 59 | 07/09 → 07/13 | B | BUD, CGGA | |
| | 59 | 10/08 → 11/12 | B | CGGA | |

Lupo I

| | | | | | |
|---------|----|---------------|---|-------------------------|-----------|
| 1.4 16V | 55 | 09/98 → 07/05 | B | AHW, AKQ, APE, AUA, BBY | 11-1998 → |
| | 74 | 08/99 → 07/05 | B | AFK, AQQ, AUB | |
| 1.4 FSI | 77 | 02/01 → 07/05 | B | ARR | |

New Beetle, Cabrio

| | | | | | |
|-----|----|---------------|---|-----|--|
| 1.4 | 55 | 11/01 → 09/10 | B | BCA | |
|-----|----|---------------|---|-----|--|

Polo III (6N1), Classic, Variant, Van

| | | | | | |
|------------|----|---------------|---|----------|--|
| 1.4 16V | 55 | 10/99 → 09/01 | B | APE, AUA | |
| 75 1.4 16V | 55 | 10/99 → 09/01 | B | APE, AUA | |

Polo IV (6N2)

| | | | | | |
|---------|----|---------------|---|---------------|--|
| 1.4 16V | 55 | 10/99 → 09/01 | B | AHW, APE, AUA | |
| | 74 | 10/99 → 09/01 | B | AFK, AQQ, AUB | |

Polo V (9N)

| | | | | | |
|---------|----|---------------|---|---------------|--|
| 1.4 | 55 | 07/03 → | B | BBY, BKY | |
| | 63 | 06/05 → 11/09 | B | | |
| | 74 | 11/03 → | B | BBZ | |
| 1.4 16V | 55 | 10/01 → 05/08 | B | AUA, BBY, BKY | |
| | 59 | 05/06 → 11/09 | B | BUD | |
| | 74 | 10/01 → 05/08 | B | AUB, BBZ | |

Polo VI (6R)

| | | | | | |
|------------|----|---------------|----|------------------|--|
| 1.4 | 63 | 06/09 → | B | CDDA, CGGB, CLPA | |
| 1.4 BiFuel | 60 | 03/10 → 01/11 | BF | CMAA | |

81777
350981777000

KW

VOLKSWAGEN
Polo VI (6R)

| | | | | | |
|------------|----|---------|----|------|--|
| 1.6 | 63 | 11/10 → | B | CFNB | |
| 1.6 BiFuel | 60 | 01/11 → | BF | CNKA | |

81779
350981779000

PULEGGIA

| | |
|----------------------------|-------|
| Diametro Puleggia | Ø62.3 |
| Numero Denti/Gole Puleggia | 14 |
| Altezza Puleggia | 31.5 |
| Posizione Attacco | 59.1 |
| Diametro Girante | Ø71 |
| N° Alette Girante | 7 |
| Posizione Girante | 21 |

KW

VOLVO
S 80 I

| | | | | | |
|--------|-----|---------------|---|---------|-----------|
| 2.8 T6 | 200 | 05/98 → 07/06 | B | B6284T | → 12-2002 |
| | 147 | 03/99 → 07/06 | B | B6294S | → 12-2002 |
| 2.9 | 150 | 05/98 → 07/06 | B | B6304S3 | → 12-2002 |
| | 144 | 06/01 → 07/06 | B | B6294S2 | → 12-2002 |
| 3.0 T6 | 200 | 06/01 → 07/06 | B | B6294T | → 12-2002 |

81780
350981780000

PULEGGIA

| | |
|----------------------------|-------|
| Diametro Puleggia | Ø56.3 |
| Numero Denti/Gole Puleggia | 19 |
| Altezza Puleggia | 29.5 |
| Posizione Attacco | 68 |
| Diametro Girante | Ø55 |
| N° Alette Girante | 11 |
| Posizione Girante | 35.6 |

KW

DAEWOO
Espero

| | | | | | |
|---------|----|---------------|---|-------|--|
| 1.5 16V | 65 | 10/93 → 09/94 | B | A15MF | |
| | 66 | 02/95 → 06/99 | B | A15MF | |

Lanos

| | | | | | |
|---------|----|---------|---|--------|--|
| 1.6 16V | 78 | 05/97 → | B | A16DMS | |
|---------|----|---------|---|--------|--|

Nexia I

| | | | | | |
|---------|----|---------------|---|-------|--|
| 1.5 16V | 66 | 02/95 → 08/97 | B | A15MF | |
|---------|----|---------------|---|-------|--|

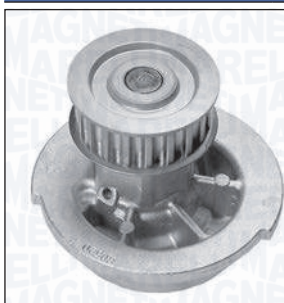
81781
350981781000

PULEGGIA

Diametro Puleggia Ø56.3
 Numero Denti/Gole Puleggia 19
 Altezza Puleggia 20
 Posizione Attacco 58.5
 Diametro Girante Ø55
 N° Alette Girante 11
 Posizione Girante 35.6

KW

CHEVROLET
Aveo I

| | | | | | |
|-----|----|---------------|---|------------|--|
| 1.5 | 62 | 01/05 → 05/08 | B | F15S3 | |
| | 62 | 05/05 → | B | F15S3, LX6 | |

Kalos

| | | | | | |
|-----|----|---------|---|-------|--|
| 1.2 | 53 | 03/05 → | B | B12S1 | |
|-----|----|---------|---|-------|--|

DAEWOO
Kalos

| | | | | | |
|-----|----|---------------|---|--------------|--|
| 1.2 | 53 | 04/03 → | B | B12S1, F12S3 | |
| 1.4 | 61 | 09/02 → | B | F14S3 | |
| 1.5 | 62 | 11/02 → 12/04 | B | F15S | |

Lanos

| | | | | | |
|-----|----|---------|---|--------|-----------|
| 1.4 | 55 | 05/97 → | B | A14SMS | |
| 1.5 | 63 | 05/97 → | B | A15SMS | 01-1997 → |
| | 63 | 05/97 → | B | A15SMS | |

81782
350981782000

PULEGGIA

Diametro Puleggia Ø56.3
 Numero Denti/Gole Puleggia 19
 Altezza Puleggia 29.5
 Posizione Attacco 68
 Diametro Girante Ø55
 N° Alette Girante 11
 Posizione Girante 35.6

KW

CHEVROLET
Aveo I

| | | | | | |
|-----|----|---------|---|------------------|--|
| 1.6 | 77 | 09/03 → | B | A16DMS, LXT, LXV | |
|-----|----|---------|---|------------------|--|

Cruze II, Hatchback, Station Wagon

| | | | | | |
|-----|----|---------|---|-----|--|
| 1.6 | 86 | 12/12 → | B | LDE | |
|-----|----|---------|---|-----|--|

Kalos

| | | | | | |
|---------|----|---------|---|-------|--|
| 1.4 | 61 | 03/05 → | B | F14S3 | |
| 1.4 16V | 69 | 03/05 → | B | F14D3 | |

81782
350981782000

KW

CHEVROLET
Lacetti

| | | | | | |
|---------|----|---------|---|--------|--|
| 1.4 16V | 70 | 03/05 → | B | F14D3 | |
| 1.6 | 80 | 03/05 → | B | F16D3 | |
| 1.8 | 89 | 08/05 → | B | F18D3 | |
| | 90 | 03/05 → | B | T18SED | |

Nubira, Station Wagon

| | | | | | |
|-----|----|---------|---|--------|--|
| 1.4 | 69 | 01/05 → | B | F14D3 | |
| | 70 | 01/06 → | B | F14D3 | |
| 1.6 | 80 | 03/05 → | B | F16D3 | |
| 1.8 | 89 | 08/05 → | B | F18D3 | |
| | 90 | 03/05 → | B | T18SED | |

Rezzo

| | | | | | |
|-----|----|---------|---|--------|--|
| 1.6 | 77 | 03/05 → | B | A16DMS | |
| | 79 | 08/05 → | B | A16DMS | |

DAEWOO
Kalos

| | | | | | |
|---------|----|---------------|---|-------|--|
| 1.4 | 69 | 05/03 → 12/04 | B | F14D3 | |
| 1.4 16V | 69 | 04/03 → | B | F14D3 | |

Lacetti II

| | | | | | |
|-----|----|---------------|---|--------|--|
| 1.6 | 78 | 06/99 → 07/03 | B | A16DMS | |
|-----|----|---------------|---|--------|--|

Lacetti III, Hatchback

| | | | | | |
|-----|----|---------|---|-------|--|
| 1.4 | 70 | 02/04 → | B | F14D3 | |
| 1.6 | 80 | 02/04 → | B | F16D3 | |

Nubira I, Station Wagon

| | | | | | |
|---------|----|---------------|---|--------|--|
| 1.6 | 76 | 08/02 → 07/03 | B | A16DMS | |
| | 66 | 06/97 → | B | A16SMS | |
| 1.6 16V | 76 | 07/00 → | B | A16DMS | |
| | 78 | 05/97 → | B | A16DMS | |

Nubira II, Station Wagon

| | | | | | |
|-----|----|---------------|---|--------|--|
| 1.4 | 69 | 10/03 → 12/04 | B | F14D3 | |
| 1.6 | 80 | 07/03 → | B | F16D3 | |
| 1.8 | 90 | 07/03 → | B | T18SED | |

Rezzo

| | | | | | |
|--------|----|---------------|---|--------|--|
| 1.6 | 77 | 09/00 → | B | A16DMS | |
| 1.6 SX | 66 | 08/01 → 12/04 | B | A16SMS | |

81783
350981783000

PULEGGIA

| | |
|----------------------------|--------|
| Diametro Puleggia | Ø54.66 |
| Numero Denti/Gole Puleggia | 22 |
| Altezza Puleggia | 28 |
| Posizione Attacco | 58.9 |
| Diametro Girante | Ø58 |
| N° Alette Girante | 7 |
| Posizione Girante | 3.75 |

CHEVROLET
Aveo I

| | | | | |
|-----|----|---------------|---|----------------------|
| 1.2 | 53 | 03/06 → 12/07 | B | B12S1, F12S3, LY4 |
|-----|----|---------------|---|----------------------|

Kalos

| | | | | |
|-----|----|---------|---|-------|
| 1.2 | 53 | 03/05 → | B | F12S3 |
|-----|----|---------|---|-------|

Matiz

| | | | | |
|---------|----|---------|---|-------|
| 0.8 | 38 | 03/05 → | B | F8CV |
| 0.8 LPG | 38 | 03/05 → | | F8CV |
| 1.0 | 47 | 03/05 → | B | B10S |
| | 49 | 03/05 → | B | B10S1 |
| 1.0 LPG | 49 | 03/05 → | | B10S1 |

Spark I

| | | | | |
|-----|----|---------------|---|-------|
| 0.8 | 38 | 09/00 → 12/04 | B | F8CV |
| 1.0 | 47 | 11/02 → 12/04 | B | G10CV |

Spark II

| | | | | |
|--------|----|---------|---|-----------|
| 0.8 | 37 | 05/05 → | B | F8CV |
| 1.0 SX | 46 | 05/05 → | B | B10S, LA2 |
| | 49 | 05/05 → | B | B10S1 |

DAEWOO
Matiz

| | | | | |
|-----|----|---------|---|------|
| 0.8 | 38 | 09/98 → | B | F8CV |
| 1.0 | 47 | 01/03 → | B | B10S |

Tico II

| | | | | |
|-----|----|---------------|---|------|
| 0.8 | 35 | 02/95 → 12/00 | B | F8C |
| | 38 | 01/96 → 12/00 | B | F8CV |

SUZUKI
Cappucino

| | | | | |
|-----|----|---------------|---|-----|
| 0.7 | 47 | 02/92 → 08/95 | B | F6A |
|-----|----|---------------|---|-----|

81784
350981784000

FLANGIA

| | |
|-------------------------|-------|
| Numero Fori Flangia | 4 |
| Dimensione Fori Flangia | M6×1 |
| Posizione Attacco | 92.5 |
| Diametro Mozzo | Ø20 |
| Diametro Girante | Ø54.5 |
| N° Alette Girante | 6 |
| Posizione Girante | -1 |

HYUNDAI
Accent I

| | | | | |
|-----------|----|---------------|---|------|
| 1.3 | 44 | 10/94 → 01/00 | B | G4EH |
| | 55 | 10/94 → 01/00 | B | G4EH |
| 1.3 i 12V | 62 | 10/94 → 01/00 | B | G4EH |
| 1.5 i 12V | 65 | 10/94 → 01/00 | B | G4EK |

Accent II

| | | | | |
|-----|----|---------------|---|------|
| 1.3 | 55 | 01/00 → 11/05 | B | G4EA |
| | 61 | 01/00 → 11/05 | B | G4EA |
| | 62 | 08/02 → 11/05 | B | G4EH |
| | 63 | 01/00 → 11/05 | B | G4EA |

Getz

| | | | | |
|-------|----|---------------|---|------|
| 1.3 | 63 | 09/03 → 09/05 | B | G4EA |
| 1.3 i | 60 | 09/02 → 03/04 | B | G4EA |

Lantra I

| | | | | |
|----------|----|---------------|---|------------|
| 1.5 i.e. | 63 | 10/90 → 11/95 | B | G15B, G4DJ |
|----------|----|---------------|---|------------|

Lantra II, Station Wagon

| | | | | |
|---------|----|---------------|---|------|
| 1.5 12V | 65 | 12/96 → 09/00 | B | G4EK |
|---------|----|---------------|---|------|

Pony III / Excel

| | | | | |
|-------|----|---------------|---|------------|
| 1.3 | 43 | 10/89 → 01/95 | B | G4DG |
| | 49 | 10/89 → 01/95 | B | G4DG |
| 1.5 | 53 | 10/89 → 01/95 | B | G15B, G4DJ |
| 1.5 i | 61 | 10/89 → 01/95 | B | G15B, G4DJ |
| | 62 | 10/89 → 01/95 | B | G15B, G4DJ |

S Coupé

| | | | | |
|-------------|----|---------------|---|------------|
| 1.5 GS | 57 | 03/90 → 12/92 | B | G4DJ |
| 1.5 i | 62 | 02/90 → 05/96 | B | G15B, G4DJ |
| | 65 | 04/92 → 05/96 | B | G4EK |
| 1.5 i Turbo | 85 | 04/91 → 05/96 | B | G4EK-TC |

MITSUBISHI
Colt III

| | | | | |
|----------|----|---------------|---|------------|
| 1.3 | 51 | 04/88 → 05/92 | B | 4G13 (8V) |
| 1.3 12V | 55 | 04/88 → 05/92 | B | 4G13 (12V) |
| 1.3 GL | 44 | 04/88 → 12/90 | B | 4G13 (8V) |
| 1.5 | 66 | 07/90 → 05/92 | B | 4G15 (12V) |
| 1.5 GLXi | 62 | 04/88 → 05/92 | B | 4G15 |

Colt IV

| | | | | |
|-------------|----|---------------|---|------------|
| 1.3 GLi 12V | 55 | 04/92 → 04/96 | B | 4G13 (12V) |
|-------------|----|---------------|---|------------|

81784 **350981784000**

MITSUBISHI
Colt V

1.5 16V 69 10/99 → 09/03 B 4G15 (16V)

Lancer III, Station Wagon

1.3 GL 50 05/88 → 06/90 B G13B

55 07/90 → 08/92 B 4G13 (12V)

1.5 61 09/88 → 12/90 B 4G15

1.5 12V 66 09/90 → 12/91 B 4G15 (12V)

1.5 GLS 63 08/89 → 08/92 B 4G15 (12V)

Lancer IV, Station Wagon

1.2 GL 44 05/88 → 08/92 B 4G16

44 04/88 → 05/92 B 4G13 (8V)

1.3 51 08/88 → 05/92 B 4G13 (8V), G13B

1.3 12V 55 06/92 → 05/94 B 4G13 (12V)

1.3 GL 50 05/88 → 06/90 B G13B

1.5 62 06/88 → 05/92 B 4G15

62 04/88 → 05/92 B 4G15 (12V)

1.5 12V 66 05/89 → 05/92 B 4G15 (12V)

1.5 GLS 63 08/89 → 08/92 B 4G15 (12V)

Lancer V, Station Wagon, Hatchback, Coupé

1.3 55 06/92 → 02/95 B 4G13 (12V)

55 06/92 → 12/96 B 4G13 (12V)

1.3 55 06/92 → 12/96 B 4G13 (12V)

Lancer VI, Station Wagon, Hatchback, Coupé, Cabrio

1.5 16V 69 10/99 → 08/03 B 4G15 (16V)

Space Star

1.3 16V 60 09/00 → 12/04 B 4G13 (16V)

61 12/98 → 12/04 B 4G13 (16V)

63 06/98 → 12/04 B 4G13 (16V)

81785 **350981785000**

FLANGIA

| | |
|-------------------------|-------|
| Numero Fori Flangia | 4 |
| Dimensione Fori Flangia | M6×1 |
| Posizione Attacco | 86.5 |
| Diametro Mozzo | Ø23.9 |
| Diametro Girante | Ø63 |
| N° Alette Girante | 6 |
| Posizione Girante | 6 |

HYUNDAI
Coupé I

1.6 16V 85 03/98 → 04/02 B G4GR

1.6 i 16V 84 12/96 → 04/02 B 4G61

100 08/01 → 08/09 B G4GC-G

2.0 101 08/99 → 01/02 B G4DF

102 03/02 → 08/09 B G4GC-G

2.0 16V 99 03/01 → 04/02 B G4DF

102 08/96 → 04/02 B G4GF

2.0 GLS 105 02/03 → 08/09 B G4GC-G

Elantra I

1.8 79 06/00 → 07/03 B G4BB

97 06/00 → 07/06 B G4BB

102 06/00 → 07/06 B G4GC-G

2.0 104 06/00 → 07/06 B G4GC

105 10/03 → 07/06 B G4GC

Elantra II

2.0 CVVT 105 06/06 → 06/11 B G4GC 11-2006 →

i30 I, Station Wagon

2.0 105 10/07 → 11/11 B G4GC, G4GC-G

105 10/07 → 11/11 B G4GC, G4GC-G

Lantra I

1.6 i.e. 16V 78 10/90 → 11/95 B G4CR

84 10/90 → 11/95 B G4CR

Lantra II, Station Wagon

1.6 16V 84 11/95 → 09/00 B 4G61

1.6 i 66 11/95 → 09/00 B G4GR

1.8 16V 94 11/95 → 09/00 B G4GM

2.0 16V 102 08/96 → 09/00 B G4GF

Matrix

1.8 90 06/01 → 08/10 B G4GB-G

Tiburón

2.0 CVVT 105 10/06 → 12/08 B G4GC

Trajét

2.0 103 01/04 → 07/08 B G4GC-G

104 11/03 → 07/08 B G4GC 02-2004 →

81785 350981785000



HYUNDAI

Tucson I

| | | | | |
|------------------------|-----|---------------|---|------|
| 2.0 | 104 | 08/04 → 03/10 | B | G4GC |
| 2.0 Trazione integrale | 104 | 08/04 → 03/10 | B | G4GC |

KIA

Carens II

| | | | | |
|----------|-----|---------|---|------|
| 2.0 CVVT | 102 | 08/04 → | B | G4GC |
|----------|-----|---------|---|------|

Cee'd I, Station Wagon

| | | | | |
|-----|-----|---------------|---|------|
| 2.0 | 105 | 12/06 → 12/12 | B | G4GC |
|-----|-----|---------------|---|------|

Cerato I

| | | | | |
|-----|-----|---------|---|------|
| 2.0 | 105 | 04/04 → | B | G4GC |
|-----|-----|---------|---|------|

Pro Cee'd I

| | | | | |
|---------|-----|---------------|---|------|
| 2.0 | 105 | 02/08 → 09/12 | B | G4GC |
| 2.0 LPG | 105 | 01/09 → 12/09 | | G4GC |

Sportage II

| | | | | |
|-------------|-----|---------|---|------|
| 2.0 16V 4WD | 104 | 09/04 → | B | G4GC |
| 2.0 i 16V | 104 | 09/04 → | B | G4GC |

81786 350981786000



FLANGIA
 Numero Fori Flangia 4
 Dimensione Fori Flangia M6×1
 Posizione Attacco 92
 Diametro Mozzo Ø23.9
 Diametro Girante Ø75
 N° Alette Girante 8
 Posizione Girante -1



HYUNDAI

Lantra I

| | | | | |
|--------------|----|---------------|---|------|
| 1.8 i.e. 16V | 93 | 10/90 → 11/95 | B | G4CN |
|--------------|----|---------------|---|------|

Sonata II

| | | | | |
|-----------|----|---------------|---|--------|
| 2.0 i 16V | 96 | 01/91 → 10/93 | B | G4CP-D |
|-----------|----|---------------|---|--------|

Sonata III

| | | | | |
|-----------|-----|---------------|---|---------|
| 2.0 i 16V | 92 | 06/96 → 06/98 | B | G4CP-DM |
| | 102 | 05/93 → 06/98 | B | G4CP-D |

KIA

Joice

| | | | | |
|-----|-----|---------|---|------|
| 2.0 | 88 | 09/01 → | B | G4CP |
| | 102 | 02/00 → | B | G4CP |

81786 350981786000



MITSUBISHI

Colt III

| | | | | |
|-------------|-----|---------------|---|------|
| 1.8 GTi 16V | 100 | 06/90 → 05/92 | B | 4G67 |
|-------------|-----|---------------|---|------|

Eclipse I, Cabrio

| | | | | |
|---------------|-----|---------------|---|----------------|
| 2.0 i 16V | 110 | 04/91 → 11/95 | B | 4G63 (DOHC16V) |
| 2.0 i 16V 4WD | 110 | 04/91 → 11/95 | B | 4G63 (DOHC16V) |

Galant IV, Station Wagon

| | | | | |
|-----------------|-----|---------------|---|----------------|
| 2.0 GTi 16V | 106 | 11/88 → 10/92 | B | 4G63 (DOHC16V) |
| | 107 | 11/88 → 10/92 | B | 4G63 (DOHC16V) |
| 2.0 GTi 16V 4WD | 106 | 06/88 → 10/92 | B | 4G63 (DOHC16V) |
| | 110 | 09/91 → 10/92 | B | 4G63 (DOHC16V) |
| 2.0 GTi 16V 4x4 | 106 | 07/89 → 12/92 | B | 4G63 (DOHC16V) |

Lancer IV, Station Wagon

| | | | | |
|-------------|-----|---------------|---|------|
| 1.8 GTi 16V | 100 | 11/89 → 05/92 | B | 4G67 |
|-------------|-----|---------------|---|------|

Santamo

| | | | | |
|-------------|-----|---------------|---|----------------|
| 2.0 16V | 102 | 05/99 → 12/04 | B | 4G63 (DOHC16V) |
| 2.0 16V 4WD | 102 | 05/99 → 12/04 | B | 4G63 (DOHC16V) |

81787 350981787000



FLANGIA
 Numero Fori Flangia 4
 Dimensione Fori Flangia M6×1
 Posizione Attacco 130
 Diametro Mozzo Ø23.9
 Diametro Girante n.v.
 N° Alette Girante n.v.
 Posizione Girante n.v.



HYUNDAI

Galloper I

| | | | | |
|-----------|----|---------------|---|-------|
| 2.5 TCi D | 77 | 08/98 → 12/03 | D | D4BH |
| | 65 | 08/98 → 12/03 | D | D4BA |
| 2.5 TD | 62 | 08/91 → 07/98 | D | 4D56T |
| | 70 | 08/91 → 07/98 | D | 4D56T |

81787 350981787000

HYUNDAI
Grace

| | | | | |
|--------|----|---------------|---|------|
| 2.5 TD | 59 | 06/98 → 10/01 | D | D4BF |
|--------|----|---------------|---|------|

H 100

| | | | | |
|----------|----|---------------|---|------------|
| 2.5 D | 55 | 07/93 → 12/94 | D | D4BA, D4BX |
| | 57 | 12/94 → 03/00 | D | D4BA |
| 2.5 TD | 59 | 07/93 → 03/00 | D | D4BF |
| 2.5 TDiC | 59 | 06/98 → 10/03 | D | D4BF |

Starex

| | | | | |
|------------|----|---------------|---|------|
| 2.5 D | 57 | 10/97 → 04/04 | D | D4BF |
| 2.5 TD | 59 | 06/97 → 04/04 | D | D4BF |
| 2.5 TD 4WD | 59 | 02/98 → 04/04 | D | D4BF |

MITSUBISHI
L 200 II

| | | | | |
|-----------|----|---------------|---|---------------------|
| 2.5 D | 51 | 11/86 → 10/96 | D | 4D56 (8V) → 06-1996 |
| 2.5 D 4WD | 51 | 12/87 → 05/93 | D | 4D56 (8V) |

L 200 III

| | | | | |
|-------|----|---------------|---|-----------|
| 2.5 D | 55 | 06/96 → 12/07 | D | 4D56 (8V) |
|-------|----|---------------|---|-----------|

L 300

| | | | | |
|--------|----|---------------|---|-----------|
| 2.5 D | 51 | 11/86 → 02/06 | D | 4D56 (8V) |
| 2.5 TD | 64 | 02/87 → 08/97 | D | 4D56T |
| | 64 | 02/87 → 05/03 | D | 4D56T |

L 400

| | | | | |
|-------------|----|---------------|---|--------|
| 2.5 TD | 73 | 05/95 → 05/00 | D | 4D56TD |
| 2.5 TD 4WD | 73 | 05/95 → 05/00 | D | 4D56TD |
| 2500 TD | 64 | 05/95 → 06/05 | D | 4D56T |
| | 64 | 09/96 → 06/05 | D | 4D56T |
| 2500 TD 4WD | 64 | 09/96 → 06/05 | D | 4D56T |

Pajero I

| | | | | |
|--------|----|---------------|---|-------|
| 2.5 TD | 64 | 01/90 → 12/91 | D | 4D56T |
| | 70 | 11/89 → 11/90 | D | 4D56T |

81789 350981789000

| | |
|-------------------------|------|
| FLANGIA | |
| Numero Fori Flangia | 4 |
| Dimensione Fori Flangia | M6×1 |
| Posizione Attacco | 79 |
| Diametro Mozzo | Ø24 |
| Diametro Girante | Ø60 |
| N° Alette Girante | 7 |
| Posizione Girante | 9.5 |

SUZUKI
Jimny

| | | | | |
|-------------|----|---------------|---|-------|
| 1.3 16V | 59 | 09/98 → | B | G13BB |
| 1.3 16V 4WD | 59 | 09/98 → | B | G13BB |
| | 63 | 09/98 → 08/00 | B | G13BB |

Samurai

| | | | | |
|------------------------|----|---------------|---|-------|
| 1.3 | 47 | 11/88 → 12/04 | B | G13A |
| 1.3 Trazione integrale | 51 | 11/88 → 12/04 | B | G13BA |
| | 44 | 11/88 → 12/04 | B | G13A |

SJ 413

| | | | | |
|-----|----|---------------|---|------|
| 1.3 | 44 | 08/86 → 08/90 | B | G13A |
| | 47 | 09/84 → 08/90 | B | G13A |

81790 350981790000

| | |
|-------------------------|-------|
| FLANGIA | |
| Numero Fori Flangia | 4 |
| Dimensione Fori Flangia | M6×1 |
| Posizione Attacco | 79.8 |
| Diametro Mozzo | Ø24 |
| Diametro Girante | Ø58.5 |
| N° Alette Girante | 7 |
| Posizione Girante | 9 |

SUZUKI
Baleno, Station Wagon

| | | | | |
|---------------|----|---------------|---|------|
| 1.6 i 16V | 72 | 07/95 → 05/02 | B | G16B |
| | 73 | 08/96 → 05/02 | B | G16B |
| 1.6 i 16V 4x4 | 72 | 07/95 → 05/02 | B | G16B |
| 1.8 GTX | 89 | 03/96 → 05/02 | B | J18A |
| 1.8 i 16V | 89 | 08/96 → 05/02 | B | J18A |

Swift II, Cabrio

| | | | | |
|-----------|----|---------------|---|------|
| 1.6 | 70 | 11/89 → 12/91 | B | G16B |
| 1.6 4WD | 70 | 11/89 → 12/91 | B | G16B |
| 1.6 i | 68 | 01/90 → 05/01 | B | G16B |
| 1.6 i 4WD | 68 | 01/90 → 05/01 | B | G16B |

81790
350981790000

SUZUKI
Vitara

| | | | | |
|----------------------------------|-----|---------------|---|-----------|
| 1.6 | 59 | 07/88 → 01/95 | B | G16A (8V) |
| 1.6 i 16V | 71 | 07/90 → 03/99 | B | G16B |
| 1.6 i 16V Trazione integrale | 71 | 07/90 → 03/98 | B | G16B |
| 1.6 Trazione integrale | 59 | 07/88 → 03/98 | B | G16A (8V) |
| | 60 | 07/88 → 12/91 | B | G16A (8V) |
| 2.0 V6 24V Trazione integrale | 100 | 12/94 → 03/98 | B | H20A |

X-90

| | | | | |
|---------------|----|---------------|---|------|
| 1.6 i 16V | 71 | 09/95 → 12/97 | B | G16B |
| 1.6 i 16V 4x4 | 71 | 09/95 → 12/97 | B | G16B |

81791
350981791000

PULEGGIA

| | |
|----------------------------|--------|
| Diametro Puleggia | Ø56.21 |
| Numero Denti/Gole Puleggia | 19 |
| Altezza Puleggia | 33.5 |
| Posizione Attacco | 52.2 |
| Diametro Girante | Ø59.8 |
| N° Alette Girante | 8 |
| Posizione Girante | 48.2 |

AUDI
A2

| | | | | |
|---------|----|---------------|---|----------|
| 1.2 TDI | 45 | 03/01 → 08/05 | D | ANY |
| 1.4 TDI | 55 | 02/00 → 08/05 | D | AMF, BHC |
| | 66 | 11/03 → 08/05 | D | ATL |

A3 II, Sportback, Cabriolet

| | | | | |
|---------|----|---------------|---|---------------|
| 1.9 TDI | 77 | 05/03 → 05/10 | D | BKC, BLS, BXE |
| | 77 | 04/08 → 10/09 | D | BLS |

FORD
Galaxy I

| | | | | |
|---------|-----|---------------|---|-----|
| 1.9 TDI | 96 | 02/03 → 05/06 | D | ASZ |
| | 110 | 05/05 → 05/06 | D | BTB |

SEAT
Alhambra I

| | | | | |
|-------------|----|---------------|---|-----|
| 1.9 TDI | 96 | 11/02 → 11/08 | D | ASZ |
| 1.9 Tdi 4x4 | 96 | 06/05 → 11/08 | D | ASZ |

81791
350981791000

SEAT
Altea, Altea XL

| | | | | |
|---------|----|---------|---|--------------------|
| 1.9 TDI | 66 | 08/09 → | D | BXF |
| | 77 | 04/04 → | D | BJB, BKC, BLS, BXE |
| | 77 | 10/06 → | D | BKC, BLS, BXE |

Arosa

| | | | | |
|---------|----|---------------|---|-----|
| 1.4 TDI | 55 | 01/00 → 06/04 | D | AMF |
|---------|----|---------------|---|-----|

Cordoba III, Vario

| | | | | |
|---------|----|---------------|---|----------|
| 1.4 TDI | 51 | 05/05 → 11/09 | D | BNM |
| | 55 | 10/02 → 12/05 | D | AMF |
| | 59 | 06/05 → 11/09 | D | BMS, BNV |

| | | | | |
|---------|----|---------------|---|---------------|
| 1.9 TDI | 74 | 09/02 → 11/09 | D | ATD, AXR, BMT |
| | 96 | 10/02 → 11/09 | D | ASZ, BLT |

Ibiza IV

| | | | | |
|---------|----|---------------|---|----------|
| 1.4 TDI | 51 | 05/05 → 11/09 | D | BNM |
| | 55 | 05/02 → 12/05 | D | AMF |
| | 59 | 06/05 → 11/09 | D | BMS, BNV |

| | | | | |
|---------|----|---------------|---|---------------|
| 1.9 TDI | 74 | 02/02 → 11/09 | D | ATD, AXR, BMT |
| | 96 | 02/02 → 11/09 | D | ASZ, BLT |

Ibiza V

| | | | | |
|---------|----|---------------|---|-----|
| 1.4 TDI | 59 | 07/08 → 06/10 | D | BMS |
| 1.9 TDI | 66 | 07/08 → 06/10 | D | BXJ |
| | 77 | 03/08 → 06/10 | D | BLS |

Leon II

| | | | | |
|---------|----|---------------|---|---------------|
| 1.9 TDI | 66 | 06/07 → 12/10 | D | BXF |
| | 77 | 07/05 → 12/10 | D | BKC, BLS, BXE |
| | 81 | 10/05 → 12/12 | D | ASV |

Toledo III

| | | | | |
|---------|----|---------------|---|--------------------|
| 1.9 TDI | 77 | 10/04 → 05/09 | D | BJB, BKC, BLS, BXE |
|---------|----|---------------|---|--------------------|

SKODA
Fabia I, Station Wagon, Van

| | | | | |
|------------|----|---------------|---|----------|
| 1.4 TDI | 51 | 10/05 → 03/08 | D | BNM |
| | 55 | 04/03 → 03/08 | D | AMF |
| | 59 | 10/05 → 03/08 | D | BNV |
| 1.9 TDI | 74 | 01/00 → 03/08 | D | ATD, AXR |
| 1.9 TDI RS | 96 | 06/03 → 03/08 | D | ASZ, BLT |

Fabia II, Station Wagon, Van

| | | | | |
|---------|----|---------------|---|----------|
| 1.4 TDI | 51 | 02/07 → 03/10 | D | BNM |
| | 59 | 01/07 → 03/10 | D | BMS, BNV |
| 1.9 TDI | 77 | 04/07 → 03/10 | D | BLS, BSW |

81791 350981791000

KW

SKODA
Octavia II, Station Wagon

| | | | | |
|---------|----|---------------|---|--------------------|
| 1.9 TDI | 77 | 06/04 → 12/10 | D | BJB, BKC, BLS, BXE |
|---------|----|---------------|---|--------------------|

| | | | | |
|-------------|----|---------------|---|---------------|
| 1.9 TDI 4x4 | 77 | 11/04 → 12/10 | D | BKC, BLS, BXE |
|-------------|----|---------------|---|---------------|

Roomster, Van

| | | | | |
|---------|----|---------------|---|-----|
| 1.4 TDI | 51 | 07/06 → 03/10 | D | BNM |
|---------|----|---------------|---|-----|

| | | | | |
|--|----|---------------|---|----------|
| | 59 | 09/06 → 03/10 | D | BMS, BNV |
|--|----|---------------|---|----------|

| | | | | |
|---------|----|---------------|---|----------|
| 1.9 TDI | 77 | 09/06 → 03/10 | D | BLS, BSW |
|---------|----|---------------|---|----------|

Superb II, Station Wagon

| | | | | |
|---------|----|---------------|---|----------|
| 1.9 TDI | 77 | 03/08 → 11/10 | D | BLS, BXE |
|---------|----|---------------|---|----------|

VOLKSWAGEN
Caddy III

| | | | | |
|---------|----|---------------|---|-----|
| 1.9 TDI | 55 | 09/05 → 08/10 | D | BSU |
|---------|----|---------------|---|-----|

| | | | | |
|--|----|---------------|---|----------|
| | 77 | 04/04 → 08/10 | D | BJB, BLS |
|--|----|---------------|---|----------|

| | | | | |
|-----------------|----|---------------|---|-----|
| 1.9 TDI 4motion | 77 | 11/08 → 08/10 | D | BLS |
|-----------------|----|---------------|---|-----|

| | | | | |
|---------|----|---------------|---|----------|
| 2.0 SDI | 51 | 03/04 → 08/10 | D | BDJ, BST |
|---------|----|---------------|---|----------|

Crafter 30-35, 30-50

| | | | | |
|---------|----|---------------|---|-----------|
| 2.5 TDI | 65 | 04/06 → 07/11 | D | BJJ, CEBA |
|---------|----|---------------|---|-----------|

Fox I

| | | | | |
|---------|----|---------|---|-----|
| 1.4 TDI | 51 | 04/05 → | D | BNM |
|---------|----|---------|---|-----|

Golf V, Plus, Variant

| | | | | |
|---------|----|---------------|---|---------------|
| 1.9 TDI | 66 | 05/05 → 12/08 | D | BRU, BXF, BXJ |
|---------|----|---------------|---|---------------|

| | | | | |
|--|----|---------------|---|---------------|
| | 77 | 01/05 → 01/09 | D | BKC, BLS, BXE |
|--|----|---------------|---|---------------|

| | | | | |
|--|----|---------------|---|----------|
| | 77 | 06/07 → 07/09 | D | BLS, BXE |
|--|----|---------------|---|----------|

| | | | | |
|-----------------|----|---------------|---|---------------|
| 1.9 TDI 4motion | 77 | 08/04 → 11/08 | D | BKC, BLS, BXE |
|-----------------|----|---------------|---|---------------|

| | | | | |
|-----------------|----|---------------|---|-----|
| 1.9 TDI 4motion | 77 | 01/08 → 07/09 | D | BLS |
|-----------------|----|---------------|---|-----|

| | | | | |
|---------|----|---------------|---|-----|
| 2.0 SDI | 55 | 01/04 → 11/08 | D | BDK |
|---------|----|---------------|---|-----|

| | | | | |
|---------|----|---------------|---|-----|
| 2.0 SDI | 55 | 01/04 → 11/08 | D | BDK |
|---------|----|---------------|---|-----|

Jetta III

| | | | | |
|---------|----|---------------|---|---------------|
| 1.9 TDI | 77 | 08/05 → 10/10 | D | BKC, BLS, BXE |
|---------|----|---------------|---|---------------|

Lupo I

| | | | | |
|------------|----|---------------|---|----------|
| 1.2 TDI 3L | 45 | 07/99 → 07/05 | D | ANY, AYZ |
|------------|----|---------------|---|----------|

| | | | | |
|---------|----|---------------|---|-----|
| 1.4 TDI | 55 | 01/99 → 07/05 | D | AMF |
|---------|----|---------------|---|-----|

Multivan V

| | | | | |
|---------|----|---------------|---|-----|
| 1.9 TDI | 62 | 01/06 → 11/09 | D | BRR |
|---------|----|---------------|---|-----|

| | | | | |
|--|----|---------------|---|-----|
| | 63 | 04/03 → 11/09 | D | AXC |
|--|----|---------------|---|-----|

| | | | | |
|--|----|---------------|---|-----|
| | 75 | 06/06 → 11/09 | D | BRS |
|--|----|---------------|---|-----|

| | | | | |
|--|----|---------------|---|-----|
| | 77 | 04/03 → 11/09 | D | AXB |
|--|----|---------------|---|-----|

81791 350981791000

KW

VOLKSWAGEN
New Beetle, Cabrio

| | | | | |
|---------|----|---------------|---|----------|
| 1.9 TDI | 74 | 02/01 → 09/10 | D | ATD, BEW |
|---------|----|---------------|---|----------|

| | | | | |
|---------|----|---------------|---|-----|
| 1.9 TDI | 77 | 07/05 → 09/10 | D | BSW |
|---------|----|---------------|---|-----|

Passat VI, Variant, CC

| | | | | |
|---------|----|---------------|---|---------------|
| 1.9 TDI | 77 | 03/05 → 11/08 | D | BKC, BLS, BXE |
|---------|----|---------------|---|---------------|

Polo IV (6N2)

| | | | | |
|---------|----|---------------|---|-----|
| 1.4 TDI | 55 | 10/99 → 09/01 | D | AMF |
|---------|----|---------------|---|-----|

| | | | | |
|--|----|---------------|---|-----|
| | 66 | 01/00 → 10/00 | D | ATL |
|--|----|---------------|---|-----|

Polo V (9N)

| | | | | |
|---------|----|---------------|---|----------|
| 1.4 TDI | 51 | 04/05 → 11/09 | D | BNM, BWB |
|---------|----|---------------|---|----------|

| | | | | |
|--|----|---------------|---|----------|
| | 55 | 10/01 → 06/05 | D | AMF, BAY |
|--|----|---------------|---|----------|

| | | | | |
|--|----|---------|---|-----|
| | 55 | 07/03 → | D | BAY |
|--|----|---------|---|-----|

| | | | | |
|--|----|---------------|---|----------|
| | 59 | 04/05 → 11/09 | D | BMS, BNV |
|--|----|---------------|---|----------|

| | | | | |
|--|----|---------|---|-----|
| | 74 | 09/02 → | D | ATD |
|--|----|---------|---|-----|

| | | | | |
|--|----|---------------|---|---------------|
| | 74 | 10/01 → 11/09 | D | ATD, AXR, BMT |
|--|----|---------------|---|---------------|

| | | | | |
|--|----|---------------|---|----------|
| | 96 | 11/03 → 11/09 | D | ASZ, BLT |
|--|----|---------------|---|----------|

Sharan I

| | | | | |
|---------|----|---------------|---|-----|
| 1.9 TDI | 96 | 11/02 → 03/10 | D | ASZ |
|---------|----|---------------|---|-----|

| | | | | |
|--|-----|---------------|---|-----|
| | 110 | 06/05 → 03/10 | D | BTB |
|--|-----|---------------|---|-----|

Touran I

| | | | | |
|---------|----|---------------|---|---------------|
| 1.9 TDI | 66 | 11/04 → 05/10 | D | BRU, BXF, BXJ |
|---------|----|---------------|---|---------------|

| | | | | |
|--|----|---------------|---|-----|
| | 74 | 02/03 → 05/04 | D | AVQ |
|--|----|---------------|---|-----|

| | | | | |
|--|----|---------------|---|---------------|
| | 77 | 08/03 → 05/10 | D | BKC, BLS, BXE |
|--|----|---------------|---|---------------|

Transporter V

| | | | | |
|---------|----|---------------|---|-----|
| 1.9 TDI | 62 | 01/06 → 11/09 | D | BRR |
|---------|----|---------------|---|-----|

| | | | | |
|--|----|---------------|---|-----|
| | 63 | 04/03 → 11/09 | D | AXC |
|--|----|---------------|---|-----|

| | | | | |
|--|----|---------------|---|-----|
| | 75 | 06/06 → 11/09 | D | BRS |
|--|----|---------------|---|-----|

| | | | | |
|--|----|---------------|---|-----|
| | 77 | 04/03 → 11/09 | D | AXB |
|--|----|---------------|---|-----|

81793

350981793000



PULEGGIA
 Diametro Puleggia Ø94.8
 Numero Denti/Gole Puleggia 5
 Altezza Puleggia 25
 Posizione Attacco 74.2
 Diametro Girante Ø53.5
 N° Alette Girante 7
 Posizione Girante 10.5



BMW

3 IV (E46), Touring, Cabrio, Coupé, Compact

| | | | | | |
|-------|-----|---------------|---|--------------------------------|-------------|
| 318 d | 85 | 09/01 → 03/03 | D | M47D20, M47D20 (204D1) | |
| 320 d | 95 | 02/98 → 04/05 | D | M47D20 (204D1) | |
| | 100 | 04/98 → 09/01 | D | M47204D1, M47D20 (204D1) | M: M47204D1 |
| | 100 | 03/00 → 09/01 | D | M47204D1, M47D20 (204D1) | |

81794

350981794000



PULEGGIA
 Diametro Puleggia Ø94.8
 Numero Denti/Gole Puleggia 5
 Altezza Puleggia 25
 Posizione Attacco 74.25
 Diametro Girante Ø61.5
 N° Alette Girante 7
 Posizione Girante 10.75



BMW

3 IV (E46), Touring, Cabrio, Coupé, Compact

| | | | | | |
|-------|-----|---------------|---|--------------------------------|-----------|
| 320 d | 100 | 04/98 → 09/01 | D | M47204D1, M47D20 (204D1) | M: M47D20 |
| | 100 | 03/00 → 09/01 | D | M47204D1, M47D20 (204D1) | |

5 IV (E39), Touring

| | | | | | |
|-------|-----|---------------|---|--------------------------------|--|
| 520 d | 100 | 02/00 → 06/03 | D | M47204D1, M47D20 (204D1) | |
|-------|-----|---------------|---|--------------------------------|--|

81795

350981795000



PULEGGIA
 Diametro Puleggia Ø95.5
 Numero Denti/Gole Puleggia 5
 Altezza Puleggia 25
 Posizione Attacco 88.5
 Diametro Girante Ø64.5
 N° Alette Girante 6
 Posizione Girante -0.7



BMW

3 IV (E46), Touring, Cabrio, Coupé, Compact

| | | | | | |
|--------|-----|---------------|---|-------------------|--|
| 330 d | 135 | 10/99 → 02/05 | D | M57D30 (306D1) | |
| 330 xd | 135 | 06/00 → 02/05 | D | M57D30 (306D1) | |

5 IV (E39), Touring

| | | | | | |
|-------|-----|---------------|---|------------------------------|-------------------------|
| 525 d | 120 | 02/00 → 06/03 | D | M57D25 (256D1) | |
| 530 d | 135 | 08/98 → 09/00 | D | M57D30 (306D1) | 09-1999 →, → 09-2000 |
| | 142 | 09/00 → 06/03 | D | M57D30 (306D1) | |
| | 142 | 09/00 → 05/04 | D | M57D30, M57D30 (306D1) | |

7 III (E38)

| | | | | | |
|-------|-----|---------------|---|-------------------|-----------|
| 730 d | 135 | 08/98 → 04/00 | D | M57D30 (306D1) | 10-1999 → |
| | 142 | 04/00 → 11/01 | D | M57D30 (306D1) | |

X5 I (E53)

| | | | | | |
|-------|-----|---------------|---|-------------------|--|
| 3.0 d | 135 | 05/01 → 12/03 | D | M57D30 (306D1) | |
|-------|-----|---------------|---|-------------------|--|

LAND ROVER

Range Rover III

| | | | | | |
|-----------|-----|---------------|---|-------|--|
| 3.0 D 4x4 | 130 | 03/02 → 08/12 | D | 306D1 | |
|-----------|-----|---------------|---|-------|--|

OPEL

Omega B, Station Wagon

| | | | | | |
|---------|-----|---------------|---|-------|--|
| 2.5 DTI | 110 | 09/01 → 07/03 | D | Y25DT | |
|---------|-----|---------------|---|-------|--|

81796
350981796000

PULEGGIA

| | |
|----------------------------|--------|
| Diametro Puleggia | Ø95.52 |
| Numero Denti/Gole Puleggia | 5 |
| Altezza Puleggia | 25 |
| Posizione Attacco | 88.5 |
| Diametro Girante | Ø64.5 |
| N° Alette Girante | 6 |
| Posizione Girante | -0.7 |

KW

BMW
5 IV (E39), Touring

| | | | | | |
|-------|-----|---------------|---|---|-------------------------|
| 530 d | 135 | 08/98 → 09/00 | D | M57D30 (306D1) | 08-1998 →, → 08-1999 |
| 540 i | 210 | 01/97 → 05/04 | B | M62448S2, M62B44 (448S1), M62B44 (448S2), M62B44TU | 09-1998 →, → 05-2004 |

7 III (E38)

| | | | | | |
|-------|-----|---------------|---|-------------------|-----------|
| 730 d | 135 | 08/98 → 04/00 | D | M57D30 (306D1) | → 09-1999 |
|-------|-----|---------------|---|-------------------|-----------|

LANCIA
Lybra, Station Wagon

| | | | | | |
|---------|-----|---------------|---|----------|--|
| 2.4 JTD | 110 | 05/02 → 10/05 | D | 841C.000 | |
|---------|-----|---------------|---|----------|--|

81797
350981797000

PULEGGIA

| | |
|----------------------------|-------|
| Diametro Puleggia | Ø53.1 |
| Numero Denti/Gole Puleggia | 18 |
| Altezza Puleggia | 25 |
| Posizione Attacco | 37 |
| Diametro Girante | Ø52.8 |
| N° Alette Girante | 6 |

KW

CITROËN
Berlingo I, Van

| | | | | | |
|--------------|----|---------------|---|----------------------------|----------------|
| 1.1 i | 44 | 07/96 → | B | HDZ (TU1M), HFX (TU1JP) | M →: 3.762.434 |
| 1.4 | 48 | 11/02 → | G | KFW (TU3JP) | |
| | 53 | 11/02 → 10/05 | B | KFW (TU3JP) | |
| 1.4 bivalent | 48 | 11/02 → | | KFW (TU3JP) | |
| 1.4 GNC | 48 | 11/02 → | G | KFW (TU3JP) | |
| 1.4 Hybrid | 54 | 05/05 → | | KFW (TU3JP) | |

81797
350981797000

KW

CITROËN
Berlingo I, Van

| | | | | | |
|----------------|----|---------|----|-----------------------------|----------------|
| 1.4 i | 55 | 07/96 → | B | KFW (TU3JP), KFX (TU3JP) | M →: 3.666.766 |
| 1.4 i bivalent | 55 | 04/03 → | BF | KFW (TU3JP) | |

C 2, Van

| | | | | | |
|-----|----|---------|---|-------------|--|
| 1.1 | 44 | 09/03 → | B | HFX (TU1JP) | |
| 1.4 | 54 | 09/03 → | B | KFV (TU3JP) | |
| | 55 | 10/06 → | B | KFV (TU3JP) | |

C 3 I, Pluriel

| | | | | | |
|----------------|----|---------|---|----------------------------|--|
| 1.1 i | 44 | 02/02 → | B | HFX (TU1A), HFX (TU1JP) | |
| 1.4 | 54 | 05/03 → | B | KFV (TU3JP) | |
| 1.4 Hybrid | 54 | 05/05 → | | KFV (TU3JP) | |
| 1.4 i | 54 | 02/02 → | B | KFV (TU3A), KFV (TU3JP) | |
| 1.4 i Bivalent | 54 | 02/02 → | | KFV (TU3JP) | |

C 3 II, Picasso

| | | | | | |
|------------|----|---------|----|---------------------------|--|
| 1.1 | 44 | 11/09 → | B | HFX (TU1JP) | |
| 1.1 BiFuel | 44 | 11/10 → | BF | HFX (TU1A) | |
| 1.4 | 54 | 11/09 → | B | KFT (TU3A), KFV (TU3A) | |

Nemo, Van

| | | | | | |
|-----|----|---------|---|---------------------------|--|
| 1.4 | 54 | 04/09 → | B | KFT (TU3A), KFV (TU3A) | |
| | 54 | 02/08 → | B | KFV (TU3A) | |

Saxo

| | | | | | |
|----------|----|---------------|---|-----------------------------|------------------------------|
| 1.1 X,SX | 40 | 05/96 → 09/03 | B | HDZ (TU1M) | 08-2000 →, M →: 3.666.766 |
| | 44 | 05/96 → 09/03 | B | HDZ (TU1M), HFX (TU1JP) | 08-2000 →, M →: 3.666.766 |
| 1.4 VTS | 55 | 05/96 → 06/03 | B | KFW (TU3JP), KFX (TU3JP) | 08-2000 →, M →: 3.666.766 |

Xsara, Break, Coupé, Picasso, Van

| | | | | | |
|-------|----|---------------|---|-----------------------------|------------------------------|
| 1.4 i | 55 | 04/97 → 03/05 | B | KFW (TU3JP), KFX (TU3JP) | 09-2000 →, M →: 3.666.766 |
| | 55 | 10/97 → 08/05 | B | KFW (TU3JP), KFX (TU3JP) | M →: 3.666.766 |

FIAT
Fiorino IV

| | | | | | |
|-----|----|---------|---|----------|--|
| 1.4 | 54 | 11/07 → | B | KFT, KFV | |
|-----|----|---------|---|----------|--|

Qubo

| | | | | | |
|-----|----|---------|---|----------|--|
| 1.4 | 54 | 02/08 → | B | KFT, KFV | |
|-----|----|---------|---|----------|--|

81797
350981797000

PEUGEOT
106 I, Van

| | | | | | |
|-----|----|---------------|---|--------------------|--|
| 1.0 | 33 | 09/91 → 03/01 | B | CDY (TU9M), TU9 | |
|-----|----|---------------|---|--------------------|--|

205 II, Van

| | | | | | |
|-----|----|---------------|---|-------------|----------------|
| 1.1 | 40 | 08/98 → 07/00 | B | HFY (TU1JP) | M →: 3.762.434 |
|-----|----|---------------|---|-------------|----------------|

| | | | | | |
|-------|----|---------|---|-----------------------------|----------------|
| 1.1 i | 44 | 09/98 → | B | HFX (TU1JP), HFZ (TU1JP) | M →: 3.762.434 |
|-------|----|---------|---|-----------------------------|----------------|

| | | | | | |
|-------|----|---------|---|-----------------------------|----------------|
| 1.4 i | 55 | 09/98 → | B | KFW (TU3JP), KFX (TU3JP) | M →: 3.666.766 |
|-------|----|---------|---|-----------------------------|----------------|

| | | | | | |
|---------|----|---------------|--|-------------|--|
| 1.4 LPG | 55 | 05/06 → 09/07 | | KFV (TU3JP) | |
|---------|----|---------------|--|-------------|--|

206 +

| | | | | | |
|-----|----|---------|---|---------------------------------------|--|
| 1.1 | 44 | 01/09 → | B | HFX (TU1A), HFX (TU1JP), TU1AE5 | |
|-----|----|---------|---|---------------------------------------|--|

| | | | | | |
|--|----|---------|---|------------|--|
| | 54 | 09/10 → | B | KFT (TU3A) | |
|--|----|---------|---|------------|--|

| | | | | | |
|-------|----|---------|---|---------------------------|--|
| 1.4 i | 55 | 01/09 → | B | KFV (TU3A), KFW (TU3A) | |
|-------|----|---------|---|---------------------------|--|

206, CC, Van

| | | | | | |
|-----|----|---------|---|-------------|----------------|
| 1.1 | 44 | 07/02 → | B | HFX (TU1JP) | M →: 3.762.434 |
|-----|----|---------|---|-------------|----------------|

| | | | | | |
|--|----|---------|---|----------------------------|----------------|
| | 55 | 07/02 → | B | KFV (TU3A), KFW (TU3JP) | M →: 3.666.766 |
|--|----|---------|---|----------------------------|----------------|

| | | | | | |
|-----|----|---------|---|----------------------------|--|
| 1.4 | 55 | 03/07 → | B | KFV (TU3A), KFW (TU3JP) | |
|-----|----|---------|---|----------------------------|--|

207, Station Wagon, CC, Van

| | | | | | |
|--|----|---------|---|------------|--|
| | 53 | 02/06 → | B | KFV (TU3A) | |
|--|----|---------|---|------------|--|

| | | | | | |
|--|----|---------|---|---------------------------|--|
| | 54 | 12/07 → | B | KFT (TU3A), KFV (TU3A) | |
|--|----|---------|---|---------------------------|--|

| | | | | | |
|-----|----|---------|---|------------|--|
| 1.4 | 54 | 12/07 → | B | KFV (TU3A) | |
|-----|----|---------|---|------------|--|

| | | | | | |
|--|----|---------|---|---------------------------|--|
| | 55 | 08/08 → | B | KFV (TU3A), KFW (TU3A) | |
|--|----|---------|---|---------------------------|--|

| | | | | | |
|-------------|----|---------|--|-------------|--|
| 1.4 Bioflex | 60 | 08/08 → | | KFW (TU3JP) | |
|-------------|----|---------|--|-------------|--|

| | | | | | |
|----------|----|---------|--|------------|--|
| 1.4 Flex | 60 | 11/08 → | | KFW (TU3A) | |
|----------|----|---------|--|------------|--|

306, Station Wagon, Coupé, Cabrio, Van

| | | | | | |
|-----|----|---------------|---|---|----------------|
| 1.4 | 55 | 05/93 → 05/01 | B | KDX (TU3MC), KFW (TU3JP), KFX (TU3JP) | M →: 3.666.766 |
|-----|----|---------------|---|---|----------------|

| | | | | | |
|--|----|---------------|---|-----------------------------|----------------|
| | 55 | 03/97 → 04/02 | B | KFW (TU3JP), KFX (TU3JP) | M →: 3.666.766 |
|--|----|---------------|---|-----------------------------|----------------|

| | | | | | |
|--------|----|---------------|---|---|----------------|
| 1.4 SL | 55 | 06/94 → 05/01 | B | KDX (TU3MC), KFW (TU3JP), KFX (TU3JP) | M →: 3.666.766 |
|--------|----|---------------|---|---|----------------|

307, Station Wagon, CC

| | | | | | |
|-----|----|---------|---|-------------|----------------|
| 1.4 | 55 | 08/00 → | B | KFW (TU3JP) | M →: 3.666.766 |
|-----|----|---------|---|-------------|----------------|

81797
350981797000

PEUGEOT
1007

| | | | | | |
|-----|----|---------|---|-------------|--|
| 1.4 | 54 | 04/05 → | B | KFV (TU3JP) | |
|-----|----|---------|---|-------------|--|

| | | | | | |
|---------|----|---------|---|-------------|--|
| 1.4 16V | 65 | 10/05 → | B | KFU (ET3J4) | |
|---------|----|---------|---|-------------|--|

Bipper, Tepee

| | | | | | |
|-----|----|---------|---|------------|--|
| 1.4 | 54 | 02/08 → | B | KFV (TU3A) | |
|-----|----|---------|---|------------|--|

Partner I

| | | | | | |
|--|----|---------|---|------------|-----------|
| | 44 | 06/96 → | B | HDZ (TU1M) | 11-2002 → |
|--|----|---------|---|------------|-----------|

| | | | | | |
|-----|----|---------|---|----------------------------|-----------|
| 1.1 | 44 | 06/96 → | B | HDZ (TU1M), HFZ (TU1JP) | 11-2002 → |
|-----|----|---------|---|----------------------------|-----------|

| | | | | | |
|--|----|---------------|---|-------------|--|
| | 54 | 11/02 → 10/06 | B | KFW (TU3JP) | |
|--|----|---------------|---|-------------|--|

| | | | | | |
|-----|----|---------|---|--------------------------------------|-----------|
| 1.4 | 55 | 06/96 → | B | KFW (TU3JP), KFX (TU3JP), TU32 | 11-2002 → |
|-----|----|---------|---|--------------------------------------|-----------|

| | | | | | |
|--|----|---------|---|----------------------|-----------|
| | 55 | 06/96 → | B | KFX (TU3JP), TU32 | 11-2002 → |
|--|----|---------|---|----------------------|-----------|

| | | | | | |
|------------|----|---------|----|-------------|----------------|
| 1.4 BiFuel | 55 | 04/03 → | BF | KFW (TU3JP) | M →: 3.666.766 |
|------------|----|---------|----|-------------|----------------|

81798
350981798000

| | | |
|--|--|--|
| | PULEGGIA | |
| | Diametro Puleggia Numero Denti/Gole Puleggia Altezza Puleggia Posizione Attacco Diametro Girante N° Alette Girante Posizione Girante | Ø62 21 30 39.1 Ø72 20 29 |

CITROËN
C 1 I

| | | | | | |
|---------|----|---------|---|-------------|--|
| 1.4 HDi | 40 | 06/05 → | D | 8HT (DV4TD) | |
|---------|----|---------|---|-------------|--|

C 2, Van

| | | | | | |
|--|----|---------|---|-------------|--|
| | 50 | 04/09 → | D | 8HX (DV4TD) | |
|--|----|---------|---|-------------|--|

| | | | | | |
|---------|----|---------|---|-----------------------------|--|
| 1.4 HDi | 50 | 09/03 → | D | 8HX (DV4TD), 8HZ (DV4TD) | |
|---------|----|---------|---|-----------------------------|--|

C 3 I, Pluriel

| | | | | | |
|-------------|----|---------|---|------------------|--|
| 1.4 16V HDi | 66 | 02/02 → | D | 8HY (DV4TED4) | |
|-------------|----|---------|---|------------------|--|

| | | | | | |
|---------|----|---------|---|-------------|--|
| 1.4 HDi | 50 | 02/02 → | D | 8HX (DV4TD) | |
|---------|----|---------|---|-------------|--|

| | | | | | |
|--|----|---------|---|-------------|--|
| | 55 | 05/05 → | D | 8HX (DV4TD) | |
|--|----|---------|---|-------------|--|

C 3 II, Picasso

| | | | | | |
|------------|----|---------|---|----------------------------|--|
| 1.4 HDi 70 | 50 | 11/09 → | D | 8HR (DV4C), 8HZ (DV4TD) | |
|------------|----|---------|---|----------------------------|--|

DS 3, Cabrio

| | | | | | |
|------------|----|---------------|---|------------|--|
| 1.4 HDi 70 | 50 | 04/10 → 07/15 | D | 8HR (DV4C) | |
|------------|----|---------------|---|------------|--|

81798 350981798000

CITROËN
Nemo, Van

| | | | | |
|---------|----|---------|---|--------------|
| 1.4 HDi | 50 | 02/08 → | D | 8HS (DV4TED) |
| | 50 | 04/09 → | D | 8HS (DV4TED) |

Xsara, Break, Coupé, Picasso, Van

| | | | | |
|---------|----|---------------|---|-------------|
| 1.4 HDi | 50 | 01/03 → 03/05 | D | 8HX (DV4TD) |
|---------|----|---------------|---|-------------|

FORD
B-Max, Van

| | | | | |
|----------|----|---------|---|------|
| 1.5 TDCi | 55 | 10/12 → | D | UGJC |
| 1.6 TDCi | 70 | 10/12 → | D | T3JB |

C-Max I

| | | | | |
|----------|----|---------------|---|-------------|
| 1.6 TDCi | 74 | 02/07 → 09/10 | D | G8DC, MTD A |
|----------|----|---------------|---|-------------|

Ecosport II

| | | | | |
|----------|----|---------|---|------|
| 1.5 TDCi | 66 | 10/13 → | D | UGJE |
|----------|----|---------|---|------|

Fiesta V, Van

| | | | | |
|----------|----|---------------|---|------------|
| 1.4 TDCi | 50 | 11/01 → 06/08 | D | F6JA, F6JB |
|----------|----|---------------|---|------------|

Fiesta VI, Van

| | | | | |
|----------|----|---------|---|------------------|
| 1.4 TDCi | 50 | 01/09 → | D | F6JB |
| | 51 | 07/10 → | D | F6JD, KVJA |
| 1.5 TDCi | 55 | 09/12 → | D | UGJC |
| 1.6 TDCi | 66 | 01/09 → | D | HHJC, HHJD, HHJE |
| | 70 | 02/10 → | D | T3JA, TZJA, TZJB |

Focus II, Station Wagon, Cabrio

| | | | | |
|----------|----|---------------|---|-------------|
| 1.6 TDCi | 74 | 07/04 → 09/12 | D | G8DC, MTD A |
| | 81 | 12/07 → 09/12 | D | G8DA |

Focus III, Station Wagon, Van

| | | | | |
|-------------------|----|---------|---|------------|
| 1.6 TDCi ECOnetic | 77 | 05/12 → | D | NGDA, NGDB |
|-------------------|----|---------|---|------------|

Fusion

| | | | | |
|----------|----|---------------|---|------------|
| 1.4 TDCi | 50 | 08/02 → 07/05 | D | F6JA, F6JB |
|----------|----|---------------|---|------------|

Galaxy II

| | | | | |
|----------|----|---------------|---|------------|
| 1.6 TDCi | 85 | 02/11 → 06/15 | D | T1WA, T1WB |
|----------|----|---------------|---|------------|

Grand C-Max

| | | | | |
|----------|----|---------|---|------------|
| 1.6 TDCi | 70 | 12/10 → | D | T3DA, T3DB |
| | 85 | 12/10 → | D | T1DA, T1DB |

S-Max

| | | | | |
|----------|----|---------|---|------------|
| 1.6 TDCi | 85 | 02/11 → | D | T1WA, T1WB |
|----------|----|---------|---|------------|

Tourneo II Connect, Courier, Custom

| | | | | |
|----------|----|---------|---|------------|
| 1.6 TDCi | 55 | 09/13 → | D | UBGA |
| | 70 | 09/13 → | D | TZGA, TZGB |
| | 85 | 09/13 → | D | T1GA |

81798 350981798000

FORD
Transit Connect II, Courier

| | | | | |
|----------|----|---------|---|------------|
| 1.6 TDCi | 55 | 02/13 → | D | UBGA |
| | 70 | 02/13 → | D | TZGA, TZGB |
| | 85 | 02/13 → | D | T1GA |

MAZDA
2 I

| | | | | |
|--------|----|---------|---|------------|
| 1.4 CD | 50 | 04/03 → | D | F6JA, F6JB |
|--------|----|---------|---|------------|

2 II, Saloon

| | | | | |
|------------|----|---------------|---|------|
| 1.4 MZR-CD | 50 | 01/08 → 06/15 | D | Y404 |
|------------|----|---------------|---|------|

PEUGEOT
107

| | | | | |
|---------|----|---------|---|-------------|
| 1.4 HDi | 40 | 06/05 → | D | 8HT (DV4TD) |
|---------|----|---------|---|-------------|

205 II, Van

| | | | | |
|----------------|----|---------------|---|--------------------------|
| 1.4 HDi | 51 | 09/02 → 02/07 | D | 8HX (DV4TD) |
| 1.4 HDi eco 70 | 50 | 09/01 → | D | 8HX (DV4TD), 8HZ (DV4TD) |

206 +

| | | | | |
|----------------|----|---------|---|--------------------------|
| 1.4 HDi eco 70 | 50 | 01/09 → | D | 8HX (DV4TD), 8HZ (DV4TD) |
|----------------|----|---------|---|--------------------------|

206, CC, Van

| | | | | |
|----------------|----|---------------|---|--------------------------|
| 1.4 HDi | 50 | 07/02 → | D | 8HX (DV4TD) |
| | 50 | 09/01 → 03/09 | D | 8HX (DV4TD), 8HZ (DV4TD) |
| 1.4 HDi eco 70 | 50 | 09/08 → | D | 8HZ (DV4TD) |

207, Station Wagon, CC, Van

| | | | | |
|---------|----|---------|---|-------------------------|
| 1.4 HDi | 50 | 02/06 → | D | 8HR (DV4C), 8HZ (DV4TD) |
| | 50 | 04/07 → | D | 8HZ (DV4TD) |

208

| | | | | |
|---------|----|---------|---|------------------------|
| 1.4 HDi | 50 | 03/12 → | D | 8HP (DV4C), 8HR (DV4C) |
|---------|----|---------|---|------------------------|

307, Station Wagon, CC

| | | | | |
|---------|----|---------|---|--------------------------|
| 1.4 HDi | 50 | 10/01 → | D | 8HX (DV4TD), 8HZ (DV4TD) |
| | 50 | 03/02 → | D | 8HZ (DV4TD) |

1007

| | | | | |
|---------|----|---------|---|--------------------------|
| 1.4 HDi | 50 | 04/05 → | D | 8HX (DV4TD), 8HZ (DV4TD) |
|---------|----|---------|---|--------------------------|

2008

| | | | | |
|---------|----|---------|---|------------|
| 1.4 HDi | 50 | 06/13 → | D | 8HR (DV4C) |
|---------|----|---------|---|------------|

Bipper, Tepee

| | | | | |
|---------|----|---------|---|--------------|
| 1.4 HDi | 50 | 02/08 → | D | 8HS (DV4TED) |
|---------|----|---------|---|--------------|

81798 350981798000



SUZUKI

Liana

1.4 DDiS 66 04/04 → D 8HY

TOYOTA

Aygo I

1.4 HDi 40 07/05 → 08/10 D 2WZ-TV

81799 350981799000



PULEGGIA

Diametro Puleggia Ø59.85
 Numero Denti/Gole Puleggia 20
 Altezza Puleggia 32.3
 Posizione Attacco 62
 Diametro Girante Ø61.5
 N° Alette Girante 8
 Posizione Girante 22.2



CITROËN

C 4 I, Coupé, Picasso, Grand Picasso

1.8 Bifuel 92 01/09 → 10/12 BF 6FY (EW7A)

1.8 i 16V 92 10/06 → B 6FY (EW7A)

2.0 16V 100 11/04 → 07/07 B RFN(EW10J4)

2.0 16V 103 11/04 → 07/11 B RFJ(EW10A)

2.0 16V 130 11/04 → 12/10 B RFK (EW10J4S)

2.0 i 16V 103 10/06 → B RFJ(EW10A)

C 5 I, Break

1.8 16V 85 03/01 → 08/04 B 6FZ(EW7J4)

2.0 16V 100 03/01 → 08/04 B RFN(EW10J4)

2.0 16V HPi 103 03/01 → 08/04 B RLZ(EW10D)

C 5 II, Break

1.8 16V 92 09/05 → B 6FY (EW7A)

1.8 16V 85 09/04 → B 6FZ(EW7J4)

2.0 16V 103 09/04 → B RFJ(EW10A)

C 5 III, Break

1.8 16V 92 02/08 → B 6FY (EW7A)

2.0 16V 103 02/08 → B RFJ(EW10A)

2.0 16V BioFlex 103 02/08 → RFJ(EW10A)

C 8

2.0 100 07/02 → B RFN(EW10J4)

2.0 16V 103 09/05 → B RFJ(EW10A)

2.0 16V 104 09/05 → B RFJ(EW10A)

2.2 116 07/02 → B 3FZ(EW12J4)

81799 350981799000



CITROËN

Evasion

2.0 16V 100 05/00 → 07/02 B RFN(EW10J4)

Jumpy I

2.0 100 04/00 → 12/06 B RFN(EW10J4)

2.0 i 16V 102 03/00 → B RFN(EW10J4)

Jumpy II

2.0 100 12/03 → 10/06 B RFN(EW10J4)

Jumpy III

2.0 i 103 01/07 → B RFH(EW10A)

Xsara, Break, Coupé, Picasso, Van

1.8 16V 85 02/00 → B 6FZ(EW7J4)

1.8 VTS 85 09/00 → 10/04 B 6FZ(EW7J4)

2.0 16V 100 09/00 → 03/05 B RFN(EW10J4)

FIAT

Scudo I

2.0 100 05/00 → 12/06 B RFN(EW10J4)

2.0 16V 100 06/00 → 12/06 B RFN(EW10J4)

Ulysse II

2.0 100 08/02 → 06/11 B RFN(EW10J4)

LANCIA

Phedra

2.0 100 09/02 → 11/10 B RFN(EW10J4)

Zeta

2.0 16V 100 07/00 → 09/02 B RFN

PEUGEOT

205 II, Van

2.0 RC 130 07/03 → B RFK (EW10J4S)

2.0 S16 99 04/99 → 10/00 B RFR (DEW10J4)

2.0 S16 100 06/99 → B RFN(EW10J4)

206, CC, Van

2.0 16V 100 07/02 → B RFN(EW10J4)

2.0 S16 100 09/00 → B RFN(EW10J4)

307, Station Wagon, CC

2.0 100 03/02 → B RFN(EW10J4)

2.0 105 08/08 → B RFN (EW10J4)

2.0 100 08/00 → B RFN (EW10J4)

2.0 103 03/05 → B RFJ(EW10A) M: EW10J4

2.0 16V 103 03/05 → B RFJ(EW10A)

2.0 16V 103 03/05 → B RFJ(EW10A), RFN(EW10J4)

2.0 16V 130 06/05 → B RFK (EW10J4S)

81799
350981799000

KW

PEUGEOT
407, Station Wagon, Coupé

| | | | | | |
|-------------|-----|---------------|---|--------------------------------|-----------|
| 1.8 | 85 | 05/04 → | B | 6FZ (EW7J4) | |
| 1.8 16V | 92 | 09/05 → | B | 6FY (EW7A) | |
| 2.0 | 100 | 05/04 → | B | RFN (EW10J4) | |
| 2.0 16V | 99 | 01/99 → 08/00 | B | RFR (DEW10J4) | |
| | 100 | 08/00 → 06/04 | B | RFN (EW10J4) | |
| 2.0 16V | 100 | 10/00 → 12/04 | B | RFN (EW10J4), RFV (XU10J4R) | |
| | 103 | 09/05 → | B | RFJ (EW10A) | |
| 2.0 16V | 97 | 11/95 → 05/04 | B | RFV (XU10J4R) | 04-1999 → |
| 2.0 16V HPI | 103 | 05/01 → 05/04 | B | RLZ (EW10D) | |
| 2.0 Bioflex | 103 | 09/07 → | | RFJ (EW10A) | |
| 2.2 | 116 | 07/00 → 05/04 | B | 3FZ (EW12J4) | |
| 2.2 16V | 120 | 09/05 → | B | 3FY (EW12J4) | |

607

| | | | | | |
|---------|-----|---------|---|--------------|--|
| 2.0 | 100 | 02/00 → | B | RFN (EW10J4) | |
| 2.2 16V | 116 | 02/00 → | B | 3FZ (EW12J4) | |
| | 120 | 09/05 → | B | 3FY (EW12J4) | |

806

| | | | | | |
|---------|-----|---------------|---|--------------|--|
| 2.0 16V | 100 | 09/00 → 08/02 | B | RFN (EW10J4) | |
|---------|-----|---------------|---|--------------|--|

807

| | | | | | |
|---------|-----|---------|---|--------------|--|
| 2.0 | 100 | 06/02 → | B | RFN (EW10J4) | |
| 2.0 16V | 103 | 09/05 → | B | RFJ (EW10A) | |
| 2.2 | 116 | 06/02 → | B | 3FZ (EW12J4) | |

Expert I

| | | | | | |
|-----|-----|---------|---|--------------|--|
| 2.0 | 100 | 07/00 → | B | RFN (EW10J4) | |
|-----|-----|---------|---|--------------|--|

Expert II, Tepee

| | | | | | |
|---------|-----|---------|---|-----------------------------|--|
| 2.0 16V | 103 | 01/07 → | B | RFH (EW10A), RFJ (EW10A) | |
|---------|-----|---------|---|-----------------------------|--|

81800
350981800000

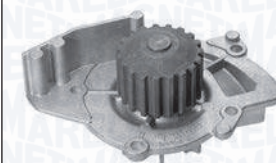
KW

PULEGGIA

| | |
|----------------------------|------|
| Diametro Puleggia | Ø56 |
| Numero Denti/Gole Puleggia | 19 |
| Altezza Puleggia | 33.5 |
| Posizione Attacco | 42.3 |
| Diametro Girante | Ø74 |
| N° Alette Girante | 8 |
| Posizione Girante | 34.2 |

CITROËN
C 4 I, Coupé, Picasso, Grand Picasso

| | | | | | |
|-------------|-----|---------------|---|-------------------------------------|--|
| 2.0 HDi | 100 | 11/04 → 12/10 | D | RHR (DW10BTED4) | |
| | 103 | 07/08 → 07/11 | D | RHF (DW10BTED4) | |
| 2.0 HDi 138 | 100 | 10/06 → | D | RHJ (DW10BTED4), RHR (DW10BTED4) | |

C 5 I, Break

| | | | | | |
|---------|----|---------------|---|------------------------|--|
| 2.2 HDi | 98 | 03/01 → 08/04 | D | 4HX (DW12TED4/ FAP) | |
|---------|----|---------------|---|------------------------|--|

C 5 II, Break

| | | | | | |
|---------|-----|---------|---|------------------------|--|
| 2.0 HDi | 100 | 09/04 → | D | RHR (DW10BTED4) | |
| 2.2 HDi | 98 | 09/04 → | D | 4HX (DW12TED4/ FAP) | |

C 5 III, Break

| | | | | | |
|-------------|-----|---------|---|-------------------------------------|--|
| 2.0 HDi | 100 | 02/08 → | D | RHF (DW10BTED4), RHR (DW10BTED4) | |
| | 100 | 02/08 → | D | RHR (DW10BTED4) | |
| 2.0 HDi 140 | 103 | 04/09 → | D | RHF (DW10BTED4) | |
| 2.0 HDi 165 | 120 | 04/09 → | D | RHH (DW10CTED4) | |

C 8

| | | | | | |
|---------|----|---------|---|-----------------|--|
| 2.0 HDi | 80 | 07/02 → | D | RHW (DW10ATED4) | |
| | 88 | 02/07 → | D | RHK (DW10UTED4) | |

81800
35098180000

CITROËN
C 8

| | | | | |
|-------------|-----|---------|---|---|
| 2.0 HDi 135 | 100 | 03/06 → | D | RHD (DW10CB), RHD (DW10CTED4), RHR (DW10BTED4) |
|-------------|-----|---------|---|---|

| | | | | |
|-------------|-----|---------|---|---|
| 2.0 HDi 165 | 120 | 03/06 → | D | RHE (DW10CTED4), RHH (DW10CTED4) |
|-------------|-----|---------|---|---|

| | | | | |
|---------|----|---------|---|-------------------|
| 2.2 HDi | 94 | 07/02 → | D | 4HW (DW12TED4) |
|---------|----|---------|---|-------------------|

Jumper II

| | | | | |
|---------|----|---------|---|-------------------|
| 2.2 HDi | 74 | 04/02 → | D | 4HY (DW12UTED) |
|---------|----|---------|---|-------------------|

Jumpy III

| | | | | |
|-------------|----|---------|---|--------------------|
| 2.0 HDi 120 | 88 | 01/07 → | D | RHK (DW10UTED4) |
|-------------|----|---------|---|--------------------|

| | | | | |
|-------------|-----|---------|---|--------------------|
| 2.0 HDi 140 | 100 | 01/07 → | D | RHR (DW10BTED4) |
|-------------|-----|---------|---|--------------------|

FIAT
Scudo II

| | | | | |
|-------------------|----|---------|---|-----|
| 2.0 D Multijet | 88 | 01/07 → | D | RHK |
|-------------------|----|---------|---|-----|

| | | | |
|-----|---------|---|-------------------|
| 100 | 01/07 → | D | DW10BTED4, RHR |
|-----|---------|---|-------------------|

| | | | |
|-----|---------|---|-----|
| 100 | 01/07 → | D | RHR |
|-----|---------|---|-----|

| | | | | |
|-----------------------|----|---------|---|-----|
| 2.0 D Multijet 4x4 | 88 | 01/07 → | D | RHK |
|-----------------------|----|---------|---|-----|

Ulysse II

| | | | | |
|-------------------|----|---------------|---|-----|
| 2.0 D Multijet | 88 | 05/06 → 06/11 | D | RHK |
|-------------------|----|---------------|---|-----|

| | | | |
|-----|---------------|---|-----|
| 100 | 05/06 → 06/11 | D | RHR |
|-----|---------------|---|-----|

| | | | | |
|---------|----|---------------|---|--------------------|
| 2.2 JTD | 94 | 08/02 → 08/06 | D | 4HW (DW12ATED4) |
|---------|----|---------------|---|--------------------|

FORD
C-Max I

| | | | | |
|----------|----|---------------|---|------|
| 2.0 TDCi | 81 | 02/08 → 09/10 | D | IXDA |
|----------|----|---------------|---|------|

| | | | |
|----|---------------|---|---------------------|
| 98 | 02/07 → 09/10 | D | G6DC, G6DE, G6DF |
|----|---------------|---|---------------------|

| | | | |
|-----|---------------|---|---------------------------|
| 100 | 02/07 → 09/10 | D | G6DA, G6DB, G6DD, G6DG |
|-----|---------------|---|---------------------------|

Focus C-Max

| | | | | |
|----------|----|---------------|---|---------------------|
| 2.0 TDCi | 98 | 10/03 → 03/07 | D | G6DC, G6DE, G6DF |
|----------|----|---------------|---|---------------------|

| | | | |
|-----|---------------|---|---------------------------|
| 100 | 10/03 → 03/07 | D | G6DA, G6DB, G6DD, G6DG |
|-----|---------------|---|---------------------------|

81800
35098180000

CITROËN
Focus II, Station Wagon, Cabrio

| | | | | |
|----------|----|---------------|---|------|
| 2.0 TDCi | 81 | 02/08 → 07/11 | D | IXDA |
|----------|----|---------------|---|------|

| | | | |
|----|---------------|---|------------|
| 98 | 07/04 → 01/08 | D | G6DE, G6DF |
|----|---------------|---|------------|

| | | | |
|-----|---------------|---|---------------------|
| 100 | 07/04 → 09/12 | D | G6DA, G6DB, G6DD |
|-----|---------------|---|---------------------|

Galaxy II

| | | | | |
|----------|----|---------------|---|------------|
| 2.0 TDCi | 85 | 11/07 → 06/15 | D | KLWA, TYWA |
|----------|----|---------------|---|------------|

| | | | |
|----|---------------|---|------|
| 96 | 05/06 → 06/15 | D | AZWA |
|----|---------------|---|------|

| | | | |
|-----|---------------|---|----------------------|
| 100 | 05/06 → 06/15 | D | AZWC, UKWA → 05-2009 |
|-----|---------------|---|----------------------|

| | | | |
|-----|---------------|---|---------------------------|
| 103 | 05/06 → 06/15 | D | QXWA, QXWB, QXWC, UFWA |
|-----|---------------|---|---------------------------|

Kuga I

| | | | | |
|----------|-----|---------------|---|------------|
| 2.0 TDCi | 100 | 03/08 → 11/12 | D | G6DG, UKDA |
|----------|-----|---------------|---|------------|

| | | | | |
|-----------------|-----|---------------|---|------------|
| 2.0 TDCi 4x4 | 100 | 03/08 → 11/12 | D | G6DG, UKDA |
|-----------------|-----|---------------|---|------------|

Mondeo IV, Station Wagon

| | | | | |
|----------|----|---------------|---|---------------------|
| 2.0 TDCi | 85 | 11/07 → 09/14 | D | KLBA, LPBA, TYBA |
|----------|----|---------------|---|---------------------|

| | | | |
|----|---------------|---|------|
| 96 | 03/07 → 09/14 | D | AZBA |
|----|---------------|---|------|

| | | | |
|-----|---------------|---|---------------------|
| 100 | 03/07 → 09/14 | D | AZBC, UKBA, UKBB |
|-----|---------------|---|---------------------|

| | | | |
|-----|---------------|---|---------------------------|
| 103 | 03/07 → 09/14 | D | QXBA, QXBB, UFBA, UFBB |
|-----|---------------|---|---------------------------|

S-Max

| | | | | |
|----------|----|---------|---|------------|
| 2.0 TDCi | 85 | 11/07 → | D | KLWA, TYWA |
|----------|----|---------|---|------------|

| | | | |
|----|---------|---|------|
| 96 | 05/06 → | D | AZWA |
|----|---------|---|------|

| | | | |
|-----|---------|---|------------|
| 100 | 05/06 → | D | AZWC, UKWA |
|-----|---------|---|------------|

| | | | |
|-----|---------|---|---------------------------|
| 103 | 05/06 → | D | QXWA, QXWB, QXWC, UFWA |
|-----|---------|---|---------------------------|

LANCIA
Phedra

| | | | | |
|----------------|-----|---------------|---|--------------------|
| 2.0 D Multijet | 100 | 07/06 → 11/10 | D | RHR (DW10BTED4) |
|----------------|-----|---------------|---|--------------------|

| | | | | |
|---------|----|---------------|---|--------------------|
| 2.0 JTD | 88 | 06/06 → 11/10 | D | RHK (DW10UTED4) |
|---------|----|---------------|---|--------------------|

| | | | | |
|---------|----|---------------|---|--------------------|
| 2.2 JTD | 94 | 09/02 → 11/10 | D | 4HW (DW12ATED4) |
|---------|----|---------------|---|--------------------|

PEUGEOT
307, Station Wagon, CC

| | | | | |
|-------------|-----|---------|---|--------------------|
| 2.0 HDi 135 | 100 | 10/03 → | D | RHR (DW10BTED4) |
|-------------|-----|---------|---|--------------------|

81800 35098180000

PEUGEOT
308 I, Station Wagon, CC

| | | | | |
|---------|-----|---------|---|--------------------|
| 2.0 HDi | 100 | 09/07 → | D | RHR (DW10BTED4) |
| | 103 | 04/09 → | D | RHF (DW10BTED4) |
| | 103 | 07/10 → | D | RHR (DW10BTED4) |

407, Station Wagon, Coupé

| | | | | |
|-------------|-----|---------------|---|---------------------------|
| 2.0 HDi | 100 | 10/05 → | D | RHR (DW10BTED4) |
| | 103 | 08/08 → | D | RHF (DW10BTED4) |
| | 103 | 08/08 → | D | RHR (DW10BTED4) |
| | 110 | 02/10 → | D | RHE (DW10CTED4) |
| | 120 | 07/09 → | D | RHH (DW10CTED4) |
| 2.0 HDi 135 | 100 | 05/04 → | D | RHR (DW10BTED4) |
| 2.2 HDi | 98 | 03/00 → 05/04 | D | 4HX (DW12TED4/ FAP) |

508, Station Wagon

| | | | | |
|---------|-----|---------|---|--------------------|
| 2.0 HDi | 100 | 11/10 → | D | RHR (DW10BTED4) |
|---------|-----|---------|---|--------------------|

607

| | | | | |
|---------|-----|---------|---|---------------------------|
| 2.0 HDi | 100 | 09/05 → | D | RHR (DW10BTED4) |
| 2.2 HDi | 98 | 02/00 → | D | 4HX (DW12TED4/ FAP) |

807

| | | | | |
|---------|-----|---------------|---|--|
| 2.0 HDi | 80 | 04/04 → 05/06 | D | RHW (DW10ATED4) |
| | 88 | 02/06 → | D | RHK (DW10UTED4) |
| | 100 | 06/06 → | D | RHR (DW10BTED4) |
| 2.2 HDi | 94 | 06/02 → | D | 4HW (DW12BTED4), 4HX (DW12TED4/ FAP) |

81800 35098180000

PEUGEOT
Boxer II

| | | | | |
|---------|----|---------|---|-------------------|
| 2.2 HDi | 74 | 04/02 → | D | 4HY (DW12UTED) |
|---------|----|---------|---|-------------------|

Expert I

| | | | | |
|---------|----|---------|---|---|
| 2.0 HDi | 69 | 07/00 → | D | RHX (DW10BTED) |
| | 80 | 07/00 → | D | RHW (DW10ATED4) |
| | 80 | 07/00 → | D | RHZ (DW10ATED), RHZ (DW10BTED), RHZ (DW10CTED) |

Expert II, Tepee

| | | | | |
|-------------|-----|---------|---|--------------------|
| 2.0 HDi 120 | 88 | 01/07 → | D | RHK (DW10UTED4) |
| 2.0 HDi 140 | 100 | 01/07 → | D | RHR (DW10BTED4) |

Partner I

| | | | | |
|-------------|----|---------------|---|-----------------|
| 2.0 HDi 4x4 | 66 | 04/04 → 08/05 | D | RHY (DW10TD) |
|-------------|----|---------------|---|-----------------|

VOLVO
C 30

| | | | | |
|-------|-----|---------------|---|--------|
| 2.0 D | 100 | 10/06 → 12/12 | D | D4204T |
|-------|-----|---------------|---|--------|

C 70 II

| | | | | |
|-------|-----|---------------|---|--------|
| 2.0 D | 100 | 01/08 → 10/09 | D | D4204T |
|-------|-----|---------------|---|--------|

S 40 II

| | | | | |
|--------|-----|---------|---|---------|
| 2.0 D | 100 | 01/04 → | D | D4204T |
| 2.0 D4 | 96 | 07/05 → | D | D4204T2 |

S 80 II

| | | | | |
|---------|-----|---------|---|--------|
| 2.0 TDi | 100 | 02/08 → | D | D4204T |
|---------|-----|---------|---|--------|

V 50

| | | | | |
|-------|-----|---------|---|--------|
| 2.0 D | 100 | 04/04 → | D | D4204T |
|-------|-----|---------|---|--------|

V 70 III

| | | | | |
|-------|-----|---------|---|--------|
| 2.0 D | 100 | 10/07 → | D | D4204T |
|-------|-----|---------|---|--------|

81801
350981801000

PULEGGIA

Diametro Puleggia Ø59.27
 Numero Denti/Gole Puleggia 20
 Altezza Puleggia 16
 Posizione Attacco 46.5
 Diametro Girante Ø63
 N° Alette Girante 8
 Posizione Girante 34

KW

AUTOBIANCHI
Y10

| | | | | |
|---------------|----|---------------|---|-----------|
| 1.0 | 33 | 03/85 → 10/95 | B | 156A2.000 |
| 1.0 4WD | 37 | 12/86 → 10/95 | B | 156A3.000 |
| 1.0 Cat. | 33 | 10/87 → 10/95 | B | 156A2.246 |
| 1.1 | 42 | 06/89 → 10/95 | B | 156C.000 |
| 1.1 4WD | 42 | 06/89 → 10/95 | B | 156C.000 |
| 1.1 i.e. Cat. | 42 | 09/90 → 10/95 | B | 156C.046 |

FIAT
Punto I, Cabrio, Van

| | | | | |
|--------|----|---------------|---|-------------------------|
| 55 1.1 | 40 | 09/93 → 09/99 | B | 176A6.000, 176B2.000 |
| 75 1.2 | 54 | 10/93 → 09/99 | B | 176A8.000 |

Cinquecento

| | | | | |
|--------------|----|---------------|---|-----------|
| 1.1 Sporting | 40 | 10/94 → 01/98 | B | 176B2.000 |
|--------------|----|---------------|---|-----------|

Palio I, Weekend

| | | | | | |
|-----|----|---------------|---|---------------------------------------|----------------|
| 1.2 | 50 | 06/99 → 10/00 | B | 178E2.000 | → M: 9.042.882 |
| | 54 | 06/98 → | B | 176A8.000, 178B5.000, 178E2.000 | → M: 9.042.882 |
| | 54 | 04/96 → 02/01 | B | 178B5.000 | → M: 9.042.882 |

Panda I, Van

| | | | | |
|----------------|----|---------------|---|-------------------------|
| 1.1 | 37 | 05/91 → 03/95 | B | 156C.046 |
| | 32 | 01/86 → 04/92 | B | 156A2.100 |
| | 32 | 01/86 → 02/92 | B | 156A2.100, 156A3.100 |
| 1000 | 37 | 01/85 → 12/92 | B | 156A3.000 |
| | 33 | 05/86 → 12/94 | B | 141C2.000, 156A2.246 |
| 1000 4x4 | 37 | 01/86 → 12/92 | B | 156A3.000 |
| | 33 | 08/92 → 02/04 | B | 156A2.246 |
| 1000 i.e. | 33 | 08/92 → 02/04 | B | 156A2.246 |
| 1000 i.e. Cat. | 33 | 10/87 → 08/98 | B | 141C2.000, 156A2.246 |
| | 37 | 05/91 → 12/99 | B | 156C.046 |
| 1100 | 40 | 02/95 → 09/03 | B | 176B2.000, 187A1.000 |
| | 40 | 02/95 → 07/04 | B | 176B2.000 |

81801
350981801000

KW

FIAT
Panda I, Van

| | | | | |
|----------------------|----|---------------|---|--------------------------------------|
| 1100 Trekking 4x4 | 37 | 10/91 → 07/04 | B | 156C.046 |
| 750 | 25 | 01/86 → 10/03 | B | 141B.000, 156A4.000, 156A4.048 |

Punto I, Cabrio, Van

| | | | | |
|--------|----|---------------|---|-------------------------|
| 1.1 | 40 | 04/96 → 02/00 | B | 176B2.000 |
| | 43 | 04/94 → 06/00 | B | 176A7.000 |
| 60 1.2 | 44 | 05/95 → 06/00 | B | 176B1.000, 176B4.000 |

Seicento, Van

| | | | | | |
|-----|----|---------------|---|-------------------------|------------------------------|
| 1.1 | 40 | 01/98 → 01/10 | B | 176B2.000 | → 04-1999, → M: 9.042.882 |
| | 40 | 01/98 → 01/10 | B | 176B2.000, 187A1.000 | → 04-1999, → M: 9.042.882 |

Siena I

| | | | | | |
|-----|----|---------------|---|-----------|-----------|
| 1.2 | 54 | 09/98 → 12/09 | B | 178B5.000 | → 06-1999 |
|-----|----|---------------|---|-----------|-----------|

Strada

| | | | | |
|-----|----|---------|---|-----------|
| 1.2 | 54 | 06/99 → | B | 178B5.000 |
|-----|----|---------|---|-----------|

Tipo I

| | | | | |
|-----|----|---------------|---|-----------|
| 1.1 | 41 | 01/88 → 10/91 | B | 160A3.000 |
|-----|----|---------------|---|-----------|

Uno I

| | | | | | |
|-------------|----|---------------|---|-------------------------|-------------------------|
| 1.0 | 31 | 06/89 → 02/92 | B | 156A2.000 | |
| 1.0 iE | 34 | 05/98 → 08/00 | B | 156A2.246 | |
| 45 1.0 | 32 | 06/86 → 12/93 | B | 156A2.048, 156A2.100 | |
| 45 i.e. 1.0 | 33 | 04/84 → 10/95 | B | 156A2.246 | |
| 50 1.1 | 37 | 01/90 → 12/93 | B | 156C.046 | 01-1989 →, → 12-1991 |
| 50 i.e. 1.1 | 36 | 06/92 → 12/93 | B | 146C3.000 | |
| 60 1.1 | 42 | 04/89 → 12/92 | B | 160A3.000 | |

LANCIA
Y10

| | | | | |
|-----------------------------------|----|---------------|---|-------------------------|
| 1.0 Fire | 37 | 03/85 → 02/90 | B | 156A2.000 |
| | 32 | 06/85 → 06/91 | B | 156A2.100 |
| | 33 | 03/85 → 02/92 | B | 156A2.000, 156A2.246 |
| 1.0 Fire Trazione integrale | 37 | 12/87 → 02/90 | B | 156A2.000 |
| | 33 | 12/87 → 02/92 | B | 156A2.000, 156A2.246 |
| 1.1 Fire | 40 | 01/95 → 12/95 | B | 176B2.000 |
| 1.1 Fire Trazione integrale | 40 | 01/95 → 12/95 | B | 176B2.000 |

81801 350981801000

LANCIA
Y10

| | | | | | |
|-------------------------------------|----|---------------|---|----------|--|
| 1.1 i.e Fire | 42 | 08/89 → 06/92 | B | 156C.000 | |
| 1.1 i.e Fire Trazione integrale | 42 | 08/89 → 06/92 | B | 156C.000 | |
| 1.1 i.e. Fire | 37 | 07/89 → 09/95 | B | 156C.046 | |
| 1.1 i.e. Fire Trazione integrale | 37 | 09/92 → 12/95 | B | 156C.046 | |

Y

| | | | | | |
|-----|----|---------------|---|-------------------------|-----------|
| 1.1 | 40 | 11/95 → 09/03 | B | 176B2.000 | |
| 1.2 | 44 | 03/96 → 09/03 | B | 188A4.000, 840A3.000 | → 08-2000 |

81802 350981802000



FLANGIA

Numero Fori Flangia 4

Dimensione Fori Flangia M8×1.25

Posizione Attacco 59.8

Diametro Centraggio Ø58

Diametro Girante Ø79

N° Alette Girante 6

Posizione Girante 28

FORD
C-Max I

| | | | | | |
|----------|----|---------------|---|------|--|
| 1.8 TDCi | 85 | 02/07 → 09/10 | D | KKDA | |
|----------|----|---------------|---|------|--|

Fiesta IV, Van

| | | | | | |
|--------|----|---------------|---|------------------|--|
| 1.8 DI | 55 | 09/00 → 08/03 | D | RTN, RTP | |
| | 55 | 04/00 → 01/02 | D | RTN, RTP, RTQ | |
| TD 1.8 | 55 | 03/00 → 08/03 | D | RTN, RTP, RTQ | |

Focus C-Max

| | | | | | |
|----------|----|---------------|---|------|--|
| 1.8 TDCi | 85 | 01/05 → 03/07 | D | KKDA | |
|----------|----|---------------|---|------|--|

Focus I, Station Wagon

| | | | | | |
|------------------------|----|---------------|---|---------------------|--|
| 1.8 DI / TDDi | 55 | 08/99 → 11/04 | D | BHDA, BHDB | |
| 1.8 TDCi | 74 | 08/02 → 11/04 | D | FFDA | |
| | 85 | 03/01 → 11/04 | D | F9DA, F9DB | |
| 1.8 Turbo DI / TDDi | 55 | 08/01 → 03/05 | D | BHDA, BHDB | |
| | 66 | 10/98 → 11/04 | D | C9DA, C9DB, C9DC | |

Focus II, Station Wagon, Cabrio

| | | | | | |
|----------|----|---------------|---|------------|--|
| 1.8 TDCi | 85 | 01/05 → 09/12 | D | KKDA, KKDB | |
|----------|----|---------------|---|------------|--|

81802 350981802000

FORD
Galaxy II

| | | | | | |
|----------|----|---------------|---|------|--|
| 1.8 TDCi | 74 | 05/06 → 06/15 | D | FFWA | |
| | 92 | 05/06 → 06/15 | D | QYWA | |

Mondeo IV, Station Wagon

| | | | | | |
|----------|----|---------------|---|------------|--|
| 1.8 TDCi | 74 | 03/07 → 09/14 | D | FFBA | |
| | 92 | 06/07 → | D | KHBA, QYBA | |

S-Max

| | | | | | |
|----------|----|---------|---|------|--|
| 1.8 TDCi | 74 | 01/07 → | D | FFWA | |
| | 92 | 05/06 → | D | QYWA | |

Tourneo I Connect, Grand Tourneo Connect

| | | | | | |
|-------------------------|----|---------------|---|--|--|
| 1.8 TDCi | 66 | 06/02 → 12/13 | D | HCPA, HCPB, P9PA, P9PB, P9PC, P9PD, R3PA, RWPE, RWPF | |
| | 81 | 08/06 → 12/13 | D | RWPA, RWPC, RWPD | |
| 1.8 TDCi / TDDi / DI | 55 | 06/02 → 12/13 | D | BHPA, P7PA, P7PB, R2PA | |

Transit Connect I

| | | | | | |
|----------|----|---------------|---|--|--|
| 1.8 Di | 55 | 06/02 → 12/13 | D | BHPA, P7PA, P7PB, R2PA | |
| 1.8 TDCi | 66 | 06/02 → 12/13 | D | HCPA, HCPB, P9PA, P9PB, P9PC, P9PD, R3PA, RWPE, RWPF | |
| | 81 | 08/06 → 12/13 | D | RWPA, RWPC, RWPD | |

81803 350981803000



FLANGIA

Numero Fori Flangia 3

Dimensione Fori Flangia M8×1.25

Posizione Attacco 40.25

Diametro Mozzo Ø23.4

Diametro Girante Ø70

N° Alette Girante 6

Posizione Girante 40.4

FORD
Cougar

| | | | | | |
|---------|----|---------------|---|---------------------------|--|
| 2.0 16V | 96 | 08/98 → 12/01 | B | EDBA, EDBB, EDBC, EDBD | |
|---------|----|---------------|---|---------------------------|--|

Escort Classic

| | | | | | |
|---------|----|---------------|---|-----|--|
| 1.6 16V | 66 | 10/98 → 07/00 | B | L1E | |
|---------|----|---------------|---|-----|--|

81803
350981803000

FORD
Focus I, Station Wagon

| | | | | |
|------------|-----|---------------|----|--|
| 1.8 16V | 85 | 10/98 → 11/04 | B | EYDB, EYDC, EYDD, EYDE, EYDF, EYDG, EYDI, EYDJ, EYDL |
| 1.8 BiFuel | 82 | 02/03 → 01/05 | BF | |
| 2.0 16V | 96 | 10/98 → 11/04 | B | EDDB, EDDC, EDDD, EDDF |
| RS | 158 | 10/02 → 11/04 | B | HMDA |
| ST170 | 127 | 03/02 → 11/04 | B | ALDA |

Tourneo I Connect, Grand Tourneo Connect

| | | | | |
|---------|----|---------------|---|------------------|
| 1.8 16V | 85 | 06/02 → 12/13 | B | EYPA, EYPC, EYPD |
|---------|----|---------------|---|------------------|

Transit Connect I

| | | | | |
|-------------|----|---------------|---|------------------|
| 1.8 16V | 85 | 06/02 → 12/13 | B | EYPA, EYPC, EYPD |
| 1.8 16V LPG | 85 | 06/02 → 12/13 | | EYPC |

MAZDA
Tribute

| | | | | |
|---------|----|---------------|---|----|
| 2.0 | 91 | 03/00 → 05/08 | B | YF |
| 2.0 4WD | 91 | 03/00 → 05/08 | B | YF |

81804
350981804000

FLANGIA

| | |
|-------------------------|---------|
| Numero Fori Flangia | 3 |
| Dimensione Fori Flangia | M8x1.25 |
| Posizione Attacco | 50.5 |
| Diametro Girante | Ø67 |
| N° Alette Girante | 6 |
| Posizione Girante | 43.4 |

FORD
C-Max I

| | | | | |
|---------------|-----|---------------|---|------------------------|
| 1.8 | 90 | 02/07 → 09/10 | B | QQDC |
| | 92 | 02/07 → 09/10 | B | QQDA, QQDB |
| 1.8 Flexifuel | 92 | 02/07 → 09/10 | | Q7DA |
| 2.0 | 107 | 02/07 → 09/10 | B | AODA, AODB, AODE, SYDA |
| 2.0 CNG | 107 | 04/09 → 09/10 | | SYDA |
| 2.0 LPG | 107 | 06/08 → 09/10 | | SYDA |

Fiesta V, Van

| | | | | |
|-------|-----|---------------|---|------|
| ST150 | 110 | 03/05 → 06/08 | B | N4JB |
|-------|-----|---------------|---|------|

81804
350981804000

FORD
Focus C-Max

| | | | | |
|---------------|-----|---------------|---|------------------|
| 1.8 | 88 | 10/03 → 03/07 | B | CSDA, CSDB |
| | 92 | 04/04 → 03/07 | B | Q7DA, QQDA, QQDB |
| 1.8 Flexifuel | 92 | 01/06 → 03/07 | | Q7DA |
| 2.0 | 107 | 03/04 → 03/07 | B | AODA, AODB, SYDA |

Focus II, Station Wagon, Cabrio

| | | | | |
|---------------|-----|---------------|---|------------------|
| 1.8 | 92 | 03/06 → 09/12 | B | Q7DA, QQDB |
| | 92 | 03/06 → 09/12 | B | QQDB |
| 1.8 Flexifuel | 92 | 01/06 → 09/12 | | Q7DA |
| | 96 | 12/05 → 01/08 | | QQDD |
| | 96 | 12/05 → 01/08 | | |
| 2.0 | 107 | 10/06 → 07/11 | B | AODA, AODB |
| | 107 | 07/04 → 09/12 | B | AODA, AODB, AODE |
| 2.0 CNG | 107 | 04/09 → 07/11 | | SYDA |
| 2.0 LPG | 107 | 06/08 → 07/11 | | SYDA |

Focus III, Station Wagon, Van

| | | | | |
|--------|-----|---------|---|------|
| 2.0 ST | 184 | 07/12 → | B | R9DA |
|--------|-----|---------|---|------|

Galaxy II

| | | | | |
|---------------|-----|---------------|---|------------|
| 2.0 | 107 | 05/06 → 06/15 | B | AOWA, AOWB |
| 2.0 EcoBoost | 149 | 03/10 → 06/15 | B | TNWA |
| 2.0 Flexifuel | 107 | 05/06 → 06/15 | | TBWA, TBWB |
| 2.3 | 118 | 09/07 → 06/15 | B | SEWA |

Galaxy III

| | | | | |
|--------------|-----|---------|---|------------|
| 2.0 EcoBoost | 176 | 01/15 → | B | R9CD, R9CI |
|--------------|-----|---------|---|------------|

Maverick II

| | | | | |
|---------|-----|---------|---|----|
| 2.3 16V | 110 | 03/04 → | B | GZ |
|---------|-----|---------|---|----|

Mondeo III, Station Wagon

| | | | | |
|---------|-----|---------------|---|------------|
| 1.8 16V | 81 | 10/00 → 03/07 | B | CGBA, CGBB |
| | 92 | 10/00 → 03/07 | B | CHBA, CHBB |
| 1.8 SCi | 96 | 06/03 → 03/07 | B | CFBA |
| 2.0 16V | 107 | 10/00 → 03/07 | B | CJBA, CJBB |

Mondeo IV, Station Wagon

| | | | | |
|---------------|-----|---------------|---|------------------|
| 2.0 | 107 | 03/07 → 09/14 | B | AOBA, AOBC, TBBA |
| 2.0 EcoBoost | 176 | 07/10 → 09/14 | B | TPBA |
| 2.0 Flexifuel | 107 | 03/09 → 09/14 | | TBBA, TBBB |
| 2.0 LPG | 107 | 07/09 → 09/14 | | TBBA |
| 2.0 SCTi | 149 | 03/10 → 09/14 | B | TNBA |

81804 **350981804000**

FORD
Mondeo IV, Station Wagon

2.3 118 07/07 → 09/14 B SEBA

Mondeo V, Station Wagon

| | | | | |
|-----------------|-----|---------|---|------------------|
| 2.0 EcoBoost | 146 | 05/15 → | B | TNCC |
| | 149 | 09/14 → | B | TNCD, TNCF |
| | 176 | 09/14 → | B | R9CB, R9CF, R9CH |

S-Max

| | | | | |
|-----------------|-----|---------|---------|------------|
| 2.0 EcoBoost | 107 | 05/06 → | B | AOWA, AOWB |
| | 146 | 07/10 → | B | TNWB |
| 2.0 EcoBoost | 149 | 03/10 → | B | TNWA |
| | 176 | 02/15 → | B | R9CD, R9CI |
| 2.0 Flexifuel | 107 | 05/06 → | | TBWA, TBWB |
| | 2.3 | 118 | 07/07 → | B SEWA |

LAND ROVER
Discovery Sport

2.0 4WD 177 12/14 → B 204PT

Freelander II

2.0 Si4 4x4 177 10/11 → 10/14 B 204PT

Range Rover Evoque, Cabrio

2.0 4x4 177 06/11 → B 204PT

MAZDA
3 I, Saloon

| | | | | |
|--------------------|-----|---------------|---------------|--------------|
| 2.0 | 110 | 10/03 → 06/09 | B | LF17 |
| | 2.3 | 118 | 03/04 → 03/09 | B L3-VE |
| | | 126 | 06/00 → 03/03 | B L3-VE |
| 2.3 DiSi Turbo MPS | 184 | 06/06 → 06/09 | B | L3YH |
| 2.3 MPS Turbo | 191 | 12/06 → 06/09 | B | L3-VDT, L3N9 |
| 2.3 MZR | 115 | 03/04 → 03/09 | B | L3-VE |
| 2.3 MZR Sport | 126 | 10/03 → 06/09 | B | L3YS, L3YT |

3 II, Saloon

| | | | | |
|---------------|-----|---------|---|--------------|
| 2.0 MZR | 110 | 06/09 → | B | LF-DE, LF17 |
| 2.0 MZR DISI | 111 | 06/09 → | B | LF5H, LF5W |
| 2.3 MPS Turbo | 191 | 06/09 → | B | L3-VDT, L3KG |

5 I

| | | | | |
|-----|-----|---------|---|------|
| 1.8 | 85 | 03/05 → | B | L823 |
| 2.0 | 107 | 03/05 → | B | FF7 |
| 2.3 | 122 | 02/05 → | B | |

81804 **350981804000**

MAZDA
5 II

| | | | | |
|---------|-----|---------|---------|--------|
| 1.8 MZR | 85 | 09/10 → | B | L850 |
| | 2.0 | 106 | 01/11 → | B LFZB |
| | | 110 | 09/10 → | B LF5H |

6 I, Hatchback, Station Wagon

| | | | | |
|---------------|-----|---------------|---|------------------|
| 1.8 | 88 | 08/02 → 08/07 | B | L813 |
| | 88 | 08/02 → 08/07 | B | L813, L823, L828 |
| 2.0 | 104 | 06/02 → 08/07 | B | LF17, LF18 |
| | 108 | 03/05 → 08/07 | B | FF7 |
| 2.3 | 122 | 06/02 → 08/07 | B | L3C1 |
| 2.3 AWD | 119 | 11/02 → 08/07 | B | L3C1 |
| 2.3 MPS Turbo | 191 | 12/05 → 08/07 | B | L3KG |
| 2.5 | 125 | 08/07 → | B | L5-VE |

6 II, Hatchback, Station Wagon

| | | | | |
|---------|-----|---------|---|-------|
| 1.8 MZR | 88 | 08/07 → | B | L813 |
| 2.0 MZR | 108 | 08/07 → | B | LF17 |
| | 114 | 01/10 → | B | LF-DE |
| 2.5 MZR | 125 | 08/07 → | B | L5-VE |

CX - 7

| | | | | |
|--------------------|-----|---------|---|--------|
| 2.3 MZR DISI Turbo | 190 | 10/07 → | B | L3-VDT |
| | 191 | 09/09 → | B | L3-VDT |

MPV

2.3 104 07/02 → 02/06 B L3

MX - 5 III

| | | | | |
|-----|-----|---------|---|-------------|
| 1.8 | 93 | 03/05 → | B | L8-DE, L828 |
| 2.0 | 118 | 09/08 → | B | LF-DE, LF62 |

Premacy

2.3 SVT 122 02/05 → 03/05 B L333

Tribute

| | | | | |
|---------|-----|---------------|---|-------|
| 2.3 AWD | 110 | 04/04 → 05/08 | B | L3-VE |
| 2.3 GX | 110 | 12/03 → 10/04 | B | L3-VE |

VOLVO
C 30

| | | | | |
|--------------|-----|---------------|---|----------|
| 1.8 | 92 | 10/06 → 12/12 | B | B4184S11 |
| 1.8 FlexFuel | 92 | 01/07 → 12/12 | | B4184S8 |
| 2.0 | 107 | 10/06 → 12/12 | B | B4204S3 |
| 2.0 FlexFuel | 107 | 01/10 → 12/12 | | B4204S4 |

S 40 II

| | | | | |
|-------|-----|---------|----|---------|
| 2.0 | 107 | 10/06 → | B | B4204S3 |
| 2.0 F | 107 | 10/09 → | FF | B4204S4 |

81804 350981804000



VOLVO

S 60 II

| | | | | |
|--------|-----|---------|---|---------|
| 2.0 T | 149 | 04/10 → | B | B4204T6 |
| T5 | 177 | 04/10 → | B | B4204T7 |
| T6 AWD | 224 | 04/10 → | B | B6304T4 |

S 80 II

| | | | | |
|--------------|-----|---------|---|---------|
| 2.0 | 107 | 01/08 → | B | B4204S3 |
| 2.0 FlexFuel | 107 | 01/08 → | | B4204S4 |
| 2.0 T | 149 | 01/10 → | B | B4204T6 |
| T5 | 177 | 10/10 → | B | B4204T7 |

V 50

| | | | | |
|--------------|-----|---------|---|----------|
| 1.8 | 92 | 04/04 → | B | B4184S11 |
| 1.8 FlexFuel | 92 | 01/05 → | | B4184S8 |
| 2.0 | 107 | 10/06 → | B | B4204S3 |
| 2.0 FlexFuel | 107 | 01/10 → | | B4204S4 |

V 60

| | | | | |
|-------|-----|---------|---|---------|
| 2.0 T | 149 | 09/10 → | B | B4204T6 |
| T5 | 177 | 09/10 → | B | B4204T7 |

V 70 III

| | | | | |
|---------------|-----|---------|---|---------|
| 2.0 | 107 | 10/07 → | B | B4204S3 |
| 2.0 FlexiFuel | 107 | 01/08 → | | B4204S4 |
| 2.0 T | 149 | 01/10 → | B | B4204T6 |
| T5 | 177 | 01/10 → | B | B4204T7 |

XC 60

| | | | | |
|-------|-----|---------|---|---------|
| 2.0 T | 149 | 03/10 → | B | B4204T6 |
| T5 | 177 | 09/10 → | B | B4204T7 |

81805 350981805000



ALBERINO

Diametro Alberino 10.8

Posizione Attacco 66.7

Diametro Girante Ø80

N° Alette Girante 8

Posizione Girante 16.2



FORD

Mondeo III, Station Wagon

| | | | | |
|--------------------------|----|---------------|---|------------------------|
| 2.0 16V DI / TDDi / TDCi | 66 | 10/00 → 03/07 | D | D5BA, SDBA |
| 2.0 16V TDDi / TDCi | 85 | 10/00 → 03/07 | D | D6BA, HJBA, HJBB, HJBC |
| 2.0 TDCi | 96 | 10/01 → 03/07 | D | FMBA, N7BA |

81805 350981805000



FORD

Mondeo III, Station Wagon

| | | | | |
|----------|-----|---------------|---|------------|
| 2.2 TDCi | 110 | 09/04 → 03/07 | D | QJBC, QJBD |
| | 114 | 09/04 → 03/07 | D | QJBA, QJBB |

Transit VII

| | | | | |
|----------|----|---------------|---|------|
| 2.0 DI | 55 | 08/00 → 05/06 | D | D3FA |
| | 63 | 08/00 → 05/06 | D | F3FA |
| | 74 | 08/00 → 05/06 | D | ABFA |
| 2.0 TDCi | 92 | 08/02 → 05/06 | D | FIFA |
| | 92 | 08/02 → 05/06 | D | FIFA |

JAGUAR

X Type, Estate

| | | | | |
|-------|-----|---------------|---|---------------------|
| 2.0 D | 96 | 07/03 → 11/09 | D | FMBA, FMBB, R4-X404 |
| | 107 | 01/07 → 11/09 | D | LJ46G |
| 2.2 D | 114 | 10/05 → 11/09 | D | LJ46G |

81806 350981806000



PULEGGIA

Diametro Puleggia Ø59.26

Numero Denti/Gole Puleggia 20

Altezza Puleggia 30.5

Posizione Attacco 49.7

Diametro Girante Ø59.5

N° Alette Girante 8

Posizione Girante 24.8



DACIA

Duster

| | | | | |
|-----------------|----|---------|---|----------------|
| 1.6 16V | 77 | 04/10 → | B | K4M690, K4M696 |
| 1.6 16V 4x4 | 77 | 06/10 → | B | K4M606 |
| 1.6 16V Hi-Flex | 77 | 08/10 → | | K4M696 |
| 1.6 16V LPG | 77 | 04/11 → | | K4M696 |

Logan

| | | | | |
|---------|----|---------|---|--------|
| 1.6 16V | 77 | 01/13 → | B | K4M842 |
|---------|----|---------|---|--------|

Logan MCV

| | | | | |
|-----------------|----|---------|---|----------------|
| 1.6 16V | 77 | 02/07 → | B | K4M690, K4M696 |
| 1.6 16V Hi-Flex | 77 | 11/09 → | | K4M690, K4M694 |

81806 350981806000

DACIA
Logan, Station Wagon, Van

| | | | | |
|----------------------|----|---------|---|-------------------|
| 1.6 16V | 77 | 02/06 → | B | K4M690, K4M696 |
| 1.6 16V Flexifuel | 77 | 07/10 → | | K4M696 |

Sandero I

| | | | | |
|-------------------|----|---------|----|------------------------------|
| 1.6 16V | 77 | 07/11 → | B | K4M690 |
| 1.6 16V Bifuel | 77 | 01/11 → | BF | K4M690, K4M694, K4M696 |

Sandero II

| | | | | |
|---------|----|---------|---|-------------------|
| 1.6 | 61 | 11/12 → | B | K7M812 |
| 1.6 16V | 77 | 01/13 → | B | K4M842, K4M845 |

NISSAN
Kubistar

| | | | | |
|---------|----|---------------|---|--------|
| 1.6 16V | 70 | 08/03 → 10/09 | B | K4M752 |
|---------|----|---------------|---|--------|

RENAULT
Clio II

| | | | | |
|-------------|----|---------------|---|--|
| 1.4 16V | 70 | 10/99 → 09/04 | B | K4J712, K4J713 |
| | 72 | 08/00 → | B | K4J710, K4J711, K4J712, K4J713 |
| 1.6 16V | 79 | 09/98 → | B | K4M708, K4M740, K4M742, K4M743, K4M744, K4M745, K4M748 |
| 1.6 Hi-Flex | 86 | 01/05 → 02/10 | | K4M748 |

Clio III, Grandtour

| | | | | |
|-------------|----|---------------|---|-------------------|
| 1.4 16V | 72 | 02/10 → | B | K4J780 |
| 1.6 16V | 65 | 06/05 → | B | K4M804 |
| | 82 | 02/08 → | B | K4M800, K4M801 |
| | 94 | 11/08 → | B | K4M862 |
| 1.6 16V GT | 94 | 06/09 → | B | K4M862 |
| 1.6 Hi-Flex | 86 | 05/05 → 02/10 | | K4M748 |

Duster

| | | | | |
|---------|----|---------|---|--------|
| 1.6 16V | 75 | 02/12 → | B | K4M616 |
|---------|----|---------|---|--------|

Fluence

| | | | | |
|---------|----|---------|---|-------------------|
| 1.6 16V | 82 | 02/10 → | B | K4M838 |
| | 81 | 02/10 → | B | K4M838, K4M839 |

81806 350981806000

RENAULT
Grand Scénic II

| | | | | |
|-----|----|---------------|---|-------------------|
| 1.6 | 77 | 06/06 → | B | K4M788 |
| | 82 | 06/06 → 11/08 | B | K4M812 |
| | 83 | 04/04 → | B | K4M761, K4M782 |

Grand Scénic III

| | | | | |
|-------------------|----|---------|----|--------|
| 1.6 16V | 81 | 02/09 → | B | K4M858 |
| 1.6 16V Bifuel | 81 | 02/09 → | BF | K4M866 |

Kangoo I, Van

| | | | | |
|---------------------|----|---------|---|---|
| 1.6 16V | 70 | 06/01 → | B | K4M706, K4M750, K4M752, K4M753 |
| | 70 | 10/01 → | B | K4M706, K4M752 |
| 1.6 16V 4x4 | 70 | 10/01 → | B | K4M750, K4M752, K4M753 |
| 1.6 16V bivalent | 60 | 06/05 → | | K4M850 |

Kangoo II, Be Bop, Van

| | | | | |
|--------------------|----|---------|---|-------------------|
| 1.6 | 78 | 02/09 → | B | K4M830 |
| 1.6 16V | 78 | 02/08 → | B | K4M830 |
| | 78 | 02/08 → | B | K4M830, K4M831 |
| 1.6 16V Hi-Flex | 78 | 02/08 → | | K4M834, K4M850 |
| 1.6 16V LPG | 72 | 02/08 → | | K4M834 |

Laguna I, Grantour

| | | | | |
|---------|----|---------------|---|-------------------|
| 1.6 16V | 79 | 11/97 → 03/01 | B | K4M720, K4M724 |
|---------|----|---------------|---|-------------------|

Laguna II, Grantour

| | | | | |
|--------------|----|---------------|---|--|
| 1.6 16V | 82 | 02/05 → | B | K4M716 |
| | 79 | 03/01 → | B | K4M710, K4M714 |
| | 82 | 02/05 → | B | K4M716 |
| 1.6 FlexFuel | 76 | 06/01 → 10/03 | | K4M718 |
| 1.8 16V | 85 | 03/01 → | B | F4P770, F4P771, F4P773, F4P774, F4P775 |

M: F4P 775

Laguna III, Grantour, Coupé

| | | | | |
|---------|----|---------|---|--------|
| 1.6 16V | 81 | 10/07 → | B | K4M824 |
|---------|----|---------|---|--------|

81806
350981806000

RENAULT
Logan I, Station Wagon

| | | | | |
|-----|----|---------|---|--------|
| 1.6 | 77 | 04/07 → | B | K4M690 |
|-----|----|---------|---|--------|

Logan I, Station Wagon, Express

| | | | | |
|-----|----|---------|---|--------|
| 1.6 | 77 | 04/07 → | B | K4M697 |
|-----|----|---------|---|--------|

Megane I, Coach, Cabrio, Scénic, Station Wagon

| | | | | |
|---------|----|---------------|---|-------------------|
| 1.4 16V | 70 | 03/99 → 08/03 | B | K4J714, K4J750 |
|---------|----|---------------|---|-------------------|

| | | | | |
|---------|----|---------------|---|---|
| 1.6 16V | 79 | 03/99 → 08/03 | B | K4M700, K4M701, K4M704, K4M708 |
| | 79 | 03/99 → 08/03 | B | K4M700, K4M701, K4M708 |

| | | | | |
|---------|----|---------------|--|--------|
| 1.6 LPG | 80 | 10/00 → 08/02 | | K4M704 |
|---------|----|---------------|--|--------|

Megane II, Station Wagon, Coupé-Cabrio

| | | | | |
|-----|----|---------------|---|-------------------|
| 1.4 | 60 | 09/03 → | B | K4J732 |
| | 72 | 08/03 → 07/09 | B | K4J730, K4J740 |

| | | | | |
|---------|----|---------------|---|-------------------|
| 1.4 16V | 60 | 10/03 → 02/08 | B | K4J732 |
| | 72 | 11/02 → 02/08 | B | K4J730, K4J740 |

| | | | | |
|-----|----|---------------|---|--------|
| 1.6 | 75 | 09/03 → | B | K4M768 |
| | 77 | 05/05 → | B | K4M762 |
| | 77 | 06/05 → 02/08 | B | K4M788 |

| | | | | |
|-----|----|---------------|---|-------------------|
| 1.6 | 83 | 09/03 → 03/09 | B | K4M760, K4M761 |
| | 77 | 05/05 → 07/09 | B | K4M762 |

| | | | | |
|---------|----|---------------|---|---|
| 1.6 16V | 82 | 01/06 → 06/08 | B | K4M760, K4M761, K4M812, K4M813 |
| | 82 | 01/06 → 06/08 | B | K4M760, K4M812, K4M813 |

| | | | | |
|---------|----|---------------|---|-------------------|
| 1.6 16V | 82 | 01/06 → | B | K4M812, K4M813 |
| | 83 | 11/02 → 02/08 | B | K4M760 |

| | | | | |
|--------------------|----|---------------|--|--------|
| 1.6 16V Hi-Flex | 77 | 02/08 → 07/09 | | K4M856 |
|--------------------|----|---------------|--|--------|

| | | | | |
|------------------|----|---------------|--|--------|
| 1.6 Flex-Fuel | 77 | 01/07 → 02/08 | | K4M788 |
|------------------|----|---------------|--|--------|

81806
350981806000

RENAULT
Megane III, Station Wagon, Coupé, CC

| | | | | |
|---------|----|---------|---|-------------------|
| 1.6 16V | 82 | 11/08 → | B | K4M858, K4M866 |
| | 74 | 11/08 → | B | K4M848 |
| | 81 | 06/10 → | B | K4M858 |

| | | | | |
|-------------------|----|---------|----|--------|
| 1.6 16V Bifuel | 81 | 11/08 → | BF | K4M866 |
|-------------------|----|---------|----|--------|

| | | | | |
|---------|----|---------|---|--|
| 1.6 TCe | 96 | 01/11 → | B | |
|---------|----|---------|---|--|

Modus

| | | | | |
|-----|----|---------|---|-------------------|
| 1.4 | 72 | 12/04 → | B | K4J770, K4J780 |
|-----|----|---------|---|-------------------|

| | | | | |
|-----|----|---------|---|---|
| 1.6 | 65 | 12/04 → | B | K4M794 |
| | 82 | 12/04 → | B | K4M790, K4M791, K4M800, K4M801 |

| | | | | |
|-----|----|---------|---|---|
| 1.6 | 82 | 12/04 → | B | K4M790, K4M791, K4M800, K4M801 |
|-----|----|---------|---|---|

Scénic I

| | | | | |
|---------|----|---------------|---|-------------------|
| 1.4 16V | 70 | 09/99 → 08/03 | B | K4J714, K4J750 |
|---------|----|---------------|---|-------------------|

| | | | | |
|-----|----|---------------|---|-------------------|
| 1.6 | 79 | 09/99 → 09/03 | B | K4M700, K4M706 |
|-----|----|---------------|---|-------------------|

| | | | | |
|------------|----|---------------|----|--------|
| 1.6 BiFuel | 79 | 09/99 → 04/01 | BF | K4M704 |
|------------|----|---------------|----|--------|

Scénic II

| | | | | |
|-----|----|---------|---|------------------------------|
| 1.4 | 72 | 06/03 → | B | K4J730, K4J740, K4J770 |
|-----|----|---------|---|------------------------------|

| | | | | |
|-----|----|---------|---|-------------------|
| 1.6 | 77 | 06/06 → | B | K4M788 |
| | 83 | 06/03 → | B | K4M761, K4M782 |

| | | | | |
|---------|----|---------|---|---|
| 1.6 16V | 82 | 10/05 → | B | K4M706, K4M766, K4M812, K4M813 |
| | 82 | 10/05 → | B | K4M706, K4M766, K4M812, K4M813 |

Scénic III

| | | | | |
|---------|----|---------|---|--------|
| 1.6 16V | 81 | 02/09 → | B | K4M858 |
|---------|----|---------|---|--------|

| | | | | |
|---------|----|---------|----|--------|
| 1.6 E85 | 81 | 02/09 → | FF | K4M866 |
|---------|----|---------|----|--------|

Thalia I

| | | | | |
|---------|----|---------|---|--------|
| 1.4 16V | 72 | 08/00 → | B | K4J712 |
|---------|----|---------|---|--------|

| | | | | |
|---------|----|---------|---|--------|
| 1.6 16V | 79 | 04/02 → | B | K4M740 |
|---------|----|---------|---|--------|

Thalia II

| | | | | |
|---------|----|---------|---|--------|
| 1.6 16V | 77 | 09/08 → | B | K4M743 |
|---------|----|---------|---|--------|

Twingo II

| | | | | |
|--------|----|---------|---|--------|
| 1.6 RS | 98 | 05/08 → | B | K4M854 |
|--------|----|---------|---|--------|

Wind

| | | | | |
|-----|----|---------|---|--------|
| 1.6 | 98 | 07/10 → | B | K4M854 |
|-----|----|---------|---|--------|

81807
350981807000

FLANGIA

| | |
|-----------------------------------|------|
| Numero Fori Flangia | 3 |
| Numero Fori Flangia (Serie 2) | 3 |
| Dimensione Fori Flangia | M6×1 |
| Dimensione Fori Flangia (Serie 2) | Ø6 |
| Posizione Attacco | 61.6 |
| Diametro Centraggio | Ø40 |
| Diametro Girante | Ø60 |
| N° Alette Girante | 8 |
| Posizione Girante | 30.6 |

KW

SEAT
Arosa

| | | | | | |
|-----|----|---------------|---|-------------------------|-------------------|
| 1.0 | 37 | 10/98 → 01/01 | B | AHT | |
| | 37 | 05/97 → 06/04 | B | AER, ALD, ALL, ANV, AUC | → 11-1999, M: AHT |

VOLKSWAGEN
Lupo I

| | | | | | |
|-----|----|---------------|---|-------------------------|--------|
| 1.0 | 37 | 10/98 → 05/00 | B | AHT | |
| | 37 | 09/98 → 07/05 | B | AER, ALD, ALL, ANV, AUC | M: AHT |

81808
350981808000

FLANGIA

| | |
|-------------------------|------|
| Numero Fori Flangia | 3 |
| Numero Fori Flangia | 3 |
| Dimensione Fori Flangia | M6×1 |
| Posizione Attacco | 56.5 |
| Diametro Mozzo | Ø28 |
| Diametro Girante | Ø60 |
| N° Alette Girante | 6 |
| Posizione Girante | 10.2 |

KW

DAIHATSU
Copen

| | | | | | |
|-----|----|---------------|---|-------|-----------------|
| 1.3 | 64 | 03/06 → 09/12 | B | K3-VE | Flange: 3 holes |
|-----|----|---------------|---|-------|-----------------|

Materia

| | | | | | |
|----------------|----|---------|---|--------|-----------------|
| 1.3 | 67 | 10/06 → | B | K3-VE | Flange: 3 holes |
| 1.3 DVVT Turbo | 95 | 10/06 → | B | K3-VET | Flange: 3 holes |
| 1.5 | 76 | 10/06 → | B | 3SZ-VE | Flange: 3 holes |
| 1.5 ECO 4WD | 76 | 10/06 → | B | 3SZ-VE | Flange: 3 holes |

Sirion I

| | | | | | |
|---------------|----|---------------|---|--------|-----------------|
| 1.3 Sport | 75 | 08/00 → 01/05 | B | K3-VE2 | Flange: 3 holes |
| 1.3 Sport 4WD | 75 | 08/00 → 03/05 | B | K3-VE2 | Flange: 3 holes |

81808
350981808000

KW

DAIHATSU
Sirion II

| | | | | | |
|---------|----|---------------|---|--------|-----------------|
| 1.3 | 64 | 01/05 → | B | K3-VE | Flange: 3 holes |
| | 67 | 03/08 → | B | K3-VE | Flange: 3 holes |
| 1.3 4WD | 64 | 04/05 → | B | K3-VE | Flange: 3 holes |
| | 67 | 03/08 → | B | K3-VE | Flange: 3 holes |
| 1.5 | 76 | 03/08 → | B | 3SZ-VE | Flange: 3 holes |
| 1.5 4WD | 76 | 05/06 → 10/08 | B | 3SZ-VE | Flange: 3 holes |

Terios II

| | | | | | |
|---------------|----|---------|---|--------|-----------------|
| 1.3 VVT-i | 63 | 11/05 → | B | K3-VE | Flange: 3 holes |
| 1.3 VVT-i 4x4 | 63 | 11/05 → | B | K3-VE | Flange: 3 holes |
| 1.5 4x4 | 77 | 05/06 → | B | 3SZ-VE | Flange: 3 holes |
| 1.5 VVT-i | 75 | 09/10 → | B | 3SZ-VE | Flange: 3 holes |
| | 77 | 11/05 → | B | 3SZ-VE | Flange: 3 holes |
| 1.5 VVT-i 4x4 | 75 | 09/10 → | B | | Flange: 3 holes |

YRV

| | | | | | |
|---------|----|---------|---|--------|-----------------|
| 1.3 | 64 | 02/01 → | B | K3-VE | Flange: 3 holes |
| 1.3 4WD | 64 | 02/01 → | B | K3-VE | Flange: 3 holes |
| 1.3 GTi | 95 | 07/02 → | B | K3-VET | Flange: 3 holes |

TOYOTA
Yaris I

| | | | | | |
|---------|----|---------------|---|--------|-----------------|
| 1.0 16V | 48 | 03/03 → 09/05 | B | 1SZ-FE | Flange: 3 holes |
| | 50 | 04/99 → 09/05 | B | 1SZ-FE | Flange: 3 holes |

81809
350981809000

FLANGIA

| | |
|-------------------------|-------|
| Numero Fori Flangia | 3 |
| Dimensione Fori Flangia | M6×1 |
| Posizione Attacco | 50.5 |
| Diametro Mozzo | Ø28 |
| Diametro Girante | Ø56.5 |
| N° Alette Girante | 6 |
| Posizione Girante | 21.2 |

KW

TOYOTA
Corolla VII, Liftback, Station Wagon, Verso

| | | | | | |
|----------|----|---------------|---|--------|--|
| 1.4 D | 66 | 07/04 → 02/07 | D | 1ND-TV | |
| 1.4 D4-D | 66 | 07/04 → 02/07 | D | 1ND-TV | |
| | 66 | 07/04 → 07/07 | D | 1ND-TV | |

Prius I

| | | | | | |
|------------|----|---------------|--|---------|--|
| 1.5 Hybrid | 53 | 05/00 → 01/04 | | 1NZ-FXE | |
|------------|----|---------------|--|---------|--|

Prius II

| | | | | | |
|-----|----|---------------|--|---------|--|
| 1.5 | 57 | 08/03 → 03/09 | | 1NZ-FXE | |
|-----|----|---------------|--|---------|--|

81809
350981809000

KW

TOYOTA
Urban Cruiser

| | | | | |
|-----------------|----|---------|---|--------|
| 1.5 VVTi | 80 | 07/07 → | B | 1NZ-FE |
| 1.5 VVTi 4WD | 76 | 04/09 → | B | 1NZ-FE |

Verso S

| | | | | |
|---------|----|---------|---|--------|
| 1.5 | 80 | 11/10 → | B | 1NZ-FE |
| 1.5 4WD | 76 | 11/10 → | B | 1NZ-FE |

Yaris I

| | | | | |
|-----------------|-----------|--------------------------------|---|-------------------|
| 1.3 | 64 | 04/02 → 09/05 | B | 2SZ-FE |
| 1.3 16V | 63 | 11/99 → 09/05 | B | 2NZ-FE, 2SZ-FE |
| 1.4 D-4D | 55 | 12/01 → 09/05 | D | 1ND-TV |
| 1.5 TS | 77 | 01/03 → 09/05 | B | 1NZ-FE |
| 1.5 VVT-i TS | 78 110 | 04/01 → 09/05 03/03 → 07/05 | B | 1NZ-FE |

Yaris II

| | | | | |
|---------|----|---------|---|-------------------|
| 1.3 | 64 | 08/07 → | B | 2NZ-FE, 2SZ-FE |
| 1.3 4WD | 64 | 08/07 → | B | 2NZ-FE |
| 1.5 | 80 | 08/07 → | B | 1NZ-FE |
| | 81 | 08/07 → | B | 1NZ-FE |
| | 80 | 11/05 → | B | 1NZ-FE |

Yaris III

| | | | | |
|-----------|----|---------|---|--------|
| 1.3 VVT-i | 63 | 12/10 → | B | 2NZ-FE |
|-----------|----|---------|---|--------|

Yaris Verso

| | | | | |
|----------|----|---------------|---|--------|
| 1.3 | 62 | 11/02 → 09/05 | B | 2NZ-FE |
| | 63 | 08/99 → 10/02 | B | 2NZ-FE |
| 1.4 D-4D | 55 | 12/01 → 09/05 | D | 1ND-TV |
| 1.5 | 77 | 05/03 → 09/05 | B | 1NZ-FE |
| | 78 | 03/00 → 09/05 | B | 1NZ-FE |

81810
350981810000

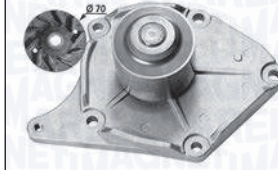
KW

PULEGGIA

| | |
|-------------------|-------|
| Diametro Puleggia | Ø52 |
| Altezza Puleggia | 32.8 |
| Posizione Attacco | 50.5 |
| Diametro Girante | Ø70.3 |
| N° Alette Girante | 10 |
| Posizione Girante | 7.8 |

KW

DACIA
Logan

| | | | | |
|---------|----|---------|---|--------|
| 1.5 dCi | 55 | 10/12 → | D | K9K612 |
| | 63 | 01/13 → | D | K9K830 |

Logan MCV

| | | | | |
|---------|----|---------|---|--------|
| 1.5 dCi | 55 | 02/13 → | D | K9K612 |
| | 63 | 02/13 → | D | K9K830 |
| | 66 | 02/13 → | D | K9K612 |

Sandero II

| | | | | |
|---------|----|---------|---|--------|
| 1.5 dCi | 55 | 10/12 → | D | K9K612 |
| | 66 | 10/12 → | D | K9K612 |

NISSAN
Almera II, Hatchback

| | | | | |
|---------|----|---------|---|--------|
| 1.5 dCi | 60 | 01/03 → | D | K9K722 |
|---------|----|---------|---|--------|

Kubistar

| | | | | |
|---------|----|---------------|---|-------------------|
| 1.5 dCi | 42 | 08/03 → 10/09 | D | K9K710, K9K714 |
| | 45 | 08/05 → 10/09 | D | K9K710, K9K714 |
| | 48 | 08/03 → 10/09 | D | K9K704 |
| | 60 | 08/03 → 10/09 | D | K9K722 |

Micra III (K12), C+C

| | | | | |
|---------|----|---------------|---|--------|
| 1.5 dCi | 48 | 01/03 → 06/10 | D | K9K704 |
| | 60 | 09/03 → 06/10 | D | K9K722 |

RENAULT
Clio II

| | | | | |
|---------|----|---------------|---|------------------------------|
| 1.5 dCi | 50 | 04/04 → | D | K9K714 |
| | 59 | 06/01 → 10/04 | D | K9K702 |
| | 60 | 11/03 → | D | K9K702, K9K710, K9K716 |
| | 48 | 06/01 → | D | K9K700, K9K704 |
| | 59 | 06/01 → 10/03 | D | K9K702 |
| | 60 | 06/01 → | D | K9K702 |

Grand Scénic II

| | | | | |
|---------|----|---------|---|---------|
| 1.5 dCi | 74 | 04/04 → | D | K9K728 |
| | 78 | 05/05 → | D | K9KP732 |

81810 350981810000

RENAULT
Kangoo I, Van

| | | | | | |
|---------|----|---------------|---|------------------------|-----------|
| 1.5 dCi | 42 | 07/03 → | D | K9K704 | → 03-2004 |
| | 45 | 04/05 → 06/10 | D | K9K700, K9K702 | |
| | 45 | 10/05 → | D | K9K716 | |
| | 50 | 06/05 → | D | K9K714 | |
| | 42 | 12/02 → | D | K9K704 | → 03-2004 |
| | 48 | 12/01 → | D | K9K700, K9K702, K9K704 | → 03-2004 |
| | 48 | 12/01 → | D | K9K700, K9K704 | → 03-2004 |
| | 50 | 06/05 → | D | K9K714 | |
| | 60 | 07/02 → | D | K9K702, K9K710 | → 03-2004 |
| | 62 | 06/05 → | D | K9K718 | |

Logan I, Station Wagon, Express

| | | | | | |
|---------|----|---------|---|--------|--|
| 1.5 dCi | 50 | 04/07 → | D | K9K792 | |
|---------|----|---------|---|--------|--|

Megane II, Station Wagon, Coupé-Cabrio

| | | | | | |
|---------|----|---------------|---|--------|-----------|
| 1.5 dCi | 60 | 08/03 → 05/06 | D | K9K722 | → 03-2004 |
| | 60 | 11/02 → 02/08 | D | K9K722 | → 03-2004 |

Megane III, Station Wagon, Coupé, CC

| | | | | | |
|---------|----|---------|---|--------|--|
| 1.5 dCi | 63 | 03/09 → | D | K9K830 | |
|---------|----|---------|---|--------|--|

Modus

| | | | | | |
|---------|----|---------|---|----------------|--|
| 1.5 dCi | 50 | 12/04 → | D | K9K762, K9K768 | |
| | 63 | 12/04 → | D | K9K760, K9K766 | |

Scénic II

| | | | | | |
|---------|----|---------|---|----------------|-----------|
| 1.5 dCi | 60 | 06/03 → | D | K9K722 | → 03-2004 |
| | 74 | 11/03 → | D | K9K728, K9K729 | → 03-2004 |

Thalia I

| | | | | | |
|---------|----|---------|---|--------|--|
| 1.5 dCi | 48 | 04/02 → | D | K9K700 | |
|---------|----|---------|---|--------|--|

Thalia II

| | | | | | |
|---------|----|---------|---|--------|--|
| 1.5 dCi | 48 | 01/09 → | D | K9K700 | |
|---------|----|---------|---|--------|--|

Twingo II

| | | | | | |
|---------|----|---------|---|--------|--|
| 1.5 dCi | 62 | 04/08 → | D | K9K718 | |
|---------|----|---------|---|--------|--|

SUZUKI
Jimny

| | | | | | |
|--------------|----|---------|---|--------|--|
| 1.5 DDiS 4WD | 48 | 12/03 → | D | K9K700 | |
|--------------|----|---------|---|--------|--|

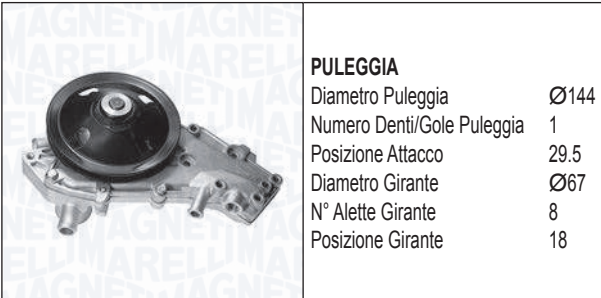
81811 350981811000

RENAULT
19 I, Chamade, Cabrio

| | | | | | |
|-----|----|---------------|---|----------------|--------|
| 1.2 | 40 | 01/88 → 12/92 | B | C1G730 | (+)COP |
| 1.4 | 43 | 01/89 → 04/92 | B | C2J772, C3J710 | (+)COP |

19 II, Chamade, Cabrio

| | | | | | |
|-----|----|---------------|---|--------|--------|
| 1.2 | 40 | 04/92 → 12/95 | B | C1G730 | (+)COP |
| 1.4 | 43 | 04/92 → 12/95 | B | C3J710 | (+)COP |

21, Station Wagon

| | | | | | |
|-----|----|---------------|---|--------|--------|
| 1.4 | 51 | 09/89 → 05/93 | B | C2J770 | (+)COP |
|-----|----|---------------|---|--------|--------|

Clio I

| | | | | | |
|-----|----|---------------|---|--------|------------------------------|
| 1.1 | 34 | 01/91 → 09/98 | B | C1E700 | (+)COP |
| | 34 | 01/91 → 09/98 | B | C1E700 | (+)COP, → 05-1994, M: C1E700 |
| | 36 | 04/92 → 08/92 | B | C1E700 | (+)COP, → 05-1994, M: C1E700 |

Rapid

| | | | | | |
|-----|----|---------------|---|--|---------------|
| 1.0 | 27 | 02/86 → 05/92 | B | C1C706 | (+)COP, (-)AC |
| 1.1 | 33 | 07/85 → 04/95 | B | C1E750, C1E752, C1E754, C1E756, C1E760, C1E762, C1E792 | (+)COP, (-)AC |
| | | | | | |
| 1.2 | 40 | 09/91 → 03/98 | B | C3G710, C3G712 | (+)COP, (-)AC |
| 1.4 | 43 | 07/85 → 03/98 | B | C1J768, C1J780, C3J700, C3J702, C3J760, C3J762 | (+)COP, (-)AC |
| | | | | 44 | 03/86 → 08/91 |

81811 350981811000



RENAULT

Super 5

| | | | | | |
|--------------|-----|---------------|---|--|---------------|
| 1.1 | 33 | 01/86 → 03/95 | B | C1E750, C1E752, C1E756, C1E760 | (+)COP, (-)AC |
| | 34 | 10/84 → 12/96 | B | C1E750, C1E752, C1E754 | (+)COP, (-)AC |
| 1.2 | 40 | 01/87 → 08/90 | B | C1G702, C1G720, C1G722 | (+)COP, (-)AC |
| | 44 | 01/87 → 12/96 | B | C1G702 | (+)COP, (-)AC |
| 1.4 | 43 | 10/84 → 12/96 | B | C1J768, C1J780, C3J700, C3J702, C3J760 | (+)COP, (-)AC |
| | 44 | 06/87 → 08/90 | B | C2J784 | (+)COP, (-)AC |
| 1.4 Turbo | 88 | 04/85 → 08/90 | B | C1J782, C1J784, C1J788 | (+)COP, (-)AC |
| 1.4 Turbo GT | 118 | 01/85 → 05/91 | B | 840730 | (+)COP, (-)AC |

81812 350981812000



FLANGIA

Numero Fori Flangia 3

Dimensione Fori Flangia M6×1

Posizione Attacco 74

Diametro Girante Ø66.8

N° Alette Girante 8

Posizione Girante 16.7



ALFA ROMEO

159, Sportwagon

| | | | | |
|---------|-----|---------------|---|-----------|
| 1.9 JTS | 118 | 09/05 → 11/11 | B | 939A6.000 |
| 2.2 JTS | 136 | 09/05 → 11/11 | B | 939A5.000 |

Brera

| | | | | |
|---------|-----|---------------|---|-----------|
| 2.2 JTS | 136 | 01/06 → 06/10 | B | 939A5.000 |
|---------|-----|---------------|---|-----------|

Spider V

| | | | | |
|---------|-----|---------------|---|-----------|
| 2.2 JTS | 136 | 03/06 → 06/10 | B | 939A5.000 |
|---------|-----|---------------|---|-----------|

81812 350981812000



CHEVROLET

Captiva

| | | | | |
|---------|-----|---------|---|------------|
| 2.4 | 123 | 03/11 → | B | A24XE, LE5 |
| 2.4 4WD | 123 | 03/11 → | B | A24XE, LE5 |

HHR

| | | | | |
|-----|-----|---------------|---|-----|
| 2.4 | 125 | 10/07 → 12/11 | B | LE5 |
|-----|-----|---------------|---|-----|

Malibu

| | | | | |
|-----|-----|---------|---|-----|
| 2.4 | 123 | 01/12 → | B | LE9 |
| | 125 | 01/12 → | B | LE9 |

FIAT

Croma II

| | | | | |
|---------|-----|---------|---|-----------|
| 2.2 16V | 108 | 06/05 → | B | 194A1.000 |
|---------|-----|---------|---|-----------|

OPEL

Antara

| | | | | |
|---------|-----|---------|---|-------|
| 2.4 | 123 | 12/10 → | B | A24XE |
| 2.4 4x4 | 123 | 12/10 → | B | A24XE |

Astra G, Station Wagon, Coupé, Cabrio, Van

| | | | | |
|---------|-----|---------------|---|-------|
| 2.2 16V | 108 | 06/00 → 01/05 | B | Z22SE |
|---------|-----|---------------|---|-------|

Astra J, Station Wagon, GTC

| | | | | |
|-----|-----|---------|---|-------------------|
| 2.0 | 206 | 04/12 → | B | A20NFT, B20NFT |
|-----|-----|---------|---|-------------------|

GT II

| | | | | |
|-----|-----|---------|---|---------------------------|
| 2.0 | 194 | 06/07 → | B | LNF, Z20NHH → T: 7Y999999 |
|-----|-----|---------|---|---------------------------|

Insignia, Station Wagon

| | | | | |
|---------------|-----|---------|----|-------------------|
| 2.0 E85 Turbo | 162 | 09/10 → | FF | A20NFT, A20NHT |
| | 162 | 09/10 → | FF | A20NHT |
| 2.0 Turbo | 162 | 07/08 → | B | A20NHT |
| 2.0 Turbo 4x4 | 162 | 07/08 → | B | A20NHT |
| | 184 | 09/11 → | B | A20NFT |
| 2.0 Turbo E85 | 162 | 07/08 → | FF | A20NFT, A20NHT |

Signum

| | | | | |
|------------|-----|---------|---|--------|
| 2.0 Turbo | 129 | 05/03 → | B | Z20NET |
| 2.2 direct | 114 | 05/03 → | B | Z22YH |

Speedster

| | | | | |
|-----|-----|---------|---|-------|
| 2.2 | 108 | 09/00 → | B | Z22SE |
|-----|-----|---------|---|-------|

Vectra B, Station Wagon

| | | | | |
|-----------|-----|---------------|---|------------------|
| 2.2 i 16V | 108 | 09/00 → 04/02 | B | C22SEL, Z22SE |
|-----------|-----|---------------|---|------------------|

Vectra C, Station Wagon

| | | | | |
|---------------|-----|---------|---|--------|
| 2.0 16V Turbo | 129 | 03/03 → | B | Z20NET |
| 2.0 Turbo | 129 | 10/03 → | B | Z20NET |
| 2.2 16V | 108 | 04/02 → | B | Z22SE |
| 2.2 direct | 114 | 10/03 → | B | Z22YH |

81812 350981812000

OPEL
Zafira A

| | | | | |
|---------|-----|---------------|---|-------|
| 2.2 16V | 108 | 09/00 → 06/05 | B | Z22SE |
|---------|-----|---------------|---|-------|

Zafira B, Van

| | | | | |
|-----|-----|---------|---|-------|
| 2.2 | 110 | 07/05 → | B | Z22YH |
|-----|-----|---------|---|-------|

SAAB
9-3 II, Station Wagon, Cabrio

| | | | | |
|------|-----|---------|---|-------|
| 1.8t | 110 | 09/02 → | B | B207E |
|------|-----|---------|---|-------|

| | | | | |
|------|-----|---------|--|-------|
| 1.8t | 110 | 01/07 → | | B207E |
|------|-----|---------|--|-------|

| | | | | |
|----------|-----|---------|--|-------|
| BioPower | 129 | 05/09 → | | B207L |
|----------|-----|---------|--|-------|

| | | | | |
|----------|-----|---------|---|-------|
| 1.8t 2.0 | 110 | 03/05 → | B | B207E |
|----------|-----|---------|---|-------|

| | | | | |
|--|-----|---------|---|-------|
| | 110 | 03/05 → | B | B207E |
|--|-----|---------|---|-------|

| | | | | |
|--|-----|---------|---|-------|
| | 129 | 08/03 → | B | B207L |
|--|-----|---------|---|-------|

| | | | | |
|-------|-----|---------|---|-----------------|
| 2.0 t | 129 | 09/02 → | B | B207L, B207M |
|-------|-----|---------|---|-----------------|

| | | | | |
|--|-----|---------|---|-------|
| | 147 | 02/09 → | B | B207M |
|--|-----|---------|---|-------|

| | | | | |
|--|-----|---------|---|-------|
| | 154 | 09/02 → | B | B207R |
|--|-----|---------|---|-------|

| | | | | |
|--|-----|---------|---|-------|
| | 177 | 05/09 → | B | B207R |
|--|-----|---------|---|-------|

| | | | | |
|-------------------|-----|---------|--|-------|
| 2.0 t BioPower | 110 | 01/07 → | | B207E |
|-------------------|-----|---------|--|-------|

| | | | | |
|--|-----|---------|--|-------|
| | 129 | 01/07 → | | B207L |
|--|-----|---------|--|-------|

| | | | | |
|--|-----|---------|--|-------|
| | 145 | 06/07 → | | B207R |
|--|-----|---------|--|-------|

| | | | | |
|--|-----|---------|--|-------|
| | 147 | 05/09 → | | B207M |
|--|-----|---------|--|-------|

| | | | | |
|--|-----|---------|--|-------|
| | 154 | 09/02 → | | B207R |
|--|-----|---------|--|-------|

| | | | | |
|-----------|-----|---------|---|-------|
| 2.0 t XWD | 154 | 06/08 → | B | B207R |
|-----------|-----|---------|---|-------|

| | | | | |
|---------------|-----|---------|---|-------|
| 2.0 Turbo XWD | 154 | 01/08 → | B | B207R |
|---------------|-----|---------|---|-------|

9-3 X

| | | | | |
|--------------------------|-----|---------|--|-------|
| 2.0 t BioPower XWD | 154 | 02/09 → | | B207R |
|--------------------------|-----|---------|--|-------|

| | | | | |
|-----------|-----|---------|---|-------|
| 2.0 t XWD | 154 | 02/09 → | B | B207R |
|-----------|-----|---------|---|-------|

9-5 II, Station Wagon

| | | | | |
|-------------------|-----|---------------|--|--------|
| 2.0 t BioPower | 162 | 05/10 → 01/12 | | A20NFT |
|-------------------|-----|---------------|--|--------|

| | | | | |
|--------------------------|-----|---------------|--|--------|
| 2.0 t BioPower XWD | 162 | 05/10 → 01/12 | | A20NHT |
|--------------------------|-----|---------------|--|--------|

| | | | | |
|-----------|-----|---------------|---|--------|
| 2.0 Turbo | 162 | 05/10 → 01/12 | B | A20NHT |
|-----------|-----|---------------|---|--------|

| | | | | |
|---------------|-----|---------------|---|--------|
| 2.0 Turbo XWD | 162 | 05/10 → 01/12 | B | A20NHT |
|---------------|-----|---------------|---|--------|

VAUXHALL
ASTRA

| | | | | |
|---------|-----|---------------|---|-------|
| 2.2 16V | 108 | 03/01 → 05/05 | B | Z22SE |
|---------|-----|---------------|---|-------|

SIGNUM

| | | | | |
|-------|-----|---------------|---|-------|
| 2.2 i | 114 | 05/03 → 05/08 | B | Z22YH |
|-------|-----|---------------|---|-------|

81812 350981812000

OPEL
ZAFIRA

| | | | | |
|---------|-----|---------------|---|-------|
| 2.2 16V | 108 | 11/98 → 08/04 | B | Z22SE |
|---------|-----|---------------|---|-------|

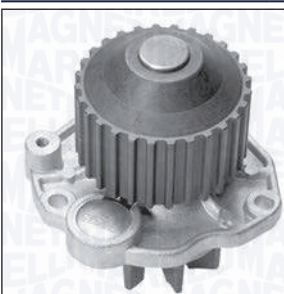
81813 350981813000

PULEGGIA

| | |
|----------------------------|-------|
| Diametro Puleggia | Ø69.7 |
| Numero Denti/Gole Puleggia | 28 |
| Altezza Puleggia | 36.1 |
| Posizione Attacco | 54.15 |
| Diametro Girante | Ø59.5 |
| N° Alette Girante | 8 |
| Posizione Girante | 49.4 |

CITROËN
C 5 I, Break

| | | | | |
|--------------|-----|---------------|---|--------------|
| 3.0 Carlsson | 173 | 09/03 → 08/04 | B | XFV (ES9J4S) |
|--------------|-----|---------------|---|--------------|

| | | | | |
|--------|-----|---------------|---|--------------|
| 3.0 V6 | 152 | 03/01 → 08/04 | B | XFV (ES9J4S) |
|--------|-----|---------------|---|--------------|

C 5 II, Break

| | | | | |
|-----|-----|---------|---|--------------|
| 3.0 | 173 | 09/04 → | B | XFV (ES9J4S) |
|-----|-----|---------|---|--------------|

| | | | | |
|--|-----|---------------|---|------------|
| | 155 | 10/04 → 04/07 | B | XFU (ES9A) |
|--|-----|---------------|---|------------|

| | | | | |
|--|-----|---------|---|------------|
| | 152 | 09/04 → | B | XFU (ES9A) |
|--|-----|---------|---|------------|

| | | | | |
|--------|-----|---------|---|-----------------------------|
| 3.0 V6 | 152 | 09/04 → | B | XFU (ES9A), XFV (ES9J4S) |
|--------|-----|---------|---|-----------------------------|

C 5 III, Break

| | | | | |
|--------|-----|---------|---|------------|
| 3.0 V6 | 155 | 02/08 → | B | XFU (ES9A) |
|--------|-----|---------|---|------------|

C 6

| | | | | |
|--------|-----|---------|---|-----------------------------|
| 3.0 V6 | 155 | 09/05 → | B | XFV (ES9A), XFV (ES9J4S) |
|--------|-----|---------|---|-----------------------------|

C 8

| | | | | |
|--------|-----|---------|---|--------------|
| 3.0 V6 | 150 | 07/02 → | B | XFV (ES9J4S) |
|--------|-----|---------|---|--------------|

FIAT
Ulysse II

| | | | | |
|-----|-----|---------------|---|-----|
| 3.0 | 150 | 08/02 → 06/11 | B | XFV |
|-----|-----|---------------|---|-----|

LANCIA
Phedra

| | | | | |
|--------|-----|---------------|---|--------|
| 3.0 V6 | 150 | 09/02 → 11/10 | B | ES9J4S |
|--------|-----|---------------|---|--------|

PEUGEOT
407, Station Wagon, Coupé

| | | | | |
|-----|-----|---------|---|------------|
| 3.0 | 155 | 05/04 → | B | XFV (ES9A) |
|-----|-----|---------|---|------------|

| | | | | | |
|--------|-----|---------------|---|--------------|--------------|
| 3.0 V6 | 152 | 03/00 → 05/04 | B | XFV (ES9J4S) | PROD →: 8555 |
|--------|-----|---------------|---|--------------|--------------|

| | | | | |
|--|-----|---------|---|------------|
| | 155 | 10/05 → | B | XFV (ES9A) |
|--|-----|---------|---|------------|

81813
350981813000

PEUGEOT
607

| | | | | |
|------------|-----|---------|---|-----------------------------|
| 3.0 V6 24V | 152 | 02/00 → | B | XFV (ES9J4S) |
| | 155 | 03/04 → | B | XFV (ES9A), XFV (ES9J4S) |

807

| | | | | |
|--------|-----|---------|---|--------------|
| 3.0 V6 | 150 | 06/02 → | B | XFV (ES9J4S) |
|--------|-----|---------|---|--------------|

RENAULT
Avantime

| | | | | |
|--------|-----|---------------|---|-------------------|
| 3.0 V6 | 152 | 09/01 → 05/03 | B | L7X720, L7X721 |
|--------|-----|---------------|---|-------------------|

Clio II

| | | | | |
|--------|-----|---------------|---|--------|
| 3.0 V6 | 166 | 11/00 → 12/02 | B | L7X760 |
| Sport | 187 | 12/02 → | B | L7X762 |

Laguna II, Grantour

| | | | | |
|------------|-----|---------|---|--------|
| 3.0 V6 24V | 152 | 03/01 → | B | L7X731 |
| | 152 | 03/01 → | B | L7X731 |

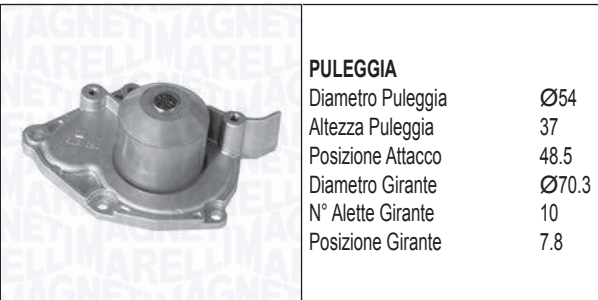
81814
350981814000

MITSUBISHI
Carisma

| | | | | |
|----------|----|---------------|---|------|
| 1.9 DI-D | 85 | 09/00 → 06/06 | D | F9Q2 |
| | 75 | 09/00 → 06/06 | D | F9Q1 |

Space Star

| | | | | |
|----------|----|---------------|---|------|
| 1.9 DI-D | 85 | 10/02 → 12/04 | D | F9Q2 |
| | 75 | 02/01 → 12/04 | D | F9Q1 |

NISSAN
Interstar

| | | | | |
|--------|----|---------|---|--------|
| dCi 80 | 60 | 07/02 → | D | F9Q772 |
|--------|----|---------|---|--------|

Primastar

| | | | | |
|---------|----|---------|---|-------------------|
| 2.0 | 88 | 02/03 → | B | F4R720 |
| | 88 | 03/01 → | B | F4R720, F4R722 |
| dCi 100 | 74 | 03/01 → | D | F9Q760 |
| dCi 80 | 60 | 03/01 → | D | F9Q762 |

81814
350981814000

OPEL
Movano A

| | | | | |
|---------|----|---------|---|-------------------|
| 1.9 DTI | 60 | 10/01 → | D | F9Q772, F9Q774 |
|---------|----|---------|---|-------------------|

Vivaro

| | | | | |
|------------|----|---------|---|-------------------|
| 1.9 DI | 60 | 08/01 → | D | F9Q762 |
| | 60 | 08/01 → | D | F9Q762, F9Q774 |
| 1.9 DTI | 74 | 08/01 → | D | F9Q760 |
| 2.0 16V | 88 | 08/01 → | B | F4R720 |
| 2.0 ECOTEC | 86 | 08/06 → | B | F4R820 |

RENAULT
Avantime

| | | | | |
|---------------|-----|---------------|---|-------------------|
| 2.0 16V Turbo | 120 | 11/01 → 05/03 | B | F4R760, F4R761 |
|---------------|-----|---------------|---|-------------------|

Clio III, Grandtour

| | | | | |
|---------------|-----|---------|---|--------|
| 2.0 16V Sport | 145 | 02/06 → | B | F4R830 |
| | 148 | 09/08 → | B | F4R830 |

Duster

| | | | | |
|-----|----|---------|---|-------------------|
| 2.0 | 98 | 02/12 → | B | F4R403, F4R405 |
|-----|----|---------|---|-------------------|

Espace IV

| | | | | |
|-----------|-----|---------------|---|---|
| 1.9 dCi | 85 | 04/03 → 02/05 | D | F9Q820 |
| 1.9 dCi | 88 | 11/02 → | D | F9Q680, F9Q820, F9Q826 |
| | | | | |
| 2.0 | 125 | 04/05 → | B | F4R796, F4R797, F4R896, F4R897 |
| | | | | |
| 2.0 Turbo | 120 | 11/02 → | B | F4R794, F4R795, F4R796, F4R797 |

Grand Scénic II

| | | | | |
|-----|-----|---------|---|-------------------|
| 2.0 | 99 | 04/04 → | B | F4R770, F4R771 |
| | 120 | 04/04 → | B | F4R776 |

Laguna I, Grantour

| | | | | |
|---------|-----|---------------|---|--------|
| 1.9 dCi | 79 | 09/99 → 03/01 | D | F9Q718 |
| 2.0 16V | 103 | 09/99 → 03/01 | B | F4R780 |

81814
350981814000

KW

RENAULT
Laguna II, Grantour

| | | | | | |
|---------|---------|---------------|------------------------------|--|-------------------|
| 1.8 16V | 86 | 03/01 → | B | F4P770 | |
| | 89 | 03/01 → | B | F4P770, F4P774 | |
| | 85 | 03/01 → | B | F4P770, F4P771, F4P773, F4P774, F4P775 | |
| | 85 | 03/01 → | B | F4P770, F4P771, F4P774, F4P775 | |
| | 86 | 03/01 → | B | F4P770, F4P774 | |
| | 88 | 03/01 → | B | F4P770, F4P773 | |
| | 89 | 03/01 → | B | F4P770, F4P772 | |
| | 1.9 dCi | 79 | 03/01 → | D | F9Q718, F9Q754 |
| 85 | | 09/05 → | D | F9Q750 | |
| 92 | | 09/05 → | D | F9Q750 | |
| 74 | | 10/01 → | D | F9Q752 | |
| 74 | | 10/01 → | D | F9Q754 | |
| 77 | | 06/01 → | D | F9Q752 | |
| 85 | | 08/05 → 09/07 | D | F9Q758, F9Q759 | |
| 88 | | 03/01 → | D | F9Q650, F9Q670, F9Q674, F9Q750 | |
| 88 | 03/01 → | D | F9Q670, F9Q674, F9Q750 | | |

81814
350981814000

KW

RENAULT
Laguna II, Grantour

| | | | | | |
|---------------|-----|---------------|---|---|--|
| 2.0 16V | 98 | 08/02 → | B | F4R714 | |
| | 98 | 10/04 → 09/07 | B | F4R714, F4R715 | |
| | 125 | 01/05 → | B | F4R784, F4R786, F4R787 | |
| | 150 | 01/05 → | B | F4R886, F4R887 | |
| 2.0 16V IDE | 103 | 04/01 → | B | F5R700, F5R701 | |
| | | | | | |
| 2.0 16V Turbo | 120 | 01/03 → | B | F4R764, F4R765, F4R786, F4R787 | |

Laguna III, Grantour, Coupé

| | | | | | |
|---------------|-----|---------|---|--------------------|--|
| 2.0 16V Turbo | 125 | 10/07 → | B | F4R811 | |
| | 125 | 09/08 → | B | F4R811, F4Rt811 | |
| 2.0 GT | 150 | 09/08 → | B | F4R800 | |

Master II

| | | | | | |
|------------|----|---------|---|-------------------|--|
| 1.9 dCi 80 | 60 | 11/01 → | D | F9Q772, F9Q774 | |
|------------|----|---------|---|-------------------|--|

Megane I, Coach, Cabrio, Scénic, Station Wagon

| | | | | | |
|---------|----|---------------|---|------------------------------|--|
| 1.9 dCi | 75 | 02/01 → 08/03 | D | F9Q732, F9Q733 | |
| | 75 | 02/01 → 08/03 | D | F9Q732, F9Q733, F9Q738 | |

Megane II, Station Wagon, Coupé-Cabrio

| | | | | | |
|-------------------|-----|---------------|---|--------------------|--|
| 2.0 | 99 | 09/03 → 12/09 | B | F4R770, F4R771 | |
| | 102 | 09/03 → 02/07 | B | F4R770 | |
| | 169 | 08/06 → 02/08 | B | F4R774 | |
| 2.0 16V | 99 | 11/02 → 02/08 | B | F4R770 | |
| 2.0 16V Turbo | 120 | 05/04 → 02/08 | B | F4R776 | |
| 2.0 Renault Sport | 165 | 05/04 → 10/09 | B | F4R774, F4Rt774 | |

81814
350981814000

KW

RENAULT
Megane III, Station Wagon, Coupé, CC

| | | | | |
|----------|-----|---------|---|-------------------|
| 2.0 R.S. | 195 | 11/08 → | B | F4R874 |
| 2.0 TCe | 140 | 06/12 → | B | F4R872 |
| | 162 | 09/12 → | B | F4R874 |
| | 132 | 11/08 → | B | F4R870 |
| | 132 | 06/10 → | B | F4R870, F4R872 |
| | 184 | 05/09 → | B | F4R874 |

Scénic II

| | | | | |
|---------------|-----|---------|---|-------------------|
| 2.0 | 99 | 06/03 → | B | F4R770, F4R771 |
| 2.0 16V Turbo | 120 | 05/04 → | B | F4R776 |

Trafic II

| | | | | |
|-------------|----|---------------|---|-------------------|
| 1.9 dCi | 59 | 04/01 → 07/03 | D | F9Q762 |
| | 75 | 03/01 → | D | F9Q760 |
| 1.9 dCi 100 | 74 | 03/01 → | D | F9Q760 |
| 1.9 dCi 80 | 60 | 03/01 → | D | F9Q760, F9Q762 |
| | 60 | 03/01 → | D | F9Q762 |
| 2.0 | 88 | 03/01 → | B | F4R720 |
| | 88 | 03/01 → | B | F4R720, F4R722 |
| 2.0 16V | 86 | 08/06 → | B | F4R820 |

Vel Satis

| | | | | |
|---------------|-----|---------|---|-------------------|
| 2.0 16V Turbo | 125 | 04/04 → | B | F4R766, F4R767 |
| | 120 | 06/02 → | B | F4R762, F4R763 |
| 2.0 Turbo | 108 | 04/05 → | B | F4R867 |

VAUXHALL
MOVANO

| | | | | |
|---------|----|---------------|---|--------|
| 1.9 DTI | 59 | 09/00 → 10/01 | D | F9Q770 |
| | 60 | 10/01 → 05/10 | D | F9Q774 |

VIVARO

| | | | | |
|---------|----|---------------|---|--------|
| 1.9 DI | 59 | 08/01 → 12/06 | D | F9Q762 |
| 1.9 DTI | 74 | 08/01 → 12/06 | D | F9Q760 |

VOLVO
S 40 I

| | | | | |
|--------|----|---------------|---|---------|
| 1.9 DI | 75 | 07/00 → 12/03 | D | D4192T4 |
| | 85 | 07/00 → 12/03 | D | D4192T3 |

V 40 I

| | | | | |
|--------|----|---------------|---|---------|
| 1.9 DI | 75 | 07/00 → 06/04 | D | D4192T4 |
| | 85 | 07/00 → 06/04 | D | D4192T3 |

81815
350981815000

KW

FLANGIA

| | |
|-------------------------|------|
| Numero Fori Flangia | 4 |
| Dimensione Fori Flangia | M6×1 |
| Posizione Attacco | 76.5 |
| Diametro Mozzo | Ø28 |
| Diametro Girante | Ø58 |
| N° Alette Girante | 7 |
| Posizione Girante | 10 |

KW

TOYOTA
Carina E (T19), Station Wagon

| | | | | | |
|---------|----|---------------|---|-------|----------------------|
| 1.6 | 73 | 12/93 → 09/97 | B | 4A-FE | (-)COP |
| | 79 | 01/93 → 09/97 | B | 4A-FE | (-)COP, → 12-1994 |
| | 85 | 12/93 → 09/97 | B | 4A-FE | (-)COP |
| 1.6 GLI | 79 | 04/92 → 09/97 | B | 4A-FE | (-)COP |

Celica V

| | | | | | |
|---------|----|---------------|---|-------|--------|
| 1.6 STI | 77 | 10/89 → 11/93 | B | 4A-FE | (-)COP |
|---------|----|---------------|---|-------|--------|

Corolla V, Liftback, Station Wagon, Compact

| | | | | | |
|---------|----|---------------|---|-------|--------|
| 1.6 GLI | 84 | 07/92 → 04/97 | B | 4A-FE | (-)COP |
| 1.6 Si | 84 | 09/95 → 04/97 | B | 4A-FE | (-)COP |

Corolla VI, Liftback, Station Wagon, Compact

| | | | | | |
|----------|----|---------------|---|-------|--------|
| 1.6 | 81 | 04/97 → 02/00 | B | 4A-FE | (-)COP |
| | 79 | 04/97 → 02/00 | B | 4A-FE | (-)COP |
| 1.6 Aut. | 79 | 04/97 → 02/00 | B | 4A-FE | (-)COP |

81816
350981816000

KW

PULEGGIA

| | |
|----------------------------|------|
| Diametro Puleggia | Ø56 |
| Numero Denti/Gole Puleggia | 19 |
| Altezza Puleggia | 33.5 |
| Posizione Attacco | 52.2 |
| Diametro Girante | Ø64 |
| N° Alette Girante | 8 |
| Posizione Girante | 47.5 |

KW

AUDI
A3 I

| | | | | |
|-----------------|----|---------------|---|----------|
| 1.9 TDI | 74 | 10/00 → 05/03 | D | ATD, AXR |
| | 96 | 08/00 → 05/03 | D | ASZ |
| 1.9 TDI quattro | 96 | 08/00 → 05/03 | D | ASZ |

81816
350981816000

AUDI
A3 II, Sportback, Cabriolet

| | | | | | |
|---------------------|-----|---------------|---|-----------------------|--------|
| 2.0 TDI | 100 | 05/03 → 08/12 | D | AZV, CBAA, CFFA | |
| | 100 | 04/08 → 05/13 | D | CBAA, CFFA | |
| | 103 | 06/05 → 06/08 | D | BMM | |
| | 103 | 04/08 → 05/13 | D | CBAB, CFFB | |
| | 120 | 06/06 → 06/08 | D | BUY | |
| | 125 | 03/06 → 08/12 | D | BMN, CBBB, CFGB | |
| 2.0 TDI 16V | 103 | 05/03 → 08/12 | D | BKD, CBAB, CFFB, CLJA | |
| 2.0 TDI 16V quattro | 103 | 08/04 → 08/12 | D | BKD, CBAB, CFFB | |
| | 103 | 11/05 → 03/13 | D | BKD, CBAB, CFFB | M: BKD |
| 2.0 TDI quattro | 100 | 05/03 → 06/08 | D | AZV | |
| | 103 | 01/06 → 06/08 | D | BMM | |
| | 125 | 03/06 → 08/12 | D | BMN, CBBB, CFGB | |

A4 I, Avant

| | | | | | |
|-----------------|----|---------------|---|----------|--|
| 1.9 TDI | 85 | 03/00 → 11/00 | D | AJM | |
| 1.9 TDI quattro | 85 | 03/00 → 11/00 | D | AJM, ATJ | |

A4 II, Avant, Cabriolet

| | | | | | |
|-----------------|-----|---------------|---|----------|--|
| 1.9 TDI | 74 | 05/01 → 12/04 | D | AVB | |
| | 85 | 06/04 → 12/04 | D | BKE | |
| | 96 | 11/00 → 12/04 | D | AVF, AWX | |
| 1.9 TDI quattro | 96 | 11/01 → 12/04 | D | AVF | |
| 2.0 TDI | 100 | 01/06 → 03/09 | D | BRC | |
| | 103 | 01/06 → 03/09 | D | BPW | |

A4 III, Avant

| | | | | | |
|-----------------|-----|---------------|---|----------|--|
| 1.9 TDI | 85 | 11/04 → 06/08 | D | BKE, BRB | |
| 2.0 TDI | 89 | 09/05 → 09/06 | D | BVG | |
| | 93 | 11/05 → 11/06 | D | BVF | |
| | 100 | 11/04 → 06/08 | D | BNA, BRF | |
| | 103 | 11/04 → 06/08 | D | BPW | |
| | 120 | 06/06 → 06/08 | D | BVA | |
| | 125 | 06/06 → 06/08 | D | BRD | |
| 2.0 TDI 16V | 103 | 11/04 → 06/08 | D | BLB, BRE | |
| 2.0 TDI quattro | 103 | 01/06 → 06/08 | D | BPW | |
| | 120 | 06/06 → 06/08 | D | BVA | |
| | 125 | 06/06 → 06/08 | D | BRD | |

81816
350981816000

AUDI
A4 IV, Avant, Allroad

| | | | | | |
|---------|-----------------|---------------|---------|------------------------|------------------|
| 2.0 TDI | 88 | 06/08 → 12/15 | D | CAGC, CJCC | |
| | 100 | 11/07 → 12/15 | D | CAGB, CJCB, CSUB | |
| | 105 | 11/07 → 12/15 | D | CAGA, CJCA, CMEA, CMFA | |
| | 120 | 08/08 → 12/15 | D | CAHB, CGLD, CNHC | |
| | 125 | 01/08 → 03/12 | D | CAHA | |
| | 2.0 TDI quattro | 100 | 09/09 → | D | CAGB, CJCB, CSUB |
| 105 | | 11/08 → 12/15 | D | CAGA, CJCA | |
| 120 | | 04/09 → | D | CAHB, CGLD, CNHC | |
| 125 | | 01/08 → 03/12 | D | CAHA | |

A5, Sportback, Cabriolet

| | | | | | |
|-----------------|-----|---------|---|------------------------|--|
| 2.0 TDI | 100 | 09/09 → | D | CAGB, CJCB | |
| | 105 | 09/09 → | D | CAGA, CJCA, CMEA, CMFA | |
| | 120 | 08/08 → | D | CAHB, CGLD | |
| | 125 | 08/08 → | D | CAHA | |
| 2.0 TDI quattro | 125 | 08/08 → | D | CAHA | |

A6 II, Avant

| | | | | | |
|---------|----|---------------|---|----------|--|
| 1.9 TDI | 85 | 07/00 → 01/05 | D | AJM | |
| | 96 | 08/01 → 01/05 | D | AVF, AWX | |

A6 III, Avant, Allroad

| | | | | | |
|---------|-----|---------------|---|----------------|--|
| 2.0 TDI | 89 | 09/05 → 06/06 | D | BVG | |
| | 100 | 07/04 → 03/11 | D | BNA, BRF, CAGB | |
| | 103 | 07/04 → 10/08 | D | BLB, BRE | |
| | 120 | 04/09 → 03/11 | D | CAHB | |
| | 125 | 11/08 → 03/11 | D | CAHA | |

TT II, Roadster

| | | | | | |
|-----------------|-----|---------------|---|------------|--|
| 2.0 TDI quattro | 125 | 06/08 → 06/14 | D | CBBB, CFGB | |
|-----------------|-----|---------------|---|------------|--|

CHRYSLER
Sebring III, Cabrio

| | | | | | |
|---------|-----|---------------|---|-----|--|
| 2.0 CRD | 103 | 07/07 → 12/10 | D | ECD | |
|---------|-----|---------------|---|-----|--|

DODGE
Avenger

| | | | | | |
|---------|-----|---------|---|-----|--|
| 2.0 CRD | 103 | 06/07 → | D | ECD | |
|---------|-----|---------|---|-----|--|

Caliber

| | | | | | |
|---------|-----|---------|---|----------|--|
| 2.0 CRD | 103 | 06/06 → | D | ECD, ECE | |
|---------|-----|---------|---|----------|--|

81816
350981816000

DODGE
Journey

| | | | | |
|---------|-----|---------|---|-----|
| 2.0 CRD | 103 | 06/08 → | D | ECE |
|---------|-----|---------|---|-----|

FORD
Galaxy I

| | | | | | |
|---------|----|---------------|---|--------------|-------------------|
| 1.9 TDI | 66 | 03/95 → 05/06 | D | 1Z, AHU, ANU | 05-2000 →, M: ANU |
| | 85 | 04/00 → 05/06 | D | AUY | M: VW19NPD |

JEEP
Compass

| | | | | |
|---------|-----|---------|---|----------|
| 2.0 CRD | 103 | 08/06 → | D | ECD, ECE |
|---------|-----|---------|---|----------|

| | | | | |
|-------------|-----|---------|---|-----|
| 2.0 CRD 4x4 | 103 | 09/06 → | D | ECE |
|-------------|-----|---------|---|-----|

Patriot

| | | | | |
|---------|-----|---------|---|----------|
| 2.0 CRD | 103 | 02/07 → | D | ECD, ECE |
|---------|-----|---------|---|----------|

| | | | | |
|-------------|-----|---------|---|----------|
| 2.0 CRD 4x4 | 103 | 02/07 → | D | ECD, ECE |
|-------------|-----|---------|---|----------|

MITSUBISHI
Grandis II

| | | | | |
|----------|-----|---------|---|-----|
| 2.0 DI-D | 100 | 09/05 → | D | BSY |
|----------|-----|---------|---|-----|

| | | | | |
|--|-----|---------|---|-----|
| | 103 | 02/07 → | D | BWC |
|--|-----|---------|---|-----|

Lancer VIII, Station Wagon, Sportback

| | | | | |
|----------|-----|---------|---|----------|
| 2.0 DI-D | 103 | 06/08 → | D | BKD, BWC |
|----------|-----|---------|---|----------|

Outlander II, Van

| | | | | |
|----------|-----|---------------|---|-----|
| 2.0 DI-D | 103 | 02/07 → 11/12 | D | BSY |
|----------|-----|---------------|---|-----|

SEAT
Alhambra I

| | | | | | |
|---------|-----|---------------|---|--------------|-----------|
| 1.9 TDI | 66 | 04/96 → 03/10 | D | 1Z, AHU, ANU | 08-2000 → |
| | 85 | 06/00 → 03/10 | D | AUY, BVK | |
| | 110 | 05/05 → 05/07 | D | BTB | |

| | | | | |
|-----------------|----|---------------|---|----------|
| 1.9 TDI 4motion | 85 | 06/00 → 03/10 | D | AUY, BVK |
|-----------------|----|---------------|---|----------|

| | | | | |
|---------|-----|---------------|---|-----|
| 2.0 TDI | 103 | 11/05 → 03/10 | D | BRT |
|---------|-----|---------------|---|-----|

Altea, Altea XL

| | | | | |
|---------|-----|---------------|---|-----------|
| 2.0 TDI | 100 | 03/04 → 05/09 | D | AZV |
| | 103 | 11/05 → | D | BMM |
| | 125 | 03/06 → | D | BMN, CEGA |

| | | | | |
|-------------|-----|---------|---|-----------|
| 2.0 TDI 16V | 103 | 03/04 → | D | BKD, CFHC |
|-------------|-----|---------|---|-----------|

| | | | | |
|-------------|-----|---------|---|-----|
| 2.0 TDI 4x4 | 103 | 06/07 → | D | BMM |
|-------------|-----|---------|---|-----|

| | | | | |
|--|-----|---------|---|-----------------|
| | 125 | 06/07 → | D | BMN, CEGA, CFJA |
|--|-----|---------|---|-----------------|

Exeo, Exeo ST

| | | | | |
|---------|-----|---------|---|------------|
| 2.0 TDI | 88 | 12/08 → | D | CAGC, CJCC |
| | 105 | 12/08 → | D | CAGA, CJCA |
| | 125 | 02/09 → | D | CAHA, CGLB |

81816
350981816000

SEAT
Ibiza IV

| | | | | |
|-----------------|-----|---------------|---|----------|
| 1.9 TDI Cupra R | 118 | 03/04 → 02/08 | D | BPX, BUK |
|-----------------|-----|---------------|---|----------|

Leon I

| | | | | |
|---------|-----|---------------|---|-----|
| 1.9 TDI | 74 | 10/05 → 06/06 | D | AXR |
| | 96 | 05/03 → 06/06 | D | ASZ |
| | 110 | 09/00 → 06/06 | D | ARL |

| | | | | |
|----------------|-----|---------------|---|-----|
| 1.9 TDI Syncro | 110 | 05/02 → 06/06 | D | ARL |
|----------------|-----|---------------|---|-----|

Leon II

| | | | | |
|---------|-----|---------------|---|-----------------|
| 2.0 TDI | 100 | 07/05 → 05/10 | D | AZV |
| | 103 | 10/05 → 10/10 | D | BMM |
| | 125 | 05/06 → 12/12 | D | BMN, CEGA, CFJA |

| | | | | |
|-------------|-----|---------------|---|-----------------|
| 2.0 TDI 16V | 103 | 07/05 → 12/12 | D | BKD, CFHC, CLCB |
|-------------|-----|---------------|---|-----------------|

Toledo II

| | | | | |
|---------|-----|---------------|---|-----|
| 1.9 TDI | 96 | 05/03 → 05/06 | D | ASZ |
| | 110 | 10/00 → 07/04 | D | ARL |

Toledo III

| | | | | |
|-------------|-----|---------------|---|-----------|
| 2.0 TDI | 100 | 09/04 → 05/09 | D | AZV |
| | 103 | 11/05 → 05/09 | D | BMM |
| 2.0 TDI | 125 | 01/06 → 05/09 | D | BMN, CEGA |
| 2.0 TDI 16V | 103 | 04/04 → 05/09 | D | BKD |

SKODA
Octavia I, Station Wagon

| | | | | |
|-------------|----|---------------|---|-----|
| 1.9 TDI | 74 | 10/05 → 12/10 | D | AXR |
| | 96 | 09/02 → 09/04 | D | ASZ |
| 1.9 TDI 4x4 | 74 | 09/00 → 01/06 | D | ATD |

Octavia II, Station Wagon

| | | | | |
|-------------|-----|---------------|---|-----------------|
| 2.0 TDI | 100 | 02/04 → 05/10 | D | AZV |
| | 103 | 11/05 → 05/10 | D | BMM |
| 2.0 TDI 16V | 100 | 02/04 → 05/10 | D | AZV |
| | 103 | 02/04 → 04/13 | D | BKD, CFHC, CLCB |
| 2.0 TDI 4x4 | 103 | 07/06 → 05/10 | D | BMM |
| 2.0 TDI RS | 125 | 04/06 → 02/13 | D | BMN, CEGA |

Roomster, Van

| | | | | |
|---------|----|---------------|---|-----|
| 1.9 TDI | 74 | 03/06 → 05/06 | D | AXR |
|---------|----|---------------|---|-----|

Superb I

| | | | | |
|---------|-----|---------------|---|----------|
| 1.9 TDI | 74 | 08/02 → 10/05 | D | AVB |
| | 77 | 10/05 → 05/07 | D | BSV |
| | 85 | 01/07 → 03/08 | D | BPZ |
| | 96 | 12/01 → 03/08 | D | AVF, AWX |
| 2.0 TDI | 103 | 10/05 → 03/08 | D | BSS |

81816 350981816000

SKODA
Superb II, Station Wagon

| | | | | | |
|-------------|-----|---------------|---|-----------------|--|
| 2.0 TDI | 103 | 03/08 → 05/10 | D | BMP | |
| | 125 | 07/08 → 05/15 | D | CBBB, CFGB | |
| 2.0 TDI 16V | 103 | 01/09 → 05/15 | D | BKD, CFFB, CLJA | |
| 2.0 TDI 4x4 | 125 | 09/08 → 05/15 | D | CBBB, CFGB | |

Yeti

| | | | | | |
|-------------|-----|---------|---|------------------|---------|
| 2.0 TDI 4x4 | 103 | 05/09 → | D | CBDB, CFHC, CLCB | M: CBDB |
| | 125 | 11/09 → | D | CEGA, CFJA | M: CEGA |

VOLKSWAGEN
Beetle II (Maggiolino)

| | | | | | |
|---------|-----|---------|---|------------|--|
| 2.0 TDI | 103 | 04/12 → | D | CFFB, CJAA | |
|---------|-----|---------|---|------------|--|

Bora, Station Wagon

| | | | | | |
|-----------------|-----|---------------|---|----------|--|
| 1.9 TDI | 74 | 09/00 → 05/05 | D | ATD, AXR | |
| | 85 | 12/98 → 01/02 | D | AJM, AUY | |
| | 96 | 11/00 → 05/05 | D | ASZ | |
| | 110 | 05/00 → 05/05 | D | ARL | |
| 1.9 TDI 4motion | 74 | 09/00 → 05/05 | D | ATD | |
| | 85 | 02/99 → 06/01 | D | AJM, AUY | |
| | 96 | 11/00 → 05/05 | D | ASZ | |
| | 110 | 05/00 → 05/05 | D | ARL | |

Caddy III

| | | | | | |
|---------|-----|---------------|---|-----|--|
| 2.0 TDI | 103 | 09/07 → 08/10 | D | BMM | |
|---------|-----|---------------|---|-----|--|

Eos

| | | | | | |
|-------------|-----|---------------|---|------------|--|
| 2.0 TDI | 103 | 06/06 → 05/08 | D | BMM | |
| 2.0 TDI 16V | 103 | 05/08 → | D | CBAB, CFFB | |

Golf IV, Variant, Cabrio

| | | | | | |
|-----------------|---------------|---------------|-----|----------|--------|
| 1.9 TDI | 74 | 09/00 → 06/05 | D | ATD, AXR | |
| | 85 | 12/98 → 06/01 | D | AJM, AUY | |
| | 96 | 11/00 → 06/05 | D | ASZ | |
| | 110 | 06/01 → 06/06 | D | ARL | |
| | 110 | 05/00 → 06/05 | D | ARL | M: ARL |
| 1.9 TDI 4motion | 74 | 09/00 → 06/05 | D | ATD | |
| | 85 | 05/99 → 06/01 | D | AJM | |
| | 85 | 09/99 → 06/01 | D | AJM, AUY | |
| | 96 | 11/00 → 06/05 | D | ASZ | |
| | 110 | 05/02 → 06/05 | D | ARL | |
| 110 | 02/00 → 06/05 | D | ARL | M: ARL | |

81816 350981816000

VOLKSWAGEN
Golf V, Plus, Variant

| | | | | | |
|---------------------|-----|---------------|---|-----------------|--|
| 2.0 TDI | 81 | 01/09 → 12/13 | D | CBDC, CLCA | |
| | 96 | 05/05 → 05/07 | D | BEE | |
| | 100 | 06/07 → 07/09 | D | AZV | |
| | 100 | 10/03 → 11/08 | D | AZV, CBDA | |
| | 100 | 05/05 → 12/13 | D | AZV, CBDA, CFHB | |
| | 103 | 12/05 → 05/11 | D | BMM | |
| 2.0 TDI 16V | 125 | 11/05 → 11/08 | D | BMN | |
| | 103 | 10/03 → 11/08 | D | BKD | |
| | 103 | 06/07 → 07/09 | D | BKD, CBDB | |
| | 103 | 01/05 → 12/13 | D | BKD, CBDB, CFHC | |
| 2.0 TDI 16V 4motion | 103 | 08/04 → 11/08 | D | BKD | |
| 2.0 TDI 4motion | 100 | 06/07 → 07/09 | D | AZV | |
| | 103 | 08/04 → 11/08 | D | BMM | |

Golf VI, Variant, Cabrio

| | | | | | |
|-----------------|-----|---------------|---|------------------------|---------|
| 2.0 TDI | 81 | 10/08 → 11/12 | D | CBDC, CLCA | |
| | 100 | 10/08 → 11/12 | D | CBAA, CFFA | M: CBAA |
| | 100 | 07/09 → 07/13 | D | CBDA, CFHB | |
| | 103 | 10/08 → 05/13 | D | CBAB, CFFB, CJAA | |
| | 125 | 04/09 → 11/12 | D | CBBB, CFGB | |
| 2.0 TDI 16V | 103 | 07/09 → 07/13 | D | CBDB, CFHC, CJAA, CLCB | |
| 2.0 TDI 4motion | 103 | 05/09 → 11/12 | D | CBAB, CFFB | M: CBAB |

Jetta III

| | | | | | |
|-------------|-----|---------------|---|-----------------------|--|
| 2.0 TDI | 100 | 09/05 → 10/10 | D | AZV, CBDA | |
| | 103 | 10/05 → 10/10 | D | BMM | |
| | 125 | 10/06 → 10/10 | D | BMN, CEGA | |
| 2.0 TDI 16V | 103 | 08/05 → 10/10 | D | BKD, CBDB, CBEA, CJAA | |

New Beetle, Cabrio

| | | | | | |
|---------|----|---------------|---|-----|--|
| 1.9 TDI | 74 | 06/03 → 09/10 | D | AXR | |
| | 77 | 07/05 → 09/10 | D | BSW | |

Passat IV, Variant

| | | | | | |
|-----------------|----|---------------|---|----------|--|
| 1.9 TDI | 74 | 02/00 → 11/00 | D | AVB | |
| | 85 | 08/98 → 11/00 | D | AJM, ATJ | |
| 1.9 TDI 4motion | 85 | 08/99 → 11/00 | D | ATJ | |

81816
350981816000

KW

VOLKSWAGEN
Passat V, Variant

| | | | | |
|--------------------|-----|---------------|---|----------|
| 1.9 TDI | 74 | 11/00 → 05/05 | D | AVB |
| | 96 | 11/00 → 05/05 | D | AVF, AWX |
| | 96 | 11/00 → 05/05 | D | AVF, AWX |
| 1.9 TDI 4motion | 96 | 11/00 → 05/05 | D | AVF |
| | 96 | 11/00 → 05/05 | D | AVF |
| 2.0 TDI | 100 | 12/03 → 05/05 | D | BGW, BHW |

Passat VI, Variant, CC

| | | | | |
|------------------------|-----|---------------|---|------------------|
| 2.0 BlueTDI | 105 | 01/09 → 11/10 | D | CBAC |
| 2.0 TDI | 81 | 11/08 → 07/10 | D | CBDC |
| | 88 | 11/05 → 05/07 | D | BWV |
| | 90 | 08/05 → 07/06 | D | BVE |
| | 100 | 03/05 → 11/10 | D | BMA, CBAA |
| | 100 | 06/08 → 05/11 | D | CBAA, CFFA |
| | 103 | 03/05 → 05/09 | D | BMP |
| | 103 | 06/08 → 01/12 | D | CBAB, CFFB |
| | 120 | 08/05 → 05/09 | D | BUZ |
| | 125 | 08/05 → 07/10 | D | BMR, CBBB |
| | 125 | 06/08 → 01/12 | D | CBBB, CFGB, CLLA |
| 2.0 TDI 16V | 103 | 03/05 → 07/10 | D | BKP, CBAB |
| 2.0 TDI 16V 4motion | 103 | 03/05 → 08/10 | D | BKP, CBAB |
| 2.0 TDI 4motion | 103 | 03/05 → 05/09 | D | BMP |
| | 103 | 08/09 → 01/12 | D | CBAB, CFFB |
| | 125 | 05/09 → 07/10 | D | CBBB |
| | 125 | 11/09 → 01/12 | D | CBBB, CFGB |

Scirocco III

| | | | | |
|---------|-----|---------|---|------------|
| 2.0 TDI | 103 | 08/08 → | D | CBDB, CFHC |
| | 125 | 05/09 → | D | CBBB, CFGB |

Sharan I

| | | | | | |
|--------------------|-----|---------------|---|--------------|----------------------|
| 1.9 TDI | 66 | 09/95 → 03/10 | D | 1Z, AHU, ANU | 03-2000 →, M: ANU |
| | 85 | 04/00 → 03/10 | D | AUY, BVK | |
| 1.9 TDI 4motion | 85 | 04/00 → 03/10 | D | AUY, BVK | |
| 2.0 TDI | 100 | 11/05 → 03/10 | D | BVH | |
| | 103 | 11/05 → 03/10 | D | BRT | |

Tiguan I

| | | | | |
|--------------------|-----|---------------|---|------------------|
| 2.0 TDI | 103 | 03/08 → | D | CBAB, CFFB |
| 2.0 TDI 4motion | 100 | 11/07 → | D | CBAA, CFFA |
| | 103 | 09/07 → | D | CBAB, CFFB, CLJA |
| | 120 | 02/08 → 08/09 | D | CBBA |
| | 125 | 09/07 → | D | CBBB, CFGB |

81816
350981816000

KW

VOLKSWAGEN
Touran I

| | | | | |
|-------------|-----|---------------|---|-----------|
| 2.0 TDI | 100 | 02/03 → 05/10 | D | AZV |
| | 103 | 12/05 → 05/10 | D | BMM |
| | 125 | 12/05 → 05/10 | D | BMN, CFJA |
| 2.0 TDI 16V | 103 | 08/03 → 05/10 | D | BKD |

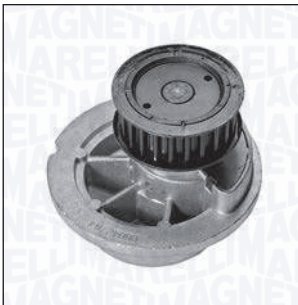
81817
350981817000

PULEGGIA

| | |
|----------------------------|-------|
| Diametro Puleggia | Ø57.2 |
| Numero Denti/Gole Puleggia | 23 |
| Altezza Puleggia | 21 |
| Posizione Attacco | 60.5 |
| Diametro Girante | Ø56 |
| N° Alette Girante | 8 |
| Posizione Girante | 35 |

KW

OPEL
Astra G, Station Wagon, Coupé, Cabrio, Van

| | | | | | |
|---------|----|---------------|---|-----------------------------|---|
| 1.4 16V | 66 | 02/98 → 01/05 | B | X14XE, Z14XE | 09-2000 →, M →: 20U75999, M →: 02MV7225, M →: 20U75999 |
| | | | | | |
| 1.6 16V | 74 | 02/98 → 01/05 | B | C16SEL, X16XEL, Z16XE | M →: 02MV7225, M →: 20U75999 |
| | | | | X16XEL, Z16XE | M →: 02MV7225, M →: 20U75999 |
| | | | | Z16XE | M →: 02MV7225, M →: 20U75999 |
| | | | | Z16XE | |
| 1.6 CNG | 71 | 03/03 → 07/04 | | Z16YNG | |
| 1.6 LPG | 74 | 06/02 → 01/05 | | Z16XE | |

Combo B

| | | | | |
|----------------|----|---------|--|--------|
| 1.6 CNG | 69 | 06/06 → | | Z16YNG |
| | 71 | 04/05 → | | Z16YNG |
| 1.6 CNG 16V | 69 | 06/06 → | | Z16YNG |
| | 71 | 04/05 → | | Z16YNG |

Corsa C, Van

| | | | | |
|-----|----|---------------|---|-------|
| 1.4 | 66 | 09/00 → 12/09 | B | Z14XE |
|-----|----|---------------|---|-------|

Meriva A

| | | | | |
|---------|----|---------------|---|-------|
| 1.6 16V | 74 | 05/03 → 01/06 | B | Z16XE |
|---------|----|---------------|---|-------|

81817 350981817000

KW

OPEL
Vectra B, Station Wagon

| | | | | | |
|-----------|----|---------------|---|----------------------------|---------------------------------|
| 1.6 i 16V | 74 | 10/95 → 04/02 | B | X16XEL, Y16XE, Z16XE | M →: 20U75999, M →: 02MV7225 |
| | 74 | 10/95 → 07/02 | B | X16XEL, Y16XE, Z16XE | M →: 02MZ5254 |
| | 74 | 11/96 → 07/02 | B | X16XEL, Y16XE, Z16XE | M →: 20U75999, M →: 02MZ5254 |

Vectra C, Station Wagon

| | | | | | |
|---------|----|---------|---|-------|--|
| 1.6 | 74 | 08/05 → | B | Z16XE | |
| 1.6 16V | 74 | 06/04 → | B | Z16XE | |

Zafira A

| | | | | | |
|---------|----|---------------|---|------------------|---|
| 1.6 16V | 74 | 04/99 → 06/05 | B | X16XEL, Z16XE | 07-2000 →, M →: 02MV7225, M →: 20U75999, M →: 02MV7225 |
| 1.6 CNG | 71 | 09/01 → 06/05 | | Z16YNG | |

Zafira B, Van

| | | | | | |
|------------------|-----|---------|--|-------------------|--|
| 1.6 CNG | 69 | 01/06 → | | Z16YNG | |
| 1.6 CNG Turbo | 110 | 02/09 → | | A16XNT, Z16XNT | |

VAUXHALL
ASTRA

| | | | | | |
|---------|----|---------------|---|--|-----------|
| 1.4 16V | 66 | 02/98 → 05/05 | B | X14XE, Z14XE | 09-2000 → |
| 1.6 16V | 74 | 09/98 → 05/05 | B | C16SEL, X16XEL, Z16XE, Z16XEP | 09-2000 → |
| | 74 | 02/98 → 05/05 | B | X16XEL, Z16XE | 09-2000 → |
| | 74 | 03/01 → 10/05 | B | Z16XE | |

CORSA

| | | | | | |
|---------|----|---------------|---|-------|--|
| 1.4 16V | 66 | 09/00 → 10/06 | B | Z14XE | |
|---------|----|---------------|---|-------|--|

MERIVA

| | | | | | |
|-----------|----|---------------|---|-------|--|
| 1.6 i 16V | 74 | 01/03 → 09/05 | B | Z16XE | |
|-----------|----|---------------|---|-------|--|

ZAFIRA

| | | | | | |
|---------|----|---------------|---|------------------|-----------|
| 1.6 16V | 74 | 04/99 → 08/05 | B | X16XEL, Z16XE | 07-2000 → |
|---------|----|---------------|---|------------------|-----------|

81818 350981818000

KW

PULEGGIA

| | |
|----------------------------|-------|
| Diametro Puleggia | Ø56.3 |
| Numero Denti/Gole Puleggia | 19 |
| Altezza Puleggia | 20 |
| Posizione Attacco | 58.2 |
| Diametro Girante | Ø56 |
| N° Alette Girante | 8 |
| Posizione Girante | 35 |

KW

OPEL
Astra G, Station Wagon, Coupé, Cabrio, Van

| | | | | | |
|---------|----|---------------|---|------------------|---------------------------------|
| 1.4 16V | 66 | 09/98 → 01/05 | B | X14XE, Z14XE | 09-2000 → |
| 1.6 | 62 | 09/00 → 01/05 | B | Z16SE | M →: 02MZ5254, M →: 20U75999 |
| | 62 | 09/00 → 07/04 | B | Z16SE | M →: 20U75999, M →: 02MZ5254 |
| | 76 | 12/02 → 12/09 | B | Z16XEP | |
| 1.6 16V | 74 | 09/98 → 01/05 | B | X16XEL, Z16XE | 09-2000 → |

Combo B

| | | | | | |
|-----|----|---------|---|-------|----------|
| 1.6 | 64 | 10/01 → | B | Z16SE | M: Z16SE |
| | 64 | 10/01 → | B | Z16SE | |

Meriva A

| | | | | | |
|-----|----|---------------|---|-------|--|
| 1.6 | 64 | 05/03 → 05/10 | B | Z16SE | |
|-----|----|---------------|---|-------|--|

Vectra B, Station Wagon

| | | | | | |
|-------|----|---------------|---|--------|-----------------------------|
| 1.6 i | 55 | 10/95 → 04/02 | B | X16SZR | 01-2000 →, M →: 02MZ5254 |
| | 55 | 10/95 → 07/03 | B | X16SZR | M →: 02MZ5254 |

VAUXHALL
ASTRA

| | | | | | |
|-----|----|---------------|---|-------|--|
| 1.6 | 62 | 09/00 → 05/05 | B | Z16SE | |
|-----|----|---------------|---|-------|--|

MERIVA

| | | | | | |
|-------|----|---------------|---|-------|--|
| 1.6 i | 64 | 01/03 → 06/10 | B | Z16SE | |
|-------|----|---------------|---|-------|--|

81819
350981819000

PULEGGIA

| | |
|-------------------|------|
| Diametro Puleggia | Ø74 |
| Altezza Puleggia | 31.5 |
| Posizione Attacco | 60 |
| Diametro Girante | Ø79 |
| N° Alette Girante | 5 |
| Posizione Girante | 28.8 |

AUDI
A4 II, Avant, Cabriolet

| | | | | | |
|-------------|-----|---------------|---|----------|--|
| 3.0 | 160 | 04/01 → 12/04 | B | BBJ | |
| | 162 | 09/01 → 12/04 | B | ASN | |
| | 162 | 11/00 → 12/04 | B | ASN, AVK | |
| 3.0 quattro | 160 | 04/01 → 12/04 | B | BBJ | |
| | 162 | 05/03 → 12/05 | B | ASN | |
| | 162 | 09/01 → 12/04 | B | ASN, AVK | |
| | 162 | 11/00 → 12/04 | B | ASN, AVK | |

A4 III, Avant

| | | | | | |
|-------------|-----|---------------|---|-----|--|
| 3.0 | 160 | 11/04 → 05/06 | B | BBJ | |
| 3.0 quattro | 160 | 11/04 → 07/06 | B | BBJ | |

A6 II, Avant

| | | | | | |
|-------------|-----|---------------|---|-----|--|
| 3.0 | 162 | 08/01 → 01/05 | B | ASN | |
| 3.0 quattro | 160 | 06/01 → 07/04 | B | BBJ | |
| | 162 | 08/01 → 01/05 | B | ASN | |

A6 III, Avant, Allroad

| | | | | | |
|-------------|-----|---------------|---|-----|--|
| 3.0 | 160 | 08/04 → 05/06 | B | BBJ | |
| 3.0 quattro | 160 | 05/04 → 05/06 | B | BBJ | |

A8 II

| | | | | | |
|-------------|-----|---------------|---|-----|--|
| 3.0 | 160 | 07/03 → 05/06 | B | BBJ | |
| | 162 | 07/03 → 05/05 | B | ASN | |
| 3.0 quattro | 160 | 11/03 → 05/04 | B | BBJ | |

81820
350981820000

PULEGGIA

| | |
|-------------------|-------|
| Diametro Puleggia | Ø56.2 |
| Altezza Puleggia | 27 |
| Posizione Attacco | 53.4 |
| Diametro Girante | Ø60 |
| N° Alette Girante | 6 |
| Posizione Girante | 5.5 |

DACIA
Sandero I

| | | | | | |
|---------|----|---------|---|--------|--|
| 1.2 16V | 55 | 11/08 → | B | D4F732 | |
|---------|----|---------|---|--------|--|

NISSAN
Kubistar

| | | | | | |
|---------|----|---------------|---|--------|--|
| 1.2 16V | 55 | 04/06 → 10/09 | B | D4F712 | |
|---------|----|---------------|---|--------|--|

RENAULT
Clio II

| | | | | | |
|---------|----|---------|---|--|-----------|
| 1.2 16V | 55 | 06/01 → | B | D4F706, D4F712, D4F714, D4F722, D4F728 | → 05-2003 |
|---------|----|---------|---|--|-----------|

Clio III, Grandtour

| | | | | | |
|-------------|----|---------|---|--------|--|
| 1.2 16V | 76 | 09/10 → | B | D4F786 | |
| 1.2 Ethanol | 55 | 07/08 → | | | |

Clio IV, Grandtour

| | | | | | |
|---------|----|---------|---|-------------------|--|
| 1.2 16V | 54 | 11/12 → | B | D4F728, D4F740 | |
| | 54 | 01/13 → | B | D4F740 | |

Kangoo I, Van

| | | | | | |
|---------|----|---------|---|---|--|
| 1.2 16V | 55 | 06/01 → | B | D4F712, D4F714, D4F716, D4F730 | |
| | 55 | 10/01 → | B | D4F712, D4F714, D4F730 | |

Modus

| | | | | | |
|--------------------|----|---------|---|--------|--|
| 1.2 | 48 | 05/05 → | B | D4F740 | |
| | 55 | 12/04 → | B | D4F740 | |
| | 58 | 12/04 → | B | D4F764 | |
| 1.2 16V | 74 | 05/07 → | B | D4F784 | |
| 1.2 16V Hi-Flex | 55 | 10/08 → | | D4F740 | |

Thalia I

| | | | | | |
|---------|----|---------|---|-------------------|--|
| 1.2 16V | 55 | 04/02 → | B | D4F706, D4F712 | |
|---------|----|---------|---|-------------------|--|

81820 350981820000

RENAULT
Twingo I

| | | | | |
|---------|----|---------------|---|--------|
| 1.2 16V | 44 | 08/04 → 06/07 | B | D4F708 |
| | 55 | 01/01 → | B | D4F702 |

81821 350981821000

FLANGIA

| | |
|-------------------------|-------|
| Numero Fori Flangia | 4 |
| Dimensione Fori Flangia | M6×1 |
| Posizione Attacco | 58.2 |
| Diametro Mozzo | Ø35.8 |
| Diametro Girante | Ø56.5 |
| N° Alette Girante | 6 |
| Posizione Girante | 21.2 |

MINI
Mini I (R50,R52, R53)

| | | | | |
|-------|----|---------------|---|--------|
| One D | 55 | 06/03 → 09/06 | D | 1ND |
| | 65 | 06/03 → 09/06 | D | 1ND-TV |

TOYOTA
Auris I, Van

| | | | | | |
|----------|----|---------------|---|--------|-----------|
| 1.4 D-4D | 66 | 03/07 → 09/12 | D | 1ND-TV | → 01-2009 |
|----------|----|---------------|---|--------|-----------|

Corolla Verso

| | | | | | |
|----------|----|---------------|---|--------|-----------|
| 1.4 D-4D | 66 | 03/04 → 03/09 | D | 1ND-TV | → 01-2009 |
|----------|----|---------------|---|--------|-----------|

Corolla VIII, Hatchback, Station Wagon

| | | | | | |
|----------|----|---------|---|--------|-----------|
| 1.4 D-4D | 66 | 01/07 → | D | 1ND-TV | → 01-2009 |
|----------|----|---------|---|--------|-----------|

Yaris II

| | | | | |
|----------|----|---------|---|--------|
| 1.4 D-4D | 66 | 08/05 → | D | 1ND-TV |
|----------|----|---------|---|--------|

VOLKSWAGEN
Passat VII, Variant, CC, AllTrack

| | | | | | |
|---------|----|---------------|---|------|-----------|
| 1.4 TSI | 90 | 08/10 → 12/14 | B | CAXA | → 01-2009 |
|---------|----|---------------|---|------|-----------|

81822 350981822000

PULEGGIA

| | |
|----------------------------|------|
| Diametro Puleggia | Ø150 |
| Numero Denti/Gole Puleggia | 3 |
| Posizione Attacco | 76 |
| Diametro Girante | Ø80 |
| N° Alette Girante | 10 |
| Posizione Girante | -1 |

CITROËN
C 25

| | | | | | |
|-----------------|----|---------------|---|-------------------|-------|
| 1.9 D | 51 | 07/87 → 02/94 | D | D9B (XUD9A/U) | (-)AC |
| 1.9 D 1400 | 51 | 01/88 → 01/94 | D | DJY (XUD9A) | (-)AC |
| 1.9 TD | 60 | 04/92 → 02/94 | D | M705 | (-)AC |
| 2.5 D | 54 | 10/85 → 02/94 | D | CRD93L (U25-661) | (-)AC |
| 2.5 D 4x4 | 54 | 01/87 → 02/94 | D | CRD93L (U25-661) | (-)AC |
| 2.5 D Turbo | 70 | 08/87 → 02/94 | D | CRD93LS (U25-673) | (-)AC |
| 2.5 D Turbo 4x4 | 70 | 08/87 → 02/94 | D | CRD93LS (U25-673) | (-)AC |
| 2.5 DT | 70 | 01/87 → 01/94 | D | CRD93LS (U25-673) | (-)AC |

CX II, Break

| | | | | | |
|--------------|-----|---------------|---|---------|-------|
| 25 D | 54 | 08/85 → 12/92 | D | M25-660 | |
| 25 D Turbo | 88 | 01/87 → 12/92 | D | M25-669 | |
| 25 D Turbo 2 | 88 | 01/87 → 12/92 | D | M25-669 | |
| 25 GTi | 89 | 05/86 → 12/92 | B | M25-668 | (-)AC |
| 25 GTi | 115 | 09/86 → 12/92 | B | M25-667 | (-)AC |
| Turbo 2 | 122 | 08/85 → 12/92 | B | M25-662 | (-)AC |
| 25 i | 89 | 05/86 → 12/92 | B | M25-668 | (-)AC |
| 25 TRi | 100 | 08/85 → 12/92 | B | M25-659 | (-)AC |

FIAT
Ducato I

| | | | | |
|-------|----|---------------|---|---------------------------|
| 2.5 D | 55 | 01/82 → 08/90 | D | 8144.67, CRD93L (U25-661) |
|-------|----|---------------|---|---------------------------|

PEUGEOT
J5 I

| | | | | |
|--------|----|---------------|---|---------------------------|
| 2.5 D | 54 | 09/81 → 08/90 | D | CRD93 |
| | 54 | 09/81 → 09/90 | D | CRD93 (U25/661) |
| 2.5 DT | 70 | 09/81 → 08/90 | D | CRD93L, CRD93LS (U25/673) |

81822
350981822000

PEUGEOT
J5 II

| | | | | | |
|------------|----|---------------|---|-------------------|--|
| 2.5 D | 54 | 09/90 → 01/94 | D | CRD93 | |
| | 54 | 10/90 → 02/94 | D | CRD93 (U25/661) | |
| 2.5 D 4x4 | 54 | 10/90 → 02/94 | D | CRD93 (U25/661) | |
| 2.5 DT | 70 | 09/90 → 01/94 | D | CRD93L | |
| 2.5 TD | 70 | 10/90 → 02/94 | D | CRD93LS (U25/673) | |
| 2.5 TD 4x4 | 70 | 10/90 → 02/94 | D | CRD93LS (U25/673) | |

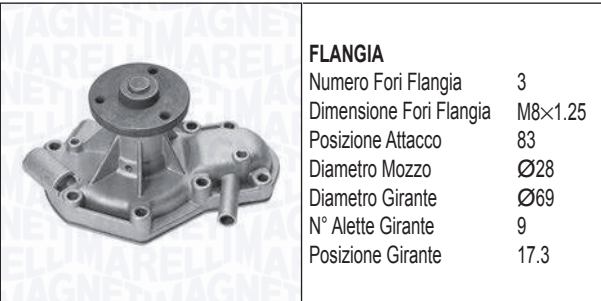
81828
350981828000

FLANGIA

Numero Fori Flangia 3
 Dimensione Fori Flangia M8x1.25
 Posizione Attacco 83
 Diametro Mozzo Ø28
 Diametro Girante Ø69
 N° Alette Girante 9
 Posizione Girante 17.3

RENAULT
25

| | | | | | |
|-----|----|---------------|---|--|----------------|
| 2.0 | 74 | 04/84 → 12/92 | B | J6R706, J6R707, J6R760, J6R762, J6R763 | → M: F.308.131 |
|-----|----|---------------|---|--|----------------|

Master I

| | | | | | |
|-----------|----|---------------|---|----------------|---------------|
| 28-35 2.0 | 58 | 10/86 → 07/98 | B | J5R718 | → M: F029.328 |
| | 58 | 10/86 → 07/98 | B | J5R728 | → M: F029.328 |
| 30 2.2 | 67 | 08/80 → 07/98 | B | J7T782, J7T788 | → M: F305.272 |

Trafic I

| | | | | | |
|-----|----|---------------|---|--------|--------------------------|
| 2.0 | 59 | 05/89 → 08/90 | B | J5R716 | 01-1981 →, → M: F029.328 |
| | 59 | 05/89 → 08/90 | B | J5R726 | 01-1981 →, → 08-1994 |
| 2.2 | 70 | 05/89 → 06/94 | B | J7T780 | 01-1981 → |
| | 74 | 06/94 → 10/97 | B | J7T600 | 01-1981 →, → M: F305.272 |

81832
350981832000

FLANGIA

Numero Fori Flangia 3
 Dimensione Fori Flangia M8x1.25
 Posizione Attacco 94.5
 Diametro Mozzo Ø40
 Diametro Girante Ø68
 N° Alette Girante 8
 Posizione Girante -0.5

VOLKSWAGEN
Transporter III

| | | | | | |
|------------|----|---------------|---|----|--|
| 2.1 | 64 | 10/86 → 07/92 | B | SR | |
| | 70 | 08/85 → 07/92 | B | MV | |
| | 82 | 08/84 → 07/92 | B | DJ | |
| 2.1 Cat. | 70 | 06/89 → 07/92 | B | MV | |
| 2.1 i | 68 | 07/89 → 07/92 | B | SS | |
| 2.1 Syncro | 64 | 10/86 → 07/92 | B | SR | |
| | 70 | 08/85 → 07/92 | B | MV | |
| | 82 | 01/86 → 07/92 | B | DJ | |

81833
350981833000

PULEGGIA

Diametro Puleggia Ø59.3
 Numero Denti/Gole Puleggia 20
 Altezza Puleggia 21
 Posizione Attacco 32.5
 Diametro Girante Ø72
 N° Alette Girante 7
 Posizione Girante 33

VOLKSWAGEN
LT I 28-35, 40-55

| | | | | | |
|---------|----|---------------|---|----|--|
| 2.4 | 66 | 12/82 → 07/92 | B | DL | |
| 2.4 4WD | 66 | 12/82 → 07/92 | B | DL | |
| 2.4 i | 69 | 08/89 → 06/96 | B | 1E | |

81834
350981834000

FLANGIA

| | |
|-------------------------|---------|
| Numero Fori Flangia | 3 |
| Dimensione Fori Flangia | M8×1.25 |
| Posizione Attacco | 78 |
| Diametro Centraggio | Ø50 |
| Diametro Girante | Ø93.5 |
| N° Alette Girante | 8 |
| Posizione Girante | 14.5 |

KW

OPEL
Movano A

| | | | | | |
|---------|----|---------------|---|-------------------|-----------|
| 2.5 D | 59 | 07/98 → 09/00 | D | S8U770, S8U772 | |
| 2.8 DTI | 84 | 01/99 → 10/01 | D | S9W700, S9W702 | → 12-1999 |

RENAULT
Master II

| | | | | | |
|---------|----|---------------|---|--------|-----------|
| 2.5 D | 59 | 07/98 → 01/01 | D | S8U770 | |
| 2.8 dTI | 84 | 07/98 → 10/01 | D | S9W702 | → 12-1999 |

VAUXHALL
Movano

| | | | | | |
|-------|----|---------------|---|--------|--|
| 2.5 D | 59 | 10/98 → 01/01 | D | S8U770 | |
|-------|----|---------------|---|--------|--|

81835
350981835000

FLANGIA

| | |
|-------------------------|---------|
| Numero Fori Flangia | 3 |
| Dimensione Fori Flangia | M8×1.25 |
| Posizione Attacco | 82.6 |
| Diametro Mozzo | Ø27.88 |
| Diametro Girante | Ø93.5 |
| N° Alette Girante | 8 |
| Posizione Girante | 14.5 |

KW

OPEL
Movano A

| | | | | | |
|---------|----|---------------|---|-------------------|----------|
| 2.8 DTI | 84 | 07/98 → 10/01 | D | S9W700, S9W702 | |
| | 84 | 01/99 → 10/01 | D | S9W700, S9W702 | 01-2000→ |

RENAULT
Master II

| | | | | | |
|---------|----|---------------|---|--------|----------|
| 2.8 dTI | 84 | 07/98 → 10/01 | D | S9W702 | 01-2000→ |
|---------|----|---------------|---|--------|----------|

VAUXHALL
Movano

| | | | | | |
|---------|----|---------------|---|--------|--|
| 2.8 DTI | 84 | 10/98 → 10/01 | D | S9W702 | |
| | 84 | 10/98 → 10/01 | D | S9W702 | |

81836
350981836000

FLANGIA

| | |
|-------------------------|------|
| Numero Fori Flangia | 3 |
| Dimensione Fori Flangia | M6×1 |
| Posizione Attacco | 74.9 |
| Diametro Girante | Ø70 |
| N° Alette Girante | 7 |
| Posizione Girante | 4.3 |

KW

OPEL
Astra G, Station Wagon, Coupé, Cabrio, Van

| | | | | | |
|-------------|----|---------------|---|--------|---------------------------|
| 1.7 CDTI | 59 | 04/03 → 12/09 | D | Z17DTL | |
| 1.7 DTI 16V | 55 | 02/00 → 01/05 | D | Y17DT | 09-2000 →, M →: 073533 |
| | 55 | 02/00 → 01/05 | D | Y17DT | |

Astra H, Station Wagon, GTC, Twin Top, Van

| | | | | | |
|----------|----|---------|---|-------------------|--------------|
| 1.7 CDTI | 59 | 03/04 → | D | Z17DTL | |
| | 74 | 03/04 → | D | Z17DTH | → T: 1874032 |
| | 74 | 03/04 → | D | Z17DTH | |
| | 81 | 02/07 → | D | A17DTJ | |
| | 81 | 02/07 → | D | A17DTJ, Z17DTJ | |
| | 81 | 02/07 → | D | Z17DTJ | |
| | 92 | 02/07 → | D | A17DTR | |
| | 92 | 02/07 → | D | A17DTR, Z17DTR | |

Combo B

| | | | | | |
|--------------|----|---------|---|--------|--|
| 1.4 | 66 | 10/04 → | B | Z14XEP | |
| 1.7 CDTI 16V | 74 | 12/04 → | D | Z17DTH | |
| 1.7 DI 16V | 48 | 10/01 → | D | Y17DTL | |
| 1.7 DTI 16V | 55 | 10/01 → | D | Y17DT | |

Corsa C, Van

| | | | | | |
|-------------|----|---------------|---|--------|--|
| 1.7 CDTI | 74 | 06/03 → 12/09 | D | Z17DTH | |
| 1.7 DI | 48 | 09/00 → 12/09 | D | Y17DTL | |
| 1.7 DI 16V | 48 | 09/00 → | D | Y17DTL | |
| 1.7 DTI | 55 | 09/00 → 12/09 | D | Y17DT | |
| 1.7 DTI 16V | 55 | 09/00 → | D | Y17DT | |

Corsa D, Van

| | | | | | |
|----------|----|---------|---|--------|--------------|
| 1.7 CDTI | 92 | 07/06 → | D | Z17DTR | → T: 1874032 |
| | 96 | 06/10 → | D | A17DTS | → T: 1874032 |

Meriva A

| | | | | | |
|----------|----|---------------|---|-------------------|--|
| 1.7 CDTI | 74 | 09/03 → 05/10 | D | Z17DT, Z17DTH | |
| | 92 | 09/06 → 05/10 | D | A17DTR, Z17DTR | |
| 1.7 DTI | 55 | 09/03 → 05/10 | D | Y17DT | |

81836 **350981836000**



OPEL

Zafira B, Van

| | | | | | |
|----------|----|---------|---|----------------|--------------|
| 1.7 CDTI | 81 | 01/08 → | D | A17DTJ, Z17DTJ | → T: 1874032 |
| | 81 | 01/08 → | D | A17DTJ, Z17DTJ | |
| | 92 | 01/08 → | D | A17DTR | → T: 1874032 |
| | 92 | 01/08 → | D | A17DTR | |

VAUXHALL

Combo

| | | | | | |
|------------|----|---------------|---|--------|--|
| 1.7 DI 16V | 48 | 09/01 → 11/11 | D | Y17DTL | |
|------------|----|---------------|---|--------|--|

81837 **350981837000**



FLANGIA

| | |
|-------------------------|------|
| Numero Fori Flangia | 4 |
| Dimensione Fori Flangia | M6×1 |
| Posizione Attacco | 80 |
| Diametro Mozzo | Ø24 |
| Diametro Girante | Ø55 |
| N° Alette Girante | 6 |
| Posizione Girante | 5.5 |



HYUNDAI

Atos, Atos Prime

| | | | | | |
|-------|----|---------------|---|--------|--|
| 0.8 | 38 | 04/99 → 07/03 | B | G3HJ | |
| 1.0 i | 40 | 02/98 → 03/02 | B | G4HC | |
| | 43 | 03/01 → | B | G4HC-E | |
| 1.1 | 43 | 08/03 → 05/05 | B | G4HD | |

81838 **350981838000**



PULEGGIA

| | |
|----------------------------|------|
| Diametro Puleggia | Ø56 |
| Numero Denti/Gole Puleggia | 19 |
| Altezza Puleggia | 44.5 |
| Posizione Attacco | 61 |
| Diametro Girante | Ø61 |
| N° Alette Girante | 7 |
| Posizione Girante | 14 |



HONDA

Accord VI, Aerodeck, Hatchback, Coupé

| | | | | | |
|--------|----|---------------|---|-------|--|
| 1.6 | 85 | 12/99 → 12/02 | B | D16B6 | |
| | 65 | 10/98 → 12/02 | B | A16A5 | |
| 1.6 i | 85 | 10/98 → 12/02 | B | D16B6 | |
| 1.6 LS | 79 | 10/98 → 12/02 | B | D16B7 | |

Civic VI, Hatchback, Aerodeck, Fastback, Coupé

| | | | | | |
|------------|----|---------------|---|--------------|---------|
| 1.4 16V | 55 | 04/98 → 02/01 | B | D14A7 | M: SOHC |
| | 66 | 04/98 → 02/01 | B | D14A8 | M: SOHC |
| 1.4 i | 55 | 11/95 → 02/01 | B | D14A3, D14Z1 | |
| 1.5 16V | 84 | 04/98 → 02/01 | B | D15Z8 | |
| 1.5 i | 84 | 11/95 → 02/01 | B | D15Z6 | |
| 1.6 | 92 | 11/98 → 10/00 | B | D16W4 | |
| 1.6 16V | 85 | 04/98 → 02/01 | B | D16B2 | |
| 1.6 i | 77 | 03/96 → 03/00 | B | D16Y7 | M: SOHC |
| | 84 | 11/95 → 02/01 | B | D16Y5 | |
| 1.6 i Vtec | 92 | 11/95 → 02/01 | B | D16Y6, D16Y8 | |
| | 92 | 03/96 → 03/00 | B | D16Y8 | |

Civic VII, Hatchback, Coupé

| | | | | | |
|-------|----|---------------|---|-------|--|
| 1.4 i | 55 | 02/01 → 09/05 | B | D14Z6 | |
|-------|----|---------------|---|-------|--|

HR-V

| | | | | | |
|---------|----|---------|---|-------|--|
| 1.6 16V | 77 | 03/99 → | B | D16W1 | |
| 1.6 16V | 77 | 03/99 → | B | D16W1 | |
| 4WD | 91 | 10/99 → | B | D16W5 | |

81839
350981839000

PULEGGIA

| | |
|----------------------------|-----|
| Diametro Puleggia | Ø65 |
| Numero Denti/Gole Puleggia | 22 |
| Altezza Puleggia | 30 |
| Posizione Attacco | 47 |
| Diametro Girante | Ø55 |
| N° Alette Girante | 7 |
| Posizione Girante | 18 |

KW

ACURA
Integra III

| | | | | |
|--------|-----|---------------|---|-------|
| 1.8 LS | 125 | 10/93 → 09/01 | B | F18C1 |
|--------|-----|---------------|---|-------|

HONDA
Civic V, Hatchback, Coupé

| | | | | |
|------------|-----|---------------|---|-------|
| 1.6 i Vtec | 118 | 01/94 → 11/95 | B | B16A2 |
|------------|-----|---------------|---|-------|

| | | | | |
|---------|-----|---------------|---|-------|
| 1.6 VTi | 118 | 10/91 → 11/95 | B | B16A2 |
|---------|-----|---------------|---|-------|

| | | | | |
|-------------|-----|---------------|---|-------|
| 1.6 VTi 16V | 118 | 10/91 → 11/95 | B | B16A2 |
|-------------|-----|---------------|---|-------|

Civic VI, Hatchback, Aerodeck, Fastback, Coupé

| | | | | |
|------------|-----|---------------|---|-------|
| 1.6 i Vtec | 118 | 04/99 → 12/00 | B | B16A2 |
|------------|-----|---------------|---|-------|

| | | | | |
|---------|-----|---------------|---|-------|
| 1.6 VTi | 118 | 01/97 → 02/01 | B | B16A2 |
| | 118 | 11/95 → 02/01 | B | B16A2 |

| | | | | |
|---------|-----|---------------|---|-------|
| 1.8 16V | 124 | 04/98 → 02/01 | B | B18C4 |
|---------|-----|---------------|---|-------|

Integra II

| | | | | |
|------------|-----|---------------|---|-------|
| 1.8 Type-R | 140 | 11/97 → 10/01 | B | B18C6 |
|------------|-----|---------------|---|-------|

81840
350981840000

PULEGGIA

| | |
|----------------------------|-------|
| Diametro Puleggia | Ø67.3 |
| Numero Denti/Gole Puleggia | 27 |
| Altezza Puleggia | 21 |
| Posizione Attacco | 56 |
| Diametro Girante | Ø63.6 |
| N° Alette Girante | 8 |
| Posizione Girante | 35.1 |

KW

AUDI
A2

| | | | | |
|---------|----|---------------|---|-----|
| 1.6 FSI | 81 | 05/02 → 08/05 | B | BAD |
|---------|----|---------------|---|-----|

SEAT
Leon I

| | | | | |
|----------|----|---------------|---|--------------------|
| 1.6 16 V | 77 | 09/00 → 06/06 | B | ATN, AUS, AZD, BCB |
|----------|----|---------------|---|--------------------|

Toledo II

| | | | | |
|---------|----|---------------|---|---------------|
| 1.6 16V | 77 | 06/00 → 05/06 | B | AUS, AZD, BCB |
|---------|----|---------------|---|---------------|

81840
350981840000

KW

VOLKSWAGEN
Bora, Station Wagon

| | | | | |
|---------|----|---------------|---|--------------------|
| 1.6 16V | 77 | 05/00 → 05/05 | B | ATN, AUS, AZD, BCB |
|---------|----|---------------|---|--------------------|

| | | | | |
|---------|----|---------------|---|-----|
| 1.6 FSI | 81 | 01/02 → 05/05 | B | BAD |
|---------|----|---------------|---|-----|

Golf IV, Variant, Cabrio

| | | | | |
|-----|----|---------------|---|-----|
| 1.6 | 78 | 08/03 → 06/05 | B | AWB |
|-----|----|---------------|---|-----|

| | | | | |
|---------|----|---------------|---|--------------------|
| 1.6 16V | 77 | 02/00 → 06/05 | B | ATN, AUS, AZD, BCB |
|---------|----|---------------|---|--------------------|

| | | | | |
|---------|----|---------------|---|---------------|
| 1.6 FSI | 81 | 01/02 → 06/05 | B | BAD → 09-2003 |
|---------|----|---------------|---|---------------|

Lupo I

| | | | | |
|---------|----|---------------|---|-----|
| 1.6 GTI | 92 | 09/00 → 07/05 | B | AVY |
|---------|----|---------------|---|-----|

Polo III (6N1), Classic, Variant, Van

| | | | | |
|-----------------|----|---------------|---|-----|
| 120 1.6 16V GTI | 88 | 09/98 → 10/99 | B | AJV |
|-----------------|----|---------------|---|-----|

Polo IV (6N2)

| | | | | |
|-------------|----|---------------|---|----------|
| 1.6 16V GTI | 92 | 10/99 → 09/01 | B | ARC, AVY |
|-------------|----|---------------|---|----------|

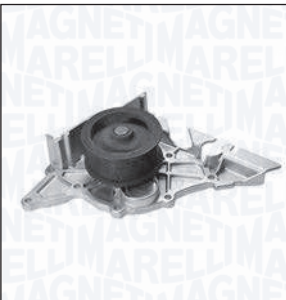
81842
350981842000

PULEGGIA

| | |
|-------------------|------|
| Diametro Puleggia | Ø74 |
| Altezza Puleggia | 31.5 |
| Posizione Attacco | 60.2 |
| Diametro Girante | Ø79 |
| N° Alette Girante | 5 |
| Posizione Girante | 29.4 |

KW

AUDI
A4 I, Avant

| | | | | |
|-----|-----|---------------|---|-----|
| 2.4 | 110 | 07/95 → 07/97 | B | AFM |
|-----|-----|---------------|---|-----|

| | | | | |
|--|-----|---------------|---|---------------|
| | 120 | 08/97 → 11/00 | B | AJG, AMM, APZ |
|--|-----|---------------|---|---------------|

| | | | | |
|--|-----|---------------|---|-------------------------|
| | 121 | 03/97 → 11/00 | B | AGA, ALF, AML, APS, ARJ |
|--|-----|---------------|---|-------------------------|

| | | | | |
|-------------|-----|---------------|---|-----|
| 2.4 quattro | 120 | 08/97 → 11/00 | B | APZ |
|-------------|-----|---------------|---|-----|

| | | | | |
|--|-----|---------------|---|-------------------------|
| | 121 | 03/97 → 11/00 | B | AGA, ALF, AML, APS, ARJ |
|--|-----|---------------|---|-------------------------|

| | | | | |
|-----|-----|---------------|---|-----|
| 2.6 | 102 | 01/96 → 07/97 | B | ACZ |
|-----|-----|---------------|---|-----|

| | | | | |
|--|-----|---------------|---|-----|
| | 110 | 01/95 → 11/00 | B | ABC |
|--|-----|---------------|---|-----|

| | | | | |
|-------------|-----|---------------|---|-----|
| 2.6 quattro | 110 | 01/95 → 11/00 | B | ABC |
|-------------|-----|---------------|---|-----|

| | | | | |
|-------------------|-----|---------------|---|-----|
| 2.7 Turbo quattro | 169 | 02/99 → 09/00 | B | AJK |
|-------------------|-----|---------------|---|-----|

81842
350981842000

KW

AUDI
A4 I, Avant

| | | | | | |
|-------------|-----|---------------|---|------------------------------|----------|
| 2.8 | 128 | 09/95 → 07/97 | B | AAH | |
| | 142 | 10/96 → 11/00 | B | ACK, AHA, ALG, AMX, APR, AQD | |
| 2.8 quattro | 128 | 01/95 → 07/97 | B | AAH | |
| | 142 | 10/96 → 08/01 | B | ACK, AHA, ALG, AMX, APR, AQD | |
| RS4 quattro | 280 | 05/00 → 09/01 | B | ASJ, AZR | |
| S4 quattro | 195 | 09/97 → 09/01 | B | AGB, AZB | 01-1999→ |
| | 195 | 09/97 → 09/01 | B | AGB, AZB | |

A4 II, Avant, Cabriolet

| | | | | | |
|-----|-----|---------------|---|-----|--|
| 2.4 | 120 | 09/01 → 12/04 | B | AMM | |
| | 125 | 09/01 → 12/04 | B | BDV | |

A6 I, Avant

| | | | | | |
|-------------|-----|---------------|---|---------------|--|
| 2.4 | 110 | 07/95 → 06/96 | B | AFM | |
| 2.6 | 102 | 06/94 → 10/97 | B | ACZ | 08-1996 →, →02-1997, T→: F44-S-026-715 |
| | 110 | 06/94 → 10/97 | B | ABC | 08-1996 →, →02-1997, T→: F44-S-026-715 |
| | 110 | 06/94 → 12/97 | B | ABC | 08-1996 →, →12-1997, T→: F44-S-026.715 |
| 2.6 quattro | 110 | 06/94 → 10/97 | B | ABC | 08-1996 →, →02-1997, T→: F44-S-026-715 |
| | 110 | 06/94 → 12/97 | B | ABC | 08-1996 →, →12-1997, T→: F44-S-026.715 |
| 2.8 | 128 | 06/94 → 12/97 | B | AAH, AEJ | 08-1996 →, →12-1997, T→: F44-S-026.715 |
| | 128 | 06/94 → 10/97 | B | AAH, AEJ, AFC | 08-1996 →, →02-1997, T→: F44-S-026.715 |
| | 142 | 12/95 → 10/97 | B | ACK | T→: F44-S-026.715 |

81842
350981842000

KW

AUDI
A6 I, Avant

| | | | | | |
|-------------|-----|---------------|---|----------|--|
| 2.8 quattro | 128 | 06/94 → 10/97 | B | AAH, AEJ | 08-1996 →, →02-1997, T→: F44-S-026.715 |
| | 128 | 06/94 → 12/97 | B | AAH, AEJ | 08-1996 →, →12-1997, T→: F44-S-026.715 |
| 2.8 quattro | 142 | 12/95 → 10/97 | B | ACK | |
| | 142 | 12/95 → 12/97 | B | ACK | T→: F44-S-026.715 |

A6 II, Avant

| | | | | | |
|---------------|-----|---------------|---------------|-------------------------|-------------------|
| 2.4 | 100 | 07/98 → 01/05 | B | ALW, ARN, ASM | |
| | 115 | 02/97 → 01/05 | B | APC | |
| | 120 | 02/97 → 01/05 | B | AJG, AMM, APZ | |
| 2.4 | 121 | 02/97 → 01/05 | B | AGA, ALF, AML, APS, ARJ | |
| | 121 | 12/97 → 01/05 | B | AGA, ALF, AML, APS, ARJ | T→: F44-S-026.715 |
| | 125 | 08/01 → 01/05 | B | BDV | |
| 2.4 quattro | 115 | 08/98 → 07/99 | B | APC | |
| | 120 | 02/97 → 01/05 | B | AJG, APZ | |
| | 121 | 02/97 → 01/05 | B | AGA, ALF, AML, APS, ARJ | |
| 2.4 quattro | 121 | 12/97 → 01/05 | B | AGA, ALF, AML, APS, ARJ | T→: F44-S-026.715 |
| | 125 | 08/01 → 01/05 | B | BDV | |
| | 2.7 | 187 | 05/01 → 07/04 | B | APB, BEL |
| 2.7 quattro | 187 | 05/01 → 07/04 | B | APB, BEL | |
| | 195 | 11/03 → 07/04 | B | BEL | |
| 2.7 T | 169 | 02/99 → 01/05 | B | AJK | T→: F44-S-026.715 |
| | 169 | 02/99 → 01/05 | B | AJK | |
| 2.7 T quattro | 169 | 12/97 → 01/05 | B | AJK, AZA | 01-1999→ |
| | 169 | 12/97 → 01/05 | B | AJK, AZA | T→: F44-S-026.715 |
| | 169 | 12/97 → 01/05 | B | AJK, AZA | |
| | 184 | 08/01 → 01/05 | B | ARE, BES | |

81842 350981842000

AUDI
A6 II, Avant

| | | | | | |
|-----|-----|---------------|---|----------|--|
| 2.8 | 132 | 10/97 → 05/00 | B | AGE | |
| | 140 | 07/99 → 01/05 | B | ATX | |
| | 140 | 07/99 → 01/05 | B | ATX, BBG | |

| | | | | | |
|-----|-----|---------------|---|------------------------------|--------------------|
| 2.8 | 142 | 02/97 → 01/05 | B | ACK, AHA, ALG, AMX, APR, AQD | T →: F44-S-026.715 |
| | 142 | 02/97 → 01/05 | B | ACK, AHA, ALG, AMX, APR, AQD | |

| | | | | | |
|-------------|-----|---------------|---|------------------------------|--------------------|
| 2.8 quattro | 132 | 01/98 → 04/00 | B | AGE | |
| | 140 | 07/99 → 05/01 | B | ATX | |
| | 142 | 02/97 → 01/05 | B | ACK, AHA, ALG, AMX, APR, AQD | T →: F44-S-026.715 |

| | | | | | |
|-------------|-----|---------------|---|-----|--|
| 2.8 quattro | 132 | 01/98 → 04/00 | B | AGE | |
| | 140 | 07/99 → 05/01 | B | ATX | |

| | | | | | |
|-------------|-----|---------------|---|------------------------------|--------------------|
| 2.8 quattro | 142 | 02/97 → 01/05 | B | ACK, AHA, ALG, AMX, APR, AQD | T →: F44-S-026.715 |
| | 142 | 02/97 → 01/05 | B | ACK, AHA, ALG, AMX, APR, AQD | |

| | | | | | |
|-------------|-----|---------------|---|------------------------------|--|
| 2.8 quattro | 142 | 02/97 → 01/05 | B | ACK, AHA, ALG, AMX, APR, AQD | |
| | 142 | 02/97 → 01/05 | B | ACK, AHA, ALG, AMX, APR, AQD | |

A8 I

| | | | | | |
|-----|-----|---------------|---|-------------------------|--------------------|
| 2.8 | 142 | 04/96 → 09/02 | B | ACK, ALG, AMX, APR, AQD | T →: F4D-S-000.497 |
|-----|-----|---------------|---|-------------------------|--------------------|

| | | | | | |
|-------------|-----|---------------|---|--------------------|--------------------|
| 2.8 quattro | 142 | 04/96 → 09/02 | B | ACK, AMX, APR, AQD | T →: F4D-S-000.497 |
|-------------|-----|---------------|---|--------------------|--------------------|

Allroad

| | | | | | |
|---------------|-----|---------------|---|----------|--|
| 2.7 quattro | 187 | 09/00 → 08/05 | B | APB, BEL | |
| 2.7 T quattro | 184 | 05/00 → 08/05 | B | ARE, BES | |

SKODA
Superb I

| | | | | | |
|--------|-----|---------------|---|-----|--|
| 2.8 V6 | 140 | 06/02 → 03/08 | B | BBG | |
| | 142 | 12/01 → 03/08 | B | AMX | |

VOLKSWAGEN
Passat IV, Variant

| | | | | | |
|------------|-----|---------------|---|-----|--|
| 2.8 Syncro | 132 | 05/97 → 09/99 | B | AGE | |
| | 132 | 05/97 → 09/99 | B | AGE | |

| | | | | | |
|--------|-----|---------------|---|--------------------|--|
| 2.8 V6 | 140 | 09/99 → 11/00 | B | ATX, BBG | |
| | 142 | 08/96 → 11/00 | B | ACK, AHA, APR, AQD | |

| | | | | | |
|-----------------------|-----|---------------|---|-------------------------|--|
| 2.8 V6 Syncro/4motion | 142 | 10/96 → 11/00 | B | ACK, AHA, ALG, APR, AQD | |
|-----------------------|-----|---------------|---|-------------------------|--|

Passat V, Variant

| | | | | | |
|-------------|-----|---------------|---|----------|--|
| 2.8 4motion | 142 | 11/00 → 05/05 | B | AMX, ATQ | |
|-------------|-----|---------------|---|----------|--|

81843 350981843000

| | |
|----------------------------|--------|
| PULEGGIA | |
| Diametro Puleggia | Ø53.25 |
| Numero Denti/Gole Puleggia | 18 |
| Altezza Puleggia | 31.5 |
| Posizione Attacco | 64 |
| Diametro Girante | Ø70 |
| N° Alette Girante | 6 |
| Posizione Girante | 18.5 |

ROVER
400 I, Station Wagon

| | | | | | |
|---------------------|-----|---------------|---|-------|-----------|
| 420 GTI/GSI/Vitesse | 103 | 02/92 → 04/95 | B | 20M4F | → 09-1992 |
|---------------------|-----|---------------|---|-------|-----------|

800

| | | | | | |
|-----------|-----|---------------|---|---------|--------------|
| 2.0 E | 84 | 10/88 → 10/91 | B | | → T: 200.604 |
| 2.0 Turbo | 120 | 10/88 → 10/91 | B | | → T: 200.604 |
| 820 | 74 | 10/88 → 10/91 | B | | → T: 200.604 |
| 820 i/Si | 103 | 10/88 → 12/91 | B | 20HD | → T: 200.604 |
| 820 SE/SI | 88 | 10/86 → 12/91 | B | 20HS | → T: 200.604 |
| 820 SI | 98 | 10/88 → 12/91 | B | 20HDM16 | → T: 200.604 |
| 820e | 88 | 10/86 → 10/91 | B | 20HS | → T: 200.604 |

81844 350981844000

| | |
|----------------------------|-------|
| PULEGGIA | |
| Diametro Puleggia | Ø69.7 |
| Numero Denti/Gole Puleggia | 28 |
| Altezza Puleggia | 36.1 |
| Posizione Attacco | 54.2 |
| Diametro Girante | Ø69 |
| N° Alette Girante | 8 |
| Posizione Girante | 57.8 |

CITROËN
Xantia I, Break

| | | | | | |
|-----------|-----|---------------|---|-------------|------------|
| 3.0 i 24V | 140 | 01/97 → 01/98 | B | XFZ (ES9J4) | → T: 08441 |
|-----------|-----|---------------|---|-------------|------------|

Xantia II, Break

| | | | | | |
|--------|-----|---------------|---|-------------|------------|
| 3.0 V6 | 140 | 01/98 → 04/03 | B | XFZ (ES9J4) | → T: 08441 |
|--------|-----|---------------|---|-------------|------------|

XM II, Break

| | | | | | |
|--------|-----|---------------|---|-------------|------------|
| 3.0 V6 | 140 | 04/97 → 10/00 | B | XFZ (ES9J4) | → T: 08441 |
|--------|-----|---------------|---|-------------|------------|

PEUGEOT
407, Station Wagon, Coupé

| | | | | | |
|---------|-----|---------------|---|-------------|---|
| 3.0 24V | 140 | 10/96 → 05/04 | B | XFZ (ES9J4) | → 12-1999, → T: 08441, → PROD: 8554 |
|---------|-----|---------------|---|-------------|---|

| | | | | | |
|------------|-----|---------------|---|-------------|------------|
| 3.0 V6 24V | 140 | 03/97 → 12/04 | B | XFZ (ES9J4) | → T: 08441 |
|------------|-----|---------------|---|-------------|------------|

81844 350981844000



RENAULT

Espace III

3.0 V6 24V 140 10/98 → 10/02 B L7X727 → T: 08441

Laguna I, Grantour

3.0 24V 140 03/97 → 03/01 B L7X700, L7X701 → T: 08441

Safrane II

2.9 24V 140 03/99 → 12/00 B L7X713 → T: 08441

3.0 V6 123 07/96 → 12/00 B Z7X722, Z7X723, Z7X755

Thalia I

3.0 V6 169 04/00 → 09/01 B L7X732

Turbo Sport 187 06/02 → B L7X762

81845 350981845000



PULEGGIA

Diametro Puleggia Ø54.55
 Numero Denti/Gole Puleggia 3
 Posizione Attacco 33.3
 Diametro Girante Ø78.5
 N° Alette Girante 6
 Posizione Girante 32.2



FORD

Cougar

2.5 ST 200 151 01/00 → 12/01 B SGA

2.5 V6 24V 125 06/00 → 12/01 B LCBB, LCBC, LCBE

125 08/98 → 12/01 B LCBA

Maverick II

3.0 V6 24V 145 02/01 → B AJ → 03-2004

Mondeo I, Station Wagon

2.5 i 24V 125 07/94 → 08/96 B SEA

Mondeo II, Station Wagon

2.5 24V 125 06/00 → 09/00 B LCBD, SEB, SEC

125 06/00 → 09/00 B SEB, SEC

125 08/96 → 09/00 B SEA

2.5 ST 200 151 05/99 → 09/00 B SGA

81845 350981845000



JAGUAR

X Type, Estate

2.0 V6 115 03/02 → 10/05 B

2.5 144 02/04 → 12/09 B

2.5 V6 Trazione integrale 144 06/01 → 11/09 B

3.0 169 02/04 → 12/09 B AJ-V6

3.0 V6 Trazione integrale 169 06/01 → 11/07 B AJ-V6

81846 350981846000



FLANGIA

Numero Fori Flangia 3
 Dimensione Fori Flangia M6x1
 Posizione Attacco 72.5
 Diametro Mozzo Ø36
 Diametro Centraggio Ø39
 Diametro Girante Ø55
 N° Alette Girante 6
 Posizione Girante 29.8



OPEL

Calibra

2.5 i V6 125 04/93 → 07/97 B C25XE, X25XE

Omega B, Station Wagon

2.5 V6 125 03/94 → 09/00 B X25XE

2.6 V6 132 09/00 → 07/03 B Y26SE

3.0 V6 155 04/94 → 02/01 B X30XE

3.2 V6 160 02/01 → 07/03 B Y32SE

Signum

3.2 V6 155 05/03 → B Z32SE

Sintra

3.0 i 24V 148 11/96 → 04/99 B X30XE

Vectra A

2.5 V6 125 02/93 → 11/95 B C25XE

Vectra B, Station Wagon

2.5 144 10/99 → 06/00 B X25XE

2.5 i V6 125 10/95 → 09/00 B X25XE

2.6 i V6 125 09/00 → 04/02 B Y26SE

i 500 2.5 143 05/98 → 09/00 B X25XE

Vectra C, Station Wagon

3.2 V6 155 08/02 → B Z32SE

81846 350981846000

RENAULT
Safrane II

| | | | | |
|---------|-----|---------------|---|-------------------|
| 2.5 20V | 121 | 07/96 → 12/00 | B | N7U700, N7U701 |
|---------|-----|---------------|---|-------------------|

SAAB
9-5 I, Station Wagon

| | | | | |
|---------|-----|---------------|---|-------|
| 3.0 V6t | 147 | 01/98 → 12/09 | B | B308E |
|---------|-----|---------------|---|-------|

900 II, Cabrio, Coupé

| | | | | |
|------------|-----|---------------|---|-------|
| 2.5 -24 V6 | 125 | 07/93 → 02/98 | B | B258I |
|------------|-----|---------------|---|-------|

9000

| | | | | |
|------------|-----|---------------|---|-------|
| 3.0 -24 V6 | 155 | 07/94 → 12/98 | B | B308I |
| CD/CDE | 155 | 07/94 → 12/98 | B | B308I |

81852 350981852000

PULEGGIA

| | |
|----------------------------|------|
| Diametro Puleggia | Ø142 |
| Numero Denti/Gole Puleggia | 4 |
| Altezza Puleggia | 20 |
| Posizione Attacco | 80 |
| Diametro Girante | Ø67 |
| N° Alette Girante | 8 |
| Posizione Girante | 18 |

RENAULT
Twingo I

| | | | | | |
|-----|----|---------------|---|-------------------|---------------|
| 1.2 | 40 | 03/93 → 10/96 | B | C3G700, C3G702 | (+)COP, (+)AC |
|-----|----|---------------|---|-------------------|---------------|

81847 350981847000

FLANGIA

| | |
|-------------------------|------|
| Numero Fori Flangia | 4 |
| Dimensione Fori Flangia | M6×1 |
| Posizione Attacco | 74.9 |
| Diametro Girante | Ø70 |
| N° Alette Girante | 7 |
| Posizione Girante | 4.3 |

OPEL
Corso B, Station Wagon, Van

| | | | | |
|-------|----|---------|---|-------------|
| 1.7 D | 44 | 01/99 → | D | X17D (4EE1) |
|-------|----|---------|---|-------------|

Vectra B, Station Wagon

| | | | | |
|--------|----|---------------|---|-------------------|
| 1.7 TD | 60 | 11/96 → 12/97 | D | X17DT (TC4EE1) |
|--------|----|---------------|---|-------------------|

81853 350981853000

PULEGGIA

| | |
|----------------------------|--------|
| Diametro Puleggia | Ø147.2 |
| Numero Denti/Gole Puleggia | 6 |
| Posizione Attacco | 40.4 |
| Diametro Girante | Ø67 |
| N° Alette Girante | 8 |
| Posizione Girante | 18 |

RENAULT
Rapid

| | | | | | |
|-----|----|---------------|---|--|---------------|
| 1.0 | 27 | 02/86 → 05/92 | B | C1C706 | (+)COP, (+)AC |
| 1.1 | 33 | 07/85 → 04/95 | B | C1E750, C1E752, C1E754, C1E756, C1E760, C1E762, C1E792 | (+)COP, (+)AC |
| 1.2 | 40 | 09/91 → 03/98 | B | C3G710, C3G712 | (+)COP, (+)AC |
| 1.4 | 43 | 07/85 → 03/98 | B | C1J768, C1J780, C3J700, C3J702, C3J760, C3J762 | (+)COP, (+)AC |
| | 44 | 03/86 → 08/91 | B | C2J784 | (+)COP, (+)AC |

81851 350981851000

FLANGIA

| | |
|-------------------------|---------|
| Numero Fori Flangia | 4 |
| Dimensione Fori Flangia | M8×1.25 |
| Posizione Attacco | 90.7 |
| Diametro Mozzo | Ø23.9 |
| Diametro Girante | Ø69 |
| N° Alette Girante | 9 |
| Posizione Girante | 17.3 |

RENAULT
25

| | | | | |
|------------|----|---------------|---|--------|
| 2.1 Diesel | 51 | 06/89 → 12/92 | D | J8S736 |
|------------|----|---------------|---|--------|

81853
350981853000

RENAULT
Super 5

| | | | | | |
|--------------|-----|---------------|---|--|---------------|
| 1.1 | 33 | 01/86 → 03/95 | B | C1E750, C1E752, C1E756, C1E760 | (+)COP, (+)AC |
| | 34 | 10/84 → 12/96 | B | C1E750, C1E752, C1E754 | (+)COP, (+)AC |
| 1.2 | 40 | 01/87 → 08/90 | B | C1G702, C1G720, C1G722 | (+)COP, (+)AC |
| | 44 | 01/87 → 12/96 | B | C1G702 | (+)COP, (+)AC |
| 1.4 | 43 | 10/84 → 12/96 | B | C1J768, C1J780, C3J700, C3J702, C3J760 | (+)COP, (+)AC |
| | 44 | 06/87 → 08/90 | B | C2J784 | (+)COP, (+)AC |
| 1.4 Turbo | 88 | 04/85 → 08/90 | B | C1J782, C1J784, C1J788 | (+)COP, (+)AC |
| 1.4 Turbo GT | 118 | 01/85 → 05/91 | B | 840730 | (+)COP, (+)AC |

81854
350981854000

PULEGGIA

| | |
|----------------------------|------|
| Diametro Puleggia | Ø144 |
| Numero Denti/Gole Puleggia | 1 |
| Posizione Attacco | 29.5 |
| Diametro Girante | Ø67 |
| N° Alette Girante | 8 |
| Posizione Girante | 18 |

RENAULT
Clio I

| | | | | | |
|-----|----|---------------|---|--------|--------|
| 1.2 | 40 | 06/94 → 02/98 | B | C3G720 | (+)COP |
| | 40 | 01/96 → 12/96 | B | C3G720 | (+)COP |

Rapid

| | | | | | |
|-----|----|---------------|---|-------------------|---------------------|
| 1.2 | 40 | 09/91 → 03/98 | B | C3G710, C3G712 | (+)COP, 05-1995→ |
|-----|----|---------------|---|-------------------|---------------------|

Twingo I

| | | | | | |
|-----|----|---------------|---|-------------------|---------------|
| 1.2 | 40 | 03/93 → 10/96 | B | C3G700, C3G702 | (+)COP, (-)AC |
|-----|----|---------------|---|-------------------|---------------|

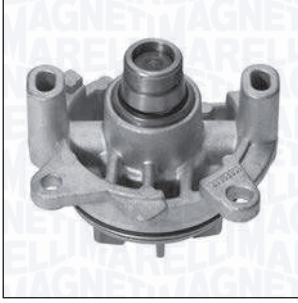
81855
350981855000

FLANGIA

| | |
|-------------------|-------|
| Posizione Attacco | 43.15 |
| Diametro Mozzo | M22×1 |
| Diametro Girante | Ø70 |
| N° Alette Girante | 8 |
| Posizione Girante | 45 |

NISSAN
Interstar

| | | | | |
|--------|----|---------|---|--------|
| dCi 90 | 66 | 07/02 → | D | G9T722 |
|--------|----|---------|---|--------|

Primastar

| | | | | |
|---------|----|---------|---|--------|
| dCi 140 | 99 | 07/03 → | D | G9U730 |
|---------|----|---------|---|--------|

OPEL
Movano A

| | | | | |
|----------|-----|---------|---|---|
| 2.2 DTI | 66 | 09/00 → | D | G9T720, G9T722, G9T750 |
| | 74 | 09/07 → | D | G9U650 |
| 2.5 CDTI | 88 | 08/06 → | D | G9U632, G9U650 |
| | 107 | 08/06 → | D | G9U632, G9U650 |
| 2.5 DTI | 73 | 10/03 → | D | G9U754 |
| | 84 | 10/01 → | D | G9U720, G9U724, G9U750, G9U754 |
| | 84 | 10/01 → | D | G9U720, G9U724, G9U754 |

Vivaro

| | | | | |
|----------|-----|---------|---|------------------|
| 2.5 CDTI | 107 | 08/06 → | D | G9MB6, G9U630 |
| | 107 | 08/06 → | D | G9U630 |
| | 84 | 08/06 → | D | G9U630 |
| 2.5 DTI | 99 | 05/03 → | D | G9U730 |

RENAULT
Avantime

| | | | | |
|---------|-----|---------------|---|--------|
| 2.2 dCi | 110 | 05/02 → 05/03 | D | G9T712 |
|---------|-----|---------------|---|--------|

Espace III

| | | | | |
|---------|----|---------------|---|-------------------|
| 2.2 dCi | 85 | 07/00 → 10/02 | D | G9T710 |
| | 95 | 10/00 → 10/02 | D | G9T642, G9T710 |

81855 350981855000

RENAULT
Espace IV

| | | | | |
|---------|-----|---------|---|-------------------|
| 2.2 dCi | 102 | 02/06 → | D | G9T645 |
| | 110 | 11/02 → | D | G9T742, G9T743 |

Laguna II, Grantour

| | | | | |
|---------|-----|---------------|---|---|
| 2.2 dCi | 102 | 05/05 → | D | G9T600, G9T605, G9T706, G9T707 |
| | 102 | 05/05 → | D | G9T600, G9T706, G9T707 |
| | 85 | 04/04 → 10/05 | D | G9T600 |
| | 110 | 10/01 → | D | G9T700, G9T702 |
| | 110 | 10/01 → | D | G9T702 |

Master II

| | | | | |
|-------------|-----|---------|---|---|
| 2.2 dCi 90 | 66 | 09/00 → | D | G9T720, G9T722, G9T750 |
| 2.5 dCi | 74 | 08/06 → | D | G9U650, G9U754 |
| | 84 | 01/04 → | D | G9U750 |
| | 88 | 08/06 → | D | G9U650 |
| | 107 | 08/06 → | D | G9U632 |
| 2.5 dCi 100 | 73 | 10/03 → | D | G9U754 |
| 2.5 dCi 120 | 84 | 10/01 → | D | G9U720, G9U724, G9U750, G9U754 |
| | 84 | 10/01 → | D | G9U720, G9U750, G9U754 |

Traffic II

| | | | | |
|-------------|-----|---------------|---|--------|
| 2.5 dCi | 84 | 08/07 → | D | G9U630 |
| 2.5 dCi 115 | 84 | 02/08 → | D | G9U630 |
| 2.5 dCi 135 | 99 | 03/01 → | D | G9U730 |
| | 99 | 05/03 → | D | G9U730 |
| 2.5 dCi 145 | 107 | 08/06 → | D | G9U630 |
| 2.5 DTi | 99 | 03/03 → 07/03 | D | G9U730 |

81855 350981855000

RENAULT
Vel Satis

| | | | | |
|---------|-----|---------|---|--|
| | 83 | 12/04 → | D | G9T600 |
| | 85 | 04/04 → | D | G9T600 |
| 2.2 dCi | 102 | 09/04 → | D | G9T600, G9T606, G9T607, G9T700, G9T702 |
| | 110 | 06/02 → | D | G9T702, G9T703 |

VAUXHALL
Movano

| | | | | |
|---------|----|---------------|---|------------------------------|
| 2.2 DTI | 66 | 09/00 → 05/10 | D | G9T720, G9T722, G9T750 |
| | 66 | 09/00 → 05/10 | D | G9T720, G9T750 |

81856 350981856000

| | | |
|--|-------------------------|---------|
| | FLANGIA | |
| | Numero Fori Flangia | 3 |
| | Dimensione Fori Flangia | M8x1.25 |
| | Posizione Attacco | 31.5 |
| | Diametro Mozzo | Ø30 |
| | Diametro Girante | Ø50 |
| | N° Alette Girante | 7 |
| | Posizione Girante | 61.6 |

SEAT
Toledo II

| | | | | |
|------------|-----|---------------|---|-----|
| 2.3 V5 | 110 | 10/98 → 11/00 | B | AGZ |
| 2.3 V5 20V | 125 | 09/00 → 11/03 | B | AQN |

VOLKSWAGEN
Bora, Station Wagon

| | | | | | |
|----------------|-----|---------------|---|-----|-----------|
| 2.3 V5 | 110 | 10/98 → 10/00 | B | AGZ | 08-1998 → |
| | 110 | 05/99 → 10/00 | B | AGZ | |
| | 125 | 10/00 → 05/05 | B | AQN | |
| 2.3 V5 4motion | 110 | 12/98 → 10/00 | B | AGZ | 08-1998 → |
| | 110 | 05/99 → 10/00 | B | AGZ | |
| | 125 | 10/00 → 05/05 | B | AQN | |

Golf IV, Variant, Cabrio

| | | | | |
|----------------|-----|---------------|---|-----|
| 2.3 V5 | 110 | 08/97 → 10/00 | B | AGZ |
| | 125 | 10/00 → 06/05 | B | AQN |
| 2.3 V5 4motion | 110 | 12/98 → 10/00 | B | AGZ |
| | 125 | 10/00 → 06/05 | B | AQN |

81856
350981856000

VOLKSWAGEN
New Beetle, Cabrio

| | | | | |
|--------|-----|---------------|---|-----|
| 2.3 V5 | 125 | 10/00 → 09/10 | B | AQN |
|--------|-----|---------------|---|-----|

Passat IV, Variant

| | | | | |
|------------------------|-----|---------------|---|-----|
| 2.3 VR5 Syncro/4motion | 110 | 10/96 → 11/00 | B | AGZ |
| | 110 | 10/97 → 11/00 | B | AGZ |

Passat V, Variant

| | | | | |
|-----------------|-----|---------------|---|-----|
| 2.3 V5 | 125 | 11/00 → 05/05 | B | AZX |
| 2.3 V5 4motion | 125 | 11/00 → 05/05 | B | AZX |
| 2.3 VR5 | 125 | 11/00 → 05/05 | B | AZX |
| 2.3 VR5 4motion | 125 | 11/00 → 05/05 | B | AZX |

81857
350981857000

PULEGGIA

| | |
|----------------------------|-------|
| Diametro Puleggia | Ø62.3 |
| Numero Denti/Gole Puleggia | 14 |
| Altezza Puleggia | 31.5 |
| Posizione Attacco | 63.5 |
| Diametro Girante | Ø71 |
| N° Alette Girante | 7 |
| Posizione Girante | 14 |

VOLVO
960 I, Station Wagon

| | | | | |
|-----|-----|---------------|---|-------------------------|
| 2.9 | 150 | 08/90 → 07/94 | B | B6304F, B6304FS, B6304G |
| | 150 | 08/90 → 07/94 | B | B6304F, B6304S |

960 II, Station Wagon

| | | | | |
|-----|-----|---------------|---|-----------------------------|
| 2.5 | 125 | 07/94 → 12/96 | B | B6254S |
| | 125 | 08/94 → 12/96 | B | B6254S 07-1994 →, → 10-1996 |
| 2.9 | 150 | 07/94 → 12/96 | B | B6304S |

S 90

| | | | | |
|-----|-----|---------------|---|-------------------|
| 2.5 | 125 | 11/96 → 10/98 | B | B6254FS |
| | 132 | 11/96 → 10/97 | B | B6244FS |
| 2.9 | 132 | 01/97 → 05/98 | B | B6304S2 11-1996 → |
| | 150 | 01/97 → 05/98 | B | B6304G |

V 90

| | | | | |
|-----|-----|---------------|---|---------|
| 2.5 | 125 | 11/96 → 10/98 | B | B6254FS |
| | 132 | 11/96 → 10/97 | B | B6244FS |
| 2.9 | 132 | 01/97 → 12/98 | B | B6304S2 |
| | 150 | 01/97 → 12/98 | B | B6304G |

81858
350981858000

FLANGIA

| | |
|-------------------------|-------|
| Numero Fori Flangia | 4 |
| Dimensione Fori Flangia | M6×1 |
| Posizione Attacco | 72.2 |
| Diametro Mozzo | Ø43.8 |
| Diametro Girante | Ø60 |
| N° Alette Girante | 7 |
| Posizione Girante | 9.5 |

SUBARU
Justy II

| | | | | |
|------------|----|---------------|---|-------|
| 1.3 4x4 | 63 | 04/01 → 11/03 | B | G13BB |
| 1.3 GX 4x4 | 50 | 10/95 → 11/03 | B | EF13 |

SUZUKI
Alto

| | | | | |
|-----|----|---------------|---|-------|
| 1.0 | 43 | 01/00 → 06/02 | B | G10BB |
|-----|----|---------------|---|-------|

Alto III

| | | | | |
|-----|----|---------------|---|-----------------|
| 1.0 | 39 | 09/94 → 09/98 | B | G10BB 01-1991 → |
|-----|----|---------------|---|-----------------|

Alto IV

| | | | | |
|-----|----|---------------|---|-------------|
| 1.1 | 46 | 09/04 → 12/08 | B | F10D, F10DN |
|-----|----|---------------|---|-------------|

Baleno, Station Wagon

| | | | | |
|-----------|----|---------------|---|-----------------|
| 1.3 | 52 | 09/96 → 05/02 | B | G13BA |
| 1.3 16V | 63 | 03/97 → 05/02 | B | G13BB |
| 1.3 i 16V | 63 | 07/95 → 05/02 | B | G13BB 01-1994 → |

Swift II, Cabrio

| | | | | |
|---------|----|---------------|---|-------|
| 1.0 | 37 | 03/89 → 05/01 | B | G10A |
| | 39 | 01/95 → 12/05 | B | G10A |
| | 40 | 03/89 → 12/91 | B | G10A |
| 1.3 | 50 | 03/89 → 05/01 | B | G13A |
| | 50 | 03/89 → 05/01 | B | G13A |
| | 52 | 03/89 → 12/91 | B | G13A |
| 1.3 4WD | 50 | 03/89 → 05/01 | B | G13A |
| | 52 | 10/89 → 12/91 | B | G13A |
| 1.3 GTi | 74 | 03/89 → 05/01 | B | G13B |
| 1.3 i | 50 | 09/91 → 10/96 | B | G13BA |

Wagon R+ II

| | | | | |
|---------|----|---------------|---|-------|
| 1.3 | 56 | 05/00 → 12/04 | B | G13BB |
| 1.3 4WD | 56 | 10/01 → | B | G13BB |

81861
350981861000

PULEGGIA

| | |
|----------------------------|------|
| Diametro Puleggia | Ø131 |
| Numero Denti/Gole Puleggia | 6 |
| Altezza Puleggia | 29 |
| Posizione Attacco | 163 |
| Diametro Girante | Ø60 |
| N° Alette Girante | 6 |
| Posizione Girante | 16 |

KW

FIAT
500X

| | | | | |
|-----|----|---------|---|----------|
| 1.6 | 81 | 11/14 → | B | 55263842 |
| | 82 | 09/14 → | B | 55263842 |

JEEP
Renegade

| | | | | |
|-----|----|---------|---|-----|
| 1.6 | 81 | 07/14 → | B | EJH |
|-----|----|---------|---|-----|

MINI
Mini I (R50,R52, R53)

| | | | | |
|----------|-----|---------------|---|---------|
| Cooper | 85 | 06/01 → 09/06 | B | W10B16A |
| Cooper S | 125 | 07/04 → 09/06 | B | W11B16A |
| One | 55 | 04/03 → 09/06 | B | W10B14A |
| | 66 | 06/01 → 09/06 | B | W10B16A |

81862
350981862000

PULEGGIA

| | |
|----------------------------|------|
| Diametro Puleggia | Ø115 |
| Numero Denti/Gole Puleggia | 6 |
| Altezza Puleggia | 23 |
| Posizione Attacco | 77.5 |
| Diametro Girante | Ø62 |
| N° Alette Girante | 6 |
| Posizione Girante | 24.5 |

KW

ALFA ROMEO
Mito

| | | | | |
|--------------|----|---------|---|-----------|
| 1.3 MultiJet | 59 | 12/13 → | D | 199B8.000 |
| | 62 | 01/11 → | D | 199B4.000 |
| | 66 | 09/08 → | D | 199A3.000 |
| | 70 | 10/09 → | D | 199B1.000 |

CHRYSLER
Ypsilon

| | | | | |
|--------------|----|---------|---|-----------|
| 1.3 Multijet | 70 | 05/11 → | D | 199B1.000 |
|--------------|----|---------|---|-----------|

CITROËN
Nemo, Van

| | | | | |
|------------|----|---------|---|------------------|
| 1.3 HDi 75 | 55 | 10/10 → | D | FHZ (F13DTE5) |
|------------|----|---------|---|------------------|

81862
350981862000

KW

FIAT
500 II, 500C

| | | | | |
|-------------------|----|---------|---|-----------|
| 1.3 D Multijet | 55 | 10/07 → | D | 169A1.000 |
| | 70 | 12/09 → | D | 199B1.000 |

500L

| | | | | |
|-------------------|----|---------|---|-----------|
| 1.3 D Multijet | 62 | 09/12 → | D | 199B4.000 |
| | 70 | 06/14 → | D | 330A1.000 |

500X

| | | | | |
|----------------|----|---------|---|----------|
| 1.3 D Multijet | 70 | 06/15 → | D | 55266963 |
|----------------|----|---------|---|----------|

Doblo I, Cargo

| | | | | |
|-------------------|----|---------------|---|-----------|
| 1.3 D Multijet | 55 | 10/05 → 01/10 | D | 199A2.000 |
| | 62 | 10/05 → | D | 223A9.000 |
| 1.3 JTD | 55 | 05/05 → | D | 199A2.000 |

| | | | | |
|-------------|----|---------------|---|-------------------------|
| 1.3 JTD 16V | 51 | 05/04 → 12/06 | D | 188A8.000, 188A9.000 |
| | 51 | 12/04 → 05/05 | D | 188A9.000 |

| | | | | |
|-------------------------|----|---------|---|-----------|
| 1.3 JTD 16V Multijet | 62 | 08/06 → | D | 223A9.000 |
|-------------------------|----|---------|---|-----------|

Doblo II, Cargo

| | | | | |
|----------------|----|---------|---|-------------------------|
| 1.3 D Multijet | 66 | 02/10 → | D | 199A3.000, 263A2.000 |
|----------------|----|---------|---|-------------------------|

Fiorino IV

| | | | | |
|-------------------|----|---------|---|-------------------------|
| 1.3 D Multijet | 55 | 11/07 → | D | 199A2.000, 199A9.000 |
| | 70 | 07/09 → | D | 199B1.000, 330A1.000 |

Grande Punto, Van

| | | | | |
|-------------------|----|---------|---|-------------------------|
| 1.3 D Multijet | 51 | 07/08 → | D | 199B2.000 |
| | 55 | 10/05 → | D | 199A2.000 |
| | 56 | 06/09 → | D | 199A2.000 |
| | 62 | 04/10 → | D | 199B4.000, 223A9.000 |
| | 66 | 10/05 → | D | 199A3.000 |

Idea

| | | | | |
|-------------------|----|---------|---|-----------|
| 1.3 D Multijet | 66 | 10/05 → | D | 199A3.000 |
| | 70 | 05/08 → | D | 199B1.000 |
| 1.3 JTD | 51 | 01/04 → | D | 188A9.000 |

Linea

| | | | | |
|-------------------|----|---------|---|-----------|
| 1.3 D Multijet | 66 | 06/07 → | D | 199A3.000 |
| | 70 | 09/09 → | D | 199A3.000 |

Panda II, Van

| | | | | |
|-------------------|----|---------|---|-------------------------|
| 1.3 D Multijet | 51 | 09/03 → | D | 188A8.000, 188A9.000 |
| | 55 | 01/06 → | D | 169A1.000 |
| | 55 | 06/06 → | D | 169A1.000, 169A5.000 |

81862
350981862000

FIAT
Panda II, Van

| | | | | |
|-----------------------|----|---------|---|-------------------------|
| 1.3 D Multijet 4x4 | 51 | 10/04 → | D | 188A8.000, 188A9.000 |
| | 55 | 01/06 → | D | 169A1.000 |
| | 55 | 09/10 → | D | 169A1.000, 169A5.000 |

Panda III, Van

| | | | | |
|-------------------|----|---------|---|---------------------------------------|
| 1.3 D Multijet | 55 | 02/12 → | D | 199A1.000, 199A9.000 |
| | 70 | 04/15 → | D | 199B1.000, 312B1.000, 330A1.000 |

| | | | | |
|-----------------------|----|---------|---|---------------------------------------|
| 1.3 D Multijet 4x4 | 55 | 06/12 → | D | 199A1.000, 199A9.000 |
| | 59 | 06/14 → | D | 225A2.000, 312A8.000, 312B2.000 |
| | 70 | 04/15 → | D | 199B1.000, 312B1.000, 330A1.000 |

Punto Evo, Van

| | | | | |
|-------------------|----|---------------|---|-------------------------|
| 1.3 D Multijet | 51 | 07/08 → 02/12 | D | 199B2.000 |
| | 55 | 10/09 → 02/12 | D | 199A2.000, 199A9.000 |
| | 62 | 10/09 → 02/12 | D | 199B4.000, 223A9.000 |
| | 66 | 10/09 → 02/12 | D | 199A3.000 |
| | 70 | 10/09 → 02/12 | D | 199B1.000 |

Punto II, Cabrio, Van

| | | | | |
|----------------|----|---------------|---|-----------|
| 1.3 D Multijet | 55 | 02/05 → 10/09 | D | 188A9.000 |
| 1.3 JTD | 51 | 06/03 → 10/05 | D | 188A9.000 |
| 1.3 JTD 16V | 51 | 06/03 → | D | 188A9.000 |

Punto III, Van

| | | | | |
|-------------------|----|---------------|---|-------------------------|
| 1.3 D Multijet | 55 | 03/12 → | D | 199A2.000, 199A9.000 |
| | 59 | 12/13 → | D | 199B8.000 |
| | 62 | 03/12 → | D | 199B4.000 |
| | 66 | 01/10 → 02/12 | D | 199A3.000 |
| | 70 | 03/12 → | D | 199B1.000 |

Qubo

| | | | | |
|-------------------|----|---------|---|-------------------------|
| 1.3 D Multijet | 55 | 02/08 → | D | 199A2.000, 199A9.000 |
| | 70 | 07/10 → | D | 199B1.000 |

Siena I

| | | | | |
|---------|----|---------------|---|-----------|
| 1.3 JTD | 51 | 09/03 → 12/09 | D | 188A9.000 |
|---------|----|---------------|---|-----------|

81862
350981862000

FIAT
Siena II

| | | | | |
|---------|----|---------|---|-----------|
| 1.3 JTD | 51 | 11/07 → | D | 188A9.000 |
|---------|----|---------|---|-----------|

Strada

| | | | | |
|-------------------|----|---------|---|-----------|
| 1.3 D Multijet | 62 | 05/06 → | D | 223A9.000 |
| | 70 | 10/10 → | D | 199B1.000 |

Tipo II

| | | | | |
|----------------|----|---------|---|------------------------|
| 1.3 D Multijet | 70 | 10/15 → | D | 199B1.000, 55266963 |
|----------------|----|---------|---|------------------------|

FORD
KA II

| | | | | |
|----------|----|---------|---|-----|
| 1.3 TDCi | 55 | 10/08 → | D | FD4 |
|----------|----|---------|---|-----|

LANCIA
Musa

| | | | | |
|-------------------|----|---------------|---|-----------|
| 1.3 D Multijet | 51 | 10/04 → 09/12 | D | 188A9.000 |
| | 66 | 09/06 → 09/12 | D | 199A3.000 |
| | 70 | 03/09 → 09/12 | D | 199B1.000 |

Ypsilon I

| | | | | |
|-------------------|----|---------------|---|-----------|
| 1.3 D Multijet | 55 | 09/06 → 12/11 | D | 199A2.000 |
| | 66 | 09/06 → 12/11 | D | 199A3.000 |
| | 77 | 05/07 → 12/11 | D | 199A3.000 |
| 1.3 JTD | 51 | 10/03 → 12/11 | D | 188A9.000 |

Ypsilon II

| | | | | |
|--------------|----|---------|---|-----------|
| 1.3 Multijet | 70 | 05/11 → | D | 199B1.000 |
|--------------|----|---------|---|-----------|

OPEL
Agila A

| | | | | |
|----------|----|---------------|---|-------|
| 1.3 CDTI | 51 | 08/03 → 12/07 | D | Z13DT |
|----------|----|---------------|---|-------|

Agila B

| | | | | |
|----------|----|---------|---|--------------|
| 1.3 CDTI | 55 | 04/08 → | D | D13A, Z13DTJ |
|----------|----|---------|---|--------------|

Astra H, Station Wagon, GTC, Twin Top, Van

| | | | | |
|----------|----|---------|---|--------|
| 1.3 CDTI | 66 | 08/05 → | D | Z13DTH |
|----------|----|---------|---|--------|

Astra J, Station Wagon, GTC

| | | | | |
|----------|----|---------|---|--------|
| 1.3 CDTI | 70 | 12/09 → | D | A13DTE |
|----------|----|---------|---|--------|

Combo B

| | | | | |
|-----------------|----|---------|---|-----------------|
| 1.3 CDTI 16V | 51 | 10/04 → | D | Y13DT, Z13DT |
| | 51 | 08/05 → | D | Z13DT |
| | 55 | 10/05 → | D | Z13DTJ |

Combo C

| | | | | |
|----------|----|---------|---|-------|
| 1.3 CDTI | 66 | 02/12 → | D | A13FD |
|----------|----|---------|---|-------|

Corsa C, Van

| | | | | |
|-----------------|----|---------------|---|-------|
| 1.3 CDTI | 51 | 06/03 → 12/09 | D | Z13DT |
| 1.3 CDTI 16V | 51 | 08/05 → | D | Z13DT |

81862 **350981862000**

OPEL
Corsa D, Van

| | | | | |
|----------|----|---------|---|------------------------------|
| 1.3 CDTI | 55 | 07/06 → | D | A13DTC, Z13DTJ |
| | 66 | 07/06 → | D | Z13DTH |
| | 70 | 06/10 → | D | A13DTE, A13DTR, Z13DTE |

Corsa E, Van

| | | | | |
|----------|----|---------|---|--------|
| 1.3 CDTI | 55 | 09/14 → | D | B13DTC |
|----------|----|---------|---|--------|

Meriva A

| | | | | |
|----------|----|---------------|---|-----------------|
| 1.3 CDTI | 51 | 04/05 → 05/10 | D | Y13DT, Z13DT |
| | 55 | 09/03 → 05/10 | D | Z13DTJ |

Meriva B

| | | | | |
|----------|----|---------|---|--------|
| 1.3 CDTI | 55 | 06/10 → | D | A13DTC |
| | 70 | 06/10 → | D | A13DTE |

Tigra II Twin Top

| | | | | |
|----------|----|---------|---|-------|
| 1.3 CDTI | 51 | 06/04 → | D | Z13DT |
|----------|----|---------|---|-------|

PEUGEOT
Bipper, Tepee

| | | | | |
|------------|----|---------|---|-----------|
| 1.3 HDi 75 | 55 | 10/10 → | D | 199A9.000 |
|------------|----|---------|---|-----------|

SUZUKI
Ignis II

| | | | | |
|----------|----|---------|---|-------|
| 1.3 DDiS | 51 | 09/03 → | D | Z13DT |
|----------|----|---------|---|-------|

Splash

| | | | | |
|----------|----|---------|---|--------------|
| 1.3 CDTI | 55 | 01/08 → | D | D13A, Z13DTJ |
|----------|----|---------|---|--------------|

Swift III

| | | | | |
|----------|----|---------|---|--------------|
| 1.3 DDiS | 51 | 08/05 → | D | Z13DT |
| | 55 | 08/05 → | D | D13A, Z13DTJ |

Swift IV

| | | | | |
|----------|----|---------|---|------|
| 1.3 DDiS | 55 | 10/10 → | D | D13A |
|----------|----|---------|---|------|

Wagon R+ II

| | | | | |
|----------|----|---------|---|-------|
| 1.3 DDiS | 51 | 09/03 → | D | Z13DT |
|----------|----|---------|---|-------|

VAUXHALL
AGILA

| | | | | |
|----------|----|---------------|---|--------------|
| 1.3 CDTI | 55 | 01/08 → 11/14 | D | D13A, Z13DTJ |
|----------|----|---------------|---|--------------|

ASTRA

| | | | | |
|----------|----|---------|---|--------|
| 1.3 CDTI | 70 | 12/09 → | D | A13DTE |
|----------|----|---------|---|--------|

CORSA

| | | | | |
|-----------------|----|---------------|---|-------|
| 1.3 CDTI 16V | 52 | 08/00 → 09/06 | D | Z13DT |
|-----------------|----|---------------|---|-------|

CORSAVAN

| | | | | |
|-----------------|----|---------------|---|-------|
| 1.3 CDTI 16V | 52 | 04/04 → 06/06 | D | Z13DT |
|-----------------|----|---------------|---|-------|

TIGRA

| | | | | |
|----------|----|---------------|---|-------|
| 1.3 CDTI | 51 | 06/04 → 08/09 | D | Z13DT |
|----------|----|---------------|---|-------|

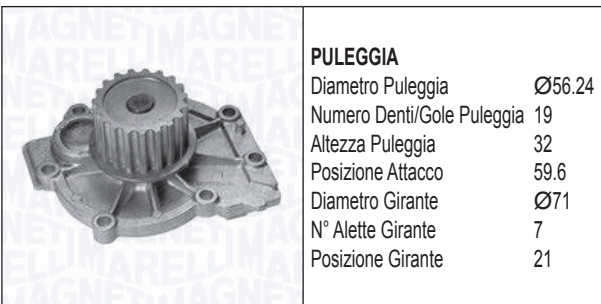
81864
350981864000

PULEGGIA

| | |
|----------------------------|--------|
| Diametro Puleggia | Ø56.24 |
| Numero Denti/Gole Puleggia | 19 |
| Altezza Puleggia | 32 |
| Posizione Attacco | 59.6 |
| Diametro Girante | Ø71 |
| N° Alette Girante | 7 |
| Posizione Girante | 21 |

VOLVO
C 30

| | | | | |
|----|-----|---------------|---|----------------------|
| D3 | 110 | 10/10 → 12/12 | D | D5204T5 |
| D4 | 130 | 10/10 → 12/12 | D | D5204T |
| D5 | 120 | 10/06 → 12/12 | D | D5244T9 |
| | 132 | 10/06 → 12/12 | D | D5244T13, D5244T8 |

C 70 II

| | | | | |
|-------|-----|---------------|---|----------------------|
| 2.4 D | 120 | 03/07 → 06/13 | D | D5244T9 |
| D3 | 110 | 10/10 → 06/13 | D | D5204T5 |
| D4 | 130 | 10/10 → 06/13 | D | D5204T |
| D5 | 132 | 03/06 → 06/13 | D | D5244T13, D5244T8 |

S 40 II

| | | | | |
|--------|-----|---------|---|----------------------|
| 2.4 D5 | 132 | 03/06 → | D | D5244T13, D5244T8 |
| D3 | 110 | 10/10 → | D | D5204T5 |
| D4 | 130 | 10/10 → | D | D5204T |

S 60 I

| | | | | |
|--------|-----|---------------|---|---------|
| 2.4 D | 93 | 09/05 → 04/10 | D | D5244T7 |
| | 120 | 09/05 → 01/09 | D | D5244T5 |
| | 96 | 12/01 → 04/10 | D | D5244T2 |
| 2.4 D5 | 120 | 07/01 → 04/10 | D | D5244T |
| | 136 | 09/05 → 04/10 | D | D5244T4 |

S 60 II

| | | | | |
|-----------|-----|---------------|---|-----------------------|
| 2.4 D4AWD | 140 | 03/15 → | D | D5244T21 |
| D3 | 100 | 05/12 → | D | D5204T7 |
| | 120 | 04/10 → 04/12 | D | D5204T2, D5204T3 |
| D4 | 120 | 05/12 → | D | D5204T3 |
| D5 | 151 | 04/10 → | D | D5244T10 |
| | 158 | 06/11 → | D | D5244T11, D5244T15 |
| | 169 | 04/14 → | D | D5244T15, D5244T23 |

81864
350981864000

VOLVO
S 60 II

| | | | | | |
|--------|-----|---------|---|-----------------------|--|
| D5 AWD | 151 | 04/10 → | D | D5244T10 | |
| | 158 | 06/11 → | D | D5244T15 | |
| | 169 | 04/14 → | D | D5244T15, D5244T23 | |

S 80 I

| | | | | | |
|--------|-----|---------------|---|---------|-----------|
| 2.4 D | 96 | 10/01 → 07/06 | D | D5244T2 | |
| 2.4 D5 | 120 | 08/01 → 07/06 | D | D5244T | |
| 2.8 T6 | 200 | 05/98 → 07/06 | B | B6284T | 01-2003 → |
| 2.9 | 147 | 03/99 → 07/06 | B | B6294S | 01-2003 → |
| | 150 | 05/98 → 07/06 | B | B6304S3 | 01-2003 → |
| 3.0 | 144 | 06/01 → 07/06 | B | B6294S2 | 01-2003 → |
| 3.0 T6 | 200 | 06/01 → 07/06 | B | B6294T | 01-2003 → |

S 80 II

| | | | | | |
|---------|-----|---------|---|-----------------------|--|
| 2.4 D | 120 | 03/06 → | D | D5244T, D5244T5 | |
| | 129 | 01/10 → | D | D5244T14 | |
| D3 | 100 | 05/12 → | D | D5204T7 | |
| D3 / D4 | 120 | 01/10 → | D | D5204T2, D5204T3 | |
| D5 | 136 | 03/06 → | D | D5244T4 | |
| | 151 | 01/10 → | D | D5244T10 | |
| D5 | 158 | 06/11 → | D | D5244T11, D5244T15 | |
| D5 AWD | 136 | 01/07 → | D | D5244T4 | |
| | 151 | 01/10 → | D | D5244T10 | |
| | 158 | 06/11 → | D | D5244T15 | |

V 40 II

| | | | | | |
|----|-----|---------------|---|---------|--|
| D3 | 110 | 03/12 → 03/15 | D | D5204T6 | |
| D4 | 130 | 03/12 → | D | D5204T4 | |

V 50

| | | | | | |
|---------|-----|---------|---|----------------------|--|
| 2.4 D5 | 132 | 03/06 → | D | D5244T13, D5244T8 | |
| 2.4 Tdi | 120 | 05/07 → | D | D5244T9 | |
| D3 | 110 | 10/10 → | D | D5204T5 | |
| D4 | 130 | 10/10 → | D | D5204T | |

V 60

| | | | | | |
|-------------------|-----|---------|---|-----------------------|--|
| 2.4 D5 | 158 | 06/11 → | D | D5244T11, D5244T15 | |
| 2.4 D5 AWD | 158 | 06/11 → | D | D5244T15 | |
| 2.4 D5 Hybrid AWD | 120 | 03/15 → | | D87PHEV | |
| 2.4 Hybrid D6 AWD | 158 | 06/12 → | | D82PHEV | |

81864
350981864000

VOLVO
V 60

| | | | | | |
|---------------|-----|---------|---|-----------------------|--|
| D3 | 100 | 12/12 → | D | D5204T7 | |
| D3 / D4 | 120 | 09/10 → | D | D5204T2, D5204T3 | |
| D4 AWD | 120 | 12/12 → | D | D5244T17 | |
| | 133 | 10/13 → | D | D5244T12 | |
| | 140 | 03/15 → | D | D5244T21 | |
| D5 | 151 | 09/10 → | D | D5244T10 | |
| | 169 | 04/14 → | D | D5244T23 | |
| D5 AWD | 151 | 09/10 → | D | D5244T10 | |
| | 169 | 04/14 → | D | D5244T15, D5244T23 | |
| D6 Hybrid AWD | 162 | 03/15 → | | D97PHEV | |

V 70 II

| | | | | | |
|------------|-----|---------------|---|--------------------------------|--|
| 2.4 D | 93 | 05/05 → 08/07 | D | D5244T7 | |
| | 96 | 12/01 → 08/07 | D | D5244T2 | |
| 2.4 D5 | 120 | 08/01 → 08/07 | D | D5244T, D5244T5 | |
| | 136 | 12/05 → 08/07 | D | D5244T4 | |
| 2.4 D5 AWD | 120 | 03/03 → 08/07 | D | D5244T, D5244T2, D5244T5 | |
| | 136 | 12/05 → 08/07 | D | D5244T4 | |

V 70 III

| | | | | | |
|---------|-----|---------|---|-----------------------|--|
| 2.4 D | 120 | 08/07 → | D | D5244T5 | |
| | 129 | 10/09 → | D | D5244T14 | |
| D3 | 100 | 03/10 → | D | D5204T7 | |
| D3 / D4 | 120 | 03/10 → | D | D5204T2, D5204T3 | |
| D4 AWD | 120 | 01/13 → | D | D5244T17 | |
| | 133 | 10/13 → | D | D5244T12 | |
| D5 | 136 | 08/07 → | D | D5244T4 | |
| | 151 | 12/09 → | D | D5244T10 | |
| | 158 | 06/11 → | D | D5244T11, D5244T15 | |
| D5 AWD | 136 | 10/07 → | D | D5244T4 | |
| | 151 | 12/09 → | D | D5244T10 | |
| | 158 | 06/11 → | D | D5244T11, D5244T15 | |

81864 **350981864000**

VOLVO
XC 60

| | | | | |
|---------|-----|---------------|---|-----------------------|
| 2.4 D | 129 | 07/09 → | D | D5244T14 |
| D3 | 100 | 04/12 → | D | D5204T7 |
| D3 / D4 | 120 | 03/10 → | D | D5204T2, D5204T3 |
| D4 AWD | 133 | 10/13 → | D | D5244T12 |
| | 140 | 03/15 → | D | D5244T21 |
| D5 | 158 | 06/11 → | D | D5244T11, D5244T15 |
| D5 AWD | 151 | 07/09 → 06/11 | D | D5244T10 |
| | 158 | 06/11 → | D | D5244T11, D5244T15 |
| | 162 | 03/15 → | D | D5244T20, D5244T22 |
| | 169 | 04/14 → | D | D5244T23 |

XC 70 I Cross Country

| | | | | |
|---------------|-----|---------------|---|---------|
| 2.4 D5 AWD | 136 | 12/05 → 08/07 | D | D5244T4 |
| 2.4 D5 XC AWD | 120 | 09/02 → 08/07 | D | D5244T |

XC 70 II

| | | | | |
|----------------|-----|---------|---|-----------------------------------|
| 2.4 D | 129 | 01/10 → | D | D5244T14 |
| 2.4 D / D4 AWD | 120 | 08/07 → | D | D5244T16, D5244T17, D5244T5 |
| D3 | 120 | 08/11 → | D | D5204T2, D5204T3 |
| D3 AWD | 120 | 08/11 → | D | D5204T2 |
| D4 AWD | 133 | 10/13 → | D | D5244T12 |
| D5 AWD | 136 | 08/07 → | D | D5244T4 |
| | 151 | 12/09 → | D | D5244T10 |
| | 158 | 06/11 → | D | D5244T11, D5244T15 |
| | 162 | 03/15 → | D | D5244T20 |

XC 90 I

| | | | | |
|---------|-----|---------|---|--------------------|
| D3 / D5 | 120 | 04/09 → | D | D5244T5 |
| D5 | 147 | 01/11 → | D | D5244T18 |
| | 120 | 10/02 → | D | D5244T, D5244T5 |
| | 136 | 05/06 → | D | D5244T4 |
| D5 AWD | 120 | 10/07 → | D | D5244T5 |
| T6 | 200 | 10/02 → | B | B6294T |

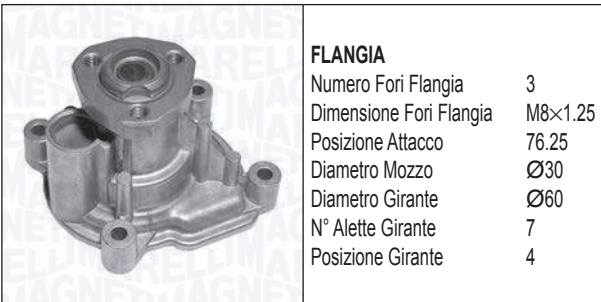
81865 **350981865000**

FLANGIA

| | |
|-------------------------|---------|
| Numero Fori Flangia | 3 |
| Dimensione Fori Flangia | M8×1.25 |
| Posizione Attacco | 76.25 |
| Diametro Mozzo | Ø30 |
| Diametro Girante | Ø60 |
| N° Alette Girante | 7 |
| Posizione Girante | 4 |

AUDI
A3 II, Sportback, Cabriolet

| | | | | |
|---------|----|---------------|---|------------------|
| 1.6 FSI | 85 | 08/03 → 09/07 | B | BAG, BLF, BLP |
| | 85 | 09/04 → 09/07 | B | BLF, BLP |

SEAT
Cordoba III, Vario

| | | | | |
|---------|----|---------------|---|-----|
| 1.6 16V | 77 | 11/06 → 11/09 | B | BTS |
|---------|----|---------------|---|-----|

Ibiza IV

| | | | | |
|---------|----|---------------|---|-----|
| 1.6 16V | 77 | 11/06 → 11/09 | B | BTS |
|---------|----|---------------|---|-----|

Ibiza V

| | | | | | |
|-----|----|---------|---|-----|----------------|
| 1.6 | 77 | 05/08 → | B | BTS | → T: 6J9002800 |
| | 77 | 02/12 → | B | BTS | |

SKODA
Fabia II, Station Wagon, Van

| | | | | |
|-----|----|---------------|---|-----------|
| 1.6 | 77 | 04/07 → 12/14 | B | BTS, CFNA |
|-----|----|---------------|---|-----------|

Octavia II, Station Wagon

| | | | | |
|---------|----|---------------|---|-----|
| 1.6 FSI | 85 | 02/04 → 10/08 | B | BLF |
|---------|----|---------------|---|-----|

Rapid II

| | | | | |
|-----|----|---------|---|------|
| 1.6 | 77 | 07/12 → | B | CFNA |
|-----|----|---------|---|------|

Roomster, Van

| | | | | |
|-----|----|---------------|---|-----------|
| 1.6 | 77 | 09/06 → 05/15 | B | BTS, CFNA |
|-----|----|---------------|---|-----------|

VOLKSWAGEN
Eos

| | | | | |
|---------|----|---------------|---|-----|
| 1.6 FSI | 85 | 06/06 → 05/08 | B | BLF |
|---------|----|---------------|---|-----|

Golf V, Plus, Variant

| | | | | |
|---------|----|---------------|---|------------------|
| 1.4 FSI | 66 | 10/03 → 07/06 | B | BKG, BLN |
| | 66 | 07/05 → 11/06 | B | BLN |
| 1.6 FSI | 85 | 10/03 → 07/08 | B | BAG, BLF, BLP |
| | 85 | 01/05 → 05/08 | B | BLF |

Jetta III

| | | | | |
|---------|----|---------------|---|-----|
| 1.6 FSI | 85 | 09/05 → 10/10 | B | BLF |
|---------|----|---------------|---|-----|

Passat VI, Variant, CC

| | | | | |
|---------|----|---------------|---|-----|
| 1.6 FSI | 85 | 03/05 → 06/08 | B | BLF |
|---------|----|---------------|---|-----|

81865 350981865000



VOLKSWAGEN

Polo V (9N)

| | | | | | |
|----------------------|----|---------------|---|-----|--|
| 1.4 FSI | 63 | 02/02 → 07/06 | B | AXU | |
| 1.6 16V Polo VI (6R) | 77 | 05/06 → 11/09 | B | BTS | |

| | | | | | |
|-----|----|---------|---|------------|--|
| 1.6 | 77 | 05/10 → | B | CFNA, CLSA | |
|-----|----|---------|---|------------|--|

Touran I

| | | | | | |
|---------|----|---------------|---|---------------|--|
| 1.6 FSI | 85 | 02/03 → 01/07 | B | BAG, BLF, BLP | |
|---------|----|---------------|---|---------------|--|

81866 350981866000



FLANGIA

| | |
|-------------------------|---------|
| Numero Fori Flangia | 3 |
| Dimensione Fori Flangia | M8×1.25 |
| Posizione Attacco | 31.5 |
| Diametro Mozzo | Ø30 |
| Diametro Girante | Ø66.5 |
| N° Alette Girante | 7 |
| Posizione Girante | 63.8 |



AUDI

A3 II, Sportback, Cabriolet

| | | | | | |
|----------------|-----|---------------|---|---------------|--|
| 3.2 V6 quattro | 184 | 07/03 → 05/09 | B | BDB, BMJ, BUB | |
| | 184 | 09/04 → 05/09 | B | BMJ, BUB | |

Q7 I

| | | | | | |
|---------|-----|---------------|---|-----|--|
| 3.6 FSI | 206 | 08/06 → 05/10 | B | BHK | |
|---------|-----|---------------|---|-----|--|

TT I, Roadster

| | | | | | |
|-----------------|-----|---------------|---|----------|--|
| 3.2 VR6 quattro | 184 | 07/03 → 06/06 | B | BHE, BPF | |
|-----------------|-----|---------------|---|----------|--|

TT II, Roadster

| | | | | | |
|----------------|-----|---------------|---|-----|--|
| 3.2 V6 quattro | 184 | 08/06 → 06/10 | B | BUB | |
|----------------|-----|---------------|---|-----|--|

SEAT

Alhambra I

| | | | | | |
|----------------|-----|---------------|---|----------|--|
| 2.8 V6 | 150 | 06/00 → 03/10 | B | AUE, AYL | |
| 2.8 V6 4motion | 150 | 06/00 → 03/10 | B | AUE, AYL | |

Leon I

| | | | | | |
|-------------|-----|---------------|---|-----|----------|
| 2.8 | 150 | 05/02 → 06/04 | B | BDE | |
| 2.8 Cupra 4 | 150 | 02/01 → 06/06 | B | AUE | 10-2001→ |

81866 350981866000



SKODA

Superb II, Station Wagon

| | | | | | |
|-------------|-----|---------------|---|------|--|
| 3.6 FSI 4x4 | 191 | 04/09 → 05/15 | B | | |
| 3.6 V6 4x4 | 191 | 11/08 → 05/15 | B | CDVA | |

VOLKSWAGEN

Bora, Station Wagon

| | | | | | |
|----------------|-----|---------------|---|---------------|--------|
| 2.8 V6 4motion | 150 | 03/99 → 05/05 | B | AQP, AUE, BDE | M: BDE |
|----------------|-----|---------------|---|---------------|--------|

CC

| | | | | | |
|-----------------|-----|---------|---|-----|--|
| 3.6 FSI 4motion | 220 | 11/11 → | B | BWS | |
|-----------------|-----|---------|---|-----|--|

Eos

| | | | | | |
|--------|-----|---------------|---|-----------|--|
| 3.2 V6 | 184 | 06/06 → 05/09 | B | BUB, CBRA | |
| 3.6 V6 | 191 | 05/09 → 11/10 | B | CDVA | |

Golf IV, Variant, Cabrio

| | | | | | |
|-----------------|-----|---------------|---|----------|--|
| 3.2 R32 4motion | 177 | 09/02 → 06/05 | B | BFH, BML | |
|-----------------|-----|---------------|---|----------|--|

Golf V, Plus, Variant

| | | | | | |
|-----------------|-----|---------------|---|-----------|--|
| 3.2 | 184 | 09/05 → 11/08 | B | BUB | |
| 3.2 R32 4motion | 177 | 01/04 → 11/08 | B | BJS | |
| | 184 | 11/05 → 11/08 | B | BUB, CBRA | |

Multivan V

| | | | | | |
|----------------|-----|---------------|---|-----------|--|
| 3.2 V6 | 170 | 02/04 → 06/04 | B | BDL | |
| | 173 | 02/04 → 11/09 | B | BKK, CFLA | |
| 3.2 V6 4motion | 173 | 07/04 → 11/09 | B | BKK, CFLA | |

New Beetle, Cabrio

| | | | | | |
|-----------------|-----|---------------|---|-----|--|
| RSI 3.2 4motion | 165 | 04/00 → 05/01 | B | AXJ | |
|-----------------|-----|---------------|---|-----|--|

Passat VI, Variant, CC

| | | | | | |
|-----------------|-----|---------------|---|-----------|--|
| 3.2 FSI 4motion | 184 | 11/05 → 07/10 | B | AXZ | |
| 3.6 FSI 4motion | 206 | 06/08 → 01/12 | B | BLV, CNNA | |
| | 220 | 06/08 → 05/10 | B | BWS | |
| 3.6 R36 4motion | 220 | 04/07 → 07/10 | B | BWS | |

Passat VII, Variant, CC, AllTrack

| | | | | | |
|-----------------|-----|---------------|---|-----|--|
| 3.6 FSI 4motion | 220 | 01/11 → 12/14 | B | BWS | |
|-----------------|-----|---------------|---|-----|--|

Phaeton

| | | | | | |
|----------------|-----|---------|---|------------|--|
| 3.2 V6 | 177 | 04/02 → | B | AYT, BKL | |
| 3.2 V6 4motion | 177 | 02/04 → | B | BKL, BRK | |
| 3.6 V6 4motion | 206 | 11/08 → | B | CHNA, CMVA | |

81866 350981866000

VOLKSWAGEN
Sharan I

| | | | | | |
|------------|-----|---------------|---|-----|--------------|
| 2.8 V6 24V | 150 | 04/00 → 03/10 | B | AYL | T →: 035.001 |
|------------|-----|---------------|---|-----|--------------|

| | | | | | |
|-----------------------|-----|---------------|---|-----|--------------|
| 2.8 V6 24V 4motion | 150 | 04/00 → 03/10 | B | AYL | T →: 035.001 |
|-----------------------|-----|---------------|---|-----|--------------|

Touareg I

| | | | | | |
|--------|-----|---------------|---|------------------------------------|--|
| 3.2 V6 | 162 | 10/02 → 11/06 | B | AZZ, BAA, BKJ, BMV, BMX, BRJ | |
| | 177 | 11/04 → 11/06 | B | BMV | |

| | | | | | |
|------------|-----|---------------|---|----------|--|
| 3.6 V6 FSI | 206 | 10/05 → 05/10 | B | BHK, BHL | |
|------------|-----|---------------|---|----------|--|

Transporter IV

| | | | | | |
|---------|-----|---------------|---|-----|--|
| 2.8 VR6 | 150 | 06/00 → 04/03 | B | AMV | |
|---------|-----|---------------|---|-----|--|

Transporter V

| | | | | | |
|-------------|-----|---------------|---|-----------|--|
| 3.2 4motion | 173 | 11/03 → 11/09 | B | BKK, CFLA | |
|-------------|-----|---------------|---|-----------|--|

| | | | | | |
|--------|-----|---------------|---|-----|--|
| 3.2 V6 | 170 | 02/04 → 06/04 | B | BDL | |
| | 173 | 08/03 → 05/06 | B | BKK | |

| | | | | | |
|--------|-----|---------------|---|-----------|--|
| 3.2 V6 | 173 | 02/04 → 11/09 | B | BKK, CFLA | |
|--------|-----|---------------|---|-----------|--|

| | | | | | |
|-------------------|-----|---------------|---|-----------|--|
| 3.2 V6 4motion | 173 | 11/03 → 11/09 | B | BKK, CFLA | |
|-------------------|-----|---------------|---|-----------|--|

81867 350981867000

FLANGIA

| | |
|-------------------------|---------|
| Numero Fori Flangia | 3 |
| Dimensione Fori Flangia | M8x1.25 |
| Posizione Attacco | 69 |
| Diametro Mozzo | Ø30 |
| Diametro Girante | Ø64 |
| N° Alette Girante | 8 |
| Posizione Girante | 20.6 |

SEAT
Cordoba III, Vario

| | | | | | |
|-----|----|---------------|---|----------|--|
| 1.2 | 47 | 10/02 → 06/06 | B | AZQ, BME | |
|-----|----|---------------|---|----------|--|

| | | | | | |
|---------|----|---------------|---|-----|--|
| 1.2 12V | 51 | 05/06 → 11/09 | B | BXV | |
|---------|----|---------------|---|-----|--|

Ibiza IV

| | | | | | |
|-----|----|---------------|---|----------|--|
| 1.2 | 44 | 06/07 → 05/08 | B | BBM | |
| | 47 | 02/02 → 06/06 | B | AZQ, BME | |

| | | | | | |
|---------|----|---------------|---|-----|--|
| 1.2 12V | 51 | 05/06 → 11/09 | B | BXV | |
|---------|----|---------------|---|-----|--|

Ibiza V

| | | | | | |
|-----|----|---------|---|--------------------|--|
| 1.2 | 44 | 07/09 → | B | CGPB | |
| | 51 | 03/08 → | B | BZG, CGPA, CJLB | |

| | | | | | |
|-----|----|---------|---|------|--|
| 1.2 | 55 | 07/12 → | B | CGPC | |
|-----|----|---------|---|------|--|

Toledo IV

| | | | | | |
|-----|----|---------|---|------|--|
| 1.2 | 55 | 07/12 → | B | CGPC | |
|-----|----|---------|---|------|--|

81867 350981867000

SKODA
Fabia I, Station Wagon, Van

| | | | | | |
|-----|----|---------------|---|----------|--|
| 1.2 | 40 | 08/02 → 03/08 | B | AWY, BMD | |
| | 47 | 01/03 → 03/08 | B | AZQ, BME | |

Fabia II, Station Wagon, Van

| | | | | | |
|-----|----|---------------|---|--------------------------|--|
| 1.2 | 44 | 12/06 → 12/14 | B | BBM, CHFA | |
| | 51 | 01/07 → 12/14 | B | BZG, CEVA, CGPA, CHTA | |

| | | | | | |
|---------|----|---------------|---|------|--|
| 1.2 12V | 44 | 11/11 → 12/14 | B | CGPB | |
|---------|----|---------------|---|------|--|

| | | | | | |
|-----|----|---------|---|------|--|
| 1.2 | 55 | 07/12 → | B | CGPC | |
|-----|----|---------|---|------|--|

| | | | | | |
|-----|----|---------|---|------|--|
| 1.2 | 55 | 07/12 → | B | CGPC | |
|-----|----|---------|---|------|--|

Rapid II

| | | | | | |
|-----|----|---------|---|------|--|
| 1.2 | 55 | 07/12 → | B | CGPC | |
|-----|----|---------|---|------|--|

Roomster, Van

| | | | | | |
|-----|----|---------------|---|-----------|--|
| 1.2 | 47 | 05/06 → 01/07 | B | BME | |
| | 51 | 01/07 → 05/15 | B | BZG, CGPA | |

| | | | | | |
|-----|----|---------------|---|-----------|--|
| 1.2 | 51 | 01/07 → 05/15 | B | BZG, CGPA | |
|-----|----|---------------|---|-----------|--|

VOLKSWAGEN
Fox I

| | | | | | |
|-----|----|---------|---|-----------|--|
| 1.2 | 40 | 04/05 → | B | BMD, CHFB | |
| | 44 | 09/10 → | B | CHFA | |

| | | | | | |
|-----|----|---------|---|------|--|
| 1.2 | 44 | 09/10 → | B | CHFA | |
|-----|----|---------|---|------|--|

Polo V (9N)

| | | | | | |
|-----|----|---------------|---|----------|--|
| 1.2 | 40 | 01/02 → 05/07 | B | AWY, BMD | |
| | 44 | 05/07 → 11/09 | B | BBM | |

| | | | | | |
|-----|----|---------------|---|-----|--|
| 1.2 | 44 | 05/07 → 11/09 | B | BBM | |
|-----|----|---------------|---|-----|--|

| | | | | | |
|---------|----|---------------|---|----------|--|
| 1.2 12V | 47 | 10/01 → 07/07 | B | AZQ, BME | |
| | 51 | 05/07 → 11/09 | B | BZG | |

| | | | | | |
|---------|----|---------------|---|-----|--|
| 1.2 12V | 51 | 05/07 → 11/09 | B | BZG | |
|---------|----|---------------|---|-----|--|

Polo VI (6R)

| | | | | | |
|-----|----|---------|---|------|--|
| 1.2 | 44 | 06/09 → | B | CGPB | |
| | 51 | 06/09 → | B | CGPA | |

| | | | | | |
|-----|----|---------|---|------|--|
| 1.2 | 51 | 06/09 → | B | CGPA | |
|-----|----|---------|---|------|--|

81868 350981868000

PULEGGIA

| | |
|-------------------|-------|
| Diametro Puleggia | Ø52 |
| Altezza Puleggia | 37 |
| Posizione Attacco | 48.5 |
| Diametro Girante | Ø70.3 |
| N° Alette Girante | 10 |
| Posizione Girante | 7.8 |

NISSAN
Primera III, Hatchback, Station Wagon

| | | | | | |
|---------|----|---------|---|-----|--|
| 1.9 dCi | 88 | 04/03 → | D | F9Q | |
|---------|----|---------|---|-----|--|

81868
350981868000

RENAULT
Grand Scénic II

| | | | | |
|---------|----|---------------|---|--|
| 1.9 dCi | 85 | 05/05 → 01/09 | D | F9Q803, F9Q804, F9Q812 |
| | 81 | 05/05 → | D | F9QE804 |
| | 88 | 04/04 → | D | F9Q812 |
| | 96 | 05/05 → | D | F9Q816, F9Q818, F9QEE804, F9QJ803 |

Laguna II, Grantour

| | | | | |
|---------|----|---------|---|-------------------|
| 1.9 dCi | 68 | 03/04 → | D | F9Q664 |
| | 81 | 01/05 → | D | F9Q674, F9Q758 |
| | 96 | 05/05 → | D | F9Q758, F9Q759 |

Megane II, Station Wagon, Coupé-Cabrio

| | | | | |
|---------|---------------|---------------|--------|---|
| 1.9 dCi | 66 | 11/02 → 12/05 | D | F9Q808 |
| | 68 | 03/04 → 08/06 | D | F9Q808 |
| | 81 | 05/05 → 03/09 | D | F9Q804, F9Q816, F9Q818 |
| | 81 | 05/05 → 02/08 | D | F9Q804, F9Q818 |
| | 85 | 11/02 → 02/08 | D | F9Q804, F9Q816, F9Q818 |
| | 85 | 05/05 → 07/09 | D | F9Q818 |
| | 88 | 09/03 → 03/09 | D | F9Q800 |
| | 96 | 05/05 → 02/07 | D | F9Q803, F9Q804 |
| | 96 | 05/05 → 12/09 | D | F9Q803, F9Q804, F9Q816, F9Q818 |
| | 81 | 05/05 → | D | F9Q803, F9Q804, F9Q816, F9Q818 |
| 88 | 11/02 → 02/08 | D | F9Q800 | |

Scénic II

| | | | | |
|-------|----|---------|---|--------------------|
| 1.9 D | 85 | 06/06 → | D | F9Q812, F9QJ803 |
|-------|----|---------|---|--------------------|

81868
350981868000

RENAULT
Scénic II

| | | | | |
|---------|----|---------|---|--|
| 1.9 dCi | 92 | 06/03 → | D | F9Q804 |
| | 81 | 05/05 → | D | F9Q804 |
| | 88 | 06/03 → | D | F9Q812 |
| | 96 | 05/05 → | D | F9Q804, F9Q816, F9Q818, F9QJ803 |

SUZUKI
Grand Vitara II

| | | | | |
|----------|----|---------------|---|------|
| 1.9 DDiS | 95 | 10/05 → 02/15 | D | F9QB |
|----------|----|---------------|---|------|

81869
350981869000

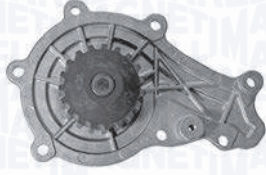

PULEGGIA

| | |
|----------------------------|-----|
| Diametro Puleggia | Ø56 |
| Numero Denti/Gole Puleggia | 19 |
| Altezza Puleggia | 30 |
| Posizione Attacco | 39 |
| Diametro Girante | Ø72 |
| N° Alette Girante | 20 |
| Posizione Girante | 29 |

CITROËN
Berlingo I, Van

| | | | | |
|-------------|----|---------|---|----------------------------|
| 1.6 HDI 110 | 80 | 08/05 → | D | 9HZ (DV6TED4) |
| 1.6 HDI 75 | 55 | 07/05 → | D | 9HW (DV6BTED4), DV6B |
| 1.6 HDI 90 | 66 | 07/05 → | D | 9HX (DV6ATED4) |

Berlingo II, Van

| | | | | |
|-----------------|----|---------|---|-------------------------------------|
| 1.6 BlueHDI 100 | 73 | 12/14 → | D | BHY (DV6FD) |
| 1.6 BlueHDI 120 | 88 | 12/14 → | D | BHZ (DV6FC) |
| 1.6 BlueHDI 75 | 55 | 04/15 → | D | 9HN (DV6ETED), BHW (DV6FE) |
| 1.6 HDi 110 | 80 | 04/08 → | D | 9HZ (DV6TED4) |
| | 82 | 07/10 → | D | 9HL (DV6C), 9HR (DV6C) |

81869
350981869000

KW

CITROËN
Berlingo II, Van

| | | | | |
|----------------|----|---------|---|---------------------------------|
| 1.6 HDi 115 | 84 | 07/10 → | D | 9HL (DV6C) |
| | 84 | 07/10 → | D | 9HR (DV6C) |
| 1.6 HDi 75 | 55 | 04/08 → | D | 9HT (DV6BTED4) |
| | 55 | 04/08 → | D | 9HT (DV6BUTED4) |
| 1.6 HDi 90 | 66 | 07/10 → | D | 9HF (DV6DTED) |
| | 66 | 04/08 → | D | 9HX (DV6ATED4) |
| | 68 | 07/10 → | D | 9HP (DV6DTED) |
| 1.6 HDi 90 16V | 68 | 07/10 → | D | 9HP (DV6DTED), 9HX (DV6ATED4) |
| | | | | 9HS (DV6TED4BU), 9HX (DV6ATED4) |

C 2, Van

| | | | | |
|---------|----|---------|---|---------------|
| 1.6 HDi | 80 | 09/05 → | D | 9HZ (DV6TED4) |
|---------|----|---------|---|---------------|

C 3 I, Pluriel

| | | | | |
|-------------|----|---------|---|----------------|
| 1.6 16V HDi | 66 | 10/05 → | D | 9HX (DV6ATED4) |
| | 80 | 09/05 → | D | 9HZ (DV6TED4) |

C 3 II, Picasso

| | | | | |
|-----------------|----|---------|---|----------------|
| 1.6 BlueHDi 100 | 73 | 07/14 → | D | BHY (DV6FD) |
| 1.6 BlueHDi 75 | 55 | 04/15 → | D | BHW (DV6FE) |
| 1.6 HDi | 66 | 02/09 → | D | 9HX (DV6ATED4) |
| | 68 | 11/09 → | D | 9HP (DV6DTED) |
| | 80 | 02/09 → | D | 9HZ (DV6TED4) |
| 1.6 HDi 110 | 82 | 11/09 → | D | 9HR (DV6C) |
| 1.6 HDi 115 | 84 | 09/12 → | D | 9HD (DV6C) |
| 1.6 HDi 90 | 66 | 11/09 → | D | 9HX (DV6ATED4) |
| | 68 | 07/10 → | D | 9HP (DV6DTED) |

81869
350981869000

KW

CITROËN
C 4 Cactus

| | | | | |
|-----------------|----|---------|---|---------------|
| 1.6 BlueHDi 100 | 73 | 09/14 → | D | BHY (DV6FD) |
| 1.6 HDi 90 | 68 | 09/14 → | D | 9HP (DV6DTED) |

C 4 Aircross

| | | | | |
|-----------------|----|---------|---|------------|
| 1.6 HDi 115 | 84 | 04/12 → | D | 9HL (DV6C) |
| 1.6 HDi 115 AWC | 84 | 05/12 → | D | 9HL (DV6C) |

C 4 I, Coupé, Picasso, Grand Picasso

| | | | | |
|-------------|----|---------------|---|------------------------------|
| 1.6 HDi | 66 | 11/04 → 07/11 | D | 9HX (DV6ATED4) |
| | 80 | 11/04 → 07/11 | D | 9HY (DV6TED4), 9HZ (DV6TED4) |
| 1.6 HDi 110 | 82 | 09/10 → | D | 9HL (DV6C), 9HR (DV6C) |
| | 82 | 09/10 → 08/13 | D | 9HR (DV6C) |

C 4 II, Picasso, Grand Picasso

| | | | | |
|-----------------------|----|---------|---|-------------------------|
| 1.6 BlueHDi 100 | 73 | 01/15 → | D | BHY (DV6FD) |
| 1.6 BlueHDi 115 | 85 | 08/14 → | D | BHX (DV6FC) |
| 1.6 BlueHDi 120 | 88 | 07/14 → | D | BHZ (DV6FC) |
| 1.6 HDi / BlueHDi 115 | 85 | 09/13 → | D | 9HC (DV6C), BHX (DV6FC) |
| 1.6 HDi 110 | 82 | 11/09 → | D | 9HR (DV6C) |
| 1.6 HDi 115 | 84 | 07/12 → | D | 9HD (DV6C), 9HR (DV6C) |
| 1.6 HDi 90 | 68 | 09/13 → | D | 9HP (DV6DTED) |

C 5 II, Break

| | | | | |
|---------|----|---------|---|------------------------------|
| 1.6 HDi | 80 | 09/04 → | D | 9HY (DV6TED4), 9HZ (DV6TED4) |
|---------|----|---------|---|------------------------------|

C 5 III, Break

| | | | | |
|-------------|----|---------|---|------------------------|
| 1.6 HDi | 80 | 02/08 → | D | 9HZ (DV6TED4) |
| 1.6 HDi 110 | 82 | 07/10 → | D | 9HL (DV6C), 9HR (DV6C) |

81869
350981869000

CITROËN
C 5 III, Break

| | | | | |
|-------------|----|---------|---|---------------------------|
| 1.6 HDi 115 | 84 | 01/12 → | D | 9HL (DV6C), 9HR (DV6C) |
|-------------|----|---------|---|---------------------------|

C-Elysee

| | | | | |
|-----------------|----|---------|---|-------------|
| 1.6 BlueHDi 100 | 73 | 11/14 → | D | BHY (DV6FD) |
|-----------------|----|---------|---|-------------|

| | | | | |
|------------|----|---------|---|----------------------------------|
| 1.6 HDi 92 | 68 | 11/12 → | D | 9HJ (DV6DTEDM), 9HP (DV6DTEd) |
|------------|----|---------|---|----------------------------------|

DS 3, Cabrio

| | | | | |
|-----------------|----|---------------|---|-------------|
| 1.6 BlueHDi 100 | 73 | 07/14 → 07/15 | D | BHY (DV6FD) |
|-----------------|----|---------------|---|-------------|

| | | | | |
|-----------------|----|---------------|---|-------------|
| 1.6 BlueHDi 120 | 88 | 10/13 → 07/15 | D | BHZ (DV6FC) |
|-----------------|----|---------------|---|-------------|

| | | | | |
|-------------|----|---------------|---|------------|
| 1.6 HDi 110 | 82 | 11/09 → 07/15 | D | 9HR (DV6C) |
|-------------|----|---------------|---|------------|

| | | | | |
|-------------|----|---------------|---|---------------------------|
| 1.6 HDi 115 | 84 | 08/12 → 07/15 | D | 9HD (DV6C), 9HL (DV6C) |
|-------------|----|---------------|---|---------------------------|

| | | | | |
|--|----|---------------|---|-------------|
| | 85 | 10/13 → 07/15 | D | BHX (DV6FC) |
|--|----|---------------|---|-------------|

| | | | | |
|------------|----|---------------|---|---------------|
| 1.6 HDi 90 | 68 | 11/09 → 07/15 | D | 9HP (DV6DTEd) |
|------------|----|---------------|---|---------------|

| | | | | |
|--|----|---------------|---|---------------|
| | 69 | 01/13 → 07/15 | D | 9HP (DV6DTEd) |
|--|----|---------------|---|---------------|

| | | | | |
|------------------|----|---------------|--|--|
| DS 4 1.6 HDi 110 | 81 | 04/11 → 07/15 | | |
|------------------|----|---------------|--|--|

| | | | | |
|-------------|----|---------------|---|------------|
| 1.6 HDi 110 | 82 | 04/11 → 07/15 | D | 9HR (DV6C) |
|-------------|----|---------------|---|------------|

| | | | | |
|-------------|----|---------------|---|---------------------------|
| 1.6 HDi 115 | 84 | 08/12 → 07/15 | D | 9HD (DV6C), 9HL (DV6C) |
|-------------|----|---------------|---|---------------------------|

| | | | | |
|------------|----|---------------|---|---------------|
| 1.6 HDi 90 | 68 | 05/11 → 07/15 | D | 9HP (DV6DTEd) |
|------------|----|---------------|---|---------------|

DS 5

| | | | | |
|-----------------|----|---------------|---|-------------|
| 1.6 BlueHDi 120 | 88 | 07/14 → 07/15 | D | BHZ (DV6FC) |
|-----------------|----|---------------|---|-------------|

| | | | | |
|---------|----|---------------|---|-------------|
| 1.6 HDi | 85 | 11/13 → 07/15 | D | BHX (DV6FC) |
|---------|----|---------------|---|-------------|

| | | | | |
|-------------|----|---------------|---|------------|
| 1.6 HDi 110 | 82 | 11/11 → 07/15 | D | 9HR (DV6C) |
|-------------|----|---------------|---|------------|

| | | | | |
|-------------|----|---------------|---|------------|
| 1.6 HDi 115 | 84 | 06/12 → 07/15 | D | 9HD (DV6C) |
|-------------|----|---------------|---|------------|

Jumpy III

| | | | | |
|----------------|----|---------|---|----------------|
| 1.6 HDi 90 16V | 66 | 01/07 → | D | 9HU (DV6UTED4) |
|----------------|----|---------|---|----------------|

| | | | | |
|---------------|----|---------|---|------------------------------|
| 1.6 HDi 90 8V | 66 | 01/07 → | D | 9HH (DV6DUM), 9HM (DV6UC) |
|---------------|----|---------|---|------------------------------|

81869
350981869000

CITROËN
Xsara, Break, Coupé, Picasso, Van

| | | | | |
|---------|----|---------|---|----------------|
| 1.6 HDi | 66 | 09/05 → | D | 9HX (DV6ATED4) |
|---------|----|---------|---|----------------|

| | | | | |
|--|----|---------|---|---------------------------------|
| | 80 | 05/04 → | D | 9HY (DV6TED4), 9HZ (DV6TED4) |
|--|----|---------|---|---------------------------------|

DS
DS 3

| | | | | |
|-----------------|----|---------|---|--|
| 1.6 BlueHDi 100 | 73 | 04/15 → | D | |
|-----------------|----|---------|---|--|

| | | | | |
|-----------------|----|---------|---|--|
| 1.6 BlueHDi 120 | 88 | 07/15 → | D | |
|-----------------|----|---------|---|--|

DS 4 / DS 4 CROSSBACK

| | | | | |
|-----------------|----|---------|---|--|
| 1.6 BlueHDi 120 | 88 | 07/15 → | D | |
|-----------------|----|---------|---|--|

FIAT
Scudo II

| | | | | |
|----------------|----|---------|---|-----|
| 1.6 D Multijet | 66 | 01/07 → | D | 9HU |
|----------------|----|---------|---|-----|

FORD
B-Max, Van

| | | | | |
|----------|----|---------|---|------|
| 1.5 TDCi | 55 | 10/12 → | D | UGJC |
|----------|----|---------|---|------|

| | | | | |
|----------|----|---------|---|------|
| 1.6 TDCi | 70 | 10/12 → | D | T3JB |
|----------|----|---------|---|------|

C-Max I

| | | | | |
|----------|----|---------------|---|---------------------|
| 1.6 TDCi | 66 | 02/07 → 09/10 | D | GPDA, HHDA, HHDB |
|----------|----|---------------|---|---------------------|

| | | | | |
|--|----|---------------|---|-------------|
| | 74 | 02/07 → 09/10 | D | G8DC, MTD A |
|--|----|---------------|---|-------------|

| | | | | |
|--|----|---------------|---|---------------------|
| | 80 | 02/07 → 09/10 | D | G8DA, G8DB, G8DD |
|--|----|---------------|---|---------------------|

C-Max II, Van

| | | | | |
|----------|----|---------|---|------------|
| 1.6 TDCi | 85 | 12/10 → | D | T1DA, T1DB |
|----------|----|---------|---|------------|

Ecosport II

| | | | | |
|----------|----|---------|---|------|
| 1.5 TDCi | 66 | 10/13 → | D | UGJE |
|----------|----|---------|---|------|

Fiesta V, Van

| | | | | |
|----------|----|---------------|---|------------|
| 1.6 TDCi | 66 | 11/04 → 06/08 | D | HHJA, HHJB |
|----------|----|---------------|---|------------|

Fiesta VI, Van

| | | | | |
|----------|----|---------|---|------------|
| 1.4 TDCi | 51 | 07/10 → | D | F6JD, KVJA |
|----------|----|---------|---|------------|

| | | | | |
|----------|----|---------|---|------|
| 1.5 TDCi | 55 | 09/12 → | D | UGJC |
|----------|----|---------|---|------|

| | | | | |
|----------|----|---------|---|------------|
| 1.6 TDCi | 55 | 06/08 → | D | HHJF, UBJA |
|----------|----|---------|---|------------|

| | | | | |
|--|----|---------|---|---------------------|
| | 66 | 06/08 → | D | HHJC, HHJD, HHJE |
|--|----|---------|---|---------------------|

| | | | | |
|--|----|---------|---|---------------------|
| | 70 | 02/10 → | D | T3JA, TZJA, TZJB |
|--|----|---------|---|---------------------|

81869 350981869000

FORD
Focus C-Max

| | | | | |
|----------|----|---------------|---|------------|
| 1.6 TDCi | 66 | 02/05 → 03/07 | D | HHDA, HHDB |
| | 80 | 10/03 → 03/07 | D | G8DA, G8DB |

Focus II, Station Wagon, Cabrio

| | | | | |
|----------|---------------|---------------|------|------------------------------|
| 1.6 TDCi | 66 | 01/05 → 09/12 | D | GPDA, GPDB, GPDC, HHDA, HHDB |
| | 66 | 07/04 → 09/12 | D | GPDA, GPDC, HHDA, HHDB |
| | 66 | 04/05 → 09/12 | D | HHDA, HHDB |
| | 74 | 07/04 → 09/12 | D | G8DC, MTDA |
| | 80 | 07/04 → 09/12 | D | G8DA, G8DB, G8DD, G8DE, G8DF |
| 81 | 12/07 → 09/12 | D | G8DA | |

Focus III, Station Wagon, Van

| | | | | |
|-------------------|----|---------|---|------------|
| 1.6 TDCi | 70 | 07/10 → | D | T3DA, T3DB |
| | 85 | 07/10 → | D | T1DA, T1DB |
| 1.6 TDCi ECOnetic | 77 | 05/12 → | D | NGDA, NGDB |

Fusion

| | | | | |
|----------|----|---------------|---|------------|
| 1.6 TDCi | 66 | 11/04 → 12/12 | D | HHJA, HHJB |
|----------|----|---------------|---|------------|

Galaxy II

| | | | | |
|----------|----|---------------|---|------------|
| 1.6 TDCi | 85 | 02/11 → 06/15 | D | T1WA, T1WB |
|----------|----|---------------|---|------------|

Mondeo IV, Station Wagon

| | | | | |
|----------|----|---------------|---|------------------|
| 1.6 TDCi | 85 | 02/11 → 09/14 | D | T1BA, T1BB, T1BC |
|----------|----|---------------|---|------------------|

S-Max

| | | | | |
|----------|----|---------|---|------------|
| 1.6 TDCi | 85 | 02/11 → | D | T1WA, T1WB |
|----------|----|---------|---|------------|

Tourneo II Connect, Courier, Custom

| | | | | |
|----------|----|---------|---|------------|
| 1.6 TDCi | 55 | 09/13 → | D | UBGA |
| | 70 | 09/13 → | D | TZGA, TZGB |
| | 85 | 09/13 → | D | T1GA |

Transit Connect II, Courier

| | | | | |
|----------|----|---------|---|------------|
| 1.6 TDCi | 55 | 02/13 → | D | UBGA |
| | 70 | 02/13 → | D | TZGA, TZGB |
| | 85 | 02/13 → | D | T1GA |

MAZDA
2 II, Saloon

| | | | | |
|-----------|----|---------------|---|------------|
| 1.6 MZ-CD | 66 | 10/08 → 06/15 | D | Y406, Y646 |
| | 70 | 06/11 → 06/15 | D | Y655, Y661 |

3 I, Saloon

| | | | | |
|--------------|----|---------------|---|------|
| 1.6 DI Turbo | 80 | 06/04 → 06/09 | D | Y601 |
| 1.6 MZ-CD | 66 | 06/06 → 12/09 | D | Y406 |

81869 350981869000

MAZDA
3 II, Saloon

| | | | | |
|------------|----|---------|---|------------|
| 1.6 MZR CD | 80 | 12/08 → | D | Y601, Y642 |
| | 80 | 12/08 → | D | Y642 |
| | 85 | 11/10 → | D | Y650, Y655 |

5 II

| | | | | |
|--------|----|---------|---|------------|
| 1.6 CD | 85 | 09/10 → | D | Y650, Y655 |
|--------|----|---------|---|------------|

MINI
Mini II (R55, R56, R57, R58, R59)

| | | | | |
|----------|----|---------------|---|-----------------------|
| Cooper D | 80 | 10/07 → 02/10 | D | 9HZ (DV6TED4) |
| | 80 | 11/06 → 09/10 | D | 9HZ (DV6TED4), W16D16 |
| One D | 66 | 06/09 → 07/10 | D | 9HZ (DV6TED4) |

MITSUBISHI
ASX, Van

| | | | | |
|--------------|----|---------|---|-----|
| 1.6 DI-D | 84 | 07/15 → | D | 9HD |
| 1.6 DI-D 4WD | 84 | 07/15 → | D | 9HD |

PEUGEOT
205 II, Van

| | | | | |
|-------------|----|---------|---|------------------------------|
| 1.6 HDi 110 | 80 | 05/04 → | D | 9HY (DV6TED4), 9HZ (DV6TED4) |
|-------------|----|---------|---|------------------------------|

206, CC, Van

| | | | | |
|-------------|----|---------|---|---------------|
| 1.6 HDi 110 | 80 | 04/05 → | D | 9HZ (DV6TED4) |
|-------------|----|---------|---|---------------|

207, Station Wagon, CC, Van

| | | | | |
|-------------|---------|---------|------------|-------------------------------|
| 1.6 HDi | 66 | 02/06 → | D | 9HV (DV6TED4), 9HX (DV6ATED4) |
| | 66 | 06/07 → | D | 9HX (DV6ATED4) |
| | 68 | 11/09 → | D | 9HP (DV6DTED) |
| | 80 | 02/06 → | D | 9HY (DV6TED4), 9HZ (DV6TED4) |
| | 80 | 02/07 → | D | 9HZ (DV6TED4) |
| 82 | 08/09 → | D | 9HR (DV6C) | |
| 1.6 HDi 110 | 82 | 08/09 → | D | 9HR (DV6C) |

81869
350981869000

PEUGEOT
208

| | | | | |
|----------------------|----|---------|---|-----------------------------|
| 1.6 BlueHDi 100 | 73 | 01/15 → | D | BHY (DV6FD) |
| 1.6 BlueHDi 120 | 88 | 11/13 → | D | BHZ (DV6FC) |
| 1.6 HDi | 68 | 03/12 → | D | 9HP (DV6DTEd) |
| | 84 | 03/12 → | D | 9HD (DV6CTED) |
| | 85 | 04/14 → | D | BHX (DV6FC) |
| 1.6 HDi / BlueHDi 75 | 55 | 01/13 → | D | 9HK (DV6ETEDM), BHW (DV6FE) |

301

| | | | | |
|------------|----|---------|---|---------------|
| 1.6 HDi 90 | 68 | 11/12 → | D | 9HF (DV6DTEd) |
|------------|----|---------|---|---------------|

307, Station Wagon, CC

| | | | | |
|-------------|----|---------|---|---|
| 1.6 HDi | 66 | 04/05 → | D | 9HV (DV6ATED4) |
| | 66 | 04/05 → | D | 9HV (DV6ATED4), 9HV (DV6TED4), 9HX (DV6ATED4) |
| 1.6 HDi 110 | 80 | 02/04 → | D | 9HY (DV6TED4), 9HZ (DV6TED4) |
| 1.6 HDi 90 | 66 | 12/06 → | D | 9HV (DV6ATED4), 9HX (DV6ATED4) |

308 I, Station Wagon, CC

| | | | | |
|---------|----|---------|---|--------------------------------|
| 1.6 HDi | 66 | 09/07 → | D | 9HV (DV6ATED4), 9HX (DV6ATED4) |
| | 66 | 09/07 → | D | |
| | 68 | 11/09 → | D | 9HP (DV6DTEd) |
| | 80 | 09/07 → | D | 9HZ (DV6TED4) |
| | 82 | 12/09 → | D | 9HR (DV6C) |
| | 84 | 03/13 → | D | |

81869
350981869000

PEUGEOT
308 II Station Wagon

| | | | | |
|-----------------------|----|---------|---|-------------------------|
| 1.6 BlueHDi 100 | 73 | 04/14 → | D | BHY (DV6FD) |
| 1.6 BlueHDi 120 | 88 | 11/13 → | D | BHZ (DV6FC) |
| 1.6 HDi | 68 | 09/13 → | D | |
| 1.6 HDi / BlueHDi 115 | 85 | 09/13 → | D | 9HC (DV6C), BHZ (DV6FC) |
| 1.6 HDi 100 | 73 | 04/14 → | D | BHY (DV6FD) |
| 1.6 HDi 92 | 68 | 03/14 → | D | |

407, Station Wagon, Coupé

| | | | | |
|-------------|----|---------|---|---------------|
| 1.6 HDi 110 | 80 | 05/04 → | D | 9HZ (DV6TED4) |
|-------------|----|---------|---|---------------|

508, Station Wagon

| | | | | |
|-----------------|----|---------|---|---------------|
| 1.6 BlueHDi 120 | 88 | 03/14 → | D | BHZ (DV6FC) |
| 1.6 HDi | 82 | 11/10 → | D | 9HR (DV6C) |
| | 84 | 02/12 → | D | 9HD (DV6CTED) |
| | 85 | 09/14 → | D | BHX (DV6FC) |

1007

| | | | | |
|---------|----|---------|---|---------------|
| 1.6 HDi | 80 | 06/07 → | D | 9HZ (DV6TED4) |
|---------|----|---------|---|---------------|

2008

| | | | | |
|-----------------|----|---------|---|---------------|
| 1.6 BlueHDi 100 | 73 | 01/15 → | D | BHY (DV6FD) |
| 1.6 BlueHDi 120 | 88 | 07/14 → | D | BHZ (DV6FC) |
| 1.6 BlueHDi 75 | 55 | 01/15 → | D | BHW (DV6FE) |
| 1.6 HDi | 68 | 03/13 → | D | 9HP (DV6DTEd) |
| | 84 | 03/13 → | D | 9HD (DV6CTED) |
| | 85 | 07/14 → | D | BHX (DV6FC) |

3008

| | | | | |
|-----------------|----|---------|---|---------------|
| 1.6 BlueHDi 120 | 88 | 05/14 → | D | BHZ (DV6FC) |
| 1.6 HDi | 80 | 06/09 → | D | 9HZ (DV6TED4) |
| | 82 | 08/10 → | D | 9HR (DV6C) |
| | 84 | 03/13 → | D | 9HD (DV6CTED) |

81869 **350981869000**

KW

PEUGEOT
4008

| | | | | |
|-------------|----|---------|---|------------|
| 1.6 HDi AWC | 84 | 05/12 → | D | 9HD (DV6C) |
|-------------|----|---------|---|------------|

5008

| | | | | |
|-----------------|----|---------|---|-------------|
| 1.6 BlueHDi 120 | 88 | 05/14 → | D | BHZ (DV6FC) |
|-----------------|----|---------|---|-------------|

| | | | | |
|---------|----|---------|---|---------------|
| 1.6 HDi | 80 | 09/09 → | D | 9HZ (DV6TED4) |
|---------|----|---------|---|---------------|

| | | | | |
|---------|----|---------|---|------------|
| 1.6 HDi | 82 | 08/10 → | D | 9HR (DV6C) |
|---------|----|---------|---|------------|

| | | | | |
|---------|----|---------|---|---------------|
| 1.6 HDi | 84 | 03/13 → | D | 9HD (DV6CTED) |
|---------|----|---------|---|---------------|

Expert II, Tepee

| | | | | |
|------------|----|---------|---|----------------|
| 1.6 HDi 90 | 66 | 01/07 → | D | 9HU (DV6UTED4) |
|------------|----|---------|---|----------------|

| | | | | |
|----------------|----|---------|---|----------------|
| 1.6 HDi 90 16V | 66 | 01/07 → | D | 9HU (DV6UTED4) |
|----------------|----|---------|---|----------------|

Partner I

| | | | | |
|------------|----|---------|---|----------------|
| 1.6 HDi 75 | 55 | 02/06 → | D | 9HW (DV6BTED4) |
|------------|----|---------|---|----------------|

| | | | | |
|------------|----|---------|---|----------------|
| 1.6 HDi 90 | 66 | 10/05 → | D | 9HX (DV6ATED4) |
|------------|----|---------|---|----------------|

Partner II, Tepee

| | | | | |
|---------|----|---------|---|--|
| 1.6 HDi | 55 | 04/08 → | D | 9HN (DV6ETED4), 9HT (DV6BTED4), 9HW (DV6BTED4) |
|---------|----|---------|---|--|

| | | | | |
|---------|----|---------|---|--------------------------------|
| 1.6 HDi | 55 | 04/08 → | D | 9HT (DV6BTED4), 9HW (DV6BTED4) |
|---------|----|---------|---|--------------------------------|

| | | | | |
|---------|----|---------|---|---------------|
| 1.6 HDi | 80 | 04/08 → | D | 9HZ (DV6TED4) |
|---------|----|---------|---|---------------|

| | | | | |
|---------|----|---------|---|------------|
| 1.6 HDi | 82 | 08/10 → | D | 9HL (DV6C) |
|---------|----|---------|---|------------|

| | | | | |
|---------|----|---------|---|------------|
| 1.6 HDi | 84 | 03/13 → | D | 9HL (DV6C) |
|---------|----|---------|---|------------|

| | | | | |
|-------------|----|---------|---|---------------------------------|
| 1.6 HDi 16V | 66 | 04/08 → | D | 9HS (DV6TED4BU), 9HX (DV6ATED4) |
|-------------|----|---------|---|---------------------------------|

| | | | | |
|-------------|----|---------|---|-------------------------------|
| 1.6 HDi 16V | 66 | 04/08 → | D | 9HV (DV6TED4), 9HX (DV6ATED4) |
|-------------|----|---------|---|-------------------------------|

81869 **350981869000**

KW

PEUGEOT
Partner II, Tepee

| | | | | |
|-----------------|----|---------|---|---------------------------------|
| 1.6 HDi 16V 4x4 | 66 | 04/12 → | D | 9HS (DV6TED4BU), 9HX (DV6ATED4) |
|-----------------|----|---------|---|---------------------------------|

| | | | | |
|------------|----|---------|---|---------------|
| 1.6 HDi 90 | 68 | 04/10 → | D | 9HP (DV6DTED) |
|------------|----|---------|---|---------------|

| | | | | |
|------------|----|---------|---|-------------------------------|
| 1.6 HDi 90 | 68 | 04/10 → | D | 9HP (DV6DTED), 9HX (DV6ATED4) |
|------------|----|---------|---|-------------------------------|

SUZUKI
SX4

| | | | | |
|----------|----|---------|---|-----|
| 1.6 DDIS | 66 | 04/07 → | D | 9HX |
|----------|----|---------|---|-----|

VOLVO

| | | | | |
|------------|----|---------------|---|--------|
| C 30 1.6 D | 80 | 10/06 → 12/12 | D | D4164T |
|------------|----|---------------|---|--------|

| | | | | |
|--------|----|---------------|---|--------|
| 1.6 D2 | 84 | 10/10 → 12/12 | D | D4162T |
|--------|----|---------------|---|--------|

S 40 II

| | | | | |
|-------|----|---------|---|--------|
| 1.6 D | 81 | 01/05 → | D | D4164T |
|-------|----|---------|---|--------|

| | | | | |
|--------|----|---------|---|--------|
| 1.6 D2 | 84 | 10/10 → | D | D4162T |
|--------|----|---------|---|--------|

S 60 II

| | | | | |
|------------|----|---------|---|--------|
| DRIVE / D2 | 84 | 01/11 → | D | D4162T |
|------------|----|---------|---|--------|

S 80 II

| | | | | |
|-------------|----|---------|---|--------|
| 1.6 D DRIVE | 80 | 01/10 → | D | D4164T |
|-------------|----|---------|---|--------|

| | | | | |
|-----------|----|---------|---|--------|
| 1.6 DRIVE | 84 | 06/11 → | D | D4162T |
|-----------|----|---------|---|--------|

V 40 II

| | | | | |
|----|----|---------|---|--------|
| D2 | 84 | 03/12 → | D | D4162T |
|----|----|---------|---|--------|

V 50

| | | | | |
|-------|----|---------|---|--------|
| 1.6 D | 81 | 01/05 → | D | D4164T |
|-------|----|---------|---|--------|

| | | | | |
|--------|----|---------|---|--------|
| 1.6 D2 | 84 | 01/10 → | D | D4162T |
|--------|----|---------|---|--------|

V 60

| | | | | |
|-----------|----|---------|---|--------|
| 1.6 DRIVE | 84 | 06/11 → | D | D4162T |
|-----------|----|---------|---|--------|

V 70 III

| | | | | |
|-------|----|---------|---|--------|
| 1.6 D | 80 | 01/10 → | D | D4164T |
|-------|----|---------|---|--------|

| | | | | |
|----------------|----|---------|---|--------|
| 1.6 DRIVE / D2 | 84 | 06/11 → | D | D4162T |
|----------------|----|---------|---|--------|

81872

350981872000

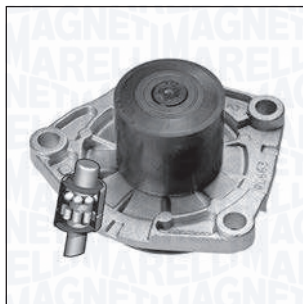

PULEGGIA

Diametro Puleggia Ø48
 Altezza Puleggia 37
 Posizione Attacco 44.5
 Diametro Girante Ø75.9
 N° Alette Girante 8
 Posizione Girante 17.5

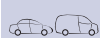

KW



ALFA ROMEO

147

| | | | | |
|-------------|-----|---------------|---|-----------|
| 1.9 JTD 16V | 93 | 09/03 → 09/04 | D | 937A4.000 |
| | 100 | 10/04 → 03/10 | D | 192B1.000 |
| 1.9 JTD 16V | 103 | 11/02 → 03/10 | D | 192A5.000 |
| | 110 | 09/04 → 03/10 | D | 937A5.000 |
| 1.9 JTD 16V | 125 | 06/08 → 03/10 | D | 937A6.000 |

156, Sportwagon

| | | | | |
|----------------|-----|---------------|---|-----------------------|
| 1.9 JTD | 93 | 11/03 → 09/05 | D | 937A4.000 |
| | 100 | 11/02 → 11/04 | D | 192B1.000 |
| | 110 | 07/04 → 09/05 | D | 937A5.000 |
| 1.9 JTD 16V | 103 | 11/02 → 09/05 | D | 192A5.000 |
| 1.9 JTD 16V Q4 | 110 | 07/04 → 05/06 | D | 937A5.000 |
| 2.4 JTD | 120 | 06/03 → 09/05 | D | 841M.000, 841N.000 |
| | 129 | 10/03 → 09/05 | D | 841G.000 |

159, Sportwagon

| | | | | |
|-------------|-----|---------------|---|-------------------------|
| 1.9 JTD 16V | 100 | 03/06 → 11/11 | D | 937A8.000 |
| | 100 | 09/05 → 11/11 | D | 937A8.000, 939A8.000 |
| | 110 | 09/05 → 11/11 | D | 939A2.000 |
| 2.0 JTD | 100 | 06/10 → 11/11 | D | 939B4.000 |
| | 120 | 05/09 → 11/11 | D | 844A2.000 |
| 2.4 JTD | 125 | 05/09 → 11/11 | D | 939B3.000 |
| | 147 | 09/05 → 11/11 | D | 939A3.000 |
| 2.4 JTD Q4 | 154 | 05/07 → 11/11 | D | 939A9.000 |

166

| | | | | |
|---------|-----|---------------|---|-----------------------|
| 2.4 JTD | 120 | 10/03 → 06/07 | D | 841M.000, 841N.000 |
| | 129 | 10/03 → 06/07 | D | 841G.000, 841H.000 |
| | 132 | 07/06 → 06/07 | D | 841M.000 |
| | 136 | 07/05 → 06/07 | D | 841M.000, 936B.000 |

81872

350981872000



KW



ALFA ROMEO

Brera

| | | | | |
|--------------|-----|---------------|---|-----------|
| 2.0 JTDM | 120 | 03/08 → 06/10 | D | 844A2.000 |
| | 125 | 05/09 → 06/10 | D | 939B3.000 |
| 2.4 JTDM 20V | 147 | 01/06 → 06/10 | D | 939A3.000 |
| | 154 | 05/07 → 06/10 | D | 939A9.000 |

Giulietta III

| | | | | |
|----------|-----|---------|---|-------------------------|
| 1.6 JTDM | 77 | 04/10 → | D | 940A3.000 |
| | 100 | 04/10 → | D | 940A8.000, 940B6.000 |
| | 103 | 04/10 → | D | 940A5.000 |
| 2.0 JTDM | 110 | 08/13 → | D | 940B5.000 |
| | 120 | 04/10 → | D | 940A7.000 |
| | 125 | 04/10 → | D | 940A4.000 |
| | 129 | 11/13 → | D | 940B4.000 |

GT II

| | | | | |
|---------|-----|---------------|---|-----------|
| 1.9 JTD | 110 | 11/03 → 09/10 | D | 937A5.000 |
| | 125 | 05/08 → 09/10 | D | 937A6.000 |

Mito

| | | | | |
|----------|----|---------|---|-------------------------|
| 1.6 JTDM | 85 | 09/08 → | D | 955A4.000 |
| | 88 | 09/08 → | D | 198A2.000, 955A3.000 |

Spider V

| | | | | |
|----------|-----|---------------|---|-----------|
| 2.0 JTDM | 120 | 04/09 → 06/10 | D | 844A2.000 |
| | 125 | 05/09 → 06/10 | D | 939B3.000 |
| 2.4 JTDM | 147 | 04/07 → 06/10 | D | 939A3.000 |
| | 154 | 03/08 → 06/10 | D | 939A3.000 |

CADILLAC

BLS, Station Wagon

| | | | | |
|-------|-----|---------|---|--------|
| 1.9 D | 110 | 04/06 → | D | Z19DTH |
| | 132 | 12/07 → | D | Z19DTR |

CHEVROLET

Malibu

| | | | | |
|-------|-----|---------|---|-----|
| 2.0 D | 118 | 04/12 → | D | LBS |
|-------|-----|---------|---|-----|

CHRYSLER

Delta

| | | | | |
|----------------|-----|---------|---|-----------|
| 1.6 D Multijet | 88 | 08/11 → | D | 198A2.000 |
| 2.0 D Multijet | 121 | 08/11 → | D | 198A5.000 |

FIAT

500L

| | | | | |
|----------------|----|---------|---|-------------------------|
| 1.6 D Multijet | 77 | 09/12 → | D | 199B5.000 |
| | 88 | 09/13 → | D | 940C1.000, 955A3.000 |

500X

| | | | | |
|----------------|----|---------|---|----------|
| 1.6 D Multijet | 84 | 09/14 → | D | 55260384 |
| | 88 | 09/14 → | D | 55260384 |

81872
350981872000

FIAT
Bravo II, Van

| | | | | |
|----------------|-----|---------|---|-------------------------|
| 1.6 D Multijet | 66 | 03/08 → | D | 198A6.000 |
| | 77 | 03/08 → | D | 198A3.000 |
| | 77 | 09/07 → | D | 198A3.000, 844A3.000 |
| | 85 | 11/08 → | D | 955A4.000 |
| | 88 | 03/08 → | D | 198A2.000 |
| 1.9 D Multijet | 110 | 04/07 → | D | 937A5.000 |
| 2.0 D Multijet | 120 | 09/08 → | D | 198A8.000, 844A2.000 |
| | 121 | 09/08 → | D | 198A5.000 |

Croma II

| | | | | |
|----------------|-----|---------|---|-----------|
| 1.9 D Multijet | 100 | 12/05 → | D | 939A8.000 |
| | 110 | 06/05 → | D | 939A2.000 |
| 2.4 D Multijet | 147 | 06/05 → | D | 939A3.000 |

Doblò II, Cargo

| | | | | |
|----------------|----|---------|---|-------------------------|
| 1.6 D Multijet | 66 | 02/10 → | D | 263A4.000 |
| | 66 | 02/10 → | D | 263A4.000, 263A5.000 |
| | 74 | 02/10 → | D | 263A3.000 |
| | 77 | 02/10 → | D | 198A3.000 |
| 2.0 D Multijet | 99 | 02/10 → | D | 263A1.000 |

Ducato V

| | | | | |
|---------------------------|----|---------|---|-------------------------|
| 115 Multijet 2,0 D | 85 | 06/11 → | D | 250A1.000, 250A2.000 |
| 120 Multijet 2,3 D 4x4 | 88 | 03/10 → | D | F1AE0481D |

Freemont

| | | | | |
|-------------|-----|---------|---|-------------------------|
| 2.0 JTD | 100 | 08/11 → | D | 939B5.000 |
| | 103 | 08/11 → | D | 939B5.000, 940A5.000 |
| | 120 | 08/11 → | D | 939B5.000 |
| | 125 | 08/11 → | D | 939B5.000 |
| 2.0 JTD 4x4 | 120 | 08/11 → | D | 939B5.000 |
| | 125 | 08/11 → | D | 939B5.000 |

Grande Punto, Van

| | | | | |
|----------------|----|---------|---|-----------|
| 1.6 D Multijet | 88 | 07/08 → | D | 955A3.000 |
| 1.9 D Multijet | 85 | 06/06 → | D | 939A7.000 |

Idea

| | | | | |
|----------------|----|---------|---|-----------|
| 1.6 D Multijet | 88 | 05/08 → | D | 350A2.000 |
|----------------|----|---------|---|-----------|

Linea

| | | | | |
|----------------|----|---------|---|-----------|
| 1.6 D Multijet | 77 | 06/09 → | D | 198A3.000 |
|----------------|----|---------|---|-----------|

Punto Evo, Van

| | | | | |
|----------------|----|---------------|---|-----------|
| 1.6 D Multijet | 88 | 10/09 → 02/12 | D | 955A3.000 |
|----------------|----|---------------|---|-----------|

81872
350981872000

FIAT
Sedici

| | | | | |
|-----------------------------|-----|---------------|---|-----------|
| 2.0 D Multijet | 99 | 06/06 → | D | D20AA |
| 2.0 D Multijet 4x4 | 99 | 06/06 → | D | D20AA |
| Stilo, Station Wagon | | | | |
| 1.9 D Multijet | 110 | 09/05 → 11/06 | D | 937A5.000 |
| | 93 | 09/03 → 11/06 | D | 937A4.000 |
| 1.9 JTD | 100 | 04/04 → 11/06 | D | 192B1.000 |
| | 103 | 01/04 → 11/06 | D | 192A5.000 |

JEEP
Renegade

| | | | | |
|-------------|-----|---------|---|-----|
| 1.6 CRD | 88 | 07/14 → | D | EJK |
| | 88 | 07/14 → | D | EBT |
| 2.0 CRD 4x4 | 103 | 07/14 → | D | EBT |
| | 125 | 07/14 → | D | EBT |

LANCIA
Delta III

| | | | | |
|----------------|-----|---------------|---|-------------------------|
| 1.6 D Multijet | 77 | 04/11 → 08/14 | D | 944A3.000 |
| | 85 | 08/08 → 08/14 | D | 955A4.000 |
| | 88 | 09/08 → 08/14 | D | 198A2.000 |
| 1.9 D Multijet | 140 | 01/09 → 08/14 | D | 844A1.000 |
| 2.0 D Multijet | 120 | 09/08 → 08/14 | D | 844A2.000 |
| | 121 | 09/08 → 08/14 | D | 198A5.000, 198A8.000 |

Musa

| | | | | |
|----------------|----|---------------|---|-------------------------|
| 1.6 D Multijet | 85 | 07/08 → 09/12 | D | 350A2.000, 350A3.000 |
| | 88 | 07/08 → 09/12 | D | 350A2.000 |

Thesis

| | | | | |
|----------------|-----|---------------|---|-----------------------|
| 2.4 D Multijet | 136 | 04/06 → 07/09 | D | 841P.000 |
| 2.4 JTD | 120 | 09/03 → 07/09 | D | 841M.000, 841N.000 |
| | 129 | 05/03 → 07/09 | D | 841G.000 |

OPEL
Astra H, Station Wagon, GTC, Twin Top, Van

| | | | | |
|--------------|-----|---------|---|--------|
| 1.9 CDTI | 110 | 09/04 → | D | Z19DTH |
| 1.9 CDTI 16V | 88 | 04/04 → | D | Z19DTJ |

Astra J, Station Wagon, GTC

| | | | | |
|------------------|-----|---------|---|--------|
| 2.0 Biturbo CDTI | 143 | 12/12 → | D | A20DTR |
| 2.0 CDTI | 96 | 10/10 → | D | |
| | 118 | 12/09 → | D | A20DTH |
| | 121 | 10/11 → | D | A20DTH |

81872
350981872000

OPEL
Cascada (W13)

| | | | | |
|----------|-----|---------|---|--------|
| 2.0 CDTI | 121 | 03/13 → | D | A20DTH |
| | 143 | 03/13 → | D | A20DTR |

Combo C

| | | | | |
|----------|----|---------|---|--------|
| 1.6 CDTI | 66 | 02/12 → | D | A16FDL |
| | 74 | 02/12 → | D | A16FDH |
| | 77 | 02/12 → | D | A16FDH |
| 2.0 CDTI | 99 | 02/12 → | D | A20FD |

Insignia, Station Wagon

| | | | | |
|----------------------|-----|---------|---|--------|
| 2.0 Biturbo CDTI | 140 | 07/08 → | D | A20DTR |
| | 143 | 01/12 → | D | A20DTR |
| 2.0 Biturbo CDTI 4x4 | 140 | 05/09 → | D | A20DTR |
| | 143 | 01/12 → | D | A20DTR |

| | | | | |
|--------------|-----|---------|---|----------------|
| 2.0 CDTI | 81 | 07/08 → | D | A20DTC, A20DTL |
| | 88 | 03/12 → | D | A20DTE |
| | 96 | 07/08 → | D | A20DT, A20DTJ |
| | 103 | 07/13 → | D | A20DTE |
| | 118 | 07/08 → | D | A20DTH |
| | 120 | 07/13 → | D | A20DTH |
| | 125 | 11/14 → | D | B20DTH |
| 2.0 CDTI 4x4 | 118 | 06/10 → | D | A20DTH |
| | 120 | 07/13 → | D | A20DTH |

Signum

| | | | | |
|----------|-----|---------|---|--------|
| 1.9 CDTI | 110 | 04/04 → | D | Z19DTH |
|----------|-----|---------|---|--------|

Vectra C, Station Wagon

| | | | | |
|----------|-----|---------|---|--------|
| 1.9 CDTI | 110 | 04/04 → | D | Z19DTH |
|----------|-----|---------|---|--------|

Zafira B, Van

| | | | | |
|----------|-----|---------|---|--------|
| 1.9 CDTI | 110 | 07/05 → | D | Z19DTH |
|----------|-----|---------|---|--------|

Zafira C

| | | | | |
|------------------|-----|---------|---|-----------------------|
| 2.0 BiTurbo CDTI | 143 | 01/13 → | D | A20DTR |
| 2.0 CDTI | 81 | 10/11 → | D | A20DTL |
| | 96 | 10/11 → | D | A20DT, Y20DTJ, Z20DTJ |
| | 118 | 10/11 → | D | A20DTH |
| | 121 | 10/11 → | D | A20DTH |

SAAB
9-3 II, Station Wagon, Cabrio

| | | | | |
|----------|-----|---------|---|----------------|
| 1.9 TiD | 110 | 09/04 → | D | Z19DTH |
| 1.9 TTiD | 132 | 12/07 → | D | A19DTR, Z19DTR |
| | 132 | 12/07 → | D | Z19DTR |

81872
350981872000

SAAB
9-3 X

| | | | | |
|----------|-----|---------|---|----------------|
| 1.9 TTiD | 132 | 02/09 → | D | A19DTR, Z19DTR |
|----------|-----|---------|---|----------------|

9-5 I, Station Wagon

| | | | | |
|---------|-----|---------------|---|--------|
| 1.9 TiD | 110 | 01/06 → 12/09 | D | Z19DTH |
|---------|-----|---------------|---|--------|

9-5 II, Station Wagon

| | | | | |
|--------------|-----|---------------|---|--------|
| 2.0 TiD | 118 | 05/10 → 01/12 | D | A20DTH |
| 2.0 TTiD | 140 | 05/10 → 01/12 | D | A20DTR |
| 2.0 TTiD XWD | 140 | 05/10 → 01/12 | D | A20DTR |

SUZUKI
SX4

| | | | | |
|--------------|----|---------|---|-------|
| 2.0 DDiS | 99 | 07/09 → | D | D20AA |
| 2.0 DDiS 4x4 | 99 | 07/09 → | D | D20AA |

VAUXHALL
ASTRA

| | | | | |
|----------|-----|---------|---|--------|
| 2.0 CDTI | 118 | 12/09 → | D | A20DTH |
|----------|-----|---------|---|--------|

81999
350981999000

FLANGIA

| | |
|-------------------------|---------|
| Numero Fori Flangia | 3 |
| Dimensione Fori Flangia | M8x1.25 |
| Posizione Attacco | 85 |
| Diametro Mozzo | Ø23 |
| Diametro Centraggio | Ø26 |
| Diametro Girante | Ø65 |
| N° Alette Girante | 7 |
| Posizione Girante | 49.3 |

LADA
Niva I

| | | | | |
|------------|----|---------------|---|---------|
| 1600 | 54 | 01/87 → 03/95 | B | BA32121 |
| 1700 i | 59 | 06/96 → | B | BA32124 |
| 1700 i 4x4 | 60 | 10/00 → | B | BA32124 |

Nova

| | | | | |
|----------------|----|---------------|---|---------|
| 1300 | 48 | 09/85 → 12/91 | B | BA32105 |
| | 49 | 08/94 → | B | BA32103 |
| 1500 | 55 | 09/85 → 02/93 | B | BA32103 |
| | 56 | 01/88 → 10/01 | B | BA32106 |
| 1700 | 62 | 08/94 → | B | B032123 |
| 1700 i Classic | 62 | 06/96 → | B | B032123 |

Toscana

| | | | | |
|------|----|---------------|---|---------|
| 1500 | 55 | 09/83 → 02/93 | B | BA32103 |
|------|----|---------------|---|---------|

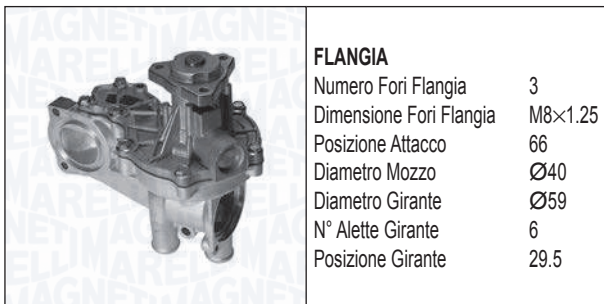
82001
350982001000

FLANGIA

| | |
|-------------------------|---------|
| Numero Fori Flangia | 3 |
| Dimensione Fori Flangia | M8x1.25 |
| Posizione Attacco | 66 |
| Diametro Mozzo | Ø40 |
| Diametro Girante | Ø59 |
| N° Alette Girante | 6 |
| Posizione Girante | 29.5 |

KW

VOLKSWAGEN
Transporter III

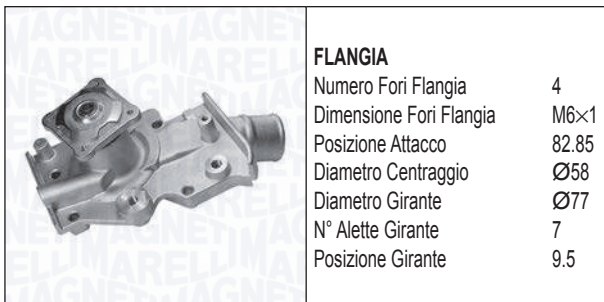
| | | | | | |
|------------------|----|---------------|---|----|-------------------------|
| 1.6 TD | 51 | 08/84 → 07/92 | D | JX | (+)COP, → M: 012.052 |
| 1.6 TD Syncro | 51 | 03/86 → 07/92 | D | JX | (+)COP, → M: 012.052 |

82004
350982004000

FLANGIA

| | |
|-------------------------|-------|
| Numero Fori Flangia | 4 |
| Dimensione Fori Flangia | M6x1 |
| Posizione Attacco | 82.85 |
| Diametro Centraggio | Ø58 |
| Diametro Girante | Ø77 |
| N° Alette Girante | 7 |
| Posizione Girante | 9.5 |

KW

FORD
Mondeo I, Station Wagon

| | | | | | |
|------------------|-----|---------------|---|-----|-----------|
| 1.6 i 16V | 65 | 07/94 → 08/96 | B | L1J | |
| | 66 | 02/93 → 08/96 | B | L1F | |
| 1.8 4x4 | 85 | 02/93 → 08/96 | B | RKA | |
| | 82 | 07/94 → 08/96 | B | RKB | |
| 1.8 i 16V | 85 | 02/93 → 08/96 | B | RKA | |
| | 85 | 02/93 → 08/96 | B | RKA | |
| 2.0 i 16V | 97 | 12/94 → 08/96 | B | NGA | |
| | 100 | 02/93 → 08/96 | B | NGA | 02-1993 → |
| | 100 | 04/93 → 08/96 | B | NGA | |
| 2.0 i 16V 4x4 | 97 | 12/94 → 08/96 | B | NGA | |
| | 100 | 04/93 → 08/96 | B | NGA | |

Mondeo II, Station Wagon

| | | | | | |
|-----------|----|---------------|---|------------------|--|
| 1.6 i | 66 | 08/96 → 09/00 | B | L1J | |
| 1.6 i 16V | 70 | 05/98 → 09/00 | B | L1L, L1N, L1Q | |

82004
350982004000

KW

OPEL
Mondeo II, Station Wagon

| | | | | | |
|-------|----|---------------|---|-------------------------------|-----------|
| 1.8 i | 85 | 08/96 → 09/00 | B | RKB, RKF, RKH, RKJ, RKK | → 04-1998 |
| | 85 | 08/96 → 09/00 | B | RKB, RKF, RKH, RKJ, RKK | |
| 2.0 i | 96 | 08/96 → 09/00 | B | NGA, NGB, NGC, NGD | |

82005
350982005000

PULEGGIA

| | |
|----------------------------|-------|
| Diametro Puleggia | Ø57.2 |
| Numero Denti/Gole Puleggia | 23 |
| Altezza Puleggia | 19.5 |
| Posizione Attacco | 61.3 |
| Diametro Girante | Ø55 |
| N° Alette Girante | 9 |
| Posizione Girante | 35 |

KW

OPEL
Astra F Classic

| | | | | | |
|-----------|----|---------------|---|--------|--|
| 1.6 i 16V | 74 | 01/98 → 08/02 | B | X16XEL | |
|-----------|----|---------------|---|--------|--|

Astra F, Station Wagon, Cabrio, Van

| | | | | | |
|-----------|----|---------------|---|--------|--|
| 1.4 i 16V | 66 | 02/96 → 09/98 | B | X14XE | |
| | 74 | 08/94 → 09/98 | B | X16XEL | |

Astra G, Station Wagon, Coupé, Cabrio, Van

| | | | | | |
|---------|----|---------------|---|-----------------------------|---|
| 1.4 16V | 66 | 02/98 → 01/05 | B | X14XE, Z14XE | → 08-2000, → M: 20U75998, → M: 02MV7224, → M: 20U75998 |
| | 66 | 09/98 → 01/05 | B | X14XE, Z14XE | |
| 1.6 16V | 74 | 02/98 → 01/05 | B | C16SEL, X16XEL, Z16XE | → M: 02MV7224, → M: 20U75998 |
| | 74 | 02/98 → 07/04 | B | X16XEL, Z16XE | → M: 02MV7224, → M: 20U75998 |
| | 74 | 09/98 → 01/05 | B | X16XEL, Z16XE | |
| | 74 | 03/01 → 10/05 | B | Z16XE | → M: 02MV7224, → M: 20U75998 |
| | 74 | 03/00 → 05/05 | B | Z16XE | |
| 1.6 LPG | 74 | 06/02 → 01/05 | | Z16XE | |

82005
350982005000

KW

OPEL
Combo A

1.4 16V 66 08/99 → 10/01 B X14XE

Corsa B, Station Wagon, Van

1.4 i 16V 63 08/97 → 09/00 B C14SEL

1.4 i 16V 66 09/94 → 09/00 B X14XE

1.4 i 16V 67 09/94 → 09/00 B X14XE

1.6 GSI 16V 80 03/93 → 09/00 B C16XE

1.6 i 16V 74 08/97 → 09/00 B C16SEL

1.6 i 16V 78 09/94 → 09/00 B X16XE

Tigra I

1.4 16V 63 08/97 → 12/00 B X14XE

1.4 16V 66 07/94 → 12/00 B X14XE

1.6 16V 74 08/97 → 08/98 B C16SEL

1.6 16V 78 07/94 → 08/98 B X16XE

Vectra B, Station Wagon

1.6 16V 74 10/95 → 04/02 B X16XEL, Y16XE, Z16XE → M: 20U75998, → M: 02MV7224

1.6 i 16V 74 10/95 → 07/02 B X16XEL, Y16XE, Z16XE → M: 02MZ5253

1.6 i 16V 74 11/96 → 07/02 B X16XEL, Y16XE, Z16XE → M: 20U75998, → M: 02MZ5253

Zafira A

1.6 16V 74 04/99 → 06/05 B X16XEL, Z16XE → 06-2000, → M: 02MV7224, → M: 20U75998, → M: 02MV7224

82010
350982010000

FLANGIA

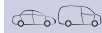
 Posizione Attacco 56.5
 Diametro Centraggio Ø28
 Diametro Girante Ø60
 N° Alette Girante 6
 Posizione Girante 10

KW

BMW
1 I (E81, E87), Coupé (E82), Cabrio (E88)

116 i 85 11/03 → 09/12 B N43B16A, N45B16A

116 i 85 03/07 → 09/12 B N45B16A

116 i 90 03/07 → 09/12 B N43B16A, N45B16A

118 i 95 07/04 → 09/12 B N43B20A, N46B20B

118 i 100 07/04 → 09/12 B N43B20A, N46B20B M: N46NB20B

118 i 100 09/08 → 12/13 B N46B20B

118 i 105 03/08 → 12/13 B N43B20A

118 i 105 09/06 → 09/12 B N43B20A, N46B20B

120 i 110 11/03 → 09/12 B N46B20B, N46B20BD, N46B20C, N46B20CC, N46B20CD

120 i 115 11/03 → 09/12 B N46B20A, N46B20B, N46B20BD, N46B20C, N46B20CC, N46B20CD

120 i 115 09/09 → 10/13 B N46B20B

120 i 115 09/06 → 09/12 B N46B20B, N46B20C

120 i 115 03/08 → 12/13 B N46B20B, N46B20C, N46B20E

120 i 125 03/08 → 12/13 B N43B20A

125 02/07 → 09/12 B N43B20A, N46B20B, N46B20BD, N46B20C, N46B20CC, N46B20CD

125 09/06 → 09/12 B N43B20A, N46B20B, N46B20C

82010 350982010000

BMW
3 IV (E46), Touring, Cabrio, Coupé, Compact

| | | | | | |
|--------|-----|---------------|---|--------------------------------|-----------|
| 316 Ci | 77 | 04/00 → 07/06 | B | M43B16 (164E3) | 06-2001 → |
| | 85 | 06/02 → 07/06 | B | N45B16A | |
| 316 i | 77 | 04/00 → 02/05 | B | M43B16, M43B16 (164E3) | 06-2002 → |
| | 85 | 06/02 → 02/05 | B | N40B16A, N45B16A | |
| | 85 | 06/02 → 02/05 | B | N45B16, N45B16A | |
| | 85 | 02/02 → 02/05 | B | N42B18A, N46B18, N46B18A | |
| 316 ti | 85 | 06/02 → 02/05 | B | N40B16A, N45B16A | |
| | 85 | 06/01 → 02/05 | B | N42B18A, N46B18A | |
| 318 Ci | 105 | 09/01 → 12/07 | B | N42B20A, N46B20A | |
| | 110 | 03/05 → 07/06 | B | N46B20A | |
| | 110 | 02/05 → 12/07 | B | N46B20A, N46B20B | |
| 318 i | 105 | 09/01 → 02/05 | B | N42B20A, N46B20, N46B20A | |
| 318 ti | 105 | 09/01 → 02/05 | B | N42B20A, N46B20A | |

3 V (E90), Touring (E91), Cabrio (E93), Coupé (E92)

| | | | | | |
|-------|-----|---------------|---|----------------------------------|--|
| 316 i | 85 | 02/06 → 12/11 | B | N45B16, N45B16A, N45B16TU2 | |
| 318 i | 95 | 09/05 → 03/07 | B | N46B20, N46B20B | |
| | 100 | 06/07 → 12/11 | B | N46B20B, N46B20E | |

82010 350982010000

BMW
3 V (E90), Touring (E91), Cabrio (E93), Coupé (E92)

| | | | | | | |
|-------|--------|---------------|---------------|---|---------|--|
| 320 i | 110 | 03/07 → 08/07 | B | N46B20, N46B20A | | |
| | 110 | 01/05 → 03/07 | B | N46B20, N46B20A, N46B20B, N46B20C | | |
| | 110 | 09/05 → 06/12 | B | N46B20, N46B20A, N46B20C | | |
| | 110 | 11/06 → 06/07 | B | N46B20A | | |
| | 115 | 03/07 → 12/13 | B | N46B20B | | |
| | 115 | 03/07 → 12/11 | B | N46B20B, N46B20C, N46B20CC, N46B20CD, N46B20E | | |
| | 125 | 03/07 → 12/13 | B | N43B20A | | |
| | 320 si | 127 | 05/06 → 12/11 | B | N45B20A | |

5 V (E60), Touring (E61)

| | | | | | |
|-------|-----|---------------|---|---------|--|
| 520 i | 115 | 04/06 → 12/09 | B | N46B20B | |
| | 125 | 09/07 → 03/10 | B | N43B20A | |

X1 I (E84)

| | | | | | |
|-------------|-----|---------------|---|---------|--|
| sDrive 18 i | 100 | 03/09 → 06/15 | B | N46B20B | |
| | 110 | 01/10 → 06/15 | B | N46B20B | |

X3 I (E83)

| | | | | | |
|-------------|-----|---------------|---|--------------------|--|
| 2.0 i | 110 | 07/05 → 08/08 | B | N46B20, N46B20B | |
| xDrive 20 i | 110 | 09/08 → 08/11 | B | N46B20B | |

Z4 I (E85), Coupé (E86)

| | | | | | |
|-------|-----|---------------|---|--------------------------------|--|
| 2.0 i | 110 | 03/05 → 02/09 | B | N46B20, N46B20A, N46B20B | |
|-------|-----|---------------|---|--------------------------------|--|

82011
350982011000

FLANGIA

| | |
|-------------------------|---------|
| Numero Fori Flangia | 3 |
| Dimensione Fori Flangia | M8x1.25 |
| Posizione Attacco | 55 |
| Diametro Mozzo | Ø30 |
| Diametro Girante | Ø49 |
| N° Alette Girante | 8 |
| Posizione Girante | 15.5 |

OPEL
Agila A

| | | | | |
|------------------|----|---------------|---|--------|
| 1.0 | 44 | 08/03 → 12/07 | B | Z10XEP |
| 1.2 16V Twinport | 59 | 07/04 → 12/07 | B | Z12XEP |

Astra G, Station Wagon, Coupé, Cabrio, Van

| | | | | |
|-----|----|---------------|---|--------|
| 1.4 | 66 | 09/07 → 12/09 | B | Z14XEP |
|-----|----|---------------|---|--------|

Astra H, Station Wagon, GTC, Twin Top, Van

| | | | | |
|---------|----|---------------|---|--------|
| 1.2 | 59 | 08/05 → | B | Z12XEP |
| 1.4 | 55 | 04/04 → 10/04 | B | Z14XEL |
| | 59 | 04/04 → 10/04 | B | Z14XEL |
| | 66 | 03/04 → | B | Z14XEP |
| 1.4 LPG | 66 | 08/09 → | | Z14XEP |

Combo B

| | | | | |
|---------|----|---------|---|--------|
| 1.4 16V | 66 | 08/05 → | B | Z14XEP |
|---------|----|---------|---|--------|

Corsa C, Van

| | | | | |
|--------------|----|---------------|---|--------|
| 1.0 | 44 | 06/03 → 12/09 | B | Z10XEP |
| 1.2 | 59 | 07/05 → | B | Z12XEP |
| 1.2 Twinport | 59 | 07/04 → 12/09 | B | Z12XEP |
| 1.4 | 66 | 08/03 → | B | Z14XEP |
| 1.4 Twinport | 66 | 06/03 → 12/09 | B | Z14XEP |

Corsa D, Van

| | | | | |
|---------|----|---------|---|--------|
| 1.0 | 44 | 07/06 → | B | A10XEP |
| | 44 | 07/06 → | B | Z10XEP |
| | 48 | 01/10 → | B | A10XEP |
| 1.2 | 59 | 07/06 → | B | Z12XEP |
| 1.2 LPG | 55 | 09/09 → | | Z12XEP |
| | 59 | 09/09 → | | Z12XEP |
| 1.4 | 66 | 07/06 → | B | Z14XEP |
| 1.4 LPG | 66 | 07/06 → | | Z14XEP |

Meriva A

| | | | | |
|----------------------|----|---------------|---|--------|
| 1.4 16V Twinport | 66 | 07/04 → 05/10 | B | Z14XEP |
| 1.4 16V Twinport LPG | 66 | 07/04 → 05/10 | | Z14XEP |

Tigra II Twin Top

| | | | | |
|-----|----|---------|---|--------|
| 1.4 | 66 | 06/04 → | B | Z14XEP |
|-----|----|---------|---|--------|

82011
350982011000

VAUXHALL
ASTRA

| | | | | |
|-----|----|---------------|---|--------|
| 1.4 | 66 | 01/04 → 05/09 | B | Z14XEP |
|-----|----|---------------|---|--------|

82012
350982012000

PULEGGIA

| | |
|-------------------|------|
| Diametro Puleggia | Ø90 |
| Altezza Puleggia | 27 |
| Posizione Attacco | 57 |
| Diametro Girante | Ø60 |
| N° Alette Girante | 6 |
| Posizione Girante | 25.5 |

TOYOTA
Auris I, Van

| | | | | |
|----------|----|---------------|---|--------|
| 1.4 VVTi | 71 | 03/07 → 09/12 | B | 4ZZ-FE |
|----------|----|---------------|---|--------|

Avensis I, Liftback, Station Wagon

| | | | | |
|-----------|----|---------------|---|--------|
| 1.6 VVT-i | 81 | 10/00 → 02/03 | B | 3ZZ-FE |
| 1.8 VVT-i | 95 | 10/00 → 02/03 | B | 1ZZ-FE |

Avensis II, Liftback, Station Wagon

| | | | | |
|-----------|----|---------------|---|--------|
| 1.6 VVT-i | 81 | 04/03 → 11/08 | B | 3ZZ-FE |
| 1.8 | 95 | 04/03 → 11/08 | B | 1ZZ-FE |

Celica VII

| | | | | |
|--------------|-----|---------------|---|--------|
| 1.8 16V VT-i | 105 | 08/99 → 07/05 | B | 1ZZ-FE |
|--------------|-----|---------------|---|--------|

Corolla Verso

| | | | | |
|-----|----|---------------|---|--------|
| 1.6 | 81 | 04/04 → 03/09 | B | 3ZZ-FE |
| 1.8 | 95 | 04/04 → 03/09 | B | 1ZZ-FE |

Corolla VI, Liftback, Station Wagon, Compact

| | | | | | |
|---------|----|---------------|---|--------|-----------|
| 1.4 | 71 | 02/00 → 01/02 | B | 4ZZ-FE | 11-2001 → |
| | 71 | 02/00 → 01/02 | B | 4ZZ-FE | |
| 1.4 16V | 71 | 02/00 → 11/01 | B | 4ZZ-FE | 11-2001 → |
| 1.6 | 81 | 02/00 → 01/02 | B | 3ZZ-FE | |
| 1.6 16V | 81 | 02/00 → 11/01 | B | 3ZZ-FE | |

Corolla VII, Liftback, Station Wagon, Verso

| | | | | |
|-----------|-----|---------------|---|--------|
| 1.4 VVT-i | 71 | 01/02 → 12/06 | B | 4ZZ-FE |
| 1.6 VVT-i | 81 | 01/02 → 12/06 | B | 3ZZ-FE |
| | 92 | 05/02 → 05/04 | B | 1ZZ-FE |
| | 96 | 03/01 → 07/05 | B | 1ZZ-FE |
| 1.8 | 100 | 06/04 → 02/07 | B | 1ZZ-FE |
| | 100 | 06/04 → 02/07 | B | 1ZZ-FE |
| 1.8 4WD | 100 | 12/01 → 02/07 | B | 1ZZ-FE |
| 1.8 4x4 | 94 | 06/07 → 07/07 | B | 1ZZ-FE |
| 1.8 VVTi | 100 | 06/04 → 02/07 | B | 1ZZ-FE |
| 1.8 VVT-i | 99 | 01/02 → 05/04 | B | 1ZZ-FE |

82012 350982012000

TOYOTA
Corolla VIII, Hatchback, Station Wagon

1.4 VVT-i 71 01/07 → B 4ZZ-FE

MR 2 III

1.8 16V VVT-i 103 10/99 → 06/07 B 1ZZ-FE

RAV 4 II

1.8 VVTi 92 08/00 → 11/05 B 1ZZ-FE

82013 350982013000

PULEGGIA

| | |
|----------------------------|-------|
| Diametro Puleggia | Ø56 |
| Numero Denti/Gole Puleggia | 19 |
| Altezza Puleggia | 33.5 |
| Posizione Attacco | 52 |
| Diametro Girante | Ø59.5 |
| N° Alette Girante | 8 |
| Posizione Girante | 48 |

SEAT
Cordoba III, Vario

1.9 SDI 47 09/02 → 11/09 D ASY

SKODA
Fabia I, Station Wagon, Van

1.9 SDI 47 12/99 → 03/08 D ASY T→: 6Y3X628013

VOLKSWAGEN
Polo V (9N)

| | | | | | |
|---------|----|---------------|---|-----|--------------|
| 1.9 SDI | 47 | 10/01 → 11/09 | D | ASY | T→: 9N210001 |
| | 47 | 09/02 → | D | ASY | |

82014 350982014000

FLANGIA

| | |
|-------------------------|------|
| Numero Fori Flangia | 3 |
| Dimensione Fori Flangia | M6×1 |
| Posizione Attacco | 61 |
| Diametro Girante | Ø56 |
| N° Alette Girante | 6 |
| Posizione Girante | 13.3 |

NISSAN
Micra III (K12), C+C

| | | | | |
|---------|----|---------------|---|----------------|
| 1.0 16V | 48 | 01/03 → 06/10 | B | CG10DE |
| 1.2 16V | 48 | 01/03 → 06/10 | B | CG12DE, CR12DE |
| | 59 | 01/03 → 06/10 | B | CG12DE, CR12DE |
| 1.4 16V | 65 | 08/05 → | B | CR14DE |
| 160 SR | 81 | 05/05 → 06/10 | B | HR16DE |

Note I

| | | | | |
|-----|----|---------|---|--------|
| 1.4 | 65 | 03/06 → | B | CR14DE |
|-----|----|---------|---|--------|

82015 350982015000

FLANGIA

| | |
|-------------------------|---------|
| Numero Fori Flangia | 3 |
| Dimensione Fori Flangia | M8×1.25 |
| Posizione Attacco | 55.5 |
| Diametro Mozzo | Ø30 |
| Diametro Girante | Ø66 |
| N° Alette Girante | 7 |
| Posizione Girante | 16.5 |

AUDI
A4 II, Avant, Cabriolet

| | | | | |
|-----------------|-----|---------------|---|-----|
| 2.7 TDI | 132 | 06/06 → 03/09 | D | BPP |
| 3.0 TDI quattro | 150 | 01/06 → 03/09 | D | BKN |
| | 171 | 01/06 → 03/09 | D | ASB |
| 3.2 FSI | 188 | 01/06 → 03/09 | B | AUK |
| 3.2 FSI quattro | 188 | 01/06 → 03/09 | B | AUK |

A4 III, Avant

| | | | | |
|-----------------|-----|---------------|---|-----|
| 2.7 TDI | 120 | 11/05 → 06/08 | D | BSG |
| | 132 | 01/06 → 06/08 | D | BPP |
| 3.0 TDI quattro | 150 | 11/04 → 06/08 | D | BKN |
| | 171 | 01/06 → 06/08 | D | ASB |
| 3.2 FSI | 188 | 01/05 → 06/08 | B | AUK |

82015
350982015000

KW

AUDI
A4 III, Avant

| | | | | |
|-----------------|-----|---------------|---|----------|
| 3.2 FSI quattro | 188 | 01/05 → 06/08 | B | AUK |
| | 188 | 01/05 → 06/08 | B | AUK, BKH |

A4 IV, Avant, Allroad

| | | | | |
|-----------------|-----|---------------|---------|------------------------------------|
| 2.7 TDI | 120 | 11/07 → 03/12 | D | CAMB, CGKB |
| | 140 | 11/07 → 03/12 | D | CAMA, CGKA |
| 3.0 TDI quattro | 155 | 06/08 → 05/10 | D | CCWB |
| | 176 | 11/07 → 03/12 | D | CAPA, CCLA, CCWA |
| | | 176 | 04/09 → | D |
| S4 quattro | 245 | 11/08 → 12/15 | B | CAKA, CCBA, CGWC, CGXC, CREC, CTUB |

A5, Sportback, Cabriolet

| | | | | |
|-----------------|-----|---------|---------|--|
| 2.7 TDI | 120 | 09/07 → | D | CAMB, CGKB |
| | 120 | 05/09 → | D | CGKB |
| | 140 | 06/07 → | D | CAMA, CGKA |
| | 140 | 03/09 → | D | CGKA |
| 3.0 TDI quattro | 155 | 03/08 → | D | CCWB |
| | 176 | 06/07 → | D | CAPA, CCWA |
| | | 176 | 03/09 → | D |
| S5 quattro | 245 | 06/09 → | B | CAKA, CCBA, CGWC, CGXC, CREC, CTDA, CTUB |
| | 245 | 10/11 → | B | CAKA, CGWC, CGXC, CREC, CTDA, CTUB |

A6 III, Avant, Allroad

| | | | | |
|------------------|-----|---------------|---------------|----------------|
| 2.4 | 130 | 05/04 → 10/08 | B | BDW |
| 2.4 quattro | 130 | 01/05 → 10/08 | B | BDW |
| 2.7 TDI | 120 | 11/04 → 03/11 | D | BSG, CANB |
| | 132 | 11/04 → 10/08 | D | BPP |
| 2.7 TDI quattro | | 140 | 10/08 → 03/11 | D |
| | 120 | 06/05 → 03/11 | D | BSG, CAND |
| | 132 | 11/04 → 10/08 | D | BPP |
| | 140 | 10/08 → 03/11 | D | CANC |
| 3.0 TDI | 171 | 06/06 → 03/11 | D | ASB |
| 3.0 TDI quattro | 155 | 05/04 → 03/11 | D | BNG, CDYB |
| | 165 | 05/04 → 05/06 | D | BMK |
| | 171 | 06/06 → 10/08 | D | ASB |
| | | 176 | 10/08 → 03/11 | D |
| 3.0 TFSI quattro | 213 | 10/08 → 03/11 | B | CAJA → 02-2009 |
| | 213 | 10/08 → 08/11 | B | CAJA |
| | 220 | 10/08 → 03/11 | B | CCAA |

82015
350982015000

KW

AUDI
A6 III, Avant, Allroad

| | | | | |
|-----------------|-----|---------------|---|----------|
| 3.2 FSI | 188 | 03/05 → 10/08 | B | AUK |
| | 188 | 05/04 → 05/09 | B | AUK, BKH |
| | 195 | 05/09 → 03/11 | B | CALA |
| 3.2 FSI quattro | 183 | 09/06 → 10/08 | B | BYU |
| | 188 | 05/06 → 10/08 | B | AUK |
| | 188 | 05/04 → 10/08 | B | AUK, BKH |

A8 II

| | | | | |
|-----------------|-----|---------------|---|-----|
| 3.0 TDI quattro | 155 | 11/03 → 07/10 | D | BNG |
| | 171 | 08/03 → 07/10 | D | ASB |
| 3.2 FSI | 191 | 06/05 → 07/10 | B | BPK |
| 3.2 FSI quattro | 191 | 06/05 → 07/10 | B | BPK |

Q5

| | | | | |
|-----------------|-----|---------|---|------------|
| 3.0 TDI quattro | 155 | 11/08 → | D | CCWB |
| | 176 | 11/08 → | D | CCWA, CPNB |

Q7 I

| | | | | |
|----------|-----|---------------|---------------|-----------------------|
| 3.0 TDI | 155 | 03/06 → 05/10 | D | BUN, CASB |
| | 165 | 06/09 → 05/12 | D | CATA |
| | 171 | 03/06 → 05/08 | D | BUG |
| | | 176 | 11/07 → 08/15 | D |
| 3.0 TFSI | 200 | 05/10 → 08/15 | B | CJTC, CJWC |
| | 206 | 05/11 → 08/15 | B | CJWE, CTWB |
| | 245 | 05/10 → 08/15 | B | CJTB, CJWB, CNA, CTWA |

VOLKSWAGEN
Phaeton

| | | | | |
|--------------------|-----|---------|---|------------|
| 3.0 V6 TDI 4motion | 165 | 09/04 → | D | BMK |
| | 171 | 06/07 → | D | CARA |
| | 176 | 11/08 → | D | CARB, CEXA |

Touareg I

| | | | | |
|------------|-----|---------------|---|------------|
| 3.0 TDI | 155 | 04/06 → 05/10 | D | BUN, CASB |
| 3.0 V6 TDI | 165 | 11/04 → 05/10 | D | BKS, CATA |
| | 176 | 11/07 → 05/10 | D | CASA, CASC |

Touareg II

| | | | | |
|------------|-----|---------|---|------------|
| 3.0 V6 TDI | 165 | 06/10 → | D | CATA |
| | 176 | 01/10 → | D | CASA, CNRB |

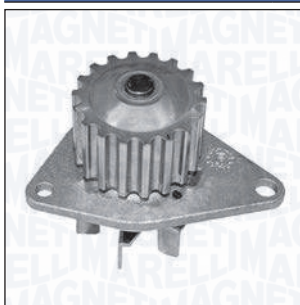
82016
350982016000

PULEGGIA

| | |
|----------------------------|--------|
| Diametro Puleggia | Ø53.25 |
| Numero Denti/Gole Puleggia | 18 |
| Altezza Puleggia | 30 |
| Posizione Attacco | 41.5 |
| Diametro Girante | Ø53.6 |
| N° Alette Girante | 6 |
| Posizione Girante | 40.6 |

KW

CITROËN
C 2, Van

| | | | | |
|---------|----|---------|---|-------------|
| 1.4 16V | 65 | 06/06 → | B | KFU (ET3J4) |
|---------|----|---------|---|-------------|

C 3 I, Pluriel

| | | | | |
|---------|----|---------|---|-------------|
| 1.4 16V | 65 | 12/03 → | B | KFU (ET3J4) |
|---------|----|---------|---|-------------|

C 4 I, Coupé, Picasso, Grand Picasso

| | | | | |
|---------|----|---------------|---|-------------|
| 1.4 16V | 65 | 11/04 → 07/11 | B | KFU (ET3J4) |
|---------|----|---------------|---|-------------|

PEUGEOT
205 II, Van

| | | | | |
|---------|----|---------|---|-------------|
| 1.4 16V | 65 | 10/03 → | B | KFU (ET3J4) |
|---------|----|---------|---|-------------|

206, CC, Van

| | | | | |
|---------|----|---------|---|-------------|
| 1.4 16V | 65 | 10/03 → | B | KFU (ET3J4) |
|---------|----|---------|---|-------------|

207, Station Wagon, CC, Van

| | | | | |
|--|----|---------|---|-------------|
| | 65 | 02/06 → | B | KFU (ET3J4) |
|--|----|---------|---|-------------|

| | | | | |
|---------|----|---------|---|----------------------|
| 1.4 16V | 70 | 06/07 → | B | 8FS (EP3), EP3, EP3C |
|---------|----|---------|---|----------------------|

307, Station Wagon, CC

| | | | | |
|---------|----|---------|---|-------------|
| 1.4 16V | 65 | 11/03 → | B | KFU (ET3J4) |
|---------|----|---------|---|-------------|

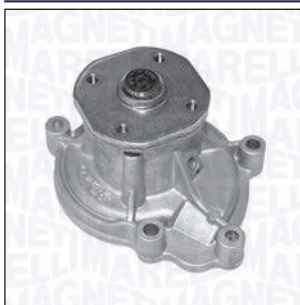
82017
350982017000

FLANGIA

| | |
|-------------------------|------|
| Numero Fori Flangia | 4 |
| Dimensione Fori Flangia | M6×1 |
| Posizione Attacco | 61.5 |
| Diametro Mozzo | Ø22 |
| Diametro Girante | Ø58 |
| N° Alette Girante | 6 |
| Posizione Girante | 14 |

KW

MERCEDES-BENZ
Classe A II (W169)

| | | | | |
|-----------|----|---------------|---|-----------|
| A 150 | 70 | 09/04 → 06/12 | B | M266.920 |
| A 160 | 70 | 04/09 → 06/12 | B | M266.920 |
| A 160 CDI | 60 | 09/04 → 06/12 | D | OM640.942 |
| A 170 | 85 | 09/04 → 06/12 | B | M266.940 |
| A 180 | 85 | 04/09 → 06/12 | B | M266.940 |

82017
350982017000

KW

MERCEDES-BENZ
Classe A II (W169)

| | | | | |
|-----------|-----|---------------|---|-----------|
| A 180 CDI | 80 | 09/04 → 06/12 | D | OM640.940 |
| A 200 | 100 | 09/04 → 06/12 | B | M266.960 |
| A 200 CDI | 100 | 09/04 → 06/12 | D | OM640.941 |
| | 103 | 09/04 → 06/12 | D | OM640.941 |

| | | | | |
|-------------|-----|---------------|---|----------|
| A 200 TURBO | 142 | 09/05 → 06/12 | B | M266.980 |
|-------------|-----|---------------|---|----------|

Classe B I (W245)

| | | | | |
|-------------|-----|---------------|---|-----------|
| B 150 | 70 | 03/05 → 11/11 | B | M266.920 |
| B 160 | 70 | 04/09 → 11/11 | B | M266.920 |
| B 170 | 85 | 03/05 → 11/11 | B | M266.940 |
| B 170 NGT | 85 | 04/08 → 11/11 | | M266.960 |
| B 180 | 85 | 04/09 → 11/11 | B | M266.940 |
| B 180 CDI | 80 | 03/05 → 11/11 | D | OM640.940 |
| B 180 NGT | 85 | 04/08 → 11/11 | | M266.960 |
| B 200 | 100 | 03/05 → 11/11 | B | M266.960 |
| B 200 CDI | 100 | 03/05 → 11/11 | D | OM640.941 |
| | 103 | 03/05 → 11/11 | D | OM640.941 |
| B 200 TURBO | 142 | 03/05 → 11/11 | B | M266.980 |

MITSUBISHI
Colt VI

| | | | | |
|----------|----|---------------|---|-----------|
| 1.5 DI-D | 50 | 08/04 → 06/12 | D | OM639.939 |
| | 70 | 08/04 → 06/12 | D | OM639.939 |

SMART
ForFour I

| | | | | |
|---------|----|---------------|---|-----------|
| 1.5 CDI | 50 | 09/04 → 06/06 | D | OM639.939 |
| | 70 | 09/04 → 06/06 | D | OM639.939 |

82018
350982018000

FLANGIA

| | |
|-------------------------|-------|
| Numero Fori Flangia | 3 |
| Dimensione Fori Flangia | M6×1 |
| Posizione Attacco | 43.7 |
| Diametro Centraggio | Ø23.3 |
| Diametro Girante | Ø49.6 |
| N° Alette Girante | 6 |
| Posizione Girante | 81 |

FORD
Fiesta V, Van

| | | | | | |
|-----|----|---------------|---|------------|--|
| 1.3 | 44 | 11/01 → 06/08 | B | BAJA | |
| | 51 | 11/01 → 06/08 | B | A9JA, A9JB | |

KA I, StreetKa, Van

| | | | | | |
|-------|----|---------------|---|-----------------------------------|-------------------------|
| 1.3 i | 44 | 09/96 → 11/08 | B | BAA, J4D, J4K, J4M, J4N, J4P, J4S | M: DU13BAYA, M: DU13BAA |
| | 44 | 05/02 → 05/05 | B | BAA, J4D, J4K, J4M, J4N, J4P, J4S | |
| | 51 | 08/02 → 11/08 | B | A9A, A9B | |
| 1.6 | 70 | 09/00 → 11/08 | B | CDB, CDC | |
| | 70 | 05/03 → 07/05 | B | CDRA, CDRB | |
| 1.6 i | 71 | 11/05 → 09/08 | B | | |
| | 70 | 07/03 → 11/08 | B | CDB, CDC | |

82020
350982020000

FLANGIA

| | |
|-------------------------|-------|
| Numero Fori Flangia | 4 |
| Dimensione Fori Flangia | M6×1 |
| Posizione Attacco | 92.4 |
| Diametro Centraggio | Ø20 |
| Diametro Girante | Ø59.6 |
| N° Alette Girante | 6 |
| Posizione Girante | 4.9 |

HYUNDAI
Accent I

| | | | | | |
|-----------|----|---------------|---|------|--|
| 1.3 | 40 | 09/95 → 05/98 | B | G4EH | |
| 1.5 i 16V | 73 | 12/95 → 01/00 | B | G4ER | |

82020
350982020000

HYUNDAI
Accent II

| | | | | | |
|-----|----|---------------|---|--------|--|
| 1.5 | 66 | 01/00 → 11/05 | B | G4EB | |
| | 75 | 09/00 → 11/05 | B | G4EC-G | |
| | 75 | 09/99 → 10/02 | B | G4FK | |
| 1.6 | 77 | 12/02 → 11/05 | B | G4ED-G | |

Accent III

| | | | | | |
|---------|----|---------------|---|------|--|
| 1.4 GL | 71 | 11/05 → 11/10 | B | G4EE | |
| 1.6 GLS | 82 | 11/05 → 11/10 | B | G4ED | |

Coupé I

| | | | | | |
|---------|----|---------------|---|--------|--|
| 1.6 16V | 77 | 03/02 → 08/09 | B | G4ED-G | |
| | 79 | 03/02 → 08/09 | B | G4ED-G | |

Elantra I

| | | | | | |
|-----|----|---------------|---|--------|--|
| 1.6 | 66 | 06/00 → 07/06 | B | G4GR | |
| | 77 | 05/03 → 07/06 | B | G4ED-G | |
| | 79 | 06/00 → 07/06 | B | G4ED-G | |
| | 82 | 09/03 → 07/06 | B | G4GA | |

Getz

| | | | | | |
|-------|----|---------------|---|------------|--|
| 1.1 | 49 | 09/05 → 06/09 | B | G4HD, G4HG | |
| 1.4 i | 71 | 08/05 → | B | G4EE | |
| 1.6 | 77 | 09/02 → 09/05 | B | G4ED-G | |
| | 78 | 08/05 → | B | G4ED-G | |

Matrix

| | | | | | |
|-----|----|---------------|---|--------|--|
| 1.6 | 66 | 01/02 → 12/05 | B | G4ED-L | |
| | 76 | 06/01 → 08/10 | B | G4ED-G | |

Tiburon

| | | | | | |
|----------|----|---------------|---|--------|--|
| 1.6 CVVT | 78 | 10/06 → 12/08 | B | G4ED-G | |
|----------|----|---------------|---|--------|--|

KIA
Cerato I

| | | | | | |
|-----|----|---------|---|------|--|
| 1.6 | 90 | 05/06 → | B | G4FC | |
| | 77 | 07/04 → | B | G4ED | |

Pride I, Van

| | | | | | |
|-------------|----|---------|---|------|--|
| 1.6 CVVT LX | 82 | 03/05 → | B | G4ED | |
|-------------|----|---------|---|------|--|

Rio II

| | | | | | |
|----------|----|---------|---|------|--|
| 1.4 16V | 71 | 03/05 → | B | G4EE | |
| 1.6 16V | 82 | 03/05 → | B | G4ED | |
| 1.6 CVVT | 82 | 03/05 → | B | G4ED | |

82021
350982021000

PULEGGIA

| | |
|-------------------|-------|
| Diametro Puleggia | Ø65 |
| Altezza Puleggia | 32.3 |
| Posizione Attacco | 59 |
| Diametro Girante | Ø68.6 |
| N° Alette Girante | 6 |
| Posizione Girante | 18.9 |

KW

HYUNDAI
Coupé I

| | | | | |
|--------|-----|---------------|---|--------|
| 2.7 V6 | 121 | 01/07 → 08/09 | B | G6BA-G |
| | 123 | 03/02 → 08/09 | B | G6BA-G |

Highway Van

| | | | | |
|------------|-----|---------|---|------|
| 2.7 V6 24V | 125 | 03/00 → | B | G6BA |
|------------|-----|---------|---|------|

Santa Fé I

| | | | | |
|------------|-----|---------------|---|--------|
| 2.7 V6 4x4 | 127 | 02/01 → 03/06 | B | G6BA-G |
|------------|-----|---------------|---|--------|

Sonata IV

| | | | | |
|------------|-----|---------------|---|--------|
| 2.5 V6 24V | 118 | 06/98 → 10/01 | B | G6BV-G |
| 2.7 V6 | 127 | 10/01 → 11/04 | B | G6BA-G |
| | 129 | 11/02 → 11/04 | B | G6BA |

Trajet

| | | | | |
|--------|-----|---------------|---|--------|
| 2.7 V6 | 127 | 09/00 → 07/08 | B | G6BA-G |
|--------|-----|---------------|---|--------|

Tucson I

| | | | | |
|------------------------|-----|---------------|---|--------|
| 2.7 Trazione integrale | 129 | 08/04 → 03/10 | B | G6BA-G |
|------------------------|-----|---------------|---|--------|

XG

| | | | | |
|-----|-----|---------------|---|------|
| 250 | 120 | 12/98 → 12/05 | B | G6AV |
|-----|-----|---------------|---|------|

KIA
Magentis I

| | | | | |
|--------|-----|---------|---|------|
| 2.5 V6 | 124 | 05/01 → | B | G6BV |
|--------|-----|---------|---|------|

Sportage II

| | | | | |
|------------|-----|---------|---|------|
| 2.7 V6 4WD | 129 | 09/04 → | B | G6BA |
|------------|-----|---------|---|------|

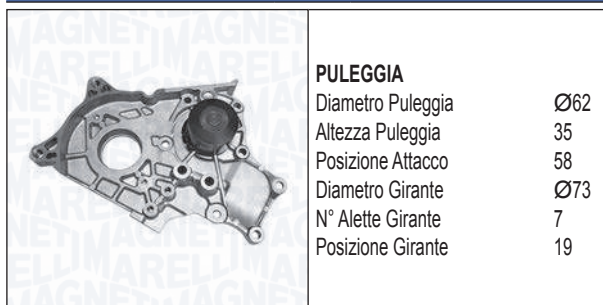
82022
350982022000

PULEGGIA

| | |
|-------------------|-----|
| Diametro Puleggia | Ø62 |
| Altezza Puleggia | 35 |
| Posizione Attacco | 58 |
| Diametro Girante | Ø73 |
| N° Alette Girante | 7 |
| Posizione Girante | 19 |

KW

TOYOTA
Avensis I, Liftback, Station Wagon

| | | | | |
|----------|----|---------------|---|---------|
| 2.0 D | 85 | 09/02 → 02/03 | D | 1CD-FTV |
| 2.0 D-4D | 81 | 10/99 → 02/03 | D | 1CD-FTV |

Avensis II, Liftback, Station Wagon

| | | | | |
|----------|----|---------------|---|-------------------|
| 2.0 D-4D | 85 | 04/03 → 11/08 | D | 1CD-FTV → 06-2004 |
|----------|----|---------------|---|-------------------|

Avensis Verso

| | | | | |
|----------|----|---------------|---|---------|
| 2.0 D-4D | 85 | 08/01 → 08/05 | D | 1CD-FTV |
|----------|----|---------------|---|---------|

Corolla VI, Liftback, Station Wagon, Compact

| | | | | |
|----------|----|---------------|---|---------|
| 2.0 D-4D | 66 | 09/00 → 11/01 | D | 1CD-FTV |
|----------|----|---------------|---|---------|

Corolla VII, Liftback, Station Wagon, Verso

| | | | | |
|----------|----|---------------|---|-------------------|
| 2.0 D-4D | 66 | 01/02 → 02/07 | D | 1CD-FTV → 06-2004 |
| | 66 | 01/02 → 12/06 | D | 1CD-FTV |
| | 85 | 06/04 → 07/07 | D | 1CD-FTV |
| | 81 | 01/02 → 12/06 | D | 1CD-FTV |
| | 85 | 05/03 → 02/07 | D | 1CD-FTV |

Previa II

| | | | | |
|----------|----|---------------|---|---------|
| 2.0 D-4D | 85 | 03/01 → 01/06 | D | 1CD-FTV |
|----------|----|---------------|---|---------|

RAV 4 II

| | | | | |
|--------------|----|---------------|---|---------|
| 2.0 D-4D 4WD | 85 | 09/01 → 11/05 | D | 1CD-FTV |
|--------------|----|---------------|---|---------|

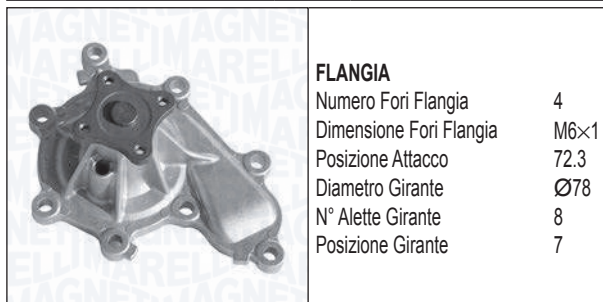
82023
350982023000

FLANGIA

| | |
|-------------------------|------|
| Numero Fori Flangia | 4 |
| Dimensione Fori Flangia | M6×1 |
| Posizione Attacco | 72.3 |
| Diametro Girante | Ø78 |
| N° Alette Girante | 8 |
| Posizione Girante | 7 |

KW

NISSAN
Almera II, Hatchback

| | | | | |
|---------|-----|---------|---|----------|
| 2.2 dCi | 82 | 09/03 → | D | YD22DDT |
| | 100 | 09/03 → | D | YD22DDTi |
| 2.2 Di | 81 | 07/00 → | D | YD22DDT |

82023 350982023000



NISSAN

Almera Tino

| | | | | |
|---------|-----|---------|---|----------|
| 2.2 dCi | 82 | 09/03 → | D | YD22DDT |
| | 100 | 09/03 → | D | YD22DDTi |
| 2.2 Di | 84 | 08/00 → | D | YD22DDTi |

Primera III, Hatchback, Station Wagon

| | | | | |
|---------|-----|---------|---|---------|
| 2.2 dCi | 102 | 04/03 → | D | YD22DDT |
| 2.2 Di | 93 | 03/02 → | D | YD22DDT |

X-Trail I

| | | | | |
|-------------|-----|---------------|---|----------|
| 2.2 DCi | 84 | 10/04 → 01/13 | D | YD22DDTi |
| 2.2 dCi | 100 | 12/03 → 01/13 | D | YD22DDTi |
| 2.2 dCi 4x4 | 100 | 12/03 → 01/13 | D | YD22DDTi |
| 2.2 DCi FWD | 84 | 06/01 → 09/03 | D | YD22DDTi |
| 2.2 Di 4x4 | 84 | 07/01 → 10/05 | D | YD22ETI |

82024 350982024000



| | |
|-------------------|-------|
| PULEGGIA | |
| Diametro Puleggia | Ø63 |
| Altezza Puleggia | 39 |
| Posizione Attacco | 69.4 |
| Diametro Girante | Ø93.8 |
| N° Alette Girante | 7 |
| Posizione Girante | 34.3 |



FIAT

Ducato IV

| | | | | |
|---------|----|---------|---|-----------|
| 2.3 JTD | 81 | 04/02 → | D | F1AE0481C |
|---------|----|---------|---|-----------|

Ducato V

| | | | | |
|------------------------|-----|---------|---|---------------------------------|
| 110 Multijet 2,3 D | 83 | 10/11 → | D | F1AE3481G |
| 120 Multijet 2,3 D | 88 | 07/06 → | D | F1AE0481D |
| | 88 | 07/06 → | D | F1AE0481D, FPT |
| 120 Multijet 2,3 D 4x4 | 88 | 03/10 → | D | F1AE0481D |
| | 93 | 08/06 → | D | F1AE0481T |
| 130 Multijet 2,3 D | 96 | 01/07 → | D | F1AE0481N, F1AE3481D, F1AGL411D |
| | 96 | 01/07 → | D | F1AE3481D, F1AGL411D |
| 150 Multijet 2,3 D | 109 | 06/11 → | D | F1AE3481E |

82024 350982024000



IVECO

Daily III

| | | | | |
|-----------|----|---------------|---|-----------|
| 29 L 12 | 85 | 09/02 → 04/06 | D | F1AE0481B |
| 29 L 12 V | 85 | 09/02 → 07/07 | D | F1AE0481B |

82025 350982025000



| | |
|----------------------------|------|
| PULEGGIA | |
| Diametro Puleggia | Ø57 |
| Numero Denti/Gole Puleggia | 23 |
| Altezza Puleggia | 30 |
| Posizione Attacco | 45.7 |
| Diametro Girante | Ø60 |
| N° Alette Girante | 8 |
| Posizione Girante | 48.5 |



AUDI

A1, Sportback

| | | | | |
|------------------|-----|---------|---|------|
| 2.0 TFSI quattro | 188 | 03/12 → | B | CDLH |
|------------------|-----|---------|---|------|

A3 II, Sportback, Cabriolet

| | | | | |
|------------------|-----|---------------|---|---------------------------------|
| 2.0 TFSI | 147 | 09/04 → 03/13 | B | AXX, BPY, BWA, CAWB, CBFA, CCZA |
| | 147 | 09/04 → 08/12 | B | AXX, BWA, CAWB, CCZA |
| 2.0 TFSI quattro | 147 | 09/04 → 03/13 | B | AXX, BPY, BWA, CCZA |
| | 147 | 09/04 → 08/12 | B | AXX, BWA, CCTA, CCZA |
| S3 quattro | 188 | 02/07 → 08/12 | B | BZC, CDLC |
| | 188 | 07/08 → 03/13 | B | CDLC |
| | 195 | 11/06 → 08/12 | B | BHZ, CDLA |

A4 II, Avant, Cabriolet

| | | | | |
|------------------|-----|---------------|---|----------|
| 2.0 TFSI 16V | 147 | 01/06 → 03/09 | B | BWE, BWT |
| 2.0 TFSI quattro | 147 | 11/05 → 03/09 | B | BWT |

A4 III, Avant

| | | | | |
|----------|-----|---------------|---|--------------------|
| 2.0 TFSI | 125 | 10/06 → 06/08 | B | BPJ, BYK |
| | 147 | 11/04 → 06/08 | B | BGB, BPG, BWE, BWT |
| | 147 | 11/04 → 06/08 | B | BGB, BWE |
| | 162 | 06/05 → 06/08 | B | BUL |

82025 350982025000

AUDI
A4 III, Avant

| | | | | |
|------------------|-----|---------------|---|--------------------|
| 2.0 TFSI quattro | 147 | 11/04 → 06/08 | B | BGB, BPG, BWE, BWT |
| | 147 | 11/04 → 06/08 | B | BGB, BWE, BWT |
| | 162 | 06/05 → 06/08 | B | BUL |

A6 III, Avant, Allroad

| | | | | |
|----------|-----|---------------|---|----------|
| 2.0 TFSI | 125 | 06/05 → 08/11 | B | BPJ |
| | 125 | 06/05 → 03/11 | B | BPJ, BYK |

TT II, Roadster

| | | | | |
|------------------|-----|---------------|---|----------------|
| 2.0 TFSI | 147 | 08/06 → 06/10 | B | BPY, BWA, CCTA |
| 2.0 TFSI quattro | 147 | 06/08 → 06/10 | B | BWA, CCZA |
| | 147 | 06/08 → 06/10 | B | CCZA |
| 2.0 TTS quattro | 195 | 05/08 → 06/14 | B | CDLA, CDMA |
| | 200 | 05/08 → 06/14 | B | CDLB |

SEAT
Altea, Altea XL

| | | | | |
|--------------|-----|---------------|---|-----|
| 2.0 TFSI | 147 | 04/06 → 05/09 | B | BWA |
| 2.0 TFSI 4x4 | 147 | 06/07 → 05/09 | B | BWA |

Leon II

| | | | | |
|----------|-----|---------------|---|-----------|
| 2.0 TFSI | 136 | 09/05 → 05/06 | B | BWA1 |
| | 147 | 05/05 → 03/09 | B | BWA |
| | 177 | 11/06 → 05/11 | B | BWJ, CDLD |

Toledo III

| | | | | |
|----------|-----|---------------|---|-----|
| 2.0 TFSI | 147 | 11/05 → 05/09 | B | BWA |
|----------|-----|---------------|---|-----|

SKODA
Octavia II, Station Wagon

| | | | | |
|--------|-----|---------------|---|-----------|
| 2.0 RS | 147 | 10/05 → 02/13 | B | BWA, CCZA |
|--------|-----|---------------|---|-----------|

VOLKSWAGEN
Eos

| | | | | |
|----------|-----|---------|---|----------------------------------|
| 2.0 TFSI | 147 | 03/06 → | B | BPY, BWA, CAWB, CBFA, CCTA, CCZA |
|----------|-----|---------|---|----------------------------------|

Golf V, Plus, Variant

| | | | | |
|---------|-----|---------------|---|---------------------------------|
| 2.0 | 147 | 06/07 → 07/09 | B | BWA, CAWB, CCTA |
| 2.0 GTI | 147 | 10/04 → 02/09 | B | AXX, BPY, BWA, CAWB, CBFA, CCTA |
| | 169 | 09/06 → 12/08 | B | BYD |

82025 350982025000

VOLKSWAGEN
Golf VI, Variant, Cabrio

| | | | | |
|---------------|-----|---------------|---|------------------|
| 2.0 GTi | 147 | 06/09 → 11/13 | B | CBFA, CCTA, CCZA |
| | 173 | 05/11 → 11/12 | B | CDLG |
| 2.0 R | 195 | 01/13 → | B | CDLA |
| 2.0 R 4motion | 188 | 11/09 → 11/13 | B | CDLC, CRZA |
| | 195 | 11/09 → 05/11 | B | CDLA |
| | 199 | 11/09 → 11/12 | B | CDLF |

Jetta III

| | | | | |
|----------|-----|---------------|---|---------------------------------------|
| 2.0 TFSI | 147 | 10/05 → 10/10 | B | AXX, BPY, BWA, CAWB, CBFA, CCTA, CCZA |
|----------|-----|---------------|---|---------------------------------------|

Passat VI, Variant, CC

| | | | | |
|---------|-----|---------------|---|---------------------------------------|
| 2.0 FSI | 147 | 07/05 → 07/10 | B | AXX, BPY, BWA, CAWB, CBFA, CCTA, CCZA |
| | 147 | 06/08 → 01/12 | B | CAWB, CBFA, CCTA, CCZA |

Polo VI (6R)

| | | | | |
|-----------|-----|---------|---|------|
| 2.0 R WRC | 162 | 08/13 → | B | CDLJ |
|-----------|-----|---------|---|------|

Scirocco III

| | | | | |
|-------|-----|---------|---|------|
| 2.0 R | 188 | 11/09 → | B | CDLC |
| | 195 | 11/09 → | B | CDLA |

82026 350982026000

| | | |
|--|-------------------------|------|
| | FLANGIA | |
| | Numero Fori Flangia | 4 |
| | Dimensione Fori Flangia | M6x1 |
| | Posizione Attacco | 57 |
| | Diametro Mozzo | Ø24 |
| | Diametro Girante | Ø59 |
| | N° Alette Girante | 8 |
| | Posizione Girante | 23.3 |

FIAT
Sedici

| | | | | |
|-------------|----|---------|---|------|
| 1.6 16V | 79 | 06/06 → | B | M16A |
| | 88 | 06/06 → | B | M16A |
| 1.6 16V 4x4 | 79 | 06/06 → | B | M16A |
| | 88 | 06/06 → | B | M16A |

82026
350982026000

KW

SUBARU
Justy III

| | | | | | |
|---------|----|---------|---|------|--|
| 1.3 AWD | 69 | 09/03 → | B | M13A | |
| 1.5 AWD | 73 | 09/03 → | B | M15A | |

SUZUKI
Ignis I

| | | | | | |
|---------|----|---------------|---|------|---------|
| 1.3 | 61 | 10/00 → 09/03 | B | M13A | M: M13A |
| 1.3 4WD | 61 | 10/00 → 09/03 | B | M13A | |

Ignis II

| | | | | | |
|-----------|----|---------|---|------|--|
| 1.3 | 69 | 09/03 → | B | M13A | |
| 1.3 4x4 | 69 | 09/03 → | B | M13A | |
| 1.5 | 73 | 09/03 → | B | M15A | |
| 1.5 4x4 | 73 | 09/03 → | B | M15A | |
| 1.5 Sport | 80 | 12/03 → | B | M15A | |

Jimny

| | | | | | |
|-------------|----|---------------|---|------|----------|
| 1.3 16V | 60 | 02/01 → | B | M13A | |
| 1.3 16V 4WD | 60 | 02/01 → | B | M13A | M: G13BB |
| 1.3 16V 4x4 | 63 | 08/05 → | B | M13A | |
| 1.3 4WD | 62 | 05/14 → | B | M13A | |
| 1.3 4x4 | 65 | 09/00 → 08/02 | B | M13A | |

Liana

| | | | | | |
|---------|----|---------------|---|------|--|
| 1.3 | 66 | 03/02 → | B | M13A | |
| 1.6 | 76 | 07/01 → 12/07 | B | M16A | |
| | 76 | 03/02 → | B | M16A | |
| 1.6 4WD | 76 | 07/01 → 12/07 | B | M16A | |
| | 76 | 03/02 → | B | M16A | |
| | 78 | 04/02 → | B | M16A | |
| 1.6 i | 78 | 04/02 → | B | M16A | |

Swift III

| | | | | | |
|---------|----|---------|---|------|--|
| 1.3 | 68 | 02/05 → | B | M13A | |
| 1.3 4x4 | 66 | 01/06 → | B | M13A | |
| | 68 | 02/05 → | B | M13A | |
| 1.5 | 75 | 02/05 → | B | M15A | |
| 1.5 4x4 | 74 | 02/05 → | B | M15A | |
| 1.6 | 92 | 05/06 → | B | M16A | |

Swift IV

| | | | | | |
|-----|-----|---------|---|------|--|
| 1.6 | 100 | 01/12 → | B | M16A | |
|-----|-----|---------|---|------|--|

SX4

| | | | | | |
|---------|----|---------|---|------|--|
| 1.5 | 73 | 06/06 → | B | M15A | |
| 1.6 | 74 | 06/06 → | B | M16A | |
| | 75 | 10/07 → | B | M16A | |
| | 79 | 10/07 → | B | M16A | |
| 1.6 VVT | 79 | 06/06 → | B | M16A | |
| | 88 | 07/09 → | B | M16A | |

82026
350982026000

KW

SUZUKI
SX4

| | | | | | |
|-------------|----|---------|---|------|--|
| 1.6 VVT 4x4 | 79 | 06/06 → | B | M16A | |
| | 88 | 07/09 → | B | M16A | |

Vitara

| | | | | | |
|-----|----|---------|---|------|--|
| 1.6 | 88 | 02/15 → | B | M16A | |
|-----|----|---------|---|------|--|

Wagon R+ II

| | | | | | |
|---------|----|---------|---|------|--|
| 1.3 | 65 | 08/01 → | B | M13A | |
| | 69 | 09/03 → | B | M13A | |
| 1.3 4WD | 69 | 09/03 → | B | M13A | |

82027
350982027000

FLANGIA

| | |
|-------------------------|---------|
| Numero Fori Flangia | 4 |
| Dimensione Fori Flangia | M8×1.25 |
| Posizione Attacco | 93.3 |
| Diametro Girante | Ø56.1 |
| N° Alette Girante | 6 |
| Posizione Girante | 12.3 |

KW

FORD
B-Max, Van

| | | | | | |
|---------|----|---------|---|------|--|
| 1.4 | 66 | 10/12 → | B | SPJD | |
| 1.4 LPG | 63 | 08/13 → | | RTJC | |
| | 66 | 08/13 → | | RTJC | |
| 1.6 Ti | 77 | 10/12 → | B | IQJA | |

C-Max I

| | | | | | |
|-----|----|---------------|---|------------------------------|--|
| 1.6 | 74 | 02/07 → 09/10 | B | HWDA, HWDB, SHDA, SHDB, SHDC | |
| | 85 | 04/07 → 09/10 | B | HXDA, HXDB, SIDA | |

C-Max II, Van

| | | | | | |
|---------------|-----|---------|---|------------|--|
| 1.6 CNG | 86 | 01/13 → | | MUDA | |
| 1.6 EcoBoost | 110 | 12/10 → | B | JQDA, JQDB | |
| | 134 | 12/10 → | B | JTDA, JTDB | |
| 1.6 Flexifuel | 88 | 02/11 → | | MUDA | |
| 1.6 LPG | 86 | 02/12 → | | MUDA | |
| | 88 | 02/12 → | | MUDA | |
| 1.6 Ti | 63 | 12/10 → | B | XTDA | |
| | 77 | 12/10 → | B | IQDA, IQDB | |
| | 92 | 12/10 → | B | PNDA | |

82027 350982027000

FORD
Ecosport II

| | | | | | |
|------------|----|---------|---|------------|--|
| 1.5 Ti | 82 | 10/13 → | B | UEJB | |
| 1.6 Ti-VCT | 90 | 08/12 → | B | HXJD, IQJB | |

Fiesta V, Van

| | | | | | |
|----------|----|---------------|---|------------|-----------|
| 1.25 16V | 51 | 03/03 → 06/08 | B | M7JA, M7JB | 05-2005 → |
| | 55 | 05/02 → 06/08 | B | FUJA, FUJB | 05-2005 → |
| 1.4 16V | 59 | 11/01 → 06/08 | B | FXJA, FXJB | 05-2005 → |
| 1.6 16V | 74 | 11/01 → 06/08 | B | FYJA, FYJB | 05-2005 → |

Fiesta VI, Van

| | | | | | |
|---------|-----|---------|---|------------------------|--|
| 1.25 | 44 | 06/08 → | B | STJA, STJB | |
| | 44 | 10/12 → | B | STJB | |
| | 60 | 01/09 → | B | SNJA, SNJB | |
| 1.4 | 60 | 06/08 → | B | SNJA, SNJB, SNJC, SNJD | |
| | 71 | 06/08 → | B | SPJA, SPJC | |
| 1.4 LPG | 68 | 01/09 → | | RTJA, RTJB | |
| | 71 | 01/09 → | | RTJA, RTJB | |
| 1.6 ST | 134 | 03/13 → | B | JTJA | |
| 1.6 Ti | 77 | 09/12 → | B | IQJA | |
| | 88 | 06/08 → | B | HXJA, HXJB | |
| | 99 | 12/10 → | B | U5JA | |

Focus C-Max

| | | | | | |
|--------|----|---------------|---|------------|-----------|
| 1.6 | 74 | 10/03 → 03/07 | B | HWDA, HWDB | 05-2005 → |
| 1.6 Ti | 85 | 08/04 → 03/07 | B | HXDA, SIDA | 05-2005 → |

Focus II, Station Wagon, Cabrio

| | | | | | |
|---------|----|---------------|---|------------------------------|-----------|
| 1.4 | 59 | 07/04 → 09/12 | B | ASDA, ASDB | 05-2005 → |
| | 59 | 04/05 → 09/12 | B | ASDA, ASDB | |
| 1.6 | 74 | 07/04 → 09/12 | B | HWDA, HWDB, SHDA, SHDB, SHDC | 05-2005 → |
| | 74 | 10/06 → 07/11 | B | HWDA, HWDB, SHDA, SHDB, SHDC | |
| 1.6 LPG | 85 | 10/09 → 07/11 | | SIDA | |
| 1.6 Ti | 85 | 07/04 → 09/12 | B | HXDA, HXDB | 05-2005 → |
| | 85 | 04/05 → 09/12 | B | HXDA, HXDB | |
| | 85 | 07/04 → 09/12 | B | HXDA, HXDB, SIDA | 05-2005 → |

Focus III, Station Wagon, Van

| | | | | | |
|---------------|-----|---------|---|------------------|--|
| 1.6 EcoBoost | 110 | 07/10 → | B | JQDA, JQDB, YUDA | |
| | 134 | 07/10 → | B | JTDA, JTDB | |
| 1.6 | 88 | 07/10 → | | MUDA | |
| 1.6 Flexifuel | 110 | 07/13 → | | YUDA | |

82027 350982027000

FORD
Focus III, Station Wagon, Van

| | | | | | |
|---------|----|---------|---|------|--|
| 1.6 LPG | 86 | 02/12 → | | MUDA | |
| | 88 | 02/12 → | | MUDA | |
| 1.6 Ti | 63 | 08/11 → | B | XTDA | |
| | 77 | 07/10 → | B | IQDB | |
| | 88 | 02/12 → | B | MUDA | |
| | 92 | 07/10 → | B | PNDA | |

Fusion

| | | | | | |
|---------|----|---------------|---|------------------|-----------|
| 1.25 | 55 | 08/04 → 12/12 | B | FUJA, FUJB | 05-2005 → |
| 1.4 | 59 | 08/02 → 12/12 | B | FXJA, FXJB, FXJC | 05-2005 → |
| 1.4 LPG | 59 | 01/10 → 12/12 | | UTJA | |
| 1.6 | 74 | 08/02 → 11/08 | B | FYJA, FYJB, FYJC | 05-2005 → |

Galaxy II

| | | | | | |
|--------------|-----|---------------|---|------------|--|
| 1.6 EcoBoost | 118 | 11/10 → 06/15 | B | JTWA, JTWB | |
|--------------|-----|---------------|---|------------|--|

Grand C-Max

| | | | | | |
|--------------|-----|---------|---|------------|--|
| 1.6 EcoBoost | 110 | 12/10 → | B | JQDA, JQDB | |
| | 134 | 12/10 → | B | JTDA, JTDB | |
| 1.6 Ti | 77 | 12/10 → | B | IQDA, IQDB | |
| | 92 | 12/10 → | B | PNDA | |

Kuga II, Van

| | | | | | |
|------------------|-----|---------|---|------------|--|
| 1.6 EcoBoost | 110 | 03/13 → | B | JQMA, JQMB | |
| 1.6 EcoBoost 4x4 | 110 | 03/13 → | B | JQMA, JQMB | |
| | 134 | 03/13 → | B | JTMA | |

Mondeo IV, Station Wagon

| | | | | | |
|--------------|-----|---------------|---|------|--|
| 1.6 EcoBoost | 118 | 02/11 → 09/14 | B | JTBA | |
| | 118 | 02/11 → 09/14 | B | JTBB | |
| 1.6 Ti | 81 | 03/07 → 09/14 | B | RHBA | |
| | 88 | 07/10 → 09/14 | B | KGBA | |
| | 92 | 03/07 → 09/14 | B | PNBA | |

S-Max

| | | | | | |
|--------------|-----|---------|---|------------|--|
| 1.6 EcoBoost | 118 | 02/11 → | B | JTWA, JTWB | |
|--------------|-----|---------|---|------------|--|

Tourneo II Connect, Courier, Custom

| | | | | | |
|--------------|-----|---------|---|------|--|
| 1.6 EcoBoost | 110 | 11/13 → | B | JQGA | |
|--------------|-----|---------|---|------|--|

Transit Connect II, Courier

| | | | | | |
|--------------|-----|---------|---|------|--|
| 1.6 EcoBoost | 110 | 11/13 → | B | JQGA | |
|--------------|-----|---------|---|------|--|

82027
350982027000

KW

VOLVO
S 60 II

| | | | | |
|-----|-----|---------|----|---------|
| T3 | 110 | 04/10 → | B | B4164T3 |
| T4 | 132 | 04/10 → | B | B4164T |
| T4F | 132 | 04/11 → | FF | B4164T2 |

S 80 II

| | | | | |
|-----|-----|---------|----|---------|
| T4 | 132 | 10/10 → | B | B4164T |
| T4F | 132 | 05/11 → | FF | B4164T2 |

V 40 II

| | | | | |
|---------|-----|---------|---|---------|
| T2 GTDi | 88 | 03/13 → | B | B4164T4 |
| T3 GTDi | 110 | 03/12 → | B | B4164T3 |
| T4 | 147 | 04/14 → | B | B4164T |
| T4 GTDi | 132 | 03/12 → | B | B4164T |

V 60

| | | | | |
|-----|-----|---------|----|---------|
| T3 | 110 | 09/10 → | B | B4164T3 |
| T4 | 132 | 09/10 → | B | B4164T |
| T4F | 132 | 04/11 → | FF | B4164T2 |

V 70 III

| | | | | |
|---------|-----|---------|----|---------|
| 1.6 T4F | 132 | 01/11 → | FF | B4164T2 |
| T4 | 132 | 10/10 → | B | B4164T |

82028
350982028000

FLANGIA

| | |
|-------------------------|------|
| Numero Fori Flangia | 4 |
| Dimensione Fori Flangia | M6x1 |
| Posizione Attacco | 69.5 |
| Diametro Mozzo | Ø25 |
| Diametro Girante | Ø56 |
| N° Alette Girante | 6 |
| Posizione Girante | 5.5 |

KW

NISSAN
Almera II, Hatchback

| | | | | |
|--------|----|---------|---|-------------------|
| 1.5 | 72 | 10/02 → | B | QG15DE |
| | 66 | 07/00 → | B | QG15DE |
| | 77 | 03/01 → | B | GA15DE, QG15DE |
| 1.5 XL | 77 | 03/01 → | B | QG15DE |
| 1.8 | 84 | 07/00 → | B | QG18DE |
| | 85 | 10/02 → | B | QG18DE |

Almera Tino

| | | | | |
|-----|----|---------|---|--------|
| 1.8 | 84 | 08/00 → | B | QG18DE |
| | 85 | 12/02 → | B | QG18DE |

82028
350982028000

KW

NISSAN
Primera II, Hatchback, Station Wagon

| | | | | |
|-----------|----|---------------|---|--------|
| 1.8 16V | 84 | 08/99 → 12/01 | B | QG18DE |
| 1.6 | 78 | 03/02 → | B | QG16DE |
| 1.6 Visia | 80 | 01/02 → | B | QG16DE |
| 1.8 | 85 | 03/02 → | B | QG18DE |

82029
350982029000

PULEGGIA

| | |
|-------------------|------|
| Diametro Puleggia | Ø66 |
| Altezza Puleggia | 34 |
| Posizione Attacco | 57 |
| Diametro Girante | Ø74 |
| N° Alette Girante | 7 |
| Posizione Girante | 36.5 |

KW

LAND ROVER
Freelander I

| | | | | |
|------------|-----|---------------|---|-------|
| 2.5 V6 4x4 | 130 | 11/00 → 10/06 | B | 25K4F |
|------------|-----|---------------|---|-------|

MG
MG ZS

| | | | | |
|-----|-----|---------------|---|-------|
| 180 | 130 | 07/01 → 04/05 | B | 25K4F |
|-----|-----|---------------|---|-------|

ROVER
45

| | | | | |
|--------|-----|---------------|---|-------|
| 2.0 V6 | 110 | 02/00 → 05/05 | B | 20K4F |
|--------|-----|---------------|---|-------|

75, Station Wagon

| | | | | |
|--------|-----|---------------|---|-------|
| 2.0 V6 | 110 | 02/99 → 05/05 | B | 20K4F |
| | 129 | 02/99 → 10/01 | B | KV6 |
| 2.5 V6 | 130 | 10/01 → 05/05 | B | 25K4F |
| | 130 | 08/01 → 05/05 | B | KV6 |

82030
350982030000

PULEGGIA

| | |
|-------------------|-------|
| Diametro Puleggia | Ø90 |
| Altezza Puleggia | Ø30.9 |
| Posizione Attacco | 79.8 |
| Diametro Girante | Ø74 |
| N° Alette Girante | 6 |
| Posizione Girante | 13.3 |

KW

MERCEDES-BENZ
Classe V

| | | | | |
|-----------|----|---------------|---|-----------|
| V 200 CDI | 75 | 03/99 → 07/03 | D | OM611.980 |
| | 90 | 03/99 → 07/03 | D | OM611.980 |

Vito I (W638)

| | | | | |
|-------------|----|---------------|---|-------------------|
| 108 CDI 2.2 | 60 | 03/99 → 07/03 | D | OM611A (60KWCDI) |
| | 60 | 03/99 → 07/03 | D | OM611A (60KWCDI) |
| 110 CDI 2.2 | 75 | 03/99 → 07/03 | D | OM611LA (75KWCDI) |
| | 75 | 03/99 → 07/03 | D | OM611LA (75KWCDI) |
| 112 CDI 2.2 | 90 | 03/99 → 07/03 | D | OM611.980 |

82032
350982032000

FLANGIA

| | |
|-------------------------|-------|
| Numero Fori Flangia | 3 |
| Dimensione Fori Flangia | M6×1 |
| Posizione Attacco | 47 |
| Diametro Centraggio | Ø20 |
| Diametro Girante | Ø59.6 |
| N° Alette Girante | 5 |
| Posizione Girante | 23.3 |

KW

BMW
1 II (F20, F21)

| | | | | | |
|-------|-----|---------|---|---------|-----------|
| 114 i | 75 | 11/11 → | B | N13B16A | → 11-2012 |
| 116 i | 100 | 12/10 → | B | N13B16A | → 11-2012 |
| 118 i | 100 | 03/15 → | B | N13B16A | → 11-2012 |
| | 125 | 11/10 → | B | N13B16A | → 11-2012 |
| 120 i | 130 | 03/15 → | B | N13B16A | → 11-2012 |

3 VI (F30, F35, F80), Touring (F31), GT (F34)

| | | | | | |
|-------|-----|---------|---|---------|-----------|
| 316 i | 100 | 10/12 → | B | N13B16A | → 11-2012 |
| 320 i | 125 | 02/12 → | B | N13B16A | → 11-2012 |

82032
350982032000

KW

CITROËN
Berlingo II, Van

| | | | | |
|-------------|----|---------|---|-------------|
| 1.6 VTi 120 | 88 | 11/09 → | B | 5FS (EP6C) |
| 1.6 VTi 95 | 72 | 07/10 → | B | 5FK (EP6CB) |

C 3 II, Picasso

| | | | | |
|----------------|----|---------|---|---------------------------------|
| 1.4 LPG | 70 | 06/13 → | | 8FN (EP3) |
| 1.4 VTi | 72 | 11/09 → | B | 8FR (EP3) |
| 1.4 VTi 95 | 70 | 02/09 → | B | 8FN (EP3), 8FP (EP3), 8FS (EP3) |
| | 70 | 11/09 → | B | 8FP (EP3) |
| 1.4 VTi 95 LPG | 70 | 01/12 → | | 8FN (EP3) |
| 1.6 VTi 120 | 88 | 11/09 → | B | 5FS (EP6C) |
| | 88 | 02/09 → | B | 5FS (EP6C), 5FW (EP6) |

C 4 I, Coupé, Picasso, Grand Picasso

| | | | | |
|-------------|-----|---------------|---|--------------|
| 1.6 16V | 103 | 07/08 → | B | 5FT (EP6DT) |
| | 110 | 10/08 → | B | 5FX (EP6DT) |
| 1.6 THP 140 | 103 | 07/08 → 07/11 | B | 5FT (EP6DT) |
| 1.6 THP 150 | 110 | 07/08 → 07/11 | B | 5FX (EP6DT) |
| 1.6 THP 155 | 115 | 09/10 → | B | 5FV (EP6CDT) |
| 1.6 VTi 120 | 88 | 07/08 → 07/11 | B | 5FW (EP6) |

C 4 II, Picasso, Grand Picasso

| | | | | |
|-----------------|-----|---------|---|--------------|
| 1.4 VTi 95 | 70 | 11/09 → | B | 8FP (EP3) |
| 1.6 THP 155 | 115 | 09/13 → | B | 5FV (EP6CDT) |
| 1.6 THP 165 | 121 | 07/14 → | B | 5GZ (EP6FDT) |
| 1.6 VTi 120 | 88 | 09/13 → | B | 5FS (EP6C) |
| 1.6 VTi 120 LPG | 88 | 09/11 → | | 5FS (EP6C) |

C 5 III, Break

| | | | | |
|-------------|-----|---------|---|--------------|
| 1.6 THP 150 | 110 | 07/10 → | B | 5FN (EP6CDT) |
| 1.6 THP 155 | 115 | 04/09 → | B | 5FV (EP6CDT) |
| 1.6 VTi 120 | 88 | 07/10 → | B | 5FS (EP6C) |

DS 3, Cabrio

| | | | | |
|----------------|----|---------------|---|-----------|
| 1.4 VTi 95 | 70 | 04/10 → 07/15 | B | 8FP (EP3) |
| 1.4 VTi 95 LPG | 70 | 08/12 → 07/15 | | 8FN (EP3) |
| 1.4 VTi 98 | 72 | 11/09 → 07/15 | B | 8FR (EP3) |

82032
350982032000

KW

CITROËN
DS 3, Cabrio

| | | | | | |
|-------------|-----|---------------|---|---------------------------|--|
| 1.6 Racing | 147 | 02/11 → 07/15 | B | 5FU (EP6CDTX) | |
| | 152 | 02/11 → 07/15 | B | 5FD (EP6DTS) | |
| 1.6 THP 150 | 110 | 01/13 → 07/15 | B | 5FN (EP6CDT) | |
| | 110 | 01/10 → 07/15 | B | 5FN (EP6CDT), 5FX (EP6DT) | |
| 1.6 THP 155 | 115 | 04/10 → 07/15 | B | 5FR (EP6DT), 5FV (EP6CDT) | |
| | 115 | 01/13 → 07/15 | B | 5FV (EP6CDT) | |
| 1.6 VTi 120 | 88 | 04/10 → 07/15 | B | 5FS (EP6C) | |

DS 4

| | | | | | |
|-------------|-----|---------------|---|---------------------------|--|
| 1.6 THP 155 | 115 | 04/11 → 07/15 | B | 5FV (EP6CDT) | |
| 1.6 THP 160 | 120 | 04/12 → 07/15 | B | 5FM (EP6DT) | |
| 1.6 THP 165 | 121 | 01/12 → 07/15 | B | 5FM (EP6DT), 5GZ (EP6FDT) | |
| 1.6 THP 200 | 147 | 04/11 → 07/15 | B | 5FU (EP6DTX) | |
| 1.6 VTi 120 | 88 | 04/11 → 07/15 | B | 5FS (EP6C) | |

DS 5

| | | | | | |
|-------------|-----|---------------|---|--------------|--|
| 1.6 THP 155 | 115 | 11/11 → 07/15 | B | 5FV (EP6CDT) | |
| 1.6 THP 200 | 147 | 11/11 → 07/15 | B | 5FU (EP6DTX) | |

DS
DS 3

| | | | | | |
|-------------|-----|---------|---|--|--|
| 1.6 THP 165 | 121 | 07/15 → | B | | |
|-------------|-----|---------|---|--|--|

DS 4 / DS 4 CROSSBACK

| | | | | | |
|-------------|-----|---------|---|--|--|
| 1.6 THP 165 | 121 | 07/15 → | B | | |
|-------------|-----|---------|---|--|--|

DS5

| | | | | | |
|-------------|-----|---------|---|--|--|
| 1.6 THP 210 | 155 | 04/15 → | B | | |
|-------------|-----|---------|---|--|--|

MINI
Mini Countryman (R60)

| | | | | | |
|-------------|----|---------|---|---------|-----------|
| Cooper | 85 | 06/10 → | B | N16B16A | → 11-2012 |
| | 90 | 06/10 → | B | N16B16A | → 11-2012 |
| Cooper ALL4 | 90 | 11/14 → | B | N18B16A | |

82032
350982032000

KW

MINI
Mini Countryman (R60)

| | | | | | |
|---------------|-----|---------|---|---------|-----------|
| Cooper S | 135 | 06/10 → | B | N18B16A | → 11-2012 |
| | 147 | 02/12 → | B | N18B16A | → 11-2012 |
| Cooper S ALL4 | 120 | 06/10 → | B | N18B16A | → 11-2012 |
| | 135 | 06/10 → | B | N18B16A | → 11-2012 |
| Cooper S JCW | 160 | 09/12 → | B | N18B16A | → 11-2012 |
| One | 72 | 06/10 → | B | N16B16A | → 11-2012 |

Mini I (R50,R52, R53)

| | | | | | |
|-------------------|-----|---------------|---|---------|--|
| John Cooper Works | 160 | 03/06 → 09/06 | B | W11B16A | |
|-------------------|-----|---------------|---|---------|--|

Mini II (R55, R56,R57,R58, R59)

| | | | | | |
|----------------------|-----|---------------|---|------------------|-----------|
| Cooper | 85 | 03/10 → 11/13 | B | N12B16A, N16B16A | → 11-2012 |
| | 85 | 03/09 → | B | N16B16A | → 11-2012 |
| | 88 | 10/06 → 02/12 | B | N12B16A | → 11-2012 |
| | 88 | 10/07 → 12/13 | B | N12B16A, N16B16A | → 11-2012 |
| | 90 | 09/09 → 11/13 | B | N16B16A | → 11-2012 |
| Cooper S | 120 | 10/07 → 02/10 | B | N14B16A | → 11-2012 |
| | 120 | 03/10 → 11/13 | B | N18B16A | → 11-2012 |
| | 120 | 09/11 → | B | N18B16A | |
| | 128 | 10/06 → 01/11 | B | N14B16A | → 11-2012 |
| | 135 | 03/10 → 11/13 | B | N18B16A | → 11-2012 |
| | 135 | 09/11 → | B | N18B16A | |
| | 147 | 03/10 → | B | N18B16A | → 11-2012 |
| | 147 | 01/12 → 11/13 | B | N18B16A | |
| Cooper SD | 105 | 02/11 → | D | N47C20A | |
| John Cooper Works | 141 | 10/08 → 02/10 | B | N14B16A | |
| | 141 | 11/06 → 12/11 | B | N14B16C | → 11-2012 |
| | 155 | 03/08 → 08/12 | B | N14B16C | |
| | 155 | 03/08 → 11/13 | B | N14B16C | → 11-2012 |
| John Cooper Works GP | 155 | 02/12 → | B | N14B16C, N18B16C | → 11-2012 |
| | 160 | 09/12 → 11/13 | B | N18B16C | → 11-2012 |
| One | 55 | 03/09 → 03/10 | B | N12B14A | → 11-2012 |
| | 70 | 11/06 → 03/10 | B | N12B14A | → 11-2012 |
| | 55 | 03/10 → 11/13 | B | N16B16A | → 11-2012 |
| | 72 | 03/10 → 11/13 | B | N16B16A | → 11-2012 |

82032 350982032000

PEUGEOT
207, Station Wagon, CC, Van

| | | | | |
|---------------|-----|---------|---|----------------------------|
| 1.4 16V | 70 | 06/07 → | B | 8FS (EP3), EP3, EP3C |
| | 72 | 10/09 → | B | 8FR (EP3) |
| 1.6 16V | 88 | 02/07 → | B | 5FS (EP6C), 5FW (EP6), EP6 |
| 1.6 16V RC | 128 | 02/07 → | B | 5FY (EP6DTS) |
| 1.6 16V Turbo | 110 | 02/06 → | B | 5FX (EP6DT) |
| | 115 | 10/09 → | B | 5FR (EP6DT) |
| | 115 | 10/09 → | B | 5FR (EP6DT), EP6CDT |
| 1.6 16V VTi | 88 | 02/07 → | B | 5FS (EP6C), 5FW (EP6), EP6 |

208

| | | | | |
|-------------|-----|---------|---|---------------------|
| 1.4 GPL | 70 | 10/13 → | | EP3C |
| 1.4 VTi | 70 | 03/12 → | B | 8FS (EP3), EP3C |
| 1.6 | 88 | 03/12 → | B | 5FS (EP6C) |
| | 115 | 03/12 → | B | 5FV (EP6DT), EP6CDT |
| 1.6 GTi | 147 | 08/12 → | B | 5FU (EP6CDTX) |
| 1.6 GTi | 153 | 10/14 → | B | |
| 1.6 THP 165 | 121 | 03/15 → | B | |

308 I, Station Wagon, CC

| | | | | |
|-------------|-----|---------|---|----------------|
| 1.4 16V | 70 | 09/07 → | B | 8FS (EP3) |
| | 70 | 09/07 → | B | 8FS (EP3), EP3 |
| | 72 | 12/09 → | B | 8FR (EP3) |
| 1.6 | 120 | 01/12 → | B | 5FV (EP6DT) |
| 1.6 16V | 88 | 09/07 → | B | 5FW (EP6), EP6 |
| | 88 | 06/09 → | B | EP6 |
| | 103 | 09/07 → | B | 5FT (EP6DT) |
| | 110 | 09/07 → | B | 5FX (EP6DT) |
| | 115 | 10/09 → | B | EP6CDT |
| | 128 | 03/08 → | B | 5FY (EP6DTS) |
| | | | | |
| 1.6 Bioflex | 82 | 03/09 → | | NFU (TU5JP4) |
| 1.6 GTi | 147 | 07/10 → | B | EP6CDTX |
| 1.6 THP | 147 | 10/10 → | B | EP6CDTX |

82032 350982032000

PEUGEOT
308 II Station Wagon

| | | | | |
|-------------|-----|---------|---|---------------|
| 1.6 | 115 | 09/13 → | B | 5FV (EP6DT) |
| 1.6 GT 205 | 151 | 06/14 → | B | |
| 1.6 GTi | 184 | 08/15 → | B | |
| | 200 | 06/15 → | B | 5GN (EP6FDTR) |
| 1.6 THP 125 | 92 | 09/13 → | B | |
| 1.6 THP 155 | 115 | 03/14 → | B | 5FV (EP6DT) |

508, Station Wagon

| | | | | |
|---------|-----|---------|---|--------------|
| 1.6 | 120 | 01/12 → | B | 5GZ (EP6FDT) |
| | 121 | 09/11 → | B | |
| 1.6 THP | 110 | 11/10 → | B | 5FN (EP6CDT) |
| | 110 | 11/10 → | B | 5FX (EP6DT) |
| | 115 | 11/10 → | B | EP6CDT |
| 1.6 VTi | 85 | 11/10 → | B | 5FH (EP6C) |
| | 88 | 11/10 → | B | 5FS (EP6C) |

2008

| | | | | |
|---------|----|---------|---|------------|
| 1.6 VTi | 88 | 03/13 → | B | 5FS (EP6C) |
|---------|----|---------|---|------------|

3008

| | | | | |
|-----------|-----|---------|---|----------------------------|
| 1.6 THP | 110 | 06/09 → | B | 5FX (EP6DT) |
| | 115 | 06/09 → | B | 5FV (EP6DT) |
| 1.6 Turbo | 121 | 05/14 → | B | 5GZ (EP6FDT) |
| 1.6 VTi | 88 | 06/09 → | B | 5FS (EP6C), 5FW (EP6), EP6 |

5008

| | | | | |
|-------------|-----|---------|---|----------------------------|
| 1.6 | 120 | 02/12 → | B | 5GZ (EP6FDT) |
| 1.6 16V | 88 | 09/09 → | B | 5FS (EP6C), 5FW (EP6), EP6 |
| | 115 | 09/09 → | B | EP6CDT |
| 1.6 THP 150 | 110 | 02/12 → | B | |
| 1.6 THP 165 | 121 | 02/12 → | B | 5GZ (EP6FDT) |

Partner II, Tepee

| | | | | |
|-----|----|---------|---|-------------|
| 1.6 | 72 | 11/10 → | B | 5FK (EP6CB) |
|-----|----|---------|---|-------------|

RCZ

| | | | | |
|-------------|-----|---------|---|---------------|
| 1.6 16V | 115 | 03/10 → | B | EP6CDT |
| | 147 | 06/10 → | B | EP6CDTX |
| 1.6 THP 270 | 199 | 06/13 → | B | 5FG (EP6CDTR) |

82033
350982033000

ALBERINO

Diametro Alberino \varnothing 11.9
 Tipo Filetto Alberino M12x1.25
 Posizione Attacco 26.5
 Diametro Girante \varnothing 71.7
 N° Alette Girante 7
 Posizione Girante 71.3

VOLKSWAGEN
Multivan V

| | | | | |
|--------------------|-----|---------------|---|----------|
| 2.5 TDI | 96 | 04/03 → 11/09 | D | AXD, BNZ |
| | 120 | 11/03 → 11/09 | D | BLJ |
| | 128 | 04/03 → 11/09 | D | AXE, BPC |
| 2.5 TDI 4motion | 96 | 07/04 → 11/09 | D | AXD, BNZ |
| | 128 | 07/04 → 11/09 | D | AXE, BPC |

Touareg I

| | | | | |
|------------|-----|---------------|---|----------|
| 2.5 R5 TDI | 120 | 08/03 → 05/10 | D | BLK, BPD |
| | 128 | 01/03 → 05/10 | D | BAC, BPE |

Transporter V

| | | | | |
|--------------------|-----|---------------|---|----------|
| 2.5 TDI | 96 | 04/03 → 11/09 | D | AXD, BNZ |
| | 120 | 11/03 → 11/09 | D | BLJ |
| | 128 | 04/03 → 11/09 | D | AXE, BPC |
| 2.5 TDI 4motion | 96 | 07/04 → 11/09 | D | AXD, BNZ |
| | 128 | 07/04 → 11/09 | D | AXE, BPC |

82034
350982034000

PULEGGIA

Diametro Puleggia \varnothing 94.3
 Numero Denti/Gole Puleggia 6
 Altezza Puleggia 25
 Posizione Attacco 90.8
 Diametro Girante \varnothing 64.9
 N° Alette Girante 6
 Posizione Girante -0.7

BMW
3 IV (E46), Touring, Cabrio, Coupé, Compact

| | | | | | |
|--------|-----|---------------|---|---------------------------------|------|
| 320 Cd | 110 | 02/05 → 12/07 | D | M47D20 (204D4) | C: A |
| | 110 | 11/03 → 07/06 | D | M47D20 (204D4), M47N204D4 | C: A |
| 320 d | 110 | 09/01 → 02/05 | D | M47D20 (204D4) | C: A |

82034
350982034000

BMW
3 IV (E46), Touring, Cabrio, Coupé, Compact

| | | | | |
|--------|-----|---------------|---|---------------------------------|
| 330 Cd | 150 | 08/05 → 12/07 | D | M57D30 (306D2), M57N306D2 |
| 330 d | 150 | 03/03 → 02/05 | D | M57D30 (306D2), M57N306D2 |
| 330 xd | 150 | 03/03 → 02/05 | D | M57D30 (306D2), M57N306D2 |

7 IV (E65, E66)

| | | | | |
|--------|-----|---------------|---|---------------------------------|
| 730 d | 155 | 10/02 → 07/08 | D | M57D30 (306D3), M57N306D2 |
| | 160 | 10/02 → 07/08 | D | M57D30 (306D2) |
| 730 Ld | 170 | 07/05 → 12/09 | D | M57306D3, M57D30 (306D3) |

X5 I (E53)

| | | | | |
|-------|-----|---------------|---|---------------------------------|
| 3.0 d | 155 | 09/03 → 12/06 | D | M57D30 (306D2), M57N306D2 |
| | 160 | 12/03 → 12/06 | D | M57D30 (306D2) |

82036
350982036000

PULEGGIA

Diametro Puleggia \varnothing 53.2
 Numero Denti/Gole Puleggia 3
 Altezza Puleggia 10.6
 Posizione Attacco 33.5
 Diametro Girante \varnothing 78.5
 N° Alette Girante 6
 Posizione Girante 24.6

FORD
Maverick II

| | | | | | |
|------------|-----|---------|---|----|-----------|
| 3.0 V6 24V | 145 | 02/01 → | B | AJ | 05-2003 → |
| | 149 | 03/04 → | B | AJ | |

Mondeo III, Station Wagon

| | | | | |
|------------|-----|---------------|---|------|
| 2.5 V6 24V | 125 | 10/00 → 03/07 | B | LCBD |
| 3.0 V6 24V | 150 | 09/04 → 03/07 | B | REBA |
| ST220 | 166 | 04/02 → 03/07 | B | MEBA |

82038
350982038000

FLANGIA

| | |
|-------------------------|---------|
| Numero Fori Flangia | 4 |
| Dimensione Fori Flangia | M8x1.25 |
| Posizione Attacco | 59.2 |
| Diametro Centraggio | Ø32 |
| Diametro Girante | Ø76.5 |
| N° Alette Girante | 6 |
| Posizione Girante | 5.1 |



KW

KIA
Carnival I

| | | | | |
|--------|----|---------------|---|----|
| 2.9 TD | 93 | 08/99 → 10/01 | D | J3 |
|--------|----|---------------|---|----|

Carnival II

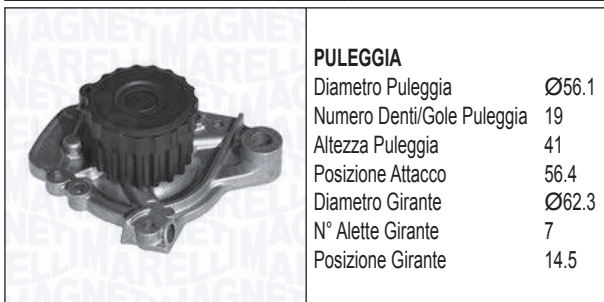
| | | | | |
|--------|----|---------|---|----|
| 2.9 TD | 93 | 01/99 → | D | J3 |
|--------|----|---------|---|----|

82039
350982039000

PULEGGIA

| | |
|----------------------------|-------|
| Diametro Puleggia | Ø56.1 |
| Numero Denti/Gole Puleggia | 19 |
| Altezza Puleggia | 41 |
| Posizione Attacco | 56.4 |
| Diametro Girante | Ø62.3 |
| N° Alette Girante | 7 |
| Posizione Girante | 14.5 |

KW

HONDA
Civic VII, Hatchback, Coupé

| | | | | |
|------------|----|---------------|---|-----------------|
| 1.4 | 66 | 12/00 → 09/05 | B | D14Z5 |
| 1.4 iS | 66 | 02/01 → 09/05 | B | D14Z5, D14Z6 |
| 1.6 | 84 | 02/01 → 09/05 | B | R16A1 |
| | 81 | 02/01 → 09/05 | B | D16V1 |
| 1.6 i | 81 | 02/01 → 12/05 | B | D16V1 |
| 1.7 | 85 | 02/01 → 09/05 | B | D17A6 |
| 1.7 i | 88 | 05/01 → 12/05 | B | D17A8 |
| 1.7 i VTEC | 92 | 05/01 → 12/05 | B | D17A5, D17A9 |

FR-V

| | | | | |
|-----|----|---------|---|-------|
| 1.7 | 92 | 08/04 → | B | D17A2 |
|-----|----|---------|---|-------|

Stream I

| | | | | |
|---------|-----|---------|---|-------|
| 1.7 16V | 92 | 05/01 → | B | D17A2 |
| 2.0 16V | 115 | 05/01 → | B | K20A1 |

82040
350982040000

PULEGGIA

| | |
|----------------------------|--------|
| Diametro Puleggia | Ø94.15 |
| Numero Denti/Gole Puleggia | 6 |
| Altezza Puleggia | 27.8 |
| Posizione Attacco | 93.4 |
| Diametro Girante | Ø64.5 |
| N° Alette Girante | 6 |
| Posizione Girante | -1.5 |

KW

BMW
1 I (E81, E87), Coupé (E82), Cabrio (E88)

| | | | | |
|-------|-----|---------------|---|---|
| 118 d | 90 | 11/03 → 09/12 | D | M47D20 (204D4), N47D20A, N47D20C |
| 120 d | 120 | 03/07 → 09/12 | D | M47D20 (204D4), N47D20A, N47D20C |

3 IV (E46), Touring, Cabrio, Coupé, Compact

| | | | | | |
|--------|-----|---------------|---|---------------------------------|-----------|
| 318 d | 85 | 03/03 → 02/05 | D | M47D20 (204D4), M47N204D4 | → 03-2004 |
| | 85 | 03/03 → 02/05 | D | M47D20 (204D4), M47N204D4 | 04-2004 → |
| 318 td | 85 | 03/03 → 02/05 | D | M47D20 (204D4), M47N204D4 | → 03-2004 |
| | 85 | 03/03 → 02/05 | D | M47D20 (204D4), M47N204D4 | 04-2004 → |
| 320 Cd | 110 | 02/05 → 12/07 | D | M47D20 (204D4) | |
| | 110 | 11/03 → 07/06 | D | M47D20 (204D4), M47N204D4 | → 03-2004 |
| | 110 | 11/03 → 07/06 | D | M47D20 (204D4), M47N204D4 | 04-2004 → |
| 320 d | 110 | 09/01 → 02/05 | D | M47D20 (204D4) | → 03-2004 |
| | 110 | 09/01 → 02/05 | D | M47D20 (204D4) | 04-2004 → |

82040
350982040000

KW

BMW
3 IV (E46), Touring, Cabrio, Coupé, Compact

| | | | | | |
|--------|-----|---------------|---|---------------------------------|-----------|
| 320 td | 110 | 09/01 → 02/05 | D | M47D20 (204D4), M47N204D4 | → 03-2004 |
| | 110 | 09/01 → 02/05 | D | M47D20 (204D4), M47N204D4 | 04-2004 → |

3 V (E90), Touring (E91), Cabrio (E93), Coupé (E92)

| | | | | | |
|--------|-----|---------------|---|--|--|
| 318 d | 90 | 09/05 → 12/11 | D | M47D20 (204D4) | |
| | 105 | 09/05 → 12/11 | D | N47D20A, N47D20C | |
| 320 d | 110 | 09/05 → 06/12 | D | M47D20 (204D4), M47D20TU | |
| | 110 | 09/05 → 12/11 | D | M47D20 (204D4), M47N204D4 | |
| | 120 | 01/05 → 12/11 | D | M47D20 (204D4), N47D20C | |
| 325 d | 145 | 09/06 → 12/11 | D | M57306D3, M57D30 (306D3) | |
| | 145 | 09/06 → 06/12 | D | M57306D3, M57D30 (306D3), M57D30TU2 | |
| | 145 | 03/07 → 12/13 | D | M57D30 (306D3) | |
| | 145 | 03/07 → 12/13 | D | M57D30 (306D3), M57D30TU2 | |
| | 155 | 01/07 → 12/09 | D | M57D30 (306D3) | |
| 330 d | 170 | 03/07 → 12/13 | D | M57D30 (306D3) | |
| | 170 | 09/05 → 12/11 | D | M57D30 (306D3), M57D30TU2 | |
| 330 xd | 170 | 09/05 → 12/11 | D | M57D30 (306D3), M57D30TU2 | |

82040
350982040000

KW

BMW
3 V (E90), Touring (E91), Cabrio (E93), Coupé (E92)

| | | | | | |
|-------|-----|---------------|---|---------------------------------|-----------|
| 335 d | 210 | 09/06 → 12/11 | D | M57D30 (306D5), M57N306D5 | → 03-2010 |
| | 210 | 09/06 → 12/13 | D | M57D30 (306D5), M57N306D5 | |

5 V (E60), Touring (E61)

| | | | | | | |
|-------|--------------|---------------|---------------|---|-------------------|--|
| 520 d | 110 | 09/05 → 03/10 | D | M47D20 (204D4) | | |
| | 110 | 09/05 → 12/10 | D | M47D20 (204D4), N47D20A, N47D20C | | |
| 525 d | 120 | 07/05 → 03/10 | D | M47D20 (204D4), N47D20A, N47D20C | | |
| | 120 | 12/04 → 03/10 | D | M57D25 (256D1) | | |
| 525 d | 120 | 12/04 → 12/10 | D | M57N256D4 | | |
| | 130 | 06/04 → 03/10 | D | M57D25 (256D2), M57D25TU | | |
| 525 d | 145 | 01/07 → 03/10 | D | M57D30 (306D3) | | |
| | 525 d xDrive | 145 | 09/08 → 03/10 | D | M57D30 (306D3) | |
| 530 d | 525 xd | 145 | 01/07 → 03/10 | D | M57D30 (306D3) | |
| | 155 | 07/03 → 03/10 | D | M57D30 (306D2), M57D30 (306D3) | | |
| | 155 | 11/05 → 12/10 | D | M57D30 (306D3) | | |
| | 160 | 07/03 → 03/10 | D | M57D30 (306D2) | → 03-2004 | |
| | 160 | 07/03 → 03/10 | D | M57D30 (306D2) | 04-2004 → | |
| | 160 | 06/04 → 12/10 | D | M57D30 (306D2), N57306D2 | | |
| | 170 | 07/03 → 03/10 | D | M57D30 (306D3) | → 03-2004 | |

82040 350982040000

BMW
5 V (E60), Touring (E61)

| | | | | | |
|--------------|-----|---------------|---|----------------------------|-----------|
| 530 d | 170 | 07/03 → 03/10 | D | M57D30 (306D3) | 04-2004 → |
| | 170 | 07/05 → 12/10 | D | M57D30 (306D3) | |
| | 173 | 01/07 → 03/10 | D | M57306D3, M57D30 (306D3) | |
| 530 d xDrive | 173 | 09/08 → 03/10 | D | M57D30 (306D3), M57N2306D3 | |
| 530 xd | 170 | 07/05 → 03/10 | D | M57D30 (306D3) | |
| | 173 | 01/07 → 03/10 | D | M57306D3, M57D30 (306D3) | |
| | 173 | 01/07 → 12/10 | D | M57D30 (306D3) | |
| 535 d | 200 | 09/04 → 03/10 | D | M57D30 (306D4) | |
| | 210 | 01/07 → 03/10 | D | M57D30 (306D5), M57N306D5 | |

6 II (E63), Cabrio (E64)

| | | | | | |
|-------|-----|---------------|---|---------------------------|--|
| 635 d | 210 | 07/07 → 07/10 | D | M57D30 (306D5), M57N306D5 | |
| | 210 | 07/07 → 07/10 | D | M57D30 (306D5), M57N306D5 | |

X3 I (E83)

| | | | | | |
|-------------|-----|---------------|---|----------------------------|-----------|
| 2.0 d | 110 | 10/04 → 12/10 | D | M47D20 (204D4) | |
| 3.0 d | 150 | 01/04 → 08/05 | D | M57D30 (306D2), M57N2306D2 | |
| | 160 | 01/04 → 08/08 | D | M57D30 (306D3) | → 03-2010 |
| 3.0 sd | 210 | 09/06 → 08/08 | D | M57D30 (306D5) | |
| xDrive 30 d | 160 | 09/08 → 04/11 | D | M57D30 (306D3), M57N2306D3 | → 03-2010 |
| xDrive 35 d | 210 | 09/08 → 08/11 | D | M57D30 (306D5) | |

82040 350982040000

BMW
X5 II (E70)

| | | | | | |
|-------------|-----|---------------|---|---------------------------|--|
| 3.0 d | 155 | 02/07 → 09/08 | D | M57D30 (306D3) | |
| | 173 | 02/07 → 09/08 | D | M57306D3, M57D30 (306D3) | |
| 3.0 sd | 210 | 09/07 → 02/09 | D | M57D30 (306D5), M57N306D5 | |
| xDrive 30 d | 173 | 09/08 → 06/13 | D | N57D30A | |
| xDrive 35 d | 210 | 09/08 → 06/13 | D | M57D30 (306D5) | |

X6 I (E71, E72)

| | | | | | |
|-------------|-----|---------------|---|---------------------------|--|
| 30 d | 173 | 05/08 → 08/08 | D | M57D30 (306D3) | |
| 35 d | 210 | 05/08 → 08/08 | D | M57D30 (306D5) | |
| xDrive 30 d | 173 | 09/08 → 06/14 | D | N57D30A | |
| xDrive 35 d | 210 | 09/08 → 06/14 | D | M57D30 (306D5), N57N306D5 | |

82041 350982041000

| | |
|--|--|
| | PULEGGIA Diametro Puleggia Ø57.2 Altezza Puleggia 33 Posizione Attacco 25.5 Diametro Girante Ø80.6 N° Alette Girante 7 Posizione Girante 31.8 |
|--|--|

AUDI
A8 I

| | | | | | |
|-----------------|-----|---------------|---|-----|--|
| 3.3 TDI quattro | 165 | 06/00 → 09/02 | D | AKF | |
|-----------------|-----|---------------|---|-----|--|

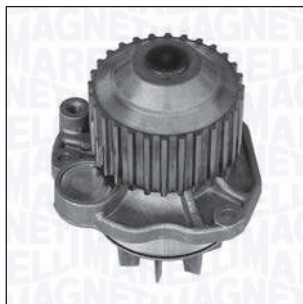
82042
350982042000

PULEGGIA

| | |
|----------------------------|-------|
| Diametro Puleggia | Ø69.8 |
| Numero Denti/Gole Puleggia | 28 |
| Altezza Puleggia | 36 |
| Posizione Attacco | 54.2 |
| Diametro Girante | Ø69.5 |
| N° Alette Girante | 8 |
| Posizione Girante | 58.4 |

KW

CITROËN
Xantia I, Break

| | | | | | |
|-----------|-----|---------------|---|-------------|------------|
| 3.0 i 24V | 140 | 01/97 → 01/98 | B | XFZ (ES9J4) | T →: 08442 |
|-----------|-----|---------------|---|-------------|------------|

Xantia II, Break

| | | | | | |
|--------|-----|---------------|---|-------------|------------|
| 3.0 V6 | 140 | 01/98 → 04/03 | B | XFZ (ES9J4) | T →: 08442 |
|--------|-----|---------------|---|-------------|------------|

XM II, Break

| | | | | | |
|--------|-----|---------------|---|-------------|------------|
| 3.0 V6 | 140 | 04/97 → 10/00 | B | XFZ (ES9J4) | T →: 08442 |
|--------|-----|---------------|---|-------------|------------|

PEUGEOT
407, Station Wagon, Coupé

| | | | | | |
|---------|-----|---------------|---|-------------|------------|
| 3.0 24V | 140 | 10/96 → 05/04 | B | XFZ (ES9J4) | T →: 08442 |
|---------|-----|---------------|---|-------------|------------|

| | | | | | |
|------------|-----|---------------|---|-------------|------------|
| 3.0 V6 24V | 140 | 03/97 → 12/04 | B | XFZ (ES9J4) | T →: 08442 |
|------------|-----|---------------|---|-------------|------------|

RENAULT
Espace III

| | | | | | |
|------------|-----|---------------|---|--------|------------|
| 3.0 V6 24V | 140 | 10/98 → 10/02 | B | L7X727 | T →: 08442 |
|------------|-----|---------------|---|--------|------------|

Laguna I, Grantour

| | | | | | |
|---------|-----|---------------|---|-------------------|------------|
| 3.0 24V | 140 | 03/97 → 03/01 | B | L7X700, L7X701 | T →: 08442 |
|---------|-----|---------------|---|-------------------|------------|

Safrane II

| | | | | | |
|---------|-----|---------------|---|--------|------------|
| 2.9 24V | 140 | 03/99 → 12/00 | B | L7X713 | T →: 08442 |
|---------|-----|---------------|---|--------|------------|

82044
350982044000

PULEGGIA

| | |
|-------------------|------|
| Diametro Puleggia | Ø62 |
| Altezza Puleggia | 35.2 |
| Posizione Attacco | 58 |
| Diametro Girante | Ø74 |
| N° Alette Girante | 7 |
| Posizione Girante | 19.2 |

KW

TOYOTA
Avensis II, Liftback, Station Wagon

| | | | | | |
|----------|----|---------------|---|---------|-----------|
| 2.0 D-4D | 85 | 04/03 → 11/08 | D | 1CD-FTV | 07-2004 → |
|----------|----|---------------|---|---------|-----------|

Corolla Verso

| | | | | | |
|----------|----|---------------|---|---------|--|
| 2.0 D-4D | 85 | 04/04 → 03/09 | D | 1CD-FTV | |
|----------|----|---------------|---|---------|--|

Corolla VII, Liftback, Station Wagon, Verso

| | | | | | |
|----------|----|---------------|---|---------|-----------|
| 2.0 D-4D | 66 | 01/02 → 02/07 | D | 1CD-FTV | 07-2004 → |
| | 85 | 04/04 → 02/07 | D | 1CD-FTV | |

82045
350982045000

FLANGIA

| | |
|-------------------------|-------|
| Numero Fori Flangia | 3 |
| Dimensione Fori Flangia | M6×1 |
| Posizione Attacco | 70.2 |
| Diametro Girante | Ø48.3 |
| N° Alette Girante | 7 |
| Posizione Girante | 5.2 |

KW

HONDA
Civic VIII, Hatchback, Coupé

| | | | | | |
|-----|----|---------|---|-------|--|
| 1.4 | 61 | 09/05 → | B | L13A7 | |
|-----|----|---------|---|-------|--|

Jazz II

| | | | | | |
|-----|----|---------------|---|-------|--|
| 1.2 | 57 | 03/02 → 07/08 | B | L12A1 | |
|-----|----|---------------|---|-------|--|

| | | | | | |
|-----|----|---------------|---|-------|--|
| 1.3 | 61 | 03/02 → 07/08 | B | L13A1 | |
|-----|----|---------------|---|-------|--|

Jazz III

| | | | | | |
|-----|----|---------|---|-------|--|
| 1.2 | 66 | 07/08 → | B | L12B1 | |
|-----|----|---------|---|-------|--|

| | | | | | |
|-------|----|---------|---|-------|--|
| 1.3 i | 73 | 07/08 → | B | L13Z1 | |
|-------|----|---------|---|-------|--|

82046
350982046000

ALBERINO

| | |
|-------------------|-----|
| Diametro Alberino | Ø12 |
| Posizione Attacco | 65 |
| Diametro Girante | Ø68 |
| N° Alette Girante | 8 |
| Posizione Girante | 5.5 |

KW

AUDI
A4 II, Avant, Cabriolet

| | | | | |
|------------|-----|---------------|---|-----|
| S4 quattro | 253 | 03/03 → 12/04 | B | BBK |
|------------|-----|---------------|---|-----|

A4 III, Avant

| | | | | |
|------------|-----|---------------|---|----------|
| S4 quattro | 253 | 11/04 → 06/08 | B | BBK |
| | 253 | 11/04 → 06/08 | B | BBK, BHF |

A6 III, Avant, Allroad

| | | | | |
|-------------|-----|---------------|---|-----|
| 4.2 quattro | 246 | 05/04 → 05/06 | B | BAT |
|-------------|-----|---------------|---|-----|

A8 II

| | | | | |
|-----------------|-----|---------------|---|-----|
| 4.0 TDI quattro | 202 | 05/03 → 07/05 | D | ASE |
|-----------------|-----|---------------|---|-----|

| | | | | |
|-----------------|-----|---------------|---|-----|
| 4.2 TDI quattro | 235 | 01/05 → 06/05 | D | BMC |
| | 240 | 07/05 → 07/10 | D | BVN |

Allroad

| | | | | |
|----------------|-----|---------------|---|-----|
| 4.2 V8 quattro | 220 | 07/02 → 08/05 | B | BAS |
|----------------|-----|---------------|---|-----|

Q7 I

| | | | | |
|---------|-----|---------------|---|-----|
| 4.2 TDI | 240 | 03/07 → 06/09 | D | BTR |
|---------|-----|---------------|---|-----|

82047
350982047000

FLANGIA

| | |
|-----------------------------------|-------|
| Numero Fori Flangia | 4 |
| Numero Fori Flangia (Serie 2) | 2 |
| Dimensione Fori Flangia | M6×1 |
| Dimensione Fori Flangia (Serie 2) | Ø6 |
| Posizione Attacco | 90.6 |
| Diametro Centraggio | Ø35 |
| Diametro Girante | Ø82.2 |
| N° Alette Girante | 8 |
| Posizione Girante | 13.2 |

KW

MERCEDES-BENZ
Classe G (W460, W461), Cabrio (W463)

| | | | | |
|-----------|-----|---------|---|-----------|
| G 270 CDI | 115 | 10/01 → | D | OM612.965 |
|-----------|-----|---------|---|-----------|

Sprinter I (901, 902, 903, 904)

| | | | | |
|---------|-----|---------------|---|-----------------------|
| 208 CDI | 60 | 04/00 → 05/06 | D | OM611.987 |
| 211 CDI | 80 | 04/00 → 05/06 | D | OM611.981 → M: 107859 |
| 213 CDI | 95 | 04/00 → 05/06 | D | OM611.981 |
| 216 CDI | 115 | 04/00 → 05/06 | D | OM612.981 → 01-2004 |

82047
350982047000

KW

MERCEDES-BENZ
Sprinter I (901, 902, 903, 904)

| | | | | |
|-------------|-----|---------------|---|-----------------------|
| 308 CDI | 60 | 04/00 → 05/06 | D | OM611.987 |
| 308 D 2.3 | 60 | 02/95 → 04/00 | D | OM601.943 |
| 311 CDI | 80 | 04/00 → 05/06 | D | OM611.981 → M: 107859 |
| 311 CDI 4x4 | 80 | 08/02 → 05/06 | D | OM611.981 → M: 107859 |
| 313 CDI | 95 | 04/00 → 05/06 | D | OM611.981 |
| 313 CDI 4x4 | 95 | 08/02 → 05/06 | D | OM611.981 |
| 316 CDI | 115 | 04/00 → 05/06 | D | OM612.981 → 01-2004 |
| 316 CDI 4x4 | 115 | 08/02 → 05/06 | D | OM612.981 → 01-2004 |
| 408 CDI | 60 | 04/00 → 05/06 | D | OM611.987 |
| 411 CDI | 80 | 04/00 → 05/06 | D | OM611.981 → M: 107859 |
| 411 CDI 4x4 | 80 | 04/00 → 05/06 | D | OM611.981 → M: 107859 |
| 413 CDI | 95 | 04/00 → 05/06 | D | OM611.981 |
| 413 CDI 4x4 | 95 | 04/00 → 05/06 | D | OM611.981 |
| 416 CDI | 115 | 04/00 → 05/06 | D | OM612.981 → 01-2004 |
| 416 CDI 4x4 | 115 | 04/00 → 05/06 | D | OM612.981 → 01-2004 |

Sprinter II (905)

| | | | | |
|---------|-----|---------------|---|-----------|
| 616 CDI | 115 | 04/01 → 05/06 | D | OM612.981 |
|---------|-----|---------------|---|-----------|

82048
350982048000

FLANGIA

| | |
|-------------------------|-------|
| Numero Fori Flangia | 4 |
| Numero Fori Flangia | 4 |
| Dimensione Fori Flangia | M6×1 |
| Posizione Attacco | 65.2 |
| Diametro Centraggio | Ø28 |
| Diametro Girante | Ø59.5 |
| N° Alette Girante | 6 |
| Posizione Girante | 5 |

KW

TOYOTA
Yaris I

| | | | | | |
|---------|----|---------------|---|--------|-----------------|
| 1.0 16V | 48 | 03/03 → 09/05 | B | 1SZ-FE | Flange: 4 holes |
| | 50 | 04/99 → 09/05 | B | 1SZ-FE | Flange: 4 holes |

Yaris II

| | | | | | |
|-----------|----|---------|---|----------------|-----------------|
| 1.3 VVT-i | 64 | 08/05 → | B | 2NZ-FE, 2SZ-FE | Flange: 4 holes |
|-----------|----|---------|---|----------------|-----------------|

82049
350982049000

| | |
|-------------------------|-------|
| FLANGIA | |
| Numero Fori Flangia | 4 |
| Dimensione Fori Flangia | M6×1 |
| Posizione Attacco | 52.3 |
| Diametro Centraggio | Ø28 |
| Diametro Girante | Ø56.1 |
| N° Alette Girante | 6 |
| Posizione Girante | 23.9 |

CITROËN
C 4 Aircross

| | | | | |
|-----|----|---------|---|------|
| 1.6 | 86 | 04/12 → | B | 4A92 |
|-----|----|---------|---|------|

MITSUBISHI
ASX, Van

| | | | | |
|-----|----|---------|---|------|
| 1.6 | 85 | 05/10 → | B | 4A92 |
| | 86 | 06/10 → | B | 4A92 |

Colt VI

| | | | | |
|------------|----|---------------|----|------|
| 1.1 | 55 | 10/04 → 06/12 | B | 3A91 |
| 1.1 Bifuel | 55 | 10/04 → 06/12 | BF | 3A91 |
| 1.3 | 70 | 06/04 → 06/12 | B | 4A90 |
| 1.3 Bifuel | 70 | 06/04 → 06/12 | BF | 4A90 |
| 1.5 | 80 | 06/04 → 06/12 | B | 4A91 |

Colt VII, CZC, Plus

| | | | | |
|-----|----|---------------|---|------|
| 1.5 | 80 | 05/06 → 07/09 | B | 4A91 |
|-----|----|---------------|---|------|

Lancer VIII, Station Wagon, Sportback

| | | | | |
|-----|----|---------|---|------|
| 1.5 | 80 | 06/08 → | B | 4A91 |
|-----|----|---------|---|------|

SMART
ForFour I

| | | | | |
|------------|-----|---------------|---|----------|
| 1.1 | 47 | 02/05 → 06/06 | B | M134.911 |
| | 55 | 01/04 → 06/06 | B | M134.910 |
| 1.3 | 70 | 01/04 → 06/06 | B | M135.930 |
| 1.5 | 80 | 01/04 → 06/06 | B | M135.950 |
| | 90 | 01/04 → 06/06 | B | M135.950 |
| 1.5 BRABUS | 130 | 05/05 → 06/06 | B | M122.950 |

82050
350982050000



| | |
|-------------------------|-------|
| FLANGIA | |
| Numero Fori Flangia | 4 |
| Dimensione Fori Flangia | M6×1 |
| Posizione Attacco | 80.1 |
| Diametro Centraggio | Ø24 |
| Diametro Girante | Ø57.5 |
| N° Alette Girante | 7 |
| Posizione Girante | 9.2 |

SUZUKI
Grand Vitara I

| | | | | |
|---------|----|---------------|---|------|
| 1.6 4x4 | 69 | 03/98 → 07/03 | B | G16B |
| | 73 | 02/00 → 09/02 | B | G16B |

Grand Vitara II

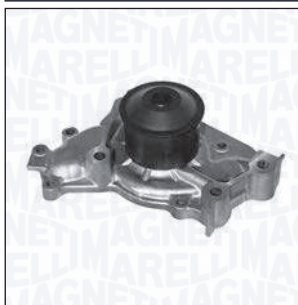
| | | | | |
|------------------------|----|---------------|---|------|
| 1.6 Trazione integrale | 73 | 09/05 → 02/15 | B | M16A |
| | 78 | 04/05 → | B | M16A |

82051
350982051000

| | |
|-------------------|-------|
| PULEGGIA | |
| Diametro Puleggia | Ø60 |
| Altezza Puleggia | 36 |
| Posizione Attacco | 61.7 |
| Diametro Girante | Ø72.1 |
| N° Alette Girante | 10 |
| Posizione Girante | 17.1 |

LEXUS
RX I

| | | | | |
|---------|-----|---------------|---|--------|
| 300 | 148 | 07/00 → 03/03 | B | 1MZ-FE |
| 300 AWD | 148 | 10/00 → 05/03 | B | 1MZ-FE |
| | 164 | 07/00 → 05/03 | B | 1MZ-FE |

RX II

| | | | | |
|----------|-----|---------------|---|--------|
| 300 | 150 | 05/03 → 12/08 | B | 1MZ-FE |
| 330 | 171 | 04/03 → 01/06 | B | 3MZ-FE |
| 330 AWD | 171 | 04/03 → 12/08 | B | 3MZ-FE |
| 400h | 155 | 09/05 → 12/08 | | 3MZ-FE |
| 400h AWD | 155 | 09/04 → 12/08 | | 3MZ-FE |

TOYOTA
Camry III, Station Wagon

| | | | | |
|---------|-----|---------------|---|--------|
| 3.0 24V | 140 | 08/96 → 11/01 | B | 1MZ-FE |
| 3.0 V6 | 135 | 08/96 → 11/01 | B | 1MZ-FE |

Camry IV

| | | | | |
|--------|-----|---------------|---|--------|
| 3.0 V6 | 137 | 11/01 → 11/06 | B | 1MZ-FE |
|--------|-----|---------------|---|--------|

82052
350982052000

FLANGIA

| | |
|-----------------------------------|------|
| Numero Fori Flangia | 4 |
| Numero Fori Flangia (Serie 2) | 2 |
| Dimensione Fori Flangia | M6x1 |
| Dimensione Fori Flangia (Serie 2) | Ø5.9 |
| Posizione Attacco | 90.9 |
| Diametro Centraggio | Ø35 |
| Diametro Girante | Ø78 |
| N° Alette Girante | 8 |
| Posizione Girante | 13.3 |

KW

MERCEDES-BENZ
Sprinter III (906)

| | | | | |
|-------------|-----|---------|---|---------------------------------------|
| 209 CDI | 65 | 06/06 → | D | OM646.984 |
| 211 CDI | 80 | 06/06 → | D | OM646.985 |
| 213 CDI | 95 | 06/06 → | D | OM646.986 |
| 215 CDI | 110 | 06/06 → | D | OM646.986, OM646.989, OM646.990 |
| | 110 | 06/06 → | D | OM646.989, OM646.990 |
| 218 CDI | 135 | 06/06 → | D | OM642.896, OM642.992, OM642.993 |
| 224 | 190 | 06/06 → | B | M272.979 |
| 309 CDI | 65 | 06/06 → | D | OM646.984 |
| 311 CDI | 80 | 06/06 → | D | OM646.985 |
| 311 CDI 4x4 | 80 | 02/08 → | D | OM646.985 |
| 313 CDI | 95 | 06/06 → | D | OM646.986 |
| | 95 | 06/06 → | D | OM646.986, OM651.955 |
| 315 CDI | 110 | 06/06 → | D | OM646.989, OM646.990 |
| 315 CDI 4x4 | 110 | 02/08 → | D | OM646.989, OM646.990 |
| 318 CDI | 135 | 06/06 → | D | OM642.896, OM642.992, OM642.993 |
| 324 | 190 | 06/06 → | B | M272.979 |
| 411 CDI | 80 | 06/09 → | D | OM646.985 |
| 415 CDI | 110 | 06/06 → | D | OM646.989, OM646.990 |
| 509 CDI | 65 | 06/06 → | D | OM646.984 |
| 511 CDI | 80 | 06/06 → | D | OM646.985 |
| 511 CDI 4x4 | 80 | 06/06 → | D | OM646.985 |

82052
350982052000

KW

MERCEDES-BENZ
Sprinter III (906)

| | | | | |
|-------------|-----|---------|---|---------------------------------------|
| 515 CDI | 110 | 06/06 → | D | OM646.986, OM646.989, OM646.990 |
| | 110 | 06/06 → | D | OM646.989, OM646.990 |
| 515 CDI 4x4 | 110 | 06/06 → | D | OM646.989, OM646.990 |
| 518 CDI | 135 | 06/06 → | D | OM642.896, OM642.992, OM642.993 |

Sprinter IV Classic

| | | | | |
|---------|----|---------|---|-----------|
| 311 CDI | 80 | 09/13 → | D | OM646.701 |
| 411 CDI | 80 | 09/13 → | D | OM646.701 |

Vito II (W639) - Viano

| | | | | |
|-----------------|-----|---------|---|-------------------------|
| 109 CDI | 65 | 09/03 → | D | OM646.983 |
| | 70 | 09/06 → | D | OM646.980 |
| | 70 | 08/06 → | D | OM646.980, OM646.981 |
| 109 CDI 4x4 | 70 | 09/07 → | D | OM646.981 |
| 111 CDI | 80 | 09/03 → | D | OM646.982 |
| | 85 | 09/07 → | D | OM646.980, OM646.982 |
| | 85 | 09/07 → | D | OM646.980 |
| 111 CDI 4x4 | 80 | 09/07 → | D | OM646.982 |
| 115 CDI | 110 | 09/03 → | D | OM646.980, OM646.982 |
| | 110 | 09/03 → | D | OM646.982 |
| 115 CDI 4x4 | 110 | 07/06 → | D | OM646.982 |
| CDI 2.0 | 80 | 09/03 → | D | OM646.982 |
| | 85 | 08/05 → | D | OM646.982 |
| CDI 2.0 4-matic | 80 | 07/05 → | D | OM646.982 |
| CDI 2.2 | 110 | 09/03 → | D | OM646.980, OM646.982 |
| CDI 2.2 4-matic | 110 | 07/05 → | D | OM646.982 |

82053
350982053000

| | |
|-------------------------|-------|
| FLANGIA | |
| Numero Fori Flangia | 4 |
| Dimensione Fori Flangia | M6×1 |
| Posizione Attacco | 106.2 |
| Diametro Centraggio | Ø31.6 |
| Diametro Girante | Ø74.7 |
| N° Alette Girante | 8 |
| Posizione Girante | -1.8 |

NISSAN
Serena I

| | | | | |
|-------|----|---------------|---|------|
| 2.3 D | 55 | 01/95 → 09/01 | D | LD23 |
|-------|----|---------------|---|------|

Vanette III Cargo

| | | | | |
|-------|----|---------|---|------|
| 2.3 D | 55 | 01/96 → | D | LD23 |
|-------|----|---------|---|------|

82054
350982054000

| | |
|-------------------------|-------|
| FLANGIA | |
| Numero Fori Flangia | 4 |
| Dimensione Fori Flangia | M6×1 |
| Posizione Attacco | 105.8 |
| Diametro Centraggio | Ø31.6 |
| Diametro Girante | Ø74.2 |
| N° Alette Girante | 8 |
| Posizione Girante | -1.1 |

NISSAN
Serena I

| | | | | |
|-------|----|---------------|---|------|
| 2.0 D | 49 | 11/92 → 09/01 | D | LD20 |
|-------|----|---------------|---|------|

Vanette II

| | | | | |
|-------|----|---------------|---|--------|
| 2.0 D | 49 | 07/91 → 01/95 | D | LD20II |
| | 47 | 10/86 → 12/95 | D | LD20 |

| | | | |
|----|---------------|---|------|
| 49 | 10/86 → 12/95 | D | LD20 |
|----|---------------|---|------|

| | | | |
|----|---------------|---|------|
| 49 | 10/86 → 12/95 | D | LD20 |
|----|---------------|---|------|

Vanette III Cargo

| | | | | |
|-------|----|---------|---|------|
| 2.0 D | 49 | 01/96 → | D | LD20 |
|-------|----|---------|---|------|

82055
350982055000

| | |
|-------------------------|---------|
| FLANGIA | |
| Numero Fori Flangia | 4 |
| Dimensione Fori Flangia | M8×1.25 |
| Posizione Attacco | 64.5 |
| Diametro Mozzo | Ø28 |
| Diametro Girante | Ø55 |
| N° Alette Girante | 7 |
| Posizione Girante | 24.5 |

LEXUS
HS

| | | | | |
|------|-----|---------|--|---------|
| 250h | 110 | 07/09 → | | 2AZ-FXE |
|------|-----|---------|--|---------|

TOYOTA
Avensis I, Liftback, Station Wagon

| | | | | |
|-----------|-----|---------------|---|---------|
| 2.0 VVT-i | 110 | 10/00 → 02/03 | B | 1AZ-FSE |
|-----------|-----|---------------|---|---------|

| | | | | |
|-----|-----|---------------|---|---------|
| 2.0 | 108 | 04/03 → 11/08 | B | 1AZ-FSE |
|-----|-----|---------------|---|---------|

| | | | | |
|----------|-----|---------------|---|--------|
| 2.0 VVTi | 114 | 04/03 → 11/08 | B | 1AZ-FE |
|----------|-----|---------------|---|--------|

| | | | | |
|-----|-----|---------------|---|---------|
| 2.4 | 120 | 10/03 → 11/08 | B | 2AZ-FSE |
| | 125 | 09/03 → 11/08 | B | 2AZ-FSE |

| | | | | |
|-----|-----|---------------|---|---------|
| 2.4 | 125 | 09/03 → 11/08 | B | 2AZ-FSE |
|-----|-----|---------------|---|---------|

Avensis Verso

| | | | | |
|-----------|-----|---------------|---|--------|
| 2.0 VVT-i | 110 | 08/01 → 11/09 | B | 1AZ-FE |
|-----------|-----|---------------|---|--------|

| | | | | |
|--------------|-----|---------------|---|--------|
| 2.4 VVTi GLS | 115 | 10/03 → 11/09 | B | 2AZ-FE |
|--------------|-----|---------------|---|--------|

| | | | | |
|--------------|-----|---------------|---|--------|
| 2.4 VVTi GLS | 115 | 10/03 → 11/09 | B | 2AZ-FE |
|--------------|-----|---------------|---|--------|

Camry IV

| | | | | |
|----------|-----|---------------|---|--------|
| 2.0 VVTi | 110 | 08/01 → 11/06 | B | 1AZ-FE |
|----------|-----|---------------|---|--------|

| | | | | |
|-----------|-----|---------------|---|--------|
| 2.4 VVT-i | 112 | 11/01 → 11/06 | B | 2AZ-FE |
|-----------|-----|---------------|---|--------|

| | | | | |
|-----------------|-----|---------------|---|---------|
| 2.4 VVTi Hybrid | 105 | 01/06 → 11/06 | B | 2AZ-FXE |
|-----------------|-----|---------------|---|---------|

| | | | | |
|-----------------|-----|---------------|---|---------|
| 2.4 VVTi Hybrid | 105 | 01/06 → 11/06 | B | 2AZ-FXE |
|-----------------|-----|---------------|---|---------|

Camry V

| | | | | |
|----------|-----|---------------|---|--------|
| 2.4 VVTi | 116 | 01/06 → 09/11 | B | 2AZ-FE |
|----------|-----|---------------|---|--------|

| | | | | |
|----------|-----|---------------|---|--------|
| 2.4 VVTi | 123 | 01/06 → 09/11 | B | 2AZ-FE |
|----------|-----|---------------|---|--------|

Previa II

| | | | | |
|-----|-----|---------------|---|--------|
| 2.4 | 115 | 08/00 → 01/06 | B | 2AZ-FE |
|-----|-----|---------------|---|--------|

| | | | | |
|---------|----|---------------|---|---------|
| 2.4 4WD | 96 | 07/02 → 12/05 | B | 2AZ-FXE |
|---------|----|---------------|---|---------|

Previa III

| | | | | |
|-----|-----|---------|---|--------|
| 2.4 | 125 | 10/05 → | B | 2AZ-FE |
|-----|-----|---------|---|--------|

RAV 4 II

| | | | | |
|--------------|-----|---------------|---|--------|
| 2.0 VVTi 4WD | 110 | 06/00 → 11/05 | B | 1AZ-FE |
|--------------|-----|---------------|---|--------|

| | | | | |
|--------------|-----|---------------|---|--------|
| 2.4 VVTi 4WD | 112 | 08/03 → 11/05 | B | 2AZ-FE |
|--------------|-----|---------------|---|--------|

| | | | | |
|--------------|-----|---------------|---|--------|
| 2.4 VVTi 4WD | 112 | 08/03 → 11/05 | B | 2AZ-FE |
|--------------|-----|---------------|---|--------|

| | | | | |
|--------------|-----|---------------|---|--------|
| 2.4 VVTi 4WD | 112 | 08/03 → 11/05 | B | 2AZ-FE |
|--------------|-----|---------------|---|--------|

RAV 4 III

| | | | | |
|---------------|-----|---------|---|--------|
| 2.0 VVT-i 4WD | 112 | 03/06 → | B | 1AZ-FE |
|---------------|-----|---------|---|--------|

| | | | | |
|----------|-----|---------|---|--------|
| 2.4 VVTi | 125 | 11/05 → | B | 2AZ-FE |
|----------|-----|---------|---|--------|

| | | | | |
|--------------|-----|---------|---|--------|
| 2.4 VVTi 4WD | 125 | 11/05 → | B | 2AZ-FE |
|--------------|-----|---------|---|--------|

| | | | | |
|--------------|-----|---------|---|--------|
| 2.4 VVTi 4WD | 125 | 11/05 → | B | 2AZ-FE |
|--------------|-----|---------|---|--------|

82056
350982056000

PULEGGIA

| | |
|----------------------------|-------|
| Diametro Puleggia | 56.24 |
| Numero Denti/Gole Puleggia | 19 |
| Altezza Puleggia | 30 |
| Posizione Attacco | 62.2 |
| Diametro Girante | 71 |
| N° Alette Girante | 7 |
| Posizione Girante | 14 |

KW

FORD
Focus II, Station Wagon, Cabrio

| | | | | |
|------------|-----|---------------|---|------|
| 2.5 RS | 224 | 01/09 → 07/11 | B | JZDA |
| 2.5 RS 500 | 257 | 05/10 → 07/11 | B | JZDA |
| 2.5 ST | 166 | 10/05 → 09/12 | B | HYDA |

Kuga I

| | | | | |
|---------|-----|---------------|---|------------|
| 2.5 | 147 | 03/09 → 11/12 | B | HYDB, HYDC |
| 2.5 4x4 | 147 | 03/09 → | B | HYDB |

Mondeo IV, Station Wagon

| | | | | |
|-----|-----|---------------|---|------|
| 2.5 | 162 | 03/07 → 09/14 | B | HUBA |
|-----|-----|---------------|---|------|

S-Max

| | | | | |
|--------|-----|---------|---|------|
| 2.5 ST | 162 | 05/06 → | B | HUWA |
|--------|-----|---------|---|------|

RENAULT
Laguna I, Grantour

| | | | | |
|---------|-----|---------------|---|----------------|
| 2.0 | 103 | 06/95 → 02/01 | B | N7Q700, N7Q704 |
| 2.0 16V | 102 | 06/95 → 03/01 | B | N7Q700, N7Q704 |

VOLVO
850, Station Wagon

| | | | | |
|-------------|-----|---------------|---|-----------------|
| 2.0 | 93 | 08/94 → 12/96 | B | B5202S |
| | 105 | 06/91 → 12/96 | B | B5204F |
| 2.0 Turbo | 132 | 09/93 → 10/96 | B | B5204T2 |
| | 155 | 08/93 → 12/96 | B | B5204FT, B5204T |
| 2.3 | 106 | 01/96 → 10/96 | B | B5234FS |
| 2.3 T5 | 166 | 08/93 → 07/96 | B | B5234FT |
| 2.3 T5 R | 176 | 04/96 → 10/96 | B | B5234T2 |
| | 184 | 08/95 → 12/96 | B | B5234T4 |
| 2.3 Turbo R | 177 | 06/95 → 10/96 | B | B5234T5 |
| 2.4 GLE | 142 | 09/93 → 10/97 | B | B5254T |
| 2.5 | 103 | 06/91 → 07/94 | B | B5252 |
| | 106 | 08/94 → 12/96 | B | B5252FS |
| | 125 | 08/91 → 12/96 | B | B5254S |
| 2.5 AWD | 142 | 04/96 → 12/96 | B | B5254T |

82056
350982056000

KW

VOLVO
C 30

| | | | | |
|-------|-----|---------------|---|---------|
| 2.4 i | 125 | 10/06 → 12/12 | B | B5244S4 |
| | 162 | 10/06 → 12/12 | B | B5254T3 |
| T5 | 169 | 03/07 → 12/12 | B | B5254T7 |

C 70 I, Cabrio, Coupé

| | | | | |
|--------|-----|---------------|---|----------------|
| 2.0 | 132 | 03/98 → 10/05 | B | B5204T2 |
| | 120 | 03/00 → 10/05 | B | B5204T4 |
| 2.0 T | 166 | 03/98 → 10/05 | B | B5204T3 |
| | 176 | 03/98 → 10/05 | B | B5234T3 |
| 2.3 T5 | 180 | 07/02 → 10/05 | B | B5234T9 |
| | 176 | 03/97 → 09/02 | B | B5234T3 |
| 2.4 T | 147 | 07/02 → 10/05 | B | B5244T7 |
| | 121 | 03/99 → 09/02 | B | B5254S |
| 2.5 | 125 | 05/99 → 09/02 | B | B5244S, B5254S |
| | 125 | 06/98 → 10/05 | B | B5254S |
| 2.5 T | 142 | 03/98 → 10/05 | B | B5244T, B5254T |

C 70 II

| | | | | |
|-------|-----|---------------|---|---------|
| 2.4 | 103 | 03/06 → 10/09 | B | B5244S5 |
| 2.4 i | 125 | 03/06 → 10/09 | B | B5244S4 |
| | 162 | 03/06 → 02/07 | B | B5254T3 |
| T5 | 169 | 03/07 → 10/09 | B | B5254T7 |

S 40 I

| | | | | | |
|--------|-----|---------------|---|------------------|----------|
| 1.6 | 80 | 03/99 → 12/03 | B | B4164S2 | |
| | 77 | 09/95 → 08/99 | B | B4164S | |
| 1.8 | 85 | 07/95 → 08/99 | B | B4184S, B4184S3 | |
| | 85 | 06/01 → 08/03 | | B4184S2 | |
| 1.8 i | 90 | 03/99 → 12/03 | B | B4184S2, B4184S9 | |
| | 90 | 06/01 → 12/03 | B | B4184SJ | |
| 1.9 T4 | 147 | 05/97 → 07/00 | B | B4194T, B4194T2 | |
| 2.0 | 100 | 07/95 → 12/03 | B | B4204S, B4204S2 | 11-1995→ |
| | 100 | 07/95 → 12/03 | B | B4204S, B4204S2 | |
| | 103 | 07/95 → 08/99 | B | B4204S | 11-1995→ |
| 2.0 T | 103 | 07/95 → 08/99 | B | B4204S | |
| | 118 | 10/97 → 12/03 | B | B4204T | |
| | 120 | 06/01 → 12/03 | B | B4204T3 | |
| 2.0 T4 | 121 | 07/00 → 06/01 | B | B4204T2, B4204T3 | |
| | 147 | 07/00 → 12/03 | B | B4204T5 | |

82056
350982056000

VOLVO
S 40 II

| | | | | |
|--------------|-----|---------|---|----------|
| 1.6 | 74 | 01/05 → | B | B4164S3 |
| 1.8 | 92 | 04/04 → | B | B4184S11 |
| 1.8 FlexFuel | 92 | 01/06 → | | B4184S8 |
| 2.4 | 103 | 01/04 → | B | B5244S5 |
| | 125 | 01/04 → | B | B5244S4 |
| 2.4 AWD | 125 | 08/06 → | B | B5244S4 |
| T5 | 162 | 01/04 → | B | B5254T3 |
| | 169 | 03/07 → | B | B5254T7 |
| T5 AWD | 162 | 04/04 → | B | B5254T3 |
| T5 AWD | 169 | 03/07 → | B | B5254T7 |

S 60 I

| | | | | |
|------------|-----|---------------|----|----------|
| 2.0 T | 132 | 07/00 → 04/10 | B | B5204T5 |
| 2.3 T5 | 195 | 07/00 → 09/02 | B | B5234T7 |
| 2.4 | 103 | 11/00 → 04/10 | B | B5244S2 |
| | 125 | 11/00 → 04/10 | B | B5244S |
| 2.4 AWD | 191 | 02/04 → 04/10 | B | B5244T5 |
| 2.4 Bifuel | 103 | 06/02 → 04/10 | BF | B5244SG |
| | 103 | 06/02 → 04/10 | BF | B5244SG2 |
| 2.4 T | 147 | 11/00 → 04/10 | B | B5244T3 |
| 2.4 T AWD | 147 | 11/01 → 04/10 | B | B5244T3 |
| 2.4 T5 | 191 | 04/04 → 04/10 | B | B5244T5 |
| 2.5 T | 154 | 02/04 → 04/10 | B | B5254T2 |
| 2.5 T AWD | 154 | 04/04 → 04/10 | B | B5254T2 |
| R2,5TAWD | 221 | 03/03 → 04/10 | B | B5254T4 |
| T5 | 184 | 11/00 → 04/10 | B | B5234T3 |

S 60 II

| | | | | |
|------------|-----|---------|---|---------|
| 2.0 T | 132 | 12/13 → | B | B5204T8 |
| 2.5 T5 | 186 | 09/11 → | B | B5254T5 |
| 2.5 T5 AWD | 186 | 09/12 → | B | B5254T5 |

S 70

| | | | | |
|---------------|-----|---------------|---|--------------------|
| 2.0 | 93 | 01/97 → 11/00 | B | B5202FS, B5202S |
| | 105 | 01/97 → 11/00 | B | B5204F |
| | 120 | 01/97 → 11/00 | B | B5204T4 |
| | 132 | 01/97 → 11/00 | B | B5204T2 |
| 2.0 Turbo | 155 | 01/97 → 11/00 | B | B5204T |
| | 166 | 01/97 → 11/00 | B | B5204T3 |
| 2.3 | 195 | 04/99 → 09/00 | B | B5234T7 |
| 2.3 T-5 | 176 | 01/97 → 11/00 | B | B5234T3 |
| 2.3 T5 AWD | 177 | 11/96 → 09/98 | B | B5234T3 |
| | 184 | 07/97 → 09/00 | B | B5234T4 |
| 2.3 Turbo | 184 | 01/97 → 11/00 | B | B5234FT+ |

82056
350982056000

VOLVO
S 70

| | | | | |
|--------------|-----|---------------|----|---------------------|
| 2.4 | 103 | 08/99 → 11/00 | B | B5244S2, B5244SG |
| | 125 | 01/97 → 11/00 | B | B5244S, B5254S |
| 2.4 AWD | 103 | 04/99 → 09/00 | B | B5244S2 |
| | 106 | 11/96 → 05/99 | B | B5252FS |
| | 121 | 10/98 → 05/99 | B | B5254S |
| | 125 | 04/99 → 09/00 | B | B5244S |
| 2.4 Blu-Fuel | 103 | 07/97 → 09/00 | G | B5244S2, B5244SG |
| 2.4 T5 AWD | 142 | 11/96 → 04/99 | B | B5254T |
| 2.4 Turbo | 142 | 01/97 → 11/00 | B | B5244T, B5254T |
| 2.5 | 106 | 01/97 → 11/00 | B | B5252FS |
| | 121 | 06/98 → 11/00 | B | B5254S |
| 2.5 Bifuel | 103 | 07/99 → 11/00 | BF | B5244SG |
| | 106 | 10/98 → 11/00 | BF | GB5252S |

S 80 I

| | | | | |
|------------|-----|---------------|----|----------|
| 2.0 | 120 | 06/98 → 07/06 | B | B5204T4 |
| 2.0 T | 132 | 12/99 → 07/06 | B | B5204T5 |
| | 166 | 06/98 → 07/06 | B | B5204T3 |
| 2.4 | 103 | 01/99 → 07/06 | B | B5244S2 |
| | 125 | 01/99 → 07/06 | B | B5244S |
| 2.4 Bifuel | 103 | 09/01 → 07/06 | BF | B5244SG |
| | 103 | 09/01 → 07/06 | BF | B5244SG2 |
| 2.4 LTP | 132 | 06/04 → 07/06 | B | B5244T4 |
| 2.4 T | 147 | 06/00 → 07/06 | B | B5244T3 |
| 2.4 T5 AWD | 147 | 04/00 → 09/03 | B | B5244T3 |
| 2.5 T | 154 | 03/03 → 07/06 | B | B5254T2 |
| 2.5 T AWD | 154 | 07/03 → 07/06 | B | B5254T2 |

S 80 II

| | | | | |
|-------------------|-----|---------|---|----------|
| 2.5 T | 183 | 09/12 → | B | B5254T14 |
| | 187 | 01/12 → | B | B5254T12 |
| | 147 | 03/06 → | B | B5254T6 |
| | 170 | 01/10 → | B | B5254T10 |
| 2.5 T AWD | 147 | 10/06 → | B | B5254T6 |
| 2.5 T FlexFuel | 147 | 05/08 → | | B5254T8 |
| | 170 | 01/10 → | | B5254T11 |

V 40 I

| | | | | |
|-----|----|---------------|---|---------------------|
| 1.6 | 80 | 03/99 → 06/04 | B | B4164S2 |
| | 77 | 12/95 → 08/99 | B | B4164S |
| 1.8 | 85 | 07/95 → 08/99 | B | B4184S, B4184S3 |
| | 90 | 03/99 → 06/04 | B | B4184S2, B4184S9 |

82056
350982056000

VOLVO
V 40 I

| | | | | | |
|--------|-----|---------------|---|--------------------|--|
| 1.8 i | 90 | 06/01 → 06/04 | B | B4184SJ | |
| 1.9 T4 | 147 | 05/97 → 07/00 | B | B4194T | |
| 2.0 | 100 | 07/95 → 06/04 | B | B4204S, B4204S2 | |
| | 103 | 07/95 → 08/99 | B | B4204S | |
| 2.0 T | 118 | 10/97 → 07/00 | B | B4204T | |
| | 120 | 06/01 → 06/04 | B | B4204T3 | |
| | 121 | 07/99 → 06/04 | B | B4204T2 | |
| 2.0 T4 | 147 | 07/00 → 06/04 | B | B4204T5 | |

V 40 II

| | | | | | |
|--------|-----|---------|---|----------|--|
| T4 | 132 | 07/13 → | B | B5204T8 | |
| T4 AWD | 132 | 07/13 → | B | B5204T8 | |
| T5 | 157 | 03/13 → | B | B5204T9 | |
| | 183 | 01/14 → | B | B5254T14 | |
| | 187 | 12/12 → | B | B5254T12 | |
| T5 AWD | 157 | 03/13 → | B | B5204T9 | |
| | 187 | 01/13 → | B | B5254T12 | |

V 50

| | | | | | |
|---------|-----|---------|---|---------|--|
| 2.4 | 103 | 04/04 → | B | B5244S5 | |
| | 125 | 04/04 → | B | B5244S4 | |
| 2.4 AWD | 125 | 08/06 → | B | B5244S4 | |
| T5 | 162 | 04/04 → | B | B5254T3 | |
| | 169 | 03/07 → | B | B5254T7 | |
| T5 AWD | 162 | 04/04 → | B | B5254T3 | |
| | 169 | 03/07 → | B | B5254T7 | |

V 60

| | | | | | |
|----|-----|---------|---|---------|--|
| T5 | 157 | 04/14 → | B | B5204T9 | |
|----|-----|---------|---|---------|--|

V 70 I

| | | | | | |
|---------------|-----|---------------|---|----------------------|-----------|
| 2.0 | 93 | 01/97 → 03/00 | B | B5202S | |
| | 105 | 01/97 → 03/00 | B | B5204F | 11-1996 → |
| | 105 | 01/97 → 03/00 | B | B5204F | |
| | 120 | 01/97 → 03/00 | B | B5204T4 | |
| | 132 | 01/97 → 03/00 | B | B5204T2 | |
| 2.0 Turbo | 155 | 01/97 → 03/00 | B | B5204T | |
| | 166 | 01/97 → 03/00 | B | B5204T3 | |
| 2.0 Turbo AWD | 166 | 01/97 → 03/00 | B | B5204T3 | |
| 2.3 | 177 | 11/96 → 11/00 | B | B5234T3 | |
| 2.3 AWD | 177 | 04/97 → 09/98 | B | B5234T3 | |
| | 195 | 12/98 → 02/00 | B | B5234T7, B5234T8 | |
| 2.3 T AWD | 184 | 04/97 → 03/00 | B | B5234FT+, B5234T4 | |
| 2.3 T-5 | 176 | 01/97 → 03/00 | B | B5234T3 | |

82056
350982056000

VOLVO
V 70 I

| | | | | | |
|---------------|-----|---------------|----|----------------------|--|
| 2.3 T-5 AWD | 176 | 01/97 → 03/00 | B | B5234T3 | |
| 2.3 Turbo | 184 | 01/97 → 03/00 | B | B5234FT+ | |
| 2.4 | 103 | 08/99 → 05/00 | B | B5244S2, B5244SG2 | |
| | 125 | 01/97 → 05/00 | B | B5244S, B5254S | |
| 2.4 AWD | 121 | 10/98 → 05/99 | B | B5254S | |
| 2.4 Bifuel | 103 | 08/99 → 03/00 | BF | B5244SG | |
| 2.4 Turbo | 142 | 01/97 → 03/00 | B | B5244T, B5254T | |
| 2.5 | 106 | 01/97 → 03/00 | B | B5252FS | |
| | 121 | 06/98 → 03/00 | B | B5254S | |
| 2.5 AWD | 195 | 03/99 → 03/00 | B | B5244T2 | |
| 2.5 Bifuel | 106 | 10/98 → 08/99 | BF | GB5252S | |
| 2.5 Turbo AWD | 142 | 01/97 → 05/00 | B | B5244T, B5254T | |

V 70 II

| | | | | | |
|-------------|-----|---------------|----|----------------------|--|
| 2.0 T | 132 | 07/01 → 08/07 | B | B5204T5 | |
| 2.3 | 195 | 10/00 → 09/04 | B | B5234T7 | |
| 2.3 AWD | 195 | 10/00 → 09/04 | B | B5234T7, B5234T8 | |
| 2.3 T5 | 184 | 03/00 → 08/04 | B | B5234T3, B5234T4 | |
| 2.4 | 103 | 03/00 → 08/07 | B | B5244S2 | |
| | 121 | 03/00 → 09/03 | B | B5254S | |
| | 125 | 03/00 → 08/07 | B | B5244S | |
| 2.4 Bifuel | 103 | 09/01 → 08/07 | BF | B5244SG, B5244SG2 | |
| | 103 | 09/01 → 08/07 | BF | B5244SG2 | |
| 2.4 T | 147 | 03/00 → 08/03 | B | B5244T3 | |
| 2.4 T AWD | 147 | 09/01 → 08/02 | B | B5244T3 | |
| 2.4 T5 | 191 | 04/04 → 08/07 | B | B5244T5 | |
| 2.5 R Sport | 221 | 12/02 → 08/07 | B | B5254T4 | |
| 2.5 T | 154 | 04/04 → 08/07 | B | B5254T2 | |
| 2.5 T AWD | 154 | 09/02 → 08/07 | B | B5254T2 | |
| R2,5 T AWD | 221 | 03/03 → 08/07 | B | B5254T4 | |

V 70 III

| | | | | | |
|-----------------|-----|---------|----|----------|--|
| 2.0 BiFuel | 157 | 03/13 → | BF | B5204T9 | |
| 2.5 T | 147 | 08/07 → | B | B5254T6 | |
| | 170 | 01/10 → | B | B5254T10 | |
| 2.5 T FlexiFuel | 147 | 05/08 → | | B5254T8 | |
| 2.5 T FlexiFuel | 170 | 10/09 → | | B5254T11 | |

82056 350982056000



VOLVO

XC 60

| | | | | |
|---------------------|-----|---------|---|-----------------------------------|
| 2.4 D / D3 / D4 AWD | 120 | 05/08 → | D | D5244T16, D5244T17, D5244T5 |
| D5 AWD | 136 | 05/08 → | D | D5244T4 |
| T5 AWD | 187 | 04/14 → | B | B5254T12 |

XC 70 I Cross Country

| | | | | |
|--------------|-----|---------------|---|---------|
| 2.4 T XC AWD | 142 | 11/97 → 09/02 | B | B5254T |
| | 147 | 03/00 → 09/02 | B | B5244T3 |
| 2.5 T XC AWD | 154 | 09/02 → 08/07 | B | B5254T2 |

XC 70 II

| | | | | |
|--------|-----|---------|---|----------|
| T5 AWD | 187 | 08/15 → | B | B5254T12 |
|--------|-----|---------|---|----------|

XC 90 I

| | | | | |
|-------|-----|---------|---|---------|
| 2.5 T | 154 | 10/02 → | B | B5254T2 |
|-------|-----|---------|---|---------|

82057 350982057000



PULEGGIA

Diametro Puleggia Ø137.5

Numero Denti/Gole Puleggia 7

Altezza Puleggia 27.3

Posizione Attacco 130.9

Diametro Girante Ø78.6

N° Alette Girante 8

Posizione Girante 12.1



FORD

Transit VII

| | | | | |
|--------------|-----|---------------|---|---------------------|
| | 55 | 01/00 → 05/06 | D | F4FA |
| 2.4 DI | 66 | 01/00 → 05/06 | D | D2FA, D2FB, D2FE |
| | 88 | 01/00 → 05/06 | D | D4FA |
| 2.4 DI [RWD] | 55 | 01/00 → 05/06 | D | F4FA |
| | 88 | 01/00 → 05/06 | D | D4FA |
| 2.4 TD | 55 | 08/00 → 08/03 | D | F4FA |
| 2.4 TDCi | 101 | 03/04 → 05/06 | D | H9FA |
| 2.4 TDdi | 66 | 10/01 → 03/06 | D | D2FE |
| | 88 | 08/00 → 08/03 | D | D4FA |
| 2.4 TDE | 85 | 03/04 → 05/06 | D | FXFA |
| | 92 | 07/01 → 05/06 | D | DOFA |
| | 92 | 07/01 → 05/06 | D | DOFA |

82057 350982057000



FORD

Transit XIII

| | | | | |
|----------------|-----|---------------|---|------------|
| 2.4 TDCi | 74 | 04/06 → 08/14 | D | PHFA, PHFC |
| | 85 | 04/06 → 08/14 | D | JXFA, JXFC |
| | 103 | 04/06 → 08/14 | D | H9FD |
| 2.4 TDCi [RWD] | 74 | 04/06 → 08/14 | D | PHFA, PHFC |
| | 85 | 04/06 → 08/14 | D | JXFA, JXFC |
| | 103 | 04/06 → 08/14 | D | H9FB, H9FD |
| 2.4 TDCi 4x4 | 103 | 04/06 → 08/14 | D | H9FD |
| | 103 | 11/06 → 08/14 | D | H9FB |

LAND ROVER

Defender Cabrio, Station Wagon, Pickup

| | | | | |
|-------------|----|---------|---|---------|
| 2.4 Td4 4x4 | 90 | 05/07 → | D | ZSD-424 |
|-------------|----|---------|---|---------|

82058 350982058000



PULEGGIA

Diametro Puleggia Ø88

Numero Denti/Gole Puleggia 7

Altezza Puleggia 26.4

Posizione Attacco 92

Diametro Girante Ø71.6

N° Alette Girante 6

Posizione Girante 11.8



CHRYSLER

300 C, Touring

| | | | | |
|---------|-----|---------------|---|-----|
| 3.0 CRD | 160 | 09/05 → 11/12 | D | EXL |
|---------|-----|---------------|---|-----|

JEEP

Commander

| | | | | |
|-------------|-----|---------------|---|-----|
| 3.0 CRD 4x4 | 160 | 04/06 → 12/10 | D | EXL |
|-------------|-----|---------------|---|-----|

Grand Cherokee III

| | | | | |
|-------------|-----|---------------|---|-----|
| 3.0 CRD 4x4 | 155 | 05/06 → 12/10 | D | EXL |
| | 160 | 06/05 → 12/10 | D | EXL |

MERCEDES-BENZ

Classe C II (W203), Station Wagon (S203), Coupé (CL203)

| | | | | |
|-----------|-----|---------------|---|-----------|
| C 320 CDI | 165 | 01/05 → 02/07 | D | OM642.910 |
|-----------|-----|---------------|---|-----------|

Classe C III (W204), Station Wagon (S204), Coupé (C204)

| | | | | |
|-------------------|-----|---------------|---|-----------|
| C 300 CDI 4-matic | 170 | 01/11 → 01/14 | D | OM642.832 |
| C 320 CDI | 165 | 01/07 → 01/14 | D | OM642.960 |

82058
350982058000

MERCEDES-BENZ
Classe C III (W204), Station Wagon (S204), Coupé (C204)

| | | | | |
|-------------------|-----|---------------|---|-----------|
| C 320 CDI 4-matic | 165 | 07/07 → 01/14 | D | OM642.961 |
| C 350 CDI | 165 | 08/07 → 08/14 | D | OM642.830 |
| | 165 | 07/09 → 01/14 | D | OM642.960 |
| | 170 | 10/09 → 01/14 | D | OM642.830 |
| C 350 CDI 4-matic | 165 | 07/09 → 01/14 | D | OM642.961 |
| | 170 | 10/09 → 01/14 | D | OM642.832 |

Classe E III (W211), Station Wagon (S211)

| | | | | |
|---------------------|-----|---------------|---|-----------|
| E 280 CDI | 140 | 03/05 → 12/08 | D | OM642.920 |
| E 280 CDI 4-matic | 140 | 03/05 → 12/08 | D | OM642.921 |
| E 280 T CDI | 140 | 03/05 → 07/09 | D | OM642.920 |
| E 280 T CDI 4-matic | 140 | 03/05 → 07/09 | D | OM642.921 |
| E 300 BlueTEC | 155 | 09/07 → 12/08 | D | OM642.920 |
| E 320 CDI | 165 | 03/05 → 12/08 | D | OM642.920 |
| E 320 CDI 4-matic | 165 | 03/05 → 12/08 | D | OM642.910 |
| E 320 T CDI | 165 | 03/05 → 07/09 | D | OM642.920 |
| E 320 T CDI 4-matic | 165 | 03/05 → 07/09 | D | OM642.920 |

Classe E IV (W212), Station Wagon (S212), Cabrio (A207), Coupé (C207)

| | | | | |
|---------------------|-----|---------------|---|----------------------|
| E 300 CDI | 150 | 12/09 → 12/10 | D | OM642.850 |
| E 300 CDI / BlueTEC | 170 | 03/11 → | D | OM642.850, OM642.852 |
| E 350 CDI | 155 | 01/09 → | D | OM642.850 |
| | 170 | 01/10 → | D | OM642.836 |
| | 170 | 01/09 → | D | OM642.850 |
| | 170 | 11/09 → | D | OM642.850, OM642.852 |
| E 350 CDI 4-matic | 170 | 09/09 → | D | OM642.856 |

Classe G (W460, W461), Cabrio (W463)

| | | | | |
|-----------|-----|---------|---|-----------|
| G 280 CDI | 135 | 04/09 → | D | OM642.884 |
| G 300 CDI | 135 | 04/10 → | D | OM642.884 |
| G 350 CDI | 155 | 07/11 → | D | OM642.886 |
| G 350 d | 180 | 06/15 → | D | OM642.887 |

82058
350982058000

MERCEDES-BENZ
Classe GL I (X164)

| | | | | |
|----------------------------------|-----|---------|---|-----------|
| GL 320 CDI / 350 BlueTEC 4-matic | 155 | 12/09 → | D | OM642.820 |
| GL 350 CDI 4-matic | 195 | 10/10 → | D | OM642.822 |

Classe GL II (X166)

| | | | | |
|------------------------------|-----|---------|---|-----------|
| GL 350 CDI / BlueTEC 4-matic | 190 | 07/12 → | D | OM642.826 |
|------------------------------|-----|---------|---|-----------|

Classe GLK (X204)

| | | | | |
|-----------------|-----|---------------|---|-----------|
| 320 CDI 4-matic | 165 | 06/08 → | D | OM642.961 |
| 350 CDI 4-matic | 165 | 07/09 → 01/10 | D | OM642.832 |
| | 170 | 02/10 → 05/10 | D | OM642.832 |

Classe M II (W164)

| | | | | |
|--------------------|-----|---------|---|-----------|
| ML 300 CDI 4-matic | 150 | 02/10 → | D | OM642.820 |
| ML 350 CDI 4-matic | 155 | 09/09 → | D | OM642.820 |

Classe M III (166)

| | | | | |
|------------------------|-----|---------|---|-----------|
| ML 350 BlueTEC 4-matic | 190 | 06/11 → | D | OM642.826 |
|------------------------|-----|---------|---|-----------|

Classe R (W251, V251)

| | | | | | |
|-------------------|-----|---------|---|---------------------------------|-----------|
| R 280 CDI | 140 | 05/06 → | D | OM642.870, OM642.872, OM642.950 | → 10-2007 |
| R 280 CDI 4-matic | 140 | 05/06 → | D | OM642.950 | → 10-2007 |
| R 320 CDI 4-matic | 155 | 01/06 → | D | OM642.870, OM642.950 | |
| | 165 | 01/06 → | D | OM642.950 | → 10-2007 |

Classe S VI (W221), Coupé (C216)

| | | | | |
|-----------------------|-----|---------------|---|-----------|
| S 320 CDI | 155 | 10/05 → 12/13 | D | OM642.930 |
| S 320 CDI 4-matic | 155 | 10/05 → 12/13 | D | OM642.932 |
| S 350 BlueTec | 190 | 04/11 → 12/13 | D | OM642.862 |
| S 350 BlueTEC 4-matic | 190 | 04/11 → 12/13 | D | OM642.868 |
| S 350 CDI | 173 | 06/09 → 12/13 | D | OM642.930 |

82058
350982058000

KW

MERCEDES-BENZ
CLK II (C209), Cabrio (A209)

| | | | | |
|------------|-----|---------------|---|-----------|
| 320 CDI | 165 | 01/05 → 05/09 | D | OM642.910 |
| CLK320 CDI | 165 | 03/05 → 03/10 | D | OM642.910 |

CLS I (C219)

| | | | | |
|-------------|-----|---------------|---|-----------|
| CLS 320 CDI | 155 | 01/05 → 12/10 | D | OM642.920 |
| CLS 350 CDI | 200 | 04/09 → 12/10 | D | OM642.920 |
| | 165 | 04/09 → 12/10 | D | OM642.920 |

Sprinter III (906)

| | | | | |
|-----------------------|-----|---------|---|---------------------------------------|
| 218 CDI | 135 | 06/06 → | D | OM642.896, OM642.992 |
| 219 CDI / BlueTEC | 140 | 03/09 → | D | OM642.896, OM642.992 |
| 318 CDI | 135 | 02/08 → | D | OM642.896, OM642.992, OM642.993 |
| 318 CDI 4x4 | 135 | 02/08 → | D | OM642.896, OM642.992, OM642.993 |
| 319 CDI / BlueTEC | 140 | 03/09 → | D | OM642.896, OM642.898, OM642.992 |
| 319 CDI / BlueTEC 4x4 | 140 | 03/09 → | D | OM642.896, OM642.898, OM642.992 |
| 418 CDI | 135 | 06/09 → | D | OM642.896, OM642.992 |
| | 135 | 06/06 → | D | OM642.896, OM642.992, OM642.993 |
| 419 CDI | 140 | 03/09 → | D | OM642.896, OM642.898, OM642.992 |
| | 140 | 03/09 → | D | OM642.992 |
| 518 CDI | 135 | 06/06 → | D | OM642.896, OM642.992, OM642.993 |
| 518 CDI 4x4 | 135 | 06/06 → | D | OM642.896, OM642.992, OM642.993 |
| 519 CDI / BlueTEC | 140 | 03/09 → | D | OM642.896, OM642.898, OM642.992 |
| 519 CDI / BlueTEC 4x4 | 140 | 03/09 → | D | OM642.896, OM642.898, OM642.992 |

82058
350982058000

KW

MERCEDES-BENZ
Vito II (W639) - Viano

| | | | | |
|---------|-----|---------|---|-----------|
| 120 CDI | 150 | 07/06 → | D | OM642.990 |
| | 165 | 09/10 → | D | OM642.890 |
| CDI 3.0 | 150 | 03/06 → | D | OM642.990 |
| | 165 | 07/10 → | D | OM642.990 |

82059
350982059000

PULEGGIA

| | |
|----------------------------|-------|
| Diametro Puleggia | Ø88 |
| Numero Denti/Gole Puleggia | 8 |
| Altezza Puleggia | 29.9 |
| Posizione Attacco | 62 |
| Diametro Girante | Ø71.5 |
| N° Alette Girante | 6 |
| Posizione Girante | 11.4 |

KW

MERCEDES-BENZ
Classe G (W460, W461), Cabrio (W463)

| | | | | |
|-----------|-----|---------|---|-----------|
| G 320 CDI | 165 | 09/06 → | D | OM642.970 |
|-----------|-----|---------|---|-----------|

Classe GL I (X164)

| | | | | |
|--------------------|-----|---------------|---|-----------|
| GL 320 CDI 4-matic | 165 | 09/06 → 05/09 | D | OM642.940 |
| GL 350 CDI 4-matic | 165 | 05/09 → | D | OM642.940 |

Classe M II (W164)

| | | | | |
|--------------------|-----|---------------|---|-----------|
| ML 280 CDI 4-matic | 140 | 07/05 → 07/09 | D | OM642.940 |
| ML 300 CDI 4-matic | 140 | 07/09 → | D | OM642.940 |
| ML 320 CDI 4-matic | 165 | 07/05 → 07/09 | D | OM642.940 |
| ML 350 CDI 4-matic | 165 | 07/09 → | D | OM642.940 |
| | 170 | 02/10 → | D | OM642.820 |

Classe R (W251, V251)

| | | | | | |
|-------------------|-----|---------|---|---------------------------------------|-----------|
| R 280 CDI | 140 | 05/06 → | D | OM642.870, OM642.872, OM642.950 | 11-2007 → |
| R 280 CDI 4-matic | 140 | 05/06 → | D | OM642.950 | 11-2007 → |
| R 300 CDI | 140 | 07/09 → | D | OM642.870, OM642.872, OM642.950 | |
| R 300 CDI 4-matic | 140 | 07/09 → | D | OM642.950 | |

82059 350982059000

MERCEDES-BENZ
Classe R (W251, V251)

| | | | | | |
|-------------------|-----|---------|---|-------------------------|-----------|
| R 320 CDI 4-matic | 165 | 01/06 → | D | OM642.950 | 11-2007 → |
| R 350 CDI 4-matic | 155 | 01/06 → | D | OM642.870, OM642.950 | |
| | 165 | 07/09 → | D | OM642.950 | |

Classe S VI (W221), Coupé (C216)

| | | | | | |
|-------------------|-----|---------------|---|-----------|--|
| S 320 CDI | 173 | 12/05 → 06/09 | D | OM642.930 | |
| S 320 CDI 4-matic | 173 | 10/06 → 12/13 | D | OM642.932 | |

82063 350982062300



PULEGGIA

Diametro Puleggia Ø99

Altezza Puleggia 30

Posizione Attacco 39.4

Diametro Girante Ø44.8

N° Alette Girante 6

Posizione Girante 21.4

CITROËN
C 1 I

| | | | | | |
|-----|----|---------|---|--------|--|
| 1.0 | 50 | 06/05 → | B | 1KR-FE | |
|-----|----|---------|---|--------|--|

DAIHATSU
Cuore XIII

| | | | | | |
|-----|----|---------|---|--------|--|
| 1.0 | 51 | 04/07 → | B | 1KR-FE | |
|-----|----|---------|---|--------|--|

Sirion II

| | | | | | |
|-----|----|---------|---|--------|--|
| 1.0 | 51 | 01/05 → | B | 1KR-FE | |
|-----|----|---------|---|--------|--|

1.0 DVVT 4WD

| | | | | | |
|-----|----|---------|---|--------|--|
| 1.0 | 51 | 04/05 → | B | 1KR-FE | |
|-----|----|---------|---|--------|--|

Storia

| | | | | | |
|-----|----|---------|---|--------|--|
| 1.0 | 51 | 04/05 → | B | 1KR-FE | |
|-----|----|---------|---|--------|--|

PEUGEOT
107

| | | | | | |
|-----|----|---------|---|---------------------------|--|
| 1.0 | 50 | 06/05 → | B | 1KR (384F), CFA (384F) | |
|-----|----|---------|---|---------------------------|--|

SUBARU
Justy IV

| | | | | | |
|-----|----|---------|---|--------|--|
| 1.0 | 51 | 01/07 → | B | 1KR-FE | |
|-----|----|---------|---|--------|--|

TOYOTA
Aygo I

| | | | | | |
|---------|----|---------|---|--------|--|
| 1.0 | 50 | 07/05 → | B | 1KR-FE | |
| 1.0 GPL | 50 | 07/05 → | | 1KR-FE | |

82063 350982062300

TOYOTA
Yaris II

| | | | | | |
|-----------|----|---------|---|--------|--|
| 1.0 | 52 | 08/07 → | B | 1KR-FE | |
| 1.0 GPL | 51 | 01/06 → | | 1KR-FE | |
| 1.0 VVT-i | 51 | 08/05 → | B | 1KR-FE | |

Yaris III

| | | | | | |
|-----|----|---------|---|--------|--|
| 1.0 | 51 | 09/11 → | B | 1KR-FE | |
|-----|----|---------|---|--------|--|

82066 350982066000



FLANGIA

Numero Fori Flangia 1

Dimensione Fori Flangia M8x1.25

Posizione Attacco 71.6

Diametro Girante Ø94.5

N° Alette Girante 5

Posizione Girante 17.7

CITROËN
Jumper III

| | | | | | |
|-------------|-----|---------|---|-----------------|--|
| 2.2 HDi 100 | 74 | 04/06 → | D | 4HV (P22DTE) | |
| 2.2 HDi 120 | 88 | 04/06 → | D | 4HU (P22DTE) | |
| 2.2 HDi 150 | 110 | 07/11 → | D | 4HJ (P22DTE) | |

FIAT
Ducato V

| | | | | | |
|--------------------|----|---------|---|-----|--|
| 100 Multijet 2,2 D | 74 | 07/06 → | D | 4HV | |
|--------------------|----|---------|---|-----|--|

FORD
Tourneo II Connect, Courier, Custom

| | | | | | |
|----------|-----|---------|---|---------------------|--|
| 2.2 TDCi | 74 | 04/12 → | D | DRF4, DRFF, DRFG | |
| | 92 | 04/12 → | D | CYF4, CYFF | |
| | 114 | 04/12 → | D | CVFF | |

Transit Custom

| | | | | | |
|----------|-----|---------|---|---------------------|--|
| 2.2 TDCi | 74 | 04/12 → | D | DRF4, DRFF, DRFG | |
| | 92 | 04/12 → | D | CYF4, CYFF | |
| | 114 | 04/12 → | D | CVFF | |

82066
350982066000

KW

FORD
Transit Tourneo II

| | | | | |
|----------|-----|---------------|---|------------------------------|
| 2.2 TDCi | 81 | 07/06 → 08/14 | D | QVFA |
| | 85 | 10/08 → 08/14 | D | SRFA, SRFB, SRFC, SRFD, SRFE |
| | 96 | 07/06 → 08/14 | D | QWFA |
| | 103 | 10/07 → 08/14 | D | PGFA, PGFB, UHFA, UHFB |

Transit XIII

| | | | | |
|----------|-----|---------------|---|------------------------------|
| 2.2 TDCi | 63 | 04/06 → 08/14 | D | P8FA, P8FB |
| | 74 | 10/11 → 08/14 | D | DRFA, DRFB, DRFC, DRFD, DRFE |
| | 81 | 04/06 → 08/14 | D | QVFA |
| | 85 | 10/08 → 08/14 | D | SRFA, SRFB, SRFC, SRFD, SRFE |
| | 92 | 10/11 → 08/14 | D | CYFA, CYFB, CYFC, CYFD |
| | 96 | 04/06 → 08/14 | D | QWFA |
| | 103 | 10/07 → 08/14 | D | PGFA, PGFB, UHFA, UHFB, UHFC |

PEUGEOT
Boxer III

| | | | | |
|-------------|-----|---------|---|--------------|
| 2.2 HDi 100 | 74 | 04/06 → | D | 4HV (P22DTE) |
| 2.2 HDi 110 | 81 | 03/11 → | D | 4HG (P22DTE) |
| 2.2 HDi 120 | 88 | 04/06 → | D | 4HU (P22DTE) |
| 2.2 HDi 130 | 96 | 03/11 → | D | 4HH (P22DTE) |
| 2.2 HDi 150 | 110 | 03/11 → | D | 4HJ (P22DTE) |

82067
350982067000

FLANGIA

| | |
|-----------------------------------|---------|
| Numero Fori Flangia | 3 |
| Numero Fori Flangia (Serie 2) | 3 |
| Dimensione Fori Flangia | M8×1.25 |
| Dimensione Fori Flangia (Serie 2) | 7×12.5 |
| Posizione Attacco | 81 |
| Diametro Centraggio | Ø28 |
| Diametro Girante | Ø65 |
| N° Alette Girante | 7 |
| Posizione Girante | 30 |

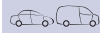
KW

CITROËN
C 5 III, Break

| | | | | |
|---------|-----|---------|---|--------------------------|
| 2.7 HDi | 150 | 02/08 → | D | DT17ED4 |
| | 150 | 02/08 → | D | DT17ED4, UHZ (DT17BTED4) |

C 6

| | | | | |
|---------|-----|---------|---|--------------------------|
| 2.7 HDi | 150 | 09/05 → | D | DT17ED4, UHZ (DT17BTED4) |
|---------|-----|---------|---|--------------------------|

PEUGEOT
407, Station Wagon, Coupé

| | | | | |
|---------|-----|---------|---|------------|
| 2.7 HDi | 150 | 10/05 → | D | UHZ (DT17) |
|---------|-----|---------|---|------------|

607

| | | | | |
|-------------|-----|---------|---|----------|
| 2.7 HDi 24V | 150 | 12/04 → | D | DT17TED4 |
|-------------|-----|---------|---|----------|

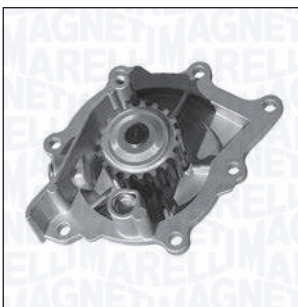
82068
350982068000

PULEGGIA

| | |
|----------------------------|-------|
| Diametro Puleggia | Ø56.2 |
| Numero Denti/Gole Puleggia | 19 |
| Altezza Puleggia | 32.2 |
| Posizione Attacco | 41.5 |
| Diametro Girante | Ø90.5 |
| N° Alette Girante | 8 |
| Posizione Girante | 34.5 |

KW

CITROËN
C 4 II, Picasso, Grand Picasso

| | | | | |
|-----------------|-----|---------|---|---------------|
| 2.0 BlueHDi 135 | 100 | 09/13 → | D | AHV (DW10FDD) |
| 2.0 BlueHDi 150 | 110 | 09/13 → | D | AHX (DW10FD) |

82068 350982068000

KW

CITROËN
C 5 II, Break

| | | | | |
|---------|-----|---------|---|---|
| 2.2 HDi | 120 | 05/06 → | D | 4HP (DW12BTED4), 4HR (DW12BTED4) |
| | 125 | 04/06 → | D | 4HT (DW12BTED4) |

C 5 III, Break

| | | | | |
|---------------------------------|-----|---------|---|--|
| 2.0 HDi 150 / BlueHDi 150 | 110 | 04/09 → | D | AHR (DW10FD), RHE (DW10CTED4) |
| 2.0 HDi 180 | 133 | 03/15 → | D | AHW (DW10FC) |
| 2.2 HDi | 125 | 02/08 → | D | 4HT (DW12BTED4) |
| 2.2 HDi 165 | 120 | 02/08 → | D | 4HP (DW12BTED4) |
| 2.2 HDi 200 | 150 | 07/10 → | D | 4HL (DW12C) |

C 6

| | | | | |
|---------|-----|---------|---|--------------------|
| 2.2 HDi | 120 | 06/06 → | D | 4HP (DW12BTED4) |
| | 125 | 06/06 → | D | 4HT (DW12BTED4) |

C 8

| | | | | |
|---------|-----|---------|---|---|
| 2.2 HDi | 120 | 06/07 → | D | 4HP (DW12BTED4), 4HR (DW12BTED4) |
| | 125 | 06/06 → | D | 4HT (DW12BTED4) |

C-Crosser

| | | | | |
|---------|-----|---------|---|--------------------|
| 2.2 HDi | 115 | 02/07 → | D | 4HN (DW12MTED4) |
|---------|-----|---------|---|--------------------|

DS 5

| | | | | |
|--------------------|-----|---------------|---|-----------------|
| 2.0 BlueHDi 180 | 133 | 08/13 → 07/15 | D | AHW (DW10FC) |
|--------------------|-----|---------------|---|-----------------|

DS
DS 4 / DS 4 CROSSBACK

| | | | | |
|--------------------|-----|---------|---|--|
| 2.0 BlueHDi 150 | 110 | 07/15 → | D | |
| 2.0 BlueHDi 180 | 133 | 07/15 → | D | |

82068
350982068000

KW

DS
DS5

| | | | | |
|--------------------|-----|---------|---|--|
| 2.0 BlueHDi 150 | 110 | 04/15 → | D | |
| 2.0 BlueHDi 180 | 133 | 04/15 → | D | |

FIAT
Ulysse II

| | | | | |
|-------------------|-----|---------------|---|-------------------------|
| 2.2 D Multijet | 125 | 03/08 → 06/11 | D | 4HS, 4HT (DW12BTED4) |
| 2.2 JTD | 120 | 03/08 → 06/11 | D | 4HP, 4HR |

FORD
C-Max II, Van

| | | | | |
|----------|-----|---------|---|------|
| 2.0 TDCi | 110 | 03/15 → | D | T7DB |
| | 125 | 03/15 → | D | T8DE |

Focus III, Station Wagon, Van

| | | | | |
|----------|-----|---------|---|------|
| 2.0 TDCi | 110 | 11/14 → | D | T7DB |
| | 136 | 11/14 → | D | T8DA |

Galaxy II

| | | | | |
|----------|-----|---------------|---|---------------|
| 2.2 TDCi | 129 | 03/08 → 12/12 | D | Q4BA, Q4WA |
| | 147 | 11/10 → 06/15 | D | KNWA |

Galaxy III

| | | | | |
|----------------------|-----|---------|---|---------------------------|
| 2.0 TDCi | 110 | 01/15 → | D | T7CI, T7CJ, T7CK, T7CL |
| | 132 | 01/15 → | D | T8CG, T8CH, T8CI, T8CJ |
| 2.0 TDCi 4x4 | 110 | 05/15 → | D | |
| | 132 | 05/15 → | D | T8CG, T8CH, T8CI, T8CJ |
| 2.0 TDCi Bi-Turbo | 154 | 01/15 → | D | T9CB, T9CC |

Kuga II, Van

| | | | | |
|--------------|-----|---------|---|------------|
| 2.0 TDCi 4x4 | 132 | 09/14 → | D | T8MA, T8MB |
|--------------|-----|---------|---|------------|

Mondeo IV, Station Wagon

| | | | | |
|----------|-----|---------------|---|------|
| 2.2 TDCi | 129 | 03/08 → 10/10 | D | Q4BA |
| | 147 | 07/10 → 09/14 | D | KNBA |

Mondeo V, Station Wagon

| | | | | |
|----------------------|-----|---------|---|------|
| 2.0 TDCi | 110 | 09/14 → | D | T7CE |
| | 132 | 09/14 → | D | T8CC |
| 2.0 TDCi 4x4 | 110 | 02/15 → | D | T7CE |
| | 132 | 02/15 → | D | T8CC |
| 2.0 TDCi Bi-Turbo | 154 | 03/15 → | D | T9CA |
| | 154 | 05/15 → | D | |

82068
350982068000

KW

FORD
S-Max

| | | | | |
|----------------------|-----|---------|---|---------------------------|
| 2.0 TDCi | 110 | 02/15 → | D | T7CI, T7CJ, T7CK, T7CL |
| | 132 | 02/15 → | D | T8CG, T8CH, T8CI, T8CJ |
| 2.0 TDCi 4x4 | 110 | 02/15 → | D | T7CI, T7CJ, T7CK, T7CL |
| | 132 | 02/15 → | D | T8CG, T8CH, T8CI, T8CJ |
| 2.0 TDCi BI-Turbo | 154 | 02/15 → | D | T9CB, T9CC |
| 2.2 TDCi | 129 | 03/08 → | D | Q4WA |
| | 147 | 07/10 → | D | KNWA |

JAGUAR
XF I

| | | | | |
|-------|-----|---------------|---|-------|
| 2.2 D | 120 | 04/11 → 04/15 | D | 224DT |
| | 140 | 05/11 → 04/15 | D | 224DT |
| | 147 | 03/12 → 04/15 | D | 224DT |

XF II, Sportbrake

| | | | | |
|-------|-----|---------------|---|-------|
| 2.2 D | 120 | 09/12 → 04/14 | D | 224DT |
| | 147 | 09/12 → 04/14 | D | 224DT |

LANCIA
Phedra

| | | | | |
|----------------|-----|---------------|---|----------|
| 2.2 D Multijet | 125 | 03/08 → 11/10 | D | 4HS, 4HT |
| 2.2 JTD | 120 | 04/06 → 11/10 | D | 4HP, 4HR |

LAND ROVER
Discovery Sport

| | | | | |
|-----------|-----|---------|---|-------|
| 2.2 D 4WD | 110 | 12/14 → | D | 224DT |
| | 140 | 12/14 → | D | 224DT |

Freelander II

| | | | | |
|-------------|-----|---------------|---|-----------------------|
| 2.2 eD4 | 110 | 08/10 → 10/14 | D | 224DT, (DW12BTED4) |
| 2.2 SD4 4x4 | 140 | 08/10 → 10/14 | D | 224DT |
| 2.2 TD4 4x4 | 110 | 10/06 → 10/14 | D | 224DT, DW12BTED4 |
| | 112 | 01/07 → 10/14 | D | 224DT |
| | 115 | 10/06 → 10/14 | D | 224DT |
| | 118 | 10/06 → 10/14 | D | 224DT, DW12BTED4 |

Range Rover Evoque, Cabrio

| | | | | |
|-----------|-----|---------|---|-------|
| 2.2 D | 110 | 06/11 → | D | 224DT |
| 2.2 D 4x4 | 110 | 06/11 → | D | 224DT |
| | 140 | 06/11 → | D | 224DT |

82068
350982068000

KW

MITSUBISHI
Outlander II, Van

| | | | | |
|-----------------|-----|---------------|---|----------|
| 2.2 DI-D 4WD | 115 | 08/07 → 11/12 | D | 4HK, 4HN |
|-----------------|-----|---------------|---|----------|

PEUGEOT
308 II Station Wagon

| | | | | |
|-----------------------|-----|---------|---|--|
| 2.0 BlueHdi 150 | 110 | 11/13 → | D | |
| | 110 | 03/14 → | D | |
| 2.0 GT BlueHdi 180 | 133 | 06/14 → | D | |
| 2.0 GT HDi 180 | 133 | 06/14 → | D | |

407, Station Wagon, Coupé

| | | | | |
|-------------|-----|---------|---|--------------------|
| 2.2 HDi | 120 | 06/08 → | D | 4HP (DW12BTED4) |
| 2.2 HDi 170 | 125 | 05/06 → | D | 4HT (DW12BTED4) |

508, Station Wagon

| | | | | |
|--------------------|-----|---------|---|-----------------|
| 2.0 BlueHdi 150 | 110 | 04/14 → | D | AHX (DW10FD) |
| 2.0 BlueHdi 180 | 133 | 04/14 → | D | AHW (DW10FC) |
| 2.0 HDi 180 RXH | 133 | 10/14 → | | |
| 2.2 HDi | 150 | 11/10 → | D | 4HL (DW12C) |

607

| | | | | |
|---------|-----|---------|---|--------------------|
| 2.2 HDi | 125 | 05/06 → | D | 4HT (DW12BTED4) |
|---------|-----|---------|---|--------------------|

807

| | | | | |
|---------|-----|---------|---|--------------------|
| 2.2 HDi | 120 | 06/06 → | D | 4HT (DW12BTED4) |
| | 125 | 06/06 → | D | 4HT (DW12BTED4) |

4007

| | | | | |
|---------|-----|---------|---|---|
| 2.2 HDi | 115 | 02/07 → | D | 4HK (DW12MTED4), 4HN (DW12MTED4) |
|---------|-----|---------|---|---|

82069
350982069000

FLANGIA

| | |
|-------------------------|---------|
| Numero Fori Flangia | 3 |
| Dimensione Fori Flangia | M8x1.25 |
| Posizione Attacco | 43.6 |
| Diametro Centraggio | Ø28.3 |
| Diametro Girante | Ø67.2 |
| N° Alette Girante | 16 |
| Posizione Girante | 55 |

KW

NISSAN
Primastar

| | | | | |
|---------|----|---------|---|--------|
| dCi 120 | 84 | 09/06 → | D | M9R780 |
| dCi 90 | 66 | 09/06 → | D | M9R782 |

Qashqai I

| | | | | |
|-------------------------------|-----|---------|---|----------|
| 2.0 dCi | 110 | 02/07 → | D | M1D, M9R |
| 2.0 dCi Trazione integrale | 110 | 02/07 → | D | M1D, M9R |

X-Trail II

| | | | | |
|-------------|-----|---------------|---|--------|
| 2.0 dCi | 110 | 06/07 → 11/13 | D | M9R |
| | 127 | 06/07 → 11/13 | D | M9R760 |
| 2.0 dCi FWD | 110 | 06/07 → 11/13 | D | M9R |

OPEL
Movano B

| | | | | |
|-------------------|-----|---------|---|--|
| 2.3 CDTI | 74 | 12/10 → | D | M9T670, M9T672, M9T676 |
| | 92 | 12/10 → | D | M9T670, M9T672, M9T676, M9T680, M9T876 |
| | 107 | 12/10 → | D | M9T678, M9T680 |
| | 110 | 01/13 → | D | M9T880 |
| 2.3 CDTI [RWD] | 74 | 05/10 → | D | M9T690, M9T692 |
| | 92 | 05/10 → | D | M9T692, M9T696, M9T698, M9T876 |
| | 107 | 05/10 → | D | M9T694, M9T696, M9T698 |

82069
350982069000

KW

OPEL
Movano B

| | | | | |
|-----------------|-----|---------|---|--|
| 2.3 CDTI FWD | 74 | 05/10 → | D | M9T670, M9T672, M9T676 |
| | 92 | 05/10 → | D | M9T670, M9T672, M9T676, M9T680, M9T876 |
| | 92 | 05/10 → | D | M9T670, M9T672, M9T676, M9T876 |
| | 107 | 05/10 → | D | M9T678, M9T680 |
| | 110 | 01/13 → | D | M9T880 |

Vivaro

| | | | | |
|----------|----|---------|---|---|
| 2.0 CDTI | 66 | 08/06 → | D | M9R630, M9R780, M9R782, M9R786 |
| | 66 | 08/06 → | D | M9R780, M9R782, M9R786 |
| | 84 | 08/06 → | D | M9R630, M9R692, M9R780, M9R784, M9R786, M9R788 |
| | 84 | 08/06 → | D | M9R630, M9R780 |
| | 84 | 08/06 → | D | M9R692, M9R780, M9R784, M9R786, M9R788 |

RENAULT
Espace IV

| | | | | |
|---------|-----|---------|---|---|
| 2.0 dCi | 96 | 01/06 → | D | M9R740, M9R750, M9R760, M9R761, M9R762, M9R763 |
| | 110 | 01/06 → | D | M9R740, M9R750, M9R815 |
| | 127 | 01/06 → | D | M9R760, M9R761, M9R762, M9R763, M9R815 |

82069
350982069000

KW

RENAULT
Grand Scénic II

| | | | | |
|---------|-----|---------|---|------------------------------|
| 2.0 dCi | 110 | 09/05 → | D | M9R700, M9R721, M9R722 |
|---------|-----|---------|---|------------------------------|

Grand Scénic III

| | | | | |
|---------|-----|---------|---|--------|
| 2.0 dCi | 110 | 02/09 → | D | M9R615 |
| | 118 | 04/09 → | D | M9R610 |

Koleos

| | | | | |
|---------|-----|---------|---|--|
| 2.0 dCi | 110 | 09/08 → | D | M9R855, M9R856, M9R862, M9R865, M9R866 |
| | 130 | 09/08 → | D | M9R830 |

| | | | | |
|-------------|-----|---------|---|---|
| 2.0 dCi 4x4 | 110 | 09/08 → | D | M9R832, M9R855, M9R856, M9R862, M9R865, M9R866 |
| | 127 | 09/08 → | D | M9R830 |

Laguna II, Grantour

| | | | | |
|---------|-----|---------|---|--------|
| 2.0 dCi | 110 | 08/05 → | D | M9R740 |
| | 127 | 01/06 → | D | M9R760 |

Laguna III, Grantour, Coupé

| | | | | |
|------------|-----|---------|---|------------------------------|
| 2.0 dCi | 127 | 09/08 → | D | M9R800, M9R809, M9R815 |
| | 96 | 10/07 → | D | M9R742, M9R744, M9R802 |
| | 110 | 09/08 → | D | M9R802, M9R805, M9R814 |
| | 127 | 01/08 → | D | M9R800, M9R809, M9R815 |
| 2.0 dCi GT | 131 | 03/08 → | D | M9R816 |
| | 131 | 09/08 → | D | M9R816, M9R820 |
| 3.0 dCi | 177 | 01/12 → | D | V9X891 |
| | 173 | 09/08 → | D | V9X791, V9X891 |

Latitude

| | | | | |
|-------------|-----|---------|---|------------------------------|
| 2.0 dCi 150 | 110 | 02/11 → | D | M9R824, M9R846 |
| 2.0 dCi 175 | 127 | 05/11 → | D | M9R804, M9R817, M9R844 |
| 3.0 dCi 240 | 177 | 02/11 → | D | V9X891 |

82069
350982069000

KW

RENAULT
Master III

| | | | | |
|-----------------|----|---------|---|---|
| 2.3 dCi 100 FWD | 74 | 02/11 → | D | M9T670, M9T672, M9T676, M9T870 |
|-----------------|----|---------|---|---|

| | | | | |
|-----------------|----|---------|---|---|
| 2.3 dCi 125 FWD | 92 | 02/11 → | D | M9T670, M9T672, M9T676, M9T870 |
|-----------------|----|---------|---|---|

| | | | | |
|-------------|-----|---------|---|--------|
| 2.3 dCi 150 | 110 | 10/12 → | D | M9T880 |
|-------------|-----|---------|---|--------|

| | | | | |
|-------------|-----|---------|---|-------------------|
| 2.3 dCi FWD | 110 | 03/13 → | D | M9T880, M9T898 |
|-------------|-----|---------|---|-------------------|

| | | | | |
|-------------|----|---------|---|--|
| 2.3 dCi FWD | 74 | 02/10 → | D | M9T670, M9T672, M9T676, M9T870, M9T890 |
|-------------|----|---------|---|--|

| | | | | |
|-------------|----|---------|---|---|
| 2.3 dCi FWD | 92 | 02/10 → | D | M9T670, M9T672, M9T676, M9T696, M9T698, M9T870, M9T890, M9T896 |
|-------------|----|---------|---|---|

| | | | | |
|-------------|----|---------|---|--|
| 2.3 dCi FWD | 92 | 02/10 → | D | M9T670, M9T672, M9T676, M9T698, M9T870, M9T890, M9T896 |
|-------------|----|---------|---|--|

| | | | | |
|-------------|-----|---------|---|---|
| 2.3 dCi FWD | 107 | 02/10 → | D | M9T678, M9T680, M9T694, M9T696, M9T698, M9T896 |
|-------------|-----|---------|---|---|

| | | | | |
|-------------|-----|---------|---|---|
| 2.3 dCi FWD | 107 | 02/10 → | D | M9T678, M9T680, M9T698, M9T896 |
|-------------|-----|---------|---|---|

| | | | | |
|-------------|-----|---------|---|--------|
| 2.3 dCi FWD | 107 | 02/11 → | D | M9T680 |
|-------------|-----|---------|---|--------|

Megane II, Station Wagon, Coupé-Cabrio

| | | | | |
|---------|-----|---------------|---|-------------------|
| 2.0 dCi | 110 | 09/05 → 03/09 | D | M9R700, M9R722 |
| | 127 | 01/07 → 02/08 | D | M9R724 |
| | 110 | 09/05 → 02/08 | D | M9R700, M9R722 |

82069 350982069000

RENAULT
Megane III, Station Wagon, Coupé, CC

| | | | | |
|---------|-----|---------|---|--------------------|
| 2.0 CVT | 103 | 05/09 → | B | M4R711, M4RF713 |
| 2.0 dCi | 120 | 07/12 → | D | M9R610 |
| | 110 | 10/10 → | D | M9R615 |
| | 118 | 06/10 → | D | M9R610 |

Scénic II

| | | | | |
|---------|-----|---------|---|------------------------------|
| 2.0 dCi | 110 | 09/05 → | D | M9R700, M9R721, M9R722 |
|---------|-----|---------|---|------------------------------|

Scénic III

| | | | | |
|---------|-----|---------|---|--------|
| 2.0 dCi | 110 | 02/09 → | D | M9R615 |
| | 118 | 04/09 → | D | M9R610 |

Trafic II

| | | | | |
|-------------|----|---------|---|--|
| 2.0 dCi 115 | 84 | 08/06 → | D | M9R630, M9R692, M9R780, M9R782, M9R786 |
| | 84 | 08/06 → | D | M9R692, M9R780, M9R782, M9R786 |
| | 84 | 08/06 → | D | M9R780, M9R782, M9R786 |

| | | | | |
|------------|----|---------|---|------------------------------|
| 2.0 dCi 90 | 66 | 08/06 → | D | M9R630, M9R780, M9R782 |
| | 66 | 08/06 → | D | M9R780, M9R782 |
| | 66 | 08/06 → | D | M9R782 |

Vel Satis

| | | | | |
|---------|-----|---------|---|------------------------------|
| 2.0 dCi | 110 | 08/05 → | D | M9R760 |
| | 127 | 01/06 → | D | M9R760, M9R762, M9R763 |

82070 350982070000

PULEGGIA

| | |
|----------------------------|-------|
| Versione | TESMA |
| Diametro Puleggia | Ø57 |
| Numero Denti/Gole Puleggia | 23 |
| Altezza Puleggia | 23.5 |
| Posizione Attacco | 53.8 |
| Diametro Girante | Ø63 |
| N° Alette Girante | 9 |
| Posizione Girante | 34 |

ABARTH
500

| | | | | | |
|-----|-----|---------|---|-------------------------|-------|
| 1.4 | 103 | 05/10 → | B | 312A3.000 | TESMA |
| | 118 | 08/08 → | B | 312A1.000, 312A3.000 | TESMA |
| | 132 | 08/08 → | B | 312A3.000 | TESMA |
| | 139 | 08/08 → | B | 312A1.000, 312A9.000 | TESMA |

500C

| | | | | | |
|-----|-----|---------|---|-------------------------|-------|
| 1.4 | 99 | 01/11 → | B | 312A1.000 | TESMA |
| | 103 | 09/09 → | B | 312A3.000 | TESMA |
| | 118 | 05/11 → | B | 312A1.000, 312A3.000 | TESMA |
| | 132 | 09/09 → | B | 312A3.000 | TESMA |

Punto

| | | | | | |
|-----|-----|---------|---|-------------------------|-------|
| 1.4 | 120 | 10/09 → | B | 955A8.000 | TESMA |
| | 132 | 07/08 → | B | 199A8.000, 955A8.000 | TESMA |

ALFA ROMEO
Giulietta III

| | | | | | |
|------------|-----|---------|----|-------------------------|-------|
| 1.4 BiFuel | 88 | 12/11 → | BF | 198A4.000 | TESMA |
| 1.4 TB | 77 | 04/11 → | B | 940B1.000, 940B8.000 | TESMA |
| | 85 | 04/10 → | B | 940A6.000 | TESMA |
| | 88 | 04/10 → | B | 198A4.000, 940B7.000 | TESMA |
| | 110 | 09/14 → | B | 940A2.000 | TESMA |
| | 120 | 04/10 → | B | 955A8.000 | TESMA |
| | 125 | 04/10 → | B | 940A2.000 | TESMA |

Mito

| | | | | | |
|--------------|-----|---------|----|-----------|-------|
| 1.4 | 51 | 05/11 → | B | 955A9.000 | TESMA |
| | 57 | 03/11 → | B | 350A1.000 | TESMA |
| | 57 | 03/11 → | B | 955A1.000 | TESMA |
| | 58 | 09/08 → | B | 955A1.000 | TESMA |
| | 70 | 09/08 → | B | 199A6.000 | TESMA |
| 1.4 BiFuel | 88 | 07/11 → | BF | 198A4.000 | TESMA |
| 1.4 MultiAir | 77 | 08/10 → | B | 955A6.000 | TESMA |
| 1.4 TB | 103 | 12/13 → | B | 955B1.000 | TESMA |

82070
350982070000

ALFA ROMEO
Mito

| | | | | | |
|--------------------|-----|---------|---|----------------------|-------|
| 1.4 TJet | 88 | 09/08 → | B | 198A4.000 | TESMA |
| | 110 | 09/08 → | B | 198A1.000 | TESMA |
| | 114 | 09/08 → | B | 199A8.000 | TESMA |
| 1.4 Turbo MultiAir | 99 | 10/09 → | B | 955A2.000, 955A7.000 | TESMA |
| | 120 | 10/09 → | B | 955A8.000 | TESMA |
| | 125 | 10/09 → | B | 940A2.000 | TESMA |

CHRYSLER
Delta

| | | | | | |
|---------|-----|---------|---|-----------|-------|
| 1.4 | 88 | 08/11 → | B | 198A4.000 | TESMA |
| 1.4 16V | 103 | 08/11 → | B | 198A7.000 | TESMA |

Ypsilon

| | | | | | |
|-----|----|---------|---|-----------|-------|
| 1.2 | 51 | 05/11 → | B | 169A4.000 | TESMA |
|-----|----|---------|---|-----------|-------|

FIAT
500 II, 500C

| | | | | | |
|-----|----|---------|---|-----------|-------|
| 1.2 | 51 | 10/07 → | B | 169A4.000 | TESMA |
| 1.4 | 74 | 10/07 → | B | 169A3.000 | TESMA |

500L

| | | | | | |
|---------|----|---------|---|-----------|-------|
| 1.4 | 70 | 09/12 → | B | 843A1.000 | TESMA |
| | 88 | 10/13 → | B | 940B7.000 | TESMA |
| 1.4 LPG | 88 | 02/14 → | | 940B7.000 | TESMA |

500X

| | | | | | |
|---------|-----|---------|---|----------|-------|
| 1.4 | 100 | 09/14 → | B | 55263624 | TESMA |
| | 103 | 09/14 → | B | 55263624 | TESMA |
| 1.4 4x4 | 120 | 02/15 → | B | 55263623 | TESMA |
| | 125 | 02/15 → | B | 55263623 | TESMA |

Bravo II, Van

| | | | | | |
|-----------|-----|---------|---|-----------|-------|
| 1.4 | 66 | 04/07 → | B | 192B2.000 | TESMA |
| 1.4 16V | 103 | 03/08 → | B | 198A7.000 | TESMA |
| 1.4 LPG | 66 | 11/09 → | | 192B2.000 | TESMA |
| 1.4 T-Jet | 88 | 09/07 → | B | 198A4.000 | TESMA |
| | 110 | 09/07 → | B | 198A1.000 | TESMA |

Doblò I, Cargo

| | | | | | |
|-----|----|---------|---|-----------|-------|
| 1.4 | 57 | 10/05 → | B | 350A1.000 | TESMA |
|-----|----|---------|---|-----------|-------|

Doblò II, Cargo

| | | | | | |
|-------------------|----|---------|---|-----------|-------|
| 1.4 | 70 | 02/10 → | B | 843A1.000 | TESMA |
| | 88 | 10/11 → | B | 198A4.000 | TESMA |
| 1.4 Natural Power | 88 | 06/10 → | | 198A4.000 | TESMA |

Fiorino IV

| | | | | | |
|-------------------|----|---------|--|-----------|-------|
| 1.4 Natural Power | 57 | 10/09 → | | 350A1.000 | TESMA |
|-------------------|----|---------|--|-----------|-------|

82070
350982070000

FIAT
Grande Punto, Van

| | | | | | |
|-----------|-----|---------------|---|-----------|-------|
| 1.2 | 48 | 10/05 → | B | 199A4.000 | TESMA |
| | 51 | 09/10 → | B | 169A4.000 | TESMA |
| 1.2 LPG | 51 | 07/08 → | | 199A4.000 | TESMA |
| 1.4 | 55 | 06/06 → | B | 199A7.000 | TESMA |
| | 57 | 10/05 → | B | 350A1.000 | TESMA |
| 1.4 16V | 70 | 10/05 → | B | 199A6.000 | TESMA |
| | 112 | 09/07 → 07/12 | B | 198A1.000 | TESMA |
| 1.4 LPG | 57 | 12/08 → | | 350A1.000 | TESMA |
| 1.4 T-Jet | 88 | 09/07 → | B | 198A4.000 | TESMA |

Idea

| | | | | | |
|---------|----|---------|---|-----------|-------|
| 1.2 16V | 59 | 01/04 → | B | 188A5.000 | TESMA |
| 1.4 | 57 | 10/05 → | B | 350A1.000 | TESMA |
| 1.4 16V | 70 | 01/04 → | B | 843A1.000 | TESMA |
| 1.4 LPG | 57 | 03/09 → | | 350A1.000 | TESMA |

Linea

| | | | | | |
|-----------|----|---------|---|-----------|-------|
| 1.4 | 57 | 06/07 → | B | 350A1.000 | TESMA |
| 1.4 T-Jet | 88 | 09/07 → | B | 198A4.000 | TESMA |

Panda II, Van

| | | | | | |
|-------------------|----|---------------|---|-----------|-------|
| 1.2 | 44 | 09/03 → | B | 188A4.000 | TESMA |
| | 51 | 03/10 → | B | 169A4.000 | TESMA |
| 1.2 4x4 | 44 | 10/04 → | B | 188A4.000 | TESMA |
| | 51 | 11/09 → | B | 169A4.000 | TESMA |
| 1.2 LPG | 44 | 04/09 → | | 188A4.000 | TESMA |
| | 51 | 11/10 → | | 169A4.000 | TESMA |
| 1.2 Natural Power | 44 | 01/07 → 11/09 | | 188A4.000 | TESMA |
| 1.4 | 74 | 10/06 → | B | 169A3.000 | TESMA |
| 1.4 Natural Power | 51 | 01/10 → | | 350A1.000 | TESMA |
| | 57 | 09/10 → | | 350A1.000 | TESMA |

Panda III, Van

| | | | | | |
|---------|----|---------|---|-----------|-------|
| 1.2 | 51 | 02/12 → | B | 169A4.000 | TESMA |
| 1.2 LPG | 51 | 06/12 → | | 169A4.000 | TESMA |

Punto Evo, Van

| | | | | | |
|-------------------|----|---------------|---|-----------|-------|
| 1.2 | 48 | 10/09 → 02/12 | B | 199A4.000 | TESMA |
| | 51 | 10/09 → 02/12 | B | 169A4.000 | TESMA |
| 1.4 | 55 | 07/09 → 02/12 | B | 199A7.000 | TESMA |
| | 57 | 10/09 → 02/12 | B | 350A1.000 | TESMA |
| 1.4 16V | 77 | 10/09 → 02/12 | B | 955A6.000 | TESMA |
| | 99 | 10/09 → 02/12 | B | 955A2.000 | TESMA |
| 1.4 LPG | 57 | 06/09 → 02/12 | | 350A1.000 | TESMA |
| 1.4 Natural Power | 57 | 10/09 → 02/12 | | 350A1.000 | TESMA |

82070 350982070000

FIAT
Punto II, Cabrio, Van

| | | | | | |
|-------------------|----|---------|----|-----------|---------------------|
| 1.2 Bifuel | 44 | 08/07 → | BF | 188A4.000 | TESMA |
| 1.2 Natural Power | 44 | 09/03 → | | 188A4.000 | M →: 2533529, TESMA |
| 1.4 | 71 | 11/05 → | B | 199A6.000 | TESMA |

Punto III, Van

| | | | | | |
|---------------------|----|---------|----|-----------|-------|
| 1.2 | 49 | 02/14 → | B | 199B9.000 | TESMA |
| | 51 | 03/12 → | B | 169A4.000 | TESMA |
| 1.4 | 55 | 03/12 → | B | 199A7.000 | TESMA |
| | 57 | 03/12 → | B | 350A1.000 | TESMA |
| 1.4 Bifuel | 57 | 03/12 → | BF | 350A1.000 | TESMA |
| 1.4 LPG | 57 | 03/09 → | | 350A1.000 | TESMA |
| 1.4 Multi Air | 77 | 03/12 → | B | 955A6.000 | TESMA |
| 1.4 Natural Power | 57 | 03/12 → | | 350A1.000 | TESMA |
| 1.4 Turbo Multi Air | 99 | 03/12 → | B | 955A2.000 | TESMA |

Qubo

| | | | | | |
|-------------------|----|---------|--|-----------|-------|
| 1.4 Natural Power | 57 | 10/09 → | | 350A1.000 | TESMA |
|-------------------|----|---------|--|-----------|-------|

Siena I

| | | | | | |
|----------|----|---------------|---|----------------------|-------|
| 1.2 Flex | 52 | 03/04 → 05/05 | | 178E9.011 | TESMA |
| 1.4 | 57 | 01/07 → 12/09 | B | 178F3.011, 350A1.000 | TESMA |

Siena II

| | | | | | |
|-----|----|---------|---|-----------|-------|
| 1.4 | 57 | 11/07 → | B | 199A1.000 | TESMA |
|-----|----|---------|---|-----------|-------|

Stilo, Station Wagon

| | | | | | |
|---------|----|---------------|---|-----------|-------|
| 1.4 16V | 66 | 03/05 → 11/06 | B | 192B2.000 | TESMA |
| | 70 | 01/04 → 11/06 | B | 843A1.000 | TESMA |

Strada

| | | | | | |
|-----|----|---------|---|-----------|-------|
| 1.2 | 44 | 04/03 → | B | 188A4.000 | TESMA |
| | 54 | 06/99 → | B | 178B5.000 | TESMA |

Tipo II

| | | | | | |
|-----|----|---------|---|-----------|-------|
| 1.4 | 70 | 10/15 → | B | 843A1.000 | TESMA |
|-----|----|---------|---|-----------|-------|

JEEP
Renegade

| | | | | | |
|---------|-----|---------|---|-----|-------|
| 1.4 | 103 | 07/14 → | B | EAM | TESMA |
| 1.4 4x4 | 125 | 07/14 → | B | EAM | TESMA |

LANCIA
Delta III

| | | | | | |
|------------|-----|---------------|----|-----------|-------|
| 1.4 | 88 | 09/08 → 08/14 | B | 198A4.000 | TESMA |
| | 110 | 09/08 → 08/14 | B | 198A1.000 | TESMA |
| 1.4 16V | 103 | 07/10 → 08/14 | B | 198A7.000 | TESMA |
| 1.4 Bifuel | 88 | 07/11 → 08/14 | BF | 198A4.000 | TESMA |

82070 350982070000

LANCIA
Musa

| | | | | | |
|---------|----|---------------|---|-----------|-------|
| 1.41.4 | 57 | 09/05 → 09/12 | B | 350A1.000 | TESMA |
| | 66 | 10/07 → 09/12 | B | 192B2.000 | TESMA |
| | 70 | 10/04 → 09/12 | B | 843A1.000 | TESMA |
| 1.4 LPG | 57 | 11/10 → 09/12 | | 350A1.000 | TESMA |

Ypsilon I

| | | | | | |
|---------|----|---------------|---|-----------|-------|
| 1.2 | 44 | 10/03 → 12/11 | B | 188A4.000 | TESMA |
| | 51 | 08/10 → 12/11 | B | 169A4.000 | TESMA |
| | 59 | 10/03 → 12/11 | B | 188A5.000 | TESMA |
| 1.4 | 57 | 02/06 → 12/11 | B | 350A1.000 | TESMA |
| 1.4 16V | 70 | 10/03 → 12/11 | B | 843A1.000 | TESMA |
| 1.4 LPG | 57 | 11/10 → 12/11 | | 350A1.000 | TESMA |

Ypsilon II

| | | | | | |
|------------|----|---------|----|-----------|-------|
| 1.2 | 51 | 05/11 → | B | 169A4.000 | TESMA |
| 1.2 Bifuel | 49 | 05/11 → | BF | 169A4.000 | TESMA |
| | 51 | 05/11 → | BF | 169A4.000 | TESMA |

OPEL
Combo C

| | | | | | |
|---------|----|---------|---|-------|-------|
| 1.4 | 70 | 02/12 → | B | A14FP | TESMA |
| 1.4 CNG | 88 | 02/12 → | | A14FC | TESMA |

82071 350982071000



PULEGGIA

| | |
|-------------------|--------|
| Diametro Puleggia | Ø109.9 |
| Altezza Puleggia | 31.5 |
| Posizione Attacco | 54 |
| Diametro Girante | Ø74 |
| N° Alette Girante | 7 |
| Posizione Girante | 18.9 |

LEXUS
IS II

| | | | | |
|------|-----|---------|---|---------|
| 200d | 110 | 07/10 → | D | 2AD-FTV |
| | 130 | 10/05 → | D | 2AD-FHV |

TOYOTA
Auris I, Van

| | | | | |
|----------|-----|---------------|---|---------|
| 2.0 D-4D | 93 | 03/07 → 09/12 | D | 1AD-FTV |
| 2.2 D | 130 | 03/07 → 09/12 | D | 2AD-FHV |

Avensis II, Liftback, Station Wagon

| | | | | |
|-----------|-----|---------------|---|---------|
| 2.0 D-4D | 93 | 03/06 → 11/08 | D | 1AD-FTV |
| | 110 | 10/05 → 11/08 | D | 2AD-FTV |
| 2.2 D-CAT | 130 | 07/05 → 11/08 | D | 2AD-FHV |

82071
350982071000

TOYOTA
Avensis III, Liftback, Station Wagon

| | | | | | |
|----------|-----|---------|---|---------------------|-----------|
| 2.0 D-4D | 93 | 02/09 → | D | 1AD-FTV | → 11-2011 |
| | 110 | 02/09 → | D | 2AD-FHV, 2AD-FTV | |
| | 130 | 02/09 → | D | 2AD-FHV | |

Corolla Verso

| | | | | | |
|----------|-----|---------------|---|---------|--|
| 2.2 D-4D | 100 | 10/05 → 03/09 | D | 2AD-FTV | |
| | 130 | 10/05 → 03/09 | D | 2AD-FHV | |

Corolla VIII, Hatchback, Station Wagon

| | | | | | |
|----------|-----|---------|---|---------|--|
| 2.0 D-4D | 93 | 01/07 → | D | 1AD-FTV | |
| | 130 | 11/06 → | D | 2AD-FHV | |

RAV 4 III

| | | | | | |
|------------------|-----|---------|---|---------------------|--|
| 2.2 D-4D | 110 | 12/08 → | D | 2AD-FHV, 2AD-FTV | |
| 2.2 D-4D 4WD | 100 | 03/06 → | D | 2AD-FTV | |
| | 110 | 12/08 → | D | 2AD-FHV, 2AD-FTV | |
| 2.2 D-CAT 4WD | 130 | 03/06 → | D | 2AD-FHV | |

RAV 4 IV

| | | | | | |
|-----------------|-----|---------|---|---------------------|--|
| 2.2 D4-D 4WD | 110 | 12/12 → | D | 2AD-FHV, 2AD-FTV | |
|-----------------|-----|---------|---|---------------------|--|

Verso

| | | | | | |
|-----------|-----|---------|---|---------|--|
| 2.0 D-4D | 91 | 11/12 → | D | 1AD-FTV | |
| | 93 | 04/09 → | D | 1AD-FTV | |
| | 110 | 04/09 → | D | 2AD-FHV | |
| 2.2 D-CAT | 130 | 04/09 → | D | 2AD-FHV | |

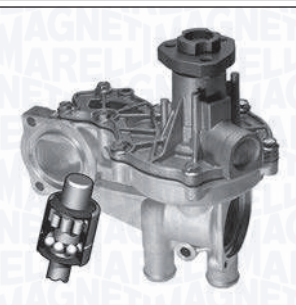
82080
350982080000

FLANGIA

| | |
|-------------------------|---------|
| Numero Fori Flangia | 3 |
| Dimensione Fori Flangia | M8x1.25 |
| Posizione Attacco | 74 |
| Diametro Mozzo | Ø30 |
| Diametro Girante | Ø59 |
| N° Alette Girante | 6 |
| Posizione Girante | 29.5 |

AUDI
80 IV

| | | | | | |
|--------|----|---------------|---|--------|--------|
| 1.6 | 51 | 08/87 → 09/91 | B | PP | (+)COP |
| | 55 | 09/86 → 08/91 | B | RN | (+)COP |
| | 75 | 08/90 → 10/91 | B | ABB | (+)COP |
| 1.6 TD | 59 | 09/86 → 08/91 | D | RA, SB | (+)COP |

82080
350982080000

AUDI
80 IV

| | | | | | |
|----------------------|-----|---------------|---|------------|--------|
| 1.8 | 55 | 10/86 → 01/90 | B | RU | (+)COP |
| 1.8 E | 82 | 06/86 → 08/91 | B | DZ | (+)COP |
| 1.8 E quattro | 82 | 09/86 → 08/91 | B | DZ | (+)COP |
| 1.8 quattro | 83 | 09/86 → 08/90 | B | SD | (+)COP |
| 1.8 S | 65 | 08/86 → 01/90 | B | SF | (+)COP |
| | 66 | 09/86 → 10/91 | B | JN, NE, PM | (+)COP |
| 1.8 S quattro | 65 | 09/86 → 07/90 | B | SF | (+)COP |
| | 66 | 09/86 → 09/91 | B | JN, NE, PM | (+)COP |
| 1.9 D | 50 | 08/89 → 08/91 | D | 1Y | (+)COP |
| 2.0 | 82 | 10/90 → 08/91 | B | AAD | (+)COP |
| 2.0 E | 83 | 08/88 → 10/90 | B | 3A | (+)COP |
| 2.0 E 16V | 101 | 03/90 → 09/91 | B | 6A | (+)COP |
| 2.0 E 16V quattro | 101 | 03/90 → 08/91 | B | 6A | (+)COP |
| 2.0 E quattro | 83 | 08/88 → 09/90 | B | 3A | (+)COP |
| | 82 | 08/88 → 07/90 | B | 3A | (+)COP |
| 2.0 quattro | 85 | 10/90 → 08/91 | B | AAD | (+)COP |

80 V, Avant

| | | | | | |
|----------------------|-----|---------------|---|-----|--------|
| 1.6 | 52 | 09/91 → 12/94 | B | ABM | (+)COP |
| 1.6 E | 74 | 06/93 → 12/94 | B | ADA | (+)COP |
| 1.9 TD | 55 | 09/91 → 12/94 | D | AAZ | (+)COP |
| 1.9 TDI | 66 | 09/91 → 12/94 | D | 1Z | (+)COP |
| 2.0 | 66 | 09/91 → 12/94 | B | ABT | (+)COP |
| 2.0 E | 85 | 09/91 → 12/94 | B | ABK | (+)COP |
| 2.0 E 16V | 103 | 08/92 → 12/94 | B | ACE | (+)COP |
| 2.0 E 16V quattro | 103 | 04/92 → 12/94 | B | ACE | (+)COP |
| 2.0 E quattro | 85 | 09/91 → 12/94 | B | ABK | (+)COP |
| 2.0 quattro | 79 | 11/93 → 01/96 | B | ADW | (+)COP |

90 II

| | | | | | |
|-------------|-----|---------------|---|--------|--------|
| 1.6 TD | 59 | 04/87 → 09/91 | D | RA, SB | (+)COP |
| 2.0 quattro | 101 | 08/89 → 07/90 | B | 6A | (+)COP |

100 III, Avant

| | | | | | |
|---------------------|----|---------------|---|--------|--------|
| 1.8 | 65 | 02/86 → 07/90 | B | SH | (+)COP |
| 1.8 Cat. | 66 | 03/85 → 11/90 | B | 4B, PH | (+)COP |
| 1.8 quattro | 65 | 08/86 → 07/90 | B | SH | (+)COP |
| 1.8 quattro Cat. | 66 | 08/85 → 11/90 | B | 4B, PH | (+)COP |

100 IV, Avant

| | | | | | |
|-----------|-----|---------------|---|----------|--------|
| 2.0 E | 74 | 12/90 → 06/94 | B | AAE | (+)COP |
| | 74 | 09/91 → 06/94 | B | AAE | (+)COP |
| | 85 | 12/90 → 06/94 | B | AAD, ABK | (+)COP |
| 2.0 E 16V | 103 | 01/92 → 06/94 | B | ACE | (+)COP |

82080
350982080000

KW

AUDI
100 IV, Avant

| | | | | | |
|-------------------|-----|---------------|---|-----|--------|
| 2.0 E 16V quattro | 103 | 07/92 → 06/94 | B | ACE | (+)COP |
| 2.0 E quattro | 85 | 12/90 → 07/92 | B | AAD | (+)COP |

A6 I, Avant

| | | | | | |
|-----------------|-----|---------------|---|---------|---------------|
| 1.9 TDI | 66 | 06/94 → 10/97 | D | 1Z, AHU | (+)COP |
| | 66 | 06/94 → 10/97 | D | 1Z, AHU | (+)COP, M: 1Z |
| 2.0 | 74 | 06/94 → 10/97 | B | AAE | (+)COP |
| | 79 | 08/95 → 07/96 | B | ADW | (+)COP |
| | 85 | 06/94 → 10/97 | B | ABK | (+)COP |
| 2.0 16V | 103 | 06/94 → 10/97 | B | ACE | (+)COP |
| 2.0 16V quattro | 103 | 06/94 → 10/97 | B | ACE | (+)COP |

Cabriolet

| | | | | | |
|---------|-----|---------------|---|---------|--------|
| 1.9 TDI | 66 | 06/95 → 08/00 | D | 1Z, AHU | (+)COP |
| 2.0 16V | 103 | 06/95 → 07/96 | B | ACE | (+)COP |
| 2.0 E | 85 | 01/93 → 07/98 | B | ABK | (+)COP |

Coupé II

| | | | | | |
|----------|-----|---------------|---|----------|--------|
| 2.0 | 82 | 03/90 → 07/90 | B | 3A | (+)COP |
| | 83 | 05/89 → 03/90 | B | 3A | (+)COP |
| | 85 | 05/89 → 12/96 | B | AAD, ABK | (+)COP |
| 2.0 16 V | 101 | 01/92 → 07/92 | B | 6A | (+)COP |
| | 103 | 08/92 → 12/96 | B | ACE | (+)COP |

FORD

| | | | | | |
|---------|----|---------------|---|--------------|-------------------|
| 1.9 TDI | 66 | 03/95 → 05/06 | D | 1Z, AHU, ANU | (+)COP |
| | 66 | 03/95 → 05/06 | D | 1Z, AHU, ANU | (+)COP, → 04-2000 |
| | 81 | 08/97 → 04/00 | D | AFN, AVG | (+)COP |
| | 81 | 08/97 → 04/00 | D | AFN, AVG | (+)COP, → 04-2000 |

SEAT
Alhambra I

| | | | | | |
|---------|----|---------------|---|--------------|---------------------------|
| 1.9 TDI | 66 | 04/96 → 03/10 | D | 1Z, AHU, ANU | (+)COP |
| | 66 | 04/96 → 03/10 | D | 1Z, AHU, ANU | (+)COP, → 07-2000 |
| | 81 | 08/96 → 06/00 | D | AFN, AVG | (+)COP |
| 2.0 i | 85 | 04/96 → 03/10 | B | ADY, ATM | (+)COP |
| | 85 | 04/96 → 03/10 | B | ADY, ATM | (+)COP, → 07-2000, M: ADY |

82080
350982080000

KW

SEAT
Cordoba I, Vario

| | | | | | |
|-----------|---------------|---------------|-----|-------------------|-------------------|
| 1.6 i | 55 | 05/94 → 06/99 | B | 1F | (+)COP |
| | 74 | 09/96 → 06/99 | B | AFT | (+)COP |
| | 74 | 07/96 → 10/99 | B | AFT, AKL | (+)COP |
| | 55 | 09/96 → 06/99 | B | AEE, ALM | (+)COP |
| 1.8 i | 66 | 02/93 → 06/99 | B | ABS, ACC, ADZ | (+)COP |
| | 66 | 02/93 → 06/99 | B | ABS, ACC, ADZ | (+)COP, 10-1993 → |
| 1.8 i 16V | 95 | 10/93 → 08/96 | B | ADL | (+)COP |
| | 95 | 10/93 → 08/96 | B | ADL | (+)COP, 10-1993 → |
| 1.9 D | 47 | 01/96 → 08/96 | D | 1Y | (+)COP |
| | 47 | 01/96 → 08/96 | D | 1Y | (+)COP, 06-1996 → |
| | 50 | 02/93 → 08/96 | D | 1Y | (+)COP |
| | 50 | 02/93 → 08/96 | D | 1Y | (+)COP, 10-1993 → |
| 1.9 SDI | 47 | 08/96 → 06/99 | D | AEY | (+)COP |
| | 47 | 08/96 → 06/99 | D | AEY | (+)COP, 05-1997 → |
| 1.9 TD | 55 | 02/93 → 08/96 | D | AAZ | (+)COP |
| | 55 | 02/93 → 08/96 | D | AAZ | (+)COP, 10-1993 → |
| 1.9 TDI | 66 | 08/96 → 06/99 | D | 1Z, AHU | (+)COP |
| | 66 | 08/96 → 06/99 | D | 1Z, AHU | (+)COP, 06-1996 → |
| | 81 | 03/97 → 06/99 | D | AFN | (+)COP |
| 2.0 i | 81 | 03/97 → 06/99 | D | AFN | (+)COP, 05-1997 → |
| | 85 | 02/93 → 06/99 | B | 2E, AGG | (+)COP |
| 2.0 i 16V | 85 | 02/93 → 06/99 | B | 2E, AGG | (+)COP, 10-1993 → |
| | 110 | 08/96 → 06/99 | B | ABF | (+)COP |
| 110 | 08/96 → 06/99 | B | ABF | (+)COP, 02-1997 → | |

Ibiza II

| | | | | | |
|-------|----|---------------|---|---------------|---------------------------|
| 1.6 i | 55 | 09/94 → 06/99 | B | 1F | (+)COP |
| | 74 | 04/96 → 08/99 | B | AFT | (+)COP |
| | 55 | 03/93 → 08/99 | B | ABU, AEE, ALM | (+)COP |
| | 55 | 03/93 → 08/99 | B | ABU, AEE, ALM | (+)COP, 01-1995 →, M: AEE |

82080
350982080000

SEAT
Ibiza II

| | | | | | |
|-----------|-----|---------------|---|---------------|------------------|
| 1.8 i | 66 | 03/93 → 08/99 | B | ABS, ACC, ADZ | (+)COP |
| | 66 | 03/93 → 08/99 | B | ABS, ACC, ADZ | (+)COP, 01-1993→ |
| 1.8 i 16V | 95 | 11/93 → 08/96 | B | ADL | (+)COP |
| 1.9 D | 47 | 04/93 → 08/96 | D | 1Y, AEY | (+)COP |
| | 50 | 10/94 → 08/96 | D | 1Y | (+)COP |
| 1.9 SDI | 47 | 08/96 → 08/99 | D | AEY | (+)COP |
| 1.9 TD | 55 | 03/93 → 08/96 | D | AAZ | (+)COP |
| 2.0 i | 85 | 03/93 → 08/99 | B | 2E, AGG | (+)COP |
| 2.0 i 16V | 110 | 08/96 → 08/99 | B | ABF | (+)COP |

Inca

| | | | | | |
|---------|----|---------------|---|--------------|------------------|
| 1.6 i | 55 | 11/95 → 05/98 | B | 1F | (+)COP |
| | 55 | 11/95 → 05/98 | B | 1F | (+)COP, 11-1995→ |
| 1.7 D | 42 | 09/96 → 06/03 | D | AHB | (+)COP |
| 1.9 D | 47 | 11/95 → 06/03 | D | 1Y | (+)COP |
| | 47 | 11/95 → 06/03 | D | 1Y | (+)COP, 11-1995→ |
| 1.9 SDI | 47 | 11/95 → 06/03 | D | 1Y, AEY, AYQ | (+)COP |
| | 47 | 11/95 → 06/03 | D | 1Y, AEY, AYQ | (+)COP, 11-1995→ |

Toledo I

| | | | | | |
|---------|----|---------------|---|---------------|------------------|
| 1.8 16V | 52 | 05/91 → 12/93 | B | 1F | (+)COP |
| | 54 | 05/91 → 03/99 | B | 1F, ABN, EZ | (+)COP |
| | 54 | 05/91 → 03/99 | B | 1F, ABN, EZ | (+)COP, 05-1991→ |
| | 55 | 01/93 → 03/99 | B | 1F | (+)COP |
| | 55 | 01/93 → 03/99 | B | 1F | (+)COP, 05-1991→ |
| | 74 | 11/96 → 03/99 | B | AFT | (+)COP |
| 1.8 GT | 92 | 05/91 → 03/99 | B | PL | (+)COP |
| | 92 | 05/91 → 03/99 | B | PL | (+)COP, 05-1991→ |
| | 98 | 05/91 → 03/99 | B | KR | (+)COP |
| 1.8 i | 98 | 05/91 → 03/99 | B | KR | (+)COP, 05-1991→ |
| | 65 | 05/91 → 12/96 | B | RP | (+)COP |
| 1.8 i | 66 | 11/93 → 12/96 | B | ABS, ACC, ADZ | (+)COP |

82080
350982080000

SEAT
Toledo I

| | | | | | |
|-----------|-----|---------------|---|---------|------------------|
| 1.9 D | 47 | 12/95 → 03/99 | D | 1Y | (+)COP |
| | 47 | 12/95 → 03/99 | D | 1Y | (+)COP, 05-1991→ |
| | 50 | 05/91 → 03/99 | D | 1Y | (+)COP |
| 1.9 TD | 50 | 05/91 → 03/99 | D | 1Y | (+)COP, 05-1991→ |
| | 55 | 05/91 → 03/99 | D | AAZ | (+)COP |
| 1.9 TDI | 55 | 05/91 → 03/99 | D | AAZ | (+)COP, 05-1991→ |
| | 66 | 08/95 → 03/99 | D | 1Z, AHU | (+)COP |
| 2.0 i | 66 | 08/95 → 03/99 | D | 1Z, AHU | (+)COP, 05-1991→ |
| | 81 | 11/96 → 03/99 | D | AFN | (+)COP |
| 2.0 i 16V | 81 | 11/96 → 03/99 | D | AFN | (+)COP, 05-1991→ |
| | 85 | 05/91 → 03/99 | B | 2E, AGG | (+)COP |
| 2.0 i 16V | 110 | 11/93 → 03/99 | B | ABF | (+)COP |
| | 110 | 11/93 → 03/99 | B | ABF | (+)COP, 01-1997→ |

VOLKSWAGEN
Caddy I

| | | | | | |
|-------|----|---------------|---|--------|--------|
| 1.6 | 55 | 01/83 → 07/92 | B | EW | (+)COP |
| 1.6 D | 40 | 08/82 → 07/92 | D | JK, ME | (+)COP |
| 1.8 | 70 | 08/85 → 07/92 | B | JH | (+)COP |

| | | | | | |
|---------|----|---------------|---|---------------|----------------|
| 1.6 | 55 | 11/95 → 05/97 | B | 1F | (+)COP |
| 1.7 SDI | 42 | 07/96 → 09/00 | D | AHB | (+)COP |
| 1.9 D | 47 | 11/95 → 01/04 | D | 1Y | (+)COP |
| 1.9 SDI | 47 | 11/95 → 01/04 | D | AEY, AYQ | (+)COP |
| | 47 | 11/95 → 01/04 | D | AEY, AYQ | (+)COP, M: AEY |
| 1.9 TDI | 66 | 09/96 → 01/04 | D | 1Z, AHU, ALH | (+)COP |
| | 66 | 10/96 → 01/04 | D | AHU, ALE, ALH | (+)COP |
| 75 1.6 | 55 | 11/95 → 05/97 | B | 1F | (+)COP |

Corrado

| | | | | | |
|-----------|-----|---------------|---|---------|--------|
| 1.8 16V | 100 | 04/89 → 07/92 | B | KR | (+)COP |
| 1.8 G60 | 118 | 09/88 → 09/93 | B | PG | (+)COP |
| 2.0 i | 85 | 04/93 → 12/95 | B | 2E, ADY | (+)COP |
| 2.0 i 16V | 100 | 08/91 → 12/95 | B | 9A | (+)COP |

82080
350982080000

KW

VOLKSWAGEN
Golf I, Cabrio

| | | | | | |
|-----|----|---------------|---|--------|--------|
| 1.6 | 53 | 04/86 → 02/90 | B | RE | (+)COP |
| | 55 | 08/83 → 04/92 | B | EW, HN | (+)COP |
| 1.8 | 66 | 08/83 → 09/92 | B | EX | (+)COP |
| | 70 | 08/83 → 04/93 | B | JH | (+)COP |
| | 72 | 08/89 → 03/93 | B | 2H | (+)COP |

Golf II

| | | | | | |
|--------------------|-----|---------------|---|----------------|--------|
| 1.6 | 51 | 10/86 → 12/92 | B | PN | (+)COP |
| | 53 | 02/86 → 10/91 | B | RF | (+)COP |
| | 55 | 08/83 → 07/92 | B | ABN, EZ, HM | (+)COP |
| 1.6 D | 37 | 08/83 → 10/91 | D | | (+)COP |
| | 40 | 08/83 → 10/91 | D | JP, ME | (+)COP |
| 1.6 TD | 51 | 08/83 → 10/91 | D | JR, MF | (+)COP |
| | 59 | 04/89 → 10/91 | D | RA, SB | (+)COP |
| | 44 | 08/89 → 10/91 | D | 1V | (+)COP |
| 1.8 | 62 | 08/86 → 01/90 | B | RH | (+)COP |
| | 66 | 08/84 → 10/91 | B | GU, GX, HV | (+)COP |
| 1.8 GTI | 82 | 08/83 → 10/91 | B | DX, EV, GZ, PB | (+)COP |
| 1.8 GTI 16V | 95 | 02/86 → 10/91 | B | PL | (+)COP |
| | 102 | 02/86 → 06/90 | B | KR | (+)COP |
| 1.8 GTI Cat. | 79 | 01/87 → 10/91 | B | PF | (+)COP |
| 1.8 GTI G60 | 118 | 04/90 → 07/91 | B | PG | (+)COP |
| 1.8 GTI G60 Syncro | 118 | 08/88 → 12/91 | B | 1H, PG | (+)COP |
| 1.8 i Cat. | 66 | 08/87 → 10/91 | B | GX, RP | (+)COP |
| 1.8 i Syncro Cat. | 66 | 08/87 → 10/91 | B | RP | (+)COP |
| 1.8 Syncro | 66 | 02/86 → 07/91 | B | GU, GX | (+)COP |
| | 72 | 08/88 → 07/91 | B | 1P | (+)COP |
| 2.0 | 57 | 08/85 → 07/92 | B | | (+)COP |

Golf III, Variant, Cabrio

| | | | | | |
|-----|----|---------------|---|---------------|---------------------|
| 1.6 | 74 | 10/94 → 05/98 | B | AEK, AFT, AKS | (+)COP, 05-1996 → |
| | 74 | 07/95 → 08/97 | B | AEK, AFT, AKS | (+)COP |
| | 74 | 07/95 → 08/97 | B | AEK, AFT, AKS | (+)COP, M: AEK -AFT |

82080
350982080000

KW

VOLKSWAGEN
Golf III, Variant, Cabrio

| | | | | | |
|----------------|---------------|---------------|-----|------------------------|-------------------|
| 1.8 | 55 | 11/91 → 08/97 | B | AAM | (+)COP |
| | 55 | 07/93 → 04/99 | B | AAM, ANN | (+)COP |
| | 66 | 11/91 → 08/97 | B | ABS, ACC, ADZ | (+)COP |
| | 66 | 07/93 → 05/98 | B | ABS, ADZ | (+)COP |
| | 66 | 07/93 → 04/99 | B | ABS, ADZ, ANP | (+)COP |
| 1.8 Syncro | 66 | 10/94 → 04/99 | B | ADZ | (+)COP |
| | 66 | 01/93 → 08/97 | B | ABS, ADZ | (+)COP |
| 1.9 D | 48 | 11/91 → 08/97 | D | 1Y | (+)COP |
| | 48 | 11/91 → 08/97 | D | 1Y | (+)COP, → 07-1995 |
| 1.9 SDI | 47 | 07/95 → 08/97 | D | AEY | (+)COP |
| 1.9 TD | 55 | 07/93 → 04/99 | D | AAZ | (+)COP |
| | 55 | 07/93 → 04/99 | D | AAZ | (+)COP, → 07-1995 |
| 1.9 TD, GTD | 55 | 11/91 → 08/97 | D | AAZ | (+)COP |
| | 55 | 11/91 → 08/97 | D | AAZ | (+)COP, → 07-1995 |
| 1.9 TDI | 66 | 09/93 → 08/97 | D | 1Z, AHU, ALE | (+)COP |
| | 66 | 09/93 → 08/97 | D | 1Z, AHU, ALE | (+)COP, → 07-1995 |
| | 66 | 08/95 → 05/98 | D | 1Z, AHU, ALE | (+)COP, M: 1Z |
| | 81 | 04/96 → 08/97 | D | AFN | (+)COP |
| 1.9 TDI Syncro | 66 | 07/95 → 04/99 | D | 1Z, AHU, ALE | (+)COP |
| | 66 | 07/95 → 04/99 | D | 1Z, AHU, ALE | (+)COP, → 07-1995 |
| 2.0 | 79 | 08/95 → 04/96 | B | AEP | (+)COP |
| | 85 | 11/91 → 08/97 | B | 2E, ABA, ADY, AGG, AKR | (+)COP |
| | 85 | 07/93 → 05/98 | B | 2E, ADY, AGG, AKR | (+)COP |
| 2.0 GTI 16V | 85 | 07/93 → 05/98 | B | 2E, ADY, AGG, AKR | (+)COP, 08-1991 → |
| | 110 | 08/92 → 08/97 | B | ABF | (+)COP |
| 110 | 08/92 → 08/97 | B | ABF | (+)COP, 08-1991 → | |

82080
350982080000

VOLKSWAGEN
Golf III, Variant, Cabrio

| | | | | | |
|------------|----|---------------|---|-----|-------------------|
| 2.0 Syncro | 85 | 08/95 → 04/99 | B | AGG | (+)COP |
| | 85 | 08/95 → 04/99 | B | AGG | (+)COP, 08-1991 → |
| | 85 | 08/95 → 08/97 | B | AGG | (+)COP |
| | 85 | 08/95 → 08/97 | B | AGG | (+)COP, 08-1991 → |

Golf IV, Variant, Cabrio

| | | | | | |
|---------|----|---------------|---|-------------------------|-------------------|
| 1.6 | 74 | 06/98 → 06/02 | B | AFT, AKS | (+)COP |
| | 74 | 06/98 → 06/02 | B | AFT, AKS | (+)COP, 05-1996 → |
| 1.8 | 55 | 06/98 → 06/02 | B | AAM, ANN | (+)COP |
| | 55 | 06/98 → 06/02 | B | AAM, ANN | (+)COP, 11-1991 → |
| | 66 | 06/98 → 06/02 | B | ADZ, ANP | (+)COP |
| | 66 | 06/98 → 06/02 | B | ADZ, ANP | (+)COP, 11-1991 → |
| 1.9 TDI | 66 | 06/98 → 06/02 | D | AHU, ALE | (+)COP |
| | 81 | 06/98 → 06/02 | D | AFN, AVG | (+)COP |
| 2.0 | 85 | 06/98 → 06/02 | B | AGG, AKR, ATU, AWF, AWG | (+)COP |
| | 85 | 06/98 → 06/02 | B | AGG, AKR, ATU, AWF, AWG | (+)COP, 08-1991 → |

Jetta II

| | | | | | |
|------------|----|---------------|---|-------------|--------|
| 1.6 | 51 | 10/86 → 10/91 | B | PN | (+)COP |
| | 53 | 03/86 → 10/91 | B | RF | (+)COP |
| | 55 | 01/84 → 07/92 | B | ABN, EZ, HM | (+)COP |
| 1.6 D | 40 | 01/84 → 10/91 | D | JP, ME | (+)COP |
| 1.6 TD | 51 | 01/84 → 10/91 | D | JR, MF | (+)COP |
| | 59 | 04/89 → 10/91 | D | RA, SB | (+)COP |
| | 44 | 01/90 → 10/91 | D | 1V | (+)COP |
| 1.8 | 62 | 08/86 → 01/90 | B | RH | (+)COP |
| | 66 | 08/84 → 10/91 | B | GU, GX, HV | (+)COP |
| | 82 | 01/84 → 10/91 | B | EV, GZ, PB | (+)COP |
| 1.8 16V | 95 | 08/86 → 10/91 | B | PL | (+)COP |
| 1.8 Cat. | 66 | 08/87 → 10/91 | B | GX, RP | (+)COP |
| | 79 | 01/87 → 10/91 | B | PF | (+)COP |
| 1.8 Syncro | 72 | 08/88 → 07/91 | B | 1P | (+)COP |

Passat III, Variant

| | | | | | |
|--------|----|---------------|---|----------|--------|
| 1.6 | 53 | 02/88 → 09/91 | B | 1F, EZ | (+)COP |
| | 74 | 10/94 → 08/96 | B | AEK, AFT | (+)COP |
| 1.6 TD | 59 | 08/88 → 09/93 | D | RA, SB | (+)COP |

82080
350982080000

VOLKSWAGEN
Passat III, Variant

| | | | | | |
|----------------|-----|---------------|---|-------------------|--------|
| 1.8 | 55 | 08/90 → 08/96 | B | AAM | (+)COP |
| | 66 | 02/88 → 08/96 | B | ABS, ADZ, RP | (+)COP |
| | 79 | 04/88 → 07/93 | B | PF | (+)COP |
| | 82 | 04/88 → 07/92 | B | PB | (+)COP |
| | 102 | 08/91 → 09/93 | B | KR | (+)COP |
| 1.8 G60 Syncro | 118 | 08/88 → 08/96 | B | PG | (+)COP |
| 1.8 GL | 102 | 08/91 → 09/93 | B | KR | (+)COP |
| 1.9 D | 50 | 05/89 → 10/93 | D | 1Y | (+)COP |
| 1.9 TD | 55 | 03/91 → 08/96 | D | AAZ | (+)COP |
| 1.9 TDI | 66 | 10/93 → 08/96 | D | 1Z, AHU | (+)COP |
| | 81 | 03/96 → 08/96 | D | AFN | (+)COP |
| 2.0 | 79 | 03/95 → 08/96 | B | AEP | (+)COP |
| | 85 | 02/90 → 10/96 | B | 2E, ABA, ADY, AGG | (+)COP |
| | 85 | 02/90 → 05/97 | B | 2E, ADY, AGG | (+)COP |
| 2.0 16V | 125 | 04/88 → 07/91 | B | | (+)COP |
| | 100 | 08/88 → 09/93 | B | 9A | (+)COP |
| 2.0 Syncro | 110 | 01/94 → 08/96 | B | ABF | (+)COP |
| | 81 | 09/89 → 07/92 | B | | (+)COP |
| 2.0 Syncro | 85 | 10/90 → 08/96 | B | 2E, ADY, AGG | (+)COP |

Polo III (6N1), Classic, Variant, Van

| | | | | | |
|---------|----|---------------|---|-------------------------|--------------------|
| 1.6 | 74 | 05/97 → 09/01 | B | AEH, AFT, AKL, APF, AUR | (+)COP |
| | 74 | 05/97 → 09/01 | B | AEH, AFT, AKL, APF, AUR | (+)COP, M: AFT AUR |
| 1.7 SDI | 42 | 08/97 → 09/01 | D | AKW | (+)COP |
| 1.8 | 66 | 05/97 → 09/01 | B | ADZ | (+)COP |
| | 47 | 06/97 → 09/01 | D | AEY | (+)COP |
| 1.9 SDI | 48 | 06/96 → 09/01 | D | AEY | (+)COP |
| | 66 | 05/97 → 09/01 | D | AGR, AHU, ALE, ALH | (+)COP |
| | 66 | 05/97 → 09/01 | D | AGR, AHU, ALE, ALH | (+)COP, M: ALE |
| 100 1.6 | 74 | 12/95 → 09/01 | B | AEH, AFT, AKL, APF, AUR | (+)COP |
| | 74 | 12/95 → 09/01 | B | AEH, AFT, AKL, APF, AUR | (+)COP, M: AFT AUR |

82080 350982080000

VOLKSWAGEN
Polo III (6N1), Classic, Variant, Van

| | | | | | |
|-------------|----|---------------|---|--------------------|----------------|
| 110 1.9 TDI | 81 | 06/98 → 01/02 | D | AFN, ASV | (+)COP |
| 57 1.7 SDI | 42 | 07/97 → 09/01 | D | AKW | (+)COP |
| 64 1.9 D | 47 | 01/96 → 10/96 | D | 1Y | (+)COP |
| 64 1.9 SDI | 47 | 12/95 → 08/99 | D | 1Y, AEY | (+)COP |
| 75 1.6 | 55 | 11/95 → 09/97 | B | 1F | (+)COP |
| 90 1.8 | 66 | 01/97 → 09/01 | B | ABS, ADD, ADZ | (+)COP |
| 90 1.9 TDI | 66 | 09/96 → 09/01 | D | AGR, AHU, ALE, ALH | (+)COP |
| | 66 | 09/96 → 09/01 | D | AGR, AHU, ALE, ALH | (+)COP, M: ALE |

Scirocco II

| | | | | | |
|---------|----|---------------|---|----|--------|
| 1.6 | 53 | 04/86 → 07/90 | B | RE | (+)COP |
| 1.8 | 66 | 08/83 → 07/92 | B | EX | (+)COP |
| | 70 | 11/85 → 07/92 | B | JH | (+)COP |
| 1.8 16V | 95 | 03/86 → 07/92 | B | PL | (+)COP |

Sharan I

| | | | | | |
|---------|----|---------------|---|--------------|---|
| 1.9 TDI | 66 | 09/95 → 03/10 | D | 1Z, AHU, ANU | (+)COP |
| | 66 | 09/95 → 03/10 | D | 1Z, AHU, ANU | (+)COP, 09-1995 →, → 03-2000, M: 1Z, M: AHU |
| | 81 | 09/96 → 04/00 | D | AFN, AVG | (+)COP |
| 2.0 | 85 | 09/95 → 03/10 | B | ADY, ATM | (+)COP |
| | 85 | 09/95 → 03/10 | B | ADY, ATM | (+)COP, 09-1995 →, → 02-2000, M: ADY |

Transporter III

| | | | | | |
|---------------|----|---------------|---|----|----------------------|
| 1.6 TD | 51 | 08/84 → 07/92 | D | JX | (+)COP |
| | 51 | 08/84 → 07/92 | D | JX | (+)COP, M →: 012.053 |
| 1.6 TD Syncro | 51 | 03/86 → 07/92 | D | JX | (+)COP |
| | 51 | 03/86 → 07/92 | D | JX | (+)COP, M →: 012.053 |
| 1.7 D | 42 | 10/86 → 07/92 | D | KY | (+)COP |

Transporter IV

| | | | | | |
|--------|----|---------------|---|-----|-------------------|
| 1.8 | 49 | 12/90 → 07/92 | B | PD | (+)COP |
| 1.9 D | 44 | 09/90 → 12/95 | D | 1X | (+)COP |
| | 45 | 07/90 → 12/95 | D | 1X | (+)COP |
| 1.9 TD | 50 | 10/92 → 04/03 | D | ABL | (+)COP |
| 2.0 | 62 | 07/90 → 04/03 | B | AAC | (+)COP, 09-1990 → |
| | 62 | 09/90 → 04/03 | B | AAC | (+)COP |

82080 350982080000

VOLKSWAGEN
Vento

| | | | | | |
|---------|----|---------------|---|-------------------|--------|
| 1.6 | 74 | 10/94 → 09/98 | B | AEK, AFT | (+)COP |
| 1.8 | 55 | 11/91 → 09/98 | B | AAM | (+)COP |
| | 66 | 11/91 → 09/98 | B | ABS, ADZ | (+)COP |
| 1.9 D | 48 | 11/91 → 09/98 | D | 1Y | (+)COP |
| 1.9 SDI | 47 | 04/97 → 09/98 | D | AEY | (+)COP |
| 1.9 TD | 55 | 11/91 → 09/98 | D | AAZ | (+)COP |
| 1.9 TDI | 66 | 09/93 → 09/98 | D | 1Z, AHU, ALE | (+)COP |
| | 81 | 04/96 → 09/98 | D | AFN | (+)COP |
| 2.0 | 85 | 11/91 → 09/98 | B | 2E, ADY, AGG, AKR | (+)COP |
| 2.0 GL | 62 | 11/91 → 07/98 | B | AAC | (+)COP |
| | 79 | 05/96 → 12/97 | B | AEP | (+)COP |

82081 350982081000

| | | |
|--|---|--|
| | PULEGGIA | |
| | Diametro Puleggia Ø66 Altezza Puleggia 30.5 Posizione Attacco 60.8 Diametro Girante Ø79 N° Alette Girante 5 Posizione Girante 29.4 | |

AUDI
A6 II, Avant

| | | | | | |
|------------------|-----|---------------|---|---------------|-----------|
| 3.7 | 191 | 03/99 → 01/05 | B | AQG | |
| 3.7 quattro | 191 | 03/99 → 01/05 | B | AQG | |
| 4.2 quattro | 220 | 11/98 → 01/05 | B | ARS, ASG, AWN | 04-1999 → |
| | 220 | 11/98 → 01/05 | B | ARS, ASG, AWN | |
| RS6 plus quattro | 353 | 04/04 → 01/05 | B | BRV | |
| RS6 quattro | 331 | 07/02 → 01/05 | B | BCY | |
| S6 quattro | 250 | 09/99 → 01/05 | B | ANK, AQJ | 04-1999 → |
| | 250 | 09/99 → 01/05 | B | ANK, AQJ | |

A8 I

| | | | | | |
|-------------|-----|---------------|---|---------------|--|
| 3.7 | 191 | 11/98 → 09/02 | B | AKC, AQG | |
| 3.7 quattro | 191 | 11/98 → 09/02 | B | AKC, AQG | |
| | 175 | 02/99 → 04/00 | B | ARU | |
| 4.2 quattro | 228 | 11/98 → 09/02 | B | AQF, AUW, AUX | |

82081 350982081000



AUDI

A8 I

| | | | | |
|-------------|-----|---------------|---|----------|
| S 8 quattro | 265 | 06/99 → 09/02 | B | AQH, AVP |
|-------------|-----|---------------|---|----------|

A8 II

| | | | | |
|-------------|-----|---------------|---|-----|
| 3.7 quattro | 206 | 10/02 → 05/06 | B | BFL |
|-------------|-----|---------------|---|-----|

| | | | | |
|-------------|-----|---------------|---|-----|
| 4.2 quattro | 246 | 10/02 → 07/10 | B | BFM |
|-------------|-----|---------------|---|-----|

VOLKSWAGEN

Phaeton

| | | | | |
|----------------|-----|---------|---|----------|
| 4.2 V8 4motion | 246 | 05/03 → | B | BGH, BGJ |
|----------------|-----|---------|---|----------|

Touareg I

| | | | | |
|--------|-----|---------------|---|----------|
| 4.2 V8 | 228 | 12/02 → 11/06 | B | AXQ, BHX |
|--------|-----|---------------|---|----------|

82082 350982082000



PULEGGIA

| | |
|-------------------|-------|
| Diametro Puleggia | Ø90 |
| Altezza Puleggia | 34.5 |
| Posizione Attacco | 74.8 |
| Diametro Girante | Ø73.5 |
| N° Alette Girante | 6 |
| Posizione Girante | 12.45 |



MERCEDES-BENZ

Classe C II (W203), Station Wagon (S203), Coupé (CL203)

| | | | | |
|-----------|----|---------------|---|----------------------|
| C 200 CDI | 75 | 03/01 → 08/07 | D | OM611.962, OM646.962 |
|-----------|----|---------------|---|----------------------|

Classe C III (W204), Station Wagon (S204), Coupé (C204)

| | | | | |
|-----------|-----|---------------|---|----------------------|
| C 200 CDI | 100 | 08/07 → 12/11 | D | OM646.811 |
| | 100 | 01/07 → 12/10 | D | OM646.811, OM646.812 |
| | 120 | 01/07 → 11/08 | D | OM646.811 |
| | 125 | 01/07 → 11/08 | D | OM646.811 |

Classe CLC

| | | | | |
|-------------|-----|---------------|---|-----------|
| CLC 200 CDI | 90 | 05/08 → 06/11 | D | OM646.962 |
| | 110 | 05/08 → 06/11 | D | OM646.963 |

Classe E III (W211), Station Wagon (S211)

| | | | | |
|-----------|-----|---------------|---|-----------|
| E 200 CDI | 75 | 07/02 → 12/08 | D | OM646.951 |
| | 90 | 07/02 → 12/08 | D | OM646.951 |
| | 100 | 04/06 → 12/08 | D | OM646.820 |
| | 100 | 04/06 → 07/09 | D | OM646.821 |

82082 350982082000



MERCEDES-BENZ

Classe E III (W211), Station Wagon (S211)

| | | | | |
|-------------|-----|---------------|---|-----------|
| E 220 CDI | 120 | 03/03 → 12/08 | D | OM646.821 |
| | 100 | 03/02 → 12/08 | D | OM646.961 |
| | 110 | 03/02 → 12/08 | D | OM646.961 |
| | 125 | 04/06 → 12/08 | D | OM646.821 |
| E 220 T CDI | 120 | 03/03 → 07/09 | D | OM646.821 |
| | 110 | 03/03 → 07/09 | D | OM646.961 |
| | 125 | 04/06 → 07/09 | D | OM646.821 |
| E 270 CDI | 120 | 03/02 → 12/08 | D | OM647.961 |
| E 270 T CDI | 120 | 03/03 → 07/09 | D | OM647.961 |

CLK II (C209), Cabrio (A209)

| | | | | |
|---------|-----|---------------|---|-----------|
| 220 CDI | 100 | 01/05 → 05/09 | D | OM646.966 |
| | 110 | 01/05 → 05/09 | D | OM646.966 |

82083 350982083000



FLANGIA

| | |
|-------------------------|---------|
| Numero Fori Flangia | 3 |
| Dimensione Fori Flangia | M8x1.25 |
| Posizione Attacco | 46.5 |
| Diametro Mozzo | Ø30 |
| Diametro Girante | Ø54 |
| N° Alette Girante | 8 |
| Posizione Girante | 27 |



ALFA ROMEO

159, Sportwagon

| | | | | |
|---------|-----|---------------|---|-----------|
| 1.8 MPI | 103 | 03/07 → 11/11 | B | 939A4.000 |
|---------|-----|---------------|---|-----------|

CHEVROLET

Aveo II

| | | | | |
|-----|----|---------|---|-------|
| 1.6 | 85 | 03/11 → | B | F16D4 |
|-----|----|---------|---|-------|

Cruze II, Hatchback, Station Wagon

| | | | | |
|-----|-----|---------|---|-----------------|
| 1.6 | 80 | 05/09 → | B | F16D3, LXT, LXV |
| | 80 | 01/12 → | B | LXT |
| | 83 | 05/09 → | B | F16D4 |
| | 86 | 12/12 → | B | F16D4 |
| | 86 | 12/12 → | B | LDE |
| | 91 | 06/11 → | B | F16D4 |
| | 91 | 05/09 → | B | F16D4, LDE |
| | 91 | 08/12 → | B | LDE |
| 1.8 | 104 | 08/12 → | B | 2H0 |
| | 104 | 05/09 → | B | 2H0, F18D4 |
| | 104 | 06/11 → | B | F18D4 |

82083 350982083000

CHEVROLET
Cruze II, Hatchback, Station Wagon

| | | | | |
|---------|-----|---------|--|------------|
| 1.8 LPG | 104 | 06/11 → | | 2H0, F18D4 |
| | 104 | 06/11 → | | F18D4 |

Trax

| | | | | |
|-----|----|---------|---|------------|
| 1.6 | 85 | 12/12 → | B | F16D4, LDE |
|-----|----|---------|---|------------|

FIAT
Croma II

| | | | | |
|---------|-----|---------|---|-----------|
| 1.8 16V | 103 | 12/05 → | B | 939A4.000 |
|---------|-----|---------|---|-----------|

Stilo, Station Wagon

| | | | | |
|---------|----|---------------|---|-----------|
| 1.6 16V | 77 | 03/05 → 12/07 | B | 192B3.000 |
|---------|----|---------------|---|-----------|

OPEL
Astra G, Station Wagon, Coupé, Cabrio, Van

| | | | | |
|-----|----|---------------|---|--------|
| 1.6 | 76 | 12/02 → 12/09 | B | Z16XEP |
|-----|----|---------------|---|--------|

| | | | | |
|---------|----|---------------|---|--------|
| 1.6 16V | 76 | 03/00 → 05/05 | B | Z16XEP |
|---------|----|---------------|---|--------|

Astra H, Station Wagon, GTC, Twin Top, Van

| | | | | |
|-----|----|---------------|---|--------|
| 1.6 | 76 | 02/04 → 11/04 | B | Z16XEP |
|-----|----|---------------|---|--------|

| | | | |
|----|---------|---|----------------|
| 77 | 03/04 → | B | Z16XE1, Z16XEP |
|----|---------|---|----------------|

| | | | |
|----|---------|---|----------------|
| 85 | 12/06 → | B | A16XER, Z16XER |
|----|---------|---|----------------|

| | | | |
|----|---------|---|--------|
| 85 | 12/06 → | B | Z16XER |
|----|---------|---|--------|

| | | | | |
|---------|----|---------|--|--------|
| 1.6 LPG | 85 | 08/09 → | | Z16XER |
|---------|----|---------|--|--------|

| | | | | |
|-----------|-----|---------|---|--------|
| 1.6 Turbo | 132 | 02/07 → | B | Z16LET |
|-----------|-----|---------|---|--------|

| | | | | |
|-----|----|---------|---|-------|
| 1.8 | 92 | 03/04 → | B | Z18XE |
|-----|----|---------|---|-------|

| | | | |
|-----|---------|---|----------------|
| 103 | 01/06 → | B | A18XER, Z18XER |
|-----|---------|---|----------------|

| | | | |
|-----|---------|---|--------|
| 103 | 01/06 → | B | Z18XER |
|-----|---------|---|--------|

Astra J, Station Wagon, GTC

| | | | | |
|-----|----|---------|---|----------------|
| 1.6 | 85 | 12/09 → | B | A16XER, B16XER |
|-----|----|---------|---|----------------|

| | | | |
|-----|---------|---|--------|
| 132 | 10/11 → | B | A16LET |
|-----|---------|---|--------|

| | | | | |
|-----------|-----|---------|---|--------|
| 1.6 Turbo | 132 | 12/09 → | B | A16LET |
|-----------|-----|---------|---|--------|

| | | | | |
|-----|-----|---------|---|--------|
| 1.8 | 103 | 10/11 → | B | A18XER |
|-----|-----|---------|---|--------|

| | | | | |
|-----------|-----|---------|---|----------------|
| 1.6 Turbo | 110 | 02/07 → | B | A16LEL, Z16LEL |
|-----------|-----|---------|---|----------------|

| | | | |
|-----|---------|---|------------------------|
| 141 | 02/07 → | B | A16LER, B16LER, Z16LER |
|-----|---------|---|------------------------|

| | | | |
|-----|---------|---|----------------|
| 155 | 06/11 → | B | A16LES, B16LES |
|-----|---------|---|----------------|

Corsa E, Van

| | | | | |
|-----------|-----|---------|---|--------|
| 1.6 Turbo | 152 | 03/15 → | B | B16LES |
|-----------|-----|---------|---|--------|

82083 350982083000

OPEL
Insignia, Station Wagon

| | | | | |
|-----|----|---------|---|--------|
| 1.6 | 85 | 07/08 → | B | A16XER |
|-----|----|---------|---|--------|

| | | | | |
|-----------|-----|---------|---|--------|
| 1.6 Turbo | 132 | 07/08 → | B | A16LET |
|-----------|-----|---------|---|--------|

| | | | | |
|-----|-----|---------|---|--------|
| 1.8 | 103 | 07/08 → | B | A18XER |
|-----|-----|---------|---|--------|

Meriva A

| | | | | |
|-----|----|---------------|---|--------|
| 1.6 | 77 | 01/06 → 05/10 | B | Z16XEP |
|-----|----|---------------|---|--------|

| | | | | |
|-----------|-----|---------------|---|--------|
| 1.6 Turbo | 132 | 09/05 → 05/10 | B | Z16LET |
|-----------|-----|---------------|---|--------|

Mokka

| | | | | |
|-----|----|---------|---|----------------|
| 1.6 | 85 | 06/12 → | B | A16XER, B16XER |
|-----|----|---------|---|----------------|

| | | | | |
|-----|-----|---------|---|--------|
| 1.8 | 103 | 01/13 → | B | A18XER |
|-----|-----|---------|---|--------|

| | | | | |
|---------|-----|---------|---|--------|
| 1.8 4x4 | 103 | 01/13 → | B | A18XER |
|---------|-----|---------|---|--------|

Signum

| | | | | |
|-----|-----|---------|---|--------|
| 1.8 | 103 | 09/05 → | B | Z18XER |
|-----|-----|---------|---|--------|

Vectra C, Station Wagon

| | | | | |
|-----|----|---------|---|--------|
| 1.6 | 77 | 01/06 → | B | Z16XEP |
|-----|----|---------|---|--------|

| | | | | |
|-----|-----|---------|---|--------|
| 1.8 | 103 | 01/06 → | B | Z18XER |
|-----|-----|---------|---|--------|

Zafira B, Van

| | | | | |
|-----|----|---------|---|----------------|
| 1.6 | 77 | 07/05 → | B | Z16XE1, Z16XEP |
|-----|----|---------|---|----------------|

| | | | |
|----|---------|---|----------------|
| 85 | 01/08 → | B | A16XER, Z16XER |
|----|---------|---|----------------|

| | | | | |
|---------------|-----|---------|--|----------------|
| 1.6 CNG Turbo | 110 | 02/09 → | | A16XNT, Z16XNT |
|---------------|-----|---------|--|----------------|

| | | | | |
|-----|----|---------|---|--------|
| 1.8 | 88 | 06/13 → | B | A18XEL |
|-----|----|---------|---|--------|

| | | | |
|-----|---------|---|----------------|
| 103 | 07/05 → | B | A18XER, Z18XER |
|-----|---------|---|----------------|

| | | | | |
|---------------|-----|---------|--|----------------|
| 1.6 CNG Turbo | 110 | 02/09 → | | A16XNT, Z16XNT |
|---------------|-----|---------|--|----------------|

| | | | | |
|-----|----|---------|---|--------|
| 1.8 | 88 | 06/13 → | B | A18XEL |
|-----|----|---------|---|--------|

| | | | |
|-----|---------|---|----------------|
| 103 | 07/05 → | B | A18XER, Z18XER |
|-----|---------|---|----------------|

| | | | | |
|-----|-----|---------|---|----------------|
| 1.8 | 103 | 07/05 → | B | A18XER, Z18XER |
|-----|-----|---------|---|----------------|

| | | | | |
|-----|-----|---------|---|----------------|
| 1.8 | 103 | 07/05 → | B | A18XER, Z18XER |
|-----|-----|---------|---|----------------|

Zafira C

| | | | | |
|---------|-----|---------|--|----------------|
| 1.6 CNG | 110 | 10/11 → | | A16XNT, B16XNT |
|---------|-----|---------|--|----------------|

| | | | | |
|-----|----|---------|---|--------|
| 1.8 | 85 | 10/11 → | B | A18XEL |
|-----|----|---------|---|--------|

| | | | |
|----|---------|---|--------|
| 88 | 10/11 → | B | A18XEL |
|----|---------|---|--------|

| | | | |
|-----|---------|---|--------|
| 103 | 10/11 → | B | A18XER |
|-----|---------|---|--------|

| | | | | |
|---------|-----|---------|--|--------|
| 1.8 LPG | 101 | 10/11 → | | A18XER |
|---------|-----|---------|--|--------|

| | | | | |
|---------|-----|---------|--|--------|
| 1.8 LPG | 101 | 10/11 → | | A18XER |
|---------|-----|---------|--|--------|

SAAB
9-5 II, Station Wagon

| | | | | |
|-----------|-----|---------------|---|--------|
| 1.6 Turbo | 132 | 05/10 → 01/12 | B | A16LET |
|-----------|-----|---------------|---|--------|

VAUXHALL
ASTRA

| | | | | |
|-----|----|---------|---|----------------|
| 1.6 | 85 | 12/09 → | B | A16XER, B16XER |
|-----|----|---------|---|----------------|

82083
350982083000

VAUXHALL
ASTRA

| | | | | | |
|-----------|-----|---------------|---|--|-------------------------|
| 1.6 16V | 74 | 09/98 → 05/05 | B | C16SEL, X16XEL, Z16XE, Z16XEP | 05-2004 →, M: Z16XEP |
| | 74 | 03/01 → 10/05 | B | Z16XE | 05-2004 →, M: Z16XEP |
| 1.6 Turbo | 132 | 12/09 → | B | A16LET | |

82084
350982084000



PULEGGIA

Diametro Puleggia Ø105

Altezza Puleggia 31

Posizione Attacco 70.7

Diametro Girante Ø78

N° Alette Girante 8

Posizione Girante 13.5

MERCEDES-BENZ
Classe E II (W210), Station Wagon (S210)

| | | | | |
|-------------|-----|---------------|---|-----------|
| E 320 CDI | 145 | 07/99 → 03/02 | D | OM613.961 |
| E 320 T CDI | 145 | 07/99 → 03/03 | D | OM613.961 |

82085
350982085000

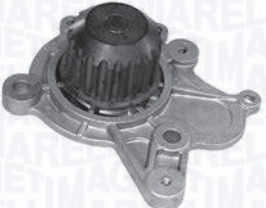

PULEGGIA

Diametro Puleggia Ø59

Numero Denti/Gole Puleggia 20

Altezza Puleggia 30

Posizione Attacco 48

Diametro Girante Ø77

N° Alette Girante 6

Posizione Girante 21

HYUNDAI
Accent II

| | | | | |
|----------|----|---------------|---|------|
| 1.5 CRDi | 60 | 04/02 → 11/05 | D | D3EA |
|----------|----|---------------|---|------|

Elantra I

| | | | | |
|----------|----|---------------|---|------|
| 2.0 CRDi | 83 | 04/01 → 07/06 | D | D4EA |
|----------|----|---------------|---|------|

Getz

| | | | | |
|----------|----|---------------|---|------|
| 1.5 CRDi | 60 | 03/03 → 09/05 | D | D3EA |
|----------|----|---------------|---|------|

Matrix

| | | | | |
|----------|----|---------------|---|------|
| 1.5 CRDi | 60 | 10/01 → 08/10 | D | D3EA |
|----------|----|---------------|---|------|

82085
350982085000

HYUNDAI
Santa Fé I

| | | | | |
|-----------------------------------|-----|---------------|---|------|
| 2.0 CRDi | 83 | 08/01 → 03/06 | D | D4EA |
| 2.0 CRDi 4x4 | 83 | 04/01 → 03/06 | D | D4EA |
| | 92 | 08/03 → 03/06 | D | D4EA |
| 2.0 CRDi Trazione integrale | 107 | 11/03 → 02/06 | D | D4EA |

Trajt

| | | | | |
|----------|----|---------------|---|------|
| 2.0 CRDi | 83 | 04/01 → 07/08 | D | D4EA |
| | 92 | 08/05 → 07/08 | D | D4EA |

Tucson I

| | | | | | |
|-----------------------------------|----|---------------|---|------|-----------|
| 2.0 CRDi | 83 | 08/04 → 03/10 | D | D4EA | → 12-2005 |
| 2.0 CRDi Trazione integrale | 83 | 08/04 → 03/10 | D | D4EA | → 12-2005 |

KIA
Carens II

| | | | | |
|----------|----|---------|---|------|
| 2.0 CRDi | 83 | 07/02 → | D | D4EA |
|----------|----|---------|---|------|

Cee'd I, Station Wagon

| | | | | |
|-----------------|-----|---------------|---|--------|
| 2.0 CRDi 140 | 103 | 09/07 → 12/12 | D | D4EA-F |
|-----------------|-----|---------------|---|--------|

Cerato I

| | | | | | |
|----------|----|---------|---|------|-----------|
| 2.0 CRDi | 83 | 04/04 → | D | D4EA | → 05-2005 |
|----------|----|---------|---|------|-----------|

Sportage II

| | | | | |
|-----------------|-----|---------|---|-------------------|
| 2.0 CRDi | 83 | 02/05 → | D | D4EA |
| | 103 | 01/06 → | D | D4EA-V |
| 2.0 CRDi 4WD | 83 | 09/04 → | D | D4EA |
| | 103 | 01/06 → | D | D4EA-F, D4EA-V |

82086
350982086000

FLANGIA

| | |
|-------------------------|---------|
| Numero Fori Flangia | 3 |
| Dimensione Fori Flangia | M8x1.25 |
| Posizione Attacco | 65.3 |
| Diametro Mozzo | Ø22 |
| Diametro Centraggio | Ø25.95 |
| Diametro Girante | Ø70 |
| N° Alette Girante | 9 |
| Posizione Girante | 28.4 |

KW

FIAT
Punto I, Cabrio, Van

| | | | | | |
|--------|----|---------------|---|-----------|-----------|
| 1.7 TD | 46 | 09/96 → 09/99 | D | 176B7.000 | |
| | 51 | 01/94 → 09/99 | D | 176A3.000 | 08-1996 → |
| | 52 | 01/94 → 09/99 | D | 176A5.000 | 08-1996 → |

Palio I, Weekend

| | | | | | |
|--------|----|---------------|---|-----------|------------------------------|
| 1.7 TD | 51 | 04/96 → 03/01 | D | 176A3.000 | 10-1999 →, M →: 2.427.907 |
|--------|----|---------------|---|-----------|------------------------------|

Siena I

| | | | | | |
|--------|----|---------------|---|-----------|--|
| 1.7 TD | 51 | 02/06 → 12/09 | D | 176A3.000 | |
|--------|----|---------------|---|-----------|--|

Strada

| | | | | | |
|--------|----|---------|---|-----------|----------------|
| 1.7 TD | 51 | 06/99 → | D | 176A3.000 | M →: 2.427.907 |
|--------|----|---------|---|-----------|----------------|

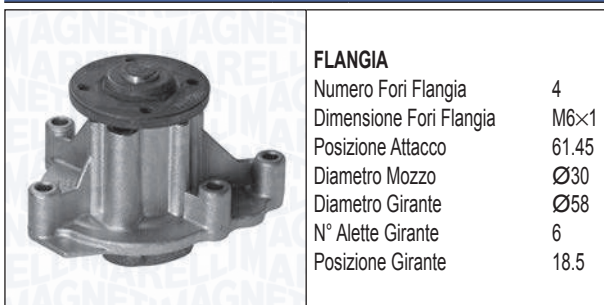
82087
350982087000

FLANGIA

| | |
|-------------------------|-------|
| Numero Fori Flangia | 4 |
| Dimensione Fori Flangia | M6x1 |
| Posizione Attacco | 61.45 |
| Diametro Mozzo | Ø30 |
| Diametro Girante | Ø58 |
| N° Alette Girante | 6 |
| Posizione Girante | 18.5 |

KW

MERCEDES-BENZ
Classe A I (W168)

| | | | | | |
|-----------|-----|---------------|---|-----------|--|
| A 140 | 60 | 07/97 → 08/04 | B | M166.940 | |
| | 60 | 01/01 → 08/04 | B | M166.960 | |
| A 160 | 75 | 07/97 → 08/04 | B | M166.960 | |
| A 160 CDI | 44 | 07/98 → 02/01 | D | OM668.941 | |
| | 55 | 02/01 → 08/04 | D | OM668.940 | |
| A 170 CDI | 66 | 07/98 → 02/01 | D | OM668.940 | |
| | 70 | 02/01 → 08/04 | D | OM668.942 | |
| A 190 | 92 | 03/99 → 08/04 | B | M166.990 | |
| A 210 | 103 | 03/02 → 08/04 | B | M166.995 | |

82087
350982087000

MERCEDES-BENZ
Vaneo

| | | | | | |
|---------|----|---------------|---|-----------|--|
| 1.6 | 60 | 02/02 → 07/05 | B | M166.961 | |
| | 75 | 02/02 → 07/05 | B | M166.961 | |
| 1.7 CDI | 55 | 02/02 → 07/05 | D | OM668.914 | |
| | 67 | 02/02 → 07/05 | D | OM668.914 | |
| 1.9 | 92 | 02/02 → 07/05 | B | M166.991 | |

82088
350982088000

PULEGGIA

| | |
|-------------------|-------|
| Diametro Puleggia | Ø90 |
| Altezza Puleggia | 34.5 |
| Posizione Attacco | 74.4 |
| Diametro Girante | Ø73.5 |
| N° Alette Girante | 6 |
| Posizione Girante | 12.5 |

KW

MERCEDES-BENZ
Classe C I (W202), Station Wagon (S202)

| | | | | | |
|-----------------|-----|---------------|---|-----------|--|
| C 200 T CDI | 75 | 03/98 → 03/01 | D | OM611.960 | |
| C 220 CDI | 92 | 09/97 → 05/00 | D | OM611.960 | |
| C 220 T CDI | 92 | 09/97 → 03/01 | D | OM611.960 | |
| C 220 T D | 55 | 06/96 → 03/01 | D | OM604.910 | |
| C 250 T Turbo-D | 110 | 06/96 → 03/01 | D | OM605.960 | |

Classe C II (W203), Station Wagon (S203), Coupé (CL203)

| | | | | | |
|-----------|-----|---------------|---|-----------|--|
| C 200 CDI | 75 | 02/01 → 02/07 | D | OM646.962 | |
| | 85 | 03/01 → 08/07 | D | OM611.962 | |
| | 85 | 09/00 → 02/07 | D | OM611.962 | |
| | 90 | 04/03 → 02/07 | D | OM646.962 | |
| C 220 CDI | 100 | 03/01 → 01/04 | D | OM611.962 | |
| | 100 | 05/00 → 02/07 | D | OM611.962 | |
| | 105 | 03/01 → 08/07 | D | OM611.962 | |
| | 105 | 05/00 → 02/07 | D | OM611.962 | |
| | 110 | 02/03 → 02/07 | D | OM646.963 | |
| | 100 | 08/06 → 08/07 | D | OM646.963 | |
| C 270 CDI | 120 | 12/00 → 02/07 | D | OM612.962 | |
| | 125 | 03/01 → 08/07 | D | OM612.962 | |
| | 125 | 12/00 → 02/07 | D | OM612.962 | |

Classe E II (W210), Station Wagon (S210)

| | | | | | |
|-----------|----|---------------|---|-----------|--|
| E 200 CDI | 85 | 07/99 → 03/02 | D | OM611.961 | |
| | 75 | 06/98 → 03/02 | D | OM611.961 | |

82088

350982088000



MERCEDES-BENZ

Classe E II (W210), Station Wagon (S210)

| | | | | |
|-------------|-----|---------------|---|-----------|
| E 220 CDI | 100 | 07/99 → 03/02 | D | OM611.961 |
| | 105 | 07/99 → 03/02 | D | OM611.961 |
| | 92 | 06/98 → 07/99 | D | OM611.961 |
| E 220 T CDI | 100 | 05/99 → 03/03 | D | OM611.961 |
| | 105 | 07/99 → 03/03 | D | OM611.961 |
| | 92 | 06/98 → 07/99 | D | OM611.961 |
| E 270 CDI | 120 | 07/99 → 03/02 | D | OM612.961 |
| | 125 | 07/99 → 03/02 | D | OM612.961 |
| E 270 T CDI | 120 | 02/00 → 03/03 | D | OM612.961 |
| | 125 | 07/99 → 03/03 | D | OM612.961 |

Classe G (W460, W461), Cabrio (W463)

| | | | | |
|-----------|-----|---------|---|-----------|
| G 270 CDI | 115 | 01/03 → | D | OM612.966 |
|-----------|-----|---------|---|-----------|

Classe M I (W163)

| | | | | |
|------------|-----|---------------|---|-----------|
| ML 270 CDI | 120 | 12/99 → 06/05 | D | OM612.963 |
|------------|-----|---------------|---|-----------|

CLK II (C209), Cabrio (A209)

| | | | | |
|---------|-----|---------------|---|----------------------|
| 270 CDI | 120 | 02/03 → 06/05 | D | OM612.967 |
| 270 CDI | 125 | 10/02 → 05/09 | D | OM612.962, OM612.967 |

82089

350982089000



PULEGGIA
 Diametro Puleggia Ø59.85
 Numero Denti/Gole Puleggia 20
 Altezza Puleggia 32.3
 Posizione Attacco 62
 Diametro Girante Ø61.5
 N° Alette Girante 8
 Posizione Girante 22.2



CITROËN

C 4 I, Coupé, Picasso, Grand Picasso

| | | | | |
|------------|-----|---------------|----|----------------------|
| 1.8 Bifuel | 92 | 01/09 → 10/12 | BF | 6FY (EW7A) (+)COP |
| | 92 | 01/09 → 10/12 | BF | 6FY (EW7A) |
| 1.8 i 16V | 92 | 10/06 → | B | 6FY (EW7A) (+)COP |
| | 92 | 10/06 → | B | 6FY (EW7A) |
| 2.0 16V | 100 | 11/04 → 07/07 | B | RFN (EW10J4) (+)COP |
| | 100 | 11/04 → 07/07 | B | RFN (EW10J4) |
| | 103 | 11/04 → 07/11 | B | RFJ (EW10A) (+)COP |
| | 103 | 11/04 → 07/11 | B | RFJ (EW10A) |
| | 130 | 11/04 → 12/10 | B | RFK (EW10J4S) (+)COP |
| | 130 | 11/04 → 12/10 | B | RFK (EW10J4S) |

82089

350982089000



CITROËN

C 4 I, Coupé, Picasso, Grand Picasso

| | | | | |
|-----------|-----|---------------|---|--------------------|
| 2.0 i 16V | 103 | 10/06 → | B | RFJ (EW10A) (+)COP |
| | 103 | 10/06 → | B | RFJ (EW10A) |
| 2.0 VTR | 103 | 10/06 → 12/07 | B | RFJ (EW10A) (+)COP |

C 5 I, Break

| | | | | |
|-------------|-----|---------------|---|---------------------|
| 1.8 16V | 85 | 03/01 → 08/04 | B | 6FZ (EW7J4) (+)COP |
| | 85 | 03/01 → 08/04 | B | 6FZ (EW7J4) |
| 2.0 16V | 100 | 03/01 → 08/04 | B | RFN (EW10J4) (+)COP |
| | 100 | 03/01 → 08/04 | B | RFN (EW10J4) |
| 2.0 16V HPi | 103 | 03/01 → 08/04 | B | RLZ (EW10D) (+)COP |
| | 103 | 03/01 → 08/04 | B | RLZ (EW10D) |

C 5 II, Break

| | | | | |
|---------|-----|---------|---|--------------------|
| 1.8 16V | 92 | 09/05 → | B | 6FY (EW7A) (+)COP |
| | 92 | 09/05 → | B | 6FY (EW7A) |
| | 85 | 09/04 → | B | 6FZ (EW7J4) (+)COP |
| 2.0 16V | 85 | 09/04 → | B | 6FZ (EW7J4) |
| | 103 | 09/04 → | B | RFJ (EW10A) (+)COP |
| | 103 | 09/04 → | B | RFJ (EW10A) |

| | | | | |
|------------------------|-----|---------|---|--------------------|
| C 5 III, Break 1.8 16V | 92 | 02/08 → | B | 6FY (EW7A) (+)COP |
| 1.8 16V | 92 | 02/08 → | B | 6FY (EW7A) |
| 2.0 16V | 103 | 02/08 → | B | RFJ (EW10A) (+)COP |
| | 103 | 02/08 → | B | RFJ (EW10A) |
| 2.0 16V BioFlex | 103 | 02/08 → | | RFJ (EW10A) (+)COP |
| | 103 | 02/08 → | | RFJ (EW10A) |

C 8

| | | | | |
|---------|-----|---------|---|---------------------|
| 2.0 | 100 | 07/02 → | B | RFN (EW10J4) (+)COP |
| | 100 | 07/02 → | B | RFN (EW10J4) |
| 2.0 16V | 103 | 09/05 → | B | RFJ (EW10A) (+)COP |
| | 103 | 09/05 → | B | RFJ (EW10A) |
| | 104 | 09/05 → | B | RFJ (EW10A) (+)COP |
| | 104 | 09/05 → | B | RFJ (EW10A) |
| 2.2 | 116 | 07/02 → | B | 3FZ (EW12J4) (+)COP |
| | 116 | 07/02 → | B | 3FZ (EW12J4) |

Evasion

| | | | | |
|---------|-----|---------------|---|---------------------|
| 2.0 16V | 100 | 05/00 → 07/02 | B | RFN (EW10J4) (+)COP |
| | 100 | 05/00 → 07/02 | B | RFN (EW10J4) |

Jumpy I

| | | | | |
|-----------|-----|---------------|---|---------------------|
| 2.0 | 100 | 04/00 → 12/06 | B | RFN (EW10J4) (+)COP |
| | 100 | 04/00 → 12/06 | B | RFN (EW10J4) |
| 2.0 i 16V | 102 | 03/00 → | B | RFN (EW10J4) (+)COP |
| | 102 | 03/00 → | B | RFN (EW10J4) |

82089 350982089000

CITROËN
Jumpy II

| | | | | | |
|-----|-----|---------------|---|-------------|--------|
| 2.0 | 100 | 12/03 → 10/06 | B | RFN(EW10J4) | (+)COP |
| | 100 | 12/03 → 10/06 | B | RFN(EW10J4) | |

Jumpy III

| | | | | | |
|-------|-----|---------|---|------------|--------|
| 2.0 i | 103 | 01/07 → | B | RFH(EW10A) | (+)COP |
| | 103 | 01/07 → | B | RFH(EW10A) | |

Xsara, Break, Coupé, Picasso, Van

| | | | | | |
|---------|-----|---------------|---|-------------|--------|
| 1.8 16V | 85 | 02/00 → | B | 6FZ(EW7J4) | (+)COP |
| | 85 | 02/00 → | B | 6FZ(EW7J4) | |
| 1.8 VTS | 85 | 09/00 → 10/04 | B | 6FZ(EW7J4) | (+)COP |
| | 85 | 09/00 → 10/04 | B | 6FZ(EW7J4) | |
| 2.0 16V | 100 | 09/00 → 03/05 | B | RFN(EW10J4) | (+)COP |
| | 100 | 09/00 → 03/05 | B | RFN(EW10J4) | |

FIAT
Doblo II, Cargo

| | | | | | |
|-----|----|---------|---|-----------|--------|
| 1.4 | 70 | 04/10 → | B | 843A1.000 | (+)COP |
| | 70 | 04/10 → | B | 843A1.000 | |

Scudo I

| | | | | | |
|---------|-----|---------------|---|-------------|--------|
| 2.0 | 100 | 05/00 → 12/06 | B | RFN(EW10J4) | (+)COP |
| | 100 | 05/00 → 12/06 | B | RFN(EW10J4) | |
| 2.0 16V | 100 | 06/00 → 12/06 | B | RFN(EW10J4) | (+)COP |
| | 100 | 06/00 → 12/06 | B | RFN(EW10J4) | |

Ulysse II

| | | | | | |
|-----|-----|---------------|---|-------------|--------|
| 2.0 | 100 | 08/02 → 06/11 | B | RFN(EW10J4) | (+)COP |
| | 100 | 08/02 → 06/11 | B | RFN(EW10J4) | |

LANCIA
Phedra

| | | | | | |
|-----|-----|---------------|---|-------------|--------|
| 2.0 | 100 | 09/02 → 11/10 | B | RFN(EW10J4) | (+)COP |
| | 100 | 09/02 → 11/10 | B | RFN(EW10J4) | |

Zeta

| | | | | | |
|---------|-----|---------------|---|-----|--------|
| 2.0 16V | 100 | 07/00 → 09/02 | B | RFN | (+)COP |
| | 100 | 07/00 → 09/02 | B | RFN | |

PEUGEOT
205 II, Van

| | | | | | |
|---------|-----|---------------|---|--------------|--------|
| 2.0 RC | 130 | 07/03 → | B | RFK(EW10J4S) | (+)COP |
| | 130 | 07/03 → | B | RFK(EW10J4S) | |
| 2.0 S16 | 99 | 04/99 → 10/00 | B | RFR(DEV10J4) | (+)COP |
| | 99 | 04/99 → 10/00 | B | RFR(DEV10J4) | |
| | 100 | 06/99 → | B | RFN(EW10J4) | (+)COP |
| | 100 | 06/99 → | B | RFN(EW10J4) | |

82089 350982089000

PEUGEOT
206, CC, Van

| | | | | | |
|---------|-----|---------|---|-------------|--------|
| 2.0 16V | 100 | 07/02 → | B | RFN(EW10J4) | (+)COP |
| | 100 | 07/02 → | B | RFN(EW10J4) | |
| 2.0 S16 | 100 | 09/00 → | B | RFN(EW10J4) | (+)COP |
| | 100 | 09/00 → | B | RFN(EW10J4) | |

307, Station Wagon, CC

| | | | | | |
|---------|-----|---------|---|-------------------------|--------|
| 2.0 | 100 | 03/02 → | B | RFN(EW10J4) | (+)COP |
| | 100 | 03/02 → | B | RFN(EW10J4) | |
| | 105 | 08/08 → | B | RFN(EW10J4) | (+)COP |
| | 105 | 08/08 → | B | RFN(EW10J4) | |
| 2.0 16V | 100 | 08/00 → | B | RFN(EW10J4) | (+)COP |
| | 100 | 08/00 → | B | RFN(EW10J4) | |
| | 103 | 03/05 → | B | RFJ(EW10A) | (+)COP |
| | 103 | 03/05 → | B | RFJ(EW10A) | |
| | 103 | 03/05 → | B | RFJ(EW10A), RFN(EW10J4) | (+)COP |
| | 103 | 03/05 → | B | RFJ(EW10A), RFN(EW10J4) | |
| | 130 | 06/05 → | B | RFK(EW10J4S) | (+)COP |
| | 130 | 06/05 → | B | RFK(EW10J4S) | |

308 I, Station Wagon, CC

| | | | | | |
|-------------|-----|---------------|---|------------|--------|
| 2.0 Bioflex | 103 | 01/08 → 01/12 | | RFJ(EW10A) | (+)COP |
| | 103 | 01/08 → | | RFJ(EW10A) | |
| 2.0 CVVT | 103 | 07/09 → 11/14 | B | RFJ(EW10A) | (+)COP |

407, Station Wagon, Coupé

| | | | | | |
|---------|-----|---------|---|-------------|--------|
| 1.8 | 85 | 05/04 → | B | 6FZ(EW7J4) | (+)COP |
| | 85 | 05/04 → | B | 6FZ(EW7J4) | |
| 1.8 16V | 92 | 09/05 → | B | 6FY(EW7A) | (+)COP |
| | 92 | 09/05 → | B | 6FY(EW7A) | |
| 2.0 | 100 | 05/04 → | B | RFN(EW10J4) | (+)COP |
| | 100 | 05/04 → | B | RFN(EW10J4) | |

82089

350982089000



PEUGEOT

407, Station Wagon, Coupé

| | | | | | | |
|---------|-------------|---------------|---------------|-----------------------------|--------------|--------|
| 2.0 16V | 99 | 01/99 → 08/00 | B | RFR (DEW10J4) | (+)COP | |
| | 99 | 01/99 → 08/00 | B | RFR (DEW10J4) | | |
| | 100 | 08/00 → 06/04 | B | RFN (EW10J4) | (+)COP | |
| | 100 | 08/00 → 06/04 | B | RFN (EW10J4) | | |
| | 100 | 10/00 → 12/04 | B | RFN (EW10J4), RFV (XU10J4R) | (+)COP | |
| | 100 | 10/00 → 12/04 | B | RFN (EW10J4), RFV (XU10J4R) | | |
| | 103 | 09/05 → | B | RFJ (EW10A) | (+)COP | |
| | 103 | 09/05 → | B | RFJ (EW10A) | | |
| | 97 | 11/95 → 05/04 | B | RFV (XU10J4R) | (+)COP | |
| | 97 | 11/95 → 05/04 | B | RFV (XU10J4R) | | |
| | 2.0 16V HPi | 103 | 05/01 → 05/04 | B | RLZ (EW10D) | (+)COP |
| | 2.0 Bioflex | 103 | 09/07 → | | RFJ (EW10A) | (+)COP |
| | 2.2 | 116 | 07/00 → 05/04 | B | 3FZ (EW12J4) | (+)COP |
| | 2.2 16V | 120 | 09/05 → | B | 3FY (EW12J4) | (+)COP |
| | 120 | 09/05 → | B | 3FY (EW12J4) | | |

607

| | | | | | |
|---------|-----|---------|---|--------------|--------|
| 2.0 | 100 | 02/00 → | B | RFN (EW10J4) | (+)COP |
| | 100 | 02/00 → | B | RFN (EW10J4) | |
| 2.2 16V | 116 | 02/00 → | B | 3FZ (EW12J4) | (+)COP |
| | 116 | 02/00 → | B | 3FZ (EW12J4) | |
| | 120 | 09/05 → | B | 3FY (EW12J4) | (+)COP |
| | 120 | 09/05 → | B | 3FY (EW12J4) | |

806

| | | | | | |
|---------|-----|---------------|---|--------------|--------|
| 2.0 16V | 100 | 09/00 → 08/02 | B | RFN (EW10J4) | (+)COP |
| | 100 | 09/00 → 08/02 | B | RFN (EW10J4) | |

807

| | | | | | |
|---------|-----|---------|---|--------------|--------|
| 2.0 | 100 | 06/02 → | B | RFN (EW10J4) | (+)COP |
| | 100 | 06/02 → | B | RFN (EW10J4) | |
| 2.0 16V | 103 | 09/05 → | B | RFJ (EW10A) | (+)COP |
| | 103 | 09/05 → | B | RFJ (EW10A) | |

82089

350982089000



PEUGEOT

807

| | | | | | |
|-----|-----|---------|---|--------------|--------|
| 2.2 | 116 | 06/02 → | B | 3FZ (EW12J4) | (+)COP |
| | 116 | 06/02 → | B | 3FZ (EW12J4) | |

Expert I

| | | | | | |
|-----|-----|---------|---|--------------|--------|
| 2.0 | 100 | 07/00 → | B | RFN (EW10J4) | (+)COP |
| | 100 | 07/00 → | B | RFN (EW10J4) | |

Expert II, Tepee

| | | | | | |
|---------|-----|---------|---|--------------------------|--------|
| 2.0 16V | 103 | 01/07 → | B | RFH (EW10A), RFJ (EW10A) | (+)COP |
| | 103 | 01/07 → | B | RFH (EW10A), RFJ (EW10A) | |

82090

350982090000



PULEGGIA

| | |
|-------------------|-------|
| Diametro Puleggia | Ø56.2 |
| Altezza Puleggia | 30.5 |
| Posizione Attacco | 56 |
| Diametro Girante | Ø60 |
| N° Alette Girante | 6 |
| Posizione Girante | 5.4 |



DACIA

Logan

| | | | | | |
|---------|----|---------|---|--------|--|
| 1.2 | 54 | 05/15 → | B | | |
| | 55 | 10/12 → | B | D4F732 | |
| 1.2 LPG | 55 | 10/12 → | | D4F734 | |

Logan MCV

| | | | | | |
|---------|----|---------|---|--------|--|
| 1.2 | 54 | 05/15 → | B | D4F732 | |
| | 55 | 02/13 → | B | D4F732 | |
| 1.2 LPG | 55 | 02/13 → | | D4F734 | |

Logan, Station Wagon, Van

| | | | | | |
|-------------|----|---------|---|--------|--|
| 1.2 16V | 55 | 02/06 → | B | D4F732 | |
| 1.2 16V LPG | 55 | 02/06 → | | D4F734 | |

Sandero I

| | | | | | |
|-------------|----|---------|--|--------|--|
| 1.2 16V LPG | 55 | 11/08 → | | D4F732 | |
|-------------|----|---------|--|--------|--|

Sandero II

| | | | | | |
|---------|----|---------|---|--------|--|
| 1.2 | 54 | 05/15 → | B | D4F732 | |
| | 55 | 10/12 → | B | D4F732 | |
| 1.2 LPG | 55 | 10/12 → | | D4F732 | |

82090 350982090000

RENAULT
Clio II

| | | | | | |
|---------|----|---------|---|--|-----------|
| 1.2 16V | 55 | 06/01 → | B | D4F706, D4F712, D4F714, D4F722, D4F728 | 06-2003 → |
|---------|----|---------|---|--|-----------|

Clio III, Grandtour

| | | | | | |
|--------------------|----|---------|---|-------------------|--|
| 1.2 | 57 | 10/05 → | B | D4F764 | |
| 1.2 16V | 58 | 06/05 → | B | D4F764 | |
| | 76 | 09/10 → | B | D4F786 | |
| | 48 | 06/05 → | B | D4F740 | |
| | 55 | 06/05 → | B | D4F706, D4F740 | |
| 1.2 16V Hi-Flex | 55 | 02/08 → | B | D4F740 | |
| | 58 | 02/08 → | B | D4F764 | |
| | 74 | 02/08 → | B | D4F784 | |
| 1.2 16V Hi-Flex | 55 | 07/08 → | | D4F740 | |
| | 55 | 07/08 → | | D4F740, D4F742 | |
| 1.2 Ethanol | 55 | 07/08 → | | | |

Clio IV, Grandtour

| | | | | | |
|---------|----|---------|---|-------------------|--|
| 1.2 16V | 54 | 11/12 → | B | D4F728, D4F740 | |
| | 54 | 01/13 → | B | D4F740 | |

Modus

| | | | | | |
|-----|----|---------|---|--------|--|
| 1.2 | 76 | 04/11 → | B | D4F786 | |
|-----|----|---------|---|--------|--|

Thalia II

| | | | | | |
|---------|----|---------|---|--------|--|
| 1.2 16V | 55 | 09/08 → | B | D4F728 | |
|---------|----|---------|---|--------|--|

Twingo II

| | | | | | |
|-------------|----|---------|---|------------------------------|--|
| 1.2 16V | 55 | 03/07 → | B | D4F764, D4F770, D4F772 | |
| | 56 | 03/07 → | B | D4F772 | |
| 1.2 TCe 100 | 75 | 02/11 → | B | D4F780, D4F782 | |
| 1.2 Turbo | 74 | 03/07 → | B | D4F780, D4F782 | |

Wind

| | | | | | |
|-------------|----|---------|---|--------|--|
| 1.2 TCe 100 | 75 | 02/11 → | B | D4F780 | |
|-------------|----|---------|---|--------|--|

82091 350982091000

PULEGGIA

| | |
|-------------------|-------|
| Diametro Puleggia | Ø56.2 |
| Altezza Puleggia | Ø30.3 |
| Posizione Attacco | 56 |
| Diametro Girante | Ø60 |
| N° Alette Girante | 6 |
| Posizione Girante | 4.5 |

RENAULT
Clio II

| | | | | | |
|-----|----|---------|---|--|-----------|
| 1.2 | 43 | 09/98 → | B | D7F720, D7F726, D7F746, D7F764, D7F766 | 01-2004 → |
|-----|----|---------|---|--|-----------|

Kangoo I, Van

| | | | | | |
|------------|----|---------------|----|-------------------|--|
| 1.2 BiFuel | 43 | 07/98 → 07/01 | BF | D7F710, D7F744 | |
|------------|----|---------------|----|-------------------|--|

Twingo I

| | | | | | |
|---------|----|---------|--|-------------------|--|
| 1.2 LPG | 44 | 10/03 → | | D7F702, D7F708 | |
|---------|----|---------|--|-------------------|--|

Twingo II

| | | | | | |
|-----|----|---------|---|--------|--|
| 1.2 | 43 | 03/07 → | B | D7F800 | |
|-----|----|---------|---|--------|--|

82092 350982092000

PULEGGIA

| | |
|----------------------------|-------|
| Diametro Puleggia | Ø56.4 |
| Numero Denti/Gole Puleggia | 19 |
| Altezza Puleggia | 34.8 |
| Posizione Attacco | 89.6 |
| Diametro Girante | Ø68.8 |
| N° Alette Girante | 6 |
| Posizione Girante | 4.5 |

MAZDA
3 I, Saloon

| | | | | | |
|------------|-----|---------------|---|------|--|
| 2.0 MZR-CD | 105 | 12/06 → 06/09 | D | RF7J | |
|------------|-----|---------------|---|------|--|

5 I

| | | | | | |
|--------|-----|---------|---|------|--|
| 2.0 CD | 81 | 03/05 → | D | RF7J | |
| | 105 | 06/05 → | D | RF7J | |

6 I, Hatchback, Station Wagon

| | | | | | |
|-----------------|-----|---------------|---|------|--|
| 2.0 CiTD 4x4 | 89 | 10/02 → 02/05 | D | RF5C | |
| | 100 | 10/02 → 02/05 | D | RF5C | |
| 2.0 DI | 89 | 08/02 → 08/07 | D | RF5C | |
| | 100 | 06/02 → 08/07 | D | RF5C | |
| | 105 | 06/05 → 08/07 | D | RF7J | |

82092
350982092000

KW

MAZDA
6 II, Hatchback, Station Wagon

2.0 MZR-CD 103 08/07 → D RF7J

323 F VI

2.0 TD 66 09/98 → 12/01 D

74 01/01 → 05/04 D RF4F

323 S VI

2.0 DiTD 74 10/00 → 10/02 D RF4F

2.0 TD 66 09/98 → 05/04 D RF3F

626 V, Hatchback, Station Wagon

2.0 Di TD 66 04/98 → 10/02 D RF3F

2.0 DiTD 66 04/98 → 10/02 D RF3F

2.0 TD 81 10/00 → 10/02 D RF59

81 10/00 → 10/02 D

2.0 Turbo Di 74 04/98 → 10/02 D RF4F

74 04/98 → 10/02 D

MPV

2.0 Di 100 07/02 → 02/06 D RF5C

Premacy

2.0 TD 66 10/99 → 07/00 D RF3F

74 07/00 → 03/05 D RF4F

82093
350982093000

PULEGGIA

Diametro Puleggia Ø102.6

Altezza Puleggia 32.5

Posizione Attacco 51.6

Diametro Girante Ø62

N° Alette Girante 7

Posizione Girante 23.5

KW

HONDA
Accord VII, Aerodeck, Hatchback, Coupé

2.2 i-CTDi 103 01/04 → 05/08 D N22A1

Civic VIII, Hatchback, Coupé

2.2 CTDi 103 09/05 → D N22A2

CR-V II

2.2 CTDi 103 02/05 → 09/06 D N22A2

CR-V III

2.2 i-CTDi 4WD 103 01/07 → D N22A2

FR-V

2.2 i CTDi 103 07/05 → D N22A1

82094
350982094000

PULEGGIA

Diametro Puleggia Ø105.1

Numero Denti/Gole Puleggia 6

Altezza Puleggia 22.8

Posizione Attacco 83.9

Diametro Girante Ø83

N° Alette Girante 7

Posizione Girante 18.2

KW

CITROËN
Jumper III

3.0 HDi 145 107 07/10 → D F1CE3481N

3.0 HDi 155 115 07/10 → D F1CE0481D (F30DT)

3.0 HDi 160 116 09/06 → D F1CE0481D (F30DT)

3.0 HDi 180 130 07/11 → D F1CE0481D (F30DT)

FIAT
Ducato V

115 Multijet 2,0 D 85 06/11 → D 250A1.000, 250A2.000

140 Natural Power 100 04/09 → F1CE0441A

140 Natural Power 100 04/09 → F1CE0441A, F1CFA401A

150 Multijet 3,0 D 107 04/10 → D F1CE3481N

115 10/06 → D F1CE0481D

115 07/06 → D F1CE3481M

160 Multijet 3,0 D 116 07/06 → D F1CE0481D

116 07/06 → D F1CE0481D, F1CE3481M

180 Multijet 3,0 D 130 06/11 → D F1CE3481E

PEUGEOT
Boxer III

3.0 HDi 115 07/06 → D F1CE0481D (F30DT)

3.0 HDi 145 107 04/10 → D

3.0 HDi 160 116 04/06 → D F1CE0481D (F30DT)

3.0 HDi 175 130 03/11 → D F1CE0481D (F30DT)

82095
350982095000

ALBERINO

Diametro Alberino M30×1.5
 Tipo Filetto Alberino MASCHIO
 Posizione Attacco 144.9
 Diametro Girante Ø83.8
 N° Alette Girante 7
 Posizione Girante 17.2

KW

IVECO
Daily III

| | | | | |
|---------------------|-----|---------------|---|-----------|
| 35 C 14 | 100 | 09/04 → 04/06 | D | F1CE0481A |
| 35 C 14, 35 S 14 | 100 | 01/05 → 04/06 | D | F1AE0481M |
| 35 C 17, 35 S 17 | 122 | 01/05 → 04/06 | D | F1CE0481B |
| 40 C 14 | 100 | 09/04 → 04/06 | D | F1CE0481A |
| 40 C 17, 40 S 17 | 122 | 01/05 → 04/06 | D | F1CE0481B |
| 50 C 14 | 100 | 09/04 → 04/06 | D | F1CE0481A |
| 50 C 17 | 122 | 09/04 → 04/06 | D | F1CE0481B |
| 65 C 14 | 100 | 09/04 → 04/06 | D | F1CE0481A |
| 65 C 17 | 122 | 09/04 → 04/06 | D | F1CE0481B |

Daily IV

| | | | | |
|---|-----|---------------|---|------------|
| 35C15 | 107 | 05/06 → 08/11 | D | F1CE0481FA |
| 35C15 V, 35C15 V/P | 107 | 05/06 → 08/11 | D | F1CE0481FA |
| 35C18 | 130 | 05/06 → 08/11 | D | F1CE0481HA |
| 35C18 V, 35C18 V/P, 35S18 V, 35S18 V/P | 130 | 05/06 → 08/11 | D | F1CE0481HA |
| 35C18, 35S18 | 130 | 05/06 → 08/11 | D | F1CE0481HA |
| 40C15 | 107 | 05/06 → 08/11 | D | F1CE0481FA |
| 40C15 V, 40C15 V/P | 107 | 05/06 → 08/11 | D | F1CE0481FA |
| 40C18 | 130 | 05/06 → 08/11 | D | F1CE0481HA |
| 40C18 V, 40C18 V/P | 130 | 05/06 → 08/11 | D | F1CE0481HA |
| 45C15 | 107 | 05/06 → 08/11 | D | F1CE0481FA |
| 45C15 V | 107 | 05/06 → 08/11 | D | F1CE0481FA |
| 45C18 | 130 | 05/06 → 08/11 | D | F1CE0481HA |
| 45C18, 45C18 /P, 45C18 D, 45C18 D/P | 130 | 05/06 → 08/11 | D | F1CE0481HA |

82095
350982095000

KW

IVECO
Daily IV

| | | | | |
|--|-----|---------------|---|------------|
| 50C15 | 107 | 05/06 → 08/11 | D | F1CE0481FA |
| 50C15 V, 50C15 V/P | 107 | 05/06 → 08/11 | D | F1CE0481FA |
| 50C18 | 130 | 05/06 → 08/11 | D | F1CE0481HA |
| 50C18 V, 50C18 V/P | 130 | 05/06 → 08/11 | D | F1CE0481HA |
| 60C15 | 107 | 05/06 → 08/11 | D | F1CE0481FA |
| 60C15 V | 107 | 05/06 → 08/11 | D | F1CE0481FA |
| 60C15, 60C15 /P, 60C15 D, 60C15 D/P | 107 | 05/06 → 08/11 | D | F1CE0481FA |
| 60C18 | 130 | 05/06 → 08/11 | D | F1CE0481HC |
| 65C15 | 107 | 05/06 → 08/11 | D | F1CE0481FA |
| 65C15, 65C15 /P, 65C15 D, 65C15 D/P | 107 | 05/06 → 08/11 | D | F1CE0481FA |
| 65C18 | 130 | 05/06 → 08/11 | D | F1CE0481HC |

82097
350982097000

FLANGIA

Numero Fori Flangia 3
 Dimensione Fori Flangia M8×1.25
 Posizione Attacco 76.2
 Diametro Centraggio Ø30
 Diametro Girante Ø59.5
 N° Alette Girante 7
 Posizione Girante -1

KW

AUDI
A1, Sportback

| | | | | |
|----------|-----|---------|---|---------------------|
| 1.4 TFSI | 90 | 05/10 → | B | CAXA, CNVA |
| 1.4 TFSI | 136 | 11/11 → | B | CAVG, CTHG, CTJA |

A3 II, Sportback, Cabriolet

| | | | | |
|----------|----|---------------|---|------------|
| 1.4 TFSI | 92 | 02/11 → 05/13 | B | CAXC |
| | 92 | 09/07 → 08/12 | B | CAXC, CMSA |

82097
350982097000

KW

SEAT
Altea, Altea XL

1.4 TSI 92 11/07 → B CAXC

Leon II 10.4 TSI 92 11/07 → 12/12 B CAXC

Toledo IV

1.4 TSI 90 07/12 → B CAXA

SKODA
Octavia II, Station Wagon

1.4 TSI 90 11/08 → 06/13 B CAXA

Rapid II

1.4 TSI 90 07/12 → B CAXA

Superb II, Station Wagon

1.4 TSI 92 07/08 → 05/15 B CAXC

Yeti

1.4 TSI 90 06/10 → B CAXA

VOLKSWAGEN
Eos

1.4 TSI 118 05/08 → B CAVD, CTHD

Golf V, Plus, Variant

1.4 TSI 90 06/07 → 12/13 B CAXA

Golf VI, Variant, Cabrio

1.4 TSI 90 10/08 → 11/12 B CAXA

Jetta III

1.4 TSI 90 05/07 → 10/10 B CAXA

Jetta IV

1.4 TSI 90 05/11 → B CAXA, CMSB

Passat VI, Variant, CC

1.4 TSI 90 05/07 → 07/10 B CAXA

Passat VII, Variant, CC, AllTrack

1.4 TSI 90 08/10 → 12/14 B CAXA

Scirocco III

1.4 TSI 90 08/08 → B CAXA, CMSB

Tiguan I

1.4 TSI 90 08/10 → B CAXA

82098
350982098000

PULEGGIA

| | |
|-------------------|------|
| Diametro Puleggia | Ø52 |
| Altezza Puleggia | 33.5 |
| Posizione Attacco | 52.3 |
| Diametro Girante | Ø67 |
| N° Alette Girante | 12 |
| Posizione Girante | 9.5 |

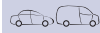
KW

DACIA
Dokker

| | | | | |
|---------|----|---------|---|--------|
| 1.5 dCi | 55 | 11/12 → | D | K9K612 |
| | 66 | 11/12 → | D | K9K612 |

Dokker Express

| | | | | |
|---------|----|---------|---|--------|
| 1.5 dCi | 55 | 12/12 → | D | K9K612 |
| | 66 | 12/12 → | D | K9K612 |

Duster

| | | | | |
|---------|----|---------|---|-------------------|
| 1.5 dCi | 66 | 10/10 → | D | K9K884, K9K892 |
| | 80 | 08/13 → | D | K9K856 |

| | | | | |
|-------------|----|---------|---|-------------------|
| 1.5 dCi 4x4 | 66 | 10/10 → | D | K9K884, K9K894 |
| | 80 | 08/13 → | D | K9K858 |
| | 81 | 10/10 → | D | K9K898 |

Lodgy

| | | | | |
|---------|----|---------|---|--------|
| 1.5 dCi | 66 | 03/12 → | D | K9K612 |
| | 79 | 01/13 → | D | K9K846 |
| | 80 | 06/15 → | D | |
| | 66 | 10/12 → | D | K9K612 |

Logan MCV

| | | | | |
|---------|----|---------|---|--------|
| 1.5 dCi | 55 | 05/10 → | D | K9K892 |
| | 65 | 05/10 → | D | K9K892 |

Logan, Station Wagon, Van

| | | | | |
|---------|----|---------|---|--------|
| 1.5 dCi | 55 | 05/10 → | D | K9K892 |
| | 65 | 05/10 → | D | K9K892 |
| | 55 | 05/10 → | D | K9K892 |
| | 65 | 05/10 → | D | K9K892 |

Sandero I

| | | | | |
|---------|----|---------|---|--------|
| 1.5 dCi | 55 | 05/10 → | D | K9K892 |
| | 65 | 05/10 → | D | K9K892 |

INFINITI
Q30

| | | | | |
|-------|----|---------|---|--|
| 1.5 D | 80 | 11/15 → | D | |
|-------|----|---------|---|--|

82098 350982098000

MERCEDES-BENZ
Citan

| | | | | |
|---------|----|---------|---|-----------|
| 108 CDI | 55 | 11/12 → | D | OM607.951 |
| 109 CDI | 66 | 11/12 → | D | OM607.951 |
| | 66 | 11/12 → | D | OM607.951 |

CLA

| | | | | |
|-----------------|----|---------|---|-----------|
| CLA 180 CDI / d | 80 | 10/13 → | D | OM607.951 |
| CLA 180 d | 80 | 07/15 → | D | OM607.951 |

Classe A III (W176)

| | | | | |
|---------------|----|---------|---|-----------|
| A 160 CDI / d | 66 | 06/13 → | D | OM607.951 |
| A 180 CDI / d | 80 | 06/12 → | D | OM607.951 |

Classe B II (W246)

| | | | | |
|---------------|----|---------|---|-----------|
| B 160 CDI / d | 66 | 05/13 → | D | OM607.951 |
| B 180 CDI / d | 80 | 02/13 → | D | OM607.951 |

Classe GLA (X156)

| | | | | |
|-----------------|----|---------|---|-----------|
| GLA 180 CDI / d | 80 | 07/14 → | D | OM607.951 |
|-----------------|----|---------|---|-----------|

NISSAN
Cube III

| | | | | |
|---------|----|---------|---|-------------|
| 1.5 dCi | 78 | 03/10 → | D | K9K, K9K270 |
| | 81 | 03/10 → | D | K9K, K9K270 |

Juke

| | | | | |
|---------|----|---------|---|----------------|
| 1.5 dCi | 81 | 06/10 → | D | K9K636, K9K896 |
|---------|----|---------|---|----------------|

Note II

| | | | | |
|---------|----|---------|---|--------|
| 1.5 dCi | 66 | 06/13 → | D | K9K892 |
|---------|----|---------|---|--------|

Pulsar

| | | | | |
|---------|----|---------|---|-----|
| 1.5 dCi | 81 | 10/14 → | D | K9K |
|---------|----|---------|---|-----|

Qashqai II

| | | | | |
|---------|----|---------|---|--------|
| 1.5 dCi | 81 | 11/13 → | D | K9K636 |
|---------|----|---------|---|--------|

RENAULT
Captur

| | | | | |
|-------------|----|---------|---|--------|
| 1.5 dCi 110 | 81 | 01/15 → | D | K9K646 |
|-------------|----|---------|---|--------|

Clio III, Grandtour

| | | | | |
|---------|----|---------|---|----------------|
| 1.5 dCi | 55 | 08/10 → | D | K9K770 |
| | 65 | 08/10 → | D | K9K770 |
| | 65 | 08/10 → | D | K9K770, K9K772 |

Clio IV, Grandtour

| | | | | |
|------------|----|---------|---|--------|
| 1.5 dCi 75 | 55 | 01/13 → | D | K9K612 |
| 1.5 dCi 90 | 66 | 01/13 → | D | K9K608 |

Fluence

| | | | | |
|---------|----|---------|---|----------------|
| 1.5 dCi | 66 | 02/10 → | D | K9K834 |
| | 81 | 02/10 → | D | K9K836, K9K837 |

82098 350982098000

RENAULT
Grand Scénic III

| | | | | |
|---------|----|---------|---|------------------------|
| 1.5 dCi | 70 | 11/10 → | D | K9K846 |
| | 81 | 04/09 → | D | K9K636, K9K836, K9K837 |

Kadjar

| | | | | |
|-------------|----|---------|---|----------------|
| 1.5 dCi 110 | 81 | 06/15 → | D | K9K646, K9K647 |
|-------------|----|---------|---|----------------|

Kangoo II, Be Bop, Van

| | | | | |
|-------------|----|---------|---|----------------|
| 1.5 dCi | 66 | 11/12 → | D | K9K808 |
| | 80 | 06/09 → | D | K9K804 |
| | 66 | 06/09 → | D | K9K808 |
| 1.5 dCi 110 | 80 | 09/10 → | D | K9K804 |
| | 81 | 03/13 → | D | K9K636 |
| 1.5 dCi 75 | 55 | 09/10 → | D | K9K608, K9K808 |
| | 55 | 09/10 → | D | K9K802 |
| 1.5 dCi 90 | 66 | 06/09 → | D | K9K608, K9K808 |

Laguna III, Grantour, Coupé

| | | | | |
|---------|----|---------|---|--------|
| 1.5 dCi | 81 | 03/12 → | D | K9K846 |
|---------|----|---------|---|--------|

Latitude

| | | | | |
|---------|----|---------|---|--------|
| 1.5 dCi | 81 | 07/10 → | D | K9K782 |
|---------|----|---------|---|--------|

Megane III, Station Wagon, Coupé, CC

| | | | | |
|---------|----|---------|---|--|
| 1.5 dCi | 66 | 05/09 → | D | K9K834 |
| | 66 | 11/08 → | D | K9KH834 |
| | 81 | 02/09 → | D | K9K636, K9K656, K9K657, K9K836, K9K837, K9K846 |
| | | | | K9K636, K9K836, K9K837, K9K846 |
| | | | | K9K636, K9K837, K9K846, K9KJ836 |
| | 81 | 02/09 → | D | K9K636, K9K836, K9K837, K9K846 |
| | 81 | 02/09 → | D | K9K636, K9K837, K9K846, K9KJ836 |
| | | | | K9K837 |

Megane IV

| | | | | |
|-------------|----|---------|---|--|
| 1.5 dCi 110 | 81 | 11/15 → | D | |
| 1.5 dCi 90 | 66 | 11/15 → | D | |

82098 350982098000



RENAULT

Scénic III

| | | | | |
|---------|----|---------|---|--|
| 1.5 dCi | 70 | 11/10 → | D | K9K846 |
| | 81 | 04/09 → | D | K9K636, K9K656, K9K657, K9K836, K9K837 |

Twingo II

| | | | | |
|------------|----|---------|---|--------|
| 1.5 dCi 75 | 55 | 10/10 → | D | K9K820 |
| 1.5 dCi 90 | 63 | 10/10 → | D | K9K820 |

82099 350982099000



RENAULT

Grand Scénic III

| | | | | |
|---------|----|---------|---|-------------------|
| 1.9 dCi | 96 | 02/09 → | D | F9Q870, F9Q872 |
|---------|----|---------|---|-------------------|

Megane III, Station Wagon, Coupé, CC

| | | | | |
|---------|----|---------|---|--------|
| 1.9 dCi | 96 | 06/10 → | D | F9Q870 |
|---------|----|---------|---|--------|

| | | | | |
|---------|----|---------|---|-------------------|
| 1.9 dCi | 96 | 11/08 → | D | F9Q870, F9Q872 |
|---------|----|---------|---|-------------------|

Scénic III

| | | | | |
|---------|----|---------|---|-------------------|
| 1.9 dCi | 96 | 02/09 → | D | F9Q870, F9Q872 |
|---------|----|---------|---|-------------------|

84000 350984000000



PULEGGIA
 Diametro Puleggia Ø94
 Numero Denti/Gole Puleggia 6
 Altezza Puleggia 23
 Posizione Attacco 72.5
 Diametro Girante Ø61.8
 N° Alette Girante 6
 Posizione Girante 5.5



BMW

1 I (E81, E87), Coupé (E82), Cabrio (E88)

| | | | | |
|-------|-----|---------------|---|---|
| 116 d | 66 | 01/11 → 12/11 | D | N47D20A, N47D20C |
| | 66 | 01/11 → 12/11 | D | N47D20C |
| | 85 | 12/08 → 09/12 | D | N47D20A |
| | 85 | 11/08 → 09/12 | D | N47D20A, N47D20C |
| 118 d | 100 | 11/03 → 09/12 | D | M47D20 (204D4), N47D20A, N47D20C |
| | 100 | 09/06 → 09/12 | D | N47D20A, N47D20C |
| | 100 | 09/09 → 10/13 | D | N47D20C |
| | 105 | 11/03 → 09/12 | D | M47D20 (204D4), N47D20A, N47D20C |
| | 105 | 09/06 → 09/12 | D | N47D20A, N47D20C |
| | 105 | 09/09 → 10/13 | D | N47D20C |
| 120 d | 120 | 03/08 → 12/13 | D | N47D20A, N47D20C |
| | 130 | 11/03 → 09/12 | D | M47D20 (204D4), N47D20A, N47D20C |
| | 130 | 09/06 → 09/12 | D | N47D20A, N47D20C |
| | 145 | 03/08 → 12/13 | D | N47D20C |
| 123 d | 150 | 03/07 → 09/12 | D | N47D20B, N47D20C, N47D20D |
| | 150 | 03/07 → 09/12 | D | N47D20B, N47D20D |

84000 35098400000

BMW
3 V (E90), Touring (E91), Cabrio (E93), Coupé (E92)

| | | | | | |
|-----------------|-----|---------------|---|---------------------|-----------|
| 316 d | 85 | 07/09 → 12/11 | D | N47D20C | |
| | 100 | 07/07 → 12/11 | D | N47D20C | |
| 318 d | 105 | 09/07 → 06/12 | D | N47D20A, N47D20C | |
| 320 d | 120 | 01/07 → 12/13 | D | N47D20C | → 02-2010 |
| | 130 | 03/07 → 12/13 | D | N47D20A | → 02-2010 |
| | 130 | 09/07 → 12/11 | D | N47D20A, N47D20C | |
| 320 d xDrive | 135 | 01/10 → 06/12 | D | N47D20C | |
| | 120 | 07/08 → 12/11 | D | N47D20C | |
| | 130 | 09/08 → 12/11 | D | N47D20C | |
| 320 xd | 130 | 09/08 → 12/13 | D | N47D20C | → 02-2010 |
| | 135 | 01/10 → 06/12 | D | N47D20C | |
| | 130 | 03/07 → 12/13 | D | N47D20A | |
| | 130 | 09/07 → 12/11 | D | N47D20C | |

5 V (E60), Touring (E61)

| | | | | | |
|-------|-----|---------------|---|---------------------|--|
| 520 d | 130 | 09/07 → 03/10 | D | N47D20A, N47D20C | |
|-------|-----|---------------|---|---------------------|--|

X1 I (E84)

| | | | | | |
|-------------|-----|---------------|---|----------------------|--|
| sDrive 18 d | 100 | 03/09 → 06/15 | D | N47D20C | |
| | 105 | 10/09 → 06/15 | D | N47D20C | |
| sDrive 20 d | 120 | 03/10 → 06/15 | D | N47D20C | |
| | 130 | 10/09 → 06/15 | D | N47D20C | |
| xDrive 18 d | 100 | 03/09 → 06/15 | D | N47D20C | |
| | 105 | 10/09 → 06/15 | D | N47D20C | |
| xDrive 20 d | 120 | 03/10 → 06/15 | D | N47D20C | |
| | 130 | 10/09 → 06/15 | D | N47D20C | |
| xDrive 23 d | 150 | 10/09 → 06/15 | D | N47D20C, N47SD20D | |

X3 I (E83)

| | | | | | |
|-------------|-----|---------------|---|---------------------|--|
| 2.0 d | 130 | 09/07 → 03/09 | D | N47D20A, N47D20C | |
| xDrive 18 d | 105 | 09/08 → 12/11 | D | N47D20C | |
| xDrive 20 d | 120 | 09/08 → 08/10 | D | N47D20C | |
| | 130 | 09/08 → 08/10 | D | N47D20C | |

84001 350984001000

PULEGGIA

| | |
|----------------------------|-------|
| Diametro Puleggia | Ø56.2 |
| Numero Denti/Gole Puleggia | 19 |
| Altezza Puleggia | 28.8 |
| Posizione Attacco | 47.5 |
| Diametro Girante | Ø63.4 |
| N° Alette Girante | 8 |
| Posizione Girante | 47.7 |

AUDI
A1, Sportback

| | | | | | |
|---------|-----|---------|---|------|--|
| 1.6 TDI | 66 | 03/11 → | D | CAYB | |
| | 77 | 05/10 → | D | CAYC | |
| 2.0 TDI | 100 | 05/12 → | D | CFHB | |
| | 105 | 09/11 → | D | CFHD | |

A3 II, Sportback, Cabriolet

| | | | | | |
|---------|----|---------------|---|------|--|
| 1.6 TDI | 66 | 05/09 → 08/12 | D | CAYB | |
| | 77 | 05/09 → 08/12 | D | CAYC | |

A4 IV, Avant, Allroad

| | | | | | |
|--------------------|-----|---------------|---|---------------------|--|
| 2.0 TDI | 110 | 05/13 → 12/15 | D | CJCD, CMFB, CSUA | |
| | 130 | 11/11 → 12/15 | D | CGLC | |
| | 130 | 11/11 → 12/15 | D | CGLC, CMGB | |
| 2.0 TDI quattro | 130 | 11/11 → 12/15 | D | CGLC | |

A5, Sportback, Cabriolet

| | | | | | |
|--------------------|-----|---------|---|------|--|
| 2.0 TDI | 105 | 10/11 → | D | CJCA | |
| | 110 | 05/13 → | D | CJCD | |
| | 130 | 10/11 → | D | CGLC | |
| 2.0 TDI quattro | 130 | 12/11 → | D | CGLC | |

A6 IV, Avant, Allroad

| | | | | | |
|---------|-----|---------|---|------------|--|
| 2.0 TDI | 100 | 01/12 → | D | CGLC, CSUE | |
| | 120 | 03/11 → | D | CGLD | |
| | 130 | 03/11 → | D | CGLC, CMGB | |

Q3

| | | | | | |
|--------------------|-----|---------|---|------------|--|
| 2.0 TDI | 100 | 09/11 → | D | CFFA | |
| | 103 | 09/11 → | D | CFFB, CLJA | |
| | 130 | 05/13 → | D | CFGC | |
| 2.0 TDI quattro | 103 | 01/12 → | D | CFFB | |
| | 120 | 06/11 → | D | CFGD | |
| | 130 | 06/11 → | D | CFGC, CLLB | |

Q5

| | | | | | |
|---------|-----|---------|---|------------|--|
| 2.0 TDI | 100 | 11/10 → | D | CJCB, CSUB | |
| | 105 | 11/10 → | D | CJCA | |
| | 110 | 05/13 → | D | CJCD, CSUA | |

84001
350984001000

KW

AUDI
Q5

| | | | | | |
|-----------------|-----|---------|---|------------------------|--------------------|
| 2.0 TDI quattro | 100 | 08/09 → | D | CAGB, CJCB, CSUB | M: 24941 |
| | 100 | 08/09 → | D | CAGB, CJCB, CSUB | |
| | 105 | 08/09 → | D | CAGA, CJCA | M: 24949 |
| | 105 | 08/09 → | D | CAGA, CJCA | |
| | 110 | 05/13 → | D | CJCD, CSUA | |
| | 120 | 11/08 → | D | CAHB, CGLA, CGLD, CNHC | M: 24943, M: 24406 |
| | 120 | 11/08 → | D | CAHB, CGLA, CGLD, CNHC | |
| | 125 | 11/08 → | D | CAHA, CGLB, CMGA | M: 25767, M: 24948 |
| | 125 | 11/08 → | D | CAHA, CGLB, CMGA | |
| | 130 | 06/12 → | D | CGLC, CMGB | |

SEAT
Alhambra II

| | | | | | |
|----------------|-----|---------------|---|------|--|
| 2.0 TDI | 85 | 05/11 → | D | CFFE | |
| | 100 | 06/10 → 05/11 | D | CFFA | |
| | 103 | 06/10 → | D | CFFB | |
| | 125 | 06/10 → | D | CFGB | |
| | 130 | 11/12 → | D | CFGC | |
| 2.0 TDI 4Drive | 103 | 05/11 → | D | CFFB | |

Altea, Altea XL

| | | | | | |
|-----------------|-----|---------|---|------|--|
| 1.6 TDI | 66 | 11/10 → | D | CAYB | |
| | 77 | 10/09 → | D | CAYC | |
| 2.0 TDI 16V 4x4 | 103 | 10/10 → | D | CFHC | |

Ibiza V

| | | | | | |
|---------|-----|---------|---|------------|--|
| 1.2 TDI | 55 | 05/10 → | D | CFWA | |
| 1.6 TDI | 66 | 05/09 → | D | CAYB | |
| | 77 | 05/09 → | D | CAYC, CLNA | |
| 2.0 TDI | 105 | 01/10 → | D | CFHD | |

Leon II

| | | | | | |
|---------|----|---------------|---|------|--|
| 1.6 TDI | 66 | 11/10 → 12/12 | D | CAYB | |
| | 77 | 02/10 → 12/12 | D | CAYC | |

Toledo IV

| | | | | | |
|---------|----|---------|---|------------|--|
| 1.6 TDI | 77 | 07/12 → | D | CAYC, CLNA | |
|---------|----|---------|---|------------|--|

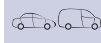
84001
350984001000

KW

SKODA
Fabia II, Station Wagon, Van

| | | | | | |
|---------|----|---------------|---|------|--|
| 1.2 TDI | 55 | 05/10 → 12/14 | D | CFWA | |
| | 55 | 04/10 → 12/14 | D | CAYA | |
| 1.6 TDI | 66 | 03/10 → 12/14 | D | CAYB | |
| | 77 | 03/10 → 12/14 | D | CAYC | |

Octavia II, Station Wagon

| | | | | | |
|-----------------|-----|---------------|---|------------|--|
| 1.6 TDI | 77 | 06/09 → 04/13 | D | CAYC | |
| 1.6 TDI 4x4 | 77 | 06/09 → 02/13 | D | CAYC | |
| 2.0 TDI | 81 | 03/10 → 06/13 | D | CFHF, CLCA | |
| 2.0 TDI 16V 4x4 | 103 | 05/10 → 02/13 | D | CFHC | |
| 2.0 TDI 4x4 | 81 | 05/11 → 02/13 | D | CFHF | |

Rapid II

| | | | | | |
|---------|----|---------|---|------------|--|
| 1.6 TDI | 66 | 08/13 → | D | CAYB | |
| | 77 | 07/12 → | D | CAYC, CLNA | |

Roomster, Van

| | | | | | |
|---------|----|---------------|---|------|--|
| 1.2 TDI | 55 | 03/10 → 05/15 | D | CFWA | |
| 1.6 TDI | 66 | 03/10 → 05/15 | D | CAYB | |
| | 77 | 03/10 → 05/15 | D | CAYC | |

Superb II, Station Wagon

| | | | | | |
|-----------------|-----|---------------|---|------|--|
| 1.6 TDI | 77 | 09/10 → 05/15 | D | CAYC | |
| 2.0 TDI 16V 4x4 | 103 | 11/10 → 05/15 | D | CFFB | |

Yeti

| | | | | | |
|-------------|-----|---------|---|------------------|---------|
| 1.6 TDI | 77 | 11/10 → | D | CAYC | |
| 2.0 TDI | 81 | 11/09 → | D | CFHA, CLCA | |
| | 103 | 11/11 → | D | CFHC | |
| 2.0 TDI 4x4 | 81 | 11/09 → | D | CFHF | |
| | 103 | 05/09 → | D | CBDB, CFHC, CLCB | M: CFHC |
| | 103 | 05/09 → | D | CBDB, CFHC, CLCB | |
| | 125 | 11/09 → | D | CEGA, CFJA | M: CFJA |
| | 125 | 11/09 → | D | CEGA, CFJA | |

VOLKSWAGEN
Amarok

| | | | | | |
|-------------------|-----|---------|---|------------|--|
| 2.0 BitDI | 120 | 09/10 → | D | CDCA | |
| | 132 | 11/11 → | D | CNEA, CSHA | |
| 2.0 BitDI 4motion | 120 | 09/10 → | D | CDCA | |
| | 132 | 11/11 → | D | CNEA, CSHA | |
| 2.0 TDI | 90 | 09/10 → | D | CDBA, CNFA | |
| | 103 | 07/12 → | D | CNFB | |
| 2.0 TDI 4motion | 90 | 09/10 → | D | CDBA, CNFA | |
| | 103 | 06/12 → | D | CNFB | |

84001 350984001000

VOLKSWAGEN
Beetle II (Maggiolino)

| | | | | | |
|---------|-----|---------|---|------------|--|
| 1.6 TDI | 77 | 10/11 → | D | CAYC | |
| 2.0 TDI | 103 | 04/11 → | D | CFFB, CJAA | |

Caddy III

| | | | | | |
|---------------------|-----|---------|---|------------|--|
| 1.6 TDI | 55 | 08/10 → | D | CAYE | |
| | 75 | 08/10 → | D | CAYD | |
| 2.0 TDI | 62 | 11/10 → | D | CFHE | |
| | 81 | 08/10 → | D | CLCA | |
| | 125 | 05/12 → | D | CFJA | |
| 2.0 TDI 16V | 103 | 11/10 → | D | CFHC, CLCB | |
| 2.0 TDI 16V 4motion | 103 | 11/10 → | D | CFHC | |
| 2.0 TDI 4motion | 62 | 12/10 → | D | CFHE | |
| | 81 | 08/10 → | D | CFHF | |

CC

| | | | | | |
|-----------------|-----|---------|---|------------|--|
| 2.0 TDI | 100 | 11/11 → | D | CFFA | |
| | 103 | 11/11 → | D | CFFB | |
| | 125 | 11/11 → | D | CFGB, CLLA | |
| | 130 | 12/12 → | D | CFGC | |
| 2.0 TDI 4motion | 103 | 11/11 → | D | CFFB | |
| | 125 | 11/11 → | D | CFGB | |
| | 130 | 12/12 → | D | CFGC | |

Crafter 30-35, 30-50

| | | | | | |
|-----------------|-----|---------|---|------------|--|
| 2.0 TDI | 80 | 05/11 → | D | CKTB | |
| | 100 | 05/11 → | D | CKTC | |
| | 105 | 10/11 → | D | CKUC | |
| | 120 | 07/11 → | D | CKUB, CSNA | |
| 2.0 TDI 4motion | 120 | 11/11 → | D | CKUB, CSNA | |

Eos

| | | | | | |
|---------|-----|---------|---|------|--|
| 2.0 TDI | 100 | 11/10 → | D | CFFA | |
|---------|-----|---------|---|------|--|

Golf V, Plus, Variant

| | | | | | |
|---------|----|---------------|---|------|--|
| 1.6 TDI | 66 | 02/09 → 12/13 | D | CAYB | |
| | 77 | 03/09 → 12/13 | D | CAYC | |

Golf VI, Variant, Cabrio

| | | | | | |
|-----------------|-----|---------------|---|------------|---------|
| 1.6 TDI | 66 | 02/09 → 11/12 | D | CAYB | |
| | 77 | 02/09 → 11/12 | D | CAYC | |
| 1.6 TDI 4motion | 77 | 07/09 → 07/13 | D | CAYC | |
| 2.0 TDI | 81 | 01/10 → 07/13 | D | CLCA | |
| | 100 | 10/08 → 11/12 | D | CBAA, CFFA | M: CFFA |
| | 100 | 10/08 → 11/12 | D | CBAA, CFFA | |
| | 103 | 11/11 → | D | CFHC | |
| 2.0 TDI 4motion | 103 | 05/09 → 11/12 | D | CBAB, CFFB | M: CFFB |
| | 103 | 05/09 → 11/12 | D | CBAB, CFFB | |

84001 350984001000

VOLKSWAGEN
Jetta III

| | | | | | |
|---------|----|---------------|---|------|--|
| 1.6 TDI | 66 | 12/09 → 10/10 | D | CAYB | |
| | 77 | 06/09 → 10/10 | D | CAYC | |

Jetta IV

| | | | | | |
|---------|-----|---------|---|------------------------|--|
| 1.6 TDI | 77 | 02/11 → | D | CAYC | |
| | 81 | 10/10 → | D | CLCA | |
| 2.0 TDI | 103 | 02/11 → | D | CFFB, CFHC, CJAA, CLCB | |

Multivan V

| | | | | | |
|-------------------|-----|---------|---|------------|--|
| 2.0 BiTDI | 132 | 09/09 → | D | CFCA | |
| 2.0 BiTDI 4motion | 132 | 09/09 → | D | CFCA | |
| 2.0 TDI | 62 | 09/09 → | D | CAAA | |
| | 75 | 09/09 → | D | CAAB | |
| | 84 | 05/11 → | D | CAAD | |
| | 100 | 05/10 → | D | CAAE, CCHB | |
| | 103 | 09/09 → | D | CAAC, CCHA | |
| 2.0 TDI 4motion | 100 | 05/10 → | D | CAAE, CCHB | |
| | 103 | 09/09 → | D | CAAC, CCHA | |

Passat VI, Variant, CC

| | | | | | |
|---------|-----|---------------|---|------|--|
| 1.6 TDI | 77 | 08/09 → 07/10 | D | CAYC | |
| 2.0 TDI | 120 | 05/08 → 05/11 | D | CBBA | |

Passat VII, Variant, CC, AllTrack

| | | | | | |
|-----------------|-----|---------------|---|------------|--|
| 1.6 TDI | 77 | 08/10 → 12/14 | D | CAYC | |
| 2.0 TDI | 100 | 08/10 → 12/14 | D | CFFA | |
| | 103 | 08/10 → 12/14 | D | CFFB | |
| | 125 | 08/10 → 12/14 | D | CFGB, CLLA | |
| | 130 | 12/12 → 12/14 | D | CFGC | |
| 2.0 TDI 4motion | 103 | 08/10 → 12/14 | D | CFFB | |
| | 125 | 01/12 → 12/14 | D | CFGB | |
| | 125 | 08/10 → 01/13 | D | CFGB, CLLA | |
| | 130 | 01/13 → 12/14 | D | CFGC | |

Polo VI (6R)

| | | | | | |
|---------|----|---------|---|------------|--|
| 1.2 TDI | 55 | 10/09 → | D | CFWA | |
| 1.6 TDI | 55 | 06/09 → | D | CAYA | |
| | 66 | 06/09 → | D | CAYB | |
| | 77 | 06/09 → | D | CAYC, CLNA | |

Scirocco III

| | | | | | |
|---------|-----|---------|---|------|--|
| 2.0 TDI | 100 | 11/10 → | D | CFHB | |
| | 130 | 01/13 → | D | CFGC | |

84001
350984001000

KW

VOLKSWAGEN
Sharan II

| | | | | |
|--------------------|-----|---------------|---|------------|
| 2.0 TDI | 85 | 05/11 → | D | CFFE, CUVA |
| | 100 | 05/10 → | D | CFFA |
| | 103 | 05/10 → | D | CFFB |
| | 125 | 08/10 → | D | CFGB |
| | 130 | 01/13 → | D | CFGC |
| 2.0 TDI 4motion | 100 | 05/11 → 05/12 | D | CFFA |
| | 103 | 05/11 → | D | CFFB |

Tiguan I

| | | | | |
|--------------------|-----|---------|---|------|
| 2.0 TDI | 81 | 05/10 → | D | CFFD |
| 2.0 TDI 4motion | 130 | 11/12 → | D | CFGC |

Touran I

| | | | | |
|---------|-----|---------------|---|------------|
| 1.6 TDI | 66 | 05/10 → 05/15 | D | CAYB |
| | 77 | 05/10 → 05/15 | D | CAYC |
| 2.0 TDI | 81 | 11/10 → 05/15 | D | CFHF, CLCA |
| | 103 | 05/10 → 05/15 | D | CFHC |
| | 125 | 05/10 → 01/13 | D | CFJA |
| | 130 | 01/13 → 05/15 | D | CFJB |

Transporter V

| | | | | |
|----------------------|-----|---------|---|------------|
| 2.0 BitDI | 132 | 09/09 → | D | CFCA |
| 2.0 BitDI 4motion | 132 | 09/09 → | D | CFCA |
| 2.0 TDI | 62 | 09/09 → | D | CAAA |
| | 75 | 09/09 → | D | CAAB |
| | 84 | 05/11 → | D | CAAD |
| | 100 | 05/10 → | D | CAAE |
| | 100 | 05/10 → | D | CAAE, CCHB |
| | 103 | 09/09 → | D | CAAC |
| 2.0 TDI 4motion | 100 | 05/10 → | D | CAAE, CCHB |
| | 103 | 09/09 → | D | CAAC |
| | 103 | 09/09 → | D | CAAC, CCHA |

84002
350984002000

FLANGIA

| | |
|-------------------------|---------|
| Numero Fori Flangia | 4 |
| Dimensione Fori Flangia | M6×1 |
| Posizione Attacco | 75.7 |
| Diametro Mozzo | M30×1.5 |
| Diametro Centraggio | Ø35 |
| Diametro Girante | Ø60 |
| N° Alette Girante | 6 |
| Posizione Girante | 4 |

KW

MERCEDES-BENZ
Sprinter III (906)

| | | | | |
|---------|-----|---------|---|----------|
| 216 | 115 | 09/08 → | B | M271.951 |
| 316 | 115 | 09/08 → | B | M271.951 |
| 316 LGT | 115 | 09/08 → | | M271.951 |
| | 115 | 09/08 → | | M271.951 |
| 316 NGT | 115 | 09/08 → | | M271.951 |
| 516 | 115 | 09/08 → | B | M271.951 |
| 516 NGT | 115 | 09/08 → | | M271.951 |

84003
350984003000

FLANGIA

| | |
|-------------------------|------|
| Numero Fori Flangia | 3 |
| Dimensione Fori Flangia | M6×1 |
| Posizione Attacco | 55.2 |
| Diametro Centraggio | Ø25 |
| Diametro Girante | Ø47 |
| N° Alette Girante | 8 |
| Posizione Girante | 17.7 |

KW

DACIA
Dokker

| | | | | |
|---------|----|---------|---|-------------------|
| 1.2 TCe | 85 | 11/12 → | B | H5F402 |
| 1.6 | 61 | 11/12 → | B | K7M812, K7M828 |

Dokker Express

| | | | | |
|-------------|----|---------|---|-------------------|
| 1.2 TCe 115 | 84 | 12/12 → | B | H5F402 |
| 1.6 | 61 | 12/12 → | B | K7M812, K7M828 |

Duster

| | | | | |
|-------------|----|---------|---|--------|
| 1.2 TCe 125 | 92 | 10/13 → | B | H5F404 |
| | 92 | 06/15 → | B | H5F404 |

Lodgy

| | | | | |
|---------|----|---------|---|-------------------|
| 1.2 TCe | 85 | 03/12 → | B | H5F402 |
| 1.6 | 61 | 03/12 → | B | K7M812, K7M828 |

84003 350984003000

DACIA
Logan

| | | | | |
|--------|----|---------|---|--------|
| TCe 90 | 66 | 10/12 → | B | H4B400 |
|--------|----|---------|---|--------|

Logan MCV

| | | | | |
|--------|----|---------|---|--------|
| TCe 90 | 66 | 02/13 → | B | H4B400 |
|--------|----|---------|---|--------|

Sandero II

| | | | | |
|--------|----|---------|---|--------|
| TCe 90 | 66 | 10/12 → | B | H4B400 |
|--------|----|---------|---|--------|

NISSAN
Cube III

| | | | | |
|---------|----|---------|---|--------|
| 1.6 16V | 81 | 03/10 → | B | HR16DE |
|---------|----|---------|---|--------|

Juke

| | | | | |
|-----------|----|---------|---|---------|
| 1.2 DIG-T | 85 | 05/14 → | B | HR12DDT |
|-----------|----|---------|---|---------|

| | | | | |
|-----|----|---------|---|--------|
| 1.6 | 69 | 01/13 → | B | HR16DE |
|-----|----|---------|---|--------|

| | | | | |
|--|----|---------|---|--------|
| | 86 | 06/10 → | B | HR16DE |
|--|----|---------|---|--------|

Micra III (K12), C+C

| | | | | |
|------------|----|---------|---|--------|
| 1.6 160 SR | 81 | 08/05 → | B | HR16DE |
|------------|----|---------|---|--------|

Micra IV (K13)

| | | | | |
|-----|----|---------|---|--------|
| 1.2 | 56 | 05/10 → | B | HR12DE |
|-----|----|---------|---|--------|

| | | | | |
|--|----|---------|---|--------|
| | 59 | 05/10 → | B | HR12DE |
|--|----|---------|---|--------|

| | | | | |
|---------|----|---------|---|---------|
| 1.2 DIG | 72 | 04/11 → | B | HR12DDR |
|---------|----|---------|---|---------|

Note I

| | | | | |
|-----|----|---------|---|--------|
| 1.6 | 81 | 03/06 → | B | HR16DE |
|-----|----|---------|---|--------|

Note II

| | | | | |
|-----|----|---------|---|--------|
| 1.2 | 59 | 06/13 → | B | HR12DE |
|-----|----|---------|---|--------|

| | | | | |
|---------|----|---------|---|---------|
| 1.2 DIG | 72 | 06/13 → | B | HR12DDR |
|---------|----|---------|---|---------|

| | | | | |
|---------|----|---------|--|--------|
| 1.2 LPG | 56 | 03/15 → | | HR12DE |
|---------|----|---------|--|--------|

Pulsar

| | | | | |
|-----------|----|---------|---|---------|
| 1.2 DIG-T | 85 | 10/14 → | B | HR12DDT |
|-----------|----|---------|---|---------|

Qashqai I

| | | | | |
|-----|----|---------|---|--------|
| 1.6 | 84 | 02/07 → | B | HR16DE |
|-----|----|---------|---|--------|

| | | | | |
|--|----|---------|---|--------|
| | 86 | 11/10 → | B | HR16DE |
|--|----|---------|---|--------|

Qashqai II

| | | | | |
|-----------|----|---------|---|---------|
| 1.2 DIG-T | 85 | 11/13 → | B | HR12DDT |
|-----------|----|---------|---|---------|

Sentra VII

| | | | | |
|-----|----|---------|---|--------|
| 1.6 | 86 | 08/14 → | B | HR16DE |
|-----|----|---------|---|--------|

Tiida II

| | | | | |
|-----|----|---------|---|--------|
| 1.6 | 81 | 09/07 → | B | HR16DE |
|-----|----|---------|---|--------|

RENAULT
Captur

| | | | | |
|------------|----|---------|---|--------|
| 0.9 TCe 90 | 66 | 06/13 → | B | H4B400 |
|------------|----|---------|---|--------|

| | | | | |
|-------------|----|---------|---|--------|
| 1.2 TCe 120 | 88 | 06/13 → | B | H5F403 |
|-------------|----|---------|---|--------|

Clio IV, Grandtour

| | | | | |
|------------|----|---------|---|--------|
| 0.9 TCe 90 | 66 | 01/13 → | B | H4B400 |
|------------|----|---------|---|--------|

| | | | | |
|-------------|----|---------|---|--------|
| 1.2 TCe 120 | 88 | 03/13 → | B | H5F403 |
|-------------|----|---------|---|--------|

84003 350984003000

RENAULT
Grand Scénic III

| | | | | |
|---------|----|---------|---|--------|
| 1.2 TCe | 97 | 01/13 → | B | H5F404 |
|---------|----|---------|---|--------|

| | | | | |
|---------|----|---------|---|--------|
| 1.4 16V | 96 | 02/09 → | B | H4J700 |
|---------|----|---------|---|--------|

Kadjar

| | | | | |
|-------------|----|---------|---|--------|
| 1.2 TCe 130 | 96 | 06/15 → | B | H5F408 |
|-------------|----|---------|---|--------|

Kangoo II, Be Bop, Van

| | | | | |
|-------------|----|---------|---|--------|
| 1.2 TCe 115 | 84 | 07/13 → | B | H5F400 |
|-------------|----|---------|---|--------|

Megane III, Station Wagon, Coupé, CC

| | | | | |
|---------|----|---------|---|--------|
| 1.2 TCe | 97 | 01/13 → | B | H5F404 |
|---------|----|---------|---|--------|

| | | | | |
|---------|----|---------|---|--------|
| 1.4 TCe | 96 | 06/10 → | B | H4J700 |
|---------|----|---------|---|--------|

Megane IV

| | | | | |
|-------------|----|---------|---|--|
| 1.2 TCe 100 | 74 | 11/15 → | B | |
|-------------|----|---------|---|--|

| | | | | |
|-------------|----|---------|---|--|
| 1.2 TCe 130 | 97 | 11/15 → | B | |
|-------------|----|---------|---|--|

Scénic III

| | | | | |
|---------|----|---------|---|--------|
| 1.2 TCe | 97 | 01/13 → | B | H5F404 |
|---------|----|---------|---|--------|

| | | | | |
|---------|----|---------|---|--------|
| 1.4 16V | 96 | 02/09 → | B | H4J700 |
|---------|----|---------|---|--------|

Twingo III

| | | | | |
|------------|----|---------|---|--------|
| 0.9 TCe 90 | 66 | 09/14 → | B | H4B401 |
|------------|----|---------|---|--------|

| | | | | |
|------------|----|---------|---|--------|
| 1.0 SCe 70 | 52 | 09/14 → | B | H4D400 |
|------------|----|---------|---|--------|

SMART
ForFour II

| | | | | |
|-----|----|---------|---|----------|
| 0.9 | 66 | 11/14 → | B | M281.910 |
|-----|----|---------|---|----------|

| | | | | |
|-----|----|---------|---|----------|
| 1.0 | 45 | 11/14 → | B | M281.920 |
|-----|----|---------|---|----------|

| | | | | |
|--|----|---------|---|----------|
| | 52 | 07/14 → | B | M281.920 |
|--|----|---------|---|----------|

ForTwo III Coupé, Cabrio

| | | | | |
|-----|----|---------|---|----------|
| 0.9 | 66 | 09/15 → | B | M281.910 |
|-----|----|---------|---|----------|

| | | | | |
|-----|----|---------|---|----------|
| 1.0 | 45 | 11/14 → | B | M281.920 |
|-----|----|---------|---|----------|

| | | | | |
|--|----|---------|---|----------|
| | 52 | 09/15 → | B | M281.920 |
|--|----|---------|---|----------|

84004

350984004000

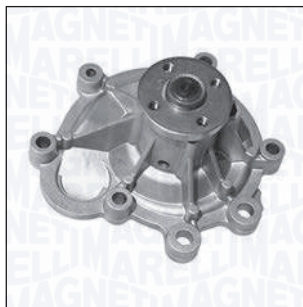

| | |
|-------------------------|------|
| FLANGIA | |
| Numero Fori Flangia | 4 |
| Dimensione Fori Flangia | M6x1 |
| Posizione Attacco | 66.6 |
| Diametro Centraggio | Ø22 |
| Diametro Girante | Ø60 |
| N° Alette Girante | 6 |
| Posizione Girante | 3.8 |



KW



MERCEDES-BENZ

Classe C II (W203), Station Wagon (S203), Coupé (CL203)

| | | | | |
|----------------------|-----|---------------|---|----------|
| C 160 Kompressor | 90 | 05/02 → 05/08 | B | M271.921 |
| C 180 Kompressor | 105 | 05/02 → 02/07 | B | M271.946 |
| C 200 CGI Kompressor | 125 | 07/03 → 02/07 | B | M271.942 |
| C 220 | 120 | 05/02 → 05/08 | B | M271.940 |
| C 230 Kompressor | 141 | 02/04 → 02/07 | B | M271.948 |

Classe C III (W204), Station Wagon (S204), Coupé (C204)

| | | | | |
|------------------|-----|---------------|---|--------------------|
| C 180 | 115 | 06/11 → | B | M271.820 |
| C 180 CGI | 115 | 01/07 → 01/14 | B | M271.820 |
| C 180 Kompressor | 115 | 01/08 → 01/14 | B | M271.910 |
| | 115 | 01/07 → 01/14 | B | M271.952 |
| C 200 | 137 | 05/11 → 01/14 | B | M271.820 |
| | 135 | 01/07 → 01/14 | B | M271.820 |
| C 200 CGI | 135 | 08/07 → 08/14 | B | M271.820, M271.860 |
| C 200 Kompressor | 135 | 01/07 → 01/14 | B | M271.950 |
| C 250 | 150 | 06/11 → | B | M271.860 |
| C 250 CGI | 150 | 07/09 → 01/14 | B | M271.860 |

Classe CLC

| | | | | |
|--------------------|-----|---------------|---|----------|
| CLC 160 | 95 | 02/09 → 06/11 | B | M271.911 |
| CLC 180 Kompressor | 105 | 05/08 → 06/11 | B | M271.946 |
| CLC 200 Kompressor | 135 | 05/08 → 06/11 | B | M271.957 |

Classe E III (W211), Station Wagon (S211)

| | | | | |
|--------------------|-----|---------------|---|----------|
| E 200 Kompressor | 120 | 11/02 → 12/08 | B | M271.941 |
| | 135 | 04/06 → 12/08 | B | M271.956 |
| E 200 NGT | 120 | 03/04 → 12/08 | | M271.941 |
| E 200 T Kompressor | 120 | 03/03 → 07/09 | B | M271.941 |

84004

350984004000



KW



MERCEDES-BENZ

Classe E IV (W212), Station Wagon (S212), Cabrio (A207), Coupé (C207)

| | | | | |
|-----------|-----|---------|---|--------------------|
| E 200 CGI | 135 | 08/09 → | B | M271.820, M271.860 |
| E 200 NGT | 120 | 03/11 → | | M271.958 |
| E 250 CGI | 150 | 01/09 → | B | M271.860 |

CLK II (C209), Cabrio (A209)

| | | | | |
|--------------------|-----|---------------|---|----------|
| 200 CGI | 125 | 07/03 → 05/09 | B | M271.942 |
| 200 | 120 | 09/02 → 05/09 | B | M271.940 |
| Kompressor | 135 | 10/06 → 05/09 | B | M271.955 |
| CLK 200 Kompressor | 120 | 02/03 → 03/10 | B | M271.940 |
| | 135 | 10/06 → 03/10 | B | M271.955 |

SLK II (R171)

| | | | | |
|----------------|-----|---------------|---|--------------------|
| 200 Kompressor | 120 | 03/04 → 02/11 | B | M271.944 |
| | 135 | 01/08 → 02/11 | B | M271.954 |
| 200 | 135 | 02/11 → | B | M271.860, M271.861 |
| 250 | 150 | 02/11 → | B | M271.860, M271.861 |

84005

350984005000



| | |
|-------------------------|------|
| FLANGIA | |
| Numero Fori Flangia | 3 |
| Dimensione Fori Flangia | M6x1 |
| Posizione Attacco | 75 |
| Diametro Girante | Ø75 |
| N° Alette Girante | 8 |
| Posizione Girante | 5.5 |



KW



CHEVROLET

Cruze II, Hatchback, Station Wagon

| | | | | |
|--------|----|---------|---|-----|
| 1.7 D | 96 | 01/12 → | D | LUD |
| 1.7 TD | 96 | 08/12 → | D | LUD |

Trax

| | | | | |
|-----------|----|---------|---|-----|
| 1.7 TD | 96 | 12/12 → | D | LUD |
| 1.7 TDAWD | 96 | 12/12 → | D | LUD |

84005 **350984005000**

OPEL
Astra H, Station Wagon, GTC, Twin Top, Van

| | | | | | |
|----------|----|---------|---|-------------------|--------------|
| 1.7 CDTI | 59 | 03/05 → | D | Z17DTL | |
| | 74 | 03/04 → | D | Z17DTH | T →: 1874033 |
| | 74 | 03/04 → | D | Z17DTH | |
| | 81 | 02/07 → | D | A17DTJ, Z17DTJ | |
| | 81 | 02/07 → | D | Z17DTJ | |
| | 92 | 02/07 → | D | A17DTR, Z17DTR | |

Astra J, Station Wagon, GTC

| | | | | | |
|----------|----|---------|---|------------------------------|--|
| 1.7 CDTI | 74 | 10/10 → | D | A17DTL, A17DTN | |
| | 81 | 10/11 → | D | A17DTC, A17DTE, A17DTJ | |
| | 92 | 12/09 → | D | A17DTR | |
| | 96 | 10/11 → | D | A17DTF, A17DTS | |

Corsa D, Van

| | | | | | |
|----------|----|---------|---|--------|--------------|
| 1.7 CDTI | 92 | 07/06 → | D | Z17DTR | T →: 1874033 |
| | 96 | 06/10 → | D | A17DTS | T →: 1874033 |

Meriva B

| | | | | | |
|----------|----|---------|---|-------------------|--|
| 1.7 CDTI | 74 | 06/10 → | D | A17DT | |
| | 81 | 06/10 → | D | A17DTC, A17DTI | |
| | 96 | 06/10 → | D | A17DTS | |

Mokka

| | | | | | |
|-----------------|----|---------|---|--------|--|
| 1.7 CDTI | 96 | 06/12 → | D | A17DTS | |
| 1.7 CDTI 4x4 | 96 | 06/12 → | D | A17DTS | |

Zafira B, Van

| | | | | | |
|----------|----|---------|---|-------------------|--------------|
| 1.7 CDTI | 81 | 01/08 → | D | A17DTJ, Z17DTJ | T →: 1874033 |
| | 81 | 01/08 → | D | A17DTJ, Z17DTJ | |
| | 92 | 01/08 → | D | A17DTR | T →: 1874033 |
| | 92 | 01/08 → | D | A17DTR | |

84006 **350984006000**

PULEGGIA

| | |
|-------------------|-------|
| Diametro Puleggia | Ø52 |
| Altezza Puleggia | 37 |
| Posizione Attacco | 48.5 |
| Diametro Girante | Ø70.3 |
| N° Alette Girante | 10 |
| Posizione Girante | 7.8 |

NISSAN
Primera III, Hatchback, Station Wagon

| | | | | | |
|---------|----|---------|---|-----|--|
| 1.9 dCi | 88 | 04/03 → | D | F9Q | |
|---------|----|---------|---|-----|--|

RENAULT
Grand Scénic II

| | | | | | |
|---------|----|---------------|---|--|--|
| 1.9 dCi | 85 | 05/05 → 01/09 | D | F9Q803, F9Q804, F9Q812 | |
| | 81 | 05/05 → | D | F9QE804 | |
| | 88 | 04/04 → | D | F9Q812 | |
| | 96 | 05/05 → | D | F9Q816, F9Q818, F9QEE804, F9QJ803 | |

Laguna II, Grantour

| | | | | | |
|---------|----|---------|---|-------------------|--|
| 1.9 dCi | 68 | 03/04 → | D | F9Q664 | |
| | 81 | 01/05 → | D | F9Q674, F9Q758 | |
| | 96 | 05/05 → | D | F9Q758, F9Q759 | |

Megane II, Station Wagon, Coupé-Cabrio

| | | | | | |
|---------|----|---------------|---|------------------------------|--|
| 1.9 dCi | 66 | 11/02 → 12/05 | D | F9Q808 | |
| | 68 | 03/04 → 08/06 | D | F9Q808 | |
| | 81 | 05/05 → 03/09 | D | F9Q804, F9Q816, F9Q818 | |
| | 81 | 05/05 → 02/08 | D | F9Q804, F9Q818 | |
| | 85 | 11/02 → 02/08 | D | F9Q804, F9Q816, F9Q818 | |
| | 85 | 05/05 → 07/09 | D | F9Q818 | |
| | 88 | 09/03 → 03/09 | D | F9Q800 | |
| | 96 | 05/05 → 02/07 | D | F9Q803, F9Q804 | |

84006
350984006000

KW

RENAULT
Megane II, Station Wagon, Coupé-Cabrio

| | | | | |
|---------|----|---------------|---|---|
| 1.9 dCi | 96 | 05/05 → 12/09 | D | F9Q803, F9Q804, F9Q816, F9Q818 |
| | 81 | 05/05 → | D | F9Q803, F9Q804, F9Q816, F9Q818 |
| | 88 | 11/02 → 02/08 | D | F9Q800 |

Scénic II

| | | | | |
|---------|----|---------|---|--|
| 1.9 D | 85 | 06/06 → | D | F9Q812, F9QJ803 |
| 1.9 dCi | 92 | 06/03 → | D | F9Q804 |
| | 81 | 05/05 → | D | F9Q804 |
| | 88 | 06/03 → | D | F9Q812 |
| | 96 | 05/05 → | D | F9Q804, F9Q816, F9Q818, F9QJ803 |

SUZUKI
Grand Vitara II

| | | | | |
|----------|----|---------------|---|------|
| 1.9 DDiS | 95 | 10/05 → 02/15 | D | F9QB |
|----------|----|---------------|---|------|

84007
350984007000

PULEGGIA

| | |
|-------------------|------|
| Diametro Puleggia | Ø52 |
| Altezza Puleggia | 32.8 |
| Posizione Attacco | 50.5 |
| Diametro Girante | Ø74 |
| N° Alette Girante | 10 |
| Posizione Girante | 6.8 |

KW

DACIA
Duster

| | | | | |
|-------------|----|---------|---|-------------------|
| 1.5 dCi | 63 | 04/10 → | D | K9K796, K9K830 |
| | 79 | 06/10 → | D | K9K896 |
| 1.5 dCi 4x4 | 79 | 06/10 → | D | K9K898 |

Logan

| | | | | |
|---------|----|---------|---|--------|
| 1.5 dCi | 55 | 10/12 → | D | K9K612 |
| | 63 | 01/13 → | D | K9K830 |

84007
350984007000

KW

DACIA
Logan MCV

| | | | | |
|---------|----|---------|---|--------|
| 1.5 dCi | 55 | 02/13 → | D | K9K612 |
| | 63 | 02/13 → | D | K9K830 |
| | 66 | 02/13 → | D | K9K612 |
| | 50 | 02/07 → | D | K9K792 |
| | 63 | 09/07 → | D | K9K796 |

Logan, Station Wagon, Van

| | | | | |
|---------|----|---------|---|--------|
| 1.5 dCi | 48 | 09/05 → | D | K9K790 |
| | 50 | 01/06 → | D | K9K792 |
| | 63 | 09/07 → | D | K9K796 |

Sandero I

| | | | | |
|---------|----|---------|---|--------|
| 1.5 dCi | 50 | 11/08 → | D | K9K792 |
| | 63 | 11/08 → | D | K9K796 |

Sandero II

| | | | | |
|---------|----|---------|---|--------|
| 1.5 dCi | 55 | 10/12 → | D | K9K612 |
| | 63 | 01/13 → | D | K9K830 |
| | 66 | 10/12 → | D | K9K612 |

NISSAN
Kubistar

| | | | | |
|------------|----|---------------|---|-------------------|
| 1.5 dCi 70 | 50 | 04/06 → 10/09 | D | K9K700, K9K716 |
| 1.5 dCi 85 | 62 | 04/06 → 10/09 | D | K9K276 |

Micra III (K12), C+C

| | | | | |
|---------|----|---------------|---|--------|
| 1.5 dCi | 50 | 06/05 → 06/10 | D | K9K708 |
| | 63 | 06/05 → 06/10 | D | K9K276 |

Note I

| | | | | |
|---------|----|---------|---|--------|
| 1.5 dCi | 50 | 03/06 → | D | K9K700 |
| | 63 | 03/06 → | D | K9K276 |
| | 66 | 09/10 → | D | K9K276 |
| | 76 | 07/08 → | D | K9K292 |

NV 200 Evalia, Box

| | | | | |
|---------|----|---------|---|------------------------------|
| 1.5 dci | 63 | 07/10 → | D | K9K400, K9K608, K9K628 |
| | 66 | 04/11 → | D | K9K892 |
| | 81 | 04/11 → | D | K9K636, K9K646 |

Qashqai I

| | | | | |
|---------|----|---------|---|-------------------|
| 1.5 dCi | 76 | 07/08 → | D | K9K410 |
| | 78 | 02/07 → | D | K9K732, K9K764 |
| | 81 | 11/10 → | D | K9K430 |

Tiida II

| | | | | |
|---------|----|---------|---|--------|
| 1.5 dCi | 78 | 09/07 → | D | K9K |
| | 78 | 09/07 → | D | K9K728 |

84007 350984007000

RENAULT
Clio II

| | | | | | |
|---------|----|---------|---|-------------------|--|
| 1.5 dCi | 74 | 01/04 → | D | K9K712 | |
| | 47 | 06/05 → | D | K9K740 | |
| | 50 | 08/04 → | D | K9K700, K9K714 | |
| | 62 | 02/07 → | D | K9K718 | |

Clio III, Grandtour

| | | | | | |
|---------|----|---------|---|-------------------|--|
| 1.5 dCi | 47 | 06/05 → | D | K9K752 | |
| | 48 | 02/10 → | D | K9K752 | |
| | 60 | 11/07 → | D | K9K750 | |
| | 50 | 02/08 → | D | K9K714, K9K768 | |
| | 63 | 02/08 → | D | K9K766 | |
| | 76 | 02/08 → | D | K9K772 | |
| | 78 | 02/08 → | D | K9K764, K9K774 | |

Fluence

| | | | | | |
|---------|----|---------|---|--------|--|
| 1.5 dCi | 63 | 02/10 → | D | K9K830 | |
| | 78 | 02/10 → | D | K9K832 | |

Grand Scénic III

| | | | | | |
|---------|----|---------|---|--------|--|
| 1.5 dCi | 63 | 04/09 → | D | K9K830 | |
| | 78 | 02/09 → | D | K9K832 | |

Kangoo I, Van

| | | | | | |
|---------|----|---------------|---|------------------------------|-----------|
| 1.5 dCi | 42 | 07/03 → | D | K9K704 | 04-2004 → |
| | 45 | 04/05 → 06/10 | D | K9K700, K9K702 | |
| | 62 | 06/05 → | D | K9K718 | |
| | 42 | 12/02 → | D | K9K704 | 04-2004 → |
| | 48 | 12/01 → | D | K9K700, K9K702, K9K704 | 04-2004 → |
| | 48 | 12/01 → | D | K9K700, K9K704 | 04-2004 → |
| | 60 | 07/02 → | D | K9K702, K9K710 | 04-2004 → |

Kangoo II, Be Bop, Van

| | | | | | |
|-------------|----|---------|---|------------------------------|--|
| 1.5 dCi | 50 | 02/08 → | D | K9K800 | |
| | 50 | 02/08 → | D | K9K714, K9K800, K9K840 | |
| | 63 | 02/08 → | D | K9K802 | |
| | 76 | 02/08 → | D | K9K804, K9K806 | |
| | 76 | 02/09 → | D | K9K806 | |
| 1.5 dCi 110 | 80 | 09/10 → | D | K9K804 | |

84007 350984007000

RENAULT
Kangoo II, Be Bop, Van

| | | | | | |
|------------|----|---------|---|-------------------|--|
| 1.5 dCi 85 | 63 | 02/08 → | D | K9K800, K9K802 | |
|------------|----|---------|---|-------------------|--|

Laguna III, Grantour, Coupé

| | | | | | |
|---------|----|---------|---|--------|--|
| 1.5 dCi | 81 | 10/07 → | D | K9K780 | |
|---------|----|---------|---|--------|--|

Logan I, Station Wagon

| | | | | | |
|---------|----|---------|---|--------|--|
| 1.5 dCi | 50 | 04/07 → | D | K9K792 | |
|---------|----|---------|---|--------|--|

Logan I, Station Wagon, Express

| | | | | | |
|---------|----|---------|---|--------|--|
| 1.5 dCi | 50 | 04/07 → | D | K9K792 | |
|---------|----|---------|---|--------|--|

Megane II, Station Wagon, Coupé-Cabrio

| | | | | | |
|---------|----|---------------|---|-------------------|-----------|
| 1.5 dCi | 60 | 08/03 → 05/06 | D | K9K722 | 04-2004 → |
| | 60 | 09/03 → | D | K9K722 | 03-2004 → |
| | 63 | 05/05 → 02/08 | D | K9K724 | |
| | 74 | 10/03 → 03/06 | D | K9K728, K9K729 | |
| | 76 | 01/07 → 02/08 | D | K9K734 | |
| | 78 | 05/05 → | D | K9K732 | |
| | 78 | 05/05 → 06/08 | D | K9K732, K9K734 | |
| | 60 | 11/02 → 02/08 | D | K9K722 | 04-2004 → |
| | 76 | 01/07 → 07/09 | D | K9K728 | |
| | 76 | 01/07 → 06/09 | D | K9K734 | |
| | 78 | 03/06 → 06/08 | D | K9K732 | |
| | 78 | 05/05 → 06/08 | D | K9K732, K9K734 | |

Megane III, Station Wagon, Coupé, CC

| | | | | | |
|---------|----|---------|---|-------------------|--|
| 1.5 dCi | 63 | 12/09 → | D | K9K830 | |
| | 78 | 02/09 → | D | K9K832 | |
| | 63 | 11/08 → | D | K9K830 | |
| | 78 | 02/09 → | D | K9K832 | |
| | 78 | 02/09 → | D | K9K836, K9K846 | |

Modus

| | | | | | |
|------------|----|---------|---|--------|--|
| 1.5 dCi | 48 | 12/04 → | D | K9K752 | |
| | 60 | 09/04 → | D | K9K750 | |
| | 76 | 05/07 → | D | K9K772 | |
| | 78 | 05/05 → | D | K9K764 | |
| 1.5 dCi 75 | 55 | 10/10 → | D | K9K770 | |
| 1.5 dCi 90 | 65 | 10/10 → | D | K9K750 | |

Scénic II

| | | | | | |
|---------|----|---------|---|-------------------|-----------|
| 1.5 dCi | 60 | 06/03 → | D | K9K722 | 04-2004 → |
| | 63 | 05/05 → | D | K9K724 | |
| | 74 | 11/03 → | D | K9K728, K9K729 | 04-2004 → |
| | 76 | 01/07 → | D | K9K734 | |
| | 78 | 05/05 → | D | K9K732 | |

84007
350984007000

RENAULT
Scénic III

| | | | | |
|---------|----|---------|---|--------|
| 1.5 dCi | 63 | 04/09 → | D | K9K830 |
| | 78 | 02/09 → | D | K9K832 |

Thalia I

| | | | | |
|---------|----|---------|---|-------------------|
| 1.5 dCi | 47 | 06/05 → | D | K9K740 |
| | 50 | 02/03 → | D | K9K700, K9K714 |
| | 60 | 06/01 → | D | K9K702 |

Thalia II

| | | | | |
|---------|----|---------|---|--------|
| 1.5 dCi | 47 | 09/08 → | D | K9K740 |
| | 48 | 01/09 → | D | K9K700 |
| | 62 | 09/08 → | D | K9K718 |

Twingo II

| | | | | |
|---------|----|---------|---|--------|
| 1.5 dCi | 47 | 03/07 → | D | K9K740 |
| | 62 | 04/08 → | D | K9K718 |

SUZUKI
Jimny

| | | | | |
|-----------------|----|---------|---|--------|
| 1.5 DDiS 4x4 | 63 | 08/05 → | D | K9K266 |
|-----------------|----|---------|---|--------|

84008
350984008000

FLANGIA

| | |
|---------------------|-------|
| Posizione Attacco | 36.5 |
| Diametro Centraggio | Ø26 |
| Diametro Girante | Ø52.5 |
| N° Alette Girante | 6 |
| Posizione Girante | 26.8 |

ALFA ROMEO
Mito

| | | | | |
|-------------|----|---------|---|-----------|
| 0.9 | 74 | 12/13 → | B | 199B6.000 |
| 0.9 TwinAir | 63 | 07/11 → | B | 312A2.000 |
| | 77 | 04/13 → | B | 199B6.000 |

CHRYSLER
Ypsilon

| | | | | |
|-------------|----|---------|---|-----------|
| 0.9 Twinair | 63 | 05/11 → | B | 312A2.000 |
|-------------|----|---------|---|-----------|

84008
350984008000

FIAT
500 II, 500C

| | | | | |
|---------|---------|---------|-----------|-------------------------|
| 0.9 | 59 | 12/13 → | B | 312A5.000 |
| | 63 | 07/10 → | B | 312A2.000 |
| | 77 | 10/13 → | B | 199B6.000 |
| | 44 | 12/13 → | B | 312A4.000, 312A6.000 |
| 48 | 09/12 → | B | 312A4.000 | |
| 1.2 LPG | 51 | 12/10 → | | 169A4.000 |

500L

| | | | | |
|----------------------|----|---------|---|-----------|
| 0.9 | 77 | 09/12 → | B | 199B6.000 |
| 0.9 Natural Power | 63 | 03/13 → | | 312A2.000 |

Panda III, Van

| | | | | |
|----------------------|---------|---------|-----------|-------------------------|
| 0.9 | 57 | 02/12 → | B | 312A2.000, 312A7.000 |
| | 59 | 12/13 → | B | 312A5.000 |
| | 63 | 02/12 → | B | 312A2.000 |
| | 44 | 12/13 → | B | 312A4.000, 312A6.000 |
| 48 | 02/12 → | B | 312A4.000 | |
| 0.9 4x4 | 63 | 09/12 → | B | 312A2.000 |
| | 66 | 06/14 → | B | 312A7.000 |
| 0.9 Natural Power | 59 | 01/15 → | | 312A2.000 |
| | 63 | 07/12 → | | 312A2.000 |

Punto III, Van

| | | | | |
|----------------------|----|---------|----|-----------|
| 0.9 | 74 | 12/13 → | B | 199B6.000 |
| | 77 | 07/13 → | B | 199B6.000 |
| 0.9 Bifuel | 63 | 03/12 → | BF | 312A2.000 |
| 0.9 Twinair Turbo | 63 | 03/12 → | B | 312A2.000 |

LANCIA
Ypsilon II

| | | | | |
|-------------|----|---------|---|-------------------------|
| 0.9 CNG | 63 | 05/11 → | | 312A2.000 |
| 0.9 Twinair | 59 | 12/13 → | B | 312A2.000, 312A5.000 |
| | 63 | 05/11 → | B | 312A2.000 |

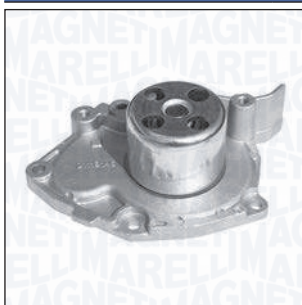
84009
350984009000

PULEGGIA

| | |
|-------------------|-------|
| Diametro Puleggia | Ø54 |
| Altezza Puleggia | 37 |
| Posizione Attacco | 48.5 |
| Diametro Girante | Ø70.3 |
| N° Alette Girante | 10 |
| Posizione Girante | 7.8 |

KW

MITSUBISHI
Carisma

| | | | | |
|----------|----|---------------|---|------|
| 1.9 DI-D | 85 | 09/00 → 06/06 | D | F9Q2 |
| | 75 | 09/00 → 06/06 | D | F9Q1 |

Space Star

| | | | | |
|----------|----|---------------|---|------|
| 1.9 DI-D | 85 | 10/02 → 12/04 | D | F9Q2 |
| | 75 | 02/01 → 12/04 | D | F9Q1 |

NISSAN
Interstar

| | | | | |
|--------|----|---------|---|--------|
| dCi 80 | 60 | 07/02 → | D | F9Q772 |
|--------|----|---------|---|--------|

Primastar

| | | | | |
|---------|----|---------|---|-------------------|
| 2.0 | 88 | 02/03 → | B | F4R720 |
| | 88 | 03/01 → | B | F4R720, F4R722 |
| dCi 100 | 74 | 03/01 → | D | F9Q760 |
| dCi 80 | 60 | 03/01 → | D | F9Q762 |

OPEL
Movano A

| | | | | |
|---------|----|---------|---|-------------------|
| 1.9 DTI | 60 | 10/01 → | D | F9Q772, F9Q774 |
|---------|----|---------|---|-------------------|

Vivaro

| | | | | |
|------------|----|---------|---|-------------------|
| 1.9 DI | 60 | 08/01 → | D | F9Q762 |
| | 60 | 08/01 → | D | F9Q762, F9Q774 |
| 1.9 DTI | 74 | 08/01 → | D | F9Q760 |
| 2.0 16V | 88 | 08/01 → | B | F4R720 |
| 2.0 ECOTEC | 86 | 08/06 → | B | F4R820 |

RENAULT
Avantime

| | | | | |
|---------------|-----|---------------|---|-------------------|
| 2.0 16V Turbo | 120 | 11/01 → 05/03 | B | F4R760, F4R761 |
|---------------|-----|---------------|---|-------------------|

Clio III, Grandtour

| | | | | |
|---------------|-----|---------|---|--------|
| 2.0 16V Sport | 145 | 02/06 → | B | F4R830 |
| | 148 | 09/08 → | B | F4R830 |

Duster

| | | | | |
|-----|----|---------|---|-------------------|
| 2.0 | 98 | 02/12 → | B | F4R403, F4R405 |
|-----|----|---------|---|-------------------|

84009
350984009000

KW

RENAULT
Espace IV

| | | | | |
|-----------|-----|---------------|---|---|
| 1.9 dCi | 85 | 04/03 → 02/05 | D | F9Q820 |
| | 88 | 11/02 → | D | F9Q680, F9Q820, F9Q826 |
| 2.0 | 98 | 11/02 → 02/05 | B | F4R790 |
| | 100 | 11/02 → | B | F4R792 |
| 2.0 | 125 | 04/05 → | B | F4R796, F4R797, F4R896, F4R897 |
| | | | | |
| 2.0 Turbo | 120 | 11/02 → | B | F4R794, F4R795, F4R796, F4R797 |

Grand Scénic II

| | | | | |
|-----|-----|---------|---|-------------------|
| 2.0 | 99 | 04/04 → | B | F4R770, F4R771 |
| | 120 | 04/04 → | B | F4R776 |

Laguna I, Grantour

| | | | | |
|---------|-----|---------------|---|--------|
| 1.9 dCi | 79 | 09/99 → 03/01 | D | F9Q718 |
| 2.0 16V | 103 | 09/99 → 03/01 | B | F4R780 |

Laguna II, Grantour

| | | | | |
|---------|----|---------|---|--|
| 1.8 16V | 86 | 03/01 → | B | F4P770 |
| | 89 | 03/01 → | B | F4P770, F4P774 |
| 1.8 16V | 85 | 03/01 → | B | F4P770, F4P771, F4P773, F4P774, F4P775 |
| | | | | |
| 1.8 16V | 85 | 03/01 → | B | F4P770, F4P771, F4P774, F4P775 |
| | | | | |
| 1.8 16V | 86 | 03/01 → | B | F4P770, F4P774 |
| | | | | |
| 1.8 16V | 88 | 03/01 → | B | F4P770, F4P773 |
| | | | | |
| 1.8 16V | 89 | 03/01 → | B | F4P770, F4P772 |
| | | | | |

84009
350984009000

KW

RENAULT
Laguna II, Grantour

| | | | | |
|---------------|-----|---------------|---|---|
| 1.9 dCi | 79 | 03/01 → | D | F9Q718, F9Q754 |
| | 85 | 09/05 → | D | F9Q750 |
| | 92 | 09/05 → | D | F9Q750 |
| | 74 | 10/01 → | D | F9Q752 |
| | 74 | 10/01 → | D | F9Q754 |
| | 77 | 06/01 → | D | F9Q752 |
| | 85 | 08/05 → 09/07 | D | F9Q758, F9Q759 |
| 2.0 16V | 88 | 03/01 → | D | F9Q650, F9Q670, F9Q674, F9Q750 |
| | 88 | 03/01 → | D | F9Q670, F9Q674, F9Q750 |
| 2.0 16V | 98 | 08/02 → | B | F4R714 |
| | 98 | 10/04 → 09/07 | B | F4R714, F4R715 |
| | 125 | 01/05 → | B | F4R784, F4R786, F4R787 |
| | 150 | 01/05 → | B | F4R886, F4R887 |
| | 99 | 08/02 → | B | F4R712, F4R713, F4R714, F4R715 |
| 2.0 16V IDE | 103 | 04/01 → | B | F5R700, F5R701 |
| 2.0 16V Turbo | 120 | 01/03 → | B | F4R764, F4R765, F4R786, F4R787 |

Laguna III, Grantour, Coupé

| | | | | |
|---------------|-----|---------|---|--------------------|
| 2.0 16V Turbo | 125 | 10/07 → | B | F4R811 |
| | 125 | 09/08 → | B | F4R811, F4Rt811 |
| 2.0 GT | 150 | 09/08 → | B | F4R800 |

Master II

| | | | | |
|------------|----|---------|---|-------------------|
| 1.9 dCi 80 | 60 | 11/01 → | D | F9Q772, F9Q774 |
|------------|----|---------|---|-------------------|

84009
350984009000

KW

RENAULT
Megane I, Coach, Cabrio, Scénic, Station Wagon

| | | | | |
|---------|----|---------------|---|------------------------------|
| 1.9 dCi | 75 | 02/01 → 08/03 | D | F9Q732, F9Q733 |
| | 75 | 02/01 → 08/03 | D | F9Q732, F9Q733, F9Q738 |

Megane II, Station Wagon, Coupé-Cabrio

| | | | | |
|-------------------|-----|---------------|---|--------------------|
| 2.0 | 99 | 09/03 → 12/09 | B | F4R770, F4R771 |
| | 102 | 09/03 → 02/07 | B | F4R770 |
| | 169 | 08/06 → 02/08 | B | F4R774 |
| 2.0 16V | 99 | 11/02 → 02/08 | B | F4R770 |
| 2.0 16V Turbo | 120 | 05/04 → 02/08 | B | F4R776 |
| 2.0 Renault Sport | 165 | 05/04 → 10/09 | B | F4R774, F4Rt774 |

Megane III, Station Wagon, Coupé, CC

| | | | | |
|----------|-----|---------|---|-------------------|
| 2.0 R.S. | 195 | 11/08 → | B | F4R874 |
| 2.0 TCe | 140 | 06/12 → | B | F4R872 |
| | 162 | 09/12 → | B | F4R874 |
| | 132 | 11/08 → | B | F4R870 |
| | 132 | 06/10 → | B | F4R870, F4R872 |
| | 184 | 05/09 → | B | F4R874 |

Scénic II

| | | | | |
|---------------|-----|---------|---|-------------------|
| 2.0 | 99 | 06/03 → | B | F4R770, F4R771 |
| 2.0 16V Turbo | 120 | 05/04 → | B | F4R776 |

Trafic II

| | | | | |
|-------------|----|---------------|---|-------------------|
| 1.9 dCi | 59 | 04/01 → 07/03 | D | F9Q762 |
| | 75 | 03/01 → | D | F9Q760 |
| 1.9 dCi 100 | 74 | 03/01 → | D | F9Q760 |
| 1.9 dCi 80 | 60 | 03/01 → | D | F9Q760, F9Q762 |
| | 60 | 03/01 → | D | F9Q762 |
| 2.0 | 88 | 03/01 → | B | F4R720 |
| | 88 | 03/01 → | B | F4R720, F4R722 |
| 2.0 16V | 86 | 08/06 → | B | F4R820 |

Vel Satis

| | | | | |
|----------------|-----|---------|---|-------------------|
| 2.0 16 V Turbo | 125 | 04/04 → | B | F4R766, F4R767 |
| | 120 | 06/02 → | B | F4R762, F4R763 |

84009 **350984009000**

RENAULT
Vel Satis

| | | | | |
|-----------|-----|---------|---|--------|
| 2.0 Turbo | 108 | 04/05 → | B | F4R867 |
|-----------|-----|---------|---|--------|

VAUXHALL
MOVANO

| | | | | |
|---------|----|---------------|---|--------|
| 1.9 DTI | 59 | 09/00 → 10/01 | D | F9Q770 |
| | 60 | 10/01 → 05/10 | D | F9Q774 |

VIVARO

| | | | | |
|---------|----|---------------|---|--------|
| 1.9 DI | 59 | 08/01 → 12/06 | D | F9Q762 |
| 1.9 DTI | 74 | 08/01 → 12/06 | D | F9Q760 |

VOLVO
S 40 I

| | | | | |
|--------|----|---------------|---|---------|
| 1.9 DI | 75 | 07/00 → 12/03 | D | D4192T4 |
| | 85 | 07/00 → 12/03 | D | D4192T3 |

V 40 I

| | | | | |
|--------|----|---------------|---|---------|
| 1.9 DI | 75 | 07/00 → 06/04 | D | D4192T4 |
| | 85 | 07/00 → 06/04 | D | D4192T3 |

84010 **350984010000**

PULEGGIA

| | |
|----------------------------|--------|
| Diametro Puleggia | Ø56.21 |
| Numero Denti/Gole Puleggia | 19 |
| Altezza Puleggia | 33.5 |
| Posizione Attacco | 52.2 |
| Diametro Girante | Ø59.8 |
| N° Alette Girante | 8 |
| Posizione Girante | 48.2 |

AUDI
A2

| | | | | |
|---------|----|---------------|---|----------|
| 1.2 TDI | 45 | 03/01 → 08/05 | D | ANY |
| 1.4 TDI | 55 | 02/00 → 08/05 | D | AMF, BHC |
| | 66 | 11/03 → 08/05 | D | ATL |

A3 II, Sportback, Cabriolet

| | | | | |
|---------|----|---------------|---|---------------|
| 1.9 TDI | 77 | 05/03 → 05/10 | D | BKC, BLS, BXE |
| | 77 | 04/08 → 10/09 | D | BLS |

FORD
Galaxy I

| | | | | |
|---------|-----|---------------|---|-----|
| 1.9 TDI | 96 | 02/03 → 05/06 | D | ASZ |
| | 110 | 05/05 → 05/06 | D | BTB |

84010 **350984010000**

SEAT
Alhambra I

| | | | | |
|-------------|----|---------------|---|-----|
| 1.9 TDI | 96 | 11/02 → 11/08 | D | ASZ |
| 1.9 Tdi 4x4 | 96 | 06/05 → 11/08 | D | ASZ |

Altea, Altea XL

| | | | | |
|---------|----|---------|---|--------------------|
| 1.9 TDI | 66 | 08/09 → | D | BXF |
| | 77 | 04/04 → | D | BJB, BKC, BLS, BXE |
| | 77 | 10/06 → | D | BKC, BLS, BXE |

Arosa

| | | | | |
|---------|----|---------------|---|-----|
| 1.4 TDI | 55 | 01/00 → 06/04 | D | AMF |
|---------|----|---------------|---|-----|

Cordoba III, Vario

| | | | | |
|---------|----|---------------|---|---------------|
| 1.4 TDI | 51 | 05/05 → 11/09 | D | BNM |
| | 55 | 10/02 → 12/05 | D | AMF |
| | 59 | 06/05 → 11/09 | D | BMS, BNV |
| 1.9 TDI | 74 | 09/02 → 11/09 | D | ATD, AXR, BMT |
| | 96 | 10/02 → 11/09 | D | ASZ, BLT |

Ibiza IV

| | | | | |
|---------|----|---------------|---|---------------|
| 1.4 TDI | 51 | 05/05 → 11/09 | D | BNM |
| | 55 | 05/02 → 12/05 | D | AMF |
| | 59 | 06/05 → 11/09 | D | BMS, BNV |
| 1.9 TDI | 74 | 02/02 → 11/09 | D | ATD, AXR, BMT |
| | 96 | 02/02 → 11/09 | D | ASZ, BLT |

Ibiza V

| | | | | |
|---------|----|---------------|---|-----|
| 1.4 TDI | 59 | 07/08 → 06/10 | D | BMS |
| 1.9 TDI | 66 | 07/08 → 06/10 | D | BXJ |
| | 77 | 03/08 → 06/10 | D | BLS |

Leon II

| | | | | |
|---------|----|---------------|---|---------------|
| 1.9 TDI | 66 | 06/07 → 12/10 | D | BXF |
| | 77 | 07/05 → 12/10 | D | BKC, BLS, BXE |
| | 81 | 10/05 → 12/12 | D | ASV |

Toledo III

| | | | | |
|---------|----|---------------|---|--------------------|
| 1.9 TDI | 77 | 10/04 → 05/09 | D | BJB, BKC, BLS, BXE |
|---------|----|---------------|---|--------------------|

SKODA
Fabia I, Station Wagon, Van

| | | | | |
|------------|----|---------------|---|----------|
| 1.4 TDI | 51 | 10/05 → 03/08 | D | BNM |
| | 55 | 04/03 → 03/08 | D | AMF |
| | 59 | 10/05 → 03/08 | D | BNV |
| 1.9 TDI | 74 | 01/00 → 03/08 | D | ATD, AXR |
| 1.9 TDI RS | 96 | 06/03 → 03/08 | D | ASZ, BLT |

84010

NEW

350984010000



KW



SKODA

Fabia II, Station Wagon, Van

| | | | | |
|---------|----|---------------|---|----------|
| 1.4 TDI | 51 | 02/07 → 03/10 | D | BNM |
| | 59 | 01/07 → 03/10 | D | BMS, BNV |
| 1.9 TDI | 77 | 04/07 → 03/10 | D | BLS, BSW |

Octavia II, Station Wagon

| | | | | |
|-------------|----|---------------|---|--------------------|
| 1.9 TDI | 77 | 06/04 → 12/10 | D | BJB, BKC, BLS, BXE |
| 1.9 TDI 4x4 | 77 | 11/04 → 12/10 | D | BKC, BLS, BXE |

Roomster, Van

| | | | | |
|---------|----|---------------|---|----------|
| 1.4 TDI | 51 | 07/06 → 03/10 | D | BNM |
| | 59 | 09/06 → 03/10 | D | BMS, BNV |
| 1.9 TDI | 77 | 09/06 → 03/10 | D | BLS, BSW |

Superb II, Station Wagon

| | | | | |
|---------|----|---------------|---|----------|
| 1.9 TDI | 77 | 03/08 → 11/10 | D | BLS, BXE |
|---------|----|---------------|---|----------|

VOLKSWAGEN

Caddy III

| | | | | |
|-----------------|----|---------------|---|----------|
| 1.9 TDI | 55 | 09/05 → 08/10 | D | BSU |
| | 77 | 04/04 → 08/10 | D | BJB, BLS |
| 1.9 TDI 4motion | 77 | 11/08 → 08/10 | D | BLS |
| 2.0 SDI | 51 | 03/04 → 08/10 | D | BDJ, BST |

Crafter 30-35, 30-50

| | | | | |
|---------|----|---------------|---|-----------|
| 2.5 TDI | 65 | 04/06 → 07/11 | D | BJJ, CEBA |
|---------|----|---------------|---|-----------|

Fox I

| | | | | |
|---------|----|---------|---|-----|
| 1.4 TDI | 51 | 04/05 → | D | BNM |
|---------|----|---------|---|-----|

Golf V, Plus, Variant

| | | | | |
|-----------------|----|---------------|---|---------------|
| 1.9 TDI | 66 | 05/05 → 12/08 | D | BRU, BXF, BXJ |
| | 77 | 01/05 → 01/09 | D | BKC, BLS, BXE |
| | 77 | 06/07 → 07/09 | D | BLS, BXE |
| 1.9 TDI 4motion | 77 | 08/04 → 11/08 | D | BKC, BLS, BXE |
| | 77 | 01/08 → 07/09 | D | BLS |
| 2.0 SDI | 55 | 01/04 → 11/08 | D | BDK |

Jetta III

| | | | | |
|---------|----|---------------|---|---------------|
| 1.9 TDI | 77 | 08/05 → 10/10 | D | BKC, BLS, BXE |
|---------|----|---------------|---|---------------|

Lupo I

| | | | | |
|------------|----|---------------|---|----------|
| 1.2 TDI 3L | 45 | 07/99 → 07/05 | D | ANY, AYZ |
| 1.4 TDI | 55 | 01/99 → 07/05 | D | AMF |

84010

NEW

350984010000



KW



VOLKSWAGEN

Multivan V

| | | | | |
|---------|----|---------------|---|-----|
| 1.9 TDI | 62 | 01/06 → 11/09 | D | BRR |
| | 63 | 04/03 → 11/09 | D | AXC |
| | 75 | 06/06 → 11/09 | D | BRS |
| | 77 | 04/03 → 11/09 | D | AXB |

New Beetle, Cabrio

| | | | | |
|---------|----|---------------|---|----------|
| 1.9 TDI | 74 | 02/01 → 09/10 | D | ATD, BEW |
| | 77 | 07/05 → 09/10 | D | BSW |

Passat VI, Variant, CC

| | | | | |
|---------|----|---------------|---|---------------|
| 1.9 TDI | 77 | 03/05 → 11/08 | D | BKC, BLS, BXE |
|---------|----|---------------|---|---------------|

Polo IV (6N2)

| | | | | |
|---------|----|---------------|---|-----|
| 1.4 TDI | 55 | 10/99 → 09/01 | D | AMF |
| | 66 | 01/00 → 10/00 | D | ATL |

Polo V (9N)

| | | | | |
|---------|----|---------------|---|---------------|
| 1.4 TDI | 51 | 04/05 → 11/09 | D | BNM, BWB |
| | 55 | 10/01 → 06/05 | D | AMF, BAY |
| | 55 | 07/03 → | D | BAY |
| | 59 | 04/05 → 11/09 | D | BMS, BNV |
| 1.9 TDi | 74 | 09/02 → | D | ATD |
| | 74 | 10/01 → 11/09 | D | ATD, AXR, BMT |
| | 96 | 11/03 → 11/09 | D | ASZ, BLT |

Sharan I

| | | | | |
|---------|-----|---------------|---|-----|
| 1.9 TDI | 96 | 11/02 → 03/10 | D | ASZ |
| | 110 | 06/05 → 03/10 | D | BTB |

Touran I

| | | | | |
|---------|----|---------------|---|---------------|
| 1.9 TDI | 66 | 11/04 → 05/10 | D | BRU, BXF, BXJ |
| | 74 | 02/03 → 05/04 | D | AVQ |
| | 77 | 08/03 → 05/10 | D | BKC, BLS, BXE |

Transporter V

| | | | | |
|---------|----|---------------|---|-----|
| 1.9 TDI | 62 | 01/06 → 11/09 | D | BRR |
| | 63 | 04/03 → 11/09 | D | AXC |
| | 75 | 06/06 → 11/09 | D | BRS |
| | 77 | 04/03 → 11/09 | D | AXB |

84011
NEW
350984011000

PULEGGIA

| | |
|----------------------------|------|
| Diametro Puleggia | Ø56 |
| Numero Denti/Gole Puleggia | 19 |
| Altezza Puleggia | 33.5 |
| Posizione Attacco | 52.2 |
| Diametro Girante | Ø64 |
| N° Alette Girante | 8 |
| Posizione Girante | 47.5 |

KW

AUDI
A3 I

| | | | | |
|-----------------|----|---------------|---|----------|
| 1.9 TDI | 74 | 10/00 → 05/03 | D | ATD, AXR |
| | 96 | 08/00 → 05/03 | D | ASZ |
| 1.9 TDI quattro | 96 | 08/00 → 05/03 | D | ASZ |

A3 II, Sportback, Cabriolet

| | | | | |
|-----------------|-----|---------------|---|-----------------------|
| 2.0 TDI | 100 | 05/03 → 08/12 | D | AZV, CBAA, CFFA |
| | 100 | 04/08 → 05/13 | D | CBAA, CFFA |
| | 103 | 06/05 → 06/08 | D | BMM |
| | 103 | 04/08 → 05/13 | D | CBAB, CFFB |
| | 120 | 06/06 → 06/08 | D | BUY |
| 2.0 TDI 16V | 103 | 05/03 → 08/12 | D | BKD, CBAB, CFFB, CLJA |
| | 103 | 08/04 → 08/12 | D | BKD, CBAB, CFFB |
| 2.0 TDI quattro | 100 | 05/03 → 06/08 | D | AZV |
| | 103 | 01/06 → 06/08 | D | BMM |
| | 125 | 03/06 → 08/12 | D | BMN, CBBB, CFGB |

A4 I, Avant

| | | | | |
|-----------------|----|---------------|---|----------|
| 1.9 TDI | 85 | 03/00 → 11/00 | D | AJM |
| 1.9 TDI quattro | 85 | 03/00 → 11/00 | D | AJM, ATJ |

A4 II, Avant, Cabriolet

| | | | | |
|-----------------|-----|---------------|---|----------|
| 1.9 TDI | 74 | 05/01 → 12/04 | D | AVB |
| | 85 | 06/04 → 12/04 | D | BKE |
| | 96 | 11/00 → 12/04 | D | AVF, AWX |
| 1.9 TDI quattro | 96 | 11/01 → 12/04 | D | AVF |
| 2.0 TDI | 100 | 01/06 → 03/09 | D | BRC |
| | 103 | 01/06 → 03/09 | D | BPW |

84011
NEW
350984011000

KW

AUDI
A4 III, Avant

| | | | | |
|-----------------|-----|---------------|---|----------|
| 1.9 TDI | 85 | 11/04 → 06/08 | D | BKE, BRB |
| 2.0 TDI | 89 | 09/05 → 09/06 | D | BVG |
| | 93 | 11/05 → 11/06 | D | BVF |
| | 100 | 11/04 → 06/08 | D | BNA, BRF |
| | 103 | 11/04 → 06/08 | D | BPW |
| | 120 | 06/06 → 06/08 | D | BVA |
| 2.0 TDI 16V | 103 | 11/04 → 06/08 | D | BLB, BRE |
| | 103 | 01/06 → 06/08 | D | BPW |
| 2.0 TDI quattro | 120 | 06/06 → 06/08 | D | BVA |
| | 125 | 06/06 → 06/08 | D | BRD |

A4 IV, Avant, Allroad

| | | | | |
|-----------------|-----|---------------|---|------------------------|
| 2.0 TDI | 88 | 06/08 → 12/15 | D | CAGC, CJCC |
| | 100 | 11/07 → 12/15 | D | CAGB, CJCB, CSUB |
| | 105 | 11/07 → 12/15 | D | CAGA, CJCA, CMEA, CMFA |
| | 120 | 08/08 → 12/15 | D | CAHB, CGLD, CNHC |
| | 125 | 01/08 → 03/12 | D | CAHA |
| 2.0 TDI quattro | 100 | 09/09 → | D | CAGB, CJCB, CSUB |
| | 105 | 11/08 → 12/15 | D | CAGA, CJCA |
| | 120 | 04/09 → | D | CAHB, CGLD, CNHC |
| | 125 | 01/08 → 03/12 | D | CAHA |

A5, Sportback, Cabriolet

| | | | | |
|-----------------|-----|---------|---|-------------------------|
| 2.0 TDI | 100 | 09/09 → | D | CAGB, CJCB |
| | 105 | 09/09 → | D | CAGA, C10CA, CMEA, CMFA |
| | 120 | 08/08 → | D | CAHB, CGLD |
| | 125 | 08/08 → | D | CAHA |
| 2.0 TDI quattro | 125 | 08/08 → | D | CAHA |

A6 II, Avant

| | | | | |
|---------|----|---------------|---|----------|
| 1.9 TDI | 85 | 07/00 → 01/05 | D | AJM |
| | 96 | 08/01 → 01/05 | D | AVF, AWX |

A6 III, Avant, Allroad

| | | | | |
|---------|-----|---------------|---|----------------|
| 2.0 TDI | 89 | 09/05 → 06/06 | D | BVG |
| | 100 | 07/04 → 03/11 | D | BNA, BRF, CAGB |
| | 103 | 07/04 → 10/08 | D | BLB, BRE |
| | 120 | 04/09 → 03/11 | D | CAHB |
| | 125 | 11/08 → 03/11 | D | CAHA |

84011

NEW

350984011000



AUDI

Q5

| | | | | | |
|-----------------|-----|---------|---|------------------------|----------|
| 2.0 TDI quattro | 100 | 08/09 → | D | CAGB, CJCB, CSUB | M: 20598 |
| | 105 | 08/09 → | D | CAGA, CJCA | M: 20597 |
| | 120 | 11/08 → | D | CAHB, CGLA, CGLD, CNHC | M: 20864 |
| | 125 | 11/08 → | D | CAHA, CGLB, CMGA | M: 20602 |

TT II, Roadster

| | | | | | |
|-----------------|-----|---------------|---|------------|--|
| 2.0 TDI quattro | 125 | 06/08 → 06/14 | D | CBBB, CFCB | |
|-----------------|-----|---------------|---|------------|--|

CHRYSLER

Sebring III, Cabrio

| | | | | | |
|---------|-----|---------------|---|-----|--|
| 2.0 CRD | 103 | 07/07 → 12/10 | D | ECD | |
|---------|-----|---------------|---|-----|--|

DODGE

Avenger

| | | | | | |
|---------|-----|---------|---|-----|--|
| 2.0 CRD | 103 | 06/07 → | D | ECD | |
|---------|-----|---------|---|-----|--|

Caliber

| | | | | | |
|---------|-----|---------|---|----------|--|
| 2.0 CRD | 103 | 06/06 → | D | ECD, ECE | |
|---------|-----|---------|---|----------|--|

Journey

| | | | | | |
|---------|-----|---------|---|-----|--|
| 2.0 CRD | 103 | 06/08 → | D | ECE | |
|---------|-----|---------|---|-----|--|

FORD

Galaxy I

| | | | | | |
|---------|----|---------------|---|--------------|--|
| 1.9 TDI | 66 | 03/95 → 05/06 | D | 1Z, AHU, ANU | |
| | 85 | 04/00 → 05/06 | D | AUY | |

JEEP

Compass

| | | | | | |
|---------|-----|---------|---|----------|--|
| 2.0 CRD | 103 | 08/06 → | D | ECD, ECE | |
|---------|-----|---------|---|----------|--|

| | | | | | |
|-------------|-----|---------|---|-----|--|
| 2.0 CRD 4x4 | 103 | 09/06 → | D | ECE | |
|-------------|-----|---------|---|-----|--|

Patriot

| | | | | | |
|---------|-----|---------|---|----------|--|
| 2.0 CRD | 103 | 02/07 → | D | ECD, ECE | |
|---------|-----|---------|---|----------|--|

| | | | | | |
|-------------|-----|---------|---|----------|--|
| 2.0 CRD 4x4 | 103 | 02/07 → | D | ECD, ECE | |
|-------------|-----|---------|---|----------|--|

MITSUBISHI

Grandis II

| | | | | | |
|----------|-----|---------|---|-----|--|
| 2.0 DI-D | 100 | 09/05 → | D | BSY | |
| | 103 | 02/07 → | D | BWC | |

Lancer VIII, Station Wagon, Sportback

| | | | | | |
|----------|-----|---------|---|----------|--|
| 2.0 DI-D | 103 | 06/08 → | D | BKD, BWC | |
|----------|-----|---------|---|----------|--|

Outlander II, Van

| | | | | | |
|----------|-----|---------------|---|-----|--|
| 2.0 DI-D | 103 | 02/07 → 11/12 | D | BSY | |
|----------|-----|---------------|---|-----|--|

84011

NEW

350984011000



SEAT

Alhambra I

| | | | | | |
|-----------------|-----|---------------|---|--------------|--|
| 1.9 TDI | 66 | 04/96 → 03/10 | D | 1Z, AHU, ANU | |
| | 85 | 06/00 → 03/10 | D | AUY, BVK | |
| | 110 | 05/05 → 05/07 | D | BTB | |
| 1.9 TDI 4motion | 85 | 06/00 → 03/10 | D | AUY, BVK | |
| 2.0 TDI | 103 | 11/05 → 03/10 | D | BRT | |

Altea, Altea XL

| | | | | | |
|-------------|-----|---------------|---|-----------------|--|
| 2.0 TDI | 100 | 03/04 → 05/09 | D | AZV | |
| | 103 | 11/05 → | D | BMM | |
| | 125 | 03/06 → | D | BMN, CEGA | |
| 2.0 TDI 16V | 103 | 03/04 → | D | BKD, CFHC | |
| 2.0 TDI 4x4 | 103 | 06/07 → | D | BMM | |
| | 125 | 06/07 → | D | BMN, CEGA, CFJA | |

Exeo, Exeo ST

| | | | | | |
|---------|-----|---------|---|------------|--|
| 2.0 TDI | 88 | 12/08 → | D | CAGC, CJCC | |
| | 105 | 12/08 → | D | CAGA, CJCA | |
| | 125 | 02/09 → | D | CAHA, CGLB | |

Ibiza IV

| | | | | | |
|-----------------|-----|---------------|---|----------|--|
| 1.9 TDI Cupra R | 118 | 03/04 → 02/08 | D | BPX, BUK | |
|-----------------|-----|---------------|---|----------|--|

Leon I

| | | | | | |
|----------------|-----|---------------|---|-----|--|
| 1.9 TDI | 74 | 10/05 → 06/06 | D | AXR | |
| | 96 | 05/03 → 06/06 | D | ASZ | |
| | 110 | 09/00 → 06/06 | D | ARL | |
| 1.9 TDI Syncro | 110 | 05/02 → 06/06 | D | ARL | |

Leon II

| | | | | | |
|-------------|-----|---------------|---|-----------------|--|
| 2.0 TDI | 100 | 07/05 → 05/10 | D | AZV | |
| | 103 | 10/05 → 10/10 | D | BMM | |
| | 125 | 05/06 → 12/12 | D | BMN, CEGA, CFJA | |
| 2.0 TDI 16V | 103 | 07/05 → 12/12 | D | BKD, CFHC, CLCB | |

Toledo II

| | | | | | |
|---------|-----|---------------|---|-----|--|
| 1.9 TDI | 96 | 05/03 → 05/06 | D | ASZ | |
| | 110 | 10/00 → 07/04 | D | ARL | |

Toledo III

| | | | | | |
|-------------|-----|---------------|---|-----------|--|
| 2.0 TDI | 100 | 09/04 → 05/09 | D | AZV | |
| | 103 | 11/05 → 05/09 | D | BMM | |
| | 125 | 01/06 → 05/09 | D | BMN, CEGA | |
| 2.0 TDI 16V | 103 | 04/04 → 05/09 | D | BKD | |

84011 NEW **350984011000**

SKODA
Octavia I, Station Wagon

| | | | | |
|-------------|----|---------------|---|-----|
| 1.9 TDI | 74 | 10/05 → 12/10 | D | AXR |
| | 96 | 09/02 → 09/04 | D | ASZ |
| 1.9 TDI 4x4 | 74 | 09/00 → 01/06 | D | ATD |

Octavia II, Station Wagon

| | | | | |
|-------------|-----|---------------|---|-----------------|
| 2.0 TDI | 100 | 02/04 → 05/10 | D | AZV |
| | 103 | 11/05 → 05/10 | D | BMM |
| 2.0 TDI 16V | 100 | 02/04 → 05/10 | D | AZV |
| | 103 | 02/04 → 04/13 | D | BKD, CFHC, CLCB |
| 2.0 TDI 4x4 | 103 | 07/06 → 05/10 | D | BMM |
| 2.0 TDI RS | 125 | 04/06 → 02/13 | D | BMN, CEGA |

Roomster, Van

| | | | | |
|---------|----|---------------|---|-----|
| 1.9 TDI | 74 | 03/06 → 05/06 | D | AXR |
|---------|----|---------------|---|-----|

Superb I

| | | | | |
|---------|-----|---------------|---|----------|
| 1.9 TDI | 74 | 08/02 → 10/05 | D | AVB |
| | 77 | 10/05 → 05/07 | D | BSV |
| | 85 | 01/07 → 03/08 | D | BPZ |
| | 96 | 12/01 → 03/08 | D | AVF, AWX |
| 2.0 TDI | 103 | 10/05 → 03/08 | D | BSS |

Superb II, Station Wagon

| | | | | |
|-------------|-----|---------------|---|-----------------|
| 2.0 TDI | 103 | 03/08 → 05/10 | D | BMP |
| | 125 | 07/08 → 05/15 | D | CBBB, CFGB |
| 2.0 TDI 16V | 103 | 01/09 → 05/15 | D | BKD, CFFB, CLJA |
| 2.0 TDI 4x4 | 125 | 09/08 → 05/15 | D | CBBB, CFGB |

Yeti

| | | | | |
|-------------|-----|---------|---|------------------|
| 2.0 TDI 4x4 | 103 | 05/09 → | D | CBDB, CFHC, CLCB |
| | 125 | 11/09 → | D | CEGA, CFJA |

VOLKSWAGEN
Beetle II (Maggiolino)

| | | | | |
|---------|-----|---------|---|------------|
| 2.0 TDI | 103 | 04/12 → | D | CFFB, CJAA |
|---------|-----|---------|---|------------|

Bora, Station Wagon

| | | | | |
|-----------------|-----|---------------|---|----------|
| 1.9 TDI | 74 | 09/00 → 05/05 | D | ATD, AXR |
| | 85 | 12/98 → 01/02 | D | AJM, AUJ |
| | 96 | 11/00 → 05/05 | D | ASZ |
| | 110 | 05/00 → 05/05 | D | ARL |
| 1.9 TDI 4motion | 74 | 09/00 → 05/05 | D | ATD |
| | 85 | 02/99 → 06/01 | D | AJM, AUJ |
| | 96 | 11/00 → 05/05 | D | ASZ |
| | 110 | 05/00 → 05/05 | D | ARL |

Caddy III

| | | | | |
|---------|-----|---------------|---|-----|
| 2.0 TDI | 103 | 09/07 → 08/10 | D | BMM |
|---------|-----|---------------|---|-----|

84011 NEW **350984011000**

VOLKSWAGEN
Eos

| | | | | |
|-------------|-----|---------------|---|------------|
| 2.0 TDI | 103 | 06/06 → 05/08 | D | BMM |
| 2.0 TDI 16V | 103 | 05/08 → | D | CBAB, CFFB |

Golf IV, Variant, Cabrio

| | | | | |
|-----------------|-----|---------------|---|----------|
| 1.9 TDI | 74 | 09/00 → 06/05 | D | ATD, AXR |
| | 85 | 12/98 → 06/01 | D | AJM, AUJ |
| | 96 | 11/00 → 06/05 | D | ASZ |
| | 110 | 05/00 → 06/05 | D | ARL |
| 1.9 TDI 4motion | 74 | 09/00 → 06/05 | D | ATD |
| | 85 | 05/99 → 06/01 | D | AJM |
| | 85 | 09/99 → 06/01 | D | AJM, AUJ |
| | 96 | 11/00 → 06/05 | D | ASZ |
| | 110 | 02/00 → 06/05 | D | ARL |

Golf V, Plus, Variant

| | | | | |
|---------------------|-----|---------------|---|-----------------|
| 2.0 TDI | 81 | 01/09 → 12/13 | D | CBDC, CLCA |
| | 96 | 05/05 → 05/07 | D | BEE |
| | 100 | 06/07 → 07/09 | D | AZV |
| | 100 | 10/03 → 11/08 | D | AZV, CBDA |
| | 100 | 05/05 → 12/13 | D | AZV, CBDA, CFHB |
| 2.0 TDI 16V | 103 | 12/05 → 05/11 | D | BMM |
| | 125 | 11/05 → 11/08 | D | BMN |
| | 103 | 10/03 → 11/08 | D | BKD |
| 2.0 TDI 16V | 103 | 06/07 → 07/09 | D | BKD, CBDB |
| | 103 | 01/05 → 12/13 | D | BKD, CBDB, CFHC |
| 2.0 TDI 16V 4motion | 103 | 08/04 → 11/08 | D | BKD |
| 2.0 TDI 4motion | 100 | 06/07 → 07/09 | D | AZV |
| | 103 | 08/04 → 11/08 | D | BMM |

Golf VI, Variant, Cabrio

| | | | | |
|-----------------|-----|---------------|---|------------------------|
| 2.0 TDI | 81 | 10/08 → 11/12 | D | CBDC, CLCA |
| | 100 | 10/08 → 11/12 | D | CBAA, CFFA |
| | 100 | 07/09 → 07/13 | D | CBDA, CFHB |
| | 103 | 10/08 → 05/13 | D | CBAB, CFFB, CJAA |
| | 125 | 04/09 → 11/12 | D | CBBB, CFGB |
| 2.0 TDI 16V | 103 | 07/09 → 07/13 | D | CBDB, CFHC, CJAA, CLCB |
| 2.0 TDI 4motion | 103 | 05/09 → 11/12 | D | CBAB, CFFB |

84011 **NEW** 350984011000



VOLKSWAGEN

Jetta III

| | | | | |
|-------------|-----|---------------|---|-----------------------|
| 2.0 TDI | 100 | 09/05 → 10/10 | D | AZV, CBDA |
| | 103 | 10/05 → 10/10 | D | BMM |
| | 125 | 10/06 → 10/10 | D | BMN, CEGA |
| 2.0 TDI 16V | 103 | 08/05 → 10/10 | D | BKD, CBDB, CBEA, CJAA |

New Beetle, Cabrio

| | | | | |
|---------|----|---------------|---|-----|
| 1.9 TDI | 74 | 06/03 → 09/10 | D | AXR |
| | 77 | 07/05 → 09/10 | D | BSW |

Passat IV, Variant

| | | | | |
|-----------------|----|---------------|---|----------|
| 1.9 TDI | 74 | 02/00 → 11/00 | D | AVB |
| | 85 | 08/98 → 11/00 | D | AJM, ATJ |
| 1.9 TDI 4motion | 85 | 08/99 → 11/00 | D | ATJ |

Passat V, Variant

| | | | | |
|-----------------|-----|---------------|---|----------|
| 1.9 TDI | 74 | 11/00 → 05/05 | D | AVB |
| | 96 | 11/00 → 05/05 | D | AVF, AWX |
| | 96 | 11/00 → 05/05 | D | AVF, AWX |
| 1.9 TDI 4motion | 96 | 11/00 → 05/05 | D | AVF |
| | 96 | 11/00 → 05/05 | D | AVF |
| 2.0 TDI | 100 | 12/03 → 05/05 | D | BGW, BHW |

Passat VI, Variant, CC

| | | | | |
|---------------------|-----|---------------|---|------------------|
| 2.0 BlueTDI | 105 | 01/09 → 11/10 | D | CBAC |
| 2.0 TDI | 81 | 11/08 → 07/10 | D | CBDC |
| | 88 | 11/05 → 05/07 | D | BWV |
| | 90 | 08/05 → 07/06 | D | BVE |
| | 100 | 03/05 → 11/10 | D | BMA, CBAA |
| | 100 | 06/08 → 05/11 | D | CBAA, CFFA |
| | 103 | 03/05 → 05/09 | D | BMP |
| | 103 | 06/08 → 01/12 | D | CBAB, CFFB |
| | 120 | 08/05 → 05/09 | D | BUZ |
| | 125 | 08/05 → 07/10 | D | BMR, CBBB |
| | 125 | 06/08 → 01/12 | D | CBBB, CFGB, CLLA |
| 2.0 TDI 16V | 103 | 03/05 → 07/10 | D | BKP, CBAB |
| 2.0 TDI 16V 4motion | 103 | 03/05 → 08/10 | D | BKP, CBAB |
| 2.0 TDI 4motion | 103 | 03/05 → 05/09 | D | BMP |
| | 103 | 08/09 → 01/12 | D | CBAB, CFFB |
| | 125 | 05/09 → 07/10 | D | CBBB |
| | 125 | 11/09 → 01/12 | D | CBBB, CFGB |

Scirocco III

| | | | | |
|---------|-----|---------|---|------------|
| 2.0 TDI | 103 | 08/08 → | D | CBDB, CFHC |
| | 125 | 05/09 → | D | CBBB, CFGB |

84011 **NEW** 350984011000



VOLKSWAGEN

Sharan I

| | | | | |
|-----------------|-----|---------------|---|--------------|
| 1.9 TDI | 66 | 09/95 → 03/10 | D | 1Z, AHU, ANU |
| | 85 | 04/00 → 03/10 | D | AUY, BVK |
| 1.9 TDI 4motion | 85 | 04/00 → 03/10 | D | AUY, BVK |
| 2.0 TDI | 100 | 11/05 → 03/10 | D | BVH |
| | 103 | 11/05 → 03/10 | D | BRT |

Tiguan I

| | | | | |
|-----------------|-----|---------------|---|------------------|
| 2.0 TDI | 103 | 03/08 → | D | CBAB, CFFB |
| | 100 | 11/07 → | D | CBAA, CFFA |
| 2.0 TDI 4motion | 103 | 09/07 → | D | CBAB, CFFB, CLJA |
| | 120 | 02/08 → 08/09 | D | CBBA |
| | 125 | 09/07 → | D | CBBB, CFGB |

Touran I

| | | | | |
|-------------|-----|---------------|---|-----------|
| 2.0 TDI | 100 | 02/03 → 05/10 | D | AZV |
| | 103 | 12/05 → 05/10 | D | BMM |
| | 125 | 12/05 → 05/10 | D | BMN, CFJA |
| 2.0 TDI 16V | 103 | 08/03 → 05/10 | D | BKD |

84012 **NEW** 350984012000



SMART

Cabrio

| | | | | |
|---------|----|---------------|---|-----------------------|
| 0.6 | 40 | 03/00 → 01/04 | B | M160.920, M160E6ALB03 |
| | 45 | 01/01 → 01/04 | B | M160.920, M160E6ALB05 |
| | 52 | 06/02 → 01/04 | B | M160.920 |
| 0.7 | 45 | 01/03 → 01/04 | B | M160.910 |
| | 55 | 01/03 → 01/04 | B | M160.910 |
| 0.8 CDI | 30 | 03/01 → 01/04 | D | OM660.940, OM660DE8LA |

84012
NEW
350984012000

KW

SMART
City-Coupé

| | | | | |
|---------|----|---------------|---|--------------------------|
| 0.6 | 33 | 07/98 → 01/04 | B | M160.920, M160E6ALB04 |
| | 40 | 07/98 → 01/04 | B | M160.920, M160E6ALB03 |
| | 45 | 01/01 → 01/04 | B | M160.920, M160E6ALB05 |
| | 52 | 06/02 → 01/04 | B | M160.920 |
| 0.7 | 37 | 01/03 → 01/04 | B | M160.910 |
| | 45 | 01/03 → 01/04 | B | M160.910 |
| | 55 | 01/03 → 01/04 | B | M160.910 |
| 0.8 CDI | 30 | 11/99 → 01/04 | D | OM660.940, OM660DE8LA |

CrossBlade

| | | | | |
|-----|----|---------------|---|----------|
| 0.6 | 52 | 06/02 → 12/03 | B | M160.920 |
|-----|----|---------------|---|----------|

ForTwo I Coupé, Cabrio

| | | | | |
|---------|----|---------------|---|--------------------------|
| 0.7 | 37 | 01/04 → 01/07 | B | M160.910 |
| | 45 | 01/04 → 01/07 | B | M160.910 |
| | 55 | 01/04 → 01/07 | B | M160.910 |
| 0.8 CDI | 30 | 01/04 → 01/07 | D | OM660.940 |
| | 30 | 01/04 → 01/07 | D | OM660.940, OM660DE8LA |
| | 33 | 01/07 → | D | OM660.950 |
| | 40 | 08/09 → | D | OM660.951 |

Roadster

| | | | | |
|------------|----|---------------|---|----------|
| 0.7 | 45 | 04/03 → 11/05 | B | M160.921 |
| | 45 | 06/03 → 11/05 | B | M160.922 |
| | 60 | 04/03 → 11/05 | B | M160.921 |
| | 60 | 04/03 → 11/05 | B | M160.922 |
| 0.7 Brabus | 74 | 12/03 → 11/05 | B | M160.923 |

84013
NEW
350984013000

FLANGIA

| | |
|---------------------|-------|
| Posizione Attacco | 69.80 |
| Diametro Centraggio | Ø28 |
| Diametro Girante | Ø59.4 |
| N° Alette Girante | 6 |
| Posizione Girante | 15.40 |

KW

MINI
Mini I (R50,R52, R53)

| | | | | |
|-------------------|-----|---------------|---|---------|
| Cooper S | 120 | 03/02 → 09/06 | B | W11B16A |
| John Cooper Works | 155 | 07/04 → 11/07 | B | W11B16A |
| S Works | 147 | 11/03 → 06/05 | B | W11B16A |
| Works | 155 | 11/03 → 09/06 | B | W11B16A |

84014
NEW
350984014000

PULEGGIA

| | |
|-------------------|-------|
| Diametro Puleggia | Ø65 |
| Altezza Puleggia | 26.5 |
| Posizione Attacco | 44.9 |
| Diametro Girante | Ø84.4 |
| N° Alette Girante | 7 |
| Posizione Girante | 35.6 |

KW

CHEVROLET
Captiva

| | | | | |
|-----------|-----|---------|---|-----------------|
| 2.0 D | 93 | 10/06 → | D | Z20S |
| | 110 | 09/07 → | D | Z20DMH, Z20S |
| 2.0 D 4WD | 93 | 10/06 → | D | Z20S |
| | 110 | 10/06 → | D | Z20DMH, Z20S |

Cruze II, Hatchback, Station Wagon

| | | | | |
|---------|-----|---------|---|------------------|
| 2.0 CDI | 90 | 05/09 → | D | Z20S1 |
| | 92 | 05/09 → | D | Z20S1 |
| | 110 | 05/09 → | D | Z20DMH, Z20S1 |

Epica

| | | | | |
|-------|-----|---------|---|------|
| 2.0 D | 110 | 01/07 → | D | Z20S |
|-------|-----|---------|---|------|

Lacetti

| | | | | |
|-------|----|---------|---|-------|
| 2.0 D | 89 | 01/07 → | D | Z20DM |
|-------|----|---------|---|-------|

84014 NEW **350984014000**



CHEVROLET

Nubira, Station Wagon

| | | | | | |
|-------|----|---------|---|----------------|--|
| 2.0 D | 89 | 01/07 → | D | Z20DM, Z20S | |
| | 89 | 01/05 → | D | Z20S | |

DAEWOO

Tosca

| | | | | | |
|----------|-----|---------|---|--------|--|
| 2.0 TDCi | 110 | 02/06 → | D | Z20DMH | |
|----------|-----|---------|---|--------|--|

OPEL

Antara

| | | | | | |
|-----------------|-----|---------|---|-----------------|--|
| 2.0 CDTI | 93 | 03/07 → | D | Z20DM, Z20S | |
| | 110 | 05/06 → | D | Z20DMH, Z20S | |
| 2.0 CDTI 4x4 | 110 | 05/06 → | D | Z20DMH, Z20S | |

VAUXHALL

ANTARA

| | | | | | |
|----------|-----|---------------|---|--------|--|
| 2.0 CDTI | 110 | 08/06 → 04/15 | D | Z20DMH | |
|----------|-----|---------------|---|--------|--|

84015 NEW **350984015000**



FLANGIA

| | |
|-------------------------|------|
| Numero Fori Flangia | 4 |
| Dimensione Fori Flangia | M6×1 |
| Posizione Attacco | 52 |
| Diametro Centraggio | Ø24 |
| Diametro Girante | Ø57 |
| N° Alette Girante | 6 |
| Posizione Girante | 28.2 |



HYUNDAI

Elantra II

| | | | | | |
|----------|-----|---------------|---|------|-----------|
| 1.6 CVVT | 90 | 06/06 → 06/11 | B | G4FC | |
| 2.0 CVVT | 105 | 06/06 → 06/11 | B | G4GC | → 10-2006 |
| 1.6 | 97 | 06/11 → | B | G4FG | |

i10 I

| | | | | | |
|-----|----|---------|---|------|--|
| 1.2 | 57 | 11/08 → | B | G4LA | |
|-----|----|---------|---|------|--|

i20 I

| | | | | | |
|-----|----|---------|---|------|--|
| 1.4 | 74 | 09/08 → | B | G4FA | |
| 1.6 | 93 | 09/08 → | B | G4FC | |

i30 I, Station Wagon

| | | | | | |
|-----|----|---------------|---|------|--|
| 1.4 | 77 | 10/07 → 11/11 | B | G4FA | |
| | 80 | 10/07 → 11/11 | B | G4FA | |

84015 NEW **350984015000**



HYUNDAI

i30 I, Station Wagon

| | | | | | |
|-----|----|---------------|---|------|--|
| 1.6 | 85 | 10/07 → 11/11 | B | G4FC | |
| | 90 | 10/07 → 11/11 | B | G4FC | |
| | 93 | 02/08 → 11/11 | B | G4FC | |

i30 II, Station Wagon, Coupé

| | | | | | |
|-----------|-----|---------|---|------|-----------|
| 1.4 | 74 | 01/15 → | B | G4LC | → 12-2014 |
| | 73 | 12/11 → | B | G4FA | → 12-2014 |
| | 73 | 06/12 → | B | G4FA | |
| 1.6 | 88 | 01/12 → | B | G4FC | |
| | 88 | 06/12 → | B | G4FG | |
| | 95 | 06/12 → | B | G4FG | |
| 1.6 GDI | 95 | 12/11 → | B | G4FG | |
| | 99 | 12/11 → | B | G4FD | |
| 1.6 T-GDI | 137 | 01/15 → | B | G4FJ | |

i40

| | | | | | |
|---------|----|---------|---|------|--|
| 1.6 GDI | 99 | 03/12 → | B | G4FD | |
|---------|----|---------|---|------|--|

ix 20

| | | | | | |
|-----|----|---------|---|------|--|
| 1.4 | 66 | 11/10 → | B | G4FA | |
| 1.6 | 92 | 11/10 → | B | G4FC | |

ix 35

| | | | | | |
|-----|----|---------|---|------|--|
| 1.6 | 99 | 11/10 → | B | G4FD | |
|-----|----|---------|---|------|--|

Tucson III

| | | | | | |
|------------------------------------|-----|---------|---|------|--|
| 1.6 GDi | 97 | 06/15 → | B | G4FD | |
| 1.6 T-GDI | 130 | 06/15 → | B | G4FJ | |
| 1.6 T-GDI Trazione integrale | 130 | 06/15 → | B | G4FJ | |

Velostar

| | | | | | |
|-----------|-----|---------|---|------|--|
| 1.6 GDI | 103 | 03/11 → | B | G4FD | |
| 1.6 T-GDI | 137 | 10/12 → | B | G4FJ | |

KIA

Carens III

| | | | | | |
|----------|----|---------|---|------|--|
| 1.6 CVVT | 93 | 10/10 → | B | G4FC | |
| | 97 | 08/09 → | B | G4FC | |

Carens IV

| | | | | | |
|---------|----|---------|---|------|--|
| 1.6 GDi | 99 | 03/13 → | B | G4FD | |
|---------|----|---------|---|------|--|

Cee'd I, Station Wagon

| | | | | | |
|----------|----|---------------|---|--------|--|
| 1.4 | 77 | 12/06 → 12/12 | B | G4FA | |
| | 80 | 12/06 → 12/12 | B | G4FA | |
| 1.4 CVVT | 66 | 06/10 → 12/12 | B | G4FA-L | |
| 1.6 | 85 | 09/07 → 12/12 | B | G4FC | |
| | 90 | 12/06 → 12/12 | B | G4FC | |
| | 93 | 02/08 → 12/12 | B | G4FC | |
| 1.6 CVVT | 92 | 10/10 → 12/12 | B | G4FC | |

84015
NEW
350984015000

KW

KIA
Cee'd II, Station Wagon

| | | | | |
|---------|-----|---------|---|--------|
| 1.4 CVT | 66 | 05/12 → | B | G4FA-L |
| | 73 | 05/12 → | B | G4FA |
| 1.6 CVT | 92 | 05/12 → | B | G4FC |
| 1.6 GDI | 99 | 05/12 → | B | G4FD |
| 1.6 GT | 150 | 06/13 → | B | G4FJ |

Cerato I

| | | | | |
|-----|----|---------|---|------|
| 1.6 | 90 | 05/06 → | B | G4FC |
|-----|----|---------|---|------|

Cerato II

| | | | | |
|---------|----|---------|---|------|
| 1.6 | 93 | 01/10 → | B | G4FC |
| 1.6 CVT | 91 | 02/09 → | B | G4FC |
| 1.6 MPi | 96 | 06/13 → | B | G4FC |

Pro Cee'd I

| | | | | |
|---------|----|---------------|---|--------|
| 1.4 | 77 | 02/08 → 09/12 | B | G4FA |
| | 80 | 02/08 → 09/12 | B | G4FA |
| 1.4 CVT | 66 | 06/10 → 09/12 | B | G4FA-L |
| 1.6 | 90 | 02/08 → 09/12 | B | G4FC |
| | 93 | 02/08 → 09/12 | B | G4FC |
| 1.6 CVT | 92 | 10/10 → 02/13 | B | G4FC |

Pro Cee'd II

| | | | | |
|---------|-----|---------|---|------|
| 1.4 CVT | 73 | 03/13 → | B | G4FA |
| 1.6 GDI | 99 | 03/13 → | B | G4FD |
| 1.6 GT | 150 | 06/13 → | B | G4FJ |

Rio III

| | | | | |
|---------|----|---------|---|------|
| 1.4 CVT | 79 | 09/11 → | B | G4FA |
| | 80 | 09/11 → | B | G4FA |
| 1.6 CVT | 90 | 06/12 → | B | G4FC |

Soul I

| | | | | |
|---------|-----|---------------|---|------|
| 1.6 | 91 | 09/09 → 12/10 | B | G4FG |
| 1.6 CVT | 77 | 02/09 → | B | G4FC |
| | 93 | 02/09 → | B | G4FC |
| | 95 | 03/12 → | B | G4FC |
| 1.6 GDI | 103 | 06/11 → | B | G4FD |

Soul II

| | | | | |
|---------|----|---------|---|------|
| 1.6 GDI | 97 | 02/14 → | B | G4FD |
|---------|----|---------|---|------|

Sportage III

| | | | | |
|-------------|-----|---------|---|------|
| 1.6 GDI | 97 | 09/15 → | B | G4FD |
| | 99 | 02/11 → | B | G4FD |
| | 130 | 09/15 → | B | G4FJ |
| 1.6 GDI 4WD | 130 | 09/15 → | B | G4FJ |

Venga

| | | | | |
|---------|----|---------|---|--------|
| 1.4 CVT | 66 | 02/10 → | B | G4FA-L |
| 1.6 CVT | 92 | 02/10 → | B | G4FC |

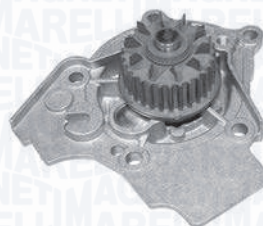
84016
NEW
350984016000

PULEGGIA

| | |
|----------------------------|------|
| Diametro Puleggia | Ø45 |
| Numero Denti/Gole Puleggia | 29 |
| Altezza Puleggia | 18.1 |
| Posizione Attacco | 32.8 |
| Diametro Girante | Ø61 |
| N° Alette Girante | 6 |
| Posizione Girante | 18.5 |

KW

AUDI
A3 II, Sportback, Cabriolet

| | | | | |
|------------------|-----|---------------|---|----------------|
| 1.8 TFSI | 118 | 11/06 → 08/12 | B | BYT, BZB, CDAA |
| | 118 | 04/08 → 05/13 | B | BZB, CDAA |
| 1.8 TFSI quattro | 118 | 07/08 → 08/12 | B | CDAA |
| 2.0 TFSI | 147 | 04/08 → 05/13 | B | CAWB, CCZA |

A4 IV, Avant, Allroad

| | | | | |
|--------------------------------|-----|---------------|---|------------------|
| 1.8 TFSI | 88 | 01/08 → 12/15 | B | CABA, CDHA |
| | 88 | 04/08 → 12/15 | B | CDHA |
| | 118 | 11/07 → 03/12 | B | CABB, CCUA, CDHB |
| 1.8 TFSI quattro | 118 | 09/08 → 03/12 | B | CDHB |
| 2.0 TFSI | 132 | 06/08 → 12/15 | B | CAEA, CDNB, CFKA |
| | 155 | 06/08 → 05/13 | B | CAEB, CDNC |
| 2.0 TFSI flexible fuel | 132 | 11/09 → 12/15 | | CFKA |
| 2.0 TFSI flexible fuel quattro | 132 | 11/09 → 12/15 | | CFKA |
| 2.0 TFSI quattro | 155 | 06/08 → 12/15 | B | CAEB, CDNC |
| | 155 | 06/08 → 12/15 | B | CAEB, CDNC, CPMA |
| | 155 | 04/09 → | B | CDNC, CPMA |
| | 162 | 05/13 → 12/15 | B | CAED, CPMB |
| | 162 | 05/13 → | B | CPMB |

A5, Sportback, Cabriolet

| | | | | |
|----------|-----|---------|---|----------------------|
| 1.8 TFSI | 118 | 05/09 → | B | CDHB |
| | 125 | 10/07 → | B | CABD, CJEB |
| 2.0 TFSI | 132 | 03/09 → | B | CAEA, CDNB |
| | 132 | 11/08 → | B | CDNB |
| | 155 | 03/09 → | B | CAEB, CDNC → 07-2011 |
| | 155 | 06/08 → | B | CDNC → 07-2011 |
| | 162 | 05/13 → | B | CAED |
| | 165 | 05/13 → | B | CNCD |

84016
NEW
350984016000

KW

AUDI
A5, Sportback, Cabriolet

| | | | | | |
|------------------|-----|---------|---|------------|-----------|
| 2.0 TFSI quattro | 155 | 06/08 → | B | CAEB, CDNC | → 07-2011 |
| | 155 | 09/09 → | B | CDNC | → 07-2011 |
| | 162 | 03/12 → | B | CAED, CPMB | |
| | 165 | 05/13 → | B | CNCD | |

A6 IV, Avant, Allroad

| | | | | | |
|-----------------|-----|---------------|---|------|--|
| 2.0 TFSI | 132 | 05/11 → | B | CDNB | |
| | 155 | 03/11 → 05/13 | B | CAEB | |
| 2.0 TFSI hybrid | 155 | 11/11 → | | CHJA | |

A8 III

| | | | | | |
|-----------------|-----|---------|--|------|--|
| 2.0 TFSI hybrid | 155 | 02/12 → | | CHJA | |
|-----------------|-----|---------|--|------|--|

Q3

| | | | | | |
|------------------|-----|---------|---|------|--|
| 2.0 TFSI quattro | 125 | 06/11 → | B | CCZC | |
| | 155 | 06/11 → | B | CPSA | |
| | 162 | 11/14 → | B | | |

Q5

| | | | | | |
|-------------------------|-----|---------|---|------------------|--|
| 2.0 TFSI hybrid quattro | 155 | 06/11 → | | CHJA | |
| 2.0 TFSI quattro | 132 | 08/09 → | B | CDNB, CNCB | |
| | 155 | 11/08 → | B | CAEB, CDNC, CPMA | |
| | 162 | 05/13 → | B | CPMB | |

TT II, Roadster

| | | | | | |
|------------------|-----|---------------|---|------------|--|
| 1.8 TFSI | 118 | 06/08 → 06/14 | B | CDA | |
| 2.0 TFSI | 155 | 05/10 → 06/14 | B | CESA | |
| 2.0 TFSI quattro | 155 | 05/10 → 06/14 | B | CESA, CETA | |

SEAT
Alhambra II

| | | | | | |
|---------|-----|---------|---|------|--|
| 2.0 TSI | 147 | 11/10 → | B | CCZA | |
|---------|-----|---------|---|------|--|

Altea, Altea XL

| | | | | | |
|--------------|-----|---------|---|----------------|---|
| 1.8 TFSI | 118 | 01/07 → | B | BYT, BZB, CDAA | → 05-2007, → T:5P7084000 |
| | 118 | 01/07 → | B | BYT, BZB, CDAA | 06-2007 →, → 05-2007, T → :5P7084001, → T:5P7084000 |
| 2.0 TFSI 4x4 | 155 | 05/09 → | B | CCZB | |

84016
NEW
350984016000

KW

SEAT
Exeo, Exeo ST

| | | | | | |
|----------|-----|---------|---|------|--|
| 1.8 TSI | 88 | 09/10 → | B | CDHA | |
| | 118 | 05/10 → | B | CDHB | |
| 2.0 TFSI | 155 | 05/10 → | B | CDND | |

Leon II

| | | | | | |
|-------------|-----|---------------|---|-----------|--|
| 1.8 TSI | 118 | 06/07 → 12/12 | B | BZB, CDAA | |
| 2.0 Cupra R | 195 | 09/09 → 12/12 | B | CDLA | |
| 2.0 TFSI | 155 | 06/09 → 12/12 | B | CCZB | |

Toledo III

| | | | | | |
|----------|-----|---------------|---|----------------|--|
| 1.8 TFSI | 118 | 01/07 → 05/09 | B | BYT, BZB, CDAA | |
|----------|-----|---------------|---|----------------|--|

SKODA
Octavia II, Station Wagon

| | | | | | |
|-------------|-----|---------------|---|-----------|--|
| 1.8 TSI | 112 | 03/09 → 06/13 | B | CDAB | |
| | 118 | 06/07 → 04/13 | B | BZB, CDAA | |
| 1.8 TSI 4x4 | 112 | 03/09 → 02/13 | B | CDAB | |
| | 118 | 11/08 → 02/13 | B | CDA | |

Superb II, Station Wagon

| | | | | | |
|-------------|-----|---------------|---|-----------|--|
| 1.8 TSI | 112 | 03/09 → 05/15 | B | CDAB | |
| | 118 | 03/08 → 05/15 | B | BZB, CDAA | |
| | 118 | 10/09 → 05/15 | B | CDA | |
| 1.8 TSI 4x4 | 112 | 03/09 → 05/15 | B | CDAB | |
| | 118 | 11/08 → 05/15 | B | CDA | |
| 2.0 TSI | 147 | 05/10 → 05/15 | B | CCZA | |

Yeti

| | | | | | |
|-------------|-----|---------|---|------|--|
| 1.8 TSI 4x4 | 112 | 11/09 → | B | CDAB | |
| | 118 | 05/09 → | B | CDA | |

VOLKSWAGEN
Amarok

| | | | | | |
|---------|-----|---------|---|------|--|
| 2.0 TSI | 118 | 12/10 → | B | CFPA | |
|---------|-----|---------|---|------|--|

Beetle II (Maggiolino)

| | | | | | |
|---------|-----|---------|---|------------------|--|
| 2.0 TSI | 147 | 04/11 → | B | CBFA, CCTA, CCZA | |
|---------|-----|---------|---|------------------|--|

CC

| | | | | | |
|---------|-----|---------|---|------|--|
| 1.8 TSI | 112 | 11/11 → | B | CDAB | |
| | 118 | 11/11 → | B | CDA | |
| 2.0 TSI | 155 | 11/11 → | B | CCZB | |

Eos

| | | | | | |
|---------|-----|---------|---|------|--|
| 2.0 TSI | 155 | 11/09 → | B | CCZB | |
|---------|-----|---------|---|------|--|

Golf VI, Variant, Cabrio

| | | | | | |
|---------|-----|---------------|---|------|--|
| 1.8 TSI | 118 | 06/09 → 01/11 | B | CDA | |
| 2.0 GTi | 155 | 04/09 → 11/12 | B | CCZB | |
| 2.0 TSI | 147 | 07/09 → 07/13 | B | CCZA | |

84016 **NEW** 350984016000

VOLKSWAGEN
Jetta IV

| | | | | |
|---------|-----|---------|---|------------------|
| 2.0 TSI | 147 | 12/10 → | B | CBFA, CCTA, CCZA |
|---------|-----|---------|---|------------------|

Multivan V

| | | | | |
|---------|-----|---------|---|------|
| 2.0 TSI | 110 | 07/12 → | B | CJKB |
| | 150 | 05/11 → | B | CJKA |

| | | | | |
|--------------------|-----|---------|---|------|
| 2.0 TSI 4motion | 150 | 07/11 → | B | CJKA |
|--------------------|-----|---------|---|------|

Passat VI, Variant, CC

| | | | | |
|---------|-----|---------------|---|------------|
| 1.8 TSI | 112 | 11/09 → 07/10 | B | CDAB, CGYA |
| | 118 | 05/07 → 07/10 | B | BZB, CDAA |

| | | | | |
|---------|-----|---------------|---|------|
| 2.0 FSI | 125 | 08/07 → 07/10 | B | CCTB |
| | 155 | 11/10 → 01/12 | B | CCZB |

Passat VII, Variant, CC, AllTrack

| | | | | |
|---------|-----|---------------|---|------|
| 1.8 TSI | 112 | 02/11 → 12/14 | B | CDAB |
| | 118 | 08/10 → 12/14 | B | CDAA |

| | | | | |
|---------|-----|---------------|---|------|
| 2.0 TSI | 155 | 11/10 → 12/14 | B | CCZB |
|---------|-----|---------------|---|------|

| | | | | |
|--------------------|-----|---------------|---|------|
| 2.0 TSI 4motion | 155 | 01/12 → 12/14 | B | CCZB |
|--------------------|-----|---------------|---|------|

Scirocco III

| | | | | |
|---------|-----|---------------|---|------|
| 2.0 TSI | 147 | 05/08 → 11/09 | B | CAWB |
| | 155 | 11/09 → | B | CCZB |

Sharan II

| | | | | |
|---------|-----|---------|---|------|
| 2.0 TSI | 147 | 12/10 → | B | CCZA |
|---------|-----|---------|---|------|

Tiguan I

| | | | | |
|---------------------|-----|---------|---|------------------|
| 2.0 TFSI 4motion | 125 | 09/07 → | B | CAWA, CCZC |
| | 147 | 09/07 → | B | CAWB, CCTA, CCZA |

| | | | | |
|--------------------|-----|---------|---|------|
| 2.0 TSI 4motion | 132 | 05/11 → | B | CCZD |
| | 155 | 05/11 → | B | CCZB |

Transporter V

| | | | | |
|---------|-----|---------|---|------|
| 2.0 TSI | 110 | 07/12 → | B | CJKB |
| | 150 | 05/11 → | B | CJKA |

| | | | | |
|--------------------|-----|---------|---|------|
| 2.0 TSI 4motion | 150 | 07/11 → | B | CJKA |
|--------------------|-----|---------|---|------|

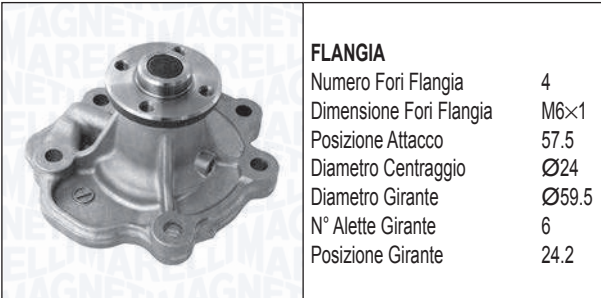
84017 **NEW** 350984017000

NISSAN
Pixo

| | | | | |
|-----|----|---------|---|------|
| 1.0 | 50 | 06/09 → | B | K10B |
|-----|----|---------|---|------|

OPEL
Agila B

| | | | | |
|-----|----|---------|---|------|
| 1.0 | 48 | 04/08 → | B | K10B |
| | 50 | 07/11 → | B | K10B |

| | | | | |
|---------|----|---------|--|------|
| 1.0 LPG | 48 | 01/10 → | | K10B |
|---------|----|---------|--|------|

| | | | | |
|-----|----|---------|---|------|
| 1.2 | 63 | 04/08 → | B | K12B |
| | 69 | 11/10 → | B | K12B |

| | | | | |
|---------|----|---------|--|------|
| 1.2 LPG | 63 | 04/08 → | | K12B |
|---------|----|---------|--|------|

SUZUKI
Alto V

| | | | | |
|-----|----|---------|---|------|
| 1.0 | 50 | 01/09 → | B | K10B |
|-----|----|---------|---|------|

Celerio

| | | | | |
|-----|----|---------|---|------|
| 1.0 | 50 | 03/14 → | B | K10B |
|-----|----|---------|---|------|

Splash

| | | | | |
|-----|----|---------|---|------|
| 1.0 | 48 | 01/08 → | B | K10B |
| | 50 | 06/11 → | B | K10B |

| | | | | |
|-----|----|---------|---|------|
| 1.2 | 63 | 01/08 → | B | K12B |
|-----|----|---------|---|------|

| | | | | |
|---------|----|---------|---|------|
| 1.2 VVT | 66 | 06/11 → | B | K12B |
| | 69 | 09/10 → | B | K12B |

Swift IV

| | | | | |
|-----|----|---------|---|------|
| 1.2 | 66 | 10/10 → | B | K12B |
| | 69 | 10/10 → | B | K12B |

| | | | | |
|---------|----|---------|---|------|
| 1.2 4x4 | 66 | 10/10 → | B | K12B |
| | 69 | 10/10 → | B | K12B |

84018
NEW
350984018000

FLANGIA

| | |
|-------------------------|-------|
| Numero Fori Flangia | 4 |
| Dimensione Fori Flangia | M6x1 |
| Posizione Attacco | 80.5 |
| Diametro Centraggio | Ø24 |
| Diametro Girante | Ø53.5 |
| N° Alette Girante | 7 |
| Posizione Girante | 6 |

KW

HYUNDAI
Atos, Atos Prime

| | | | | | |
|-----|----|---------|---|------|--|
| 1.1 | 43 | 06/03 → | B | G4HD | |
| | 46 | 03/04 → | B | G4HG | |

Getz

| | | | | | |
|-----|----|---------------|---|------|--|
| 1.1 | 46 | 09/02 → 09/05 | B | G4HD | |
|-----|----|---------------|---|------|--|

i10 I

| | | | | | |
|-----|----|---------|---|------|--|
| 1.1 | 48 | 12/07 → | B | G4HG | |
| | 49 | 01/08 → | B | G4HG | |
| | 51 | 04/11 → | B | G4HG | |

KIA
Picanto I

| | | | | | |
|-----|----|---------|---|------|--|
| 1.0 | 45 | 04/04 → | B | G4HE | |
| | 46 | 11/09 → | B | G4HE | |
| 1.1 | 48 | 04/04 → | B | G4HG | |

84019
NEW
350984019000

FLANGIA

| | |
|-----------------------------------|---------|
| Numero Fori Flangia | 3 |
| Numero Fori Flangia (Serie 2) | 3 |
| Dimensione Fori Flangia | M8x1.25 |
| Dimensione Fori Flangia (Serie 2) | 7x12.5 |
| Posizione Attacco | 80.3 |
| Diametro Centraggio | Ø28 |
| Diametro Girante | Ø67 |
| N° Alette Girante | 7 |
| Posizione Girante | 33.5 |

KW

CITROËN
C 5 III, Break

| | | | | | |
|-------------|-----|---------|---|-------|--|
| 3.0 HDi 240 | 177 | 04/09 → | D | DT20C | |
|-------------|-----|---------|---|-------|--|

C 6

| | | | | | |
|---------|-----|---------|---|-------|--|
| 3.0 HDi | 177 | 04/09 → | D | DT20C | |
|---------|-----|---------|---|-------|--|

PEUGEOT
407, Station Wagon, Coupé

| | | | | | |
|---------|-----|---------|---|-------|--|
| 3.0 HDi | 177 | 06/09 → | D | DT20C | |
|---------|-----|---------|---|-------|--|

84020
NEW
350984020000

PULEGGIA

| | |
|----------------------------|-------|
| Diametro Puleggia | Ø53 |
| Numero Denti/Gole Puleggia | 18 |
| Altezza Puleggia | 33.5 |
| Posizione Attacco | 41.4 |
| Diametro Girante | Ø74.5 |
| N° Alette Girante | 24 |
| Posizione Girante | 25.5 |

KW

CITROËN
C 4 I, Coupé, Picasso, Grand Picasso

| | | | | | |
|-------------|-----|---------|---|-----------------|--|
| 2.0 HDi 150 | 110 | 07/09 → | D | RHE (DW10CTED4) | |
|-------------|-----|---------|---|-----------------|--|

| | | | | | |
|-------------|-----|---------|---|-----------------|--|
| 2.0 HDi 165 | 120 | 09/10 → | D | RHH (DW10CTED4) | |
|-------------|-----|---------|---|-----------------|--|

C 4 II, Picasso, Grand Picasso

| | | | | | |
|-----------------|-----|---------|---|-----------------|--|
| 2.0 BlueHDi 150 | 110 | 11/09 → | D | RHE (DW10CTED4) | |
|-----------------|-----|---------|---|-----------------|--|

C 5 III, Break

| | | | | | |
|-------------------------|-----|---------|---|-------------------------------|--------------|
| 2.0 HDi 150/BlueHDi 150 | 110 | 04/09 → | D | AHR (DW10FD), RHE (DW10CTED4) | M: DW10CTED4 |
|-------------------------|-----|---------|---|-------------------------------|--------------|

| | | | | | |
|-------------|-----|---------|---|-----------------|--|
| 2.0 HDi 165 | 120 | 04/09 → | D | RHH (DW10CTED4) | |
|-------------|-----|---------|---|-----------------|--|

DS 4

| | | | | | |
|-------------|-----|---------------|---|-----------------|--|
| 2.0 HDi 135 | 100 | 09/11 → 07/15 | D | RHE (DW10CTED4) | |
|-------------|-----|---------------|---|-----------------|--|

| | | | | | |
|-------------|-----|---------------|---|-----------------|--|
| 2.0 HDi 165 | 120 | 04/11 → 07/15 | D | RHH (DW10CTED4) | |
|-------------|-----|---------------|---|-----------------|--|

DS 5

| | | | | | |
|-------------|-----|---------------|---|--------------|--|
| 2.0 HDi 135 | 100 | 11/11 → 07/15 | D | RHD (DW10CB) | |
|-------------|-----|---------------|---|--------------|--|

| | | | | | |
|-------------|-----|---------------|---|-----------------|--|
| 2.0 HDi 165 | 120 | 11/11 → 07/15 | D | RHH (DW10CTED4) | |
|-------------|-----|---------------|---|-----------------|--|

| | | | | | |
|-------------------------|-----|---------------|--|-----------------|--|
| 2.0 HDi 165 Hybrid4 4x4 | 120 | 12/11 → 07/15 | | RHC (DW10CTED4) | |
|-------------------------|-----|---------------|--|-----------------|--|

Jumpy III

| | | | | | |
|-------------|----|---------|---|--------------|--|
| 2.0 HDi 125 | 94 | 07/11 → | D | AHZ (DW10CD) | |
|-------------|----|---------|---|--------------|--|

| | | | | | |
|-------------|-----|---------|---|-----------------|--|
| 2.0 HDi 165 | 120 | 07/10 → | D | RHH (DW10CTED4) | |
|-------------|-----|---------|---|-----------------|--|

| | | | | | |
|------------|----|---------|---|--------------|--|
| 2.0 HDi 95 | 72 | 07/11 → | D | AHY (DW10CE) | |
|------------|----|---------|---|--------------|--|

84020 **NEW** 350984020000

DS
DS5

| | | | | | |
|-------------------------|-----|---------|--|--|--|
| 2.0 HDi 165 Hybrid4 4x4 | 120 | 04/15 → | | | |
|-------------------------|-----|---------|--|--|--|

FIAT
Scudo II

| | | | | | |
|----------------|-----|---------|---|-----------|--|
| 2.0 D Multijet | 94 | 04/11 → | D | RH02 | |
| | 120 | 07/10 → | D | RH02, RHH | |

| | | | | | |
|--------------------|----|---------|---|------|--|
| 2.0 D Multijet 4x4 | 94 | 04/11 → | D | RH02 | |
|--------------------|----|---------|---|------|--|

FORD
C-Max II, Van

| | | | | | |
|----------|-----|---------|---|------|--|
| 2.0 TDCi | 85 | 02/11 → | D | TYDA | |
| | 100 | 02/11 → | D | UKDB | |
| | 103 | 02/11 → | D | UFDB | |
| | 120 | 12/10 → | D | TXDB | |

Focus III, Station Wagon, Van

| | | | | | |
|----------|-----|---------|---|------|--|
| 2.0 TDCi | 85 | 07/10 → | D | TYDA | |
| | 100 | 07/10 → | D | UKDB | |
| | 103 | 07/10 → | D | UFDB | |
| | 120 | 07/10 → | D | TXDB | |

Galaxy II

| | | | | | |
|----------|-----|---------------|---|------|--|
| 2.0 TDCi | 120 | 03/10 → 06/15 | D | TXWA | |
|----------|-----|---------------|---|------|--|

Grand C-Max

| | | | | | |
|----------|-----|---------|---|------|--|
| 2.0 TDCi | 85 | 02/11 → | D | TYDA | |
| | 100 | 02/11 → | D | UKDB | |
| | 103 | 02/11 → | D | UFDB | |
| | 120 | 12/10 → | D | TXDB | |

Kuga I

| | | | | | |
|--------------|-----|---------------|---|------|--|
| 2.0 TDCi | 103 | 03/10 → 11/12 | D | UFDA | |
| 2.0 TDCi 4x4 | 103 | 03/10 → 11/12 | D | UFDA | |
| | 120 | 03/10 → 11/12 | D | TXDA | |

Kuga II, Van

| | | | | | |
|--------------|-----|---------|---|------------|--|
| 2.0 TDCi | 100 | 03/13 → | D | UKMA | |
| | 103 | 03/13 → | D | UFMA | |
| | 88 | 09/14 → | D | XRMA, XRMB | |
| | 110 | 09/14 → | D | T7MA, T7MB | |
| 2.0 TDCi 4x4 | 100 | 03/13 → | D | UKMA | |
| | 103 | 03/13 → | D | UFMA | |
| | 110 | 09/14 → | D | T7MA, T7MB | |
| | 120 | 03/13 → | D | TXDA, TXMA | |

Mondeo IV, Station Wagon

| | | | | | |
|----------|-----|---------------|---|------------|--|
| 2.0 TDCi | 120 | 03/10 → 09/14 | D | TXBA, TXBB | |
|----------|-----|---------------|---|------------|--|

S-Max

| | | | | | |
|----------|-----|---------|---|------|--|
| 2.0 TDCi | 120 | 03/10 → | D | TXWA | |
|----------|-----|---------|---|------|--|

84020 **NEW** 350984020000

PEUGEOT
308 I, Station Wagon, CC

| | | | | | |
|---------|-----|---------|---|-----------------|--|
| 2.0 HDi | 110 | 10/11 → | D | RHE (DW10CTED4) | |
| | 120 | 04/12 → | D | RHH (DW10CTED4) | |

508, Station Wagon

| | | | | | |
|---------|-----|---------|---|-----------------|--|
| 2.0 HDi | 103 | 11/10 → | D | RHF (DW10BTED4) | |
| | 120 | 11/10 → | D | RHH (DW10CTED4) | |

| | | | | | |
|---------------------|-----|---------|--|-----------------|--|
| 2.0 HDi Hybrid4 AWC | 120 | 11/10 → | | RHC (DW10CTED4) | |
| | 147 | 11/10 → | | | |

| | | | | | |
|--------------------|-----|---------|--|-----------------|--|
| 2.0 HDiRXH Hybrid4 | 120 | 11/10 → | | RHC (DW10CTED4) | |
| | 147 | 12/11 → | | RHC (DW10CTED4) | |

807

| | | | | | |
|---------|-----|---------|---|-----------------|--|
| 2.0 HDi | 120 | 06/09 → | D | RHH (DW10CTED4) | |
|---------|-----|---------|---|-----------------|--|

3008

| | | | | | |
|---------|-----|---------|---|-----------------|--|
| 2.0 HDi | 100 | 09/11 → | D | | |
| | 120 | 06/09 → | D | RHH (DW10CTED4) | |

| | | | | | |
|---------------------------|-----|---------|---|-------------------------------|--|
| 2.0 HDi 150 / BlueHDi 150 | 110 | 06/09 → | D | AHX (DW10FD), RHE (DW10CTED4) | |
|---------------------------|-----|---------|---|-------------------------------|--|

| | | | | | |
|-----------------|-----|---------|--|-----------------|--|
| 2.0 HDi Hybrid4 | 120 | 02/11 → | | RHC (DW10CTED4) | |
|-----------------|-----|---------|--|-----------------|--|

5008

| | | | | | |
|---------|-----|---------|---|-----------------|--|
| 2.0 HDi | 120 | 09/09 → | D | RHH (DW10CTED4) | |
|---------|-----|---------|---|-----------------|--|

| | | | | | |
|---------------------------|-----|---------|---|-------------------------------|--|
| 2.0 HDi 136 / BlueHDi 136 | 100 | 02/12 → | D | AHV (DW10FD), RHD (DW10CTED4) | |
|---------------------------|-----|---------|---|-------------------------------|--|

| | | | | | |
|---------------------------|-----|---------|---|-------------------------------|--|
| 2.0 HDi 150 / BlueHDi 150 | 110 | 06/09 → | D | AHX (DW10FD), RHE (DW10CTED4) | |
|---------------------------|-----|---------|---|-------------------------------|--|

84020
NEW
350984020000

KW

PEUGEOT
Expert II, Tepee

| | | | | | |
|--------------------|-----|---------|---|--------------------|--|
| 2.0 HDi 100 | 72 | 03/11 → | D | AHY (DW10CE) | |
| 2.0 HDi 120 4x4 | 88 | 01/07 → | D | RHK (DW10UTED4) | |
| 2.0 HDi 130 | 94 | 03/11 → | D | AHZ (DW10CD) | |
| 2.0 HDi 165 | 120 | 09/09 → | D | RHH (DW10CTED4) | |

RCZ

| | | | | | |
|---------|-----|---------|---|--------------------|--|
| 2.0 HDi | 120 | 03/10 → | D | RHH (DW10CTED4) | |
|---------|-----|---------|---|--------------------|--|

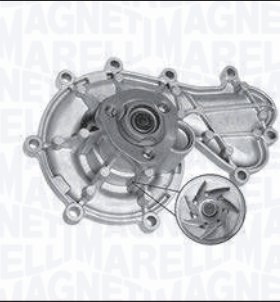
84021
NEW
350984021000

FLANGIA

| | |
|-------------------------|---------|
| Numero Fori Flangia | 3 |
| Dimensione Fori Flangia | M8x1.25 |
| Posizione Attacco | 56 |
| Diametro Centraggio | Ø30 |
| Diametro Girante | Ø65.5 |
| N° Alette Girante | 7 |
| Posizione Girante | 17.2 |

KW

AUDI
A4 IV, Avant, Allroad

| | | | | | |
|--------------------|-----|---------------|---|---------------------|--|
| 3.0 TDI | 150 | 11/11 → 12/15 | D | CLAB | |
| 3.0 TDI quattro | 180 | 11/11 → 12/15 | D | CDUC, CKVB, CKVC | |

A5, Sportback, Cabriolet

| | | | | | |
|--------------------|-----|---------|---|---------------------|--|
| 3.0 TDI | 150 | 10/11 → | D | CLAB | |
| 3.0 TDI quattro | 180 | 10/11 → | D | CDUC, CKVB, CKVC | |
| | 180 | 10/11 → | D | CDUC, CKVC | |

A6 IV, Avant, Allroad

| | | | | | |
|--------------------|-----|---------|---|------|--|
| 3.0 TDI | 150 | 11/10 → | D | CLAB | |
| 3.0 TDI quattro | 150 | 03/11 → | D | CLAA | |

A7

| | | | | | |
|--------------------|-----|---------|---|---------------------------|---------------------|
| 3.0 TDI | 150 | 11/10 → | D | CLAB | |
| | 150 | 12/10 → | D | CLAA | |
| 3.0 TDI quattro | 180 | 10/10 → | D | CDUC, CDUD, CKVB, CKVC | M: CDUD, M: CDUC |

84021
NEW
350984021000

KW

AUDI
A8 III

| | | | | | |
|--------------------|-----|---------|---|---------------------|--|
| 3.0 TDI | 150 | 09/11 → | D | CLAB | |
| | 155 | 08/10 → | D | CDTB, CTBB | |
| 3.0 TDI quattro | 184 | 07/10 → | D | CDTA, CDTC, CMHA | |

Q5

| | | | | | |
|--------------------|-----|---------|---|------|--|
| SQ5 TDI quattro | 240 | 04/15 → | D | CVUB | |
|--------------------|-----|---------|---|------|--|

Q7 I

| | | | | | |
|---------|-----|---------------|---|---------------------|--|
| 3.0 TDI | 150 | 05/10 → 08/15 | D | CJGC, CJMA | |
| | 180 | 05/11 → 08/15 | D | CJGD, CLZB, CRCA | |

VOLKSWAGEN
Touareg II

| | | | | | |
|------------|-----|---------|---|---------------------|--|
| 3.0 V6 TDI | 150 | 01/10 → | D | CASD, CJMA, CVWA | |
| | 180 | 05/11 → | D | CJGD, CRCA | |
| | 193 | 09/14 → | D | CVVA | |

84022
NEW
350984022000

PULEGGIA

| | |
|----------------------------|------|
| Diametro Puleggia | Ø94 |
| Numero Denti/Gole Puleggia | 6 |
| Altezza Puleggia | 23 |
| Posizione Attacco | 52.3 |
| Diametro Girante | Ø62 |
| N° Alette Girante | 6 |
| Posizione Girante | 5.4 |

KW

BMW
3 V (E90), Touring (E91), Cabrio (E93), Coupé (E92)

| | | | | | |
|--------------|-----|---------------|---|------------------------|--|
| 325 d | 150 | 04/10 → 12/13 | D | M57N2306D3, N57D30A | |
| | 150 | 01/10 → 12/11 | D | N57D30A | |
| 330 d | 180 | 01/09 → 12/11 | D | M57N2306D3, N57D30A | |
| 330 d xDrive | 180 | 01/09 → 12/11 | D | N57D30A | |
| 330 xd | 180 | 01/09 → 12/13 | D | M57N2306D3, N57D30A | |

84023
NEW
350984023000

PULEGGIA

| | |
|----------------------------|------|
| Diametro Puleggia | Ø94 |
| Numero Denti/Gole Puleggia | 7 |
| Altezza Puleggia | 26.5 |
| Posizione Attacco | 53.5 |
| Diametro Girante | Ø62 |
| N° Alette Girante | 6 |
| Posizione Girante | 5.4 |

KW

BMW
5 VI (F10), Touring (F11), GT (F07)

| | | | | |
|--------------|-----|---------|---|---------|
| 525 d | 150 | 02/10 → | D | N57D30A |
| 530 d | 155 | 07/10 → | D | N57D30A |
| | 180 | 12/09 → | D | N57D30A |
| 530 d xDrive | 180 | 09/10 → | D | N57D30A |
| | 190 | 10/09 → | D | N57D30A |
| 535 d | 220 | 08/10 → | D | N57D30B |
| 535 d xDrive | 220 | 09/10 → | D | N57D30B |

7 V (F01, F02, F03, F04)

| | | | | |
|--------------|-----|---------------|---|---------|
| 730 d | 180 | 10/08 → 12/15 | D | N57D30A |
| 740 d | 225 | 09/09 → 12/15 | D | N57D30B |
| 740 d xDrive | 225 | 09/09 → 12/15 | D | N57D30B |

X5 II (E70)

| | | | | |
|-------------|-----|---------------|---|---------|
| xDrive 30 d | 155 | 09/08 → 06/13 | D | N57D30A |
| | 180 | 09/10 → 06/13 | D | N57D30A |
| xDrive 40 d | 225 | 09/10 → 06/13 | D | N57D30B |

X6 I (E71, E72)

| | | | | |
|-------------|-----|---------------|---|-------------------------------------|
| xDrive 30 d | 155 | 09/10 → 06/14 | D | N57D30A |
| | 180 | 09/10 → 06/14 | D | M57D30 (306D3), M57N2306D3, N57D30A |
| xDrive 40 d | 225 | 10/10 → 06/14 | D | N57D30B |

84024
NEW
350984024000

PULEGGIA

| | |
|-------------------|-------|
| Diametro Puleggia | Ø56.2 |
| Altezza Puleggia | 30.3 |
| Posizione Attacco | 56.1 |
| Diametro Girante | Ø60 |
| N° Alette Girante | 6 |
| Posizione Girante | 5.3 |

KW

RENAULT
Clio III, Grandtour

| | | | | |
|-------------|----|---------|---|--------|
| 1.2 16V | 76 | 09/10 → | B | D4F786 |
| 1.2 Ethanol | 55 | 07/08 → | | |

Clio IV, Grandtour

| | | | | |
|---------|----|---------|---|----------------|
| 1.2 16V | 54 | 11/12 → | B | D4F728, D4F740 |
| | 54 | 01/13 → | B | D4F740 |

Wind

| | | | | |
|-----|----|---------|---|--------|
| 1.2 | 74 | 07/10 → | B | D4F782 |
|-----|----|---------|---|--------|

84025
NEW
350984025000

PULEGGIA

| | |
|-------------------|-------|
| Diametro Puleggia | Ø105 |
| Altezza Puleggia | 37.5 |
| Posizione Attacco | 54.5 |
| Diametro Girante | Ø81.8 |
| N° Alette Girante | 9 |
| Posizione Girante | 3.75 |

KW

MERCEDES-BENZ
Sprinter III (906)

| | | | | |
|-------------|-----|---------|---|----------------------|
| 210 CDI | 70 | 03/09 → | D | OM651.955 |
| 213 CDI | 95 | 06/06 → | D | OM651.955, OM651.956 |
| | 95 | 03/09 → | D | OM651.956 |
| 216 CDI | 120 | 06/06 → | D | OM651.955, OM651.957 |
| | 120 | 03/09 → | D | OM651.957 |
| 310 CDI | 70 | 03/09 → | D | OM651.955 |
| | 70 | 03/09 → | D | OM651.955, OM651.956 |
| 313 CDI | 95 | 08/11 → | D | OM651.955, OM651.956 |
| 313 CDI 4x4 | 95 | 08/11 → | D | OM651.955, OM651.956 |

84025

NEW

350984025000



MERCEDES-BENZ

Sprinter III (906)

| | | | | |
|-------------|-----|---------|---|-------------------------|
| 316 CDI | 120 | 08/11 → | D | OM651.955, OM651.957 |
| | 120 | 03/09 → | D | OM651.957 |
| 316 CDI 4x4 | 120 | 08/11 → | D | OM651.955, OM651.957 |
| 413 CDI | 95 | 06/06 → | D | OM646.986 |
| 416 CDI | 120 | 03/09 → | D | OM651.957 |
| 510 CDI | 70 | 03/09 → | D | OM651.955 |
| 513 CDI | 95 | 06/06 → | D | OM651.955, OM651.956 |
| | 95 | 06/06 → | D | OM651.956 |
| | 95 | 06/06 → | D | OM646.986 |
| 513 CDI 4x4 | 95 | 05/11 → | D | OM651.955, OM651.956 |
| | 95 | 06/06 → | D | OM651.956 |
| 516 CDI | 120 | 03/09 → | D | OM651.955, OM651.957 |
| 516 CDI 4x4 | 120 | 06/06 → | D | OM651.955, OM651.957 |

84026

NEW

350984026000



PULEGGIA

| | |
|-------------------|-------|
| Diametro Puleggia | Ø87.5 |
| Altezza Puleggia | 20 |
| Posizione Attacco | 56.6 |
| Diametro Girante | Ø62.2 |
| N° Alette Girante | 7 |
| Posizione Girante | 17.3 |



MINI

Mini Clubvan

| | | | | |
|----------|----|---------|---|---------|
| Cooper D | 82 | 12/12 → | D | N47C16A |
| | 82 | 12/12 → | D | N47C20A |

Mini Countryman (R60)

| | | | | |
|----------------|-----|---------|---|---------|
| Cooper D | 82 | 06/10 → | D | N47C16A |
| | 82 | 02/11 → | D | N47C20A |
| Cooper D ALL4 | 82 | 06/10 → | D | N47C16A |
| | 82 | 02/11 → | D | N47C20A |
| Cooper SD | 105 | 02/11 → | D | N47C20A |
| Cooper SD ALL4 | 100 | 02/11 → | D | N47C20A |
| | 105 | 02/11 → | D | N47C20A |
| One D | 66 | 06/10 → | D | N47C16A |

84026

NEW

350984026000



MINI

Mini II (R55, R56, R57, R58, R59)

| | | | | |
|-----------|-----|---------------|---|---------|
| Cooper D | 82 | 06/10 → 11/13 | D | N47C16A |
| | 82 | 02/11 → 11/13 | D | N47C20A |
| Cooper SD | 100 | 02/11 → 11/13 | D | N47C20A |
| | 105 | 02/11 → 11/13 | D | N47C20A |
| One D | 66 | 07/10 → 11/13 | D | N47C16A |

Mini Paceman (R61)

| | | | | |
|----------------|-----|---------|---|---------|
| Cooper D | 82 | 09/12 → | D | N47C16A |
| | 82 | 09/12 → | D | N47C20A |
| Cooper D ALL4 | 82 | 09/12 → | D | N47C16A |
| | 82 | 09/12 → | D | N47C20A |
| Cooper SD | 105 | 10/12 → | D | N47C20A |
| Cooper SD ALL4 | 105 | 10/12 → | D | N47C20A |

TOYOTA

Auris II, Touring Sports, Van

| | | | | |
|----------|----|---------|---|-----|
| 1.6 D4-D | 82 | 04/15 → | D | 1WW |
|----------|----|---------|---|-----|

RAV 4 IV

| | | | | |
|----------|-----|---------|---|-----|
| 2.0 D-4D | 105 | 10/15 → | D | 2WW |
|----------|-----|---------|---|-----|

Verso

| | | | | |
|----------|----|---------|---|-----|
| 1.6 D4-D | 82 | 11/13 → | D | 1WW |
|----------|----|---------|---|-----|

84027

NEW

350984027000



FLANGIA

| | |
|-------------------------|---------|
| Numero Fori Flangia | 3 |
| Dimensione Fori Flangia | M8x1.25 |
| Posizione Attacco | 55.2 |
| Diametro Centraggio | Ø30 |
| Diametro Girante | Ø52.5 |
| N° Alette Girante | 6 |
| Posizione Girante | 13.6 |



CHEVROLET

Aveo II

| | | | | |
|-----------|-----|---------|---|----------|
| 1.2 | 51 | 03/11 → | B | A12XEL |
| | 63 | 03/11 → | B | A12XER |
| 1.2 LPG | 63 | 11/12 → | | A12XER |
| 1.4 | 74 | 03/11 → | B | A14XER |
| 1.4 Turbo | 103 | 08/13 → | B | LUJ, LUV |

84027 NEW **350984027000**

CHEVROLET
Cruze II, Hatchback, Station Wagon

| | | | | |
|-----|-----|---------|---|------------------|
| 1.4 | 103 | 06/12 → | B | LUJ |
| | 103 | 09/10 → | B | A14NET, LUJ, LUV |
| | 74 | 07/13 → | B | A14XER, LDD |
| | 103 | 10/13 → | B | A14NET |

Orlando

| | | | | |
|-----|-----|---------|---|-----|
| 1.4 | 103 | 06/12 → | B | LUJ |
|-----|-----|---------|---|-----|

Trax

| | | | | |
|---------|-----|---------|---|----------------|
| 1.4 | 103 | 12/12 → | B | LUJ, LUV |
| 1.4 AWD | 103 | 12/12 → | B | LUJ |
| 1.4 LPG | 103 | 04/13 → | | A14NET, B14NET |

OPEL
Adam

| | | | | |
|---------|-----|---------|---|----------------|
| 1.2 | 51 | 10/12 → | B | A12XEL, B12XEL |
| 1.4 | 64 | 10/12 → | B | A14XEL, B14XEL |
| | 74 | 10/12 → | B | A14XER, B14XER |
| 1.4 LPG | 64 | 07/13 → | | A14XEL, B14XEL |
| 1.4 S | 110 | 11/14 → | B | B14NEH |

Astra J, Station Wagon, GTC

| | | | | |
|-----------|-----|---------|---|----------------|
| 1.4 | 88 | 10/11 → | B | A14NEL, B14NEL |
| | 103 | 10/11 → | B | A14NET, B14NET |
| | 64 | 12/09 → | B | A14XEL |
| 1.4 | 74 | 10/11 → | B | A14XER |
| 1.4 LPG | 103 | 01/12 → | | A14NET |
| 1.4 Turbo | 88 | 10/10 → | B | A14NEL, B14NEL |
| | 103 | 12/09 → | B | A14NET |
| | 103 | 10/10 → | B | A14NET, B14NET |

Cascada (W13)

| | | | | |
|-----------|-----|---------|---|--------|
| 1.4 | 88 | 03/13 → | B | A14NEL |
| 1.4 Turbo | 103 | 03/13 → | B | A14NET |

Combo A

| | | | | |
|---------|----|---------------|---|-------|
| 1.4 16V | 66 | 08/99 → 10/01 | B | X14XE |
|---------|----|---------------|---|-------|

84027 NEW **350984027000**

OPEL
Corsa D, Van

| | | | | |
|---------|----|---------|---|--------|
| 1.2 | 51 | 06/10 → | B | A12XEL |
| | 63 | 06/10 → | B | A12XER |
| 1.2 LPG | 61 | 06/11 → | | A12XER |
| | 63 | 08/11 → | | A12XER |
| 1.4 | 88 | 07/12 → | B | A14NEL |
| | 64 | 09/09 → | B | A14XEL |
| | 74 | 06/10 → | B | A14XER |
| 1.4 LPG | 64 | 09/09 → | | A14XEL |

Corsa E, Van

| | | | | |
|-----------|-----|---------|---|--------|
| 1.2 | 51 | 09/14 → | B | B12XEL |
| 1.4 | 55 | 09/14 → | B | B14XEJ |
| | 66 | 09/14 → | B | B14XEL |
| 1.4 LPG | 66 | 03/15 → | | B14XEL |
| 1.4 Turbo | 74 | 09/14 → | B | B14NEJ |
| | 110 | 03/15 → | B | B14NEH |

Insignia, Station Wagon

| | | | | |
|---------|-----|---------|---|----------------|
| 1.4 | 103 | 09/11 → | B | A14NET |
| | 103 | 04/11 → | B | A14NET, B14NET |
| 1.4 LPG | 103 | 07/12 → | | A14NET |

Meriva B

| | | | | |
|---------|-----|---------|---|----------------|
| 1.4 | 88 | 06/10 → | B | A14NEL, B14NEL |
| | 103 | 06/10 → | B | A14NET, B14NET |
| | 74 | 06/10 → | B | A14XER, B14XER |
| 1.4 LPG | 88 | 06/11 → | | A14NEL, B14NEL |

Mokka

| | | | | |
|---------|-----|---------|---|----------------|
| 1.4 | 103 | 04/13 → | B | A14NET, B14NET |
| 1.4 4x4 | 103 | 06/12 → | B | A14NET, B14NET |
| 1.4 LPG | 103 | 04/13 → | | A14NET |

Zafira C

| | | | | |
|---------|-----|---------|---|----------------|
| 1.4 | 88 | 10/11 → | B | A14NEL, B14NEL |
| | 103 | 10/11 → | B | A14NET, B14NET |
| 1.4 LPG | 103 | 10/11 → | | A14NET, B14NET |

84027 NEW **350984027000**



VAUXHALL

ASTRA

| | | | | |
|-----------|-----|---------|---|--------|
| 1.4 | 64 | 12/09 → | B | A14XEL |
| | 74 | 12/09 → | B | A14XER |
| 1.4 Turbo | 103 | 12/09 → | B | A14NET |

84028 NEW **350984028000**

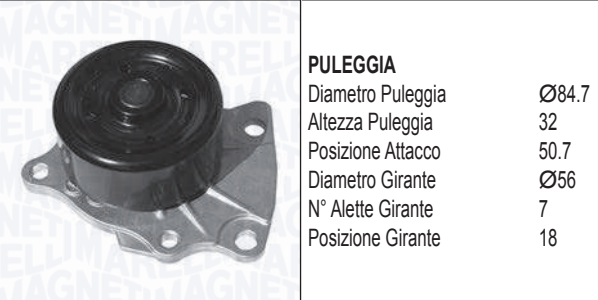

PULEGGIA
 Diametro Puleggia Ø84.7
 Altezza Puleggia 32
 Posizione Attacco 50.7
 Diametro Girante Ø56
 N° Alette Girante 7
 Posizione Girante 18



TOYOTA

IQ

| | | | | |
|----------|----|---------|---|--------|
| 1.4 D-4D | 66 | 01/09 → | D | 1ND-TV |
|----------|----|---------|---|--------|

84029 NEW **350984029000**

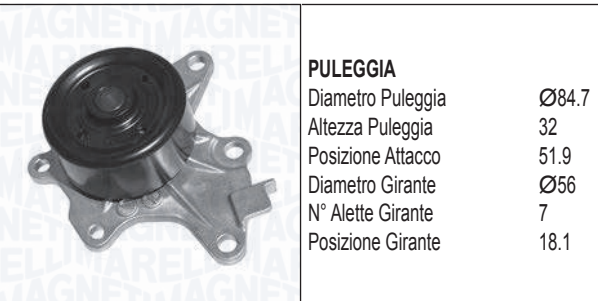

PULEGGIA
 Diametro Puleggia Ø84.7
 Altezza Puleggia 32
 Posizione Attacco 51.9
 Diametro Girante Ø56
 N° Alette Girante 7
 Posizione Girante 18.1



SUBARU

Trezia

| | | | | |
|-------|----|---------|---|--------|
| 1.4 D | 66 | 03/11 → | D | 1ND-TV |
|-------|----|---------|---|--------|

TOYOTA

Auris I, Van

| | | | | | |
|----------|----|---------------|---|--------|-----------|
| 1.4 D-4D | 66 | 03/07 → 09/12 | D | 1ND-TV | 02-2009 → |
|----------|----|---------------|---|--------|-----------|

Auris II, Touring Sports, Van

| | | | | |
|----------|----|---------|---|--------|
| 1.4 D-4D | 66 | 10/12 → | D | 1ND-TV |
|----------|----|---------|---|--------|

Corolla VIII, Hatchback, Station Wagon

| | | | | | |
|----------|----|---------|---|--------|-----------|
| 1.4 D-4D | 66 | 01/07 → | D | 1ND-TV | 02-2009 → |
|----------|----|---------|---|--------|-----------|

Corolla IX, Hatchback, Station Wagon

| | | | | |
|----------|----|---------|---|--------|
| 1.4 D-4D | 66 | 06/13 → | D | 1ND-TV |
|----------|----|---------|---|--------|

Corolla Verso

| | | | | | |
|----------|----|---------------|---|--------|-----------|
| 1.4 D-4D | 66 | 03/04 → 03/09 | D | 1ND-TV | 02-2009 → |
|----------|----|---------------|---|--------|-----------|

84029 NEW **350984029000**



TOYOTA

Urban Cruiser

| | | | | |
|----------|----|---------|---|--------|
| 1.4 D-4D | 66 | 04/09 → | D | 1ND-TV |
|----------|----|---------|---|--------|

| | | | | |
|-----------------|----|---------|---|--------|
| 1.4 D-4D 4WD | 66 | 04/09 → | D | 1ND-TV |
|-----------------|----|---------|---|--------|

Verso S

| | | | | |
|----------|----|---------|---|--------|
| 1.4 D4-D | 66 | 11/10 → | D | 1ND-TV |
|----------|----|---------|---|--------|

Yaris III

| | | | | |
|----------|----|---------|---|--------|
| 1.4 D-4D | 66 | 09/11 → | D | 1ND-TV |
|----------|----|---------|---|--------|

84030 NEW **350984030000**

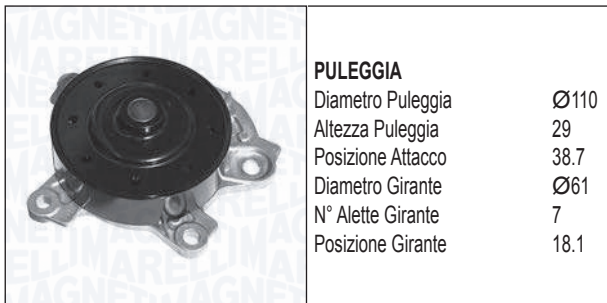

PULEGGIA
 Diametro Puleggia Ø110
 Altezza Puleggia 29
 Posizione Attacco 38.7
 Diametro Girante Ø61
 N° Alette Girante 7
 Posizione Girante 18.1



TOYOTA

Auris I, Van

| | | | | |
|-----|----|---------------|---|---------|
| 1.6 | 97 | 05/09 → 09/12 | B | 1ZR-FAE |
|-----|----|---------------|---|---------|

| | | | | |
|----------|----|---------------|---|--------|
| 1.6 VVTi | 91 | 03/07 → 09/12 | B | 1ZR-FE |
|----------|----|---------------|---|--------|

| | | | | |
|-----|-----|---------------|---|---------|
| 1.8 | 106 | 02/09 → 09/12 | B | 2ZR-FAE |
|-----|-----|---------------|---|---------|

| | | | | |
|--|-----|---------------|---|---------|
| | 108 | 02/09 → 09/12 | B | 2ZR-FAE |
|--|-----|---------------|---|---------|

| | | | | |
|---------|-----|---------------|---|---------|
| 1.8 4WD | 100 | 02/09 → 09/12 | B | 2ZR-FAE |
|---------|-----|---------------|---|---------|

Auris II, Touring Sports, Van

| | | | | |
|-----|----|---------|---|---------|
| 1.6 | 97 | 10/12 → | B | 1ZR-FAE |
|-----|----|---------|---|---------|

Avensis III, Liftback, Station Wagon

| | | | | |
|-----|----|---------|---|---------|
| 1.6 | 97 | 02/09 → | B | 1ZR-FAE |
|-----|----|---------|---|---------|

| | | | | |
|-----|-----|---------|---|---------|
| 1.8 | 108 | 02/09 → | B | 2ZR-FAE |
|-----|-----|---------|---|---------|

| | | | | |
|-----|-----|---------|---|----------|
| 2.0 | 112 | 02/09 → | B | 3ZR-FAE, |
|-----|-----|---------|---|----------|

| | | | | |
|--|--|--|--|--------|
| | | | | 3ZR-FE |
|--|--|--|--|--------|

Corolla VIII, Hatchback, Station Wagon

| | | | | |
|-----|----|---------|---|--------------------|
| 1.6 | 97 | 01/09 → | B | 1ZR-FAE, 1ZR-FE |
|-----|----|---------|---|--------------------|

| | | | | |
|------------------|----|---------|---|--------|
| 1.6 Dual VVTi | 91 | 01/07 → | B | 1ZR-FE |
|------------------|----|---------|---|--------|

| | | | | |
|----------|----|---------|---|--------|
| 1.6 VVTi | 90 | 10/12 → | B | 1ZR-FE |
|----------|----|---------|---|--------|

| | | | | |
|----------|----|---------|---|--------|
| 1.6 VVTi | 90 | 10/12 → | B | 1ZR-FE |
|----------|----|---------|---|--------|

| | | | | |
|----------|----|---------|---|--------|
| 1.6 VVTi | 90 | 10/12 → | B | 1ZR-FE |
|----------|----|---------|---|--------|

Corolla IX, Hatchback, Station Wagon

| | | | | |
|-----|----|---------|---|---------|
| 1.6 | 97 | 06/13 → | B | 1ZR-FAE |
|-----|----|---------|---|---------|

| | | | | |
|----------|-----|---------|---|--------------------|
| 1.8 VVTi | 103 | 06/13 → | B | 2ZR-FBE, 2ZR-FE |
|----------|-----|---------|---|--------------------|

84030 **NEW** 350984030000

TOYOTA
RAV 4 III

| | | | | |
|---------------|-----|---------|---|---------|
| 2.0 | 116 | 12/08 → | B | 3ZR-FAE |
| 2.0 4WD | 116 | 12/08 → | B | 3ZR-FAE |
| 2.0 VVT-i | 109 | 03/09 → | B | 3ZR-FAE |
| 2.0 VVT-i 4WD | 109 | 03/09 → | B | 3ZR-FAE |

RAV 4 IV

| | | | | |
|---------------|-----|---------|---|---------|
| 2.0 VVT-i | 107 | 12/12 → | B | 3ZR-FE |
| 2.0 VVT-i 4WD | 111 | 12/12 → | B | 3ZR-FAE |

Verso

| | | | | |
|-----|-----|---------|---|---------|
| 1.6 | 97 | 04/09 → | B | 1ZR-FAE |
| 1.8 | 108 | 04/09 → | B | 2ZR-FAE |

Yaris II

| | | | | |
|----------|----|---------|---|--------|
| 1.8 VVTi | 98 | 01/07 → | B | 2ZR-FE |
|----------|----|---------|---|--------|

84031 **NEW** 350984031000

PULEGGIA

| | |
|-------------------|------|
| Diametro Puleggia | Ø85 |
| Altezza Puleggia | 32.5 |
| Posizione Attacco | 54.5 |
| Diametro Girante | Ø45 |
| N° Alette Girante | 6 |
| Posizione Girante | 20.2 |

TOYOTA
IQ

| | | | | |
|-----|----|---------|---|--------|
| 1.0 | 50 | 01/09 → | B | 1KR-FE |
|-----|----|---------|---|--------|

84032 **NEW** 350984032000

PULEGGIA

| | |
|-------------------|-------|
| Diametro Puleggia | Ø94.8 |
| Altezza Puleggia | 30.7 |
| Posizione Attacco | 49 |
| Diametro Girante | Ø44.6 |
| N° Alette Girante | 6 |
| Posizione Girante | 19.1 |

DAIHATSU
Charade VI

| | | | | |
|----------|----|---------|---|--------|
| 1.33 16V | 73 | 05/11 → | B | 1NR-FE |
|----------|----|---------|---|--------|

SUBARU
Trezia

| | | | | |
|-----|----|---------|---|--------------------|
| 1.3 | 73 | 03/11 → | B | 1NR-FE, 1NR-FKE |
|-----|----|---------|---|--------------------|

TOYOTA
Auris I, Van

| | | | | |
|-----------|----|---------------|---|--------|
| 1.33 | 73 | 01/10 → 09/12 | B | 1NR-FE |
| Dual-VVTi | 74 | 05/09 → 09/12 | B | 1NR-FE |

Auris II, Touring Sports, Van

| | | | | |
|-----|----|---------|---|--------|
| 1.3 | 73 | 10/12 → | B | 1NR-FE |
|-----|----|---------|---|--------|

Corolla VIII, Hatchback, Station Wagon

| | | | | |
|------|----|---------|---|--------|
| 1.33 | 74 | 01/07 → | B | 1NR-FE |
|------|----|---------|---|--------|

Corolla IX, Hatchback, Station Wagon

| | | | | |
|-----|----|---------|---|--------|
| 1.3 | 73 | 06/13 → | B | 1NR-FE |
|-----|----|---------|---|--------|

Urban Cruiser

| | | | | |
|------|----|---------|---|--------|
| 1.33 | 73 | 04/10 → | B | 1NR-FE |
| | 74 | 04/09 → | B | 1NR-FE |

Verso S

| | | | | |
|------|----|---------|---|--------|
| 1.33 | 70 | 11/10 → | B | 1NR-FE |
| | 73 | 11/10 → | B | 1NR-FE |

Yaris II

| | | | | |
|------------|----|---------|---|--------|
| 1.33 VVT-i | 73 | 07/10 → | B | 1NR-FE |
| | 74 | 03/09 → | B | 1NR-FE |

Yaris III

| | | | | |
|---------|----|---------|---|--------------------|
| 1.3 | 70 | 09/11 → | B | 1NR-FE |
| | 73 | 09/11 → | B | 1NR-FE, 1NR-FKE |
| 1.3 4WD | 70 | 12/10 → | B | 1NR-FE |

84033

NEW

350984033000



PULEGGIA

| | |
|----------------------------|-------|
| Diametro Puleggia | Ø54.7 |
| Numero Denti/Gole Puleggia | 22 |
| Altezza Puleggia | 32 |
| Posizione Attacco | 75.7 |
| Diametro Girante | Ø84.7 |
| N° Alette Girante | 7 |
| Posizione Girante | 36.15 |



CHRYSLER

Grand Voyager V

| | | | | |
|---------|-----|---------|---|-----|
| 2.8 CRD | 120 | 10/07 → | D | |
| | 120 | 10/07 → | D | ENS |

Voyager IV

| | | | | |
|---------|-----|---------------|---|-----|
| 2.5 CRD | 88 | 08/05 → 12/08 | D | EDK |
| | 105 | 02/00 → 12/08 | D | ENJ |
| 2.8 CRD | 110 | 06/04 → 12/08 | D | ENR |

84034

NEW

350984034000



FLANGIA

| | |
|-------------------------|---------|
| Numero Fori Flangia | 3 |
| Dimensione Fori Flangia | M8×1.25 |
| Posizione Attacco | 46.7 |
| Diametro Mozzo | Ø28 |
| Diametro Girante | Ø66 |
| N° Alette Girante | 5 |
| Posizione Girante | 39 |



MERCEDES-BENZ

Classe C IV (W205), Station Wagon (S205), Coupé(C205)

| | | | | |
|-------------------|----|---------|---|-----------|
| C 180 BlueTEC / d | 85 | 05/14 → | D | OM626.951 |
|-------------------|----|---------|---|-----------|

| | | | | |
|-------------------|-----|---------|---|-----------|
| C 200 BlueTEC / d | 100 | 05/14 → | D | OM626.951 |
|-------------------|-----|---------|---|-----------|

Vito III (W447)

| | | | | |
|---------|----|---------|---|-----------|
| 109 CDI | 65 | 10/14 → | D | OM622.951 |
|---------|----|---------|---|-----------|

| | | | | |
|-----------------------|----|---------|---|-----------|
| 109 CDI / 109 BlueTEC | 65 | 10/14 → | D | OM622.951 |
|-----------------------|----|---------|---|-----------|

| | | | | |
|---------|----|---------|---|-----------|
| 111 CDI | 84 | 10/14 → | D | OM622.951 |
|---------|----|---------|---|-----------|

| | | | | |
|-----------------------|----|---------|---|-----------|
| 111 CDI / 111 BlueTEC | 84 | 10/14 → | D | OM622.951 |
|-----------------------|----|---------|---|-----------|

84034

NEW

350984034000



NISSAN

Qashqai I

| | | | | |
|---------|----|---------|---|-----|
| 1.6 dCi | 96 | 10/11 → | D | R9M |
|---------|----|---------|---|-----|

| | | | | |
|----------------------------|----|---------|---|-----|
| 1.6 dCi Trazione integrale | 96 | 10/11 → | D | R9M |
|----------------------------|----|---------|---|-----|

Qashqai II

| | | | | |
|---------|----|---------|---|-----|
| 1.6 dCi | 96 | 11/13 → | D | R9M |
|---------|----|---------|---|-----|

| | | | | |
|-------------|----|---------|---|-----|
| 1.6 dCi 4x4 | 96 | 11/13 → | D | R9M |
|-------------|----|---------|---|-----|

X-Trail III

| | | | | |
|---------|----|---------|---|-----|
| 1.6 dCi | 96 | 12/13 → | D | R9M |
|---------|----|---------|---|-----|

| | | | | |
|-------------|----|---------|---|-----|
| 1.6 dCi 4x4 | 96 | 12/13 → | D | R9M |
|-------------|----|---------|---|-----|

RENAULT

Espace V

| | | | | |
|-------------|----|---------|---|--------|
| 1.6 dCi 130 | 96 | 06/15 → | D | R9M409 |
|-------------|----|---------|---|--------|

| | | | | |
|-------------|-----|---------|---|--------|
| 1.6 dCi 160 | 118 | 06/15 → | D | R9M452 |
|-------------|-----|---------|---|--------|

Grand Scénic III

| | | | | |
|---------|----|---------|---|----------------|
| 1.6 dCi | 96 | 04/11 → | D | R9M402, R9M404 |
|---------|----|---------|---|----------------|

Kadjar

| | | | | |
|-------------|----|---------|---|--------|
| 1.6 dCi 130 | 96 | 06/15 → | D | R9M414 |
|-------------|----|---------|---|--------|

| | | | | |
|-----------------|----|---------|---|--------|
| 1.6 dCi 130 4x4 | 96 | 06/15 → | D | R9M414 |
|-----------------|----|---------|---|--------|

Megane III, Station Wagon, Coupé, CC

| | | | | |
|--|----|---------|---|--------|
| | 96 | 04/11 → | D | R9M402 |
|--|----|---------|---|--------|

| | | | | |
|---------|----|---------|---|----------------|
| 1.6 dCi | 96 | 04/11 → | D | R9M402, R9M404 |
|---------|----|---------|---|----------------|

Megane IV

| | | | | |
|-------------|----|---------|---|--|
| 1.6 dCi 130 | 96 | 11/15 → | D | |
|-------------|----|---------|---|--|

| | | | | |
|---------|----|---------|---|----------------|
| 1.6 dCi | 96 | 04/11 → | D | R9M402, R9M404 |
|---------|----|---------|---|----------------|

84035
NEW
350984035000

PULEGGIA

| | |
|----------------------------|-------|
| Diametro Puleggia | Ø54.7 |
| Numero Denti/Gole Puleggia | 22 |
| Altezza Puleggia | 31.8 |
| Posizione Attacco | 76 |
| Diametro Girante | Ø84.9 |
| N° Alette Girante | 7 |
| Posizione Girante | 36.15 |

KW

JEEP
Cherokee III (KJ)

| | | | | |
|----------------|-----|---------------|---|----------|
| 2.5 CRD 4x4 | 105 | 09/01 → 01/08 | D | R425DOHC |
| 2.8 CRD 4x4 | 110 | 11/02 → 01/08 | D | ENR |
| | 120 | 11/04 → 01/08 | D | ENR |

Cherokee IV (KK)

| | | | | |
|----------------|-----|---------|---|-----|
| 2.8 CRD 4x4 | 130 | 05/08 → | D | ENS |
|----------------|-----|---------|---|-----|

Wrangler II

| | | | | |
|----------|-----|---------------|---|-----|
| 2.8 CRDi | 130 | 11/06 → 04/07 | D | ENS |
|----------|-----|---------------|---|-----|

84036
NEW
350984036000

FLANGIA

| | |
|-------------------------|---------|
| Numero Fori Flangia | 3 |
| Dimensione Fori Flangia | M8x1.25 |
| Posizione Attacco | 69.2 |
| Diametro Centraggio | Ø32.9 |
| Diametro Girante | Ø47.8 |
| N° Alette Girante | 6 |
| Posizione Girante | 10.7 |

KW

FORD
B-Max, Van

| | | | | |
|-----------------|----|---------|---|---------------------------|
| 1.0 EcoBoost | 74 | 10/12 → | B | SFJA, SFJB, SFJC, SFJD |
| | 88 | 10/12 → | B | M1JA |
| | 92 | 10/12 → | B | M1JE |

C-Max II, Van

| | | | | |
|----------|----|---------|---|------------|
| 1.0 | 74 | 10/12 → | B | M2DA, SFDA |
| EcoBoost | 92 | 10/12 → | B | M1DA |

Ecosport II

| | | | | |
|----------|-----|---------|---|------|
| 1.0 | 92 | 10/13 → | B | M1JC |
| EcoBoost | 103 | 03/16 → | B | YYJD |

84036
NEW
350984036000

KW

FORD
Fiesta VI, Van

| | | | | |
|-----------------|-----|---------|---|---------------------------|
| 1.0 | 48 | 01/13 → | B | XMJA, XMJB |
| | 59 | 10/12 → | B | P4JA, P4JB, P4JC, P4JD |
| 1.0 EcoBoost | 48 | 01/13 → | B | XMJA, XMJB |
| | 59 | 10/12 → | B | P4JA, P4JB, P4JC, P4JD |
| | 74 | 01/13 → | B | SFJA, SFJB, SFJC, SFJD |
| | 92 | 09/12 → | B | M1JE |
| | 92 | 09/12 → | B | M1JE, M1JH |
| 1.0 Sport | 103 | 05/14 → | B | YYJA, YYJB |

Focus III, Station Wagon, Van

| | | | | |
|----------|----|---------|---|------|
| 1.0 | 74 | 02/12 → | B | M2DA |
| EcoBoost | 92 | 02/12 → | B | M1DA |

Grand C-Max

| | | | | |
|----------|----|---------|---|------------|
| 1.0 | 74 | 10/12 → | B | M2DA, SFDA |
| EcoBoost | 92 | 10/12 → | B | M1DA |

Mondeo V, Station Wagon

| | | | | |
|-----|----|---------|---|------------|
| 1.0 | 92 | 02/15 → | B | M1CA, M1CB |
|-----|----|---------|---|------------|

Tourneo II Connect, Courier, Custom

| | | | | |
|-----|----|---------|---|------------|
| 1.0 | 74 | 11/13 → | B | M2GA, M2GB |
|-----|----|---------|---|------------|

Transit Connect II, Courier

| | | | | |
|-----|----|---------|---|------|
| 1.0 | 74 | 02/13 → | B | M2GA |
|-----|----|---------|---|------|

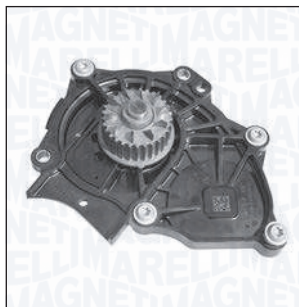
PULEGGIA

| | |
|----------------------------|-------|
| Diametro Puleggia | Ø45 |
| Numero Denti/Gole Puleggia | 29 |
| Altezza Puleggia | 18 |
| Posizione Attacco | 32.9 |
| Diametro Girante | Ø64.8 |
| N° Alette Girante | 5 |
| Posizione Girante | 25.5 |

KW

AUDI
A1, Sportback

| | | | | |
|------------|-----|---------|---|------|
| 1.8 TFSI | 141 | 02/15 → | B | DAJB |
| S1 quattro | 170 | 03/14 → | B | CWZA |

A3 III, Sportback, Cabriolet

| | | | | |
|------------------|-----|---------|---|------------|
| 1.8 TFSI | 125 | 05/14 → | B | CNSB |
| | 132 | 04/12 → | B | CJSA |
| | 132 | 05/13 → | B | CJSA, CJSB |
| 1.8 TFSI quattro | 132 | 08/12 → | B | CJSB |
| S3 quattro | 206 | 02/13 → | B | CJXB |
| | 210 | 05/14 → | B | CJXF |
| | 221 | 11/12 → | B | CJXC |

A4 IV, Avant, Allroad

| | | | | |
|------------------|-----|---------------|---|------|
| 1.8 TFSI | 125 | 11/11 → 12/15 | B | CJEB |
| 1.8 TFSI quattro | 125 | 11/11 → 12/15 | B | CJEB |
| 2.0 TFSI | 165 | 05/13 → 12/15 | B | CNCD |
| 2.0 TFSI quattro | 165 | 05/13 → 12/15 | B | CNCD |

A4 V, Avant, Allroad

| | | | | |
|------------------|-----|---------|---|------------|
| 2.0 TFSI | 140 | 05/15 → | B | CVKB |
| | 183 | 11/15 → | B | CYRC |
| | 185 | 05/15 → | B | CYMC, CYRB |
| 2.0 TFSI quattro | 183 | 11/15 → | B | CYRC |
| | 185 | 05/15 → | B | CYMC, CYRB |
| 2.0 TFSI quattro | 185 | 08/15 → | B | CYRB |

A5, Sportback, Cabriolet

| | | | | |
|------------------|-----|---------|---|----------------------|
| 1.8 TFSI | 106 | 09/14 → | B | CJED |
| | 125 | 10/11 → | B | CABD, CJEB |
| | 125 | 08/11 → | B | CJEB |
| | 130 | 05/15 → | B | CJEE |
| 2.0 TFSI | 155 | 03/09 → | B | CAEB, CDNC 08-2011 → |
| | 155 | 06/08 → | B | CDNC 08-2011 → |
| | 169 | 08/15 → | B | CNCE |
| 2.0 TFSI quattro | 155 | 06/08 → | B | CAEB, CDNC 08-2011 → |
| | 155 | 09/09 → | B | CDNC 08-2011 → |

KW

AUDI
A5, Sportback, Cabriolet

| | | | | |
|------------------|-----|---------|---|------|
| 2.0 TFSI quattro | 169 | 08/15 → | B | CNCE |
|------------------|-----|---------|---|------|

A6 IV, Avant, Allroad

| | | | | |
|------------------|-----|---------|---|------------|
| 1.8 TFSI | 140 | 09/14 → | B | CYGA |
| 2.0 TFSI quattro | 185 | 09/14 → | B | CYNB, CYPA |
| | 183 | 05/15 → | B | CYPB |
| | 185 | 05/15 → | B | CYNB, CYPA |
| 2.0 TFSI quattro | 185 | 05/14 → | B | CYNB, CYPA |
| | 185 | 05/15 → | B | CYPA |

A7

| | | | | |
|------------------|-----|---------|---|------------|
| 1.8 TFSI | 140 | 04/15 → | B | CYGA |
| 2.0 TFSI | 185 | 09/14 → | B | CYPA |
| 2.0 TFSI quattro | 183 | 05/15 → | B | CYPB |
| | 185 | 05/15 → | B | CYNB, CYPA |

Q3

| | | | | |
|------------------|-----|---------|---|------|
| 2.0 TFSI | 132 | 05/15 → | B | CULB |
| 2.0 TFSI quattro | 132 | 11/14 → | B | CULB |

Q5

| | | | | |
|------------------|-----|---------|---|------|
| 2.0 TFSI quattro | 165 | 06/12 → | B | CNCD |
|------------------|-----|---------|---|------|

TT III, Roadster

| | | | | |
|------------------|-----|---------|---|------|
| 1.8 TFSI | 132 | 08/15 → | B | CJSA |
| 2.0 TFSI | 169 | 07/14 → | B | CHHC |
| 2.0 TFSI quattro | 169 | 07/14 → | B | CHHC |
| | 215 | 07/15 → | B | CYFB |
| 2.0 TTS quattro | 210 | 02/15 → | B | CJXF |
| | 228 | 11/14 → | B | CJXG |

SEAT
Alhambra II

| | | | | |
|---------|-----|---------|---|------|
| 2.0 TSI | 162 | 05/15 → | B | DEDA |
|---------|-----|---------|---|------|

Leon III

| | | | | |
|----------------|-----|---------|---|------------|
| 1.8 TSI | 132 | 02/13 → | B | CJSA, CJSB |
| 1.8 TSI 4Drive | 132 | 11/14 → | B | CJSA |
| 2.0 Cupra | 195 | 10/13 → | B | CJXE |
| | 206 | 10/13 → | B | CJXA |

SKODA
Octavia III, Station Wagon

| | | | | |
|-------------|-----|---------|---|------------|
| 1.8 TSI | 132 | 11/12 → | B | CJSA |
| | 132 | 11/12 → | B | CJSA, CJSB |
| 1.8 TSI 4x4 | 132 | 09/14 → | B | CJSA |
| | 132 | 11/12 → | B | CJSB |
| 2.0 TSI RS | 162 | 05/13 → | B | CHHB |
| | 169 | 05/15 → | B | CHHA |

84037
NEW
350984037000

KW

SKODA
Superb

| | | | | |
|-------------|-----|---------|---|------------|
| 1.8 TSI | 132 | 03/15 → | B | CJSA, CJSC |
| 2.0 TSI | 162 | 03/15 → | B | CHHB |
| 2.0 TSI 4x4 | 206 | 03/15 → | B | CJXA |

VOLKSWAGEN
Beetle II (Maggiolino)

| | | | | |
|---------|-----|---------|---|------------|
| 2.0 TSI | 155 | 12/12 → | B | CPLA, CPPA |
| | 162 | 12/14 → | B | CULC |

Golf VII, Variant, Cabrio, AllTrack

| | | | | |
|-----------------|-----|---------|---|------------|
| 1.8 TSI 4motion | 132 | 12/14 → | B | CJSB |
| 2.0 GTI | 155 | 11/13 → | B | CNTA, CXCA |
| | 162 | 04/13 → | B | CHHB, CXDA |
| | 169 | 04/13 → | B | CHHA |
| | 195 | 02/16 → | B | CJXE |
| 2.0 R 4motion | 206 | 11/13 → | B | CJXB |
| | 221 | 11/13 → | B | CJXC |

Jetta IV

| | | | | |
|---------|-----|---------|---|------------|
| 2.0 TSI | 155 | 12/12 → | B | CPLA, CPPA |
|---------|-----|---------|---|------------|

Passat VIII, Variant, AllTrack

| | | | | |
|-----------------|-----|---------|---|------------|
| 1.8 TSI | 132 | 02/15 → | B | CJSA, CJSC |
| 2.0 TSI | 162 | 02/15 → | B | CHHB, CXDA |
| 2.0 TSI 4motion | 162 | 07/15 → | B | CHHB |

Polo VI (6R)

| | | | | |
|---------|-----|---------|---|------------|
| 1.8 GTI | 136 | 11/14 → | B | CWYA |
| | 141 | 11/14 → | B | DAJA, DAJB |

Scirocco III

| | | | | |
|---------|-----|---------|---|------|
| 2.0 R | 206 | 05/14 → | B | CDLK |
| 2.0 TSI | 132 | 11/13 → | B | CULA |
| | 162 | 11/13 → | B | CULC |

Sharan II

| | | | | |
|---------|-----|---------|---|------|
| 2.0 TSI | 162 | 05/15 → | B | DEDA |
|---------|-----|---------|---|------|

Tiguan II

| | | | | |
|-----------------|-----|---------|---|--|
| 2.0 TSI 4motion | 132 | 02/16 → | B | |
|-----------------|-----|---------|---|--|

84038
NEW
350984038000

KW

PULEGGIA

| | |
|----------------------------|--------|
| Diametro Puleggia | Ø59.85 |
| Numero Denti/Gole Puleggia | 20 |
| Altezza Puleggia | 32.3 |
| Posizione Attacco | 62 |
| Diametro Girante | Ø61.5 |
| N° Alette Girante | 8 |
| Posizione Girante | 22.2 |

KW

CITROËN
C 4 I, Coupé, Picasso, Grand Picasso

| | | | | | |
|------------|-----|---------------|----|---------------|--------|
| 1.8 Bifuel | 92 | 01/09 → 10/12 | BF | 6FY (EW7A) | (-)COP |
| 1.8 i 16V | 92 | 10/06 → | B | 6FY (EW7A) | (-)COP |
| 2.0 16V | 100 | 11/04 → 07/07 | B | RFN (EW10J4) | (-)COP |
| | 103 | 11/04 → 07/11 | B | RFJ (EW10A) | (-)COP |
| | 130 | 11/04 → 12/10 | B | RFK (EW10J4S) | (-)COP |
| 2.0 i 16V | 103 | 10/06 → | B | RFJ (EW10A) | (-)COP |
| 2.0 VTR | 103 | 10/06 → 12/07 | B | RFJ (EW10A) | (-)COP |

C 5 I, Break

| | | | | | |
|-------------|-----|---------------|---|--------------|--------|
| 1.8 16V | 85 | 03/01 → 08/04 | B | 6FZ (EW7J4) | (-)COP |
| 2.0 16V | 100 | 03/01 → 08/04 | B | RFN (EW10J4) | (-)COP |
| 2.0 16V HPI | 103 | 03/01 → 08/04 | B | RLZ (EW10D) | (-)COP |

C 5 II, Break

| | | | | | |
|---------|-----|---------|---|-------------|--------|
| 1.8 16V | 92 | 09/05 → | B | 6FY (EW7A) | (-)COP |
| | 85 | 09/04 → | B | 6FZ (EW7J4) | (-)COP |
| 2.0 16V | 103 | 09/04 → | B | RFJ (EW10A) | (-)COP |

C 5 III, Break

| | | | | | |
|-----------------|-----|---------|---|-------------|--------|
| 1.8 16V | 92 | 02/08 → | B | 6FY (EW7A) | (-)COP |
| 2.0 16V | 103 | 02/08 → | B | RFJ (EW10A) | (-)COP |
| 2.0 16V BioFlex | 103 | 02/08 → | | RFJ (EW10A) | (-)COP |

C 8

| | | | | | |
|---------|-----|---------|---|--------------|--------|
| 2.0 | 100 | 07/02 → | B | RFN (EW10J4) | (-)COP |
| 2.0 16V | 103 | 09/05 → | B | RFJ (EW10A) | (-)COP |
| | 104 | 09/05 → | B | RFJ (EW10A) | (-)COP |
| 2.2 | 116 | 07/02 → | B | 3FZ (EW12J4) | (-)COP |

Evasion

| | | | | | |
|---------|-----|---------------|---|--------------|--------|
| 2.0 16V | 100 | 05/00 → 07/02 | B | RFN (EW10J4) | (-)COP |
|---------|-----|---------------|---|--------------|--------|

Jumpy I

| | | | | | |
|-----------|-----|---------------|---|--------------|--------|
| 2.0 | 100 | 04/00 → 12/06 | B | RFN (EW10J4) | (-)COP |
| 2.0 i 16V | 102 | 03/00 → | B | RFN (EW10J4) | (-)COP |

Jumpy II

| | | | | | |
|-----|-----|---------------|---|--------------|--------|
| 2.0 | 100 | 12/03 → 10/06 | B | RFN (EW10J4) | (-)COP |
|-----|-----|---------------|---|--------------|--------|

Jumpy III

| | | | | | |
|-------|-----|---------|---|-------------|--------|
| 2.0 i | 103 | 01/07 → | B | RFH (EW10A) | (-)COP |
|-------|-----|---------|---|-------------|--------|

84038
NEW
350984038000

CITROËN
Xsara, Break, Coupé, Picasso, Van

| | | | | | |
|---------|-----|---------------|---|--------------|--------|
| 1.8 16V | 85 | 02/00 → | B | 6FZ (EW7J4) | (-)COP |
| 1.8 VTS | 85 | 09/00 → 10/04 | B | 6FZ (EW7J4) | (-)COP |
| 2.0 16V | 100 | 09/00 → 03/05 | B | RFN (EW10J4) | (-)COP |

FIAT
Doblò II, Cargo

| | | | | | |
|-----|----|---------|---|-----------|--------|
| 1.4 | 70 | 04/10 → | B | 843A1.000 | (-)COP |
|-----|----|---------|---|-----------|--------|

Scudo I

| | | | | | |
|---------|-----|---------------|---|--------------|--------|
| 2.0 | 100 | 05/00 → 12/06 | B | RFN (EW10J4) | (-)COP |
| 2.0 16V | 100 | 06/00 → 12/06 | B | RFN (EW10J4) | (-)COP |

Ulysse II

| | | | | | |
|-----|-----|---------------|---|--------------|--------|
| 2.0 | 100 | 08/02 → 06/11 | B | RFN (EW10J4) | (-)COP |
|-----|-----|---------------|---|--------------|--------|

LANCIA
Phedra

| | | | | | |
|-----|-----|---------------|---|--------------|--------|
| 2.0 | 100 | 09/02 → 11/10 | B | RFN (EW10J4) | (-)COP |
|-----|-----|---------------|---|--------------|--------|

Zeta

| | | | | | |
|---------|-----|---------------|---|-----|--------|
| 2.0 16V | 100 | 07/00 → 09/02 | B | RFN | (-)COP |
|---------|-----|---------------|---|-----|--------|

PEUGEOT
205 II, Van

| | | | | | |
|---------|-----|---------------|---|---------------|--------|
| 2.0 RC | 130 | 07/03 → | B | RFK (EW10J4S) | (-)COP |
| 2.0 S16 | 99 | 04/99 → 10/00 | B | RFR (DEW10J4) | (-)COP |
| | 100 | 06/99 → | B | RFN (EW10J4) | (-)COP |

206, CC, Van

| | | | | | |
|---------|-----|---------|---|--------------|--------|
| 2.0 16V | 100 | 07/02 → | B | RFN (EW10J4) | (-)COP |
| 2.0 S16 | 100 | 09/00 → | B | RFN (EW10J4) | (-)COP |

307, Station Wagon, CC

| | | | | | |
|---------|-----|---------|---|---------------------------|--------|
| 2.0 | 100 | 03/02 → | B | RFN (EW10J4) | (-)COP |
| | 105 | 08/08 → | B | RFN (EW10J4) | (-)COP |
| 2.0 16V | 100 | 08/00 → | B | RFN (EW10J4) | (-)COP |
| | 103 | 03/05 → | B | RFJ (EW10A) | (-)COP |
| | 103 | 03/05 → | B | RFJ (EW10A), RFN (EW10J4) | (-)COP |
| | 130 | 06/05 → | B | RFK (EW10J4S) | (-)COP |

308 I, Station Wagon, CC

| | | | | | |
|-------------|-----|---------------|---|-------------|--------|
| 2.0 Bioflex | 103 | 01/08 → 01/12 | | RFJ (EW10A) | (-)COP |
| 2.0 CVVT | 103 | 07/09 → 11/14 | B | RFJ (EW10A) | (-)COP |

407, Station Wagon, Coupé

| | | | | | |
|---------|-----|---------|---|--------------|--------|
| 1.8 | 85 | 05/04 → | B | 6FZ (EW7J4) | (-)COP |
| 1.8 16V | 92 | 09/05 → | B | 6FY (EW7A) | (-)COP |
| 2.0 | 100 | 05/04 → | B | RFN (EW10J4) | (-)COP |

84038
NEW
350984038000

PEUGEOT
407, Station Wagon, Coupé

| | | | | | |
|-------------------------|-----|---------------|---|-----------------------------|--------|
| 2.0 16V | 99 | 01/99 → 08/00 | B | RFR (DEW10J4) | (-)COP |
| | 100 | 08/00 → 06/04 | B | RFN (EW10J4) | (-)COP |
| | 100 | 10/00 → 12/04 | B | RFN (EW10J4), RFV (XU10J4R) | (-)COP |
| 2.0 16V | 103 | 09/05 → | B | RFJ (EW10A) | (-)COP |
| | 97 | 11/95 → 05/04 | B | RFV (XU10J4R) | (-)COP |
| | 103 | 05/01 → 05/04 | B | RLZ (EW10D) | (-)COP |
| 2.0 Bioflex | 103 | 09/07 → | | RFJ (EW10A) | (-)COP |
| 2.2 | 116 | 07/00 → 05/04 | B | 3FZ (EW12J4) | (-)COP |
| 2.2 16V | 120 | 09/05 → | B | 3FY (EW12J4) | (-)COP |
| 607 | | | | | |
| 2.0 | 100 | 02/00 → | B | RFN (EW10J4) | (-)COP |
| 2.2 16V | 116 | 02/00 → | B | 3FZ (EW12J4) | (-)COP |
| | 120 | 09/05 → | B | 3FY (EW12J4) | (-)COP |
| 806 | | | | | |
| 2.0 16V | 100 | 09/00 → 08/02 | B | RFN (EW10J4) | (-)COP |
| 807 | | | | | |
| 2.0 | 100 | 06/02 → | B | RFN (EW10J4) | (-)COP |
| 2.0 16V | 103 | 09/05 → | B | RFJ (EW10A) | (-)COP |
| 2.2 | 116 | 06/02 → | B | 3FZ (EW12J4) | (-)COP |
| Expert I | | | | | |
| 2.0 | 100 | 07/00 → | B | RFN (EW10J4) | (-)COP |
| Expert II, Tepee | | | | | |
| 2.0 16V | 103 | 01/07 → | B | RFH (EW10A), RFJ (EW10A) | (-)COP |

84039
NEW
350984039000

PULEGGIA

| | |
|----------------------------|--------|
| Diametro Puleggia | Ø59.26 |
| Numero Denti/Gole Puleggia | 20 |
| Altezza Puleggia | 30.5 |
| Posizione Attacco | 49.7 |
| Diametro Girante | Ø59.5 |
| N° Alette Girante | 8 |
| Posizione Girante | 24.8 |

KW

DACIA
Duster

| | | | | |
|--------------------|----|---------|---|-------------------|
| 1.6 16V | 77 | 04/10 → | B | K4M690, K4M696 |
| 1.6 16V 4x4 | 77 | 06/10 → | B | K4M606 |
| 1.6 16V Hi-Flex | 77 | 08/10 → | | K4M696 |
| 1.6 16V LPG | 77 | 04/11 → | | K4M696 |

Lodgy

| | | | | |
|---------|----|---------|--|-------------------|
| 1.6 LPG | 61 | 11/13 → | | K7M812, K7M828 |
|---------|----|---------|--|-------------------|

Logan

| | | | | |
|---------|----|---------|---|--------|
| 1.6 16V | 77 | 01/13 → | B | K4M842 |
|---------|----|---------|---|--------|

Logan MCV

| | | | | |
|--------------------|----|---------|---|-------------------|
| 1.6 16V | 77 | 02/07 → | B | K4M690, K4M696 |
| 1.6 16V Hi-Flex | 77 | 11/09 → | | K4M690, K4M694 |
| 1.6 MPI 85 | 62 | 05/10 → | B | K7M800 |

Logan, Station Wagon, Van

| | | | | |
|----------------------|----|---------|----|-------------------|
| 1.6 16V | 77 | 02/06 → | B | K4M690, K4M696 |
| 1.6 16V Flexifuel | 77 | 07/10 → | | K4M696 |
| 1.6 Bifuel | 62 | 05/10 → | BF | K7M800 |
| 1.6 MPI 85 | 62 | 05/10 → | B | K7M800 |

Sandero I

| | | | | |
|-------------------|----|---------|----|------------------------------|
| 1.6 16V | 77 | 07/11 → | B | K4M690 |
| 1.6 16V Bifuel | 77 | 01/11 → | BF | K4M690, K4M694, K4M696 |
| 1.6 MPI 85 | 62 | 05/10 → | B | K7M800 |

Sandero II

| | | | | |
|---------|----|---------|---|-------------------|
| 1.6 | 61 | 11/12 → | B | K7M812 |
| 1.6 16V | 77 | 01/13 → | B | K4M842, K4M845 |

84039
NEW
350984039000

KW

NISSAN
Kubistar

| | | | | |
|---------|----|---------------|---|--------|
| 1.6 16V | 70 | 08/03 → 10/09 | B | K4M752 |
|---------|----|---------------|---|--------|

RENAULT
Clio II

| | | | | |
|-------------|----|---------------|---|--|
| 1.4 16V | 70 | 10/99 → 09/04 | B | K4J712, K4J713 |
| | 72 | 08/00 → | B | K4J710, K4J711, K4J712, K4J713 |
| 1.6 16V | 79 | 09/98 → | B | K4M708, K4M740, K4M742, K4M743, K4M744, K4M745, K4M748 |
| 1.6 Hi-Flex | 86 | 01/05 → 02/10 | | K4M748 |

Clio III, Grandtour

| | | | | |
|-------------|----|---------------|---|-------------------|
| 1.4 16V | 72 | 02/10 → | B | K4J780 |
| 1.6 16V | 65 | 06/05 → | B | K4M804 |
| | 82 | 02/08 → | B | K4M800, K4M801 |
| | 94 | 11/08 → | B | K4M862 |
| 1.6 16V GT | 94 | 06/09 → | B | K4M862 |
| 1.6 Hi-Flex | 86 | 05/05 → 02/10 | | K4M748 |

Duster

| | | | | |
|---------|----|---------|---|--------|
| 1.6 16V | 75 | 02/12 → | B | K4M616 |
|---------|----|---------|---|--------|

Fluence

| | | | | |
|---------|----|---------|---|-------------------|
| 1.6 16V | 82 | 02/10 → | B | K4M838 |
| | 81 | 02/10 → | B | K4M838, K4M839 |

Grand Scénic II

| | | | | |
|-----|----|---------------|---|-------------------|
| 1.6 | 77 | 06/06 → | B | K4M788 |
| | 82 | 06/06 → 11/08 | B | K4M812 |
| | 83 | 04/04 → | B | K4M761, K4M782 |

Grand Scénic III

| | | | | |
|-------------------|----|---------|----|--------|
| 1.6 16V | 81 | 02/09 → | B | K4M858 |
| 1.6 16V Bifuel | 81 | 02/09 → | BF | K4M866 |

84039
NEW
350984039000

KW

RENAULT
Kangoo I, Van

| | | | | |
|------------------|----|---------|---|---|
| 1.6 16V | 70 | 06/01 → | B | K4M706, K4M750, K4M752, K4M753 |
| | 70 | 10/01 → | B | K4M706, K4M752 |
| 1.6 16V 4x4 | 70 | 10/01 → | B | K4M750, K4M752, K4M753 |
| 1.6 16V bivalent | 60 | 06/05 → | | K4M850 |

Kangoo II, Be Bop, Van

| | | | | |
|-----------------|----|---------|---|-------------------|
| 1.6 | 78 | 02/09 → | B | K4M830 |
| 1.6 16V | 78 | 02/08 → | B | K4M830 |
| | 78 | 02/08 → | B | K4M830, K4M831 |
| 1.6 16V Hi-Flex | 78 | 02/08 → | | K4M834, K4M850 |
| 1.6 16V LPG | 72 | 02/08 → | | K4M834 |

Laguna I, Grantour

| | | | | |
|---------|----|---------------|---|-------------------|
| 1.6 16V | 79 | 11/97 → 03/01 | B | K4M720, K4M724 |
|---------|----|---------------|---|-------------------|

Laguna II, Grantour

| | | | | |
|--------------|----|---------------|---|--|
| 1.6 16V | 82 | 02/05 → | B | K4M716 |
| | 79 | 03/01 → | B | K4M710, K4M714 |
| | 82 | 02/05 → | B | K4M716 |
| 1.6 FlexFuel | 76 | 06/01 → 10/03 | | K4M718 |
| 1.8 16V | 85 | 03/01 → | B | F4P770, F4P771, F4P773, F4P774, F4P775 |

Laguna III, Grantour, Coupé

| | | | | |
|---------|----|---------|---|--------|
| 1.6 16V | 81 | 10/07 → | B | K4M824 |
|---------|----|---------|---|--------|

Logan I, Station Wagon

| | | | | |
|-----|----|---------|---|--------|
| 1.6 | 77 | 04/07 → | B | K4M690 |
|-----|----|---------|---|--------|

Logan I, Station Wagon, Express

| | | | | |
|-----|----|---------|---|--------|
| 1.6 | 77 | 04/07 → | B | K4M697 |
|-----|----|---------|---|--------|

Megane I, Coach, Cabrio, Scénic, Station Wagon

| | | | | |
|---------|----|---------------|---|-------------------|
| 1.4 16V | 70 | 03/99 → 08/03 | B | K4J714, K4J750 |
|---------|----|---------------|---|-------------------|

84039
NEW
350984039000

KW

RENAULT
Megane I, Coach, Cabrio, Scénic, Station Wagon

| | | | | |
|---------|----|---------------|---|---|
| 1.6 16V | 79 | 03/99 → 08/03 | B | K4M700, K4M701, K4M704, K4M708 |
| | 79 | 03/99 → 08/03 | B | K4M700, K4M701, K4M708 |
| 1.6 LPG | 80 | 10/00 → 08/02 | | K4M704 |

Megane II, Station Wagon, Coupé-Cabrio

| | | | | |
|-----------------|----|---------------|---|---|
| 1.4 | 60 | 09/03 → | B | K4J732 |
| | 72 | 08/03 → 07/09 | B | K4J730, K4J740 |
| 1.4 16V | 60 | 10/03 → 02/08 | B | K4J732 |
| | 72 | 11/02 → 02/08 | B | K4J730, K4J740 |
| 1.6 | 75 | 09/03 → | B | K4M768 |
| | 77 | 05/05 → | B | K4M762 |
| | 77 | 06/05 → 02/08 | B | K4M788 |
| | 83 | 09/03 → 03/09 | B | K4M760, K4M761 |
| 1.6 16V | 77 | 05/05 → 07/09 | B | K4M762 |
| | 82 | 01/06 → 06/08 | B | K4M760, K4M761, K4M812, K4M813 |
| | 82 | 01/06 → 06/08 | B | K4M760, K4M812, K4M813 |
| | 82 | 01/06 → | B | K4M812, K4M813 |
| | 83 | 11/02 → 02/08 | B | K4M760 |
| 1.6 16V Hi-Flex | 77 | 02/08 → 07/09 | | K4M856 |
| 1.6 Flex-Fuel | 77 | 01/07 → 02/08 | | K4M788 |

Megane III, Station Wagon, Coupé, CC

| | | | | |
|----------------|----|---------|----|-------------------|
| 1.6 16V | 82 | 11/08 → | B | K4M858, K4M866 |
| | 74 | 11/08 → | B | K4M848 |
| | 81 | 06/10 → | B | K4M858 |
| 1.6 16V Bifuel | 81 | 11/08 → | BF | K4M866 |
| 1.6 TCe | 96 | 01/11 → | B | |

84039 NEW **350984039000**

RENAULT
Modus

| | | | | |
|-----|----|---------|---|---|
| 1.4 | 72 | 12/04 → | B | K4J770, K4J780 |
| 1.6 | 65 | 12/04 → | B | K4M794 |
| | 82 | 12/04 → | B | K4M790, K4M791, K4M800, K4M801 |

Scénic I

| | | | | |
|------------|----|---------------|----|-------------------|
| 1.4 16V | 70 | 09/99 → 08/03 | B | K4J714, K4J750 |
| 1.6 | 79 | 09/99 → 09/03 | B | K4M700, K4M706 |
| 1.6 BiFuel | 79 | 09/99 → 04/01 | BF | K4M704 |

Scénic II

| | | | | |
|---------|----|---------|---|---|
| 1.4 | 72 | 06/03 → | B | K4J730, K4J740, K4J770 |
| 1.6 | 77 | 06/06 → | B | K4M788 |
| | 83 | 06/03 → | B | K4M761, K4M782 |
| 1.6 16V | 82 | 10/05 → | B | K4M706, K4M766, K4M812, K4M813 |

Scénic III

| | | | | |
|---------|----|---------|----|--------|
| 1.6 16V | 81 | 02/09 → | B | K4M858 |
| 1.6 E85 | 81 | 02/09 → | FF | K4M866 |

Thalia I

| | | | | |
|---------|----|---------|---|--------|
| 1.4 16V | 72 | 08/00 → | B | K4J712 |
| 1.6 16V | 79 | 04/02 → | B | K4M740 |

Thalia II

| | | | | |
|---------|----|---------|---|--------|
| 1.6 16V | 77 | 09/08 → | B | K4M743 |
|---------|----|---------|---|--------|

Twingo II

| | | | | |
|--------|----|---------|---|--------|
| 1.6 RS | 98 | 05/08 → | B | K4M854 |
|--------|----|---------|---|--------|

Wind

| | | | | |
|-----|----|---------|---|--------|
| 1.6 | 98 | 07/10 → | B | K4M854 |
|-----|----|---------|---|--------|

84040 NEW **350984040000**

FLANGIA

| | |
|-------------------------|-------|
| Numero Fori Flangia | 4 |
| Dimensione Fori Flangia | M6X1 |
| Posizione Attacco | 49.7 |
| Diametro Centraggio | Ø24 |
| Diametro Girante | Ø49.5 |
| N° Alette Girante | 6 |
| Posizione Girante | 31.5 |

HYUNDAI
i10 I

| | | | | |
|-----|----|---------|---|------|
| 1.2 | 63 | 04/11 → | B | G4LA |
|-----|----|---------|---|------|

i10 II

| | | | | |
|-----|----|---------|---|------|
| 1.2 | 64 | 12/13 → | B | G4LA |
|-----|----|---------|---|------|

i20 I

| | | | | |
|-----|----|---------|---|------|
| 1.2 | 57 | 09/08 → | B | G4LA |
| | 63 | 03/12 → | B | G4LA |

i20 II, Coupé

| | | | | |
|-----|----|---------|---|------|
| 1.2 | 55 | 11/14 → | B | G4LA |
| | 62 | 11/14 → | B | G4LA |

KIA
Picanto II

| | | | | |
|-----|----|---------|---|------|
| 1.2 | 63 | 09/11 → | B | G4LA |
|-----|----|---------|---|------|

Rio III

| | | | | |
|-----------|----|---------|---|------|
| 1.2 CVVT | 62 | 11/14 → | B | G4LA |
| 1.25 CVVT | 63 | 09/11 → | B | G4LA |
| 1.25 LPG | 63 | 09/11 → | | G4LA |

84042 NEW **350984042000**

FLANGIA

| | |
|-------------------------|------|
| Numero Fori Flangia | 4 |
| Dimensione Fori Flangia | M6x1 |
| Posizione Attacco | 53 |
| Diametro Centraggio | Ø28 |
| Diametro Girante | Ø65 |
| N° Alette Girante | 8 |
| Posizione Girante | 20.7 |

CITROËN
C 4 Aircross

| | | | | |
|-----------------|-----|---------|---|------|
| 1.8 HDi 150 | 110 | 04/12 → | D | 4N13 |
| 1.8 HDi 150 AWC | 110 | 04/12 → | D | 4N13 |

84042
NEW
350984042000

KW

MITSUBISHI
ASX, Van

| | | | | |
|-----------------|-----|---------|---|------|
| 1.8 Di-D | 85 | 06/10 → | D | 4N13 |
| | 110 | 06/10 → | D | 4N13 |
| 1.8 Di-D 4WD | 85 | 06/10 → | D | 4N13 |
| | 110 | 06/10 → | D | 4N13 |
| 2.2 Di-D 4WD | 110 | 04/13 → | D | 4N14 |

Outlander II, Van

| | | | | |
|-----------------|-----|---------------|---|------|
| 2.2 Di-D | 130 | 11/06 → 11/12 | D | 4N14 |
| 2.2 Di-D 4WD | 103 | 09/10 → 11/12 | D | 4N14 |
| | 130 | 11/06 → 11/12 | D | 4N14 |

Outlander III, Van

| | | | | |
|-----------------|-----|---------|---|------|
| 2.2 Di-D | 110 | 08/12 → | D | 4N14 |
| 2.2 Di-D 4WD | 110 | 08/12 → | D | 4N14 |

PEUGEOT
4008

| | | | | |
|----------------|-----|---------|---|--|
| 1.8 HDi AWC | 110 | 05/12 → | D | |
|----------------|-----|---------|---|--|

84043
NEW
350984043000

PULEGGIA

| | |
|-------------------|-------|
| Diametro Puleggia | Ø53 |
| Altezza Puleggia | 29 |
| Posizione Attacco | 54.1 |
| Diametro Girante | Ø84.6 |
| N° Alette Girante | 6 |
| Posizione Girante | 40.4 |

KW

CHRYSLER
Grand Voyager V

| | | | | |
|---------|-----|---------|---|-----|
| 2.8 CRD | 132 | 09/12 → | D | ENS |
|---------|-----|---------|---|-----|

JEEP
Cherokee IV (KK)

| | | | | |
|-----------------|-----|---------|---|-----|
| 2.8 CRDi 4x4 | 147 | 01/10 → | D | ENS |
|-----------------|-----|---------|---|-----|

Wrangler III

| | | | | |
|---------|-----|---------|---|-----|
| 2.8 CRD | 147 | 11/10 → | D | ENS |
| | 130 | 04/07 → | D | ENS |

84044
NEW
350984044000

PULEGGIA

| | |
|----------------------------|-------|
| Diametro Puleggia | Ø110 |
| Numero Denti/Gole Puleggia | 6 |
| Altezza Puleggia | 23 |
| Posizione Attacco | 46 |
| Diametro Girante | Ø81.5 |
| N° Alette Girante | 7 |
| Posizione Girante | 11 |

KW

MERCEDES-BENZ
**Classe C III (W204), Station Wagon (S204),
Coupé (C204)**

| | | | | |
|----------------------|-----|---------------|---|-----------|
| C 180 CDI | 88 | 01/11 → 01/14 | D | OM651.913 |
| C 200 CDI | 100 | 01/11 → 01/14 | D | OM651.913 |
| C 220 CDI | 120 | 10/08 → 01/14 | D | OM651.911 |
| | 120 | 06/11 → | D | OM651.911 |
| | 125 | 12/08 → 01/14 | D | OM651.911 |
| C 220 CDI 4-matic | 125 | 02/13 → 01/14 | D | OM651.912 |
| C 250 CDI | 150 | 08/08 → 01/14 | D | OM651.911 |
| C 250 CDI 4-matic | 150 | 01/11 → 01/14 | D | OM651.912 |

**Classe E IV (W212), Station Wagon (S212),
Cabrio (A207), Coupé (C207)**

| | | | | |
|-----------------------------|-----|---------|---|-----------|
| E 200 CDI / BlueTEC | 100 | 01/09 → | D | OM651.925 |
| E 220 BlueTEC | 130 | 05/15 → | D | OM651.924 |
| | 130 | 05/14 → | D | OM651.911 |
| | 130 | 05/14 → | D | OM651.924 |
| E 220 BlueTEC 4-matic | 125 | 01/15 → | D | OM651.924 |
| E 220 CDI | 120 | 07/14 → | D | OM651.911 |
| | 120 | 01/09 → | D | OM651.924 |
| | 120 | 02/10 → | D | OM651.911 |
| | 120 | 08/09 → | D | OM651.924 |
| E 220 CDI / BlueTEC | 125 | 01/09 → | D | OM651.924 |
| E 220 CDI / BlueTEC / d | 125 | 01/10 → | D | OM651.911 |
| E 220 CDI / d | 125 | 01/10 → | D | OM651.911 |
| E 250 CDI / BlueTEC | 150 | 01/09 → | D | OM651.924 |
| E 250 CDI / BlueTEC / d | 150 | 01/10 → | D | OM651.911 |

84044
NEW
350984044000

KW

MERCEDES-BENZ
Classe E IV (W212), Station Wagon (S212), Cabrio (A207), Coupé (C207)

| | | | | |
|-----------------------------|-----|---------|---|-----------|
| E 250 CDI / BlueTEC 4-matic | 150 | 01/09 → | D | OM651.924 |
|-----------------------------|-----|---------|---|-----------|

| | | | | |
|-------------|-----|---------|---|-----------|
| E 250 CDI/d | 150 | 01/09 → | D | OM651.911 |
|-------------|-----|---------|---|-----------|

| | | | | |
|-------------------------------|-----|---------|--|-----------|
| E 300 Hybrid / BlueTEC Hybrid | 150 | 12/11 → | | OM651.924 |
|-------------------------------|-----|---------|--|-----------|

Classe GLK (X204)

| | | | | |
|---------|-----|---------|---|----------------------|
| 200 CDI | 105 | 07/10 → | D | OM651.913, OM651.916 |
|---------|-----|---------|---|----------------------|

| | | | | |
|---------|-----|---------|---|-----------|
| 220 CDI | 120 | 12/08 → | D | OM651.916 |
| | 125 | 12/08 → | D | OM651.916 |

| | | | | |
|-----------------|-----|---------|---|-----------|
| 220 CDI 4-matic | 120 | 12/08 → | D | OM651.912 |
| | 125 | 12/08 → | D | OM651.912 |

| | | | | |
|-----------------|-----|---------|---|-----------|
| 250 CDI 4-matic | 150 | 09/09 → | D | OM651.912 |
|-----------------|-----|---------|---|-----------|

Classe M III (166)

| | | | | |
|------------------------------|-----|---------|---|-----------|
| ML 250 CDI / BlueTEC 4-matic | 150 | 06/11 → | D | OM651.960 |
|------------------------------|-----|---------|---|-----------|

Classe S VI (W221), Coupé (C216)

| | | | | |
|-----------|-----|---------------|---|-----------|
| S 250 CDI | 150 | 01/11 → 12/13 | D | OM651.961 |
|-----------|-----|---------------|---|-----------|

CLS II (C218), Shooting Brake (X218)

| | | | | |
|-----------------|-----|---------|---|-----------|
| CLS 220 BlueTEC | 130 | 05/14 → | D | OM651.924 |
|-----------------|-----|---------|---|-----------|

| | | | | |
|---------------------|-----|---------|---|-----------|
| CLS 220 BlueTEC / d | 120 | 05/14 → | D | OM651.924 |
|---------------------|-----|---------|---|-----------|

| | | | | |
|---------------------|-----|---------|---|-----------|
| CLS 220 BlueTEC / d | 125 | 05/14 → | D | OM651.924 |
|---------------------|-----|---------|---|-----------|

| | | | | |
|-----------------------------|-----|---------|---|-----------|
| CLS 250 BlueTEC / d 4-matic | 150 | 05/14 → | D | OM651.924 |
|-----------------------------|-----|---------|---|-----------|

| | | | | |
|---------------------------|-----|---------|---|-----------|
| CLS 250 CDI / BlueTEC / d | 150 | 04/11 → | D | OM651.924 |
|---------------------------|-----|---------|---|-----------|

SLC (R172)

| | | | | |
|-------|-----|---------|---|-----------|
| 250 d | 150 | 01/16 → | D | OM651.980 |
|-------|-----|---------|---|-----------|

SLK III (R172)

| | | | | |
|-------------|-----|---------|---|-----------|
| 250 CDI / d | 150 | 01/12 → | D | OM651.980 |
|-------------|-----|---------|---|-----------|

84045
NEW
350984045000

KW

FLANGIA

| | |
|-------------------------|-------|
| Numero Fori Flangia | 3 |
| Dimensione Fori Flangia | M6X1 |
| Posizione Attacco | 76 |
| Diametro Centraggio | Ø30 |
| Diametro Girante | Ø54.5 |
| N° Alette Girante | 7 |
| Posizione Girante | 6 |

KW

AUDI
A1, Sportback

| | | | | |
|----------|----|---------|---|------|
| 1.2 TFSI | 63 | 05/10 → | B | CBZA |
|----------|----|---------|---|------|

A3 II, Sportback, Cabriolet

| | | | | |
|----------|----|---------------|---|------|
| 1.2 TFSI | 77 | 03/10 → 05/13 | B | CBZB |
|----------|----|---------------|---|------|

| | | | | |
|---------|----|---------------|---|------|
| 1.2 TSI | 77 | 04/10 → 08/12 | B | CBZB |
|---------|----|---------------|---|------|

SEAT
Altea, Altea XL

| | | | | |
|---------|----|---------|---|------|
| 1.2 TSI | 77 | 04/10 → | B | CBZB |
|---------|----|---------|---|------|

Ibiza V

| | | | | |
|---------|----|---------|---|------|
| 1.2 TSI | 63 | 08/12 → | B | CBZA |
|---------|----|---------|---|------|

| | | | | |
|--|----|---------|---|------|
| | 77 | 09/10 → | B | CBZB |
|--|----|---------|---|------|

Leon II

| | | | | |
|---------|----|---------------|---|------|
| 1.2 TSI | 77 | 02/10 → 12/12 | B | CBZB |
|---------|----|---------------|---|------|

Toledo IV

| | | | | |
|---------|----|---------|---|------|
| 1.2 TSI | 63 | 07/12 → | B | CBZA |
|---------|----|---------|---|------|

| | | | | |
|--|----|---------|---|------|
| | 77 | 07/12 → | B | CBZB |
|--|----|---------|---|------|

SKODA
Fabia II, Station Wagon, Van

| | | | | |
|---------|----|---------------|---|------|
| 1.2 TSI | 63 | 03/10 → 12/14 | B | CBZA |
|---------|----|---------------|---|------|

| | | | | |
|--|----|---------------|---|------|
| | 77 | 03/10 → 12/14 | B | CBZB |
|--|----|---------------|---|------|

Octavia II, Station Wagon

| | | | | |
|---------|----|---------------|---|------|
| 1.2 TSI | 77 | 02/10 → 06/13 | B | CBZB |
|---------|----|---------------|---|------|

Rapid II

| | | | | |
|---------|----|---------|---|------|
| 1.2 TSI | 63 | 07/12 → | B | CBZA |
|---------|----|---------|---|------|

| | | | | |
|--|----|---------|---|------|
| | 77 | 07/12 → | B | CBZB |
|--|----|---------|---|------|

Roomster, Van

| | | | | |
|---------|----|---------------|---|------|
| 1.2 TSI | 63 | 03/10 → 05/15 | B | CBZA |
|---------|----|---------------|---|------|

| | | | | |
|--|----|---------------|---|------|
| | 77 | 03/10 → 05/15 | B | CBZB |
|--|----|---------------|---|------|

Yeti

| | | | | |
|---------|----|---------|---|------|
| 1.2 TSI | 77 | 09/09 → | B | CBZB |
|---------|----|---------|---|------|

VOLKSWAGEN
Beetle II (Maggiolino)

| | | | | |
|---------|----|---------|---|------|
| 1.2 TSI | 77 | 07/11 → | B | CBZB |
|---------|----|---------|---|------|

Caddy III

| | | | | |
|---------|----|---------|---|------|
| 1.2 TSI | 63 | 09/10 → | B | CBZA |
|---------|----|---------|---|------|

| | | | | |
|--|----|---------|---|------|
| | 77 | 09/10 → | B | CBZB |
|--|----|---------|---|------|

84045
NEW
350984045000

VOLKSWAGEN
Golf V, Plus, Variant

| | | | | |
|---------|----|---------------|---|------|
| 1.2 TSI | 63 | 05/10 → 12/13 | B | CBZA |
| | 77 | 11/09 → 12/13 | B | CBZB |

Golf VI, Variant, Cabrio

| | | | | |
|---------|----|---------------|---|------|
| 1.2 TSI | 63 | 05/10 → 11/12 | B | CBZA |
| | 77 | 11/08 → 11/12 | B | CBZB |

Jetta IV

| | | | | |
|---------|----|---------|---|------|
| 1.2 TSI | 77 | 02/11 → | B | CBZB |
|---------|----|---------|---|------|

Polo VI (6R)

| | | | | |
|---------|----|---------------|---|------|
| 1.2 TSI | 66 | 05/11 → 05/14 | B | CBZC |
| | 77 | 11/09 → | B | CBZB |

Touran I

| | | | | |
|---------|----|---------------|---|------|
| 1.2 TSI | 77 | 05/10 → 05/15 | B | CBZB |
|---------|----|---------------|---|------|

84046
NEW
350984046000

PULEGGIA

| | |
|-------------------|-------|
| Diametro Puleggia | Ø105 |
| Altezza Puleggia | 37.5 |
| Posizione Attacco | 54.5 |
| Diametro Girante | Ø81.8 |
| N° Alette Girante | 9 |
| Posizione Girante | 3.75 |

MERCEDES-BENZ
Vito II (W639) - Viano

| | | | | |
|-----------------|-----|---------|---|-----------|
| 110 CDI | 70 | 09/10 → | D | OM651.940 |
| 113 CDI | 100 | 09/10 → | D | OM651.940 |
| 113 CDI 4x4 | 100 | 09/10 → | D | OM651.940 |
| 116 CDI | 120 | 09/10 → | D | OM651.940 |
| 116 CDI 4x4 | 120 | 09/10 → | D | OM651.940 |
| CDI 2.0 | 100 | 07/10 → | D | OM651.940 |
| CDI 2.0 4-matic | 100 | 07/10 → | D | OM651.940 |
| CDI 2.2 | 120 | 07/10 → | D | OM651.940 |
| CDI 2.2 4-matic | 120 | 07/10 → | D | OM651.940 |

84047
NEW
350984047000

PULEGGIA

| | |
|----------------------------|--------|
| Diametro Puleggia | Ø110.3 |
| Numero Denti/Gole Puleggia | 6 |
| Altezza Puleggia | 23 |
| Posizione Attacco | 57.4 |
| Diametro Girante | Ø81.8 |
| N° Alette Girante | 9 |
| Posizione Girante | 3.75 |

MERCEDES-BENZ
Vito II (W639) - Viano

| | | | | |
|-----------------|-----|---------|---|-----------|
| 110 CDI | 70 | 09/10 → | D | OM651.940 |
| 113 CDI | 100 | 09/10 → | D | OM651.940 |
| 113 CDI 4x4 | 100 | 09/10 → | D | OM651.940 |
| 116 CDI | 120 | 09/10 → | D | OM651.940 |
| 116 CDI 4x4 | 120 | 09/10 → | D | OM651.940 |
| CDI 2.0 | 100 | 07/10 → | D | OM651.940 |
| CDI 2.0 4-matic | 100 | 07/10 → | D | OM651.940 |
| CDI 2.2 | 120 | 07/10 → | D | OM651.940 |
| CDI 2.2 4-matic | 120 | 07/10 → | D | OM651.940 |

84048
NEW
350984048000

PULEGGIA

| | |
|----------------------------|--------|
| Diametro Puleggia | Ø110.3 |
| Numero Denti/Gole Puleggia | 6 |
| Altezza Puleggia | 23 |
| Posizione Attacco | 57.4 |
| Diametro Girante | Ø81.8 |
| N° Alette Girante | 9 |
| Posizione Girante | 3.75 |

MERCEDES-BENZ
Vito II (W639) - Viano

| | | | | | |
|-----------------|-----|---------|---|-----------|------------|
| 110 CDI | 70 | 09/10 → | D | OM651.940 | Potenziata |
| 113 CDI | 100 | 09/10 → | D | OM651.940 | Potenziata |
| 113 CDI 4x4 | 100 | 09/10 → | D | OM651.940 | Potenziata |
| 116 CDI | 120 | 09/10 → | D | OM651.940 | Potenziata |
| 116 CDI 4x4 | 120 | 09/10 → | D | OM651.940 | Potenziata |
| CDI 2.0 | 100 | 07/10 → | D | OM651.940 | Potenziata |
| CDI 2.0 4-matic | 100 | 07/10 → | D | OM651.940 | Potenziata |
| CDI 2.2 | 120 | 07/10 → | D | OM651.940 | Potenziata |
| CDI 2.2 4-matic | 120 | 07/10 → | D | OM651.940 | Potenziata |

84049
NEW
350984049000

PULEGGIA

| | |
|-------------------|-------|
| Diametro Puleggia | Ø90.5 |
| Altezza Puleggia | 27 |
| Posizione Attacco | 56.5 |
| Diametro Girante | Ø62 |
| N° Alette Girante | 6 |
| Posizione Girante | 22.6 |

KW

BMW
2 Coupè (F22, F87), Cabrio (F23), Active Tourer (F45), Gran Tourer (F46)

| | | | | |
|--------------|-----|---------|---|-------------------|
| 216 i | 75 | 11/15 → | B | B38A15A |
| 218 i | 100 | 03/15 → | B | B38A15A |
| | 100 | 09/14 → | B | B38A15A, B38A15MO |
| 220 i | 120 | 11/14 → | B | B48A20A |
| | 141 | 11/14 → | B | B48A20A |
| 225 i | 170 | 09/14 → | B | B48A20B |
| 225 i xDrive | 170 | 11/14 → | B | B48A20B |

X1 II (F48)

| | | | | |
|-------------|-----|---------|---|---------|
| sDrive 18 i | 100 | 11/15 → | B | B38A15A |
| sDrive 20 i | 141 | 09/15 → | B | B48A20A |
| xDrive 20 i | 141 | 09/15 → | B | B48A20A |
| xDrive 25 i | 170 | 09/15 → | B | B48A20B |

MINI
Mini III (F54, F55, F56, F57)

| | | | | |
|-------------------|-----|---------|---|------------------|
| Cooper | 100 | 07/14 → | B | B38A15A |
| Cooper S | 141 | 07/14 → | B | B46A20A, B48A20A |
| | 141 | 11/15 → | B | B48A20A |
| John Cooper Works | 170 | 03/15 → | B | B48A20B |
| One | 75 | 11/14 → | B | B38A12A |
| | 75 | 11/15 → | B | B38A15A |
| One First | 55 | 06/14 → | B | B38A12A |

84050
NEW
350984050000

PULEGGIA

| | |
|-------------------|-------|
| Diametro Puleggia | Ø90.5 |
| Altezza Puleggia | 27 |
| Posizione Attacco | 56.5 |
| Diametro Girante | Ø62.5 |
| N° Alette Girante | 7 |
| Posizione Girante | 22.9 |

KW

MINI
Mini III (F54, F55, F56, F57)

| | | | | |
|----------|----|---------|---|---------|
| Cooper D | 85 | 07/14 → | D | B37C15A |
| One D | 70 | 11/14 → | D | B37C15A |

84051
NEW
84051

PULEGGIA

| | |
|-------------------|-------|
| Diametro Puleggia | Ø90.5 |
| Altezza Puleggia | 27 |
| Posizione Attacco | 56.5 |
| Diametro Girante | Ø65 |
| N° Alette Girante | 7 |
| Posizione Girante | 23.5 |

KW

BMW
2 Coupè (F22, F87), Cabrio (F23), Active Tourer (F45), Gran Tourer (F46)

| | | | | |
|--------------|-----|---------|---|---------|
| 218 d | 100 | 03/15 → | D | B47C20A |
| | 100 | 03/15 → | D | B47C20A |
| 218 d xDrive | 100 | 11/15 → | D | |
| | 110 | 11/15 → | D | B47C20A |
| 220 d | 140 | 07/15 → | D | B47C20A |

MINI
Mini III (F54, F55, F56, F57)

| | | | | |
|-----------|-----|---------|---|---------|
| Cooper SD | 125 | 07/14 → | D | B47C20A |
|-----------|-----|---------|---|---------|

84052
NEW
350984052000

PULEGGIA

| | |
|----------------------------|-------|
| Diametro Puleggia | Ø56 |
| Numero Denti/Gole Puleggia | 19 |
| Altezza Puleggia | 33.5 |
| Posizione Attacco | 52 |
| Diametro Girante | Ø59.5 |
| N° Alette Girante | 8 |
| Posizione Girante | 48 |

KW

SEAT
Ibiza IV

| | | | | | |
|---------|----|---------------|---|-----|----------------|
| 1.9 SDI | 47 | 02/02 → 12/05 | D | ASY | → T: 6L3000000 |
|---------|----|---------------|---|-----|----------------|

SKODA
Fabia I, Station Wagon, Van

| | | | | | |
|---------|----|---------------|---|-----|-----------------|
| 1.9 SDI | 47 | 12/99 → 03/08 | D | ASY | → T: 6Y3X628012 |
|---------|----|---------------|---|-----|-----------------|

VOLKSWAGEN
Polo V (9N)

| | | | | | |
|---------|----|---------------|---|-----|----------------|
| 1.9 SDI | 47 | 10/01 → 11/09 | D | ASY | → T: 9N2100000 |
|---------|----|---------------|---|-----|----------------|

84053
NEW
350984053000

PULEGGIA

| | |
|----------------------------|---------|
| Diametro Puleggia | Ø113.65 |
| Numero Denti/Gole Puleggia | 5 |
| Altezza Puleggia | 19.2 |
| Posizione Attacco | 64.75 |
| Diametro Girante | Ø54.4 |
| N° Alette Girante | 6 |
| Posizione Girante | 17.8 |

KW

OPEL
Astra K, Sports Tourer

| | | | | |
|-----|----|---------|---|-------|
| 1.4 | 74 | 06/15 → | B | B14XE |
|-----|----|---------|---|-------|

Karl

| | | | | |
|-----|----|---------|---|-------|
| 1.0 | 52 | 06/15 → | B | B10XL |
| | 55 | 01/15 → | B | B10XE |

| | | | | |
|---------|----|---------|--|-------|
| 1.0 LPG | 54 | 02/15 → | | B10XE |
|---------|----|---------|--|-------|

VAUXHALL
ASTRA

| | | | | |
|-----|----|---------|---|-------|
| 1.4 | 74 | 07/15 → | B | B14XE |
|-----|----|---------|---|-------|

VIVA

| | | | | |
|-----|----|---------|---|-------|
| 1.0 | 55 | 01/15 → | B | B10XE |
|-----|----|---------|---|-------|

84054
NEW
350984054000

PULEGGIA

| | |
|-------------------|------|
| Diametro Puleggia | Ø90 |
| Altezza Puleggia | 37 |
| Posizione Attacco | 52 |
| Diametro Girante | Ø45 |
| N° Alette Girante | 6 |
| Posizione Girante | 22.5 |

KW

CITROËN
C 1 II

| | | | | |
|------------|----|---------|---|--------|
| 1.0 VTi 68 | 51 | 04/14 → | B | 1KR-FE |
|------------|----|---------|---|--------|

PEUGEOT
108

| | | | | |
|---------|----|---------|---|--------|
| 1.0 VTi | 51 | 05/14 → | B | 1KR-FE |
|---------|----|---------|---|--------|

TOYOTA
Aygo II

| | | | | |
|-----|----|---------|---|--------|
| 1.0 | 51 | 05/14 → | B | 1KR-FE |
|-----|----|---------|---|--------|

| | | | | |
|-----|----|---------|---|-----|
| 1.2 | 60 | 05/14 → | B | 1PP |
|-----|----|---------|---|-----|

84057
NEW
350984057000

FLANGIA

| | |
|-----------------------------------|-------|
| Numero Fori Flangia | 4 |
| Numero Fori Flangia (Serie 2) | 4 |
| Dimensione Fori Flangia | M6×1 |
| Dimensione Fori Flangia (Serie 2) | Ø13 |
| Posizione Attacco | 44 |
| Diametro Centraggio | Ø47.2 |
| Diametro Girante | Ø71.5 |
| N° Alette Girante | 6 |
| Posizione Girante | 26 |

KW

ALFA ROMEO
159, Sportwagon

| | | | | |
|---------|-----|---------------|---|----------|
| 3.2 JTS | 191 | 02/08 → 11/11 | B | 939A.000 |
|---------|-----|---------------|---|----------|

| | | | | |
|------------|-----|---------------|---|----------|
| 3.2 JTS Q4 | 191 | 12/05 → 11/11 | B | 939A.000 |
|------------|-----|---------------|---|----------|

Brera

| | | | | |
|---------|-----|---------------|---|----------|
| 3.2 JTS | 191 | 03/08 → 06/10 | B | 939A.000 |
|---------|-----|---------------|---|----------|

| | | | | |
|------------|-----|---------------|---|----------|
| 3.2 JTS Q4 | 191 | 01/06 → 06/10 | B | 939A.000 |
|------------|-----|---------------|---|----------|

Spider V

| | | | | |
|---------|-----|---------------|---|----------|
| 3.2 JTS | 191 | 03/08 → 06/10 | B | 939A.000 |
|---------|-----|---------------|---|----------|

| | | | | |
|------------|-----|---------------|---|----------|
| 3.2 JTS Q4 | 191 | 03/06 → 06/10 | B | 939A.000 |
|------------|-----|---------------|---|----------|

CADILLAC
CTS I

| | | | | |
|-----|-----|---------------|---|-----|
| 2.8 | 158 | 03/05 → 09/07 | B | LP1 |
|-----|-----|---------------|---|-----|

| | | | | |
|-----|-----|---------------|---|-----|
| 3.6 | 189 | 03/05 → 09/07 | B | LY7 |
|-----|-----|---------------|---|-----|

84057 NEW **350984057000**

CADILLAC
CTS II, Station Wagon, Coupé

| | | | | |
|---------|-----|---------|---|-----|
| 2.8 | 155 | 01/08 → | B | LP1 |
| 3.6 | 229 | 01/08 → | B | LLT |
| 3.6 AWD | 229 | 01/08 → | B | LLT |

SRX I

| | | | | |
|---------|-----|---------------|---|-----|
| 3.6 AWD | 190 | 07/04 → 12/08 | B | LY7 |
|---------|-----|---------------|---|-----|

STS

| | | | | |
|-----|-----|---------------|---|-----|
| 3.6 | 189 | 05/05 → 12/07 | B | LY7 |
|-----|-----|---------------|---|-----|

CHEVROLET
Captiva

| | | | | |
|---------|-----|---------|---|------|
| 3.2 4WD | 169 | 06/06 → | B | 10HM |
|---------|-----|---------|---|------|

OPEL
Antara

| | | | | |
|--------|-----|---------|---|-----------------|
| 3.2 V6 | 167 | 03/07 → | B | 10HM, Z32SEE |
|--------|-----|---------|---|-----------------|

Insignia, Station Wagon

| | | | | |
|---------------------|-----|---------|---|--------|
| 2.8 V6 Turbo 4x4 | 191 | 07/08 → | B | A28NET |
|---------------------|-----|---------|---|--------|

| | | | | |
|----------------------------|-----|---------|---|--------|
| 2.8 V6 Turbo OPC 4x4 | 239 | 07/09 → | B | A28NER |
|----------------------------|-----|---------|---|--------|

Signum

| | | | | |
|--------------|-----|---------|---|--------|
| 2.8 V6 Turbo | 169 | 09/05 → | B | Z28NEL |
| | 184 | 01/06 → | B | Z28NET |

Vectra C, Station Wagon

| | | | | |
|--------------|-----|---------|---|--------|
| 2.8 V6 Turbo | 169 | 08/05 → | B | Z28NEL |
| | 184 | 08/06 → | B | Z28NET |
| | 188 | 08/05 → | B | Z28NET |
| | 206 | 08/06 → | B | Z28NET |

SAAB
9-3 II, Station Wagon, Cabrio

| | | | | |
|-----------------|-----|---------|---|-------|
| 2.8 Turbo V6 | 184 | 03/05 → | B | LP9 |
| | 188 | 12/07 → | B | B284L |
| | 203 | 04/08 → | B | B284L |
| | 203 | 02/09 → | B | B284R |
| | 206 | 02/09 → | B | B284R |

| | | | | |
|---------------------|-----|---------|---|-------|
| 2.8 Turbo V6 XWD | 206 | 05/08 → | B | B284R |
|---------------------|-----|---------|---|-------|

9-5 II, Station Wagon

| | | | | |
|---------------------|-----|---------------|---|--------|
| 2.8 Turbo V6 XWD | 221 | 05/10 → 01/12 | B | A28NER |
|---------------------|-----|---------------|---|--------|

84057 NEW **350984057000**

VAUXHALL
SIGNUM

| | | | | |
|--------------|-----|---------------|---|--------|
| 2.8 V6 Turbo | 169 | 07/05 → 05/08 | B | Z28NEL |
|--------------|-----|---------------|---|--------|

VECTRA

| | | | | |
|-----------------|-----|---------------|---|--------|
| 2.8 V6 Turbo | 169 | 08/05 → 07/08 | B | Z28NEL |
| | 184 | 08/06 → 07/08 | B | Z28NET |
| | 188 | 08/05 → 07/08 | B | Z28NET |

84058 NEW **350984058000**

FLANGIA

| | |
|-------------------------|-------|
| Numero Fori Flangia | 3 |
| Dimensione Fori Flangia | M6x1 |
| Posizione Attacco | 57 |
| Diametro Centraggio | Ø23.9 |
| Diametro Girante | Ø61.8 |
| N° Alette Girante | 7 |
| Posizione Girante | 25.7 |

HYUNDAI
Accent III

| | | | | |
|-----------------|----|---------------|---|------|
| 1.5 CRDi GLS | 81 | 11/05 → 11/10 | D | D4FA |
|-----------------|----|---------------|---|------|

Getz

| | | | | |
|-----------------|----|---------------|---|------|
| 1.5 CRDi | 65 | 08/05 → 06/09 | D | D4FA |
| 1.5 CRDi GLS | 75 | 07/04 → 08/05 | D | D4FA |
| | 81 | 08/05 → 06/09 | D | D4FA |

i30 I, Station Wagon

| | | | | |
|----------|----|---------------|---|------|
| 1.6 CRDi | 66 | 10/07 → 11/11 | D | D4FB |
| | 85 | 10/07 → 11/11 | D | D4FB |
| | 94 | 01/10 → 11/11 | D | D4FB |

Matrix

| | | | | |
|-----------------|----|---------------|---|------|
| 1.5 CRDi | 75 | 12/04 → 08/10 | D | D4FA |
| 1.5 CRDi VGT | 81 | 08/05 → 08/10 | D | D4FA |

KIA
Cee'd I, Station Wagon

| | | | | |
|-----------------|----|---------------|---|--------|
| 1.6 CRDi 115 | 85 | 12/06 → 12/12 | D | D4FB |
| 1.6 CRDi 90 | 66 | 12/06 → 12/12 | D | D4FB-L |

Cerato I

| | | | | |
|----------|----|---------|---|------|
| 1.5 CRDi | 75 | 07/05 → | D | D4FA |
| 1.6 CRDi | 85 | 06/05 → | D | D4FB |

Picanto I

| | | | | |
|----------|----|---------|---|------|
| 1.1 CRDi | 55 | 11/05 → | D | D3FA |
|----------|----|---------|---|------|

84058 **NEW** 350984058000



KIA

Pride I, Van

| | | | | | |
|-------------|----|---------|---|------|--|
| 1.5 CRDi LX | 81 | 03/05 → | D | D4FA | |
|-------------|----|---------|---|------|--|

Pro Cee'd I

| | | | | | |
|--------------|----|---------------|---|------|--|
| 1.6 CRDi 115 | 85 | 02/08 → 09/12 | D | D4FB | |
|--------------|----|---------------|---|------|--|

| | | | | | |
|-------------|----|---------------|---|--------|--|
| 1.6 CRDi 90 | 66 | 02/08 → 09/12 | D | D4FB-L | |
|-------------|----|---------------|---|--------|--|

Rio II

| | | | | | |
|----------|----|---------|---|------|-----------|
| 1.5 CRDi | 81 | 03/05 → | D | D4FA | → 04-2008 |
|----------|----|---------|---|------|-----------|

84059 **NEW** 350984059000



PULEGGIA
 Diametro Puleggia Ø59.2
 Numero Denti/Gole Puleggia 20
 Altezza Puleggia 30
 Posizione Attacco 59.4
 Diametro Girante Ø79.5
 N° Alette Girante 6
 Posizione Girante 27.8



HYUNDAI

Grandeur III

| | | | | | |
|----------|-----|---------|---|------|--|
| 2.2 CRDi | 110 | 06/06 → | D | D4EB | |
| | 114 | 06/06 → | D | D4EB | |

i30 I, Station Wagon

| | | | | | |
|----------|-----|---------------|---|------|--|
| 2.0 CRDi | 100 | 10/07 → 11/11 | D | D4EA | |
| | 103 | 10/07 → 11/11 | D | D4EA | |

Santa Fé I

| | | | | | |
|----------|-----|---------------|---|------|--|
| 2.2 CRDi | 110 | 10/05 → 03/06 | D | D4EB | |
|----------|-----|---------------|---|------|--|

Santa Fé II

| | | | | | |
|----------|-----|---------|---|------|--|
| 2.2 CRDi | 102 | 03/06 → | D | D4EB | |
| | 114 | 03/06 → | D | D4EB | |
| | 145 | 01/09 → | D | D4HB | |

| | | | | | |
|--------------|-----|---------------|---|------|--|
| 2.2 CRDi 4x4 | 102 | 03/06 → | D | D4EB | |
| | 110 | 10/05 → 03/06 | D | D4EB | |
| | 114 | 03/06 → | D | D4EB | |
| | 145 | 01/09 → | D | D4HB | |

| | | | | | |
|--------------|-----|---------|---|------|--|
| 2.2 CRDi GLS | 110 | 03/06 → | D | D4EB | |
|--------------|-----|---------|---|------|--|

| | | | | | |
|------------------|-----|---------|---|------|--|
| 2.2 CRDi GLS 4x4 | 110 | 03/06 → | D | D4EB | |
|------------------|-----|---------|---|------|--|

Sonata V

| | | | | | |
|----------|-----|---------------|---|------|--|
| 2.0 CRDi | 100 | 02/06 → 12/10 | D | D4EA | |
| | 103 | 02/06 → 12/10 | D | D4EA | |
| | 110 | 03/09 → 12/10 | D | D4EA | |

84059 **NEW** 350984059000



HYUNDAI

Tucson I

| | | | | | |
|----------|-----|---------------|---|--------|-----------|
| 2.0 CRDi | 83 | 08/04 → 03/10 | D | D4EA | 01-2006 → |
| | 88 | 01/07 → 03/10 | D | D4EA | |
| | 100 | 01/06 → 03/10 | D | D4EA | |
| | 103 | 01/06 → 03/10 | D | D4EA-V | |

| | | | | | |
|-----------------------------|-----|---------------|---|----------------|-----------|
| 2.0 CRDi Trazione integrale | 83 | 08/04 → 03/10 | D | D4EA | 01-2006 → |
| | 88 | 01/07 → 03/10 | D | D4EA | |
| | 100 | 01/06 → 03/10 | D | D4EA | |
| | 103 | 01/06 → 03/10 | D | D4EA-F, D4EA-V | |

| | | | | |
|-----|---------------|---|------|--|
| 110 | 01/09 → 03/10 | D | D4EA | |
|-----|---------------|---|------|--|

KIA

Carens II

| | | | | | |
|----------|-----|---------|---|------|--|
| 2.0 CRDi | 103 | 11/05 → | D | D4EA | |
|----------|-----|---------|---|------|--|

Carens III

| | | | | | |
|--------------|----|---------|---|------|--|
| 2.0 CRDi 115 | 85 | 05/07 → | D | D4EA | |
|--------------|----|---------|---|------|--|

| | | | | | |
|--------------|-----|---------|---|------|--|
| 2.0 CRDi 135 | 100 | 08/09 → | D | D4EA | |
|--------------|-----|---------|---|------|--|

| | | | | | |
|--------------|-----|---------|---|------|--|
| 2.0 CRDi 140 | 103 | 09/06 → | D | D4EA | |
|--------------|-----|---------|---|------|--|

Cee'd I, Station Wagon

| | | | | | |
|----------|-----|---------------|---|------|--|
| 2.0 CRDi | 100 | 06/07 → 12/12 | D | D4EA | |
|----------|-----|---------------|---|------|--|

Cerato I

| | | | | | |
|----------|----|---------|---|------|-----------|
| 2.0 CRDi | 83 | 04/04 → | D | D4EA | 06-2005 → |
|----------|----|---------|---|------|-----------|

Magentis II

| | | | | | |
|----------|-----|---------------|---|------|--|
| 2.0 CRDi | 100 | 11/05 → 12/08 | D | D4EA | |
| | 103 | 04/06 → | D | D4EA | |
| | 110 | 04/06 → | D | D4EA | |

Pro Cee'd I

| | | | | | |
|--------------|-----|---------------|---|--------|--|
| 2.0 CRDi 140 | 103 | 02/08 → 09/12 | D | D4EA-F | |
|--------------|-----|---------------|---|--------|--|

Sportage II

| | | | | | |
|----------|-----|---------|---|--------|--|
| 2.0 CRDi | 83 | 02/05 → | D | D4EA | |
| | 100 | 01/06 → | D | D4EA | |
| | 103 | 01/06 → | D | D4EA-V | |
| | 110 | 09/08 → | D | D4EA | |

| | | | | | |
|--------------|-----|---------|---|----------------|--|
| 2.0 CRDi 4WD | 83 | 09/04 → | D | D4EA | |
| | 100 | 01/06 → | D | D4EA | |
| | 103 | 01/06 → | D | D4EA-F, D4EA-V | |
| | 110 | 09/08 → | D | D4EA | |

84060
NEW
350984060000

PULEGGIA

| | |
|-------------------|--------|
| Diametro Puleggia | Ø103.3 |
| Altezza Puleggia | 26 |
| Posizione Attacco | 55.8 |
| Diametro Girante | Ø58.6 |
| N° Alette Girante | 6 |
| Posizione Girante | 10.6 |

KW

MAZDA
2 II, Saloon

| | | | | |
|------------|----|---------------|----|-----------------|
| 1.3 | 55 | 10/07 → 06/15 | B | ZJ-VE |
| | 63 | 10/07 → 06/15 | B | ZJ-VE |
| 1.3 BiFuel | 55 | 05/11 → 11/14 | BF | ZJ46 |
| | 62 | 05/11 → 11/14 | BF | ZJ46 |
| 1.3 MZR | 62 | 01/10 → 06/15 | B | ZJ-VE |
| 1.5 | 76 | 10/07 → 06/15 | B | ZY-DE, ZY-VE |
| 1.5 MZR | 75 | 06/11 → 06/15 | B | ZY05, ZY66 |

3 I, Saloon

| | | | | |
|-----|----|---------------|---|-------|
| 1.4 | 62 | 10/03 → 06/09 | B | ZJ-VE |
| | 59 | 02/04 → 06/09 | B | FXJA |
| 1.6 | 77 | 10/03 → 06/09 | B | B6ZE |
| | 77 | 02/04 → 06/09 | B | Z6 |

3 II, Saloon

| | | | | |
|---------|----|---------|---|----|
| 1.6 MZR | 77 | 06/09 → | B | Z6 |
|---------|----|---------|---|----|

3 III, Saloon

| | | | | |
|-----|----|---------|---|------------|
| 1.6 | 77 | 09/13 → | B | Z6Y1 |
| | 77 | 09/13 → | B | Z6Y1, Z6Y3 |

84061
NEW
350984061000

PULEGGIA

| | |
|-------------------|------|
| Diametro Puleggia | Ø97 |
| Altezza Puleggia | 25.5 |
| Posizione Attacco | 71.5 |
| Diametro Girante | Ø47 |
| N° Alette Girante | 8 |
| Posizione Girante | 19.5 |

KW

NISSAN
Prima III, Hatchback, Station Wagon

| | | | | |
|-----|-----|---------|---|--------|
| 2.0 | 103 | 03/02 → | B | QR20DE |
|-----|-----|---------|---|--------|

84061
NEW
350984061000

KW

NISSAN
X-Trail I

| | | | | |
|---------|-----|---------------|---|---------|
| 2.0 | 103 | 07/01 → 01/13 | B | QR20DE |
| | 110 | 09/01 → 01/13 | B | QR20DE |
| 2.0 4x4 | 103 | 07/01 → 01/13 | B | QR20DE |
| | 110 | 09/01 → 01/13 | B | QR20DE |
| 2.5 4x4 | 206 | 06/01 → 01/13 | B | SR20VET |
| | 121 | 09/02 → 01/13 | B | QR25DE |
| | 132 | 11/02 → 01/13 | B | QR25DE |

X-Trail II

| | | | | |
|---------|-----|---------------|---|--------|
| 2.5 4x4 | 124 | 06/07 → 11/13 | B | QR25DE |
|---------|-----|---------------|---|--------|

RENAULT
Koleos

| | | | | |
|---------|-----|---------|---|------------------------------|
| 2.5 | 126 | 09/08 → | B | 2TR700, 2TR702, 2TR703 |
| 2.5 4x4 | 126 | 09/08 → | B | 2TR700, 2TR702, 2TR703 |

84062
NEW
350984062000

PULEGGIA

| | |
|----------------------------|-------|
| Diametro Puleggia | Ø43.4 |
| Numero Denti/Gole Puleggia | 28 |
| Altezza Puleggia | 11 |
| Posizione Attacco | 34.4 |
| Diametro Girante | Ø63 |
| N° Alette Girante | 6 |
| Posizione Girante | 18.35 |

KW

AUDI
A1, Sportback

| | | | | |
|----------|-----|---------|---|------------|
| 1.4 TFSI | 92 | 11/14 → | B | CZCA, CZDB |
| | 103 | 04/12 → | B | CPTA |
| | 110 | 11/14 → | B | CZEA |

A3 III, Sportback, Cabriolet

| | | | | |
|-----------------|-----|---------|---|---------------|
| 1.2 TFSI | 77 | 02/13 → | B | CJZA |
| | 81 | 05/14 → | B | CYVB |
| 1.4 TFSI | 85 | 02/16 → | B | CZCC |
| | 90 | 04/12 → | B | CMBA, CXSA |
| | 92 | 05/14 → | B | CXSB, CZCA |
| | 103 | 03/13 → | B | CPTA |
| | 110 | 05/14 → | B | CZEA |
| 1.4 TFSI e-tron | 110 | 05/14 → | | CUKB, CXUA |

84062
NEW
350984062000

KW

AUDI
A3 III, Sportback, Cabriolet

| | | | | |
|-----------------|----|---------|--|------|
| 1.4 TFSI g-tron | 81 | 11/13 → | | CPWA |
|-----------------|----|---------|--|------|

A4 V, Avant, Allroad

| | | | | |
|----------|-----|---------|---|------|
| 1.4 TFSI | 110 | 08/15 → | B | CVNA |
|----------|-----|---------|---|------|

Q3

| | | | | |
|----------|-----|---------|---|------------------|
| 1.4 TFSI | 110 | 10/13 → | B | CHPB, CZDA, CZEA |
|----------|-----|---------|---|------------------|

SEAT
Alhambra II

| | | | | |
|---------|-----|---------|---|------|
| 1.4 TSI | 110 | 05/15 → | B | CZDA |
|---------|-----|---------|---|------|

Ibiza V

| | | | | |
|---------|-----|---------|---|------|
| 1.2 TSI | 66 | 05/15 → | B | CJZC |
| | 81 | 09/15 → | B | CJZD |
| 1.4 TSI | 103 | 10/13 → | B | CPTA |
| | 110 | 11/15 → | B | CZEA |

Leon III

| | | | | |
|---------|-----|---------|---|------------|
| 1.0 TSI | 85 | 05/15 → | B | CHZD |
| 1.2 TSI | 63 | 12/12 → | B | CJZB, CYVA |
| | 77 | 01/13 → | B | CJZA |
| | 81 | 04/14 → | B | CYVB |
| 1.4 TGI | 81 | 02/13 → | | CPWA |
| 1.4 TSI | 90 | 11/12 → | B | CMBA, CXSA |
| | 92 | 05/14 → | B | CZCA |
| | 103 | 09/12 → | B | CHPA, CPTA |
| | 110 | 05/14 → | B | CZEA |

SKODA
Fabia III, Station Wagon

| | | | | |
|---------|----|---------|---|------|
| 1.2 TSI | 66 | 08/14 → | B | CJZC |
| | 81 | 08/14 → | B | CJZD |

Octavia III, Station Wagon

| | | | | |
|---------------|-----|---------|---|------------|
| 1.2 TSI | 63 | 11/12 → | B | CJZB |
| | 77 | 11/12 → | B | CJZA |
| | 81 | 05/15 → | B | CYVB |
| 1.4 TSI | 103 | 11/12 → | B | CHPA |
| | 110 | 08/14 → | B | CHPB, CZDA |
| 1.4 TSI G-TEC | 81 | 11/13 → | | CPWA |
| 1.6 | 81 | 01/14 → | B | CWVA |

Rapid II

| | | | | |
|---------|----|---------|---|------|
| 1.4 TSI | 92 | 05/15 → | B | CZCA |
|---------|----|---------|---|------|

Superb

| | | | | |
|-------------|-----|---------|---|------------|
| 1.4 TSI | 92 | 03/15 → | B | CZCA |
| | 110 | 03/15 → | B | CZDA, CZEA |
| 1.4 TSI 4x4 | 110 | 03/15 → | B | CZDA, CZEA |

84062
NEW
350984062000

KW

SKODA
Yeti

| | | | | |
|-------------|-----|---------|---|------|
| 1.2 TSI | 81 | 05/15 → | B | CYVB |
| 1.4 TSI | 92 | 05/15 → | B | CZCA |
| 1.4 TSI 4x4 | 110 | 05/15 → | B | CZDA |
| 1.6 | 81 | 04/14 → | B | CWVA |

VOLKSWAGEN
Golf VI, Variant, Cabrio

| | | | | |
|-------------|-----|---------|---|------------|
| 1.2 TSI 16V | 77 | 11/13 → | B | CYVD |
| 1.4 TSI | 92 | 11/13 → | B | CXSB, CZCA |
| | 110 | 11/13 → | B | CHPB, CZDA |

Golf VII, Variant, Cabrio, AllTrack

| | | | | |
|-------------------|-----|---------|---|------------------|
| 1.0 TSI | 85 | 05/15 → | B | CHZD |
| 1.2 TSI | 63 | 08/12 → | B | CJZB, CYVA |
| | 63 | 05/14 → | B | CYVA |
| | 77 | 11/12 → | B | CJZA |
| | 81 | 04/14 → | B | CYVB |
| 1.4 GTE Hybrid | 110 | 05/14 → | | CUKB |
| 1.4 TGI CNG | 81 | 06/13 → | | CPWA, CZBA |
| 1.4 TSI | 90 | 11/12 → | B | CMBA, CPVA, CXSA |
| | 90 | 05/13 → | B | CPVA, CXSA |
| | 92 | 04/14 → | B | CPVB, CZCA |
| | 103 | 05/13 → | B | CHPA |
| | 103 | 11/12 → | B | CHPA, CPTA |
| | 110 | 05/14 → | B | CHPB, CZDA |
| | 110 | 05/14 → | B | CHPB, CZDA, CZEA |
| | 110 | 02/14 → | B | CZDA |
| 1.4 TSI MultiFuel | 90 | 04/13 → | | CPVA |
| | 92 | 04/14 → | | CPVB |
| 1.6 | 81 | 05/14 → | B | CWVA |

Passat VIII, Variant, AllTrack

| | | | | |
|-----------------|-----|---------|---|------------|
| 1.4 GTE Hybrid | 115 | 06/15 → | | CUKC |
| 1.4 TSI | 92 | 11/14 → | B | CZCA |
| | 110 | 11/14 → | B | CZDA, CZEA |
| 1.4 TSI 4motion | 110 | 02/15 → | B | CZEA |

Polo VI (6R)

| | | | | |
|-------------|----|---------|---|------|
| 1.0 TSI | 70 | 11/14 → | B | CHZB |
| 1.2 TSI | 81 | 01/14 → | B | CJZD |
| 1.2 TSI 16V | 66 | 02/14 → | B | CJZC |

84062 **NEW** 350984062000

VOLKSWAGEN
Polo VI (6R)

| | | | | |
|---------|-----|---------|---|------|
| 1.4 TSI | 103 | 10/12 → | B | CPTA |
| | 110 | 05/14 → | B | CZEA |
| 1.6 | 81 | 07/14 → | B | CWVA |

Sharan II

| | | | | |
|---------|-----|---------|---|------|
| 1.4 TSI | 110 | 05/15 → | B | CZDA |
|---------|-----|---------|---|------|

Tiguan I

| | | | | |
|---------|-----|---------|---|------|
| 1.4 TSI | 92 | 05/15 → | B | CZDB |
| | 110 | 05/15 → | B | CZDA |

Touran II

| | | | | |
|---------|-----|---------|---|------|
| 1.2 TSI | 81 | 05/15 → | B | CYVB |
| 1.4 TSI | 110 | 05/15 → | B | CZDA |

84063 **NEW** 350984063000

FLANGIA

| | |
|-------------------------|-------|
| Numero Fori Flangia | 3 |
| Dimensione Fori Flangia | M6X1 |
| Posizione Attacco | 57 |
| Diametro Centraggio | Ø23.8 |
| Diametro Girante | Ø62.4 |
| N° Alette Girante | 7 |
| Posizione Girante | 25.65 |

HYUNDAI
i20 I

| | | | | |
|----------|----|---------|---|------|
| 1.1 CRDi | 55 | 03/12 → | D | D3FA |
| 1.6 CRDi | 94 | 01/09 → | D | D4FB |

i30 II, Station Wagon, Coupé

| | | | | |
|----------|----|---------|---|---------|
| 1.4 CRDi | 66 | 12/11 → | D | D4FC |
| | 81 | 12/11 → | D | D4FB |
| 1.6 CRDi | 94 | 12/11 → | D | D4FB |
| | 94 | 06/12 → | D | D4FB-5P |

KIA
Cee'd II, Station Wagon

| | | | | |
|--------------|----|---------|---|------|
| 1.4 CRDi 90 | 66 | 05/12 → | D | D4FC |
| 1.6 CRDi 110 | 81 | 05/12 → | D | D4FB |
| | | 05/12 → | D | D4FB |
| 1.6 CRDi 128 | 94 | 05/12 → | D | D4FB |

Pro Cee'd II

| | | | | |
|--------------|----|---------|---|------|
| 1.4 CRDi 90 | 66 | 03/13 → | D | D4FC |
| 1.6 CRDi 110 | 81 | 03/13 → | D | D4FB |

84063 **NEW** 350984063000

KIA
Pro Cee'd II

| | | | | |
|--------------|----|---------|---|------|
| 1.6 CRDi 128 | 94 | 03/13 → | D | D4FB |
|--------------|----|---------|---|------|

Rio II

| | | | | |
|----------|----|---------|---|------|
| 1.5 CRDi | 65 | 06/08 → | D | D4FA |
|----------|----|---------|---|------|

Rio III

| | | | | |
|----------|----|---------|---|------|
| 1.1 CRDi | 55 | 09/11 → | D | D3FA |
| 1.4 CRDi | 66 | 09/11 → | D | D4FC |

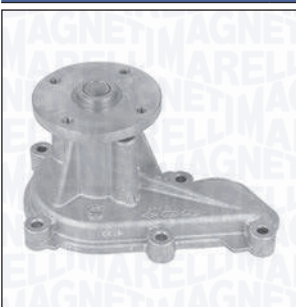
84064 **NEW** 350984064000

FLANGIA

| | |
|-------------------------|-------|
| Numero Fori Flangia | 4 |
| Dimensione Fori Flangia | M6X1 |
| Posizione Attacco | 78 |
| Diametro Centraggio | Ø24 |
| Diametro Girante | Ø57.2 |
| N° Alette Girante | 6 |
| Posizione Girante | 7.2 |

HYUNDAI
Elantra III

| | | | | |
|-----|-----|---------|---|--------|
| 1.8 | 110 | 09/10 → | B | G4NB-B |
|-----|-----|---------|---|--------|

i40

| | | | | |
|---------|-----|---------|---|------|
| 2.0 GDI | 130 | 07/11 → | B | G4NC |
| | 131 | 03/12 → | B | G4NC |

KIA
Carens IV

| | | | | |
|---------|-----|---------|---|------|
| 2.0 GDi | 122 | 03/13 → | B | G4NC |
| | 130 | 03/13 → | B | G4NC |

Sportage III

| | | | | |
|--------------|-----|---------|---|------|
| 2.0 CVVT | 120 | 07/10 → | B | G4KD |
| | 122 | 07/10 → | B | G4KD |
| 2.0 CVVT AWD | 120 | 07/10 → | B | G4KD |
| 2.0 GDI | 122 | 02/14 → | B | G4NC |
| 2.0 GDI AWD | 122 | 02/14 → | B | G4NC |

84065

NEW

350984065000



FLANGIA

| | |
|-------------------------|-------|
| Numero Fori Flangia | 3 |
| Dimensione Fori Flangia | M6X1 |
| Posizione Attacco | 66 |
| Diametro Centraggio | Ø28 |
| Diametro Girante | Ø50 |
| N° Alette Girante | 7 |
| Posizione Girante | 10.60 |



HONDA

Civic IX, Hatchback, Coupé

| | | | | |
|------------|----|---------|---|-------|
| 1.4 i-VTEC | 73 | 02/12 → | B | L13Z4 |
|------------|----|---------|---|-------|

Civic VIII, Hatchback, Coupé

| | | | | |
|-----|----|---------|---|-------|
| 1.4 | 73 | 10/08 → | B | L13Z1 |
|-----|----|---------|---|-------|

84066

NEW

350984066000



PULEGGIA

| | |
|----------------------------|-------|
| Diametro Puleggia | Ø66 |
| Numero Denti/Gole Puleggia | 3 |
| Altezza Puleggia | 12.3 |
| Posizione Attacco | 39.95 |
| Diametro Girante | Ø49.8 |
| N° Alette Girante | 6 |
| Posizione Girante | 22.34 |



CITROËN

C 1 II

| | | | | |
|------------|----|---------|---|------------|
| 1.2 VTi 82 | 60 | 04/14 → | B | HMT (EB2D) |
|------------|----|---------|---|------------|

C 3 II, Picasso

| | | | | |
|------------|----|---------|---|-----------|
| 1.0 VTi 68 | 50 | 08/12 → | B | ZMZ (EB0) |
|------------|----|---------|---|-----------|

| | | | | |
|-------------|----|---------|---|-------------|
| 1.2 THP 110 | 81 | 10/14 → | B | HNZ (EB2DT) |
|-------------|----|---------|---|-------------|

| | | | | |
|------------|----|---------|---|------------|
| 1.2 VTi 82 | 60 | 06/12 → | B | HMZ (EB2F) |
|------------|----|---------|---|------------|

C 4 Cactus

| | | | | |
|-------------|----|---------|---|-------------|
| 1.2 THP 110 | 81 | 09/14 → | B | HNZ (EB2DT) |
|-------------|----|---------|---|-------------|

| | | | | |
|------------|----|---------|---|------------|
| 1.2 VTi 75 | 55 | 09/14 → | B | HMU (EB2D) |
|------------|----|---------|---|------------|

| | | | | |
|------------|----|---------|---|------------|
| 1.2 VTi 82 | 60 | 09/14 → | B | HMZ (EB2F) |
|------------|----|---------|---|------------|

C 4 II, Picasso, Grand Picasso

| | | | | |
|-------------|----|---------|---|-------------|
| 1.2 THP 110 | 81 | 02/15 → | B | HNZ (EB2DT) |
|-------------|----|---------|---|-------------|

| | | | | |
|-------------|----|---------|---|--------------|
| 1.2 THP 130 | 96 | 04/14 → | B | HNY (EB2DTS) |
|-------------|----|---------|---|--------------|

C-Elysee

| | | | | |
|------------|----|---------|---|------------|
| 1.2 VTi 72 | 53 | 11/12 → | B | HMY (EB2M) |
|------------|----|---------|---|------------|

| | | | | |
|------------|----|---------|---|--|
| 1.2 VTi 82 | 60 | 12/14 → | B | |
|------------|----|---------|---|--|

DS 3, Cabrio

| | | | | |
|-------------|----|---------------|---|-------------|
| 1.2 THP 110 | 81 | 10/14 → 03/15 | B | HNZ (EB2DT) |
|-------------|----|---------------|---|-------------|

| | | | | |
|------------|----|---------------|---|------------|
| 1.2 VTi 82 | 60 | 01/13 → 03/15 | B | HMZ (EB2F) |
|------------|----|---------------|---|------------|

84066

NEW

350984066000



CITROËN

DS 4

| | | | | |
|-------------|----|---------------|---|--------------|
| 1.2 THP 130 | 96 | 07/14 → 07/15 | B | HNY (EB2DTS) |
|-------------|----|---------------|---|--------------|

DS

DS 3

| | | | | |
|-------------|----|---------|---|--|
| 1.2 VTi 110 | 81 | 04/15 → | B | |
|-------------|----|---------|---|--|

| | | | | |
|------------|----|---------|---|--|
| 1.2 VTi 82 | 60 | 04/15 → | B | |
|------------|----|---------|---|--|

DS 4 / DS 4 CROSSBACK

| | | | | |
|---------|----|---------|---|--|
| 1.2 VTi | 96 | 07/15 → | B | |
|---------|----|---------|---|--|

PEUGEOT

108

| | | | | |
|-----|----|---------|---|------------|
| 1.2 | 60 | 05/14 → | B | HMT (EB2D) |
|-----|----|---------|---|------------|

208

| | | | | |
|-----|----|---------|---|-----------|
| 1.0 | 50 | 03/12 → | B | ZMZ (EB0) |
|-----|----|---------|---|-----------|

| | | | | |
|-----|----|---------|---|------------|
| 1.2 | 60 | 03/12 → | B | HMZ (EB2F) |
|-----|----|---------|---|------------|

| | | | | |
|---------|----|---------|---|-------------|
| 1.2 THP | 81 | 01/13 → | B | HNZ (EB2DT) |
|---------|----|---------|---|-------------|

301

| | | | | |
|------------|----|---------|---|------------|
| 1.2 VTi 72 | 53 | 11/12 → | B | HMY (EB2M) |
|------------|----|---------|---|------------|

308 II Station Wagon

| | | | | |
|-------------|----|---------|---|-------------|
| 1.2 THP 110 | 81 | 11/13 → | B | HNZ (EB2DT) |
|-------------|----|---------|---|-------------|

| | | | | |
|-------------|----|---------|---|--------------|
| 1.2 THP 130 | 96 | 11/13 → | B | HNY (EB2DTS) |
|-------------|----|---------|---|--------------|

| | | | | |
|------------|----|---------|---|------------|
| 1.2 VTi 72 | 60 | 09/13 → | B | HMZ (EB2F) |
|------------|----|---------|---|------------|

2008

| | | | | |
|-------------|----|---------|---|-------------|
| 1.2 THP 110 | 81 | 01/15 → | B | HNZ (EB2DT) |
|-------------|----|---------|---|-------------|

| | | | | |
|-------------|----|---------|---|--------------|
| 1.2 THP 130 | 96 | 01/15 → | B | HNY (EB2DTS) |
|-------------|----|---------|---|--------------|

| | | | | |
|---------|----|---------|---|------------|
| 1.2 VTi | 60 | 03/13 → | B | HMZ (EB2F) |
|---------|----|---------|---|------------|

3008

| | | | | |
|-----|----|---------|---|--------------|
| 1.2 | 96 | 01/15 → | B | HNY (EB2DTS) |
|-----|----|---------|---|--------------|

5008

| | | | | |
|-----|----|---------|---|--------------|
| 1.2 | 96 | 01/15 → | B | HNY (EB2DTS) |
|-----|----|---------|---|--------------|

OES cross reference guide

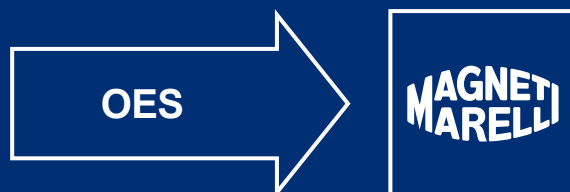

| | |
|-----|-----------------|
| OES | MAGNETI MARELLI |
|-----|-----------------|

| ACURA | |
|-------------|-------|
| 19200P72003 | 81839 |
| 19200P72013 | 81839 |
| 19200P72A01 | 81839 |
| 19200POA003 | 81708 |

| ALFA ROMEO | |
|------------|---------|
| 532912 | 11706T |
| 547815 | 11706T |
| 4714636 | 81334 |
| 4754850 | 81334 |
| 4764761 | 81334 |
| 5896818 | 81464 |
| 5896819 | 81464 |
| 5973319 | 81443 |
| 7072641 | 81302 |
| 7301300 | 81492 |
| 7303009 | 81334 |
| 7303030 | 81492 |
| 7629033 | 81464 |
| 7631379 | 81464 |
| 7693570 | 81464 |
| 7693570 | 81326 |
| 7696226 | 81464 |
| 7708187 | 81322 |
| 7747388 | 81322 |
| 46432248 | 81352 |
| 46515970 | 81352 |
| 46515972 | 81352 |
| 46520401 | 81369 |
| 46804051 | 81872 |
| 46804051 | 81872 |
| 55184081 | 81369 |
| 55198357 | 81355 |
| 55198358 | 81355 |
| 55198547 | 81369 |
| 55204538 | 82070 |
| 55209993 | 81872 |
| 55209993 | 81872 |
| 55221397 | 82070 |
| 55268277 | 82070 |
| 55268918 | 81872 |
| 55271994 | 82070 |
| 60504407 | 11706T |
| 60513151 | 19532/E |
| 60518083 | 11701T |

| | |
|-----|-----------------|
| OES | MAGNETI MARELLI |
|-----|-----------------|

| ALFA ROMEO | |
|------------|---------|
| 60523035 | 11701T |
| 60534334 | 11707 |
| 60534335 | 11707 |
| 60534336 | 11707 |
| 60534758 | 11701T |
| 60536055 | 11706T |
| 60555345 | 11707 |
| 60555347 | 19532/E |
| 60555348 | 19532/E |
| 60561800 | 19532/E |
| 60562567 | 81302 |
| 60563626 | 11701T |
| 60564004 | 81302 |
| 60564048 | 19532/E |
| 60565727 | 11706T |
| 60585358 | 11708T |
| 60585362 | 11708T |
| 60586222 | 81331 |
| 60586467 | 11706T |
| 60597487 | 11708T |
| 60604181 | 81355 |
| 60608898 | 81348 |
| 60611459 | 11706T |
| 60614390 | 11706T |
| 60622295 | 11706T |
| 60624553 | 11706T |
| 60630271 | 81355 |
| 60668487 | 81355 |
| 60700439 | 11707 |
| 60703264 | 11707 |
| 60778982 | 81362 |
| 60778983 | 81362 |
| 60800169 | 81443 |
| 60808116 | 19532/E |
| 60808756 | 81464 |
| 60809209 | 81322 |
| 60810426 | 81322 |
| 60811328 | 81331 |
| 60812263 | 81347 |
| 60812263 | 81363 |
| 60813207 | 81355 |
| 60814609 | 81352 |
| 60815559 | 81352 |
| 60816018 | 81355 |
| 71713045 | 19532/E |

| | |
|-----|-----------------|
| OES | MAGNETI MARELLI |
|-----|-----------------|

| ALFA ROMEO | |
|--------------|---------|
| 71719676 | 81322 |
| 71737965 | 81322 |
| 71737989 | 19532/E |
| 71739401 | 81812 |
| 71739779 | 82083 |
| 71741078 | 84057 |
| 71747983 | 84057 |
| 71751273 | 81812 |
| 71777350 | 82070 |
| 99440726 | 81334 |
| 113050702400 | 11701T |
| 113050702401 | 11701T |
| 116460702400 | 11707 |
| 117010702400 | 11701T |
| 119000702400 | 11707 |
| 119000702402 | 11707 |
| 195150702400 | 11707 |
| 195150702401 | 11707 |
| 195320702402 | 19532/E |
| 195360702400 | 11701T |

| AUDI | |
|------------|-------|
| 022121011 | 81866 |
| 026121005 | 81522 |
| 026121010 | 82080 |
| 026121010 | 82080 |
| 028121004 | 81528 |
| 034121004 | 81683 |
| 037121010 | 82080 |
| 037121010 | 82080 |
| 038121011 | 81706 |
| 045121011 | 81791 |
| 050121010 | 81529 |
| 052121004 | 81520 |
| 052121005 | 81520 |
| 052121019 | 81520 |
| 054121004 | 81700 |
| 055121010 | 82001 |
| 056121011 | 82001 |
| 068121005 | 81521 |
| 068121010 | 82001 |
| 069121004 | 81593 |
| 074121004 | 81701 |
| 078121006 | 81842 |
| 022121011A | 81866 |

| | |
|------------|--|
| OES | |
|------------|--|

| AUDI | |
|-------------|--------------|
| 022121011L | 81866 |
| 022121011V | 81866 |
| 022121011X | 81866 |
| 026121005A | 81522 |
| 026121005C | 81522 |
| 026121005E | 81522 |
| 026121005F | 81526 |
| 026121005G | 81522 |
| 026121005H | 81522 |
| 026121005K | 81526 |
| 026121010A | 82001 |
| 026121010AV | 82001 |
| 026121010AX | 82001 |
| 026121010C | 82080 |
| 026121010C | 82080 |
| 026121010CV | 82080 |
| 026121010CV | 82080 |
| 026121010CX | 82080 |
| 026121010CX | 82080 |
| 026121010D | 82001 |
| 026121010DV | 82001 |
| 026121010DX | 82001 |
| 026121010E | 82080 |
| 026121010E | 82080 |
| 026121010F | 82080 |
| 026121010F | 82080 |
| 026121010FV | 82080 |
| 026121010FV | 82080 |
| 026121010FX | 82080 |
| 026121010FX | 82080 |
| 026121010V | 82080 |
| 026121010V | 82080 |
| 026121010X | 82080 |
| 026121010X | 82080 |
| 028121004V | 81528 |
| 028121004X | 81528 |
| 034121004A | 81683 |
| 034121004B | 81700 |
| 034121004V | 81683 |
| 034121004X | 81683 |
| 034121005D | 81683 |
| 036121005E | 81777 |
| 036121005EV | 81777 |
| 036121005EX | 81777 |
| 036121005F | 81840 |

| | |
|------------|--|
| OES | |
|------------|--|

| AUDI | |
|-------------|--------------|
| 036121005G | 81840 |
| 036121005GX | 81840 |
| 036121005P | 81840 |
| 036121005Q | 81777 |
| 036121005QX | 81777 |
| 036121005S | 81777 |
| 036121005SV | 81777 |
| 036121005SX | 81777 |
| 036121008G | 81840 |
| 036121008GX | 81840 |
| 036121008K | 81777 |
| 036121008L | 81777 |
| 036121008M | 81777 |
| 036121008MX | 81777 |
| 037121010A | 82080 |
| 037121010A | 82080 |
| 037121010AV | 82080 |
| 037121010AV | 82080 |
| 037121010AX | 82080 |
| 037121010AX | 82080 |
| 037121010BX | 82080 |
| 037121010BX | 82080 |
| 037121010C | 82080 |
| 037121010C | 82080 |
| 038121011A | 81706 |
| 038121011AV | 81706 |
| 038121011AX | 81706 |
| 038121011C | 81816 |
| 038121011CX | 81816 |
| 038121011D | 81816 |
| 038121011G | 84011 |
| 038121011GX | 84011 |
| 038121011H | 84011 |
| 038121011HX | 84011 |
| 038121011J | 84011 |
| 038121011JX | 84011 |
| 038121011K | 84011 |
| 038121011KX | 84011 |
| 03C121005B | 81865 |
| 03C121005C | 81865 |
| 03C121005D | 81865 |
| 03C121005DX | 81865 |
| 03C121005K | 81865 |
| 03C121005N | 82097 |
| 03C121005NX | 82097 |

| | |
|------------|--|
| OES | |
|------------|--|

| AUDI | |
|-------------|--------------|
| 03C121005R | 82097 |
| 03C121005RX | 82097 |
| 03C121005S | 81865 |
| 03C121008B | 82097 |
| 03C121008C | 81865 |
| 03C121008CX | 81865 |
| 03C121008E | 82097 |
| 03C121008F | 81865 |
| 03C121008FX | 81865 |
| 03C121008J | 81865 |
| 03C121008JX | 81865 |
| 03F121004A | 84045 |
| 03F121004B | 84045 |
| 03F121004D | 84045 |
| 03F121005 | 84045 |
| 03L121011 | 84001 |
| 03L121011G | 84011 |
| 03L121011GX | 84011 |
| 03L121011H | 84001 |
| 03L121011J | 84001 |
| 03L121011P | 84001 |
| 045121011B | 81791 |
| 045121011BX | 81791 |
| 045121011F | 84010 |
| 045121011FX | 84010 |
| 045121011H | 84010 |
| 045121011HX | 84010 |
| 046121004D | 81701 |
| 046121004DV | 81701 |
| 046121004DX | 81701 |
| 04C121600K | 84062 |
| 04E121600AD | 84062 |
| 04E121600AG | 84062 |
| 04E121600AL | 84062 |
| 04E121600AQ | 84062 |
| 04E121600AR | 84062 |
| 04E121600D | 84062 |
| 04E121600H | 84062 |
| 04E121600P | 84062 |
| 050121010A | 81529 |
| 050121010AV | 81529 |
| 050121010AX | 81529 |
| 050121010C | 81529 |
| 050121010V | 81529 |
| 050121010X | 81529 |

OES
AUDI

| | |
|-------------|--------------|
| 052121004AV | 81520 |
| 052121004AX | 81520 |
| 052121004V | 81520 |
| 052121004X | 81520 |
| 052121005A | 81520 |
| 052121005AX | 81520 |
| 054121004A | 81700 |
| 054121004AV | 81700 |
| 054121004AX | 81700 |
| 054121004V | 81700 |
| 054121004X | 81700 |
| 055121010X | 82001 |
| 056121005A | 81521 |
| 056121013A | 82001 |
| 057121004C | 82041 |
| 057121004CX | 82041 |
| 057121011E | 82046 |
| 059121004B | 81705 |
| 059121004C | 81705 |
| 059121004CX | 81705 |
| 059121004D | 81705 |
| 059121004E | 81705 |
| 059121004EV | 81705 |
| 059121004EX | 81705 |
| 059121005T | 84021 |
| 059121005TX | 84021 |
| 059121008A | 84021 |
| 059121008J | 84021 |
| 059121008JX | 84021 |
| 068121005A | 81522 |
| 068121005B | 81521 |
| 068121005C | 81521 |
| 068121005X | 81521 |
| 068121010A | 82080 |
| 068121010A | 82080 |
| 068121010AX | 82080 |
| 068121010AX | 82080 |
| 069121004V | 81593 |
| 069121004X | 81593 |
| 069121005D | 81593 |
| 06A121011C | 81703 |
| 06A121011E | 81703 |
| 06A121011EV | 81703 |
| 06A121011EX | 81703 |
| 06A121011F | 81703 |

OES
AUDI

| | |
|-------------|--------------|
| 06A121011G | 81703 |
| 06A121011H | 81703 |
| 06A121011HV | 81703 |
| 06A121011HX | 81703 |
| 06A121011L | 81703 |
| 06A121011LV | 81703 |
| 06A121011LX | 81703 |
| 06A121011T | 81703 |
| 06A121011TX | 81703 |
| 06A121012 | 81703 |
| 06A121012G | 81703 |
| 06A121012X | 81703 |
| 06B121011 | 81702 |
| 06B121011A | 81702 |
| 06B121011B | 81702 |
| 06B121011BV | 81702 |
| 06B121011BX | 81702 |
| 06B121011C | 81702 |
| 06B121011CV | 81702 |
| 06B121011CX | 81702 |
| 06B121011E | 81702 |
| 06B121011EV | 81702 |
| 06B121011EX | 81702 |
| 06B121011H | 81702 |
| 06B121011L | 81702 |
| 06B121011LX | 81702 |
| 06B121011M | 81702 |
| 06B121011N | 81702 |
| 06B121011NX | 81702 |
| 06B121011Q | 81702 |
| 06C121004C | 81819 |
| 06C121004G | 81819 |
| 06C121004H | 81819 |
| 06C121004HX | 81819 |
| 06C21004G | 81819 |
| 06E121005D | 82015 |
| 06E121005F | 82015 |
| 06E121005N | 82015 |
| 06E121018A | 82015 |
| 06E121018AX | 82015 |
| 06F121011 | 82025 |
| 06F121011X | 82025 |
| 06H121026AB | 84016 |
| 06H121026AF | 84016 |
| 06H121026AG | 84016 |

OES
AUDI

| | |
|-------------|--------------|
| 06H121026B | 84016 |
| 06H121026B | 84016 |
| 06H121026BA | 84016 |
| 06H121026BE | 84016 |
| 06H121026BF | 84016 |
| 06H121026BP | 84016 |
| 06H121026CC | 84016 |
| 06H121026CP | 84016 |
| 06H121026DD | 84016 |
| 06H121026N | 84016 |
| 06J121026A | 84016 |
| 06J121026AG | 84016 |
| 06J121026F | 84016 |
| 06J121026G | 84016 |
| 06K121011 | 84037 |
| 06L121005A | 84037 |
| 06L121012 | 84037 |
| 06L121012A | 84037 |
| 074121004A | 81701 |
| 074121004AV | 81701 |
| 074121004AX | 81701 |
| 074121004BX | 81701 |
| 074121004N | 81701 |
| 074121004NX | 81701 |
| 074121004V | 81701 |
| 074121004X | 81701 |
| 074121005MV | 81701 |
| 074121005N | 81701 |
| 077121004M | 82081 |
| 077121004MX | 82081 |
| 077121004N | 82081 |
| 077121004P | 82081 |
| 077121004PX | 82081 |
| 078121004H | 81842 |
| 078121004HX | 81842 |
| 078121004J | 81842 |
| 078121004JV | 81842 |
| 078121004JX | 81842 |
| 078121004L | 81842 |
| 078121004Q | 81842 |
| 078121004QX | 81842 |
| 078121004R | 81842 |
| 078121006A | 81842 |
| 078121006X | 81842 |
| 079121011F | 82046 |

| | |
|------------|------------------------|
| OES | MAGNETI MARELLI |
|------------|------------------------|

| | |
|-------------|--|
| AUDI | |
|-------------|--|

| | |
|------------|--------------|
| 079121011H | 82046 |
| 079121012B | 82046 |

| | |
|----------------|--|
| BEDFORD | |
|----------------|--|

| | |
|----------|--------------|
| 1334004 | 81543 |
| 1334008 | 81606 |
| 1334011 | 81681 |
| 1334014 | 81605 |
| 1334023 | 81543 |
| 1334024 | 81681 |
| 1334025 | 81549 |
| 1334027 | 81544 |
| 1334041 | 81550 |
| 1334050 | 81550 |
| 1334053 | 81550 |
| 1334070 | 81543 |
| 1334071 | 81544 |
| 1334098 | 81549 |
| 1334119 | 81550 |
| 1334137 | 81550 |
| 9192370 | 81550 |
| 90076952 | 81543 |
| 90091035 | 81544 |
| 90144227 | 81549 |
| 90183273 | 81543 |
| 90220568 | 81606 |
| 90234200 | 81681 |
| 90272361 | 81606 |
| 90273361 | 81606 |
| 90284813 | 81605 |
| 90284913 | 81605 |
| 90295078 | 81605 |
| 90325660 | 81549 |
| 90325661 | 81681 |
| 90349239 | 81549 |
| 90349241 | 81543 |
| 90409912 | 81544 |
| 90443549 | 81550 |
| 90444311 | 81550 |
| 96351969 | 81549 |
| R1160012 | 81549 |
| R1160024 | 81605 |
| R1160032 | 81550 |

| | |
|------------|------------------------|
| OES | MAGNETI MARELLI |
|------------|------------------------|

| | |
|------------|--|
| BMW | |
|------------|--|

| | |
|-------------|--------------|
| 11510007039 | 81589 |
| 11510393338 | 81590 |
| 11510393731 | 81793 |
| 11511271435 | 81586 |
| 11511271436 | 81618 |
| 11511272613 | 81618 |
| 11511272616 | 81586 |
| 11511274583 | 81584 |
| 11511274584 | 81584 |
| 11511284694 | 81618 |
| 11511286355 | 81584 |
| 11511286358 | 81584 |
| 11511286417 | 81618 |
| 11511287367 | 81618 |
| 11511312129 | 81618 |
| 11511312539 | 81618 |
| 11511433712 | 81588 |
| 11511433828 | 81588 |
| 11511706564 | 81586 |
| 11511706588 | 81586 |
| 11511706624 | 81586 |
| 11511707190 | 81618 |
| 11511707191 | 81618 |
| 11511707192 | 81618 |
| 11511711492 | 81586 |
| 11511715292 | 81587 |
| 11511719836 | 81616 |
| 11511720292 | 81618 |
| 11511720609 | 81616 |
| 11511720892 | 81618 |
| 11511720893 | 81618 |
| 11511721337 | 81587 |
| 11511721477 | 81584 |
| 11511721872 | 81590 |
| 11511722536 | 81588 |
| 11511727123 | 81589 |
| 11511727468 | 81590 |
| 11511730414 | 81588 |
| 11511734269 | 81589 |
| 11511734595 | 81590 |
| 11511734602 | 81590 |
| 11511740241 | 81588 |
| 11511744243 | 81588 |
| 11512242176 | 81617 |
| 11512242677 | 81617 |

| | |
|------------|------------------------|
| OES | MAGNETI MARELLI |
|------------|------------------------|

| | |
|------------|--|
| BMW | |
|------------|--|

| | |
|-------------|--------------|
| 11512243003 | 81597 |
| 11512244333 | 81597 |
| 11512245687 | 81597 |
| 11512247552 | 81793 |
| 11512248996 | 81796 |
| 11512354055 | 81795 |
| 11517503884 | 81588 |
| 11517504040 | 81588 |
| 11517511220 | 82010 |
| 11517511221 | 82010 |
| 11517515778 | 82010 |
| 11517527799 | 81588 |
| 11517527910 | 81588 |
| 11517550484 | 82032 |
| 11517786192 | 81795 |
| 11517786736 | 81794 |
| 11517788305 | 82040 |
| 11517788305 | 82040 |
| 11517788306 | 82034 |
| 11517790135 | 82040 |
| 11517790322 | 82040 |
| 11517790322 | 82040 |
| 11517790471 | 82040 |
| 11517790472 | 82040 |
| 11517791833 | 82040 |
| 11517791834 | 82040 |
| 11517801609 | 82040 |
| 11517805808 | 82040 |
| 11517805810 | 82040 |
| 11517807311 | 84000 |
| 11517823428 | 84023 |
| 11517823429 | 84022 |
| 11518512269 | 84023 |
| 11518512497 | 84023 |
| 11518516435 | 84023 |
| 11518577893 | 84051 |
| 11518586721 | 84051 |
| 11518623574 | 84049 |
| 11519058996 | 81586 |
| 11519068606 | 81597 |
| 11519069529 | 81597 |
| 11519070755 | 81584 |
| 11519070759 | 81616 |
| 11519070761 | 81618 |

| | |
|------------|------------------------|
| OES | MAGNETI MARELLI |
|------------|------------------------|

| | |
|-----------------|--|
| CADILLAC | |
|-----------------|--|

| | |
|----------|--------------|
| 12566029 | 84057 |
|----------|--------------|

| | |
|------------------|--|
| CHEVROLET | |
|------------------|--|

| | |
|----------|--------------|
| 12624936 | 81812 |
| 24409355 | 81550 |
| 25183429 | 84014 |
| 92065969 | 81550 |
| 92226211 | 81550 |
| 96440224 | 84014 |
| 96518977 | 81783 |
| 96563958 | 81783 |
| 96666219 | 81783 |
| 96872702 | 81782 |
| 96930074 | 81782 |

| | |
|-----------------|--|
| CHRYSLER | |
|-----------------|--|

| | |
|------------|--------------|
| 4667660 | 81733 |
| 4720429 | 81302 |
| 4864566 | 81362 |
| 55204538 | 82070 |
| 55221397 | 82070 |
| 5066809AA | 84033 |
| 5066809AB | 84033 |
| 5175580AA | 82058 |
| 68000693AB | 84011 |
| 68027359AA | 84043 |
| 68271384AA | 82070 |

| | |
|----------------|--|
| CITROËN | |
|----------------|--|

| | |
|--------|--------------|
| 1201E0 | 81353 |
| 1201E1 | 82089 |
| 1201E1 | 84038 |
| 1201E1 | 82089 |
| 1201E1 | 81799 |
| 1201E3 | 81556 |
| 1201E4 | 81513 |
| 1201E5 | 81753 |
| 1201E7 | 82089 |
| 1201E7 | 84038 |
| 1201E7 | 82089 |
| 1201E7 | 81799 |
| 1201E8 | 81800 |
| 1201A1 | 81711 |
| 1201A2 | 81753 |
| 1201A3 | 81752 |

| | |
|------------|------------------------|
| OES | MAGNETI MARELLI |
|------------|------------------------|

| | |
|----------------|--|
| CITROËN | |
|----------------|--|

| | |
|--------|--------------|
| 1201A4 | 81642 |
| 1201A5 | 81712 |
| 1201A6 | 81844 |
| 1201A7 | 81353 |
| 1201A8 | 81642 |
| 1201C4 | 81713 |
| 1201C5 | 81353 |
| 1201C6 | 81353 |
| 1201C7 | 81844 |
| 1201C9 | 81316 |
| 1201F2 | 82042 |
| 1201F4 | 82089 |
| 1201F4 | 84038 |
| 1201F4 | 82089 |
| 1201F4 | 81799 |
| 1201F5 | 82089 |
| 1201F5 | 84038 |
| 1201F5 | 82089 |
| 1201F5 | 81799 |
| 1201F6 | 81813 |
| 1201F9 | 81798 |
| 1201G0 | 81797 |
| 1201G1 | 81869 |
| 1201G2 | 82016 |
| 1201G4 | 82089 |
| 1201G4 | 84038 |
| 1201G4 | 82089 |
| 1201G4 | 81799 |
| 1201G5 | 82089 |
| 1201G5 | 84038 |
| 1201G5 | 82089 |
| 1201G5 | 81799 |
| 1201G6 | 82067 |
| 1201G8 | 81798 |
| 1201G9 | 81869 |
| 1201H0 | 82063 |
| 1201H0 | 82063 |
| 1201H4 | 81753 |
| 1201H5 | 81316 |
| 1201H6 | 82066 |
| 1201H7 | 82068 |
| 1201H8 | 82032 |
| 1201J0 | 82063 |
| 1201J0 | 82063 |
| 1201J1 | 82089 |

| | |
|------------|------------------------|
| OES | MAGNETI MARELLI |
|------------|------------------------|

| | |
|----------------|--|
| CITROËN | |
|----------------|--|

| | |
|----------|--------------|
| 1201J1 | 81799 |
| 1201J2 | 82089 |
| 1201J2 | 84038 |
| 1201J2 | 82089 |
| 1201J2 | 81799 |
| 1201J4 | 82094 |
| 1201J6 | 82068 |
| 1201K0 | 82094 |
| 1201K1 | 82089 |
| 1201K1 | 84038 |
| 1201K1 | 82089 |
| 1201K2 | 84020 |
| 1201K5 | 84019 |
| 1201K8 | 81869 |
| 1201L2 | 82089 |
| 1201L2 | 84038 |
| 1201L2 | 82089 |
| 1201L3 | 82063 |
| 20145 | 81560 |
| 120134 | 81367 |
| 120137 | 81822 |
| 120140 | 81367 |
| 120150 | 81512 |
| 120152 | 81642 |
| 120154 | 81353 |
| 120155 | 81353 |
| 120158 | 81513 |
| 120161 | 81512 |
| 120163 | 81554 |
| 120165 | 81642 |
| 120167 | 81642 |
| 120169 | 81572 |
| 120170 | 81752 |
| 120182 | 81753 |
| 120191 | 81642 |
| 120193 | 81711 |
| 120195 | 81368 |
| 120196 | 81346 |
| 120198 | 81710 |
| 120258 | 81572 |
| 120718 | 81556 |
| 120723 | 81556 |
| 120725 | 81513 |
| 75530147 | 81822 |
| 91511136 | 81554 |

| OES | MAGNETI MARELLI |
|----------------|-----------------|
| CITROËN | |
| 95548541 | 81822 |
| 95619748 | 81822 |
| 95625017 | 81512 |
| 95641148 | 81554 |
| 95641149 | 81672 |
| 95643824 | 81672 |
| 95650955 | 81642 |
| 95655207 | 81554 |
| 95655208 | 81512 |
| 95655209 | 81672 |
| 95655210 | 81672 |
| 95656566 | 81554 |
| 95656567 | 81512 |
| 95656568 | 81672 |
| 95656569 | 81672 |
| 95666768 | 81642 |
| 96047088 | 81353 |
| 97521368 | 81560 |
| 504033770 | 82024 |
| 1607852880 | 84042 |
| 1607854280 | 82049 |
| 1609402180 | 81800 |
| 1609402380 | 81713 |
| 1609417280 | 81753 |
| 1609417380 | 81798 |
| 1609417480 | 84038 |
| 1609417480 | 82089 |
| 1609417680 | 81869 |
| 1609944880 | 82066 |
| 1610278080 | 82068 |
| 1611550180 | 84054 |
| 1613518580 | 84020 |
| 7901120258 | 81572 |
| 9401201340 | 81367 |
| 9401201390 | 81554 |
| 9401201400 | 81367 |
| 9401201480 | 81672 |
| 9451001263 | 81556 |
| 9608564280 | 81513 |
| 9617376980 | 81556 |
| 9801573380 | 82032 |
| 9803094380 | 84066 |
| 9803442480 | 84066 |

| OES | MAGNETI MARELLI |
|--------------|-----------------|
| DACIA | |
| 7700861686 | 81579 |
| 7701473327 | 81810 |
| 7701475995 | 84007 |
| 7701476496 | 81810 |
| 7701478031 | 84007 |
| 8200146298 | 81579 |
| 210101302R | 84039 |
| 210108574R | 84007 |

| DAEWOO | |
|---------------|-------|
| 1334008 | 81606 |
| 1334025 | 81549 |
| 1334098 | 81549 |
| 24409355 | 81550 |
| 90144227 | 81549 |
| 90220568 | 81606 |
| 90272361 | 81606 |
| 90273361 | 81606 |
| 90325660 | 81549 |
| 90349239 | 81549 |
| 90443549 | 81550 |
| 90444359 | 81550 |
| 90466343 | 81550 |
| 92064250 | 81550 |
| 92065969 | 81550 |
| 94013802 | 81780 |
| 96182871 | 81782 |
| 96350799 | 81781 |
| 96351284 | 81780 |
| 96351969 | 81549 |
| 96351971 | 81780 |
| 96352648 | 81781 |
| 96352649 | 81780 |
| 96352650 | 81782 |
| 1740050812 | 81783 |
| 1740061810 | 81783 |
| 1740060D01 | 81783 |
| 1740070B00 | 81783 |
| 17400A60D01 | 81783 |
| 17400A60D02 | 81783 |
| R1160012 | 81549 |

| OES | MAGNETI MARELLI |
|-----------------|-----------------|
| DAIHATSU | |
| 1610080001 | 82063 |
| 1610080001 | 82063 |
| 1610087109 | 81715 |
| 1610087182 | 81714 |
| 1610087183 | 81715 |
| 1610087184 | 81714 |
| 1610087185 | 81715 |
| 1610087390 | 81714 |
| 1610097234 | 82063 |
| 1610097234 | 82063 |
| 1610097404 | 81808 |
| 1610097411 | 81808 |
| 1610097404000 | 81808 |
| 1610097411000 | 81808 |
| 16100B09010 | 81808 |
| 16100B9010 | 81808 |

| FIAT | |
|-------------|-------|
| 777034 | 81333 |
| 4243672 | 81415 |
| 4243679 | 81415 |
| 4296890 | 81415 |
| 4336009 | 81434 |
| 4458134 | 81436 |
| 4823810 | 81488 |
| 5548541 | 81822 |
| 5882691 | 81434 |
| 5882694 | 81415 |
| 5890406 | 81434 |
| 5894394 | 81460 |
| 5896818 | 81464 |
| 5896819 | 81464 |
| 5939200 | 81415 |
| 5973319 | 81443 |
| 5973713 | 81801 |
| 5999790 | 81460 |
| 7301300 | 81492 |
| 7303030 | 81492 |
| 7553396 | 81450 |
| 7574887 | 81436 |
| 7575827 | 81469 |
| 7580756 | 81481 |
| 7589065 | 81477 |
| 7597569 | 81309 |
| 7608844 | 81456 |

| | |
|------------|------------------------|
| OES | MAGNETI MARELLI |
|------------|------------------------|

| FIAT | |
|-------------|--------------|
| 7609204 | 81490 |
| 7617168 | 81476 |
| 7617364 | 81458 |
| 7626604 | 81463 |
| 7629033 | 81464 |
| 7629033 | 81326 |
| 7629228 | 81463 |
| 7631379 | 81464 |
| 7631494 | 81309 |
| 7635180 | 81460 |
| 7640163 | 81801 |
| 7648451 | 81347 |
| 7651586 | 81314 |
| 7658606 | 81309 |
| 7658607 | 81309 |
| 7661811 | 81490 |
| 7661813 | 81460 |
| 7671811 | 81333 |
| 7691046 | 81476 |
| 7691047 | 81476 |
| 7691820 | 81801 |
| 7692285 | 81309 |
| 7692551 | 81489 |
| 7692552 | 81463 |
| 7692555 | 81363 |
| 7693569 | 81309 |
| 7693570 | 81464 |
| 7694229 | 81460 |
| 7695555 | 81490 |
| 7695557 | 81460 |
| 7695559 | 81490 |
| 7696226 | 81464 |
| 7701137 | 81315 |
| 7708187 | 81322 |
| 7715051 | 81347 |
| 7715242 | 81801 |
| 7720987 | 81333 |
| 7723345 | 81476 |
| 7724414 | 81300 |
| 7737200 | 81333 |
| 7744397 | 81333 |
| 7747386 | 81490 |
| 7747388 | 81322 |
| 7750698 | 81303 |
| 7752928 | 81343 |

| | |
|------------|------------------------|
| OES | MAGNETI MARELLI |
|------------|------------------------|

| FIAT | |
|-------------|--------------|
| 7752928 | 81366 |
| 7762924 | 81340 |
| 7762925 | 81330 |
| 7762926 | 81329 |
| 7762986 | 81301 |
| 7770038 | 81476 |
| 7781232 | 81304 |
| 7783006 | 81315 |
| 7784977 | 81333 |
| 7784979 | 81476 |
| 7784982 | 81476 |
| 7784988 | 81333 |
| 46400058 | 81341 |
| 46400058 | 81364 |
| 46407762 | 81347 |
| 46407766 | 81363 |
| 46408312 | 81489 |
| 46409134 | 81469 |
| 46409136 | 81456 |
| 46409200 | 81368 |
| 46409201 | 81346 |
| 46410549 | 81339 |
| 46410551 | 81342 |
| 46410562 | 81344 |
| 46411355 | 81341 |
| 46411355 | 81364 |
| 46422430 | 81343 |
| 46422430 | 81366 |
| 46422512 | 81369 |
| 46423351 | 81801 |
| 46432248 | 81352 |
| 46437911 | 81343 |
| 46437911 | 81366 |
| 46437912 | 81303 |
| 46437913 | 81346 |
| 46437914 | 81346 |
| 46437915 | 81343 |
| 46437915 | 81366 |
| 46437916 | 81303 |
| 46444355 | 81341 |
| 46444355 | 81364 |
| 46445405 | 81365 |
| 46464225 | 81344 |
| 46515970 | 81352 |
| 46515971 | 81351 |

| | |
|------------|------------------------|
| OES | MAGNETI MARELLI |
|------------|------------------------|

| FIAT | |
|-------------|----------------|
| 46515972 | 81352 |
| 46520401 | 81369 |
| 46525058 | 81344 |
| 46526243 | 81370 |
| 46531183 | 81801 |
| 46554397 | 81344 |
| 46742168 | 81300 |
| 46757573 | 82086 |
| 46757574 | 82086 |
| 46804051 | 81872 |
| 46804051 | 81872 |
| 46805736 | 81370 |
| 46815125 | 81862 |
| 46819138 | 81862 |
| 55184080 | 81370 |
| 55184081 | 81369 |
| 55198358 | 81355 |
| 55198547 | 81369 |
| 55204538 | 82070 |
| 55209993 | 81872 |
| 55209993 | 81872 |
| 55220285 | 81862 |
| 55221397 | 82070 |
| 55225394 | 84008 |
| 55233943 | 84008 |
| 55240489 | 81861 |
| 55258179 | 81861 |
| 55263214 | 84008 |
| 55268277 | 82070 |
| 55268918 | 81872 |
| 55270499 | 84008 |
| 55271994 | 82070 |
| 60513151 | 19532/E |
| 60555347 | 19532/E |
| 60555348 | 19532/E |
| 60561800 | 19532/E |
| 60564048 | 19532/E |
| 60586222 | 81331 |
| 60608898 | 81348 |
| 60800169 | 81443 |
| 60808116 | 19532/E |
| 60808756 | 81464 |
| 60809209 | 81322 |
| 60810426 | 81322 |
| 60811328 | 81331 |

| | |
|-----|-----------------|
| OES | MAGNETI MARELLI |
|-----|-----------------|

| FIAT | |
|------------|---------|
| 60814609 | 81352 |
| 60816231 | 81348 |
| 71713045 | 19532/E |
| 71713727 | 81801 |
| 71713728 | 81369 |
| 71716878 | 81364 |
| 71719666 | 81333 |
| 71719676 | 81322 |
| 71737965 | 81322 |
| 71737974 | 81333 |
| 71737989 | 19532/E |
| 71737991 | 81320 |
| 71739136 | 81642 |
| 71739401 | 81812 |
| 71739779 | 82083 |
| 71742124 | 82026 |
| 71745026 | 81862 |
| 71751273 | 81812 |
| 71777350 | 82070 |
| 75530147 | 81822 |
| 76611813 | 81460 |
| 91107589 | 81490 |
| 95548541 | 81822 |
| 95619748 | 81822 |
| 95641149 | 81672 |
| 95643824 | 81672 |
| 95655209 | 81672 |
| 95655210 | 81672 |
| 95656568 | 81672 |
| 95656569 | 81672 |
| 98430541 | 81324 |
| 98435125 | 81325 |
| 98473452 | 81316 |
| 99440717 | 81316 |
| 99440930 | 81325 |
| 99459759 | 81488 |
| 504033770 | 82024 |
| 504083122 | 81316 |
| 504102572 | 82094 |
| 504248581 | 82094 |
| 1304596080 | 81320 |
| 1304612080 | 81318 |
| 1312388080 | 81318 |
| 1313021080 | 81319 |
| 1317462080 | 81320 |

| | |
|-----|-----------------|
| OES | MAGNETI MARELLI |
|-----|-----------------|

| FIAT | |
|--------------|---------|
| 1317463080 | 81318 |
| 1317464080 | 81318 |
| 1317466080 | 81319 |
| 1609417080 | 81797 |
| 9401201340 | 81367 |
| 9401201400 | 81367 |
| 9401201480 | 81672 |
| 9463623088 | 81800 |
| 9565095580 | 81642 |
| 9565656788 | 81512 |
| 9566945680 | 81642 |
| 9566945688 | 81642 |
| 9567521488 | 81642 |
| 9569147388 | 81713 |
| 9604708880 | 81353 |
| 9627667988 | 81642 |
| 9629110980 | 81353 |
| 9631169188 | 81797 |
| 9640601280 | 82089 |
| 9640601280 | 84038 |
| 9640601280 | 82089 |
| 9640601280 | 81799 |
| 9641117180 | 81813 |
| 9654514780 | 81869 |
| 9654531880 | 82089 |
| 9654531880 | 84038 |
| 9654531880 | 82089 |
| 9654531880 | 81799 |
| 9655043180 | 82089 |
| 9655043180 | 84038 |
| 9655043180 | 82089 |
| 9655043180 | 81799 |
| 9659248280 | 82066 |
| 9663654980 | 82089 |
| 9663654980 | 84038 |
| 9663654980 | 82089 |
| 9682360280 | 84020 |
| 9684319880 | 82068 |
| 195320702402 | 19532/E |
| 46410551E | 81372 |
| K68096225AA | 81872 |
| K68290837AA | 81872 |

| | |
|-----|-----------------|
| OES | MAGNETI MARELLI |
|-----|-----------------|

| FORD | |
|---------|-------|
| 1001889 | 81773 |
| 1007714 | 81598 |
| 1020538 | 81598 |
| 1020567 | 81716 |
| 1020988 | 81651 |
| 1023645 | 81651 |
| 1031279 | 81657 |
| 1031879 | 81522 |
| 1032940 | 81362 |
| 1053879 | 81803 |
| 1059843 | 81773 |
| 1079085 | 81802 |
| 1089795 | 82018 |
| 1094596 | 81803 |
| 1096556 | 82057 |
| 1100635 | 81816 |
| 1104115 | 81802 |
| 1116996 | 81805 |
| 1119276 | 81804 |
| 1131809 | 82057 |
| 1131878 | 81802 |
| 1132607 | 81598 |
| 1136393 | 82057 |
| 1138318 | 81803 |
| 1142005 | 81804 |
| 1142427 | 81804 |
| 1143851 | 81805 |
| 1146965 | 82057 |
| 1147585 | 81798 |
| 1227902 | 81803 |
| 1229571 | 82018 |
| 1232499 | 81800 |
| 1233218 | 81559 |
| 1250684 | 84010 |
| 1250685 | 84010 |
| 1308453 | 82057 |
| 1310015 | 84011 |
| 1313167 | 81804 |
| 1313842 | 81869 |
| 1318354 | 81656 |
| 1320085 | 81654 |
| 1326374 | 81598 |
| 1336008 | 81804 |
| 1341835 | 81805 |
| 1347102 | 81805 |

| | |
|------------|------------------------|
| OES | MAGNETI MARELLI |
|------------|------------------------|

| FORD | |
|-------------|--------------|
| 1348621 | 81798 |
| 1350461 | 81598 |
| 1351130 | 81869 |
| 1359027 | 81804 |
| 1359942 | 81798 |
| 1361486 | 81804 |
| 1364152 | 81804 |
| 1364681 | 81869 |
| 1366614 | 81798 |
| 1372336 | 82066 |
| 1376162 | 82027 |
| 1381796 | 82066 |
| 1385827 | 82057 |
| 1388504 | 82056 |
| 1388504 | 82056 |
| 1406479 | 82027 |
| 1417825 | 81805 |
| 1420149 | 81798 |
| 1427914 | 82068 |
| 1429037 | 81716 |
| 1432630 | 81800 |
| 1434347 | 81804 |
| 1452907 | 82057 |
| 1455679 | 82057 |
| 1472867 | 82027 |
| 1477444 | 81805 |
| 1480869 | 81804 |
| 1517728 | 81655 |
| 1517749 | 81651 |
| 1518123 | 81559 |
| 1518911 | 81716 |
| 1528548 | 81532 |
| 1535462 | 81369 |
| 1535466 | 81369 |
| 1538412 | 82068 |
| 1538706 | 81862 |
| 1559259 | 82068 |
| 1562255 | 81800 |
| 1566239 | 81598 |
| 1566241 | 82004 |
| 1584043 | 81804 |
| 1589055 | 82027 |
| 1651816 | 81654 |
| 1680637 | 82027 |
| 1688697 | 82027 |

| | |
|------------|------------------------|
| OES | MAGNETI MARELLI |
|------------|------------------------|

| FORD | |
|-------------|--------------|
| 1694898 | 84020 |
| 1701415 | 82057 |
| 1707009 | 81800 |
| 1713348 | 82057 |
| 1715121 | 82057 |
| 1715839 | 81869 |
| 1727556 | 84020 |
| 1760659 | 84036 |
| 1766164 | 84036 |
| 1778516 | 82027 |
| 3006897 | 81845 |
| 3667653 | 81845 |
| 3715703 | 81845 |
| 3800766 | 81845 |
| 4096620 | 81845 |
| 4356532 | 81845 |
| 4356671 | 82036 |
| 4373611 | 82036 |
| 4425510 | 82036 |
| 4431771 | 82036 |
| 4448274 | 82036 |
| 4448290 | 81845 |
| 4480690 | 82036 |
| 4514060 | 82036 |
| 4551517 | 81845 |
| 5004972 | 81532 |
| 5004995 | 81602 |
| 5005058 | 81532 |
| 5005197 | 81531 |
| 5006043 | 81602 |
| 5006046 | 81602 |
| 5009186 | 81602 |
| 5009286 | 81532 |
| 5009287 | 81602 |
| 5010783 | 81531 |
| 5010875 | 81532 |
| 5010876 | 81532 |
| 5010877 | 81602 |
| 5010878 | 81602 |
| 5010880 | 81532 |
| 5011013 | 81536 |
| 5011863 | 81602 |
| 5011864 | 81532 |
| 5012322 | 81536 |
| 5012359 | 81602 |

| | |
|------------|------------------------|
| OES | MAGNETI MARELLI |
|------------|------------------------|

| FORD | |
|-------------|--------------|
| 5012773 | 81559 |
| 5013267 | 81532 |
| 5013268 | 81602 |
| 5013274 | 81602 |
| 5013320 | 81538 |
| 5020242 | 81651 |
| 5020437 | 81650 |
| 5020651 | 81538 |
| 5023817 | 81536 |
| 5024297 | 81657 |
| 5024545 | 81559 |
| 5024603 | 81531 |
| 5025607 | 81655 |
| 5025908 | 81650 |
| 5026783 | 81650 |
| 5028472 | 81656 |
| 6039328 | 81531 |
| 6050034 | 81531 |
| 6050907 | 81531 |
| 6065711 | 81602 |
| 6457409 | 81654 |
| 6683522 | 81653 |
| 6878045 | 82004 |
| 7072641 | 81302 |
| 7087382 | 81654 |
| 7269023 | 81845 |
| 19BBX8591FA | 81803 |
| 1F1E8501BA | 81845 |
| 1S7G8501AK | 81804 |
| 1S7G8501AR | 81804 |
| 1S7G8501BB | 81804 |
| 1S7G8501BC | 81804 |
| 2U1Q8K500BB | 82057 |
| 3M5Q8591EA | 81800 |
| 5L8E8501AA | 82036 |
| 6C1Q8K500AF | 82066 |
| 6G9N8591AA | 82056 |
| 6G9Q8501AB | 82068 |
| 6G9Q8591AA | 82068 |
| 7S7G8591A2A | 82027 |
| 7S7G8591A2B | 82027 |
| 88BX8591AA | 81650 |
| 88FX8591AA | 81651 |
| 88FX8591AB | 81651 |
| 88WF8501AB | 81654 |

| | |
|------------|------------------------|
| OES | MAGNETI MARELLI |
|------------|------------------------|

| FORD | |
|--------------|--------------|
| 914FX8591AA | 81559 |
| 91FX8591AA | 81657 |
| 91WM8501AA | 81654 |
| 91WM8501AB | 81654 |
| 91WM8591AA | 81654 |
| 928X8591AA | 81655 |
| 92BX8591AA | 81653 |
| 92BX8591BA | 81650 |
| 93FX8591AA | 81656 |
| 95VW8503AA | 82080 |
| 95VW8503AA | 82080 |
| 95VW8591AA | 81773 |
| 96BX8591AA | 81716 |
| 96FX8591AA | 81651 |
| 96FX8591EA | 81657 |
| 96MX8591AA | 81598 |
| 988X8591FA | 81803 |
| 988X8591FC | 81803 |
| A790X8591DA | 81532 |
| A790X8591EFA | 81532 |
| A790X8591HFA | 81531 |
| A830X8591TA | 81536 |
| A840X8591AA | 81559 |
| A840X8591ATA | 81559 |
| A840X8591AUA | 81532 |
| A840X8591BAA | 81602 |
| A840X8591BCA | 81538 |
| A840X8591JA | 81536 |
| A840X8591KA | 81602 |
| CM5G8591AA | 84036 |
| EPW20 | 81559 |
| EPW38 | 81559 |
| EPW40 | 81651 |
| EPW41 | 81602 |
| EPW50 | 81602 |
| EPW51 | 81602 |
| EPW52 | 81657 |
| EPW55 | 81655 |
| EPW60 | 81653 |
| EPW61 | 81536 |
| EPW63 | 81532 |
| EPW65 | 81536 |
| EPW67 | 81532 |
| EPW68 | 81602 |
| EPW7 | 81532 |

| | |
|------------|------------------------|
| OES | MAGNETI MARELLI |
|------------|------------------------|

| FORD | |
|---------------|--------------|
| EPW70 | 81538 |
| EPW71 | 81650 |
| EPW74 | 81654 |
| EPW743 | 81532 |
| EPW746 | 81532 |
| EPW76 | 82004 |
| EPW79 | 81656 |
| EPW80 | 81598 |
| EPW81 | 81716 |
| EPW82 | 81651 |
| EPW85 | 81657 |
| EPW985 | 81531 |
| ME3M5Q8591C2A | 81869 |
| V94DD8501AA | 81302 |
| XS2E8501BD | 81845 |
| XS2E8501CC | 81845 |
| XS2E8501CF | 81845 |
| XS4J8591AC | 81802 |
| XS7Q8K500AE | 81805 |
| XS7Q8K500AM | 81805 |

| HONDA | |
|--------------|--------------|
| 19200P01003 | 81613 |
| 19200P01004 | 81613 |
| 19200P14A00 | 81709 |
| 19200P2A004 | 81838 |
| 19200P2AA01 | 81838 |
| 19200P2AA02 | 81838 |
| 19200P30003 | 81839 |
| 19200P5TG00 | 81707 |
| 19200P5TG01 | 81707 |
| 19200P72003 | 81839 |
| 19200P72013 | 81839 |
| 19200P72A01 | 81839 |
| 19200PDFE01 | 81838 |
| 19200PE0010 | 81611 |
| 19200PE0660 | 81611 |
| 19200PH7013 | 81839 |
| 19200PLE005 | 82039 |
| 19200PLMA01 | 82039 |
| 19200PM3000 | 81613 |
| 19200PM3003 | 81613 |
| 19200PM3013 | 81613 |
| 19200PM3014 | 81613 |
| 19200POBA01 | 81708 |

| | |
|------------|------------------------|
| OES | MAGNETI MARELLI |
|------------|------------------------|

| HONDA | |
|--------------|--------------|
| 19200PTO003 | 81708 |
| 19200PTO013 | 81708 |
| 19200PWA003 | 82045 |
| 19200RB0003 | 84065 |
| 19200RBDE01 | 82093 |
| 19200RSRE01 | 82093 |
| 19200RSRE02 | 82093 |

| HYUNDAI | |
|----------------|--------------|
| 251002E000 | 84064 |
| 2510002500 | 81837 |
| 2510002501 | 81837 |
| 2510002502 | 81837 |
| 2510002566 | 84018 |
| 2510002577 | 84018 |
| 2510002588 | 84018 |
| 2510003010 | 84040 |
| 2510021000 | 81784 |
| 2510021010 | 81784 |
| 2510022010 | 81784 |
| 2510022012 | 81784 |
| 2510022650 | 81784 |
| 2510023001 | 81785 |
| 2510023002 | 81785 |
| 2510023010 | 81785 |
| 2510023011 | 81785 |
| 2510023022 | 81785 |
| 2510023511 | 81785 |
| 2510023513 | 81785 |
| 2510023530 | 81785 |
| 2510024030 | 81784 |
| 2510024040 | 81784 |
| 2510024060 | 81784 |
| 2510026015 | 82020 |
| 2510026016 | 82020 |
| 2510026660 | 82020 |
| 2510026900 | 82020 |
| 2510026901 | 82020 |
| 2510026902 | 82020 |
| 2510027000 | 82085 |
| 2510027010 | 82085 |
| 2510027400 | 84059 |
| 2510027900 | 82085 |
| 2510032120 | 81786 |
| 2510033111 | 81786 |

| OES | MAGNETI MARELLI |
|-----|-----------------|
|-----|-----------------|

| HYUNDAI | |
|------------|-------|
| 2510033120 | 81786 |
| 2510033132 | 81786 |
| 2510037102 | 82021 |
| 2510037200 | 82021 |
| 2510037201 | 82021 |
| 2510037202 | 82021 |
| 2510042000 | 81787 |
| 2510042001 | 81787 |
| 2511129000 | 81642 |
| 251002A000 | 84058 |
| 251002A001 | 84058 |
| 251002A010 | 84058 |
| 251002A201 | 84063 |
| 251002B000 | 84015 |
| 251002B700 | 84015 |
| 251002B710 | 84015 |

| INNOCENTI | |
|-----------|--|
|-----------|--|

| | |
|----------|-------|
| 4336009 | 81434 |
| 4384128 | 81481 |
| 5882691 | 81434 |
| 5890406 | 81434 |
| 7608844 | 81456 |
| 7617168 | 81476 |
| 7651586 | 81314 |
| 7691046 | 81476 |
| 7691047 | 81476 |
| 7723345 | 81476 |
| 7738267 | 81476 |
| 7748002 | 81476 |
| 7752928 | 81343 |
| 7770038 | 81476 |
| 7770042 | 81476 |
| 7784979 | 81476 |
| 7784982 | 81476 |
| 31402021 | 81419 |
| 38401023 | 81419 |
| 38402024 | 81419 |
| 38406025 | 81419 |
| 39402022 | 81419 |
| 46409136 | 81456 |
| 46410562 | 81344 |
| 46437911 | 81366 |
| 46464225 | 81344 |

| OES | MAGNETI MARELLI |
|-----|-----------------|
|-----|-----------------|

| ISUZU | |
|------------|-------|
| 5862023750 | 81708 |
| 586008905Z | 81838 |
| 586008940Z | 81838 |

| IVECO | |
|-------|--|
|-------|--|

| | |
|-----------|-------|
| 4714636 | 81334 |
| 4754850 | 81334 |
| 4764761 | 81334 |
| 7303009 | 81334 |
| 7303056 | 81491 |
| 98418986 | 81334 |
| 98437726 | 81334 |
| 98438356 | 81332 |
| 99438900 | 81332 |
| 99440726 | 81334 |
| 99459755 | 81491 |
| 500300476 | 81332 |
| 504033770 | 82024 |
| 504113544 | 82095 |
| 504113544 | 82095 |

| JAGUAR | |
|--------|--|
|--------|--|

| | |
|----------|-------|
| C2S18139 | 81845 |
| C2S40055 | 81805 |
| C2S43292 | 81845 |
| C2S43330 | 81805 |
| C2S48033 | 81805 |
| C2S5120 | 81845 |
| C2S51449 | 82068 |

| JEEP | |
|------|--|
|------|--|

| | |
|------------|-------|
| 4864566 | 81362 |
| 4864688 | 81664 |
| 55240489 | 81861 |
| 55258179 | 81861 |
| 55268277 | 82070 |
| 55268918 | 81872 |
| 05072697AA | 84035 |
| 05072697AB | 84035 |
| 05093911AB | 84035 |
| 68000693AA | 84011 |
| 68000693AB | 84011 |
| 68027359AA | 84043 |

| OES | MAGNETI MARELLI |
|-----|-----------------|
|-----|-----------------|

| KIA | |
|-------------|-------|
| 251002E000 | 84064 |
| 2510002500 | 81837 |
| 2510002501 | 81837 |
| 2510002502 | 81837 |
| 2510002566 | 84018 |
| 2510002577 | 84018 |
| 2510002588 | 84018 |
| 2510003010 | 84040 |
| 2510023001 | 81785 |
| 2510023002 | 81785 |
| 2510023010 | 81785 |
| 2510023011 | 81785 |
| 2510023022 | 81785 |
| 2510023511 | 81785 |
| 2510023513 | 81785 |
| 2510023530 | 81785 |
| 2510027000 | 82085 |
| 2510027010 | 82085 |
| 2510027400 | 84059 |
| 2510027900 | 82085 |
| 2510032120 | 81786 |
| 2510033111 | 81786 |
| 2510033120 | 81786 |
| 2510033132 | 81786 |
| 2510037102 | 82021 |
| 2510037200 | 82021 |
| 2510037201 | 82021 |
| 2510037202 | 82021 |
| 2510042000 | 81787 |
| 2510042001 | 81787 |
| 251002A000 | 84058 |
| 251002A001 | 84058 |
| 251002A010 | 84058 |
| 251002A201 | 84063 |
| 251002B000 | 84015 |
| 251002B700 | 84015 |
| 251002B710 | 84015 |
| 251004X300 | 82038 |
| OK55115100B | 82038 |

| | |
|------------|------------------------|
| OES | MAGNETI MARELLI |
|------------|------------------------|

| LADA | |
|---------------|--------------|
| 4197598 | 81999 |
| 95641149 | 81672 |
| 95643824 | 81672 |
| 95655209 | 81672 |
| 95655210 | 81672 |
| 95656568 | 81672 |
| 95656569 | 81672 |
| 9401201480 | 81672 |
| 21011307010 | 81999 |
| 21011307014 | 81999 |
| 21081307010 | 81619 |
| 2108130701010 | 81717 |

| LANCIA | |
|---------------|--|
|---------------|--|

| | |
|---------|--------------|
| 4192732 | 81415 |
| 4243672 | 81415 |
| 4243679 | 81415 |
| 4296890 | 81415 |
| 4336009 | 81434 |
| 4384128 | 81481 |
| 4384129 | 81415 |
| 4458134 | 81436 |
| 5882691 | 81434 |
| 5882694 | 81415 |
| 5890406 | 81434 |
| 5894394 | 81460 |
| 5896818 | 81464 |
| 5896819 | 81464 |
| 5939200 | 81415 |
| 5973319 | 81443 |
| 5973713 | 81801 |
| 5999790 | 81460 |
| 7574887 | 81436 |
| 7609204 | 81490 |
| 7617168 | 81476 |
| 7629033 | 81464 |
| 7629033 | 81326 |
| 7631379 | 81464 |
| 7635180 | 81460 |
| 7640163 | 81801 |
| 7651586 | 81314 |
| 7661811 | 81490 |
| 7661813 | 81460 |
| 7671811 | 81333 |
| 7691046 | 81476 |

| | |
|------------|------------------------|
| OES | MAGNETI MARELLI |
|------------|------------------------|

| LANCIA | |
|---------------|--------------|
| 7691047 | 81476 |
| 7691820 | 81801 |
| 7693570 | 81464 |
| 7694229 | 81460 |
| 7695555 | 81490 |
| 7695557 | 81460 |
| 7695559 | 81490 |
| 7696226 | 81464 |
| 7701137 | 81315 |
| 7708187 | 81322 |
| 7710471 | 81347 |
| 7715242 | 81801 |
| 7720987 | 81333 |
| 7723345 | 81476 |
| 7737200 | 81333 |
| 7738267 | 81476 |
| 7744397 | 81333 |
| 7747386 | 81490 |
| 7747388 | 81322 |
| 7748002 | 81476 |
| 7750698 | 81339 |
| 7762924 | 81340 |
| 7762925 | 81330 |
| 7762926 | 81329 |
| 7770034 | 81333 |
| 7770038 | 81476 |
| 7770042 | 81476 |
| 7783006 | 81315 |
| 7784977 | 81333 |
| 7784979 | 81476 |
| 7784982 | 81476 |
| 7784987 | 81333 |
| 7784988 | 81333 |
| 46400058 | 81341 |
| 46400058 | 81364 |
| 46410549 | 81303 |
| 46411355 | 81341 |
| 46411355 | 81364 |
| 46422512 | 81369 |
| 46423351 | 81801 |
| 46432248 | 81352 |
| 46435858 | 81363 |
| 46437912 | 81339 |
| 46437912 | 81303 |
| 46437916 | 81339 |

| | |
|------------|------------------------|
| OES | MAGNETI MARELLI |
|------------|------------------------|

| LANCIA | |
|---------------|--------------|
| 46437916 | 81303 |
| 46444355 | 81341 |
| 46444355 | 81364 |
| 46515970 | 81352 |
| 46515971 | 81351 |
| 46515972 | 81352 |
| 46520401 | 81369 |
| 46526243 | 81370 |
| 46531183 | 81801 |
| 46804051 | 81872 |
| 46804051 | 81872 |
| 46819138 | 81862 |
| 55184080 | 81370 |
| 55184081 | 81369 |
| 55198357 | 81355 |
| 55198358 | 81355 |
| 55198547 | 81369 |
| 55204538 | 82070 |
| 55209993 | 81872 |
| 55209993 | 81872 |
| 55221397 | 82070 |
| 55225394 | 84008 |
| 55233943 | 84008 |
| 55263214 | 84008 |
| 55268277 | 82070 |
| 55268918 | 81872 |
| 55270499 | 84008 |
| 55271994 | 82070 |
| 60586222 | 81331 |
| 60604181 | 81355 |
| 60630271 | 81355 |
| 60668487 | 81355 |
| 60800169 | 81443 |
| 60808756 | 81464 |
| 60809209 | 81322 |
| 60810426 | 81322 |
| 60811328 | 81331 |
| 60813207 | 81355 |
| 60814609 | 81352 |
| 60816018 | 81355 |
| 71713727 | 81801 |
| 71713728 | 81369 |
| 71719666 | 81333 |
| 71719676 | 81322 |
| 71737965 | 81322 |

| | |
|------------|------------------------|
| OES | MAGNETI MARELLI |
|------------|------------------------|

| LANCIA | |
|---------------|--------------|
| 71737974 | 81333 |
| 71745026 | 81862 |
| 71777350 | 82070 |
| 76611813 | 81460 |
| 91107589 | 81490 |
| 98430541 | 81324 |
| 98435125 | 81325 |
| 98456197 | 81325 |
| 99440930 | 81325 |
| 9463623088 | 81800 |
| 9565095580 | 81642 |
| 9566945688 | 81642 |
| 9567521488 | 81642 |
| 9569147388 | 81713 |
| 9604708880 | 81353 |
| 9629110980 | 81353 |
| 9640601280 | 82089 |
| 9640601280 | 84038 |
| 9640601280 | 82089 |
| 9640601280 | 81799 |
| 9654531880 | 82089 |
| 9654531880 | 84038 |
| 9654531880 | 82089 |
| 9654531880 | 81799 |
| 9655043180 | 82089 |
| 9655043180 | 84038 |
| 9655043180 | 82089 |
| 9655043180 | 81799 |
| 9663654980 | 82089 |
| 9663654980 | 84038 |
| 9663654980 | 82089 |
| 9684319880 | 82068 |
| K68096225AA | 81872 |

| LAND ROVER | |
|-------------------|--------------|
| GWP193 | 81707 |
| GWP2602 | 82029 |
| GWP347 | 81707 |
| LR001309 | 82068 |
| LR004799 | 82057 |
| LR009392 | 82068 |
| LR011694 | 82068 |
| LR025302 | 81804 |
| LR040990 | 81804 |
| LR053310 | 81804 |

| | |
|------------|------------------------|
| OES | MAGNETI MARELLI |
|------------|------------------------|

| LAND ROVER | |
|-------------------|--------------|
| LR081578 | 81804 |
| PEB000050 | 81795 |
| PEB000050E | 81795 |
| PEB102010 | 81707 |
| PEB102240 | 82029 |
| PEB102240L | 82029 |
| PEB102420 | 81707 |
| PEB102420L | 81707 |
| STC2192 | 81597 |
| STC3342 | 81597 |
| STC3343E | 81597 |

| LEXUS | |
|--------------|--------------|
| 1610009070 | 82051 |
| 1610009340 | 82071 |
| 1610029085 | 82051 |
| 1610029495 | 82071 |

| LOTUS | |
|--------------|--------------|
| GWP333 | 81615 |

| MAZDA | |
|--------------|--------------|
| 1201F9 | 81798 |
| 1201G8 | 81798 |
| 1E0415010 | 81716 |
| 1E0515010 | 81598 |
| 1E0615010 | 81598 |
| 1N0015010 | 81745 |
| 1N0515010 | 81745 |
| C20115010A | 81598 |
| C20215010A | 81598 |
| C40115010 | 81598 |
| L32715100A | 81804 |
| LF0115100 | 81804 |
| LF0115100A | 81804 |
| LF9415010A | 81804 |
| LF9415100 | 81804 |
| LF9415100A | 81804 |
| RF2A15100A | 82092 |
| RF2A15100B | 82092 |
| RF2A15100C | 82092 |
| RF5C15010A | 82092 |
| RF5G15010B | 82092 |
| RF7J15010A | 82092 |
| RF8G15010A | 82092 |

| | |
|------------|------------------------|
| OES | MAGNETI MARELLI |
|------------|------------------------|

| MAZDA | |
|--------------|--------------|
| Y40115010 | 81798 |
| Y40115010A | 81798 |
| Y60115010 | 81869 |
| Y60115010A | 81869 |
| Y60115010B | 81869 |
| Y60115S20 | 81869 |
| Y60315100 | 81869 |
| Y61015010A | 81869 |
| ZJ0115010A | 84060 |
| ZJ0115010B | 84060 |
| ZJ0115010C | 84060 |

| MEGA | |
|-------------|--------------|
| 120158 | 81513 |
| 120723 | 81556 |
| 120725 | 81513 |
| 1201E3 | 81556 |
| 19109800 | 81560 |
| 49152500 | 81560 |
| 9451001263 | 81556 |
| 9608564280 | 81513 |
| 9617376980 | 81556 |
| 32641Q | 81560 |
| 44854W | 81560 |

| MERCEDES-BENZ | |
|----------------------|--------------|
| 0002000301 | 81773 |
| 0002000701 | 81773 |
| 1022000520 | 81509 |
| 1022000620 | 81509 |
| 1022000920 | 81509 |
| 1022001120 | 81509 |
| 1022003901 | 81509 |
| 1022004901 | 81509 |
| 1022005001 | 81509 |
| 1032000701 | 81507 |
| 1032001701 | 81507 |
| 1032002601 | 81507 |
| 1032003701 | 81507 |
| 1042001301 | 81724 |
| 1042002701 | 81724 |
| 1042002801 | 81722 |
| 1042003001 | 81724 |
| 1042003201 | 81724 |
| 1042003301 | 81722 |

| | |
|------------|------------------------|
| OES | MAGNETI MARELLI |
|------------|------------------------|

| MERCEDES-BENZ | |
|----------------------|--------------|
| 1042004401 | 81722 |
| 1042004501 | 81722 |
| 1042004601 | 81724 |
| 1042004701 | 81722 |
| 1042004801 | 81724 |
| 1042004901 | 81722 |
| 1112000401 | 81499 |
| 1112002101 | 81728 |
| 1112002201 | 81774 |
| 1112002301 | 81725 |
| 1112002401 | 81729 |
| 1112003901 | 81729 |
| 1112004001 | 81499 |
| 1122000110 | 81730 |
| 1122000123 | 81730 |
| 1122000201 | 81730 |
| 1122000401 | 81730 |
| 1122000901 | 81730 |
| 1122001101 | 81730 |
| 1122001401 | 81730 |
| 1662000320 | 82087 |
| 1662000420 | 82087 |
| 1662000520 | 82087 |
| 1662000620 | 82087 |
| 1662000720 | 82087 |
| 2002000001 | 84003 |
| 2662000720 | 82017 |
| 2662000820 | 82017 |
| 2712000201 | 84004 |
| 2712000201 | 84004 |
| 2712000401 | 84004 |
| 2712000401 | 84004 |
| 2712000501 | 84002 |
| 2712000601 | 84004 |
| 2712000901 | 84002 |
| 2712001001 | 84004 |
| 2712001001 | 84004 |
| 6012000220 | 81504 |
| 6012000720 | 81504 |
| 6012000920 | 81504 |
| 6012001120 | 81723 |
| 6022000020 | 81506 |
| 6022000120 | 81506 |
| 6022000220 | 81506 |
| 6022000420 | 81506 |

| | |
|------------|------------------------|
| OES | MAGNETI MARELLI |
|------------|------------------------|

| MERCEDES-BENZ | |
|----------------------|--------------|
| 6022000520 | 81506 |
| 6052000120 | 81726 |
| 6052000320 | 81726 |
| 6052000520 | 81726 |
| 6052000820 | 81726 |
| 6072000007 | 82098 |
| 6112000201 | 82088 |
| 6112000401 | 82030 |
| 6112000501 | 82047 |
| 6112001001 | 82030 |
| 6112001101 | 82047 |
| 6112001201 | 82088 |
| 6132000701 | 82084 |
| 6162000420 | 81508 |
| 6162000720 | 81508 |
| 6262000007 | 84034 |
| 6402000301 | 82017 |
| 6422000701 | 82058 |
| 6422001001 | 82059 |
| 6422001301 | 82058 |
| 6422001701 | 82058 |
| 6422002201 | 82058 |
| 6462000301 | 82082 |
| 6462000501 | 82052 |
| 6462001001 | 82052 |
| 6462001301 | 82052 |
| 6462001601 | 82052 |
| 6512000201 | 84025 |
| 6512000401 | 84046 |
| 6512001101 | 84044 |
| 6512001301 | 84044 |
| 6512001901 | 84044 |
| 6512002100 | 84044 |
| 6512002301 | 84025 |
| 6512003101 | 84046 |
| 6512003301 | 84046 |
| 6512003501 | 84047 |
| 6512004101 | 84048 |
| 6512006401 | 84044 |
| 6512006801 | 84044 |
| 602200022080 | 81506 |
| 646200160180 | 82052 |

| | |
|------------|------------------------|
| OES | MAGNETI MARELLI |
|------------|------------------------|

| MG | |
|-----------|--------------|
| GWP2602 | 82029 |
| GWP333 | 81615 |
| PEB102240 | 82029 |

| MINI | |
|-------------|--|
|-------------|--|

| | |
|-------------|--------------|
| 11511485846 | 81861 |
| 11517510803 | 81861 |
| 11517513062 | 81861 |
| 11517520123 | 84013 |
| 11517550484 | 82032 |
| 11517790871 | 81821 |
| 11517805992 | 81869 |
| 11517829914 | 81861 |
| 11517829922 | 81861 |
| 11518512443 | 84026 |
| 11518577891 | 84050 |
| 11518577893 | 84051 |
| 11518586719 | 84050 |
| 11518586721 | 84051 |
| 11518623574 | 84049 |

| MITSUBISHI | |
|-------------------|--|
|-------------------|--|

| | |
|-----------|--------------|
| 1300A095 | 82049 |
| 1300A097 | 84042 |
| 1300A107 | 82049 |
| M345611 | 81574 |
| M855991 | 81574 |
| MD030863 | 81784 |
| MD050450 | 81787 |
| MD168048 | 81787 |
| MD168050 | 81787 |
| MD179030 | 81731 |
| MD300799 | 81731 |
| MD301847 | 81787 |
| MD306414 | 81731 |
| MD4667660 | 81733 |
| MD664616 | 81787 |
| MD972001 | 81787 |
| MD972052 | 81786 |
| MD972456 | 81731 |
| MD974649 | 81784 |
| MD997076 | 81784 |
| MD997084 | 81787 |
| MD997150 | 81787 |
| MD997151 | 81787 |

| | |
|------------|------------------------|
| OES | MAGNETI MARELLI |
|------------|------------------------|

| MITSUBISHI | |
|-------------------|--------------|
| MD997160 | 81787 |
| MD997170 | 81787 |
| MD997417 | 81786 |
| MD997609 | 81784 |
| MD997618 | 81787 |
| MD997621 | 81786 |
| MN143664 | 82049 |
| MN980134 | 84011 |
| MN980266 | 84011 |
| MN982187 | 82068 |
| MN982325 | 82068 |
| MN982556 | 81869 |
| MW30620725 | 81814 |

| NISSAN | |
|---------------|--|
|---------------|--|

| | |
|------------|--------------|
| 7701472182 | 81814 |
| 7701472625 | 81855 |
| 7701474190 | 81855 |
| 8200129206 | 81855 |
| 2101000Q0C | 82069 |
| 2101000Q0E | 81810 |
| 2101000Q0E | 84007 |
| 2101000Q0M | 82098 |
| 2101000Q2C | 84034 |
| 2101000Q2F | 84003 |
| 2101000QAS | 81810 |
| 210100M300 | 81744 |
| 210100M301 | 81744 |
| 2101019B25 | 81743 |
| 210101F700 | 81742 |
| 210101HC0A | 84003 |
| 2101024B25 | 81743 |
| 210103AA0B | 84003 |
| 2101041B02 | 81742 |
| 2101041B03 | 81742 |
| 210104A00F | 84017 |
| 2101053J00 | 81736 |
| 2101053J01 | 81736 |
| 2101053Y00 | 81744 |
| 2101053Y01 | 81744 |
| 2101057J00 | 81745 |
| 2101057J01 | 81745 |
| 2101057J02 | 81745 |
| 2101057J03 | 81745 |
| 2101057J25 | 81745 |

| | |
|------------|------------------------|
| OES | MAGNETI MARELLI |
|------------|------------------------|

| NISSAN | |
|---------------|---------------|
| 2101057J26 | 81745 |
| 2101057J27 | 81745 |
| 210106N225 | 84061 |
| 210106N226 | 84061 |
| 2101070J00 | 81736 |
| 2101071J00 | 81744 |
| 2101099B00 | 81742 |
| 210109C600 | 82053 |
| 210109F600 | 82028 |
| 210109F605 | 82028 |
| 21010AD200 | 82023 |
| 21010AD225 | 82023 |
| 21010AD226 | 82023 |
| 21010AW300 | 81868 |
| 21010BN700 | 81810 |
| 21010BX000 | 82014 |
| 21010ED00A | 84003 |
| 21010ED025 | 84003 |
| 21010EE025 | 84003 |
| 21010G5510 | 82054 |
| 21010G5526 | 82054 |
| 21010G5585 | 82054 |
| 21010G5586 | 82054 |
| 21010G5594 | 82054 |
| 21010G8215 | 82054 |
| 21010R7400 | 11706T |
| B10101HC0A | 84003 |
| B1010ED00A | 84003 |
| BA010G5586 | 82054 |
| BA010G8125 | 82054 |

| OPEL | |
|-------------|--|
|-------------|--|

| | |
|---------|--------------|
| 1151669 | 81362 |
| 1334004 | 81543 |
| 1334008 | 81606 |
| 1334011 | 81681 |
| 1334014 | 81605 |
| 1334016 | 81684 |
| 1334023 | 81543 |
| 1334024 | 81681 |
| 1334025 | 81549 |
| 1334027 | 81544 |
| 1334031 | 81687 |
| 1334034 | 81685 |
| 1334041 | 81550 |

| | |
|------------|------------------------|
| OES | MAGNETI MARELLI |
|------------|------------------------|

| OPEL | |
|-------------|--------------|
| 1334046 | 82005 |
| 1334050 | 81550 |
| 1334052 | 81687 |
| 1334053 | 81550 |
| 1334054 | 81551 |
| 1334059 | 81846 |
| 1334065 | 81549 |
| 1334066 | 82005 |
| 1334067 | 81812 |
| 1334069 | 81847 |
| 1334070 | 81543 |
| 1334071 | 81544 |
| 1334072 | 81846 |
| 1334073 | 81836 |
| 1334075 | 81812 |
| 1334077 | 81817 |
| 1334078 | 81818 |
| 1334079 | 81749 |
| 1334082 | 81795 |
| 1334083 | 81812 |
| 1334098 | 81549 |
| 1334102 | 81685 |
| 1334105 | 81687 |
| 1334107 | 81685 |
| 1334112 | 81597 |
| 1334114 | 81748 |
| 1334115 | 81746 |
| 1334117 | 81747 |
| 1334118 | 81747 |
| 1334119 | 81550 |
| 1334121 | 81750 |
| 1334123 | 81362 |
| 1334124 | 81597 |
| 1334128 | 84027 |
| 1334130 | 81749 |
| 1334131 | 81846 |
| 1334135 | 81751 |
| 1334137 | 81550 |
| 1334139 | 81550 |
| 1334140 | 81846 |
| 1334142 | 82083 |
| 1334143 | 81836 |
| 1334145 | 82011 |
| 1334147 | 81872 |
| 1334147 | 81872 |

| OES | MAGNETI MARELLI |
|-------------|-----------------|
| OPEL | |
| 1334154 | 81812 |
| 1334166 | 82011 |
| 1334169 | 84027 |
| 1334190 | 82070 |
| 1334207 | 81862 |
| 1334210 | 84027 |
| 1334219 | 84027 |
| 1334228 | 84027 |
| 1334240 | 84053 |
| 1334242 | 81872 |
| 1334268 | 84005 |
| 1334282 | 81812 |
| 1334284 | 81872 |
| 1334284 | 81872 |
| 1334647 | 81862 |
| 1334648 | 84057 |
| 1334711 | 81862 |
| 1334756 | 81750 |
| 4401595 | 81855 |
| 4404098 | 81574 |
| 4408028 | 81814 |
| 4409162 | 81574 |
| 4431125 | 82069 |
| 4501293 | 81834 |
| 4501294 | 81835 |
| 4506045 | 81855 |
| 4708767 | 81862 |
| 4709352 | 84017 |
| 4804957 | 81812 |
| 4805174 | 84014 |
| 4813567 | 81812 |
| 6334000 | 81550 |
| 6334001 | 81862 |
| 6334002 | 81812 |
| 6334003 | 81352 |
| 6334019 | 81836 |
| 6334035 | 81817 |
| 6334038 | 81847 |
| 6334039 | 81818 |
| 6334042 | 81812 |
| 6334043 | 84057 |
| 6334048 | 81836 |
| 9109595 | 81855 |
| 9161593 | 81834 |
| 9161594 | 81835 |

| OES | MAGNETI MARELLI |
|-------------|-----------------|
| OPEL | |
| 9192370 | 81550 |
| 9192793 | 81549 |
| 9192797 | 82005 |
| 9194747 | 81812 |
| 9199592 | 81817 |
| 9199595 | 81818 |
| 12585226 | 81812 |
| 12591894 | 81812 |
| 12658266 | 84053 |
| 12667387 | 84053 |
| 12855462 | 81862 |
| 24405895 | 82083 |
| 24439798 | 81812 |
| 24461382 | 81812 |
| 24467301 | 81812 |
| 24469102 | 82011 |
| 25192709 | 84027 |
| 25193406 | 84027 |
| 55221397 | 82070 |
| 55561623 | 84027 |
| 55579016 | 84027 |
| 55595610 | 84027 |
| 90076952 | 81543 |
| 90091035 | 81544 |
| 90144227 | 81549 |
| 90183273 | 81543 |
| 90220568 | 81606 |
| 90234200 | 81681 |
| 90284913 | 81605 |
| 90325660 | 81549 |
| 90325661 | 81681 |
| 90349239 | 81549 |
| 90349241 | 81543 |
| 90409912 | 81544 |
| 90443549 | 81550 |
| 90444079 | 82005 |
| 90444123 | 81551 |
| 90444311 | 81550 |
| 90444649 | 81846 |
| 90512535 | 81597 |
| 90540478 | 81747 |
| 90541671 | 81597 |
| 90542606 | 81749 |
| 90543277 | 81846 |
| 90543935 | 81751 |

| OES | MAGNETI MARELLI |
|----------------|-----------------|
| OPEL | |
| 91159773 | 81814 |
| 92149009 | 84057 |
| 93161595 | 82069 |
| 93170142 | 81749 |
| 93170697 | 81846 |
| 93178602 | 81812 |
| 93179114 | 81872 |
| 93179114 | 81872 |
| 93182041 | 81847 |
| 93182042 | 81818 |
| 93182043 | 81747 |
| 93189336 | 81862 |
| 93194246 | 84017 |
| 93195466 | 81862 |
| 94124093 | 81684 |
| 94341998 | 81687 |
| 94386207 | 81685 |
| 96440224 | 84014 |
| 97101319 | 81685 |
| 97101320 | 81687 |
| 97110386 | 81685 |
| 97110387 | 81687 |
| 97114682 | 81746 |
| 97114683 | 81748 |
| 97135548 | 81750 |
| 97220278 | 81847 |
| 97287175 | 81836 |
| 97351178 | 81836 |
| 98109416 | 84005 |
| 7701479043 | 81814 |
| R1160032 | 81550 |
| PEUGEOT | |
| 1201E0 | 81353 |
| 1201E1 | 82089 |
| 1201E1 | 84038 |
| 1201E1 | 82089 |
| 1201E1 | 81799 |
| 1201E3 | 81556 |
| 1201E4 | 81513 |
| 1201E5 | 81753 |
| 1201E6 | 81513 |
| 1201E7 | 82089 |
| 1201E7 | 84038 |
| 1201E7 | 82089 |

| | |
|------------|------------------------|
| OES | MAGNETI MARELLI |
|------------|------------------------|

| PEUGEOT | |
|----------------|-------|
| 1201E7 | 81799 |
| 1201E8 | 81800 |
| 1201E9 | 81813 |
| 1201A1 | 81711 |
| 1201A2 | 81753 |
| 1201A3 | 81752 |
| 1201A4 | 81642 |
| 1201A5 | 81712 |
| 1201A6 | 81844 |
| 1201A7 | 81353 |
| 1201A8 | 81642 |
| 1201C4 | 81713 |
| 1201C5 | 81353 |
| 1201C6 | 81353 |
| 1201C7 | 81844 |
| 1201C9 | 81316 |
| 1201F2 | 82042 |
| 1201F4 | 82089 |
| 1201F4 | 84038 |
| 1201F4 | 82089 |
| 1201F4 | 81799 |
| 1201F5 | 82089 |
| 1201F5 | 84038 |
| 1201F5 | 82089 |
| 1201F5 | 81799 |
| 1201F6 | 81813 |
| 1201F9 | 81798 |
| 1201G0 | 81797 |
| 1201G1 | 81869 |
| 1201G2 | 82016 |
| 1201G4 | 82089 |
| 1201G4 | 84038 |
| 1201G4 | 82089 |
| 1201G4 | 81799 |
| 1201G5 | 82089 |
| 1201G5 | 84038 |
| 1201G5 | 82089 |
| 1201G5 | 81799 |
| 1201G6 | 82067 |
| 1201G8 | 81798 |
| 1201G9 | 81869 |
| 1201H0 | 82063 |
| 1201H0 | 82063 |
| 1201H4 | 81753 |
| 1201H5 | 81316 |

| | |
|------------|------------------------|
| OES | MAGNETI MARELLI |
|------------|------------------------|

| PEUGEOT | |
|----------------|-------|
| 1201H6 | 82066 |
| 1201H7 | 82068 |
| 1201H8 | 82032 |
| 1201J0 | 82063 |
| 1201J0 | 82063 |
| 1201J1 | 82089 |
| 1201J1 | 81799 |
| 1201J2 | 82089 |
| 1201J2 | 84038 |
| 1201J2 | 82089 |
| 1201J2 | 81799 |
| 1201J4 | 82094 |
| 1201J6 | 82068 |
| 1201K0 | 82094 |
| 1201K1 | 82089 |
| 1201K1 | 84038 |
| 1201K1 | 82089 |
| 1201K2 | 84020 |
| 1201K5 | 84019 |
| 1201K8 | 81869 |
| 1201L2 | 82089 |
| 1201L2 | 84038 |
| 1201L2 | 82089 |
| 1201L3 | 82063 |
| 1201L9 | 81862 |
| 120119 | 81552 |
| 120129 | 81552 |
| 120130 | 81671 |
| 120134 | 81367 |
| 120136 | 81822 |
| 120137 | 81822 |
| 120139 | 81554 |
| 120140 | 81367 |
| 120145 | 81560 |
| 120148 | 81672 |
| 120150 | 81512 |
| 120151 | 81672 |
| 120152 | 81642 |
| 120154 | 81353 |
| 120155 | 81353 |
| 120158 | 81513 |
| 120160 | 81672 |
| 120161 | 81512 |
| 120162 | 81512 |
| 120163 | 81554 |

| | |
|------------|------------------------|
| OES | MAGNETI MARELLI |
|------------|------------------------|

| PEUGEOT | |
|----------------|-------|
| 120165 | 81642 |
| 120167 | 81642 |
| 120170 | 81752 |
| 120182 | 81753 |
| 120191 | 81642 |
| 120193 | 81711 |
| 120195 | 81368 |
| 120196 | 81346 |
| 120198 | 81710 |
| 120239 | 81671 |
| 120240 | 81552 |
| 120250 | 81552 |
| 120255 | 81552 |
| 120256 | 81671 |
| 120258 | 81572 |
| 120267 | 81552 |
| 120268 | 81671 |
| 120434 | 81572 |
| 120718 | 81556 |
| 120723 | 81556 |
| 120725 | 81513 |
| 96047088 | 81353 |
| 504033770 | 82024 |
| 1607854280 | 82049 |
| 1609402180 | 81800 |
| 1609417380 | 81798 |
| 1609417480 | 84038 |
| 1609417480 | 82089 |
| 1611550180 | 84054 |
| 1613518580 | 84020 |
| 9451001263 | 81556 |
| 9608564280 | 81513 |
| 9617376980 | 81556 |
| 9801573380 | 82032 |
| 9803094380 | 84066 |
| 9803442480 | 84066 |
| 94012010390 | 81554 |

| PUCH | |
|-------------|-------|
| 1032002601 | 81507 |
| 6022000020 | 81506 |
| 6022000220 | 81506 |

| OES | MAGNETI MARELLI |
|-----|-----------------|
|-----|-----------------|

| RENAULT | |
|------------|-------|
| 7303056 | 81491 |
| 5001001274 | 81334 |
| 7438610006 | 82056 |
| 7438610006 | 82056 |
| 7438610035 | 82056 |
| 7438610035 | 82056 |
| 7700105176 | 84039 |
| 7700105176 | 81806 |
| 7700105378 | 84039 |
| 7700105378 | 81806 |
| 7700106101 | 81761 |
| 7700107845 | 81761 |
| 7700274330 | 84039 |
| 7700274330 | 81806 |
| 7700736091 | 81661 |
| 7700859931 | 81760 |
| 7700861627 | 81761 |
| 7700861686 | 81579 |
| 7700864596 | 81762 |
| 7700866518 | 81578 |
| 7700871801 | 81760 |
| 7701041348 | 81762 |
| 7701459820 | 81572 |
| 7701460145 | 81828 |
| 7701461006 | 81828 |
| 7701461336 | 81664 |
| 7701461405 | 81576 |
| 7701462145 | 81573 |
| 7701462145 | 81811 |
| 7701462491 | 81573 |
| 7701462491 | 81811 |
| 7701462808 | 81334 |
| 7701462809 | 81574 |
| 7701463014 | 81660 |
| 7701463111 | 81574 |
| 7701463182 | 81576 |
| 7701463377 | 81573 |
| 7701463377 | 81811 |
| 7701463397 | 81574 |
| 7701464030 | 81608 |
| 7701464054 | 81756 |
| 7701464054 | 81853 |
| 7701464736 | 81574 |
| 7701465122 | 81851 |
| 7701465513 | 81666 |

| OES | MAGNETI MARELLI |
|-----|-----------------|
|-----|-----------------|

| RENAULT | |
|------------|-------|
| 7701465643 | 81755 |
| 7701465816 | 81574 |
| 7701466152 | 81754 |
| 7701466419 | 81573 |
| 7701466419 | 81811 |
| 7701466420 | 81756 |
| 7701466420 | 81853 |
| 7701466571 | 81667 |
| 7701466578 | 81574 |
| 7701466778 | 81757 |
| 7701466779 | 81758 |
| 7701466788 | 81759 |
| 7701467153 | 81596 |
| 7701467153 | 81854 |
| 7701467223 | 81608 |
| 7701467278 | 81325 |
| 7701467622 | 81760 |
| 7701467642 | 81852 |
| 7701468342 | 81334 |
| 7701468491 | 81574 |
| 7701470879 | 81834 |
| 7701470880 | 81835 |
| 7701472182 | 81814 |
| 7701472625 | 81855 |
| 7701473327 | 81810 |
| 7701473365 | 81574 |
| 7701473784 | 81334 |
| 7701474190 | 81855 |
| 7701474435 | 81868 |
| 7701475995 | 84007 |
| 7701476496 | 81810 |
| 7701478018 | 81579 |
| 7701478031 | 81810 |
| 7701478031 | 84007 |
| 7701478830 | 82098 |
| 7701478846 | 82099 |
| 7701478923 | 82090 |
| 7701478924 | 82091 |
| 7701478925 | 84024 |
| 7701479043 | 84009 |
| 7701479114 | 84006 |
| 7701633125 | 81661 |
| 7703002053 | 81762 |
| 7901120258 | 81572 |
| 8200037682 | 82091 |

| OES | MAGNETI MARELLI |
|-----|-----------------|
|-----|-----------------|

| RENAULT | |
|------------|-------|
| 8200042514 | 81761 |
| 8200042880 | 81820 |
| 8200088663 | 81762 |
| 8200129206 | 81855 |
| 8200146297 | 84039 |
| 8200146297 | 81806 |
| 8200146298 | 81579 |
| 8200146301 | 81578 |
| 8200238333 | 81820 |
| 8200266947 | 81762 |
| 8200266950 | 81820 |
| 8200332040 | 82069 |
| 8200397732 | 82090 |
| 8200397735 | 82091 |
| 8200428447 | 84039 |
| 8200428447 | 81806 |
| 8200582675 | 84039 |
| 8200582675 | 81806 |
| 8200702750 | 82090 |
| 8200702755 | 82091 |
| 8200702762 | 84024 |
| 8671019520 | 82091 |
| 9635018180 | 82042 |
| 9637506680 | 81844 |
| 9640344280 | 81844 |
| 9641117180 | 81813 |
| 210100906R | 84003 |
| 210101832R | 82090 |
| 210103314R | 82091 |
| 210105296R | 84039 |
| 210105296R | 81806 |
| 210108030R | 84003 |
| 210108796R | 84034 |
| 210108845R | 82090 |
| 210109189R | 84024 |

| ROVER | |
|---------|-------|
| 12G120 | 81419 |
| 12G1771 | 81419 |
| GWP101 | 81419 |
| GWP102 | 81419 |
| GWP104 | 81419 |
| GWP105 | 81419 |
| GWP1143 | 81611 |
| GWP117 | 81419 |

| | |
|------------|------------------------|
| OES | MAGNETI MARELLI |
|------------|------------------------|

| ROVER | |
|--------------|-------|
| GWP132 | 81419 |
| GWP134 | 81419 |
| GWP193 | 81707 |
| GWP195 | 81556 |
| GWP2154 | 81843 |
| GWP2155 | 81843 |
| GWP2157 | 81613 |
| GWP2161 | 81613 |
| GWP2162 | 81302 |
| GWP2163 | 81613 |
| GWP2166 | 81843 |
| GWP2523 | 81362 |
| GWP2602 | 82029 |
| GWP333 | 81615 |
| GWP336 | 81614 |
| GWP337 | 81672 |
| GWP338 | 81672 |
| GWP341 | 81556 |
| GWP342 | 81708 |
| GWP343 | 81709 |
| GWP345 | 81708 |
| GWP346 | 81556 |
| GWP347 | 81707 |
| PEB102010 | 81707 |
| PEB102240 | 82029 |
| PEB102420 | 81707 |
| PEB102420L | 81707 |

| SAAB | |
|-------------|-------|
| 1334117 | 81747 |
| 1334118 | 81747 |
| 1334648 | 84057 |
| 4770970 | 81846 |
| 4772711 | 81747 |
| 8821944 | 81846 |
| 8822710 | 81764 |
| 8822744 | 81764 |
| 8822793 | 81764 |
| 9321951 | 81764 |
| 12566029 | 84057 |
| 12621284 | 81812 |
| 12630084 | 81812 |
| 55488983 | 81872 |
| 55568637 | 81872 |
| 55568637 | 81872 |

| | |
|------------|------------------------|
| OES | MAGNETI MARELLI |
|------------|------------------------|

| SAAB | |
|-------------|-------|
| 90540478 | 81747 |
| 93181118 | 81812 |
| 93191762 | 81872 |
| 93191762 | 81872 |
| 125888982 | 84057 |

| SEAT | |
|-------------|-------|
| 021121004 | 81773 |
| 022121011 | 81866 |
| 026121005 | 81522 |
| 026121010 | 82080 |
| 026121010 | 82080 |
| 028121004 | 81528 |
| 031121004 | 81525 |
| 036121005 | 81776 |
| 037121010 | 82080 |
| 037121010 | 82080 |
| 038121011 | 81706 |
| 045121011 | 81791 |
| 071121005 | 81856 |
| 0131121005A | 81525 |
| 021121004V | 81773 |
| 021121004X | 81773 |
| 022121011X | 81866 |
| 026121005A | 81522 |
| 026121005C | 81522 |
| 026121005E | 81522 |
| 026121005G | 81522 |
| 026121005H | 81522 |
| 026121010C | 82080 |
| 026121010C | 82080 |
| 026121010CV | 82080 |
| 026121010CV | 82080 |
| 026121010CX | 82080 |
| 026121010CX | 82080 |
| 026121010E | 82080 |
| 026121010E | 82080 |
| 026121010F | 82080 |
| 026121010F | 82080 |
| 026121010FV | 82080 |
| 026121010FV | 82080 |
| 026121010FX | 82080 |
| 026121010FX | 82080 |
| 026121010V | 82080 |
| 026121010V | 82080 |

| | |
|------------|------------------------|
| OES | MAGNETI MARELLI |
|------------|------------------------|

| SEAT | |
|-------------|-------|
| 026121010X | 82080 |
| 026121010X | 82080 |
| 028121004V | 81528 |
| 028121004X | 81528 |
| 030121004A | 81524 |
| 030121004B | 81524 |
| 030121005D | 81527 |
| 030121005H | 81524 |
| 030121005L | 81524 |
| 030121005LV | 81524 |
| 030121005LX | 81524 |
| 030121005N | 81527 |
| 030121005NV | 81527 |
| 030121005NX | 81527 |
| 030121005S | 81775 |
| 030121005T | 81527 |
| 030121005TV | 81527 |
| 030121005TX | 81527 |
| 030121008A | 81775 |
| 030121008AV | 81775 |
| 030121008AX | 81775 |
| 030121008C | 81775 |
| 030121008D | 81527 |
| 030121008M | 81527 |
| 031121004A | 81525 |
| 031121004AV | 81525 |
| 031121004AX | 81525 |
| 031121004V | 81525 |
| 031121004X | 81525 |
| 031121005A | 81525 |
| 031121005C | 81525 |
| 031121005CV | 81525 |
| 031121005CX | 81525 |
| 036121005D | 81776 |
| 036121005DX | 81776 |
| 036121005E | 81777 |
| 036121005EV | 81777 |
| 036121005EX | 81777 |
| 036121005F | 81840 |
| 036121005G | 81840 |
| 036121005GX | 81840 |
| 036121005M | 81776 |
| 036121005P | 81840 |
| 036121005Q | 81777 |
| 036121005QX | 81777 |

| OES | MAGNETI MARELLI |
|-------------|-----------------|
| SEAT | |
| 036121005S | 81777 |
| 036121005SV | 81777 |
| 036121005SX | 81777 |
| 036121008G | 81840 |
| 036121008GX | 81840 |
| 036121008K | 81777 |
| 036121008L | 81777 |
| 036121008LX | 81777 |
| 036121008M | 81777 |
| 036121008MX | 81777 |
| 037121010A | 82080 |
| 037121010A | 82080 |
| 037121010AV | 82080 |
| 037121010AV | 82080 |
| 037121010AX | 82080 |
| 037121010AX | 82080 |
| 037121010BX | 82080 |
| 037121010BX | 82080 |
| 037121010C | 82080 |
| 037121010C | 82080 |
| 038121011A | 81706 |
| 038121011AV | 81706 |
| 038121011AX | 81706 |
| 038121011C | 81816 |
| 038121011CX | 81816 |
| 038121011D | 81816 |
| 038121011G | 84011 |
| 038121011GX | 84011 |
| 038121011H | 84011 |
| 038121011HX | 84011 |
| 038121011JX | 84011 |
| 038121011KX | 84011 |
| 03C121005LX | 81865 |
| 03C121005N | 82097 |
| 03C121005NX | 82097 |
| 03C121005R | 82097 |
| 03C121005RX | 82097 |
| 03C121005S | 81865 |
| 03C121008B | 82097 |
| 03C121008C | 81865 |
| 03C121008CX | 81865 |
| 03C121008E | 82097 |
| 03C121008F | 81865 |
| 03C121008FX | 81865 |
| 03C121008J | 81865 |

| OES | MAGNETI MARELLI |
|-------------|-----------------|
| SEAT | |
| 03C121008JX | 81865 |
| 03D121005 | 81867 |
| 03D121005X | 81867 |
| 03D121013B | 81867 |
| 03F121004A | 84045 |
| 03F121004B | 84045 |
| 03F121004D | 84045 |
| 03F121004E | 84045 |
| 03F121004EX | 84045 |
| 03F121004F | 84045 |
| 03F121005 | 84045 |
| 03L121011 | 84001 |
| 03L121011H | 84001 |
| 03L121011J | 84001 |
| 03L121011P | 84001 |
| 045121011B | 81791 |
| 045121011C | 84052 |
| 045121011F | 84010 |
| 045121011FX | 84010 |
| 045121011G | 82013 |
| 045121011HX | 84010 |
| 045121011J | 82013 |
| 047121013J | 81807 |
| 04C121600K | 84062 |
| 04E121600AD | 84062 |
| 04E121600AG | 84062 |
| 04E121600AL | 84062 |
| 04E121600AQ | 84062 |
| 04E121600AR | 84062 |
| 04E121600D | 84062 |
| 04E121600H | 84062 |
| 04E121600P | 84062 |
| 066121011C | 81856 |
| 066121011CX | 81856 |
| 066121011D | 81856 |
| 068121005A | 81522 |
| 068121010A | 82080 |
| 068121010A | 82080 |
| 068121010AX | 82080 |
| 068121010AX | 82080 |
| 068121011E | 81703 |
| 06A121011C | 81703 |
| 06A121011E | 81703 |
| 06A121011EV | 81703 |
| 06A121011EX | 81703 |

| OES | MAGNETI MARELLI |
|-------------|-----------------|
| SEAT | |
| 06A121011F | 81703 |
| 06A121011G | 81703 |
| 06A121011H | 81703 |
| 06A121011HV | 81703 |
| 06A121011HX | 81703 |
| 06A121011L | 81703 |
| 06A121011LV | 81703 |
| 06A121011LX | 81703 |
| 06A121011T | 81703 |
| 06A121011TX | 81703 |
| 06A121012D | 81703 |
| 06A121012G | 81703 |
| 06B121011 | 81702 |
| 06B121011A | 81702 |
| 06B121011B | 81702 |
| 06B121011BV | 81702 |
| 06B121011BX | 81702 |
| 06B121011C | 81702 |
| 06B121011CV | 81702 |
| 06B121011CX | 81702 |
| 06B121011E | 81702 |
| 06B121011EV | 81702 |
| 06B121011EX | 81702 |
| 06B121011H | 81702 |
| 06B121011L | 81702 |
| 06B121011LX | 81702 |
| 06B121011M | 81702 |
| 06B121011N | 81702 |
| 06B121011NX | 81702 |
| 06B121011Q | 81702 |
| 06C121004C | 81819 |
| 06C121004G | 81819 |
| 06C121004H | 81819 |
| 06C121004HX | 81819 |
| 06E121018A | 82015 |
| 06F121011 | 82025 |
| 06F121011X | 82025 |
| 06H121026AF | 84016 |
| 06H121026BA | 84016 |
| 06H121026BE | 84016 |
| 06H121026BF | 84016 |
| 06H121026CC | 84016 |
| 06H121026CF | 84016 |
| 06H121026CP | 84016 |
| 06H121026CQ | 84016 |

OES
SEAT

| | |
|--------------|--------------|
| 06H121026DD | 84016 |
| 06K121011 | 84037 |
| 06L121005A | 84037 |
| 06L121012 | 84037 |
| 06L121012A | 84037 |
| HB03200000 | 81415 |
| SE020032000A | 81415 |
| SE021032000A | 81498 |
| SE700032000C | 81497 |

SKODA

| | |
|-------------|--------------|
| 028121004 | 81528 |
| 038121011 | 81706 |
| 045121011 | 81791 |
| 078121006 | 81842 |
| 028121004V | 81528 |
| 028121004X | 81528 |
| 030121005D | 81527 |
| 030121005N | 81527 |
| 030121005NV | 81527 |
| 030121005NX | 81527 |
| 036121005E | 81777 |
| 036121005EV | 81777 |
| 036121005EX | 81777 |
| 036121005Q | 81777 |
| 036121005QX | 81777 |
| 036121005S | 81777 |
| 036121005SV | 81777 |
| 036121005SX | 81777 |
| 036121008K | 81777 |
| 036121008KX | 81777 |
| 036121008L | 81777 |
| 036121008M | 81777 |
| 036121008MX | 81777 |
| 038121011A | 81706 |
| 038121011AV | 81706 |
| 038121011AX | 81706 |
| 038121011C | 81816 |
| 038121011CX | 81816 |
| 038121011D | 81816 |
| 038121011G | 84011 |
| 038121011GX | 84011 |
| 038121011H | 84011 |
| 038121011HX | 84011 |
| 038121011J | 84011 |

OES
SKODA

| | |
|-------------|--------------|
| 038121011JX | 84011 |
| 038121011KX | 84011 |
| 03C121005B | 81865 |
| 03C121005C | 81865 |
| 03C121005D | 81865 |
| 03C121005DX | 81865 |
| 03C121005K | 81865 |
| 03C121005KX | 81865 |
| 03C121005L | 81865 |
| 03C121005S | 81865 |
| 03C121008C | 81865 |
| 03C121008CX | 81865 |
| 03C121008F | 81865 |
| 03C121008FX | 81865 |
| 03C121008J | 81865 |
| 03C121008JX | 81865 |
| 03D121005 | 81867 |
| 03D121005X | 81867 |
| 03D121013B | 81867 |
| 03F121004A | 84045 |
| 03F121004B | 84045 |
| 03F121004D | 84045 |
| 03F121005 | 84045 |
| 03L121011 | 84001 |
| 03L121011G | 84011 |
| 03L121011GX | 84011 |
| 03L121011H | 84001 |
| 03L121011J | 84001 |
| 03L121011P | 84001 |
| 045121011B | 81791 |
| 045121011BX | 81791 |
| 045121011C | 84052 |
| 045121011F | 84010 |
| 045121011FX | 84010 |
| 045121011G | 82013 |
| 045121011H | 84010 |
| 045121011HX | 84010 |
| 045121011J | 82013 |
| 04C121600K | 84062 |
| 04E121600AD | 84062 |
| 04E121600AG | 84062 |
| 04E121600AL | 84062 |
| 04E121600AQ | 84062 |
| 04E121600AR | 84062 |
| 04E121600D | 84062 |

OES
SKODA

| | |
|-------------|--------------|
| 04E121600H | 84062 |
| 04E121600P | 84062 |
| 059121004B | 81705 |
| 059121004C | 81705 |
| 059121004CX | 81705 |
| 059121004D | 81705 |
| 059121004E | 81705 |
| 059121004EV | 81705 |
| 059121004EX | 81705 |
| 06A121011C | 81703 |
| 06A121011E | 81703 |
| 06A121011EV | 81703 |
| 06A121011EX | 81703 |
| 06A121011F | 81703 |
| 06A121011G | 81703 |
| 06A121011H | 81703 |
| 06A121011HV | 81703 |
| 06A121011HX | 81703 |
| 06A121011L | 81703 |
| 06A121011LV | 81703 |
| 06A121011LX | 81703 |
| 06A121011T | 81703 |
| 06A121011TX | 81703 |
| 06A121012G | 81703 |
| 06B121011 | 81702 |
| 06B121011A | 81702 |
| 06B121011B | 81702 |
| 06B121011BV | 81702 |
| 06B121011BX | 81702 |
| 06B121011C | 81702 |
| 06B121011CV | 81702 |
| 06B121011CX | 81702 |
| 06B121011E | 81702 |
| 06B121011EV | 81702 |
| 06B121011EX | 81702 |
| 06B121011H | 81702 |
| 06B121011L | 81702 |
| 06B121011LX | 81702 |
| 06B121011M | 81702 |
| 06B121011N | 81702 |
| 06B121011NX | 81702 |
| 06B121011Q | 81702 |
| 06C121004C | 81819 |
| 06C121004G | 81819 |
| 06C121004H | 81819 |

| OES | MAGNETI MARELLI |
|-----|-----------------|
|-----|-----------------|

| SKODA | |
|-------------|-------|
| 06C121004HX | 81819 |
| 06E121018A | 82015 |
| 06F121011 | 82025 |
| 06F121011X | 82025 |
| 06H121026AB | 84016 |
| 06H121026AF | 84016 |
| 06H121026AG | 84016 |
| 06H121026BA | 84016 |
| 06H121026BE | 84016 |
| 06H121026BF | 84016 |
| 06H121026CC | 84016 |
| 06H121026CP | 84016 |
| 06H121026DD | 84016 |
| 06H121026N | 84016 |
| 06J121026A | 84016 |
| 06J121026AG | 84016 |
| 06J121026F | 84016 |
| 06J121026G | 84016 |
| 06K121011 | 84037 |
| 06L121005A | 84037 |
| 06L121012 | 84037 |
| 06L121012A | 84037 |
| 078121004H | 81842 |
| 078121004HX | 81842 |
| 078121004J | 81842 |
| 078121004JV | 81842 |
| 078121004JX | 81842 |
| 078121004L | 81842 |
| 078121004Q | 81842 |
| 078121004QX | 81842 |
| 078121004R | 81842 |
| 078121006A | 81842 |
| 078121006X | 81842 |

| SMART | |
|------------|-------|
| 1352000001 | 82049 |
| 2002000001 | 84003 |
| 6602000120 | 84012 |
| 3165V003 | 84012 |
| 4681V002 | 84012 |

| OES | MAGNETI MARELLI |
|-----|-----------------|
|-----|-----------------|

| SSANGYONG | |
|------------|-------|
| 1042001301 | 81724 |
| 1042002701 | 81724 |
| 1042003001 | 81724 |
| 1042003201 | 81724 |
| 1042004601 | 81724 |
| 1042004801 | 81724 |
| 6022000220 | 81506 |

| SUBARU | |
|------------|-------|
| 1740082850 | 81858 |

| SUZUKI | |
|------------|-------|
| 1741085E00 | 81862 |
| 1740050812 | 81783 |
| 1740060810 | 81790 |
| 1740060811 | 81790 |
| 1740060812 | 81790 |
| 1740060813 | 81790 |
| 1740060814 | 81790 |
| 1740060815 | 81790 |
| 1740061810 | 81783 |
| 1740061820 | 82050 |
| 1740082810 | 81789 |
| 1740082811 | 81789 |
| 1740082812 | 81789 |
| 1740082823 | 81858 |
| 1740082830 | 81789 |
| 1740082850 | 81858 |
| 1740082851 | 81858 |
| 1740083810 | 81789 |
| 1740083811 | 81789 |
| 1740083812 | 81789 |
| 1740083814 | 81789 |
| 1740083815 | 81789 |
| 1740083820 | 81789 |
| 1740051K00 | 84017 |
| 1740058M00 | 84017 |
| 1740060A02 | 81790 |
| 1740060A04 | 81790 |
| 1740060D01 | 81783 |
| 1740069G00 | 82026 |
| 1740069G01 | 82026 |
| 1740069G02 | 82026 |
| 1740069G04 | 82026 |
| 1740069L00 | 84017 |

| OES | MAGNETI MARELLI |
|-----|-----------------|
|-----|-----------------|

| SUZUKI | |
|-------------|-------|
| 1740070B00 | 81783 |
| 1740073J00 | 81798 |
| 1740078J00 | 84057 |
| 1740079J50 | 81352 |
| 1740079J80 | 81872 |
| 1740079J80 | 81872 |
| 17400A60D01 | 81783 |
| 17400A60D02 | 81783 |
| 17400M67L00 | 84017 |
| 17400M67L10 | 84017 |
| 17400N86J00 | 81862 |
| 1740973J00 | 81798 |
| 1741066G00 | 81642 |
| 1741067G00 | 81713 |
| 1741067JG0 | 81868 |
| 1741084A11 | 84007 |

| TALBOT | |
|-------------|-------|
| 120139 | 81554 |
| 120145 | 81560 |
| 120163 | 81554 |
| 120169 | 81572 |
| 120258 | 81572 |
| 120434 | 81572 |
| 19109800 | 81560 |
| 49152500 | 81560 |
| 7901120258 | 81572 |
| 94012010390 | 81554 |
| 32641Q | 81560 |
| 44854W | 81560 |

| TATA | |
|--------------|-------|
| 570320109901 | 81862 |
| 570420109915 | 82070 |

| TOYOTA | |
|------------|-------|
| 1610009020 | 81767 |
| 1610009050 | 81767 |
| 1610009051 | 81815 |
| 1610009051 | 81766 |
| 1610009060 | 81768 |
| 1610009061 | 81768 |
| 1610009070 | 82051 |
| 1610009080 | 82012 |
| 1610009120 | 81815 |

| | |
|------------|------------------------|
| OES | MAGNETI MARELLI |
|------------|------------------------|

| TOYOTA | |
|---------------|--------------|
| 1610009120 | 81766 |
| 1610009130 | 82012 |
| 1610009140 | 82048 |
| 1610009141 | 82048 |
| 1610009240 | 82063 |
| 1610009240 | 82063 |
| 1610009310 | 82012 |
| 1610009340 | 82071 |
| 1610009450 | 82063 |
| 1610009450 | 82063 |
| 1610009500 | 84030 |
| 1610009501 | 84030 |
| 1610009610 | 84029 |
| 1610009640 | 84054 |
| 1610019105 | 81771 |
| 1610019106 | 81771 |
| 1610019195 | 81771 |
| 1610019225 | 81771 |
| 1610019226 | 81771 |
| 1610019255 | 81815 |
| 1610019255 | 81766 |
| 1610019265 | 81769 |
| 1610019295 | 81815 |
| 1610019295 | 81766 |
| 1610019296 | 81815 |
| 1610019296 | 81766 |
| 1610019305 | 81769 |
| 1610028040 | 82055 |
| 1610028041 | 82055 |
| 1610029085 | 82051 |
| 1610029095 | 82012 |
| 1610029115 | 81808 |
| 1610029125 | 82048 |
| 1610029135 | 82022 |
| 1610029155 | 81809 |
| 1610029156 | 81809 |
| 1610029175 | 82012 |
| 1610029185 | 82044 |
| 1610029195 | 81809 |
| 1610029196 | 81809 |
| 1610029415 | 82012 |
| 1610029495 | 82071 |
| 1610039395 | 81821 |
| 1610039465 | 84030 |
| 1610039466 | 84030 |

| | |
|------------|------------------------|
| OES | MAGNETI MARELLI |
|------------|------------------------|

| TOYOTA | |
|---------------|--------------|
| 1610039525 | 84029 |
| 1610039535 | 84028 |
| 1610040110 | 84031 |
| 1610080003 | 82063 |
| 1610080003 | 82063 |
| 1610080004 | 84032 |
| 1610080005 | 84031 |
| 1610080007 | 82063 |
| 1611009020 | 81815 |
| 1611009021 | 81815 |
| 1611019107 | 81771 |
| 1611019146 | 81815 |
| 1611019185 | 81769 |
| 1611019205 | 81815 |
| 1611079025 | 81770 |
| 1611079026 | 81770 |
| 1611079045 | 81770 |
| 1611079135 | 81770 |
| 161000Q010 | 82063 |
| 161000Q010 | 82063 |
| 16100WA010 | 84026 |
| SU00100204 | 81713 |
| SU00100596 | 81798 |

| VAUXHALL | |
|-----------------|--------------|
| 1334014 | 81605 |
| 1334025 | 81549 |
| 1334041 | 81550 |
| 1334050 | 81550 |
| 1334053 | 81550 |
| 1334065 | 81549 |
| 1334069 | 81847 |
| 1334073 | 81836 |
| 1334077 | 81817 |
| 1334078 | 81818 |
| 1334098 | 81549 |
| 1334101 | 81597 |
| 1334117 | 81747 |
| 1334118 | 81747 |
| 1334119 | 81550 |
| 1334135 | 81751 |
| 1334137 | 81550 |
| 1334143 | 81836 |
| 4408028 | 81814 |
| 4431125 | 82069 |

| | |
|------------|------------------------|
| OES | MAGNETI MARELLI |
|------------|------------------------|

| VAUXHALL | |
|-----------------|--------------|
| 6334019 | 81836 |
| 6334039 | 81818 |
| 6334043 | 84057 |
| 6334048 | 81836 |
| 9109595 | 81855 |
| 9112098 | 81574 |
| 9161593 | 81834 |
| 9161594 | 81835 |
| 9192370 | 81550 |
| 9192793 | 81549 |
| 9192797 | 82005 |
| 9194747 | 81812 |
| 9199592 | 81817 |
| 9199595 | 81818 |
| 9201182 | 81846 |
| 9201450 | 81855 |
| 12585226 | 81812 |
| 12591894 | 81812 |
| 24405895 | 82083 |
| 24439798 | 81812 |
| 24461382 | 81812 |
| 24469102 | 82011 |
| 90076952 | 81543 |
| 90091035 | 81544 |
| 90144227 | 81549 |
| 90183273 | 81543 |
| 90220568 | 81606 |
| 90234200 | 81681 |
| 90272361 | 81606 |
| 90273923 | 81681 |
| 90284813 | 81605 |
| 90284913 | 81605 |
| 90295078 | 81605 |
| 90325660 | 81549 |
| 90325661 | 81681 |
| 90349239 | 81549 |
| 90349241 | 81543 |
| 90409912 | 81544 |
| 90443549 | 81550 |
| 90444079 | 82005 |
| 90444123 | 81551 |
| 90444311 | 81550 |
| 90444649 | 81846 |
| 90512535 | 81597 |
| 90540478 | 81747 |

| OES | MAGNETI MARELLI |
|-----------------|-----------------|
| VAUXHALL | |
| 90541671 | 81597 |
| 90542606 | 81749 |
| 90543277 | 81846 |
| 90543935 | 81751 |
| 91151669 | 81362 |
| 91159773 | 81814 |
| 93161595 | 82069 |
| 93170401 | 81812 |
| 93170697 | 81846 |
| 93172718 | 81812 |
| 93177340 | 81862 |
| 93178602 | 81812 |
| 93182041 | 81847 |
| 93182042 | 81818 |
| 93182043 | 81747 |
| 93195466 | 81862 |
| 94124093 | 81684 |
| 94341998 | 81687 |
| 94386207 | 81685 |
| 96351969 | 81549 |
| 96440224 | 84014 |
| 97101319 | 81685 |
| 97101320 | 81687 |
| 97110386 | 81685 |
| 97110387 | 81687 |
| 97114682 | 81746 |
| 97114683 | 81748 |
| 97135548 | 81750 |
| 97220278 | 81847 |
| 97251178 | 81836 |
| 97287175 | 81836 |
| 7701479043 | 81814 |
| R1160012 | 81549 |
| R1160018 | 81606 |
| R1160024 | 81605 |
| R1160025 | 81685 |
| R1160028 | 81687 |
| R1160030 | 82005 |
| R1160031 | 81551 |
| R1160032 | 81550 |
| R1160036 | 81746 |
| R1160037 | 81685 |
| R1160038 | 81748 |
| R1160039 | 81750 |
| R1160043 | 81846 |

| OES | MAGNETI MARELLI |
|-------------------|-----------------|
| VAUXHALL | |
| R1160044 | 81362 |
| VOLKSWAGEN | |
| 021121004 | 81773 |
| 022121011 | 81866 |
| 023121004 | 81772 |
| 026121005 | 81522 |
| 026121005 | 82080 |
| 026121005 | 82080 |
| 026121010 | 82080 |
| 026121010 | 82080 |
| 028121004 | 81528 |
| 031121004 | 81525 |
| 036121005 | 81776 |
| 037121010 | 82080 |
| 037121010 | 82080 |
| 038121011 | 81706 |
| 045121011 | 81791 |
| 050121010 | 81529 |
| 052121004 | 81520 |
| 052121005 | 81520 |
| 052121019 | 81520 |
| 055121010 | 82001 |
| 056121005 | 81521 |
| 056121011 | 82001 |
| 068121005 | 81521 |
| 068121010 | 82001 |
| 069121004 | 81593 |
| 071121005 | 81856 |
| 073121004 | 81833 |
| 073121005 | 81833 |
| 074121004 | 81701 |
| 078121006 | 81842 |
| 00A121010 | 81774 |
| 0131121005A | 81525 |
| 021121004A | 81773 |
| 021121004V | 81773 |
| 021121004X | 81773 |
| 022121011A | 81866 |
| 022121011L | 81866 |
| 022121011V | 81866 |
| 022121011X | 81866 |
| 023121004V | 81772 |
| 023121004X | 81772 |
| 025121010C | 81832 |

| OES | MAGNETI MARELLI |
|-------------------|-----------------|
| VOLKSWAGEN | |
| 025121010CV | 81832 |
| 025121010CX | 81832 |
| 026121005A | 81522 |
| 026121005A | 82080 |
| 026121005A | 82080 |
| 026121005C | 81522 |
| 026121005C | 82080 |
| 026121005C | 82080 |
| 026121005E | 81522 |
| 026121005E | 82080 |
| 026121005E | 82080 |
| 026121005F | 81526 |
| 026121005G | 81522 |
| 026121005G | 82080 |
| 026121005G | 82080 |
| 026121005H | 81522 |
| 026121005H | 82080 |
| 026121005H | 82080 |
| 026121005K | 81526 |
| 026121010A | 82001 |
| 026121010AV | 82001 |
| 026121010C | 82080 |
| 026121010C | 82080 |
| 026121010CV | 82080 |
| 026121010CV | 82080 |
| 026121010CX | 82080 |
| 026121010CX | 82080 |
| 026121010D | 82001 |
| 026121010DV | 82001 |
| 026121010DX | 82001 |
| 026121010E | 82080 |
| 026121010E | 82080 |
| 026121010F | 82080 |
| 026121010F | 82080 |
| 026121010FV | 82080 |
| 026121010FV | 82080 |
| 026121010FX | 82080 |
| 026121010FX | 82080 |
| 026121010V | 82080 |
| 026121010V | 82080 |
| 026121010X | 82080 |
| 026121010X | 82080 |
| 028121004V | 81528 |
| 028121004X | 81528 |
| 030121004A | 81524 |

OES

| VOLKSWAGEN | |
|-------------------|--------------|
| 030121004B | 81524 |
| 030121005D | 81527 |
| 030121005H | 81524 |
| 030121005L | 81524 |
| 030121005LV | 81524 |
| 030121005LX | 81524 |
| 030121005N | 81527 |
| 030121005NV | 81527 |
| 030121005NX | 81527 |
| 030121005S | 81775 |
| 030121008A | 81775 |
| 030121008AV | 81775 |
| 030121008AX | 81775 |
| 030121008C | 81775 |
| 030121008J | 81527 |
| 030121008K | 81527 |
| 030121008M | 81527 |
| 030121008R | 81527 |
| 031121004A | 81525 |
| 031121004AV | 81525 |
| 031121004AX | 81525 |
| 031121004V | 81525 |
| 031121004X | 81525 |
| 031121005A | 81525 |
| 031121005C | 81525 |
| 031121005CV | 81525 |
| 031121005CX | 81525 |
| 036121005B | 81777 |
| 036121005D | 81776 |
| 036121005DX | 81776 |
| 036121005E | 81777 |
| 036121005EV | 81777 |
| 036121005EX | 81777 |
| 036121005F | 81840 |
| 036121005G | 81840 |
| 036121005GX | 81840 |
| 036121005M | 81776 |
| 036121005P | 81840 |
| 036121005Q | 81777 |
| 036121005QX | 81777 |
| 036121005R | 81777 |
| 036121005S | 81777 |
| 036121005SV | 81777 |
| 036121005SX | 81777 |
| 036121008G | 81840 |

OES

| VOLKSWAGEN | |
|-------------------|--------------|
| 036121008GX | 81840 |
| 036121008K | 81777 |
| 036121008L | 81777 |
| 036121008M | 81777 |
| 036121008MX | 81777 |
| 037121005B | 81522 |
| 037121005C | 81522 |
| 037121010A | 82080 |
| 037121010A | 82080 |
| 037121010AV | 82080 |
| 037121010AV | 82080 |
| 037121010AX | 82080 |
| 037121010AX | 82080 |
| 037121010B | 82080 |
| 037121010BX | 82080 |
| 037121010BX | 82080 |
| 037121010C | 82080 |
| 037121010C | 82080 |
| 037121010CX | 82080 |
| 038121011A | 81706 |
| 038121011AV | 81706 |
| 038121011AX | 81706 |
| 038121011C | 81816 |
| 038121011CX | 81816 |
| 038121011D | 81816 |
| 038121011DX | 81816 |
| 038121011G | 84011 |
| 038121011GX | 84011 |
| 038121011H | 84011 |
| 038121011HX | 84011 |
| 038121011J | 84011 |
| 038121011JX | 84011 |
| 038121011K | 84011 |
| 038121011KX | 84011 |
| 03C121005B | 81865 |
| 03C121005C | 81865 |
| 03C121005D | 81865 |
| 03C121005DX | 81865 |
| 03C121005K | 81865 |
| 03C121005L | 81865 |
| 03C121005N | 82097 |
| 03C121005NX | 82097 |
| 03C121005R | 82097 |
| 03C121005RX | 82097 |
| 03C121005S | 81865 |

OES

| VOLKSWAGEN | |
|-------------------|--------------|
| 03C121008B | 82097 |
| 03C121008BX | 82097 |
| 03C121008C | 81865 |
| 03C121008CX | 81865 |
| 03C121008E | 82097 |
| 03C121008EX | 82097 |
| 03C121008F | 81865 |
| 03C121008FX | 81865 |
| 03C121008J | 81865 |
| 03C121008JX | 81865 |
| 03D121005 | 81867 |
| 03D121005X | 81867 |
| 03D121013B | 81867 |
| 03F121004A | 84045 |
| 03F121004B | 84045 |
| 03F121004D | 84045 |
| 03F121005 | 84045 |
| 03G121011 | 84011 |
| 03G121011X | 84011 |
| 03L121011 | 84001 |
| 03L121011B | 81816 |
| 03L121011BX | 81816 |
| 03L121011G | 84011 |
| 03L121011GX | 84011 |
| 03L121011H | 84001 |
| 03L121011J | 84001 |
| 03L121011P | 84001 |
| 045121011B | 81791 |
| 045121011C | 84052 |
| 045121011F | 84010 |
| 045121011FX | 84010 |
| 045121011G | 82013 |
| 045121011H | 84010 |
| 045121011HX | 84010 |
| 045121011J | 82013 |
| 046121004D | 81701 |
| 046121004DV | 81701 |
| 046121004DX | 81701 |
| 047121013J | 81807 |
| 04C121600K | 84062 |
| 04E121600AD | 84062 |
| 04E121600AG | 84062 |
| 04E121600AL | 84062 |
| 04E121600AQ | 84062 |
| 04E121600AR | 84062 |

| OES | MAGNETI MARELLI |
|-------------------|-----------------|
| VOLKSWAGEN | |
| 04E121600D | 84062 |
| 04E121600H | 84062 |
| 04E121600P | 84062 |
| 050121010A | 81529 |
| 050121010AV | 81529 |
| 050121010AX | 81529 |
| 050121010C | 81529 |
| 050121010V | 81529 |
| 050121010X | 81529 |
| 052121004AV | 81520 |
| 052121004AX | 81520 |
| 052121004V | 81520 |
| 052121004X | 81520 |
| 052121005A | 81520 |
| 052121005AX | 81520 |
| 055121010X | 82001 |
| 056121005A | 81521 |
| 056121013A | 82001 |
| 059121004B | 81705 |
| 059121004C | 81705 |
| 059121004CX | 81705 |
| 059121004D | 81705 |
| 059121004E | 81705 |
| 059121004EV | 81705 |
| 059121004EX | 81705 |
| 059121005T | 84021 |
| 059121005TX | 84021 |
| 059121008A | 84021 |
| 059121008J | 84021 |
| 059121008JX | 84021 |
| 066121011C | 81856 |
| 066121011CX | 81856 |
| 066121011D | 81856 |
| 068121005A | 81522 |
| 068121005A | 82080 |
| 068121005A | 82080 |
| 068121005B | 81521 |
| 068121005C | 81521 |
| 068121010A | 82080 |
| 068121010A | 82080 |
| 068121010AX | 82080 |
| 068121010AX | 82080 |
| 069121004V | 81593 |
| 069121004X | 81593 |
| 069121005D | 81593 |

| OES | MAGNETI MARELLI |
|-------------------|-----------------|
| VOLKSWAGEN | |
| 06A121011C | 81703 |
| 06A121011E | 81703 |
| 06A121011EV | 81703 |
| 06A121011EX | 81703 |
| 06A121011F | 81703 |
| 06A121011G | 81703 |
| 06A121011H | 81703 |
| 06A121011HV | 81703 |
| 06A121011HX | 81703 |
| 06A121011L | 81703 |
| 06A121011LV | 81703 |
| 06A121011LX | 81703 |
| 06A121011T | 81703 |
| 06A121011TX | 81703 |
| 06A121012 | 81703 |
| 06A121012G | 81703 |
| 06A121012GX | 81703 |
| 06A121012X | 81703 |
| 06B121011 | 81702 |
| 06B121011A | 81702 |
| 06B121011B | 81702 |
| 06B121011BV | 81702 |
| 06B121011BX | 81702 |
| 06B121011C | 81702 |
| 06B121011CV | 81702 |
| 06B121011CX | 81702 |
| 06B121011E | 81702 |
| 06B121011EV | 81702 |
| 06B121011EX | 81702 |
| 06B121011H | 81702 |
| 06B121011L | 81702 |
| 06B121011LX | 81702 |
| 06B121011M | 81702 |
| 06B121011N | 81702 |
| 06B121011NX | 81702 |
| 06B121011Q | 81702 |
| 06C121004C | 81819 |
| 06C121004G | 81819 |
| 06C121004H | 81819 |
| 06C121004HX | 81819 |
| 06E121008N | 82015 |
| 06E121018A | 82015 |
| 06F121011 | 82025 |
| 06F121011X | 82025 |
| 06H121026AB | 84016 |

| OES | MAGNETI MARELLI |
|-------------------|-----------------|
| VOLKSWAGEN | |
| 06H121026AF | 84016 |
| 06H121026AG | 84016 |
| 06H121026B | 84016 |
| 06H121026B | 84016 |
| 06H121026BA | 84016 |
| 06H121026BE | 84016 |
| 06H121026BF | 84016 |
| 06H121026CC | 84016 |
| 06H121026CP | 84016 |
| 06H121026DD | 84016 |
| 06H121026N | 84016 |
| 06J121026A | 84016 |
| 06J121026AG | 84016 |
| 06J121026F | 84016 |
| 06J121026G | 84016 |
| 06K121011 | 84037 |
| 06L121005A | 84037 |
| 06L121012 | 84037 |
| 06L121012A | 84037 |
| 070121011A | 82033 |
| 070121011C | 82033 |
| 070121011D | 82033 |
| 070121011DX | 82033 |
| 073121004V | 81833 |
| 073121004X | 81833 |
| 074121004A | 81701 |
| 074121004AV | 81701 |
| 074121004AX | 81701 |
| 074121004BX | 81701 |
| 074121004N | 81701 |
| 074121004NX | 81701 |
| 074121004V | 81701 |
| 074121004X | 81701 |
| 074121005MV | 81701 |
| 074121005N | 81701 |
| 077121004M | 82081 |
| 077121004MX | 82081 |
| 077121004N | 82081 |
| 077121004PX | 82081 |
| 078121004H | 81842 |
| 078121004HX | 81842 |
| 078121004J | 81842 |
| 078121004JV | 81842 |
| 078121004JX | 81842 |
| 078121004L | 81842 |

OES

VOLKSWAGEN

| | |
|-------------|--------------|
| 078121004Q | 81842 |
| 078121004QX | 81842 |
| 078121004R | 81842 |
| 078121006A | 81842 |
| 078121006X | 81842 |

VOLVO

| | |
|--------|--------------|
| 270559 | 81594 |
| 270681 | 81592 |
| 271275 | 81594 |
| 271647 | 82056 |
| 271647 | 82056 |
| 271830 | 81594 |
| 271855 | 82056 |
| 271855 | 82056 |
| 271975 | 81594 |
| 271984 | 81857 |
| 271985 | 82056 |
| 271986 | 82056 |
| 271986 | 82056 |
| 272334 | 81779 |
| 272457 | 82056 |
| 272457 | 82056 |
| 272474 | 82056 |
| 272474 | 82056 |
| 272476 | 82056 |
| 272476 | 82056 |
| 272481 | 82056 |
| 272481 | 82056 |

OES

VOLVO

| | |
|----------|--------------|
| 272482 | 81857 |
| 274155 | 81701 |
| 274216 | 81864 |
| 275619 | 81592 |
| 463425 | 81592 |
| 1326342 | 81594 |
| 2716132 | 81593 |
| 2716470 | 82056 |
| 2716470 | 82056 |
| 2717684 | 81701 |
| 2719585 | 82056 |
| 2719847 | 81857 |
| 2719854 | 82056 |
| 2719854 | 82056 |
| 2719862 | 82056 |
| 2719862 | 82056 |
| 3242084 | 81574 |
| 3344831 | 81574 |
| 3345626 | 81574 |
| 8653806 | 81800 |
| 8694628 | 81857 |
| 8694630 | 81864 |
| 8694759 | 81804 |
| 12571857 | 81593 |
| 30620725 | 81814 |
| 30650751 | 82056 |
| 30650751 | 82056 |
| 30650979 | 81864 |
| 30684432 | 82056 |

OES

VOLVO

| | |
|----------|--------------|
| 30684432 | 82056 |
| 30711527 | 81869 |
| 30711622 | 81598 |
| 30725831 | 81800 |
| 30731312 | 81804 |
| 30735758 | 81598 |
| 30751022 | 81864 |
| 30751700 | 82056 |
| 30751700 | 82056 |
| 30751971 | 81869 |
| 30757405 | 81804 |
| 30777590 | 81804 |
| 30788221 | 81800 |
| 30855991 | 81574 |
| 31219176 | 82027 |
| 31293177 | 81864 |
| 31293668 | 81864 |
| 31319266 | 81804 |
| 31330943 | 82027 |
| 31368353 | 82027 |
| 32877516 | 81574 |
| 33430935 | 81574 |
| 33442518 | 81574 |
| 33448275 | 81574 |

YUGO

| | |
|---------|--------------|
| 4384128 | 81481 |
| 7580756 | 81481 |

IAM cross reference guide

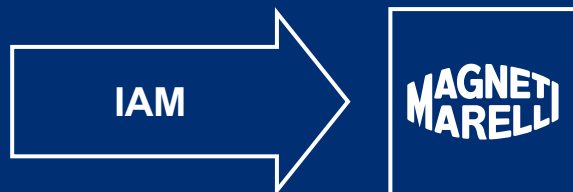

IAM

IAM

IAM

AIRTEX

| | |
|------|--------|
| 1094 | 81415 |
| 1111 | 81531 |
| 1125 | 81999 |
| 1133 | 81811 |
| 1134 | 81576 |
| 1135 | 81554 |
| 1138 | 81520 |
| 1139 | 81521 |
| 1140 | 81522 |
| 1145 | 81618 |
| 1162 | 81544 |
| 1163 | 81543 |
| 1164 | 81549 |
| 1167 | 81606 |
| 1180 | 81592 |
| 1189 | 11706T |
| 1190 | 81593 |
| 1193 | 81822 |
| 1195 | 81574 |
| 1196 | 81498 |
| 1197 | 81536 |
| 1198 | 81436 |
| 1208 | 81552 |
| 1209 | 81671 |
| 1212 | 81797 |
| 1212 | 81556 |
| 1217 | 81434 |
| 1218 | 81586 |
| 1219 | 81584 |
| 1222 | 81443 |
| 1225 | 81460 |
| 1227 | 81532 |
| 1228 | 81602 |
| 1229 | 81538 |
| 1236 | 81506 |
| 1241 | 81664 |
| 1242 | 81828 |
| 1243 | 81608 |
| 1247 | 81594 |
| 1288 | 81481 |
| 1294 | 81605 |
| 1296 | 81616 |
| 1303 | 81683 |
| 1307 | 81587 |
| 1308 | 81617 |

AIRTEX

| | |
|------|-------|
| 1310 | 81672 |
| 1312 | 81458 |
| 1321 | 81477 |
| 1327 | 81314 |
| 1338 | 81525 |
| 1348 | 82080 |
| 1348 | 82080 |
| 1349 | 82001 |
| 1359 | 82023 |
| 1359 | 81512 |
| 1364 | 81650 |
| 1366 | 81661 |
| 1368 | 81613 |
| 1369 | 81590 |
| 1370 | 81589 |
| 1371 | 81588 |
| 1377 | 81450 |
| 1382 | 81611 |
| 1383 | 81490 |
| 1385 | 81619 |
| 1386 | 81508 |
| 1388 | 81684 |
| 1391 | 81685 |
| 1391 | 81687 |
| 1394 | 81507 |
| 1395 | 81302 |
| 1397 | 81524 |
| 1398 | 81614 |
| 1399 | 81615 |
| 1400 | 81654 |
| 1404 | 81653 |
| 1406 | 81509 |
| 1412 | 81322 |
| 1415 | 81656 |
| 1417 | 81597 |
| 1419 | 81513 |
| 1420 | 81353 |
| 1421 | 81367 |
| 1423 | 81300 |
| 1424 | 81324 |
| 1426 | 81315 |
| 1427 | 81325 |
| 1428 | 81339 |
| 1429 | 81365 |
| 1429 | 81304 |

AIRTEX

| | |
|------|-------|
| 1430 | 81476 |
| 1431 | 81333 |
| 1432 | 81303 |
| 1435 | 81657 |
| 1437 | 81334 |
| 1438 | 81332 |
| 1442 | 81722 |
| 1443 | 81499 |
| 1444 | 81723 |
| 1446 | 82005 |
| 1447 | 81550 |
| 1448 | 81551 |
| 1449 | 81666 |
| 1450 | 81854 |
| 1451 | 81756 |
| 1452 | 81759 |
| 1453 | 81757 |
| 1454 | 81758 |
| 1455 | 81667 |
| 1456 | 81853 |
| 1457 | 81596 |
| 1457 | 81854 |
| 1458 | 81855 |
| 1459 | 81843 |
| 1460 | 81707 |
| 1465 | 82056 |
| 1465 | 82056 |
| 1480 | 81833 |
| 1510 | 81772 |
| 1512 | 81715 |
| 1513 | 81714 |
| 1515 | 81742 |
| 1523 | 81801 |
| 1525 | 81755 |
| 1527 | 81660 |
| 1530 | 81527 |
| 1533 | 81316 |
| 1537 | 81743 |
| 1541 | 81329 |
| 1543 | 81842 |
| 1544 | 81341 |
| 1545 | 81331 |
| 1550 | 81746 |
| 1552 | 81750 |
| 1555 | 81366 |

| IAM | MAGNETI MARELLI |
|---------------|-----------------|
| AIRTEX | |
| 1556 | 81341 |
| 1556 | 81364 |
| 1557 | 81343 |
| 1558 | 81348 |
| 1559 | 81764 |
| 1562 | 81651 |
| 1563 | 81711 |
| 1564 | 81710 |
| 1567 | 82053 |
| 1568 | 81722 |
| 1572 | 81463 |
| 1572 | 81347 |
| 1572 | 81363 |
| 1573 | 81464 |
| 1573 | 81326 |
| 1574 | 81309 |
| 1575 | 81456 |
| 1576 | 81342 |
| 1577 | 81578 |
| 1578 | 81579 |
| 1579 | 81642 |
| 1580 | 81713 |
| 1581 | 81777 |
| 1582 | 81775 |
| 1583 | 81776 |
| 1584 | 81760 |
| 1585 | 81762 |
| 1586 | 81716 |
| 1587 | 81752 |
| 1588 | 81702 |
| 1588 | 81703 |
| 1589 | 81320 |
| 1591 | 81318 |
| 1592 | 81856 |
| 1593 | 81319 |
| 1594 | 81362 |
| 1595 | 81352 |
| 1595 | 81330 |
| 1596 | 81705 |
| 1597 | 81774 |
| 1598 | 82087 |
| 1599 | 81526 |
| 1600 | 81753 |
| 1601 | 81712 |
| 1602 | 81340 |

| IAM | MAGNETI MARELLI |
|---------------|-----------------|
| AIRTEX | |
| 1602 | 81351 |
| 1603 | 81369 |
| 1606 | 81749 |
| 1608 | 81529 |
| 1609 | 81522 |
| 1610 | 82080 |
| 1610 | 82080 |
| 1611 | 81469 |
| 1616 | 81370 |
| 1618 | 81573 |
| 1619 | 81802 |
| 1622 | 81844 |
| 1625 | 81839 |
| 1626 | 81368 |
| 1627 | 81346 |
| 1628 | 81301 |
| 1630 | 81793 |
| 1631 | 81781 |
| 1632 | 81780 |
| 1633 | 81782 |
| 1634 | 81726 |
| 1635 | 81728 |
| 1636 | 81729 |
| 1637 | 81767 |
| 1638 | 81768 |
| 1640 | 81761 |
| 1641 | 84039 |
| 1641 | 81806 |
| 1642 | 81751 |
| 1643 | 81747 |
| 1645 | 81795 |
| 1646 | 81783 |
| 1647 | 82084 |
| 1648 | 82088 |
| 1649 | 81794 |
| 1651 | 81362 |
| 1659 | 81804 |
| 1685 | 82048 |
| 1688 | 82034 |
| 1733 | 82021 |
| 1746 | 84007 |
| 1894 | 84015 |
| 2300 | 81491 |
| 4084 | 81655 |
| 4085 | 82004 |

| IAM | MAGNETI MARELLI |
|---------------|-----------------|
| AIRTEX | |
| 4104 | 81598 |
| 4115 | 81803 |
| 5029 | 81789 |
| 5048 | 81790 |
| 5058 | 81858 |
| 5079 | 81846 |
| 7115 | 81784 |
| 7135 | 81731 |
| 7150 | 81733 |
| 9099 | 81770 |
| 9150 | 81832 |
| 9209 | 81613 |
| 9209 | 81708 |
| 9212 | 81786 |
| 9213 | 81736 |
| 9214 | 81744 |
| 9251 | 81709 |
| 9262 | 81773 |
| 9272 | 81769 |
| 9274 | 81701 |
| 9279 | 81700 |
| 9312 | 81724 |
| 9314 | 81725 |
| 9335 | 81528 |
| 9367 | 81771 |
| 9374 | 82050 |
| 9377 | 81703 |
| 9378 | 81816 |
| 9378 | 84011 |
| 9378 | 81706 |
| 9419 | 82039 |
| 11271 | 81572 |
| 11301 | 81334 |
| 1088M | 81560 |
| 1091A | 81419 |
| 1124D1 | 81497 |
| 1164C | 81681 |
| AW9271 | 81815 |
| PA9306 | 82051 |
| PA993 | 82069 |

IAM

IAM

IAM

AISIN

| | |
|----------|-------|
| WE-SM01A | 82049 |
| WN-076 | 82053 |
| WPH-043 | 82045 |
| WPH-044 | 82039 |
| WPK001 | 82038 |
| WPM-002 | 81787 |
| WPM-045 | 81731 |
| WPN-008 | 82054 |
| WPT-057 | 82051 |
| WPT-118 | 82044 |
| WPT-140 | 84030 |
| WPT-164 | 84031 |
| WPT-170 | 84028 |
| WPT-180 | 84029 |
| WPT-181 | 84032 |
| WPT-910A | 82048 |
| WPT-912 | 82063 |
| WPT-912 | 82063 |
| WPY-006 | 82021 |
| WPY-020 | 82020 |
| WPY-021 | 81785 |
| WPY-033 | 84015 |
| WT902 | 82048 |

ASHIKA

| | |
|-----------|-------|
| 35-02-203 | 82051 |
| 35-02-274 | 84030 |
| 35-02-275 | 84031 |
| 35-02-276 | 82048 |
| 35-02-283 | 82044 |
| 35-04-436 | 82039 |
| 35-04-439 | 82045 |
| 35-0H-H03 | 84018 |
| 35-0H-H12 | 84059 |
| 35-0K-K16 | 84058 |
| 35-K0-002 | 82038 |

BUGATTI

| | |
|---------|-------|
| PA0010 | 81415 |
| PA0011S | 81481 |
| PA0018 | 81434 |
| PA0026 | 81822 |
| PA0030 | 81492 |
| PA0035 | 81443 |
| PA0039 | 81491 |

BUGATTI

| | |
|---------|--------|
| PA0040 | 81999 |
| PA0042 | 81619 |
| PA0055 | 81552 |
| PA0056 | 81671 |
| PA0057 | 81572 |
| PA0071 | 81554 |
| PA0091 | 81543 |
| PA0092 | 81544 |
| PA0099 | 81549 |
| PA0105 | 81560 |
| PA0142 | 81504 |
| PA0145 | 81507 |
| PA0146 | 81506 |
| PA0186 | 81828 |
| PA0188 | 81576 |
| PA0189 | 81573 |
| PA0190 | 81664 |
| PA0195 | 81608 |
| PA0207 | 81618 |
| PA0209 | 81584 |
| PA0211 | 81586 |
| PA0212 | 81616 |
| PA0213 | 81617 |
| PA0214 | 81587 |
| PA0226 | 81532 |
| PA0231 | 81531 |
| PA0239 | 81536 |
| PA0240 | 81602 |
| PA0243 | 81538 |
| PA0246 | 81650 |
| PA0247 | 81651 |
| PA0252T | 81419 |
| PA0273 | 11701T |
| PA0274 | 11707 |
| PA0280 | 81460 |
| PA0285 | 81594 |
| PA0290 | 81592 |
| PA0308 | 81611 |
| PA0313 | 81520 |
| PA0317 | 81593 |
| PA0319 | 81522 |
| PA0319C | 82080 |
| PA0320 | 81521 |
| PA0320C | 82001 |
| PA0323 | 81832 |

BUGATTI

| | |
|---------|-------|
| PA0325 | 81683 |
| PA0327 | 81833 |
| PA0363 | 81498 |
| PA0506 | 81450 |
| PA0507 | 81456 |
| PA0508 | 81458 |
| PA0509 | 81469 |
| PA0513 | 81476 |
| PA0513S | 81314 |
| PA0515 | 81463 |
| PA0516 | 81464 |
| PA0516S | 81326 |
| PA0517 | 81309 |
| PA0519 | 81477 |
| PA0527 | 81436 |
| PA10001 | 81815 |
| PA10002 | 81816 |
| PA10005 | 81819 |
| PA10006 | 81814 |
| PA10007 | 81834 |
| PA10008 | 81835 |
| PA10010 | 81820 |
| PA10011 | 81810 |
| PA10012 | 81797 |
| PA10013 | 81798 |
| PA10014 | 81836 |
| PA10015 | 82010 |
| PA10016 | 82040 |
| PA10017 | 81872 |
| PA10018 | 84004 |
| PA10019 | 81817 |
| PA10020 | 81818 |
| PA10021 | 82081 |
| PA10023 | 82082 |
| PA10025 | 81861 |
| PA10026 | 84012 |
| PA10028 | 82029 |
| PA10029 | 81821 |
| PA10030 | 82011 |
| PA10031 | 81862 |
| PA10033 | 82083 |
| PA10034 | 81837 |
| PA10035 | 81838 |
| PA10036 | 81839 |
| PA10037 | 82084 |



| BUGATTI | |
|----------------|-------|
| PA10039 | 82056 |
| PA10040 | 81864 |
| PA10042 | 81840 |
| PA10043 | 81865 |
| PA10044 | 81866 |
| PA10045 | 81867 |
| PA10047 | 82055 |
| PA10048 | 82012 |
| PA10049 | 82013 |
| PA10051 | 81868 |
| PA10052 | 81869 |
| PA10053 | 82023 |
| PA10055 | 82028 |
| PA10056 | 84061 |
| PA10057 | 82014 |
| PA10058 | 82026 |
| PA10060 | 82015 |
| PA10061 | 82046 |
| PA10063 | 82016 |
| PA10064 | 82017 |
| PA10065 | 82025 |
| PA10066 | 82085 |
| PA10073 | 82018 |
| PA10074 | 82047 |
| PA10075 | 82090 |
| PA10076 | 82022 |
| PA10077 | 82024 |
| PA10078 | 82030 |
| PA10079 | 82091 |
| PA10080 | 82041 |
| PA10081 | 82038 |
| PA10082 | 82033 |
| PA10085 | 84013 |
| PA10086 | 82034 |
| PA10087 | 82063 |
| PA10088 | 82032 |
| PA10090 | 82052 |
| PA10091 | 82092 |
| PA10092 | 84060 |
| PA10093 | 82093 |
| PA10094 | 82071 |
| PA10095 | 82057 |
| PA10096 | 82048 |
| PA10098 | 82042 |
| PA10099 | 84058 |



| BUGATTI | |
|----------------|-------|
| PA10102 | 82020 |
| PA10103 | 82021 |
| PA10104 | 82049 |
| PA10105 | 84057 |
| PA10106 | 82036 |
| PA10107 | 82027 |
| PA10108 | 82050 |
| PA10109 | 82058 |
| PA10110 | 82059 |
| PA10111 | 82066 |
| PA10114 | 82068 |
| PA10115 | 82053 |
| PA10116 | 82054 |
| PA10117 | 82069 |
| PA10118 | 84014 |
| PA10119 | 84015 |
| PA10121 | 84059 |
| PA10124 | 82051 |
| PA10125 | 82094 |
| PA10126 | 82095 |
| PA10127 | 82044 |
| PA10129 | 82045 |
| PA10131 | 82039 |
| PA10134 | 84000 |
| PA10135 | 82040 |
| PA10138 | 82056 |
| PA10139 | 84016 |
| PA10140 | 84016 |
| PA10141 | 82097 |
| PA10142 | 82067 |
| PA10145 | 82098 |
| PA10146 | 82099 |
| PA10147 | 84017 |
| PA10148 | 84001 |
| PA10151 | 84018 |
| PA10153 | 82070 |
| PA10154 | 82089 |
| PA10156 | 82063 |
| PA10161 | 82080 |
| PA10169 | 84019 |
| PA10170 | 84020 |
| PA10178 | 84021 |
| PA10179 | 84022 |
| PA10180 | 84023 |
| PA10182 | 84024 |



| BUGATTI | |
|----------------|-------|
| PA10183 | 84001 |
| PA10184 | 81872 |
| PA10185 | 84025 |
| PA10187 | 84002 |
| PA10189 | 84026 |
| PA10190 | 84003 |
| PA10191 | 84027 |
| PA10192 | 84004 |
| PA10193 | 84028 |
| PA10195 | 84029 |
| PA10196 | 84030 |
| PA10197 | 84005 |
| PA10202 | 84031 |
| PA10203 | 84032 |
| PA10204 | 84006 |
| PA10205 | 84009 |
| PA10209 | 84007 |
| PA10212 | 84033 |
| PA10213 | 84008 |
| PA10216 | 84034 |
| PA10220 | 84035 |
| PA10223 | 84036 |
| PA10225 | 84037 |
| PA10227 | 84010 |
| PA10228 | 84011 |
| PA10231 | 84062 |
| PA10233 | 84038 |
| PA10234 | 82089 |
| PA10235 | 84039 |
| PA10236 | 84040 |
| PA10239 | 84042 |
| PA10240 | 84065 |
| PA10245 | 84063 |
| PA10247 | 84064 |
| PA10248 | 84043 |
| PA10249 | 84044 |
| PA10253 | 84045 |
| PA10254 | 84046 |
| PA10255 | 84047 |
| PA10256 | 84048 |
| PA10257 | 82095 |
| PA10264 | 84049 |
| PA10265 | 84050 |
| PA10266 | 84051 |
| PA10267 | 84052 |

IAM

IAM

IAM

BUGATTI

| | |
|---------|----------------|
| PA10269 | 84053 |
| PA10271 | 84054 |
| PA1053 | 81512 |
| PA1080 | 81606 |
| PA1081 | 81605 |
| PA1082 | 81681 |
| PA1084 | 81684 |
| PA1171 | 81660 |
| PA1172 | 81661 |
| PA1262 | 19532/E |
| PA5001 | 81302 |
| PA5002 | 11701T |
| PA5003 | 11708T |
| PA5006 | 11706T |
| PA5007 | 81322 |
| PA5009 | 81331 |
| PA5010 | 81348 |
| PA5011 | 81355 |
| PA5013 | 81352 |
| PA5014 | 81362 |
| PA5102 | 81700 |
| PA5107 | 81529 |
| PA5108 | 81528 |
| PA5109 | 81526 |
| PA5110 | 81842 |
| PA5112 | 81702 |
| PA5113 | 81703 |
| PA5114 | 81706 |
| PA5115 | 81705 |
| PA5116 | 81706 |
| PA5117 | 81842 |
| PA5201 | 81613 |
| PA5202 | 81614 |
| PA5203 | 81615 |
| PA5204 | 81707 |
| PA5205 | 81708 |
| PA5206 | 81709 |
| PA5207 | 81843 |
| PA5401 | 81588 |
| PA5402 | 81589 |
| PA5403 | 81590 |
| PA5404 | 81597 |
| PA5413 | 81796 |
| PA5414 | 81793 |
| PA5418 | 81795 |

BUGATTI

| | |
|--------|--------------|
| PA5419 | 81794 |
| PA5501 | 81642 |
| PA5502 | 81672 |
| PA5504 | 81556 |
| PA5505 | 81710 |
| PA5506 | 81711 |
| PA5507 | 81844 |
| PA5508 | 81712 |
| PA5509 | 81713 |
| PA5510 | 81799 |
| PA5702 | 81714 |
| PA5704 | 81715 |
| PA5903 | 81488 |
| PA5904 | 81489 |
| PA5907 | 81315 |
| PA5908 | 81300 |
| PA5909 | 81324 |
| PA5911 | 81325 |
| PA5912 | 81339 |
| PA5913 | 81303 |
| PA5914 | 81365 |
| PA5915 | 81304 |
| PA5916 | 81333 |
| PA5919 | 81334 |
| PA5920 | 81332 |
| PA5922 | 81316 |
| PA5923 | 81340 |
| PA5924 | 81341 |
| PA5925 | 81364 |
| PA5926 | 81329 |
| PA5927 | 81330 |
| PA5928 | 81342 |
| PA5929 | 81372 |
| PA5930 | 81347 |
| PA5931 | 81363 |
| PA5932 | 81346 |
| PA5933 | 81368 |
| PA5934 | 81369 |
| PA5935 | 81351 |
| PA5936 | 81301 |
| PA5937 | 81343 |
| PA5938 | 81366 |
| PA5939 | 81320 |
| PA5940 | 81318 |
| PA5941 | 81319 |

BUGATTI

| | |
|--------|--------------|
| PA5942 | 81370 |
| PA5943 | 81369 |
| PA5944 | 81344 |
| PA5945 | 81801 |
| PA5946 | 82086 |
| PA6001 | 81653 |
| PA6002 | 81654 |
| PA6003 | 81559 |
| PA6004 | 81655 |
| PA6005 | 81656 |
| PA6006 | 81657 |
| PA6009 | 82004 |
| PA6010 | 81598 |
| PA6011 | 81716 |
| PA6012 | 81802 |
| PA6013 | 81803 |
| PA6014 | 81845 |
| PA6015 | 81804 |
| PA6016 | 81805 |
| PA6401 | 81717 |
| PA6501 | 81490 |
| PA6804 | 81508 |
| PA6805 | 81509 |
| PA6808 | 81499 |
| PA6811 | 81722 |
| PA6814 | 81723 |
| PA6816 | 81724 |
| PA6818 | 81725 |
| PA6819 | 81726 |
| PA6820 | 82087 |
| PA6821 | 81728 |
| PA6822 | 81729 |
| PA6823 | 81730 |
| PA6824 | 82088 |
| PA6905 | 81731 |
| PA6908 | 81733 |
| PA7103 | 81736 |
| PA7109 | 81742 |
| PA7110 | 81743 |
| PA7111 | 81744 |
| PA7112 | 81745 |
| PA7201 | 81685 |
| PA7202 | 81550 |
| PA7203 | 81551 |
| PA7204 | 82005 |

| IAM | MAGNETI MARELLI |
|----------------|-----------------|
| BUGATTI | |
| PA7205 | 81687 |
| PA7207 | 81746 |
| PA7208 | 81747 |
| PA7209 | 81846 |
| PA7210 | 81748 |
| PA7211 | 81749 |
| PA7212 | 81750 |
| PA7213 | 81751 |
| PA7214 | 81847 |
| PA7217 | 81812 |
| PA7402 | 81367 |
| PA7404 | 81513 |
| PA7405 | 81353 |
| PA7406 | 81752 |
| PA7407 | 81753 |
| PA7409 | 81800 |
| PA7410 | 81813 |
| PA7701 | 81574 |
| PA7702 | 81754 |
| PA7703 | 81666 |
| PA7704 | 81667 |
| PA7705 | 81755 |
| PA7707 | 81851 |
| PA7708 | 81596 |
| PA7709 | 81756 |
| PA7710 | 81757 |
| PA7711 | 81758 |
| PA7712 | 81759 |
| PA7713 | 81760 |
| PA7714 | 81579 |
| PA7715 | 81578 |
| PA7716 | 81761 |
| PA7717 | 81762 |
| PA7718 | 81806 |
| PA7719 | 81852 |
| PA7721 | 81811 |
| PA7722 | 81853 |
| PA7723 | 81854 |
| PA7724 | 81855 |
| PA7802 | 81764 |
| PA7902 | 81497 |
| PA8501 | 81766 |
| PA8502 | 81767 |
| PA8503 | 81768 |
| PA8504 | 81769 |

| IAM | MAGNETI MARELLI |
|----------------|-----------------|
| BUGATTI | |
| PA8505 | 81770 |
| PA8506 | 81771 |
| PA8507 | 81808 |
| PA8508 | 81809 |
| PA8701 | 81772 |
| PA8702 | 81524 |
| PA8703 | 81525 |
| PA8704 | 81527 |
| PA8705 | 81773 |
| PA8706 | 81774 |
| PA8707 | 81775 |
| PA8708 | 81856 |
| PA8709 | 81776 |
| PA8710 | 81777 |
| PA8711 | 81807 |
| PA8712 | 81791 |
| PA8713 | 81701 |
| PA8802 | 81857 |
| PA8803 | 82056 |
| PA8804 | 81779 |
| PA9101 | 81780 |
| PA9102 | 81781 |
| PA9103 | 81782 |
| PA9104 | 81783 |
| PA9201 | 81784 |
| PA9202 | 81785 |
| PA9203 | 81786 |
| PA9204 | 81787 |
| PA9301 | 81789 |
| PA9302 | 81790 |
| PA9303 | 81858 |

| DELPHI | |
|---------------|-------|
| WP1103 | 81552 |
| WP1106 | 81671 |
| WP1906 | 82053 |
| WP2462 | 82051 |
| WP2477 | 82048 |
| WP2529 | 82057 |

| DOLZ | |
|-------------|--------|
| A130 | 81302 |
| A133 | 11706T |
| A145 | 11701T |
| A145 | 11701T |

| IAM | MAGNETI MARELLI |
|-------------|-----------------|
| DOLZ | |
| A146 | 11707 |
| A148 | 19532/E |
| A149 | 11708T |
| A150 | 81521 |
| A151 | 81522 |
| A154 | 81593 |
| A158 | 81683 |
| A159 | 81520 |
| A160 | 82001 |
| A161 | 82080 |
| A161 | 82080 |
| A162 | 81833 |
| A164 | 81524 |
| A167 | 81832 |
| A168 | 81525 |
| A171 | 81700 |
| A191 | 81777 |
| A192 | 81856 |
| A197 | 84052 |
| A210 | 82033 |
| A212 | 82025 |
| A221 | 84016 |
| A222 | 84001 |
| A222 | 84001 |
| A230 | 81362 |
| A241 | 81362 |
| A250 | 82013 |
| B114 | 81332 |
| B204 | 81618 |
| B206 | 81586 |
| B207 | 81584 |
| B211 | 81617 |
| B212 | 81616 |
| B213 | 81587 |
| B214 | 81588 |
| B215 | 81589 |
| B216 | 81590 |
| B219 | 81597 |
| B220 | 81794 |
| B226 | 82034 |
| C110 | 81556 |
| C111 | 81513 |
| C112 | 81353 |
| C113 | 81753 |
| C115 | 81822 |

IAM

IAM

IAM

DOLZ

| | |
|------|-------|
| C117 | 81642 |
| C120 | 81713 |
| C121 | 81844 |
| C122 | 81798 |
| C123 | 82042 |
| C123 | 81813 |
| C124 | 81799 |
| C130 | 81752 |
| C137 | 82067 |
| C138 | 82089 |
| C138 | 84038 |
| C138 | 82089 |
| C144 | 81799 |
| C145 | 82068 |
| F105 | 81531 |
| F111 | 81532 |
| F112 | 81602 |
| F114 | 81559 |
| F115 | 81536 |
| F125 | 81655 |
| F126 | 82004 |
| F127 | 81538 |
| F131 | 81654 |
| F135 | 81651 |
| F137 | 81650 |
| F141 | 81803 |
| F145 | 81657 |
| F147 | 81653 |
| F148 | 82057 |
| F150 | 81804 |
| F200 | 81764 |
| F201 | 81802 |
| F203 | 82018 |
| H117 | 81611 |
| H133 | 82039 |
| H200 | 81784 |
| H203 | 81785 |
| H226 | 84015 |
| I170 | 82024 |
| I274 | 82095 |
| I274 | 82095 |
| L120 | 81999 |
| L121 | 81619 |
| L135 | 81460 |
| L155 | 81490 |

DOLZ

| | |
|-------|-------|
| M131 | 81419 |
| M142 | 81614 |
| M143 | 81615 |
| M144 | 81613 |
| M145 | 81707 |
| M174 | 81507 |
| M175 | 81504 |
| M176 | 81506 |
| M179 | 81509 |
| M189 | 81508 |
| M212 | 81730 |
| M213 | 82087 |
| M215 | 82030 |
| M221 | 82047 |
| M-244 | 82092 |
| M276 | 81726 |
| N110 | 81744 |
| N111 | 81736 |
| N120 | 82054 |
| N130 | 82053 |
| N206 | 81672 |
| N304 | 81671 |
| N305 | 81552 |
| N405 | 81512 |
| O104 | 81544 |
| O105 | 81543 |
| O106 | 81549 |
| O116 | 81681 |
| O117 | 81606 |
| O118 | 81605 |
| O129 | 81684 |
| O130 | 81685 |
| O136 | 82005 |
| O137 | 81551 |
| O138 | 81550 |
| O142 | 84005 |
| O160 | 81751 |
| O266 | 84014 |
| R119 | 81572 |
| R122 | 81828 |
| R124 | 81661 |
| R125 | 81664 |
| R129 | 81573 |
| R131 | 81608 |
| R131 | 81666 |

DOLZ

| | |
|------|-------|
| R133 | 81754 |
| R137 | 81667 |
| R140 | 81325 |
| R144 | 81756 |
| R163 | 81660 |
| R164 | 81759 |
| R165 | 81757 |
| R178 | 81576 |
| R179 | 81574 |
| R193 | 81592 |
| R196 | 81594 |
| R216 | 84039 |
| R216 | 81806 |
| R227 | 84007 |
| R231 | 84007 |
| S103 | 81415 |
| S103 | 81300 |
| S125 | 81458 |
| S134 | 81352 |
| S135 | 81481 |
| S138 | 81333 |
| S141 | 81443 |
| S146 | 81476 |
| S148 | 81434 |
| S150 | 81491 |
| S151 | 81334 |
| S153 | 81498 |
| S155 | 81436 |
| S157 | 81492 |
| S160 | 81324 |
| S164 | 81497 |
| S165 | 81309 |
| S166 | 81477 |
| S168 | 81488 |
| S170 | 81450 |
| S172 | 81469 |
| S181 | 81463 |
| S182 | 81456 |
| S184 | 81489 |
| S226 | 81366 |
| S231 | 81351 |
| S320 | 82070 |
| T116 | 81560 |
| T136 | 81554 |
| T224 | 82048 |

**FEBI BILSTEIN**

| | |
|-------|--------------|
| 15947 | 82056 |
| 17130 | 82030 |
| 22251 | 81804 |
| 26279 | 82021 |
| 26393 | 82052 |

GERI

| | |
|--------|--------------|
| 317102 | 81804 |
| 317106 | 82057 |
| 317108 | 82018 |
| 321166 | 82024 |
| 326004 | 81552 |
| 327134 | 82054 |
| 327150 | 82053 |
| 329144 | 82048 |
| 350112 | 82030 |
| 350114 | 82047 |

GGT

| | |
|---------|--------------|
| PA10039 | 82051 |
| PA12506 | 82039 |
| PA12523 | 82095 |
| PA12523 | 82095 |
| PA12541 | 82067 |
| PA12549 | 82070 |
| PA12555 | 82068 |
| PA12562 | 84016 |
| PA12564 | 84001 |
| PA12564 | 84001 |

GK

| | |
|--------|--------------|
| 680293 | 84001 |
| 680293 | 84001 |
| 980107 | 82056 |
| 980262 | 82033 |
| 980273 | 82041 |
| 980481 | 82047 |
| 980494 | 82030 |
| 980501 | 82034 |
| 980753 | 84005 |
| 980773 | 81804 |
| 980776 | 82018 |
| 980778 | 84027 |
| 980817 | 84000 |
| 980901 | 82049 |

**GK**

| | |
|--------|--------------|
| 981034 | 82024 |
| 981201 | 82070 |
| 981734 | 82054 |
| 981736 | 82053 |
| 986807 | 82068 |
| 986809 | 82067 |
| 987515 | 82050 |
| 987691 | 82063 |
| 987691 | 82063 |
| 987733 | 84015 |
| 987766 | 82020 |
| 987768 | 82021 |
| 987769 | 82044 |
| 987772 | 82022 |
| 987793 | 82048 |
| 987802 | 84032 |
| 987812 | 82039 |
| 987832 | 82045 |
| 987980 | 82038 |

GP

| | |
|--------|--------------|
| PA1333 | 84015 |
| PA1367 | 84014 |

GRAF

| | |
|---------|---------------|
| PA088 | 81415 |
| PA095 | 81552 |
| PA098 | 11706T |
| PA1001 | 82071 |
| PA10036 | 81837 |
| PA1006 | 82052 |
| PA101 | 11706T |
| PA1013 | 82093 |
| PA1019 | 82056 |
| PA102 | 81593 |
| PA1020 | 82063 |
| PA1020 | 82063 |
| PA1021 | 84018 |
| PA1023 | 84058 |
| PA1024 | 82021 |
| PA1026 | 82094 |
| PA1030 | 82070 |
| PA1035 | 81579 |
| PA1039 | 84000 |
| PA1046 | 82034 |

**GRAF**

| | |
|--------|--------------|
| PA1052 | 84017 |
| PA1053 | 81795 |
| PA1056 | 84033 |
| pa1068 | 84014 |
| PA1075 | 84024 |
| PA1076 | 84043 |
| PA108 | 81544 |
| PA1085 | 81872 |
| PA1086 | 84032 |
| PA1087 | 84009 |
| PA1088 | 84015 |
| PA1089 | 84001 |
| PA1089 | 84001 |
| PA1090 | 84011 |
| PA1093 | 84028 |
| PA1094 | 84031 |
| PA1097 | 84006 |
| PA1107 | 84004 |
| PA1109 | 84002 |
| PA1125 | 84040 |
| PA113 | 81828 |
| PA1134 | 84030 |
| PA114 | 81592 |
| PA1141 | 84021 |
| PA117 | 81602 |
| PA1185 | 84034 |
| PA1189 | 84026 |
| PA1197 | 84025 |
| PA1246 | 84037 |
| PA131 | 81532 |
| PA146 | 81521 |
| PA147 | 81572 |
| PA148 | 81520 |
| PA153 | 81531 |
| PA154 | 81671 |
| PA159 | 81434 |
| PA197 | 81560 |
| PA240 | 81822 |
| PA243 | 81586 |
| PA247 | 81576 |
| PA256 | 81554 |
| PA264 | 81584 |
| PA275 | 81492 |
| PA278 | 81536 |
| PA279 | 81522 |

IAM

IAM

IAM

GRAF

| | |
|--------|----------------|
| PA286a | 81801 |
| PA293 | 81443 |
| PA295 | 81602 |
| PA298 | 81460 |
| PA304 | 81498 |
| PA306 | 11707 |
| PA312 | 81594 |
| PA317 | 81491 |
| PA318 | 81450 |
| PA321 | 81538 |
| PA323 | 81559 |
| PA324 | 81605 |
| PA325 | 81606 |
| PA328 | 81556 |
| PA338a | 81456 |
| PA340 | 81469 |
| PA344 | 81832 |
| PA346 | 19532/E |
| PA348 | 81512 |
| PA353 | 81660 |
| PA354 | 81458 |
| PA365 | 81464 |
| PA369 | 81616 |
| PA370 | 81617 |
| PA372 | 81477 |
| PA378A | 81309 |
| PA380 | 81618 |
| PA381 | 11701T |
| PA383 | 81683 |
| PA384 | 81833 |
| PA385 | 81611 |
| PA390 | 81587 |
| PA391 | 81642 |
| PA393 | 81672 |
| PA397 | 81460 |
| PA398 | 81476 |
| PA399 | 81490 |
| PA401 | 81650 |
| PA404 | 81619 |
| PA406 | 81508 |
| PA410 | 81684 |
| PA412 | 81661 |
| PA415 | 81685 |
| PA418 | 81436 |
| PA420 | 81302 |

GRAF

| | |
|--------|---------------|
| PA423 | 81525 |
| PA424 | 81772 |
| PA425 | 81524 |
| PA426 | 81614 |
| PA427 | 81615 |
| PA428 | 81613 |
| PA429 | 81654 |
| PA430 | 81590 |
| PA431 | 81589 |
| PA432 | 81588 |
| PA440 | 81653 |
| PA441 | 81543 |
| PA442 | 81549 |
| PA443 | 81681 |
| PA444 | 81489 |
| PA446 | 81504 |
| PA448 | 81506 |
| PA449 | 81507 |
| PA451 | 81300 |
| PA452 | 81324 |
| PA454 | 81488 |
| PA491 | 81513 |
| PA493a | 81744 |
| PA494 | 11708T |
| PA495 | 81509 |
| PA496 | 81322 |
| PA497 | 81315 |
| PA499 | 81334 |
| PA500 | 81332 |
| PA501 | 81655 |
| PA502 | 81597 |
| PA503 | 81325 |
| PA508 | 81736 |
| PA509 | 82004 |
| PA513 | 81755 |
| PA514 | 81666 |
| PA515 | 81851 |
| PA516 | 81754 |
| PA517 | 81602 |
| PA527 | 81664 |
| PA529 | 81596 |
| PA530 | 81756 |
| PA531 | 81574 |
| PA532 | 81759 |
| PA533 | 81757 |

GRAF

| | |
|--------|---------------|
| PA534 | 81758 |
| PA536 | 81667 |
| PA537 | 81742 |
| PA541 | 82005 |
| PA541A | 81817 |
| PA542 | 81353 |
| PA543 | 81608 |
| PA544 | 81367 |
| PA546 | 82001 |
| PA550 | 81573 |
| PA552 | 81339 |
| PA553 | 81304 |
| PA554 | 81481 |
| PA555 | 81715 |
| PA556 | 81714 |
| PA557 | 11701T |
| PA559 | 81434 |
| PA561 | 81843 |
| PA562 | 81707 |
| PA563 | 81708 |
| PA564 | 81709 |
| PA571 | 81687 |
| PA572 | 81550 |
| PA573 | 81828 |
| PA575 | 81999 |
| PA577 | 81551 |
| PA579 | 82080 |
| PA579 | 82080 |
| PA580 | 81722 |
| PA582 | 81499 |
| PA583 | 81723 |
| PA584 | 81724 |
| PA587 | 81419 |
| PA589 | 81657 |
| PA590 | 81656 |
| PA591 | 81700 |
| PA594 | 81853 |
| PA595 | 81811 |
| PA597 | 81854 |
| PA598 | 81314 |
| PA599 | 81333 |
| PA601 | 81303 |
| PA603 | 81527 |
| PA605A | 81347 |
| PA607 | 81316 |

| GRAF | |
|-------------|-------|
| PA609 | 81528 |
| PA610 | 81724 |
| PA611 | 81743 |
| PA612 | 81598 |
| PA614 | 81340 |
| PA615 | 81330 |
| PA616 | 81329 |
| PA617 | 81773 |
| PA618A | 81842 |
| PA620 | 81364 |
| PA621 | 81331 |
| PA622 | 81342 |
| PA624 | 81463 |
| PA626 | 81366 |
| PA627 | 81760 |
| PA628 | 81556 |
| PA629 | 81341 |
| PA630 | 81343 |
| PA631 | 81348 |
| PA632 | 81762 |
| PA633 | 81578 |
| PA635 | 82054 |
| PA636 | 81764 |
| PA637 | 81846 |
| PA639 | 81716 |
| PA640 | 81651 |
| PA641 | 81711 |
| PA642 | 81710 |
| PA643 | 81752 |
| PA644 | 81702 |
| PA645 | 81320 |
| PA646 | 81319 |
| PA647 | 81318 |
| PA653 | 81844 |
| PA654 | 81776 |
| PA655 | 81703 |
| PA658 | 81856 |
| PA660 | 82053 |
| PA661 | 81722 |
| PA664 | 81746 |
| PA664 | 81847 |
| PA665 | 81750 |
| PA666 | 81857 |
| PA667 | 81347 |
| PA669 | 81838 |

| GRAF | |
|-------------|-------|
| PA670 | 81839 |
| PA671 | 81362 |
| PA672 | 81352 |
| PA673 | 81355 |
| PA674 | 81777 |
| PA675 | 81705 |
| PA676 | 81775 |
| PA677 | 81774 |
| PA678 | 82087 |
| PA679 | 81526 |
| PA683 | 81753 |
| PA684 | 81712 |
| PA685 | 81346 |
| PA686 | 81346 |
| PA687 | 81725 |
| PA688 | 81733 |
| PA689 | 81301 |
| PA690 | 81351 |
| PA692 | 81793 |
| PA693 | 81369 |
| PA693 | 81369 |
| PA694 | 81781 |
| PA695 | 81780 |
| PA696 | 81782 |
| PA697 | 81784 |
| PA698 | 81785 |
| PA700 | 81787 |
| PA702 | 81786 |
| PA703 | 81745 |
| PA704 | 81717 |
| PA706 | 81726 |
| PA708 | 81728 |
| PA709 | 81729 |
| PA710 | 81730 |
| PA712 | 81766 |
| PA713 | 81767 |
| PA715 | 81770 |
| PA717 | 81769 |
| PA718 | 81771 |
| PA719 | 81768 |
| PA721 | 81852 |
| PA723 | 81761 |
| PA724 | 84039 |
| PA724 | 81806 |
| PA724A | 84039 |

| GRAF | |
|-------------|-------|
| PA725 | 81789 |
| PA726 | 81790 |
| PA727 | 81751 |
| PA728 | 81748 |
| PA729 | 81749 |
| PA730 | 81747 |
| PA731 | 81706 |
| PA733 | 81344 |
| PA736 | 82087 |
| PA737 | 81796 |
| PA738 | 81783 |
| PA739 | 81370 |
| PA741 | 81803 |
| PA742 | 81802 |
| PA746 | 82084 |
| PA747 | 81713 |
| PA749 | 82056 |
| PA749 | 82056 |
| PA749 | 82056 |
| PA750 | 81834 |
| PA751 | 81835 |
| PA752 | 82088 |
| PA758 | 81701 |
| PA759 | 81794 |
| PA761 | 84010 |
| PA761 | 81791 |
| PA762 | 81816 |
| PA762 | 84011 |
| PA763 | 81842 |
| PA764 | 82081 |
| PA765 | 81840 |
| PA773 | 81858 |
| PA779 | 81529 |
| PA799 | 81731 |
| PA802 | 81362 |
| PA803 | 81855 |
| PA804 | 81807 |
| PA806 | 84052 |
| PA816 | 82038 |
| PA819 | 84012 |
| PA820 | 81820 |
| PA821 | 81810 |
| PA822 | 81814 |
| PA823 | 82023 |
| PA824 | 81864 |

IAM

IAM

IAM

GRAF

| | |
|-------|-------|
| PA826 | 81808 |
| PA827 | 82048 |
| PA829 | 82085 |
| PA830 | 82028 |
| PA832 | 82057 |
| PA834 | 81836 |
| PA836 | 82034 |
| PA837 | 81797 |
| PA839 | 81805 |
| PA855 | 81867 |
| PA859 | 81798 |
| PA860 | 81861 |
| PA861 | 81800 |
| PA862 | 81799 |
| PA863 | 81799 |
| PA864 | 81809 |
| PA865 | 81779 |
| PA866 | 81369 |
| PA868 | 81705 |
| PA875 | 82013 |
| PA876 | 82039 |
| PA878 | 81816 |
| PA878 | 84011 |
| PA879 | 84010 |
| PA879 | 81791 |
| PA880 | 82086 |
| PA881 | 81819 |
| PA882 | 82014 |
| PA884 | 82029 |
| PA885 | 84004 |
| PA886 | 81813 |
| PA887 | 81862 |
| PA888 | 82047 |
| PA890 | 81821 |
| PA893 | 82010 |
| PA900 | 82024 |
| PA901 | 81872 |
| PA902 | 82018 |
| PA903 | 81804 |
| PA905 | 81816 |
| PA905 | 84011 |
| PA906 | 81813 |
| PA907 | 81868 |
| PA908 | 82030 |
| PA909 | 82082 |

GRAF

| | |
|--------|-------|
| PA912 | 82055 |
| PA919 | 82012 |
| PA926 | 82050 |
| PA938 | 81869 |
| PA940 | 81818 |
| PA941 | 82016 |
| PA946 | 82026 |
| PA949 | 82045 |
| PA950 | 82020 |
| PA956 | 82036 |
| PA958 | 82011 |
| PA959 | 82083 |
| PA960 | 82042 |
| PA961 | 82044 |
| PA962 | 84060 |
| PA965 | 82040 |
| PA965 | 82040 |
| PA967 | 82095 |
| PA967 | 82095 |
| PA972 | 81785 |
| PA973 | 82092 |
| PA974 | 81845 |
| PA978 | 82017 |
| PA979 | 82015 |
| PA980 | 82025 |
| PA981 | 82091 |
| PA982 | 82033 |
| PA983 | 82090 |
| PA985 | 84013 |
| PA986 | 82049 |
| PA990 | 82027 |
| PA991 | 84057 |
| PA992 | 82058 |
| PA993 | 82059 |
| PA994 | 82032 |
| PA996 | 82066 |
| PA1239 | 84066 |

HEPU

| | |
|-------|--------|
| P014 | 11701T |
| P015 | 81322 |
| P017 | 81315 |
| P022 | 11706T |
| P0243 | 82080 |
| P0243 | 82080 |

HEPU

| | |
|-------|-------|
| P028 | 81443 |
| P045 | 81615 |
| P046 | 81613 |
| P051 | 81592 |
| P053 | 81594 |
| P054 | 81574 |
| P056 | 82056 |
| P056 | 81857 |
| P056 | 82056 |
| P061 | 81779 |
| P064 | 81456 |
| P065 | 81434 |
| P065S | 81434 |
| P068 | 81304 |
| P070 | 81415 |
| P072 | 81481 |
| P080 | 81419 |
| P081 | 81436 |
| P088 | 81300 |
| P094 | 81801 |
| P099 | 81460 |
| P100 | 81339 |
| P100 | 81333 |
| P1012 | 81331 |
| P1015 | 81318 |
| P102 | 81463 |
| P103 | 81464 |
| P1033 | 81364 |
| P1034 | 82024 |
| P1035 | 81351 |
| P1042 | 81316 |
| P1045 | 81329 |
| P1049 | 81347 |
| P1055 | 81352 |
| P1061 | 81469 |
| P109 | 81458 |
| P115 | 81476 |
| P1155 | 81334 |
| P1157 | 81491 |
| P1161 | 81332 |
| P119 | 81488 |
| P1201 | 82070 |
| P122 | 81303 |
| P123 | 81303 |
| P125 | 81314 |

| | |
|------------|------------------------|
| IAM | MAGNETI MARELLI |
|------------|------------------------|

| HEPU | |
|-------------|-------|
| P127 | 81369 |
| P127 | 81369 |
| P131 | 82049 |
| P131 | 82088 |
| P133 | 81773 |
| P134 | 82030 |
| P136 | 81726 |
| P139 | 82047 |
| P140 | 82087 |
| P142 | 81725 |
| P143 | 81774 |
| P144 | 81728 |
| P145 | 81729 |
| P147 | 81730 |
| P160 | 81504 |
| P161 | 81723 |
| P162 | 81722 |
| P163 | 81722 |
| P164 | 81722 |
| P165 | 81509 |
| P176 | 81506 |
| P177 | 81507 |
| P188 | 81499 |
| P190 | 81508 |
| P191 | 81722 |
| P192 | 81722 |
| P193 | 81722 |
| P194 | 81724 |
| P195 | 81724 |
| P196 | 81724 |
| P197 | 81724 |
| P201 | 81538 |
| P202 | 81559 |
| P204 | 81650 |
| P206 | 81532 |
| P215 | 81531 |
| P220 | 81654 |
| P221 | 82004 |
| P222 | 81653 |
| P224 | 81655 |
| P227 | 81651 |
| P228 | 81657 |
| P230 | 81656 |
| P232 | 81716 |
| P234 | 81773 |

| | |
|------------|------------------------|
| IAM | MAGNETI MARELLI |
|------------|------------------------|

| HEPU | |
|-------------|-------|
| P235 | 81598 |
| P236 | 81803 |
| P237 | 81802 |
| P242 | 81522 |
| P244 | 81302 |
| P245 | 81362 |
| P248 | 82057 |
| P251 | 81804 |
| P254 | 82018 |
| P297 | 81536 |
| P298 | 81602 |
| P299 | 81602 |
| P310 | 81684 |
| P313 | 81685 |
| P314 | 81551 |
| P317 | 82005 |
| P320 | 81846 |
| P322 | 81749 |
| P326 | 84005 |
| P327 | 81751 |
| P331 | 81812 |
| P333 | 81687 |
| P338 | 81605 |
| P341 | 81746 |
| P342 | 81748 |
| P343 | 81750 |
| P345 | 81362 |
| P362 | 81597 |
| P369 | 84014 |
| P371 | 84027 |
| P384 | 81544 |
| P387 | 81543 |
| P388 | 81681 |
| P398 | 81606 |
| P421 | 84000 |
| P457 | 81618 |
| P458 | 81616 |
| P459 | 81587 |
| P463 | 81793 |
| P464 | 81796 |
| P464 | 81795 |
| P465 | 81584 |
| P467 | 82034 |
| P470 | 81590 |
| P471 | 81589 |

| | |
|------------|------------------------|
| IAM | MAGNETI MARELLI |
|------------|------------------------|

| HEPU | |
|-------------|-------|
| P472 | 81588 |
| P474 | 81617 |
| P475 | 81586 |
| P509 | 81498 |
| P514 | 81521 |
| P515 | 81520 |
| P516 | 82001 |
| P517 | 81833 |
| P518 | 81526 |
| P519 | 81529 |
| P521 | 81525 |
| P524 | 81773 |
| P527 | 81593 |
| P528 | 81772 |
| P532 | 81832 |
| P533 | 81524 |
| P534 | 81683 |
| P535 | 81700 |
| P536 | 81701 |
| P540 | 81527 |
| P541 | 81775 |
| P542 | 81528 |
| P543 | 81774 |
| P544 | 81842 |
| P545 | 81702 |
| P547 | 81703 |
| P549 | 81706 |
| P556 | 81776 |
| P557 | 81777 |
| P559 | 81705 |
| P571 | 81856 |
| P576 | 82033 |
| P587 | 82025 |
| P606 | 81764 |
| P607 | 81747 |
| P608 | 81760 |
| P620 | 81999 |
| P622 | 81619 |
| P623 | 81513 |
| P624 | 81717 |
| P655 | 84001 |
| P655 | 84001 |
| P736 | 82053 |
| P741 | 81736 |
| P748 | 81743 |

IAM

IAM

IAM

HEPU

| | |
|-------|-------|
| P749 | 81742 |
| P7515 | 82050 |
| P7691 | 82063 |
| P7691 | 82063 |
| P7732 | 81787 |
| P7733 | 84015 |
| P7740 | 81731 |
| P7766 | 82020 |
| P7768 | 82021 |
| P7769 | 82044 |
| P777 | 81613 |
| P7772 | 82022 |
| P7793 | 82048 |
| P7802 | 84032 |
| P7812 | 82039 |
| P7832 | 82045 |
| P791 | 81781 |
| P792 | 81549 |
| P793 | 81780 |
| P795 | 81782 |
| P796 | 81550 |
| P7980 | 82038 |
| P799 | 81783 |
| P807 | 82068 |
| P809 | 82067 |
| P812 | 81513 |
| P813 | 81556 |
| P814 | 81572 |
| P815 | 81512 |
| P815 | 81672 |
| P816 | 81554 |
| P817 | 81755 |
| P819 | 81666 |
| P820 | 81758 |
| P821 | 81560 |
| P822 | 81851 |
| P823 | 81667 |
| P824 | 81754 |
| P832 | 81596 |
| P836 | 81642 |
| P837 | 81759 |
| P838 | 81712 |
| P843 | 81353 |
| P844 | 81346 |
| P847 | 81346 |

HEPU

| | |
|-------|-------|
| P848 | 81608 |
| P868 | 81671 |
| P870 | 81596 |
| P871 | 81512 |
| P876 | 81573 |
| P876 | 81811 |
| P891 | 81753 |
| P895 | 81711 |
| P914 | 81828 |
| P917 | 81760 |
| P927 | 81576 |
| P930 | 81661 |
| P931 | 81578 |
| P935 | 81664 |
| P940 | 81761 |
| P942 | 81660 |
| P954S | 84024 |
| P962 | 84007 |

HERTH+
BUSS JAKOPARTS

| | |
|----------|-------|
| J1510323 | 82020 |
| J1510529 | 84018 |
| J1511065 | 82053 |
| J1512086 | 82048 |
| J1512092 | 82022 |
| J1512092 | 82044 |
| J1512115 | 82051 |
| J1513060 | 84060 |
| J1514039 | 82039 |
| J1514042 | 82045 |
| J1515065 | 82049 |
| J1518010 | 82050 |

JAPANPARTS

| | |
|--------|-------|
| PQ-203 | 82051 |
| PQ-274 | 84030 |
| PQ-275 | 84031 |
| PQ-276 | 82048 |
| PQ-283 | 82044 |
| PQ-436 | 82039 |
| PQ-439 | 82045 |
| PQ-921 | 84033 |
| PQ-H03 | 84018 |
| PQ-H05 | 81785 |

JAPANPARTS

| | |
|---------|-------|
| PQ-H12 | 84059 |
| PQ-K02 | 82038 |
| PQ-K04 | 84015 |
| PQ-K16 | 84058 |
| PQ-KI15 | 82020 |

JWP

| | |
|---------|-------|
| HW-1049 | 82021 |
| HW-1053 | 82020 |
| HW-1843 | 82045 |
| HW-2838 | 82039 |
| KW-1606 | 82038 |
| MW-1457 | 82049 |
| NW-1249 | 82053 |
| NW-3207 | 82054 |
| SW-1916 | 82050 |
| TW-1155 | 82051 |
| TW1192 | 82022 |
| TW-5105 | 82048 |

KAGER

| | |
|---------|-------|
| 330621 | 82030 |
| 330624 | 82047 |
| 330684 | 82024 |
| 33-0339 | 82053 |
| 33-0418 | 82056 |
| 33-0477 | 82048 |
| 33-0481 | 82034 |
| 33-0643 | 82050 |
| 33-0687 | 82039 |
| 33-0715 | 82045 |
| 33-1042 | 82095 |
| 33-1042 | 82095 |
| 33-1052 | 84033 |
| 33-1060 | 84032 |

KAVO PARTS

| | |
|---------|-------|
| TW-5148 | 84028 |
| TW-5154 | 84032 |

KWP

| | |
|-------|--------|
| 10098 | 11706T |
| 10154 | 81671 |
| 10635 | 82054 |
| 10660 | 82053 |

| IAM | MAGNETI MARELLI |
|------------|-----------------|
| KWP | |
| 10749 | 82056 |
| 10799 | 81731 |
| 10816 | 82038 |
| 10827 | 82048 |
| 10832 | 82057 |
| 10836 | 82034 |
| 10876 | 82039 |
| 10888 | 82047 |
| 10900 | 82024 |
| 10902 | 82018 |
| 10903 | 81804 |
| 10908 | 82030 |
| 10926 | 82050 |
| 10950 | 82020 |
| 10956 | 82036 |
| 10960 | 82042 |
| 10961 | 82044 |
| 10962 | 84060 |
| 10967 | 82095 |
| 10967 | 82095 |
| 10980 | 82025 |
| 10981 | 82091 |
| 10982 | 82033 |
| 10983 | 82090 |
| 10985 | 84013 |
| 10986 | 82049 |
| 10991 | 84057 |
| 10992 | 82058 |
| 10993 | 82059 |
| 10994 | 82032 |
| 10996 | 82066 |
| 100972 | 81785 |
| 100973 | 82092 |
| 101001 | 82071 |
| 101006 | 82052 |
| 101013 | 82093 |
| 101019 | 82056 |
| 101020 | 82063 |
| 101020 | 82063 |
| 101023 | 84058 |
| 101024 | 82021 |
| 101026 | 82094 |
| 101030 | 82070 |
| 101039 | 84000 |
| 101046 | 82034 |

| IAM | MAGNETI MARELLI |
|----------------|-----------------|
| KWP | |
| 101052 | 84017 |
| 101056 | 84033 |
| 101068 | 84014 |
| 101075 | 84024 |
| 101081 | 81872 |
| 101086 | 84032 |
| 101087 | 84009 |
| 101088 | 84015 |
| 101089 | 84001 |
| 101089 | 84001 |
| 101093 | 84028 |
| 101094 | 84031 |
| 101097 | 84006 |
| 101107 | 84004 |
| 101109 | 84002 |
| 10-946 | 82026 |
| PA195 | 81552 |
| LPR | |
| WP0429 | 82056 |
| WP0449 | 84007 |
| WP0740 | 82070 |
| METELLI | |
| 240095 | 81552 |
| 240154 | 81671 |
| 240888 | 82047 |
| 240900 | 82024 |
| 240902 | 82018 |
| 240908 | 82030 |
| 240946 | 82026 |
| 240981 | 82091 |
| 240983 | 82090 |
| 24-0635 | 82054 |
| 24-0660 | 82053 |
| 24-0700 | 81787 |
| 24-0749 | 82056 |
| 24-0816 | 82038 |
| 24-0827 | 82048 |
| 24-0832 | 82057 |
| 24-0836 | 82034 |
| 24-0876 | 82039 |
| 24-0903 | 81804 |
| 24-0926 | 82050 |
| 24-0950 | 82020 |

| IAM | MAGNETI MARELLI |
|----------------|-----------------|
| METELLI | |
| 24-0956 | 82036 |
| 24-0960 | 82042 |
| 24-0961 | 82044 |
| 24-0962 | 84060 |
| 24-0967 | 82095 |
| 24-0967 | 82095 |
| 24-0973 | 82092 |
| 24-098 | 11706T |
| 24-0980 | 82025 |
| 24-0982 | 82033 |
| 24-0985 | 84013 |
| 24-0986 | 82049 |
| 24-0991 | 84057 |
| 24-0992 | 82058 |
| 24-0993 | 82059 |
| 24-0994 | 82032 |
| 24-0996 | 82066 |
| 24-1001 | 82071 |
| 24-1006 | 82052 |
| 24-1013 | 82093 |
| 24-1019 | 82056 |
| 24-1020 | 82063 |
| 24-1020 | 82063 |
| 24-1023 | 84058 |
| 24-1024 | 82021 |
| 24-1026 | 82094 |
| 24-1030 | 82070 |
| 24-1039 | 84000 |
| 24-1046 | 82034 |
| 24-1052 | 84017 |
| 24-1056 | 84033 |
| 24-1068 | 84014 |
| 24-1075 | 84024 |
| 24-1081 | 81872 |
| 24-1086 | 84032 |
| 24-1087 | 84009 |
| 24-1088 | 84015 |
| 24-1089 | 84001 |
| 24-1089 | 84001 |
| 24-1093 | 84028 |
| 24-1094 | 84031 |
| 24-1097 | 84006 |
| 24-1107 | 84004 |
| 24-1109 | 84002 |
| 24-799 | 81731 |

IAM

METELLI

| | |
|--------|--------------|
| 24-830 | 82028 |
| 24-972 | 81785 |

MEYLE

| | |
|----------------|--------------|
| 0132200001 | 82030 |
| 0132200003 | 82047 |
| 0132200001HD | 82030 |
| 113 220 0005 | 82033 |
| 30-13 161 0001 | 82051 |
| 513 050 0003 | 82056 |
| 713 220 0005 | 81804 |

NIPPARTS

| | |
|----------|--------------|
| J1510315 | 84058 |
| J1510501 | 82020 |
| J1510520 | 82021 |
| J1510529 | 84015 |
| J1511032 | 82054 |
| J1511065 | 82053 |
| J1512069 | 82051 |
| J1512086 | 82048 |
| J1512092 | 82022 |
| J1512108 | 82044 |
| J1513036 | 82092 |
| J1513060 | 84060 |
| J1514039 | 82039 |
| J1514042 | 82045 |
| J1515065 | 82049 |
| J1518010 | 82050 |
| Y1510306 | 82038 |

OPEN PARTS

| | |
|------------|--------------|
| WAP8321.00 | 82056 |
| WAP8458.00 | 84007 |

OPTIBELT

| | |
|---------|--------------|
| AQ-2278 | 84008 |
|---------|--------------|

OPTIMAL

| | |
|---------|--------------|
| AQ-1197 | 81804 |
| AQ1214 | 82018 |
| AQ-1419 | 82054 |
| AQ-1427 | 82053 |
| AQ-1769 | 82051 |
| AQ1809 | 82024 |

IAM

OPTIMAL

| | |
|---------|--------------|
| AQ1814 | 82030 |
| AQ1815 | 82047 |
| AQ-1846 | 82048 |
| AQ-2209 | 84000 |

PEX

| | |
|---------|--------------|
| 19.0332 | 82053 |
|---------|--------------|

QUINTON HAZELL

| | |
|-----------|---------------|
| 3549 | 82057 |
| QCP1018 | 81434 |
| QCP1019 | 81671 |
| QCP1292 | 81664 |
| QCP1294 | 81593 |
| QCP1350 | 81549 |
| QCP1425 | 11707 |
| QCP1431 | 81443 |
| QCP1434 | 81460 |
| QCP1435 | 81506 |
| QCP1535 | 82054 |
| QCP2062 | 81544 |
| QCP2111 | 81415 |
| QCP2273 | 82040 |
| QCP2338 | 81822 |
| QCP2346 | 81554 |
| QCP2358 | 81584 |
| QCP2364 | 11706T |
| QCP2369 | 11701T |
| QCP2369 | 11701T |
| QCP2433 | 81784 |
| QCP2449 | 81492 |
| QCP2450 | 81504 |
| QCP2470 | 81574 |
| QCP2471 | 81543 |
| QCP2474 | 81576 |
| QCP2477 | 81618 |
| QCP2483 | 81521 |
| QCP2483BH | 82001 |
| QCP2492 | 81797 |
| QCP2492 | 81556 |
| QCP2499 | 81608 |
| QCP2512 | 81606 |
| QCP2513 | 81681 |
| QCP2517 | 81605 |
| QCP2525 | 81602 |

IAM

QUINTON HAZELL

| | |
|-----------|--------------|
| QCP2526 | 81532 |
| QCP2527 | 81538 |
| QCP2545 | 81536 |
| QCP2558 | 81491 |
| QCP2563 | 81507 |
| QCP2565 | 81559 |
| QCP2569 | 81450 |
| QCP2570BH | 81456 |
| QCP2570BH | 81344 |
| QCP2572 | 81458 |
| QCP2587 | 81498 |
| QCP2591 | 81619 |
| QCP2615 | 81436 |
| QCP2645 | 81683 |
| QCP2646 | 81616 |
| QCP2647 | 81617 |
| QCP2652 | 81650 |
| QCP2660 | 81661 |
| QCP2661 | 81574 |
| QCP2664 | 81833 |
| QCP2671 | 81587 |
| QCP2674 | 81832 |
| QCP2682BH | 81463 |
| QCP2683 | 81326 |
| QCP2683BH | 81464 |
| QCP2686 | 81684 |
| QCP2688 | 81660 |
| QCP2697BH | 81309 |
| QCP2705 | 81611 |
| QCP2735 | 81588 |
| QCP2743 | 81614 |
| QCP2743 | 81615 |
| QCP2746 | 81685 |
| QCP2801 | 81828 |
| QCP2804 | 81589 |
| QCP2873 | 81353 |
| QCP2881 | 81736 |
| QCP2882 | 81744 |
| QCP2884 | 81672 |
| QCP2887 | 81654 |
| QCP2888 | 81302 |
| QCP2889 | 81655 |
| QCP2891 | 81512 |
| QCP2894 | 81653 |
| QCP2899 | 81490 |

| IAM | MAGNETI MARELLI |
|-----------------------|-----------------|
| QUINTON HAZELL | |
| QCP2904 | 11708T |
| QCP2925 | 81772 |
| QCP2925 | 81807 |
| QCP2928 | 81594 |
| QCP2932 | 81488 |
| QCP2933 | 81489 |
| QCP2934 | 81654 |
| QCP2941 | 81554 |
| QCP2944 | 81642 |
| QCP2950 | 81789 |
| QCP2960 | 81743 |
| QCP2961 | 19532/E |
| QCP2962 | 81854 |
| QCP2971 | 81508 |
| QCP2978 | 81770 |
| QCP2985 | 81315 |
| QCP2986 | 81300 |
| QCP2987 | 81324 |
| QCP2989 | 81509 |
| QCP2990 | 82004 |
| QCP2997 | 81573 |
| QCP2997BH | 81811 |
| QCP3000 | 81314 |
| QCP3000BH | 81476 |
| QCP3036 | 81790 |
| QCP3037 | 81858 |
| QCP3041 | 81770 |
| QCP3058 | 81551 |
| QCP3059 | 81550 |
| QCP3060 | 81613 |
| QCP3067 | 81590 |
| QCP3070 | 81367 |
| QCP3074 | 81333 |
| QCP3084 | 81817 |
| QCP3084 | 82005 |
| QCP3090 | 82056 |
| QCP3090 | 82056 |
| QCP3092 | 81322 |
| QCP3093 | 81700 |
| QCP3096 | 81597 |
| QCP3097 | 81742 |
| QCP3098 | 81714 |
| QCP3100 | 81656 |
| QCP3102 | 81325 |
| QCP3105 | 81499 |

| IAM | MAGNETI MARELLI |
|-----------------------|-----------------|
| QUINTON HAZELL | |
| QCP3106 | 81754 |
| QCP3110 | 81334 |
| QCP3111 | 81332 |
| QCP3113 | 81365 |
| QCP3113BH | 81304 |
| QCP3114 | 81339 |
| QCP3114BH | 81303 |
| QCP3116 | 81717 |
| QCP3119 | 81722 |
| QCP3124 | 81667 |
| QCP3125 | 81707 |
| QCP3126 | 81708 |
| QCP3127BH | 81497 |
| QCP3133 | 81766 |
| QCP3135 | 81687 |
| QCP3137 | 81759 |
| QCP3138 | 81758 |
| QCP3139 | 81757 |
| QCP3140 | 81596 |
| QCP3155 | 81773 |
| QCP3156 | 81528 |
| QCP3157 | 81527 |
| QCP3165 | 81513 |
| QCP3168 | 81746 |
| QCP3170 | 81723 |
| QCP3172 | 81724 |
| QCP3173 | 81724 |
| QCP3177 | 81745 |
| QCP3179 | 81756 |
| QCP3179BH | 81853 |
| QCP3182 | 81731 |
| QCP3186 | 81666 |
| QCP3192 | 81715 |
| QCP3195 | 81525 |
| QCP3201 | 81851 |
| QCP3202 | 81755 |
| QCP3208 | 81364 |
| QCP3208BH | 81341 |
| QCP3209 | 81316 |
| QCP3211 | 81331 |
| QCP3212 | 81526 |
| QCP3212BH | 81529 |
| QCP3213 | 81842 |
| QCP3218 | 81340 |
| QCP3219 | 81329 |

| IAM | MAGNETI MARELLI |
|-----------------------|-----------------|
| QUINTON HAZELL | |
| QCP3224 | 81598 |
| QCP3226 | 81760 |
| QCP3227 | 81579 |
| QCP3228 | 81578 |
| QCP3229 | 81857 |
| QCP3231 | 81838 |
| QCP3235 | 81839 |
| QCP3243 | 81651 |
| QCP3244 | 81771 |
| QCP3255 | 81846 |
| QCP3257 | 81709 |
| QCP3262 | 81769 |
| QCP3274 | 81657 |
| QCP3289 | 81368 |
| QCP3289BH | 81346 |
| QCP3290 | 82011 |
| QCP3290 | 81749 |
| QCP3292 | 81750 |
| QCP3293 | 81748 |
| QCP3298 | 81702 |
| QCP3299 | 81762 |
| QCP3300 | 81835 |
| QCP3301 | 81764 |
| QCP3302 | 81768 |
| QCP3304 | 81777 |
| QCP3305BH | 81852 |
| QCP3306 | 81703 |
| QCP3313 | 81716 |
| QCP3315 | 81369 |
| QCP3316 | 81348 |
| QCP3318 | 81301 |
| QCP3319 | 81774 |
| QCP3322 | 81710 |
| QCP3323 | 81711 |
| QCP3326 | 81776 |
| QCP3327 | 81753 |
| QCP3336 | 81785 |
| QCP3345 | 81782 |
| QCP3346 | 81780 |
| QCP3348 | 82053 |
| QCP3359 | 82051 |
| QCP3360 | 81783 |
| QCP3361 | 81837 |
| QCP3362 | 81787 |
| QCP3363 | 81362 |

IAM

IAM

IAM

QUINTON HAZELL

| | |
|-----------|-------|
| QCP3364 | 81351 |
| QCP3365 | 81775 |
| QCP3366 | 81352 |
| QCP3367 | 81366 |
| QCP3367BH | 81343 |
| QCP3368 | 81733 |
| QCP3369 | 81856 |
| QCP3371 | 81355 |
| QCP3372 | 81705 |
| QCP3373 | 81793 |
| QCP3373 | 81794 |
| QCP3375 | 81844 |
| QCP3376 | 81712 |
| QCP3377 | 81320 |
| QCP3378 | 81318 |
| QCP3379 | 81319 |
| QCP3380 | 82087 |
| QCP3381 | 81730 |
| QCP3382 | 82088 |
| QCP3383 | 81726 |
| QCP3384 | 81728 |
| QCP3385 | 81729 |
| QCP3386 | 81751 |
| QCP3387 | 81747 |
| QCP3389 | 84039 |
| QCP3389 | 81806 |
| QCP3390 | 81761 |
| QCP3391 | 81713 |
| QCP3394 | 81703 |
| QCP3397 | 81725 |
| QCP3398 | 81586 |
| QCP3399BH | 81469 |
| QCP3401 | 81786 |
| QCP3403 | 81477 |
| QCP3404 | 81524 |
| QCP3405 | 81363 |
| QCP3405BH | 81347 |
| QCP3407 | 81372 |
| QCP3407BH | 81342 |
| QCP3408 | 81803 |
| QCP3409 | 81845 |
| QCP3410 | 81802 |
| QCP3422 | 81370 |
| QCP3429 | 81815 |
| QCP3430 | 82048 |

QUINTON HAZELL

| | |
|---------|-------|
| QCP3431 | 81809 |
| QCP3435 | 81369 |
| QCP3436 | 81801 |
| QCP3437 | 81808 |
| QCP3439 | 81767 |
| QCP3442 | 81706 |
| QCP3448 | 82050 |
| QCP3452 | 82012 |
| QCP3454 | 81781 |
| QCP3458 | 81816 |
| QCP3458 | 84011 |
| QCP3476 | 84010 |
| QCP3476 | 81791 |
| QCP3477 | 82081 |
| QCP3478 | 81840 |
| QCP3479 | 81842 |
| QCP3480 | 81779 |
| QCP3482 | 84052 |
| QCP3483 | 81836 |
| QCP3483 | 81847 |
| QCP3492 | 81799 |
| QCP3493 | 82086 |
| QCP3494 | 81800 |
| QCP3495 | 81701 |
| QCP3501 | 82021 |
| QCP3503 | 82038 |
| QCP3504 | 81796 |
| QCP3505 | 81795 |
| QCP3520 | 81855 |
| QCP3527 | 82055 |
| QCP3529 | 82039 |
| QCP3539 | 81804 |
| QCP3540 | 81812 |
| QCP3541 | 81813 |
| QCP3542 | 81805 |
| QCP3561 | 82034 |
| QCP3567 | 82013 |
| QCP3595 | 82045 |
| QCP3596 | 82041 |
| QCP3606 | 82042 |
| QCP3617 | 82047 |
| QCP3629 | 84007 |
| QCP3680 | 84000 |
| QCP3681 | 84014 |
| QCP3686 | 84015 |

QUINTON HAZELL

| | |
|-----------|-------|
| QCP3709P | 81419 |
| QCP3710 | 81419 |
| QCP3752 | 84035 |
| QCP3790 | 84033 |
| QCP3792 | 84008 |
| QCP4163 | 81752 |
| QCP4220 | 81330 |
| QCP4453 | 81522 |
| QCP4453BH | 82080 |
| QCP4453BH | 82080 |
| QCP766 | 81481 |
| QCP958 | 81572 |
| QCP969 | 81592 |
| QCP972 | 81999 |
| QCP977 | 81560 |
| QCP985 | 81531 |
| QCP986 | 81520 |

RUVILLE

| | |
|-------|-------|
| 65023 | 82034 |
| 65109 | 82030 |
| 65129 | 82047 |
| 65214 | 81804 |
| 65216 | 82018 |
| 65434 | 84001 |
| 65434 | 84001 |
| 66816 | 82053 |
| 66940 | 82048 |
| 67403 | 82039 |
| 67702 | 82050 |
| 68900 | 82038 |

Saleri SIL

| | |
|--------|-------|
| PA1001 | 81712 |
| PA1002 | 81701 |
| PA1048 | 81798 |
| PA1048 | 82040 |
| PA1049 | 84010 |
| PA1049 | 81791 |
| PA1051 | 82081 |
| PA1053 | 82029 |
| PA1054 | 81713 |
| PA1055 | 81799 |
| PA1057 | 81834 |
| PA1059 | 81837 |

| IAM | MAGNETI MARELLI |
|-------------------|-----------------|
| Saleri SIL | |
| PA1060 | 81840 |
| PA1069 | 81842 |
| PA1071 | 81794 |
| PA1072 | 81796 |
| PA1072 | 81795 |
| PA1073 | 81783 |
| PA1075 | 81838 |
| PA1078 | 81785 |
| PA1087 | 82084 |
| PA1095 | 82053 |
| PA1102 | 84052 |
| PA1116 | 81302 |
| PA1121 | 81861 |
| PA1126 | 81362 |
| PA1128 | 81835 |
| PA1129 | 84012 |
| PA1130 | 81820 |
| PA1131 | 81810 |
| PA1132 | 81814 |
| PA1133 | 82056 |
| PA1133 | 82056 |
| PA1134 | 81836 |
| PA1135 | 81805 |
| PA1138 | 81804 |
| PA1160 | 81808 |
| PA1161 | 81809 |
| PA1162 | 82048 |
| PA121 | 81419 |
| PA1216 | 81817 |
| PA1217 | 81818 |
| PA1224 | 81855 |
| PA1230 | 82033 |
| PA1232 | 81866 |
| PA1233 | 81867 |
| PA1234 | 81797 |
| PA1235 | 81800 |
| PA1236 | 81813 |
| PA1237 | 81862 |
| PA1242 | 82051 |
| PA1244 | 82030 |
| PA1246 | 81872 |
| PA1248 | 82040 |
| PA1249 | 82040 |
| PA1251 | 81812 |
| PA1252 | 81869 |

| IAM | MAGNETI MARELLI |
|-------------------|-----------------|
| Saleri SIL | |
| PA1253 | 82018 |
| PA1254 | 82057 |
| PA1255 | 84004 |
| PA1259 | 82083 |
| PA1260 | 82024 |
| PA1264 | 82082 |
| PA1267 | 82042 |
| PA1268 | 82041 |
| PA1269 | 82011 |
| PA1271 | 81865 |
| PA1272 | 81821 |
| PA1273 | 82046 |
| PA1274 | 81868 |
| PA1278 | 82052 |
| PA1282 | 81864 |
| PA1284 | 82047 |
| PA1285 | 84013 |
| PA1290 | 82015 |
| PA1293 | 81816 |
| PA1293 | 84011 |
| PA1294 | 82034 |
| PA1295 | 82010 |
| PA1302 | 81839 |
| PA1303 | 82039 |
| PA1304 | 82045 |
| PA1305 | 81785 |
| PA1306 | 82021 |
| PA1312 | 82038 |
| PA1321 | 82055 |
| PA1322 | 81771 |
| PA1328 | 82092 |
| PA1329 | 82014 |
| PA1330 | 82023 |
| PA1331 | 82028 |
| PA1347 | 82026 |
| PA1348 | 82022 |
| PA1349 | 82020 |
| PA1355A | 82013 |
| PA1360 | 81733 |
| PA1371 | 82063 |
| PA1371 | 82063 |
| PA1373 | 82025 |
| PA1385 | 82070 |
| PA1394 | 82066 |
| PA1395 | 84007 |

| IAM | MAGNETI MARELLI |
|-------------------|-----------------|
| Saleri SIL | |
| PA1402 | 84057 |
| PA1404 | 82090 |
| PA1425 | 82032 |
| PA1426 | 82068 |
| PA1440 | 82044 |
| PA1454 | 84059 |
| PA1459 | 84018 |
| PA1475 | 84017 |
| PA1481 | 81872 |
| PA1487 | 84000 |
| PA1502 | 84033 |
| PA1503 | 84035 |
| PA1507 | 84021 |
| PA1510 | 84030 |
| PA1511 | 84008 |
| PA1519 | 81819 |
| PA1532 | 84037 |
| PA1540 | 84043 |
| PA1550 | 84040 |
| PA1582 | 84034 |
| PA201AC | 81419 |
| PA206P | 81415 |
| PA215 | 81532 |
| PA224 | 81552 |
| PA229P | 81572 |
| PA231 | 81999 |
| PA232 | 81671 |
| PA234P | 81481 |
| PA257 | 81592 |
| PA259 | 81560 |
| PA275E | 81531 |
| PA276 | 11706T |
| PA278P | 81520 |
| PA280 | 81660 |
| PA288 | 81434 |
| PA288S | 81434 |
| PA318 | 82050 |
| PA355 | 81544 |
| PA358P | 81543 |
| PA364 | 81828 |
| PA373 | 81602 |
| PA380P | 81593 |
| PA382 | 81586 |
| PA386 | 81618 |
| PA397 | 81664 |

IAM

IAM

IAM

| Saleri SIL | |
|-------------------|----------------|
| PA413 | 81576 |
| PA421P | 81573 |
| PA429P | 81554 |
| PA430 | 81574 |
| PA431 | 81584 |
| PA437P | 81549 |
| PA445P | 81822 |
| PA453 | 11701T |
| PA453 | 11701T |
| PA455 | 81492 |
| PA459 | 81536 |
| PA460 | 81522 |
| PA463P | 11707 |
| PA464P | 81573 |
| PA465 | 81504 |
| PA467A | 81801 |
| PA468 | 81521 |
| PA472 | 81443 |
| PA473 | 81594 |
| PA484P | 81498 |
| PA488P | 81538 |
| PA493 | 81506 |
| PA495 | 81559 |
| PA497 | 81608 |
| PA497 | 81666 |
| PA498 | 81602 |
| PA507 | 81436 |
| PA511P | 81556 |
| PA512P | 81606 |
| PA515P | 81611 |
| PA518P | 81619 |
| PA521 | 82080 |
| PA521 | 82080 |
| PA522 | 82001 |
| PA524P | 81605 |
| PA525P | 81458 |
| PA527P | 81681 |
| PA534P | 81476 |
| PA547 | 81463 |
| PA552P | 81464 |
| PA557 | 81574 |
| PA561 | 81509 |
| PA562 | 81616 |
| PA563 | 81754 |
| PA564 | 19532/E |

| Saleri SIL | |
|-------------------|--------------|
| PA570 | 81456 |
| PA573 | 81832 |
| PA576 | 81491 |
| PA584 | 81367 |
| PA589P | 81525 |
| PA590P | 81651 |
| PA591 | 81460 |
| PA592 | 81450 |
| PA594 | 81508 |
| PA599 | 81650 |
| PA607 | 81469 |
| PA610 | 81507 |
| PA611P | 81661 |
| PA616 | 81617 |
| PA619P | 81683 |
| PA620P | 81833 |
| PA631 | 81477 |
| PA633P | 81672 |
| PA636 | 81755 |
| PA639P | 81309 |
| PA641 | 81851 |
| PA645P | 81756 |
| PA645P | 81853 |
| PA646 | 81587 |
| PA648P | 81512 |
| PA649P | 81642 |
| PA653 | 81654 |
| PA655P | 81524 |
| PA656 | 81684 |
| PA657 | 81685 |
| PA658 | 81590 |
| PA659 | 81588 |
| PA660 | 81589 |
| PA663P | 81772 |
| PA664P | 81700 |
| PA667 | 81653 |
| PA669 | 81655 |
| PA670P | 81353 |
| PA674P | 82056 |
| PA674P | 81857 |
| PA675 | 81687 |
| PA681P | 81613 |
| PA682P | 81614 |
| PA683P | 81615 |
| PA684 | 81744 |

| Saleri SIL | |
|-------------------|---------------|
| PA685 | 81736 |
| PA687 | 11708T |
| PA688 | 81490 |
| PA690 | 81489 |
| PA691P | 81525 |
| PA693P | 81300 |
| PA703P | 81324 |
| PA705 | 11706T |
| PA706 | 81315 |
| PA707P | 82005 |
| PA708P | 81550 |
| PA709P | 81551 |
| PA710 | 81322 |
| PA711P | 81811 |
| PA712 | 82004 |
| PA713 | 81667 |
| PA714 | 81597 |
| PA715 | 81499 |
| PA716 | 81722 |
| PA717 | 81742 |
| PA718 | 81724 |
| PA719P | 81333 |
| PA720P | 81513 |
| PA721P | 81854 |
| PA722P | 81852 |
| PA723P | 81314 |
| PA724P | 81656 |
| PA731P | 81303 |
| PA732P | 81339 |
| PA733 | 81304 |
| PA736P | 81657 |
| PA737P | 81708 |
| PA738P | 81709 |
| PA739P | 81329 |
| PA742P | 81330 |
| PA745 | 81325 |
| PA748 | 81723 |
| PA752 | 81759 |
| PA753 | 81757 |
| PA754 | 81758 |
| PA757 | 81707 |
| PA759P | 81843 |
| PA762A | 81842 |
| PA764 | 81365 |
| PA766 | 81488 |

IAM

| Saleri SIL | |
|-------------------|-------|
| PA775 | 81784 |
| PA776 | 81787 |
| PA782 | 81786 |
| PA789 | 81789 |
| PA797 | 81770 |
| PA801 | 81858 |
| PA802 | 81790 |
| PA803 | 81714 |
| PA816 | 81596 |
| PA822 | 81815 |
| PA824 | 81340 |
| PA825 | 81341 |
| PA826 | 81364 |
| PA827 | 81342 |
| PA828 | 81528 |
| PA829 | 81529 |
| PA830 | 81579 |
| PA830 | 82056 |
| PA831 | 81578 |
| PA833 | 81316 |
| PA834 | 81320 |
| PA835 | 81724 |
| PA838 | 81722 |
| PA840 | 81526 |
| PA843 | 81334 |
| PA844 | 81332 |
| PA846 | 81527 |
| PA847 | 81773 |
| PA848 | 81598 |
| PA852 | 81340 |
| PA852 | 81351 |
| PA853 | 81344 |
| PA854 | 81343 |
| PA855 | 81366 |
| PA856 | 81346 |
| PA857 | 81368 |
| PA858 | 81346 |
| PA859 | 81368 |
| PA860 | 81348 |
| PA861 | 81331 |
| PA864 | 81703 |
| PA866 | 81702 |
| PA867 | 81856 |
| PA869 | 81752 |
| PA870 | 81844 |

IAM

| Saleri SIL | |
|-------------------|-------|
| PA871 | 81780 |
| PA873 | 81301 |
| PA874 | 81347 |
| PA875 | 81363 |
| PA877 | 81657 |
| PA878 | 81845 |
| PA879 | 81716 |
| PA880 | 81760 |
| PA881 | 81764 |
| PA883 | 81705 |
| PA884 | 81774 |
| PA885 | 81711 |
| PA886 | 81710 |
| PA887 | 81846 |
| PA890 | 81746 |
| PA890 | 81750 |
| PA890 | 81847 |
| PA891 | 81747 |
| PA894 | 81613 |
| PA908 | 81708 |
| PA913 | 81369 |
| PA913 | 81369 |
| PA914 | 81352 |
| PA919 | 81318 |
| PA920 | 81319 |
| PA921 | 81743 |
| PA923 | 81355 |
| PA928 | 81782 |
| PA931 | 82087 |
| PA932 | 81725 |
| PA934 | 81730 |
| PA935 | 81749 |
| PA936 | 81751 |
| PA937 | 81748 |
| PA938 | 81753 |
| PA939 | 81762 |
| PA941 | 81775 |
| PA944 | 81706 |
| PA945 | 81777 |
| PA946 | 81776 |
| PA948 | 81745 |
| PA949 | 81802 |
| PA950 | 81803 |
| PA951 | 81726 |
| PA952 | 82088 |

IAM

| Saleri SIL | |
|-------------------|-------|
| PA953 | 81728 |
| PA957 | 81781 |
| PA958 | 81715 |
| PA965 | 81793 |
| PA967 | 81729 |
| PA969 | 81761 |
| PA970 | 84039 |
| PA970 | 81806 |
| PA974 | 81770 |
| PA976 | 81769 |
| PA980 | 81779 |
| PA982 | 81807 |
| PA983A | 81370 |
| PA984 | 82054 |
| PA993 | 81731 |

SASIC

| | |
|---------|-------|
| 3606034 | 84000 |
| 3606053 | 84014 |
| 4001198 | 82056 |

ScanTech

| | |
|---------|-------|
| 55.1985 | 82056 |
|---------|-------|

SKF

| | |
|------------|-------|
| VKPA 84623 | 82057 |
| VKPA81400 | 82001 |
| VKPA81401 | 82080 |
| VKPA81401 | 82080 |
| VKPA81401 | 81529 |
| VKPA82202 | 81300 |
| VKPA82210 | 81456 |
| VKPA82220 | 81458 |
| VKPA82230 | 81303 |
| VKPA82240 | 81342 |
| VKPA82246 | 81366 |
| VKPA82426 | 81450 |
| VKPA82428 | 81469 |
| VKPA82429 | 81463 |
| VKPA82429 | 81347 |
| VKPA82431 | 81476 |
| VKPA82435 | 81497 |
| VKPA82441 | 81341 |
| VKPA82441 | 81364 |
| VKPA82618 | 81464 |

IAM



IAM



IAM



| SKF | |
|------------|--------------|
| VKPA82620 | 81309 |
| VKPA82634 | 81489 |
| VKPA82648 | 81324 |
| VKPA82653 | 81304 |
| VKPA82670 | 81320 |
| VKPA82671 | 81319 |
| VKPA86206 | 81811 |
| VKPA86212 | 81854 |
| VKPA86217 | 81852 |
| VKPA87607 | 81843 |
| VKPA91441 | 81768 |
| VKPC 84622 | 81804 |
| VKPC 86811 | 82069 |
| VKPC 88636 | 82034 |
| VKPC 91807 | 82048 |
| VKPC 91848 | 84031 |
| VKPC 91850 | 84028 |
| VKPC 92600 | 82054 |
| VKPC 92926 | 82053 |
| VKPC 93603 | 82045 |
| VKPC 95857 | 82020 |
| VKPC 95872 | 84015 |
| VKPC 96001 | 82050 |
| VKPC81200 | 81520 |
| VKPC81204 | 81524 |
| VKPC81206 | 81525 |
| VKPC81210 | 81527 |
| VKPC81215 | 81775 |
| VKPC81302 | 82013 |
| VKPC81400 | 81521 |
| VKPC81401 | 81522 |
| VKPC81402 | 81526 |
| VKPC81407 | 81777 |
| VKPC81408 | 81702 |
| VKPC81411 | 81776 |
| VKPC81416 | 84052 |
| VKPC81417 | 84010 |
| VKPC81417 | 81791 |
| VKPC81419 | 81840 |
| VKPC81602 | 81593 |
| VKPC81606 | 81683 |
| VKPC81609 | 81832 |
| VKPC81610 | 81833 |
| VKPC81611 | 81773 |
| VKPC81612 | 81700 |

| SKF | |
|------------|---------------|
| VKPC81615 | 81528 |
| VKPC81620 | 81703 |
| VKPC81623 | 81706 |
| VKPC81624 | 81774 |
| VKPC81625 | 81705 |
| VKPC81626 | 81816 |
| VKPC81626 | 84011 |
| VKPC81802 | 81842 |
| VKPC81803 | 81772 |
| VKPC82201 | 11706T |
| VKPC82202 | 81415 |
| VKPC82206 | 81481 |
| VKPC82208 | 81434 |
| VKPC82214 | 81801 |
| VKPC82230 | 81339 |
| VKPC82240 | 81372 |
| VKPC82245 | 81333 |
| VKPC82246 | 81343 |
| VKPC82247 | 81351 |
| VKPC82249 | 81369 |
| VKPC82249 | 81369 |
| VKPC82250 | 81370 |
| VKPC82419 | 81498 |
| VKPC82424 | 81436 |
| VKPC82429 | 81363 |
| VKPC82431 | 81314 |
| VKPC82432 | 81477 |
| VKPC82436 | 11708T |
| VKPC82437 | 81340 |
| VKPC82451 | 81348 |
| VKPC82600 | 81492 |
| VKPC82614 | 81443 |
| VKPC82618 | 81326 |
| VKPC82621 | 11701T |
| VKPC82621 | 11701T |
| VKPC82622 | 81460 |
| VKPC82629 | 81490 |
| VKPC82631 | 81491 |
| VKPC82633 | 11707 |
| VKPC82637 | 81302 |
| VKPC82638 | 81325 |
| VKPC82643 | 81488 |
| VKPC82645 | 81331 |
| VKPC82646 | 81329 |
| VKPC82647 | 81315 |

| SKF | |
|------------|----------------|
| VKPC82650 | 81334 |
| VKPC82651 | 81332 |
| VKPC82652 | 81316 |
| VKPC82653 | 81365 |
| VKPC82660 | 81322 |
| VKPC82665 | 81352 |
| VKPC82665 | 81330 |
| VKPC82800 | 19532/E |
| VKPC83200 | 81572 |
| VKPC83205 | 81556 |
| VKPC83206 | 81560 |
| VKPC83401 | 81554 |
| VKPC83420 | 81642 |
| VKPC83424 | 81672 |
| VKPC83425 | 81353 |
| VKPC83428 | 81513 |
| VKPC83430 | 81753 |
| VKPC83615 | 81512 |
| VKPC83617 | 81822 |
| VKPC83630 | 81367 |
| VKPC83635 | 81710 |
| VKPC83636 | 81711 |
| VKPC83637 | 81844 |
| VKPC83639 | 81713 |
| VKPC83810 | 81752 |
| VKPC83811 | 81712 |
| VKPC84205 | 81531 |
| VKPC84208 | 81538 |
| VKPC84209 | 81650 |
| VKPC84210 | 81653 |
| VKPC84215 | 81598 |
| VKPC84216 | 81716 |
| VKPC84403 | 81536 |
| VKPC84404 | 81651 |
| VKPC84406 | 81655 |
| VKPC84407 | 82004 |
| VKPC84408 | 81656 |
| VKPC84409 | 81657 |
| VKPC84411 | 81654 |
| VKPC84415 | 81803 |
| VKPC84416 | 81802 |
| VKPC84600 | 81532 |
| VKPC84601 | 81602 |
| VKPC84618 | 81559 |
| VKPC85201 | 81544 |

| IAM | MAGNETI MARELLI |
|-----|-----------------|
|-----|-----------------|

| SKF | |
|-----------|-------|
| VKPC85202 | 81543 |
| VKPC85206 | 81549 |
| VKPC85211 | 82005 |
| VKPC85220 | 81749 |
| VKPC85401 | 81681 |
| VKPC85403 | 81684 |
| VKPC85404 | 81685 |
| VKPC85404 | 81687 |
| VKPC85407 | 81606 |
| VKPC85408 | 81605 |
| VKPC85607 | 81551 |
| VKPC85611 | 81550 |
| VKPC85613 | 81846 |
| VKPC85620 | 81746 |
| VKPC85621 | 81748 |
| VKPC85622 | 81750 |
| VKPC85623 | 81747 |
| VKPC85624 | 81751 |
| VKPC86205 | 81660 |
| VKPC86206 | 81573 |
| VKPC86206 | 81596 |
| VKPC86209 | 81756 |
| VKPC86209 | 81853 |
| VKPC86215 | 81762 |
| VKPC86216 | 81578 |
| VKPC86405 | 81828 |
| VKPC86408 | 81754 |
| VKPC86409 | 81661 |
| VKPC86413 | 81574 |
| VKPC86415 | 81579 |
| VKPC86416 | 84039 |
| VKPC86416 | 81806 |
| VKPC86418 | 84007 |
| VKPC86601 | 81664 |
| VKPC86601 | 81851 |
| VKPC86602 | 81576 |
| VKPC86603 | 81608 |
| VKPC86603 | 81666 |
| VKPC86604 | 81755 |
| VKPC86606 | 81759 |
| VKPC86609 | 81594 |
| VKPC86610 | 81592 |
| VKPC86615 | 81757 |
| VKPC86616 | 81758 |
| VKPC86618 | 82056 |

| IAM | MAGNETI MARELLI |
|-----|-----------------|
|-----|-----------------|

| SKF | |
|-----------|-------|
| VKPC86618 | 81857 |
| VKPC86618 | 82056 |
| VKPC86619 | 81701 |
| VKPC86621 | 81667 |
| VKPC86631 | 81760 |
| VKPC86633 | 81761 |
| VKPC87200 | 81419 |
| VKPC87201 | 81419 |
| VKPC87400 | 81614 |
| VKPC87401 | 81615 |
| VKPC87404 | 81613 |
| VKPC87813 | 81707 |
| VKPC87814 | 81709 |
| VKPC88200 | 81999 |
| VKPC88203 | 81619 |
| VKPC88206 | 82087 |
| VKPC88605 | 81586 |
| VKPC88607 | 81616 |
| VKPC88608 | 81504 |
| VKPC88610 | 81584 |
| VKPC88611 | 81587 |
| VKPC88612 | 81617 |
| VKPC88615 | 81590 |
| VKPC88616 | 81589 |
| VKPC88617 | 81588 |
| VKPC88619 | 81509 |
| VKPC88620 | 81506 |
| VKPC88622 | 81499 |
| VKPC88625 | 81723 |
| VKPC88631 | 81725 |
| VKPC88802 | 81618 |
| VKPC88808 | 81508 |
| VKPC88810 | 81507 |
| VKPC88824 | 81722 |
| VKPC88826 | 81597 |
| VKPC88828 | 81724 |
| VKPC88842 | 81726 |
| VKPC88843 | 82088 |
| VKPC88844 | 81728 |
| VKPC88845 | 81729 |
| VKPC88846 | 81730 |
| VKPC88848 | 84012 |
| VKPC90200 | 81780 |
| VKPC90202 | 81781 |
| VKPC90402 | 81782 |

| IAM | MAGNETI MARELLI |
|-----|-----------------|
|-----|-----------------|

| SKF | |
|-----------|-------|
| VKPC91416 | 81815 |
| VKPC91441 | 81769 |
| VKPC91814 | 82022 |
| VKPC92208 | 81742 |
| VKPC92209 | 81743 |
| VKPC92408 | 81744 |
| VKPC92412 | 81736 |
| VKPC93205 | 81611 |
| VKPC93210 | 81838 |
| VKPC93415 | 81839 |
| VKPC93601 | 81708 |
| VKPC95424 | 81786 |
| VKPC95426 | 81731 |
| VKPC96210 | 81858 |
| VKPC96212 | 81789 |
| VKPC96402 | 81790 |
| VKPC97200 | 81714 |
| VKPC97201 | 81715 |

| SWAG | |
|-------------|-------|
| 10150037 | 82030 |
| 10 92 63 93 | 82052 |
| 50 92 22 51 | 81804 |
| 55 15 0003 | 82056 |
| 90 92 6279 | 82021 |

| TRISCAN | |
|------------|-------|
| 860013034 | 82022 |
| 860018003 | 82038 |
| 860023044 | 82030 |
| 860040012 | 82045 |
| 8600 10030 | 84014 |
| 8600 13013 | 82048 |
| 8600 13018 | 84032 |
| 8600 13034 | 82044 |
| 8600 14010 | 82053 |
| 8600 14950 | 82054 |
| 8600 40115 | 82039 |
| 8600 69005 | 82050 |
| 8600-13028 | 82051 |

| VAICO | |
|-----------|-------|
| V10-50062 | 82025 |
| V20-50039 | 84000 |
| V25-50013 | 81804 |

| IAM | MAGNETI MARELLI |
|--------------|-----------------|
| VALEO | |
| 506325 | 82056 |
| 506357 | 82054 |
| 506534 | 82053 |
| 506618 | 82051 |
| 506694 | 81804 |
| 506708 | 82048 |
| 506711 | 82034 |

| IAM | MAGNETI MARELLI |
|--------------|-----------------|
| VALEO | |
| 506726 | 82033 |
| 506789 | 82057 |
| 506809 | 82018 |
| 506811 | 82039 |
| 506812 | 82045 |
| 506816 | 82020 |
| 506819 | 82021 |

| IAM | MAGNETI MARELLI |
|--------------|-----------------|
| VALEO | |
| 506833 | 82030 |
| 506849 | 82044 |
| 506851 | 82022 |
| 506852 | 82063 |
| 506852 | 82063 |
| 506863 | 84007 |