



Equipment Catalog 2017

LIFE.

**BETTER
BUILT.**





TRAILBLAZERS OF THE MODERN TRUCK TOOL BOX



BETTER BUILT FROM THE GROUND UP

For over two decades, we have taken pride in our products and dedication to quality. Innovation, quality products, customer service and a philosophy of responding to our customers' needs are among the many reasons Better Built has become the leader in the truck accessory aftermarket industry.

Simply put, Better Built means a higher standard in everything we do.

That's why we would like to personally invite you to become part of the Better Built Family. When you do, you will experience what truly makes our products and company the best in the industry. Give us a call today or place an order online and you'll know why "The name says it all!"

H.C. Daws, President and CEO
Daws Manufacturing Company, Inc.

CONTENTS

HELP & INFO

Crossover Fitment Guide 6

MISCELLANEOUS

Accessories 68

Better Built Gear 69

CROWN SERIES

8

Low Profile Crossover 10

Standard Cuff Crossover 12

Slimline Box 14

Two-Lid Box 16

Quantum® ATB Box 18

Chest Box 19

Top Mount Box 20

Side Mount Box 21

Underbody Box 22

Recreational 23

Quantum® Rack 26

Storage Racks 28

Site Safes 29

SEC SERIES

30

Low Profile Crossover 32

Standard Cuff Crossover 34

X2 End Opening Box 36

Slimline Box 37

Two-Lid Box 38

Chest Box 40

Side Mount Box 41

Fishing Box 42

SLE SERIES

44

Low Profile Box 46

Side Mount Box 49

HD SERIES

50

Crossover Box 52

Chest Box 54

Top Mount Box 56

Side Mount Box 58

Underbody Box 60

Site Safes 62

Headache Racks 64

Drawer Boxes 65

Transfer Tanks 66



BETTER BUILT



CROSSOVER BOX FITMENT GUIDE

FULLSIZE TRUCKS	CHEVROLET	DODGE	FORD	GMC	ISUZU	MAZDA	NISSAN	TOYOTA
71-72"		Ram 1500 Ram 2500 Ram 3500	F-250 F-350					
69-70"	Silverado 1500 Silverado 2500 Silverado 3500		F-150	Sierra 1500 Sierra 2500 Sierra 3500			Titan	Tundra '04 to current
MIDSIZE TRUCKS	CHEVROLET	DODGE	FORD	GMC	ISUZU	MAZDA	NISSAN	TOYOTA
67"								T-100 Long Bed Tundra '00-'03
63"	Colorado '12 and earlier	Dakota Dakota Quad		Canyon '12 and earlier			Frontier '05 to current	Tacoma '05 to current
COMPACT TRUCKS	CHEVROLET	DODGE	FORD	GMC	ISUZU	MAZDA	NISSAN	TOYOTA
60-61½"	S-10 Colorado '15		Ranger Sport Trac '01 to current	S-15 Sonoma Canyon '15	Std. Cab Space Cab	Short Bed Long Bed	Frontier '04 and earlier	Tacoma '04 and earlier

For **SPECIALTY AND CREW CABS**, please verify the dimensions of your truck before selecting a product from our catalog.

If in doubt, please contact our customer service department for assistance in finding the right size box for your truck.

BOX TYPE VISUAL GUIDE

STANDARD BOX TYPES

SINGLE LID

Single, one-piece lid with piano hinge that runs the length of the box.

STANDARD CUFF

Full-size 5" cuff affords more small parts partition storage space.

STANDARD TUB

Standard tubs leave a moderate amount of space in the truck bed below the box.

TWO-LID

"Gullwing" style double doors allow access to the box from either side.

LOW PROFILE

2" cuff height enables greater visibility from the rear cab window.

DEEP TUB

Deep tub stretches further down into the truck bed, equating to more box space.

UNIVERSAL BOX TYPES

SLIMLINE

STANDARD

WIDE

STAIR CUT

WEDGE

CORNER CUT

CROWN
SERIES



CROWN SERIES

Engineered for functionality and security, Better Built's Crown Series is the world's Quintessential Truck Tool Box.

ABOUT THE CROWN SERIES

Better Built Crown Series tool boxes are engineered to take the everyday abuse of the most avid outdoor enthusiast.



“QUICK AND EASY INSTALL”

“Dimensions were right on, and it fit perfectly. The sliding tray is very handy.”

*– David
Cloverdale, IN*

Refer to Our Fitment Guide for More Information (Page 6).

THE ORIGINAL ALUMINUM TRUCK TOOL BOX

LOW PROFILE. HIGH VISIBILITY.

Lower profile design allows for greater visibility through the rear window of your truck.

▼ Integral Ends & Single-Piece Body Construction

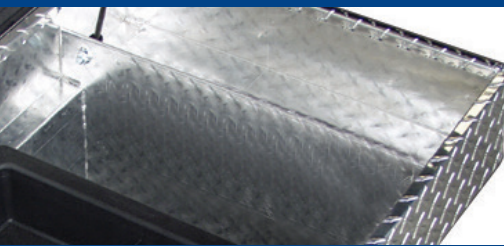

▼ Locking Stainless Steel Paddle Handles



BRITE UNCOATED



GLOSS BLACK

CROWN LOW PROFILE CROSSOVER BOX

DESCRIPTION

ALUMINUM PART #

- 71" Low Profile
- 69" Low Profile
- 69" Universal Wedge
- 67" Low Profile
- 63" Low Profile
- 63" Universal Wedge
- 61½" Universal Corner Cut
- 61½" Universal Wedge
- 56½" Low Profile

BRITE	GLOSS BLACK
73010910	
73010911	73210095
73012123	73212124
73010913	
73010914	
73012112	73212113
73010912	73210096
73010798	73210799
73010915	

DIMENSIONS

A	B	C	D	E	F
71"	63¼"	11"	13"	20"	16½"
69"	60"	11"	13"	20"	16½"
69"	44"	11"	13"	20"	16½"
67"	56½"	11"	13"	20"	16½"
63"	54"	11"	13"	20"	16½"
63"	38"	11"	13"	20"	16½"
61½"	51"	11"	13"	20"	16½"
61½"	36"	11"	13"	20"	16½"
56½"	46"	11"	13"	20"	16½"

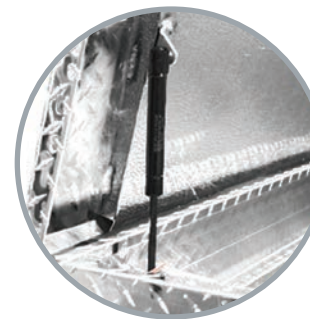

AUTO-LIFT SHOCKS

The “auto-lift” self-rising shock allows easy single handed entry with a lid that opens nearly 90°.



SELF ADJUSTING STRIKERS

A Better Built patented design, our strikers require no manual readjustment with repeated use. Each striker is guided to its latch every time.

CROWN STANDARD LOW PROFILE

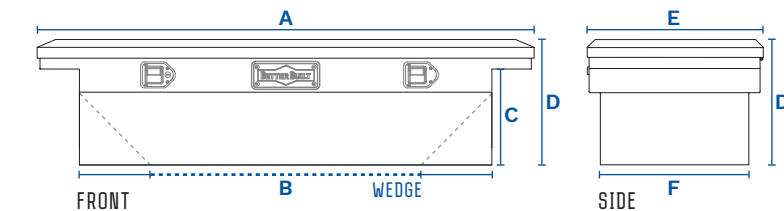

2" Cuff Height

FOR

QUALITY DEMANDING,
VALUE-CONSCIOUS
EQUIPMENT HOARDERS



**SIX-PACKS
FOR YOUR
CAMPING
TRIP**

CROWN STANDARD CUFF CROSSOVER

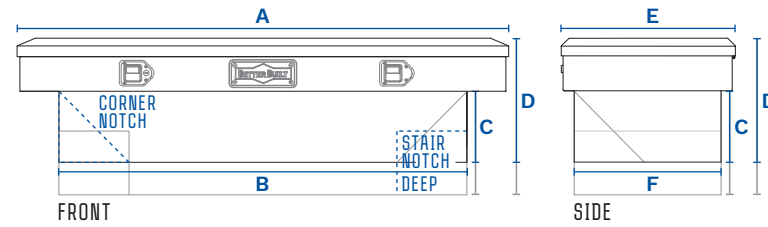

Refer to Our
Fitment Guide for
More Information
(Page 6).

CROWN STANDARD CUFF CROSSOVER BOX

STANDARD	ALUMINUM PART #		STEEL PART #		DIMENSIONS					
	BRITE	GLOSS BLACK	WHITE	BLACK	A	B	C	D	E	F
71" Crossover	73010965	73210939			71"	60½"	8½"	13"	20"	16½"
69" Crossover	73010899	73210938	73210169	73210128	69"	58"	8½"	13"	20"	16½"
67" Crossover	73012069				67"	56"	8½"	13"	20"	16½"
67" Universal Corner Cut	73012072				67"	56"	8½"	13"	20"	16½"
63" Crossover	73010884		73210170	73210129	63"	51"	8½"	13"	20"	16½"
63" Universal Corner Cut	73012110	73212111			63"	52"	7½"	13"	20"	16½"
61½" Crossover	73010869	73210943			61½"	50½"	8½"	13"	20"	16½"
61½" Universal Corner Cut	73010854				61½"	51"	8½"	13"	20"	16½"
56½" Crossover	73010839				56½"	45½"	8½"	13"	20"	16½"
51" Crossover	73010824				51"	40"	8½"	13"	20"	16½"

DEEP	ALUMINUM PART #		STEEL PART #		DIMENSIONS					
	BRITE	GLOSS BLACK	WHITE	BLACK	A	B	C	D	E	F
71" Crossover	73010966				71"	60½"	14"	19"	20"	16½"
69" Crossover	73010951	73210094			69"	56½"	14"	19"	20"	16½"
67" Crossover	73012082				67"	56"	14"	19"	20"	16½"
63" Crossover	73010885				63"	51"	14"	19"	20"	16½"
63" Universal Stair Cut	73012238				63"	52"	14"	19"	20"	16½"
61½" Crossover	73010870				61½"	50½"	14"	19"	20"	16½"
61½" Universal Stair Cut	73010855				61½"	39"	14"	19"	20"	16½"
56½" Crossover	73010840				56½"	45½"	14"	19"	20"	16½"
51" Crossover	73010825				51"	40"	14"	19"	20"	16½"



UNIVERSAL ALUMINUM CROSSOVER



DEEP UNIVERSAL ALUMINUM CROSSOVER



WHITE STEEL CROSSOVER



BLACK STEEL CROSSOVER



THIS IS A GREAT BOX.

"I had a pickup truck tool box from one of the big box stores. It never closed on both sides at the same time. The lock was finicky and took several minutes to unlock or lock.

"Then my sons bought me a Better Built box for my birthday. It's like going from a '63 Volkswagen to a Cadillac. It closes perfect on both sides; the locks work as intended. A great feature is that you can unlock and open the box from either side, but after closing, the opposite side lock stays in the locked position so that you don't have to go around to lock the other side. This is a great box."

- Pete
Austin, TX



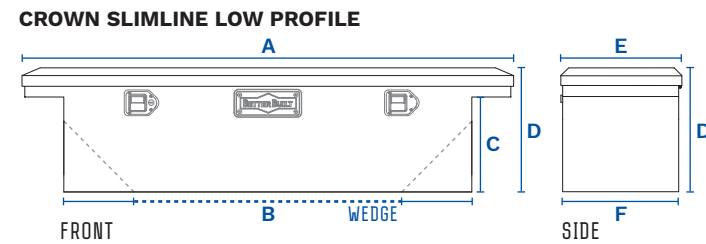

CROWN SLIMLINE LOW PROFILE BOX

DESCRIPTION	ALUMINUM PART #		DIMENSIONS					
	BRITE	GLOSS BLACK	A	B	C	D	E	F
69" Slimline Low Profile	73010284	73210283	69"	60"	10"	13"	12½"	12"
61½" Slimline Low Profile Wedge	73010286	73210285	61½"	36"	10"	12"	12½"	12"



Refer to Our Fitment Guide for More Information (Page 6).



BLACK SLIMLINE LOW PROFILE WEDGE



SLIM DESIGN
The narrow design allows for more room in the bed of your truck, taking up only 12 inches of space.



LOW PROFILE
A cleaner, Low Profile design provides greater visibility from the cab of your truck.

FOR THE SHORT BED TRUCK THAT GOES PLACES **&** A FIRE EXTINGUISHER

“INSTALLED IT BY MYSELF.”

“I installed it by myself in under 10 minutes with the proper clamps. I was amazed at how slim it looked but also how much room was inside.”
- Jason

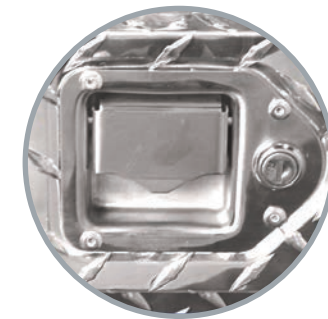
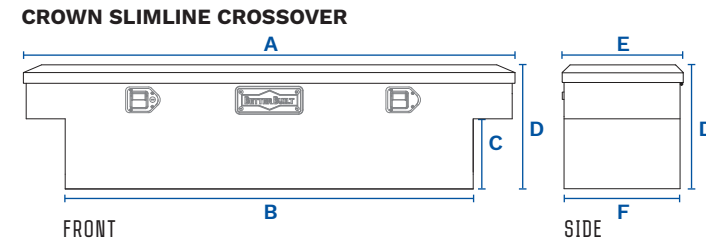

LOCKING PADDLE HANDLE
An improved take on our classic design enhances ease of use and longevity.

CROWN SLIMLINE CROSSOVER BOX

DESCRIPTION	ALUMINUM PART #		DIMENSIONS					
	BRITE	GLOSS BLACK	A	B	C	D	E	F
69" Slimline Crossover, Dual Shock	73010280	73210279	69"	58"	10"	16"	12½"	12"
69" Slimline Crossover, Single Shock	73010813		69"	58"	10"	16"	12½"	12"
63" Slimline Crossover, Single Shock	73010282	73210281	63"	52"	10½"	16"	12½"	12"
61½" Slimline Crossover, Single Shock	73010812	73212410	61½"	50"	10½"	16"	12½"	12"



69" BLACK SLIMLINE CROSSOVER





CROWN TWO-LID CROSSOVER

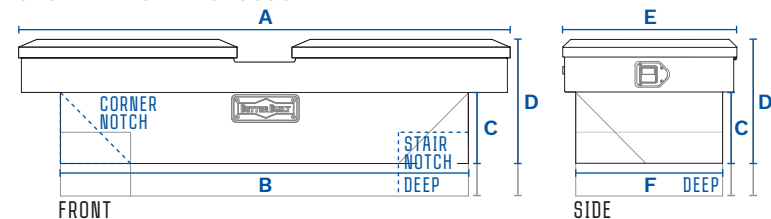

Refer to Our Fitment Guide for More Information (Page 6).



CROWN TWO-LID CROSSOVER BOX

STANDARD

STANDARD	ALUMINUM PART #
71" Crossover	74010957
69" Crossover	74010891
67" Crossover	74012084
67" Universal Corner Cut	74012073
63" Crossover	74010876
63" Universal Corner Cut	74012109
61½" Crossover	74010861
61½" Universal Corner Cut	74010846
56½" Crossover	74010831
51" Crossover	74010816

DIMENSIONS

A	B	C	D	E	F
71"	60½"	8"	13"	20"	16½"
69"	58"	8"	13"	20"	16½"
67"	56"	8"	13"	20"	16½"
67"	42"	8"	13"	20"	16½"
63"	52"	8"	13"	20"	16½"
63"	42"	8"	13"	20"	16½"
61½"	49"	8"	13"	20"	16½"
61½"	51"	8"	13"	20"	16½"
56½"	45½"	8"	13"	20"	16½"
51"	40"	8"	13"	20"	16½"

DEEP

DEEP	ALUMINUM PART #
71" Crossover	74010958
69" Crossover	74010892
67" Crossover	74012085
63" Crossover	74010877
63" Universal Stair Cut	74012233
61½" Crossover	74010862
61½" Universal Stair Cut	74010847
56½" Crossover	74010832

DIMENSIONS

A	B	C	D	E	F
71"	60½"	14"	19"	20"	16½"
69"	58"	14"	19"	20"	16½"
67"	56"	14"	19"	20"	16½"
63"	52"	14"	19"	20"	16½"
63"	41"	14"	19"	20"	16½"
61½"	51"	14"	19"	20"	16½"
61½"	38"	14"	19"	20"	16½"
56½"	45½"	14"	19"	20"	16½"



STANDARD TWO-LID



UNIVERSAL TWO-LID

FOR SMALLER ITEM STORAGE WITH EASY OUT-OF-BED ACCESS & A FEW BAGS OF ICE IN A PINCH



DEEP TWO-LID



DEEP UNIVERSAL TWO-LID

“THE OTHER BOX DIDN'T COME CLOSE.”

“Fit perfect on my 2013 GMC Sierra SLE. Very durable and easy to install. Would definitely buy another one and recommend it to my friends. My wife had ordered a different one online but the quality didn't come close.”

- Alex Greenly, CO



“GOOD LOOKING BOX.”

“Great fit, looks better than a regular box, and easy installation.”

- Roger
Kings Mountain, NC

Refer to Our Fitment Guide for More Information (Page 6).



WIDE CHEST BOX

STORAGE AT HOME OR IN YOUR TRUCK.

Versatile use makes transfer of items a breeze.



OFFSET LID

The offset hinge allows your lid to open nearly 90 degrees, even while sitting flush against your truck cab.

CROWN QUANTUM® ATB BOX

DESCRIPTION	ALUMINUM PART #		DIMENSIONS					
	BRITE	GLOSS BLACK	A	B	C	D	E	F
71" Crossover	70011172	70211151	71"	63"	11"	13"	23"	17"
69" Universal Stair Cut	70011304		69"	47"	11"	13"	23"	17"
69" Crossover	70011167	70214046	69"	61"	11"	13"	23"	17"
67" Crossover	70011306		67"	59"	11"	13"	23"	17"
63" Crossover	70011307	70211152	63"	55"	11"	13"	23"	17"
61½" Crossover	70011168		61½"	52"	11"	13"	23"	17"
61½" Universal Stair Cut	70011318		61½"	38"	11"	13"	23"	17"
56½" Crossover	70011308		56½"	46"	11"	13"	23"	17"

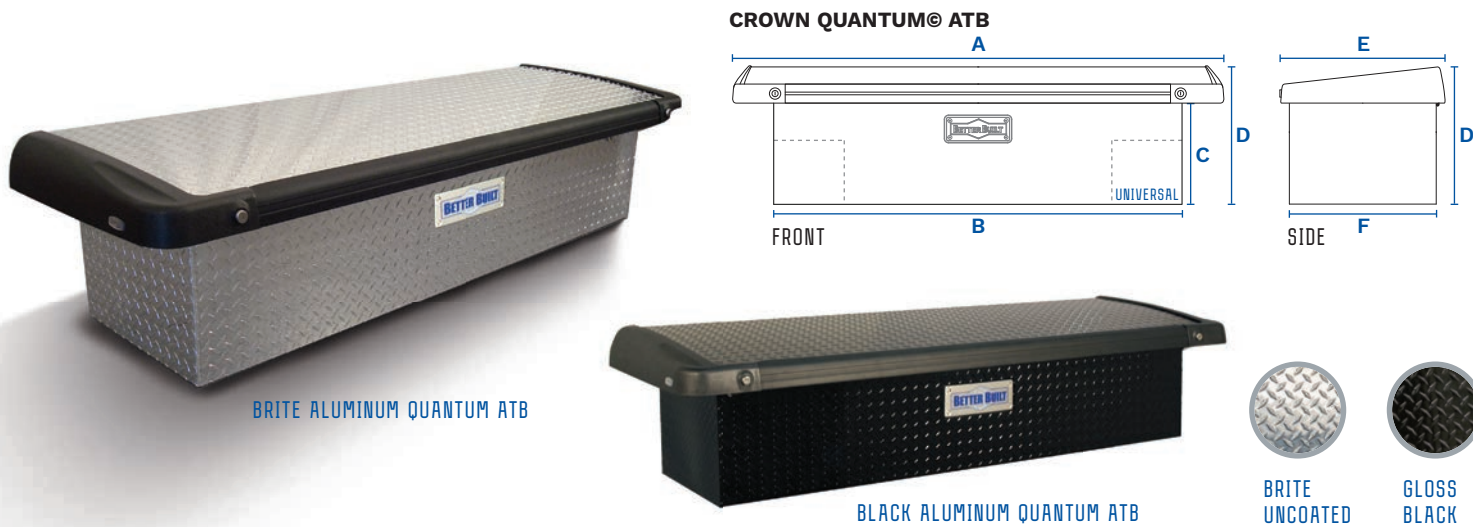

BRITE ALUMINUM QUANTUM ATB

BLACK ALUMINUM QUANTUM ATB



BRITE UNCOATED

GLOSS BLACK

CROWN CHEST BOX

STANDARD	ALUMINUM PART #		DIMENSIONS			
	BRITE	GLOSS BLACK	A	B	C	D
60" Chest Box	62012331	62210937	60"	20"	15¾"	18"
56" Chest Box	62060192	62210098	56"	20"	15¾"	18"
48" Chest Box	62012330	62210278	48"	20"	15¾"	18"
36" Chest Box	62012329	62210277	36"	20"	15¾"	18"

WIDE	ALUMINUM PART #		DIMENSIONS			
	BRITE	GLOSS BLACK	A	B	C	D
60" Chest Box	62011323		60"	24"	24"	18"
56" Chest Box	62011330		56"	24"	24"	18"
48" Chest Box	62011324		48"	24"	24"	18"
36" Chest Box	62011325		36"	24"	24"	18"

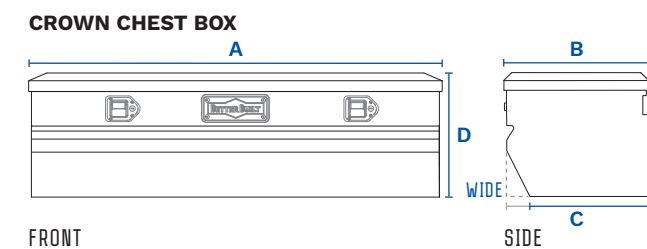

FRONT

SIDE



60" CHEST BOX



BRITE UNCOATED

GLOSS BLACK

ADAPTABLE

Use it in your truck or for household storage to make it convenient to transfer items.





72" BLACK STEEL

CROWN TOP MOUNT BOX

DESCRIPTION	ALUMINUM PART #	STEEL PART #		DIMENSIONS			
		BRITE	WHITE	BLACK	L	W	H
96" Top Mount, Double Door	64010147		64210152	64210123	96"	12"	16"
90" Top Mount, Double Door	64010146				90"	12"	16"
72" Top Mount, Double Door	64010145		64210151	64210122	72"	12"	16"
60" Top Mount, Single Door	64010144		64210150	64210121	60"	12"	16"
48" Top Mount, Single Door	64010143		64210149	64210120	48"	12"	16"

CROWN SINGLE DOOR TOP MOUNT

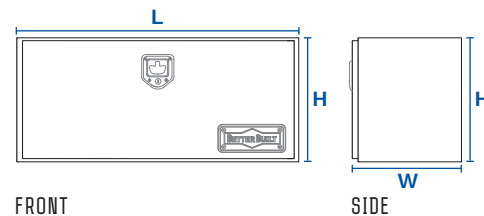

CROWN DOUBLE DOOR TOP MOUNT

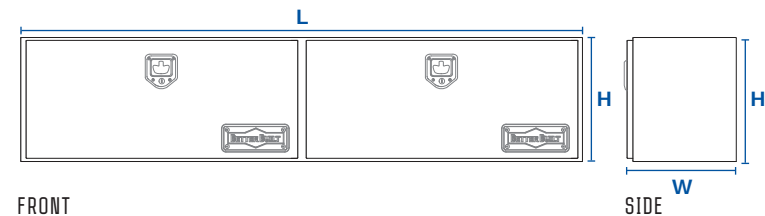

"These boxes have very good welding, the doors are sturdy with full-length hinges, and the locks work well."
 - AlwaysLearning
 Greenville, NC



SPACE SAVING
 The Top Mount sits on top of the truckbed rails, saving valuable storage space inside the truck bed.



T-HANDLE LATCH
 The locking T-handle latches are easy to use and provide superior security.

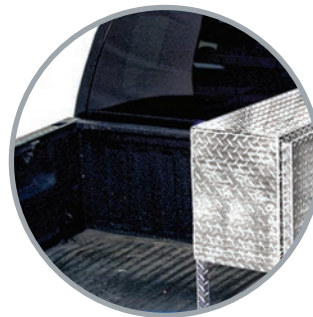

EASY INSTALL
 Top Mount boxes are easy to install to the bed rail of any truck. Legs are included for greater stability.



CROWN SIDE MOUNT BOX

DESCRIPTION	ALUMINUM PART #		DIMENSIONS				
	BRITE	GLOSS BLACK	A	B	C	D	E
72" Side Mount	63012335		72"	11½"	6"	11"	8"
60" Side Mount	63060190		60"	11½"	6"	11"	8"
48" Side Mount	63012334	63210944	48"	11½"	6"	11"	8"



NARROW DESIGN
 The Side Mount sits on the truck side rails, leaving plenty of room for additional storage space in the truck bed. Legs are included for greater stability.



48" SIDE MOUNT BLACK



CROWN SIDE MOUNT

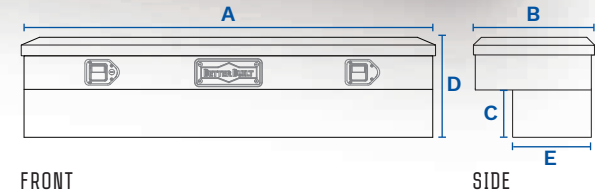

FOR EASY OUT-OF-BED ACCESS AND FULL BED USAGE **&** A BIT OF EQUESTRIAN GEAR

CROWN DOUBLE LATCH UNDERBODY

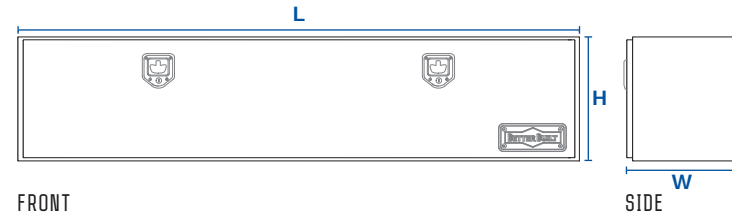

CROWN UNDERBODY BOX



DESCRIPTION	ALUMINUM PART #	STEEL PART #		DIMENSIONS		
		WHITE STEEL	BLACK STEEL	L	W	H
24" - 18" Underbody, Single Latch	65010156	65210165	65210124	24"	17"	18"
NEW 30" - 18" Underbody, Single Latch	65010131		65210130	30"	17"	18"
36" - 18" Underbody, Single Latch	65010157	65210166	65210125	36"	17"	18"
48" - 18" Underbody, Double Latch	65010158	65210167	65210126	48"	17"	18"
60" - 18" Underbody, Double Latch	65010159	65210168	65210127	60"	17"	18"
72" - 18" Underbody, Double Latch	65010160			72"	17"	18"
36" - 24" Underbody, Single Latch	65010161			36"	24"	23"
48" - 24" Underbody, Double Latch	65010162			48"	24"	23"
60" - 24" Underbody, Double Latch	65010163			60"	24"	23"
72" - 24" Underbody, Double Latch	65010164			72"	24"	23"

29221128
UNDERBODY
INSTALLATION KIT



60" BLACK STEEL



FULL PIANO HINGE
Full piano hinge provides durability and security for the life of the box.



LOCKING LATCH
The zinc-coated T-handle latches provide solid maximum security while using a minimum of space.



VERY STRONG

"Once mounted, it's very strong and looks great."

- Milton

CROWN RECREATIONAL BOXES

DESCRIPTION	ALUMINUM PART #		STEEL PART #	DIMENSIONS		
	BRITE	MATTE BLACK		L	W	H
48" Wheel Well Box	68012344			48"	8"	18"
48" Wheel Well Box with Drawers	68012346			48"	8"	18"
60" Wheel Well Box	68012345			60"	8"	18"
20" Tote Box	67011336			20"	12"	7¾"
30" Tote Box	67011337			30"	12"	12"
20" ATV Box	67011386	67210276		20"	12"	10½"
30" ATV Box	67011387	67210275		30"	12"	11"
Tool Tower Box	68010172			18"	8"	18"
Tool Tower Box with 3 Drawers	29217137		29217125	18"	7½"	15½"
Tool Tower Box with 5 Drawers	29217138		29217136	18"	7½"	15½"



TOTE BOX

The Better Built Tote Box is a truck-box-on-the-go. Made from the same high-quality materials and built to the same standards as our dependable truck boxes.

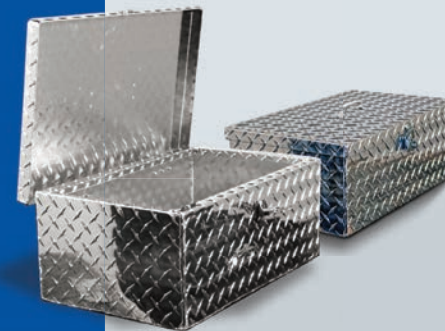

TOOL TOWER BOX

The lightweight Tool Tower Box takes up only 18 inches of space, leaving plenty of room in the truck bed for transporting your tools with ease and mobility.



WHEEL WELL BOX

Our Wheel Well Boxes feature a universal design to accommodate a variety of truck styles. Unit can be mounted on passenger or driver side. Two styles available.

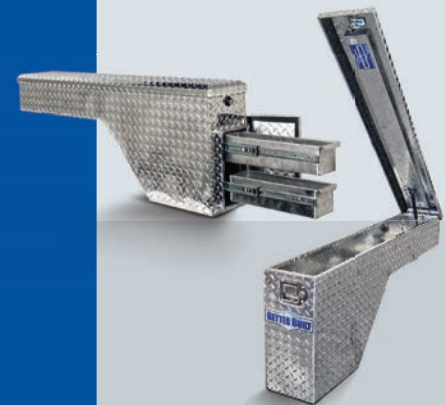

ATV BOX

Perfect for your ATV or your truck, SUV or garage, the Better Built ATV Box gives you space where you need it.



CROWN RECREATIONAL BOXES

DESCRIPTION	ALUMINUM PART #		STEEL PART #	DIMENSIONS		
	BRITE	GLOSS BLACK	GLOSS BLACK	L	W	H
Wheel Well Truck Gun Box	63010274			64½"	10"	18"
36" Single Door Dog Box	29010139			36"	48"	24"
48" Double Door Dog Box	29010140			48"	48"	24"
60" Double Door Dog Box	29010141			60"	48"	24"
69" Double Door Dog Box	29010142			69"	48"	24"
Multi Chute Game Feeder*	29211703			52¾"	63¾"	58¼"
Short Trailer Tongue Box	66012336	66212322		34"-16"	19"	18"
Tall Trailer Tongue Box	66012214	66212323	66212324	34"-21"	14"	22"
Wide Trailer Tongue Box	66010148	66212321		39"-21"	16½"	12"



CROWN RECREATIONAL BOXES

DESCRIPTION	ALUMINUM PART #	DIMENSIONS		
	BRITE	L	W	H
56" Slant Lid	62010215	56"	19"	19"
56" Slant Lid, Wide	62011310	56"	28"	19"
59" V-Top, 2 Lids	62011171	59"	22"	17"



CROWN SUV DRAWER BOXES

DESCRIPTION	ALUMINUM PART #	DIMENSIONS		
	SILVER	L	W	H
SUV Drawer Box Short	76217119	26"	37"	10½"
SUV Drawer Box Long	76217118	55"	23"	10½"



WHEEL WELL GUN BOX

Transport your hunting rifles in style with our sleek, durable Wheel Well Gun Box. Made to the same standards as our truck boxes and notched to fit over almost any wheel well, the 5" thick dual-slotted foam interior safely accommodates two full-size rifles.



DOG BOX

Available in both single and two-door configurations, the Better Built Dog Box is made from the same dependable lightweight diamond plate aluminum as our trend-setting truck boxes. Vented side panels allow for greater air flow throughout the box. The open-bottom design allows for easy truck bed cleaning.

SLANT LID RV BOX

On the go? Take it with you in one of our Slant Lid RV Boxes. Like our durable truck chests, the Slant Lid RV Box fits securely in the back of your RV, truck, camper or fifth wheel.



SUV DRAWER BOXES

Ideal for keeping your gear out of sight and safely secured in your SUV. Made of rugged aluminum with a corrosion-resistant powder coated finish, it will provide years of reliable security. Available for both midsize and fullsize SUVs.

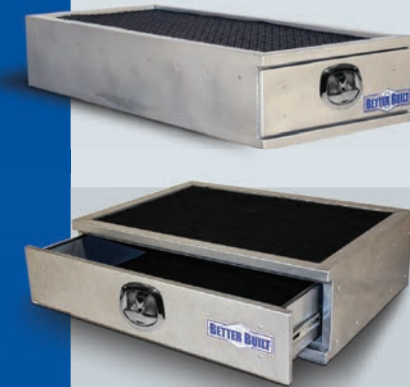

MULTI CHUTE GAME FEEDER

The Better Built Multi Chute Game Feeder features eight feeder chutes (four per side), a locking, weather resistant lid, and durable, powder coated aluminum construction, with a feed holding capacity of 600 lbs and an empty weight of just 135 lbs.

*4x4 WOOD NOT INCLUDED



TRAILER TONGUE BOX

A box "trailer-made" for your horse or utility trailer. Great for storing tie downs, wheel chocks and other various towing items. Includes auto-lift shocks for ease of opening. Fits perfectly on most trailers.

V-TOP RV BOX

Our V-Top boxes give you twice the convenience in a single, easy to install box. The deep center V-channel provides clear access for hooking up gooseneck trailers. Box contents are easily accessible, no matter which side you're on.



AWESOME!

"I must say, great product. Very easy to install in any SUV. All my tools are now locked in the drawer securely in the trunk."

- Sean Michael Walsh

QUANTUM® ACCESSORIES

Expand and enhance your Quantum Rack storage system with optional accessories, including our Cargo Lock, Box Mount, Cleat Tie-Down Kits and Headache Rack Insert.

CARGO LOCK KIT

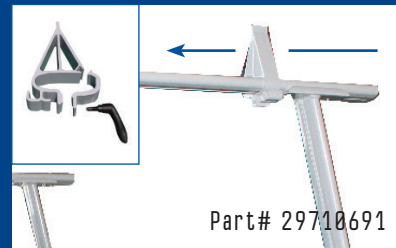

Part# 29710691

BOX MOUNT KIT



Part# 29710692

CLEAT TIE-DOWN KIT



Part# 29710693

HEADACHE RACK INSERT



Part# 29210689



THE QUANTUM® RACK

FEATURES

Fits most full-size and compact trucks
Top rail width fully adjustable to fit most any truck
Built in accessory track allows for ease of mounting optional accessories

Installs in 4 easy steps and bolts together with stainless steel hardware
Durable Quantum Silver™ or Matte Black powder coat finish
Handles loads up to 800 lbs

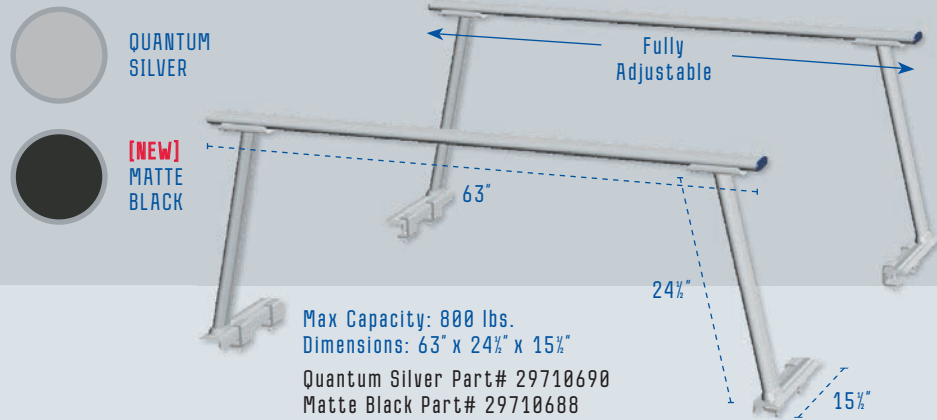

QUANTUM® RACK FEATURES



NO-DRILL MOUNTING



ADJUSTABLE CROSSBARS



HEAVY DUTY DESIGN

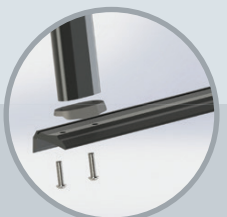

STURDY SADDLE

“NO SHAKE OR SWAY AT ALL”

“Once assembled, putting racks on and taking them off is very simple and quick. They are very stable once installed and do not shake or sway at all. 800 lb. load capacity! Need I say more?”

- Bryan





Max Capacity: 250 lbs/set
Dimensions: 27" x 1 1/2" x 57 1/2"

Y-LADDER RACK

Allows storage of long, awkward items that won't fit in your truck bed. Designed to fit any truck.
Weight Capacity: 250 lbs per set.

Part# 29710002

BUMPER BUDDY

Available in both lightweight aluminum and heavy duty steel in three durable powder-coat finishes.



Max Capacity: 500 lbs
Dimensions: 49" x 22 1/2" x 4"

STEEL
BUMPER
BUDDY

SOLID

"If I had to do it again, I would choose the same product."

- Stan
Minnesota

FOLDING KNUCKLE

Optional folding knuckle accessory for easy, compact storage. Pictured with Brite Aluminum Bumper Buddy.

Part# 21710700



ALUMINUM BUMPER BUDDY
+ FOLDING KNUCKLE

CROWN SITE SAFE JOBSITE BOX

DESCRIPTION	PART #	DIMENSIONS		
		L	W	H
60" Site Safe	37211297	60"	24"	25"
48" Site Safe	37211296	48"	23"	25"
36" Site Safe	37211295	36"	17"	25"

Secure, on-site storage constructed of heavy duty steel with a reinforced lid. Site Safes provide the security and durability to meet your industrial demands.



60" SITE SAFE
(Caster Wheel Kit Sold Separately)

CASTER WHEEL KIT

Part# 29812062

Sold separately, the Caster Wheel Kit includes all necessary mounting hardware, supports up to 1100 lbs, and is comprised of two lockable rotating wheels and two stationary wheels.



60" SITE SAFE

48" SITE SAFE

36" SITE SAFE

Crown Series Site Safes are made from 18 Gauge Steel

SITE SAFE FEATURES

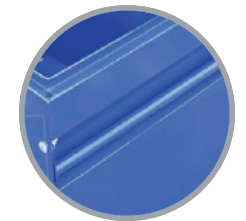

RETRACTABLE HANDLES

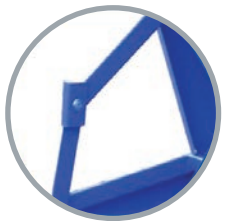

HEAVY DUTY LID PROP

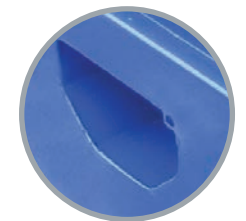

PADLOCK CAVITIES

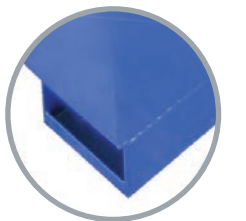

MULTI-FUNCTIONAL FEET

QUALITY

"I bought my first one in 2004 for my Refrigeration Service Truck, and it fit in the service bed perfectly. I sold the truck and box to my brother for his Trucking Company in 2006, and he used the box to secure large tools. He then sold the truck and box to my nephew for his electrical company in 2010 and he still uses it. It's still in excellent shape. You can't get a better deal on that quality."

- gearhead

SEC
SERIES

SEC SERIES

Built with optimum performance in mind, Better Built's SEC Series delivers premium features to the industry's Original Aluminum Truck Tool Box.



Prototype rail box shown. Retail product may vary slightly in appearance.

**SEC
SERIES**

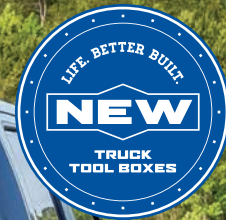

ABOUT THE SEC SERIES

Our SEC Series is the next level in our line of utility boxes, and the first to offer premium features like automotive-grade pull handles.



SEC LOW PROFILE

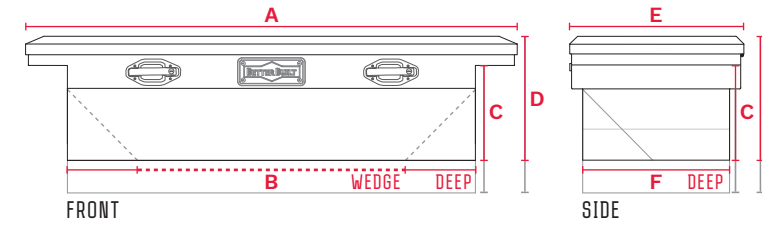

“INFINITELY BETTER”

“Better Built has one of the best latch/lock mechanisms on the market. I highly recommend it. Their ‘Better Built’ latches are infinitely better than the ones on the two previous boxes I’d purchased.”

- Jake

Refer to Our Fitment Guide for More Information (Page 6).

THE SPECIAL EDITION CROWN SERIES

SUPERIOR FEATURES AND THE LOOKS TO MATCH.

Industry exclusive details work as well as they look.

▼ Chrome Locking Pull Handles



▼ 2-Stage Automotive-Grade Rotary Latches



▼ Durable Foam-Filled Lid With Welded C-Channel

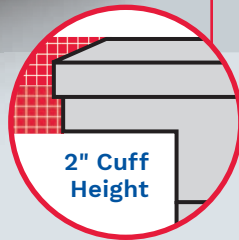

SEC LOW PROFILE BOX

DESCRIPTION	ALUMINUM PART #				DIMENSIONS					
	BRITE	GLOSS BLACK	MATTE BLACK	QUANTUM SILVER	A	B	C	D	E	F
71" Crossover	79011002	79210920	79211098	79212532	71"	62"	11"	13"	20"	16½"
69" Crossover	79011003	79210919	79211099	79212530	69"	60"	11"	13"	20"	16½"
69" Universal Stair Cut	79010947	79210948			69"	45"	11"	13"	20"	16½"
69" Universal Wedge			79211103	79212531	69"	45"	11"	13"	20"	16½"
67" Crossover	79011007				67"	56½"	11"	13"	20"	16½"
63" Crossover	79011010	79210918	79211100	79212528	63"	54"	11"	13"	20"	16½"
63" Universal Wedge	79011056	79211057	79211104	79212529	63"	39"	11"	13"	20"	16½"
61½" Universal Corner Notch	79011005	79210917			61½"	52"	11"	13"	20"	16½"
61½" Universal Wedge	79011000	79211001			61½"	35"	11"	13"	20"	16½"
56½" Crossover	79011054	79210916			56"	46"	11"	13"	20"	16½"
NEW 69" Crossover with Rail		79211115	79211116		69"	60"	11"	13"	20"	16½"

DEEP	ALUMINUM PART #				DIMENSIONS					
	BRITE	GLOSS BLACK	MATTE BLACK	QUANTUM SILVER	A	B	C	D	E	F
71" Crossover	79010902	79210922	79211101	79212535	71"	62"	15"	19"	20"	16½"
71" Universal Wedge	79011068	79211070	79211106	79212536	71"	47"	15"	19"	20"	16½"
69" Crossover	79010901	79210921	79211102	79212533	69"	60"	15"	19"	20"	16½"
69" Universal Wedge	79011067	79211069	79211105	79212534	69"	44"	15"	19"	20"	16½"
61½" Universal Stair Cut	79010946				61½"	39"	15"	19"	20"	16½"



FOR THE TRUCK THAT'S EQUAL PARTS WORK AND PLAY **&** YOUR EXTRA LARGE TARP



SEC STANDARD CUFF CROSSOVER

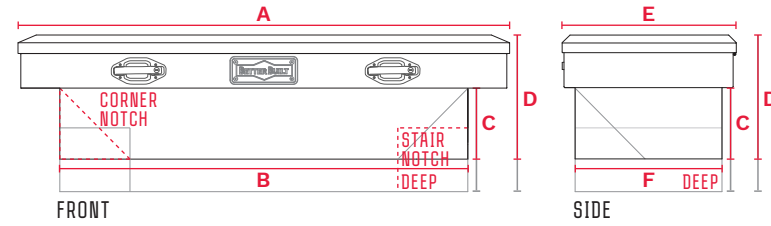

SEC STANDARD CUFF CROSSOVER BOX

STANDARD	ALUMINUM PART #				DIMENSIONS					
	BRITE	GLOSS BLACK	MATTE BLACK	QUANTUM SILVER	A	B	C	D	E	F
71" Crossover	79011016	79210984	79211093	79212525	71"	60½"	8"	13"	20"	16½"
71" Crossover, Wide	79011066	79212419	79212418	79212519	71"	60½"	8"	13"	26"	23½"
69" Crossover	79011012	79210986	79211094	79212524	69"	58½"	8"	13"	20"	16½"
69" Crossover, Wide	79011065	79212420	79212417	79212518	69"	58½"	8"	13"	26"	23½"
67" Crossover	79011031				67"	56"	8"	13"	20"	16½"
63" Crossover	79011025	79210988	79211095	79212523	63"	52"	8"	13"	20"	16½"
63" Universal Corner Cut	79010936	79211055			63"	52"	8"	13"	20"	16½"
61½" Crossover	79011014	79210989			61½"	51"	8"	13"	20"	16½"
61½" Universal Corner Cut	79011018	79210990			61½"	51"	8"	13"	20"	16½"
56½" Crossover	79011023	79210991			56½"	45½"	8"	13"	20"	16½"
51" Crossover	79011929				51"	40"	8"	13"	20"	16½"

DEEP	ALUMINUM PART #				DIMENSIONS					
	BRITE	GLOSS BLACK	MATTE BLACK	QUANTUM SILVER	A	B	C	D	E	F
71" Crossover	79011028	79210985	79211096	79212527	71"	60½"	14"	19"	20"	16½"
69" Crossover	79011020	79210987	79211097	79212526	69"	58½"	14"	19"	20"	16½"
67" Crossover	79011047				67"	56"	14"	19"	20"	16½"
63" Crossover	79011044				63"	52"	14"	19"	20"	16½"
63" Crossover Stair Cut	79011004				63"	41"	14"	19"	20"	16½"
61½" Crossover	79011040				61½"	50½"	14"	19"	20"	16½"
61½" Universal Stair Cut	79011035	79211760			61½"	39½"	14"	19"	20"	16½"
56½" Crossover	79011034				56½"	45½"	14"	19"	20"	16½"
51" Crossover	79010930				51"	40"	14"	19"	20"	16½"

DEEP + WIDE	ALUMINUM PART #				DIMENSIONS					
	BRITE	GLOSS BLACK	MATTE BLACK	QUANTUM SILVER	A	B	C	D	E	F
71" Crossover	79010924		79212414	79212517	71"	60½"	11"	16"	25"	22½"
69" Crossover	79010923		79212413	79212516	69"	52"	11"	16"	25"	22½"



FITS PERFECTLY

"I love the matte style finish! The black handles are awesome and the locking system is better than any other I have seen."

- Philip Lebanon, KY



SEC X2 END OPENING BOX

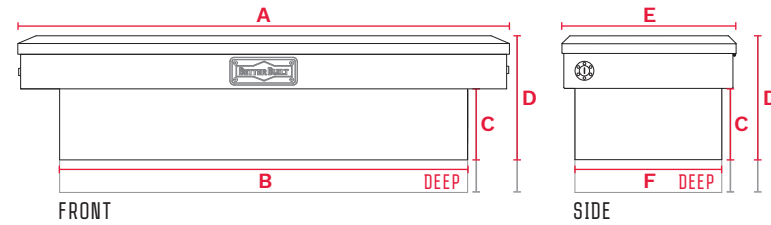

Refer to Our
Fitment Guide for
More Information
(Page 6).



"This tool box is great, and is equipped with two self-lifting shocks on the lid."

- David
Hodgenville, KY

X2 END OPENING BOX

STANDARD	ALUMINUM PART #				DIMENSIONS					
	BRITE	GLOSS BLACK	MATTE BLACK	QUANTUM SILVER	A	B	C	D	E	F
71" Crossover	79011750	79212429	79212435	79212542	71"	60½"	8"	14"	20"	16½"
69" Crossover	79011752	79212427	79212433	79212540	69"	52"	8"	14"	20"	16½"
61½" Universal Corner-Cut	79011754	79212425	79212431	79212538	61½"	49"	8"	14"	20"	17½"

DEEP	ALUMINUM PART #				DIMENSIONS					
	BRITE	GLOSS BLACK	MATTE BLACK	QUANTUM SILVER	A	B	C	D	E	F
71" Crossover	79011751	79212428	79212434	79212541	71"	60½"	14"	20"	20"	16½"
69" Crossover	79011753	79212426	79212432	79212539	69"	58½"	14"	20"	20"	16½"
61½" Compact Crossover	79011755	79212424	79212430	79212537	61½"	50½"	14"	20"	20"	16½"

SEC SLIMLINE LOW PROFILE BOX

DESCRIPTION	ALUMINUM PART #				DIMENSIONS					
	BRITE	GLOSS BLACK	MATTE BLACK	QUANTUM SILVER	A	B	C	D	E	F
71" Crossover	79011052	79210904	79212423	79212522	71"	62"	10"	12"	13½"	12"
69" Crossover	79011051	79210903	79212422	79212521	69"	60"	10"	12"	13½"	12"
63" Universal Wedge	79011050	79211759	79212421	79212520	63"	38"	10"	12"	13½"	12"

LOW PROFILE SLIMLINE BOX

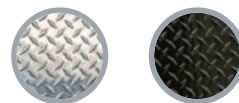
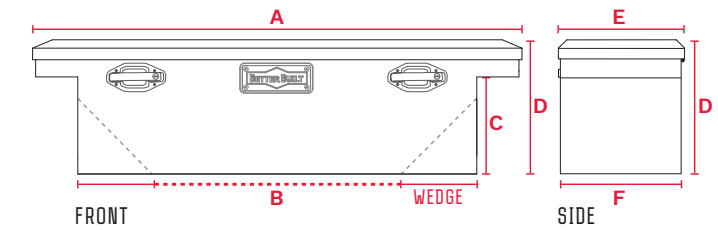

BRITE UNCOATED

GLOSS BLACK

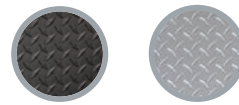

MATTE BLACK

QUANTUM SILVER

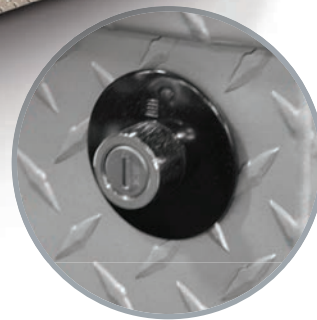

LOCKING PUSH BUTTON LATCHES

Smooth functioning push button latches allow you to lock and unlock your box from either side.



HAWKBILL LATCHES

The Hawkbill latching system provides the ultimate security for the contents of your box.



X2 DEEP

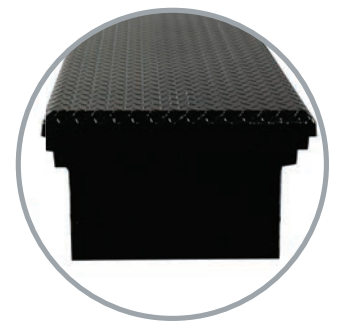

SLIM TUB

Our Slimline Boxes allow for more room in your truck bed, using only 12" of space.



SLIMLINE BLACK

FOR

THE TRUCK BED THAT'S WATCHING ITS FIGURE



8' OF ¼" CHAIN PLUS A FEW LINKS





SEC TWO-LID CROSSOVER BOX

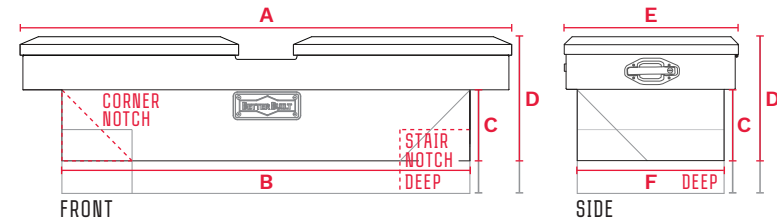

Refer to Our
Fitment Guide for
More Information
(Page 6).

SEC TWO-LID CROSSOVER BOX

STANDARD	ALUMINUM PART #	DIMENSIONS					
	BRITE	A	B	C	D	E	F
71" Crossover	79011021	71"	60½"	8"	13"	20"	16½"
69" Crossover	79011013	69"	58½"	8"	13"	20"	16½"
67" Crossover	79011045	67"	56"	8"	13"	20"	16½"
63" Universal Corner Cut	79010934	63"	38"	8"	13"	20"	16½"
63" Crossover	79011042	63"	52"	8"	13"	20"	16½"
61½" Universal Corner Cut	79011024	61½"	51"	8"	13"	20"	16½"
61½" Crossover	79011032	61½"	49"	8"	13"	20"	16½"
56½" Crossover	79011037	56½"	45½"	8"	13"	20"	16½"
51" Crossover	79010927	51"	40"	8"	13"	20"	16½"

DEEP	ALUMINUM PART #	DIMENSIONS					
	BRITE	A	B	C	D	E	F
71" Crossover	79011048	71"	60½"	14"	19½"	20"	16½"
69" Crossover	79011030	69"	58½"	14"	19½"	20"	16½"
67" Crossover	79011046	67"	56"	14"	19½"	20"	16½"
63" Universal Stair Cut	79010935	63"	41"	14"	19½"	20"	16½"
63" Crossover	79011043	63"	52"	14"	19½"	20"	16½"
61½" Universal Stair Cut	79011041	61½"	38"	14"	19½"	20"	16½"
61½" Crossover	79011039	61½"	49"	14"	19½"	20"	16½"
56½" Crossover	79011038	56½"	45½"	14"	19½"	20"	16½"



UNIVERSAL TWO-LID - CORNER CUT



SEC DEEP TWO-LID



SEC DEEP UNIVERSAL TWO-LID

**“GOOD FIT.
REASONABLE
PRICE.”**

“This tool box is perfect for my Tacoma. Good fit and a reasonable price. The sliding shelf moves smoothly and is large enough to hold often used tools.”

- Tom
Spring Branch, TX

FOR FANS OF BACK TO THE FUTURE & EXTRA JUGS OF WATER



AN ALTERNATIVE TO THE CROSSOVER BOX

The SEC Chest Box leaves the bed rails of your truck unobstructed for other uses.



OFFSET LID

The offset hinge allows your lid to open nearly 90 degrees, even while sitting flush against your truck cab.

SEC ROCKS

"Product looks great, the new handles rock for easy opening."

- Michael Komoka, ON

SEC SIDE MOUNT BOX

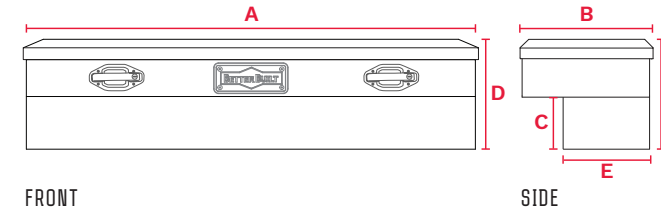

SEC SIDE MOUNT BOX

DESCRIPTION	ALUMINUM PART #				DIMENSIONS				
	BRITE	GLOSS BLACK	MATTE BLACK	QUANTUM SILVER	A	B	C	D	E
72" Side Mount	79010999	79211762			72"	12"	6"	12"	8"
60" Side Mount	79011033	79210996	79212412	79212515	60"	12"	6"	12"	8"
48" Side Mount, Single Latch	79011019	79210995	79212411	79212514	48"	12"	6"	12"	8"
36" Side Mount, Single Latch	79012451	79212445	79212446	79212444	36"	12"	6"	12"	8"

SEC CHEST BOX

DESCRIPTION	ALUMINUM PART #				DIMENSIONS			
	BRITE	GLOSS BLACK	MATTE BLACK	QUANTUM SILVER	A	B	C	D
60" Chest Box	79011015	79210994	79212439	79212545	60"	17½"	15¾"	18"
60" Chest Box, Wide	79010982		79212441	79212547	60"	21½"	24"	18"
56" Chest Box	79010983	79210993			56"	17½"	15¾"	18"
48" Chest Box	79011017	79210992	79212437	79212544	48"	17½"	15¾"	18"
48" Chest Box, Wide	79010981		79212440	79212546	48"	21½"	24"	18"
40" Chest Box	79011062				41"	17½"	15¾"	18"
36" Chest Box	79011063	79211761	79212436	79212543	36"	17½"	15¾"	18"



60" CHEST BOX

SEC STANDARD CHEST

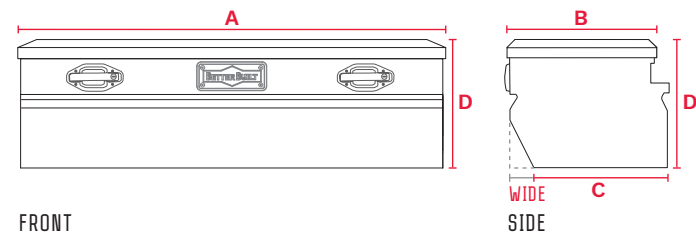

48" SIDE MOUNT GLOSS BLACK



LOCKING CHROME PULL HANDLES
Industry exclusive locking pull handle latches allow you to lock or unlock your box from either side. Available in a durable chrome finish.



ROTARY LATCHES
The automotive-grade 2-stage rotary latch provides premium security for the contents of your box.



72" SIDE MOUNT

FOR **THOSE WHO NEED MORE STORAGE IN ADDITION TO A CROSSOVER** **&** **A SET OF JUMPER CABLES**

SEC
SERIES

SEC FISHING BOX

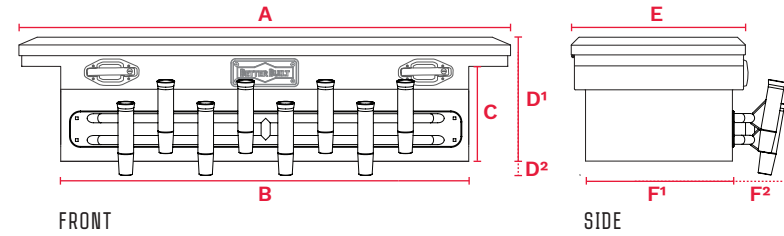

Refer to Our
Fitment Guide for
More Information
(Page 6).



79211110
**SEC Series Low Profile
Fishing Tool Box**

- FEATURES**
- Self-Adjusting Strikers a.
 - Continuous Aluminum b.
 - Piano Hinge c.
 - Solid One-Piece Body Construction
 - Offset Rod Holders d.
 - Weather Resistant Seals e.
 - Reinforced C-Channel f.
 - With Foam Filled Lid g.
 - Auto-Lift Shocks g.

THE SEC FISHING BOX

Before you embark on your next fishing trip, make sure all of your gear and tackle survive the trip. With eight offset rod holders and plenty of room for all of your tackle and gear, make Better Built's Fishing Box a part of your next outdoor adventure!

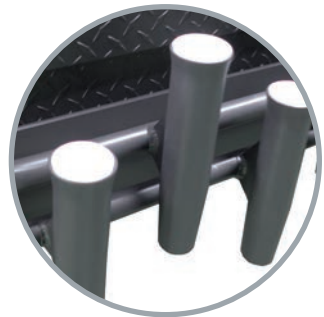

OFFSET ROD HOLDERS
The eight offset rod holders fit most standard fishing rods on the market.



POWDER COATED LOCKING PULL HANDLES
Industry exclusive locking pull handle latches allow you to lock or unlock your box from either side. Featured here in a durable powder coat finish.



FOR

**THE SPORTSMAN
WHO TAKES
FISHING REALLY
SERIOUSLY**



**ALL YOUR
TACKLE AND
FISHING
GEAR**



SEC FISHING BOX

DESCRIPTION	ALUMINUM PART #			DIMENSIONS							
	GLOSS BLACK	MATTE BLACK	QUANTUM SILVER	A	B	C	D ¹	D ²	E	F ¹	F ²
69" Low Profile Fishing Box	79211111	79211110	79211112	69"	60"	11"	13¾"	3½"	20"	16½"	7½"



SEC QUANTUM SILVER FISHING BOX



SEC GLOSS BLACK FISHING BOX

SLE
SERIES

SLE SERIES

Designed entirely in-house, Better Built spared no effort to fashion the Shotgun Latch Elite Series into our most fully realized Aluminum Truck Tool Box.



SLE SERIES

ABOUT THE SLE SERIES

Better Built's top of the line consumer tool boxes, the SLE Series offers our best combination of performance, utility and looks.



THE SHOTGUN LATCH ELITE SERIES

The Shotgun Latch Elite series of crossovers is the newest generation of Better Built truck tool box. It has an end opening quick-pull latch system for maximum security and convenience.

The front facing trigger style latches make it easy to open the box from the side of your truck while providing a more secure locking system.



SHOTGUN ROTARY LATCH SYSTEM

Our two-stage automotive-grade latches, combined with the elegance of the features below separate our boxes from the competition.



77213013 NEW SLE Series Low Profile Deep Crossover Tool Box

FEATURES

- Self-Adjusting Strikers a.
- Continuous Aluminum b.
- Piano Hinge c.
- Solid One-Piece Body Construction d.
- 100% Fully Welded Seams e.
- Premium Weather Resistant Seals f.
- Reinforced C-Channel With Foam Filled Lid



D-RING MOUNT POINTS FOR SECURING CARGO.

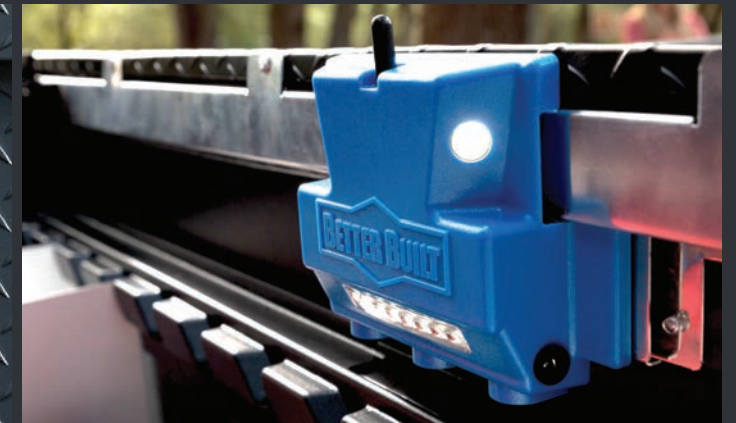

FIND WHAT YOU NEED—EVEN AT NIGHT.



GET ORGANIZED WITH MULTI-DIVIDER SYSTEM.

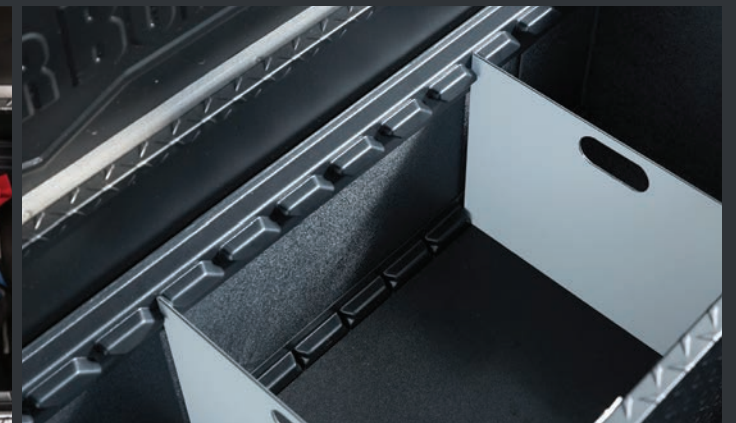

WASHABLE INTERIOR LINER WITH DRAIN.

SLE
SERIES



NEW SLE LOW PROFILE CROSSOVER BOX

STANDARD	ALUMINUM PART #				DIMENSIONS					
	BRITE	GLOSS BLACK	MATTE BLACK	QUANTUM SILVER	A	B	C	D	E	F
71" Crossover with Organization	77013069	77213066	77213067	77213068	71"	62"	11"	14½"	20"	16½"
69" Crossover with Organization	77013065	77213062	77213063	77213064	69"	60"	11"	14½"	20"	16½"
69" Universal Wedge with Organization	77013093	77213091	77213091	77213092	69"	60"	11"	14½"	20"	16½"
63" Crossover with Organization	77013073	77213070	77213071	77213072	63"	54"	11"	14½"	20"	16½"
63" Universal Wedge with Organization	77013097	77213094	77213095	77213096	63"	54"	11"	14½"	20"	16½"

DEEP	ALUMINUM PART #				DIMENSIONS					
	BRITE	GLOSS BLACK	MATTE BLACK	QUANTUM SILVER	A	B	C	D	E	F
71" Crossover with Organization	77013016	77213013	77213014	77213015	71"	62"	15"	18½"	20"	16½"
69" Crossover with Organization	77013012	77213009	77213010	77213011	69"	60"	15"	18½"	20"	16½"
69" Universal Wedge with Organization	77013004	77213001	77213002	77213003	63"	50"	15"	18½"	20"	16½"
63" Crossover with Organization	77013020	77213017	77213018	77213019	63"	54"	15"	18½"	20"	16½"
63" Universal Wedge with Organization	77013008	77213005	77213006	77213007	63"	54"	15"	18½"	20"	16½"

SLE CROSSOVER BOX

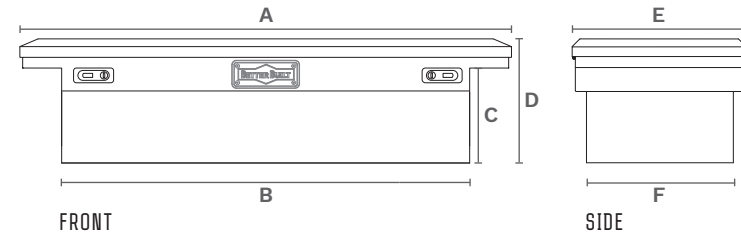

Refer to Our Fitment Guide for More Information (Page 6).

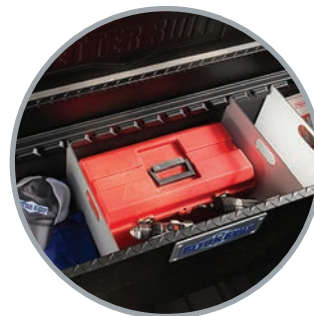

MULTI-DIVIDER SYSTEM
Four removable slats are included for creating handy individual compartments. **Liner is washable.**



INTERIOR LIGHTING
The stylish interior LED lighting makes locating items a snap, even at night. The lights turn on when the box is opened, and off when closed. **No wasted time, no wasted batteries!**



77013089
NEW SLE Side Mount Tool Box

FEATURES

Self-Adjusting Strikers	a.
Continuous Aluminum	b.
Piano Hinge	
Weather Resistant Seals	c.
Reinforced Lid Brace	d.
Premium Shocks	e.

NEW SLE SIDE MOUNT BOX

DESCRIPTION	ALUMINUM PART #				DIMENSIONS				
	BRITE	GLOSS BLACK	MATTE BLACK	QUANTUM SILVER	A	B	C	D	E
48" Side Mount, Chrome Latch	77013089	77213086			48"	12"	6"	12"	8"
48" Side Mount, Black Latch			77213087	77213088	48"	12"	6"	12"	8"
36" Side Mount, Chrome Latch	77013085	77213082			36"	12"	6"	12"	8"
36" Side Mount, Black Latch			77213083	77213084	36"	12"	6"	12"	8"



BRITE 36" SHOTGUN LATCH BOX

SLE SIDE MOUNT BOX

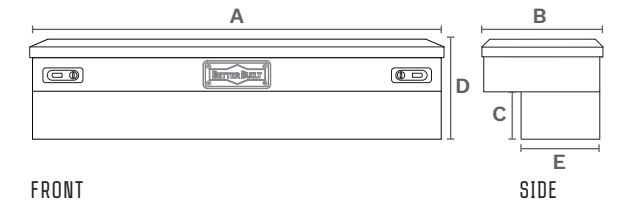

SHOTGUN ROTARY LATCH SYSTEM
Our two-stage automotive-grade latches, combined with the elegance of our brand-new Shotgun Latch separate our boxes from the competition.



AUTO-LIFT SHOCKS
Auto-lift shocks allow you to open and close the lid with ease.



FOR THE TRUCK WITH EVERY AVAILABLE OPTION **&** A 3-TON FLOOR JACK

FOR THOSE WHO NEED ONE FINGER OPERATION OUTSIDE THE TRUCK BED **&** BASEBALL GLOVES, BATS, ETC.

HD
SERIES

BETTER BUILT

BETTER BUILT
HD HEAVY DUTY

HD SERIES

No matter your trade, Better Built's professional grade Heavy Duty Series will tackle the task with uncompromising durability and excellence.

45



THE HEAVY DUTY SERIES

FEATURES

Climate Lock Seal	Heavy Duty Foam-Filled Lid	Patented Quantum® Storage System Latch Rail, Compatible with Any of Your Peg Board Accessories
Solid Full Length Piano Hinge	Patented Self-Adjusting Strikers	4-Stage Automotive-Grade Rotary Billet Push Button Latches, with a High Polish Shine
Small Part Storage Partition	Cross Broken Lid for Strength	
Auto-Lift Heavy Duty Shocks	Power Portal - Easy Access Point to Run Electricity Into the Box	
Abrasion Resistant Powder Coat		



LOCKED UNLOCKED
4-Stage Automotive-Grade Rotary Latches With Billet Push Button Locks

Includes 2 Steel Storage Trays that integrate with the Quantum® Storage System Latch Rail and 4 interchangeable dividers to fit your needs.

No-Drill Grip-Rite® Mounting Kit & Heavy Duty Non-Slip Mat Included.



71" STANDARD BLACK STEEL

FOR

PROFESSIONALS & ENTHUSIASTS WHO REQUIRE PERFORMANCE BEYOND THE TOP SHELF

&

HIDING A GIFT DURING THE HOLIDAYS

HD STANDARD CROSSOVER

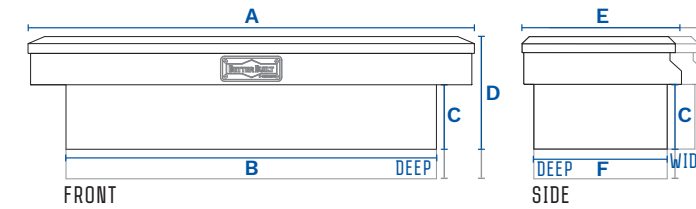

HD LOW PROFILE CROSSOVER

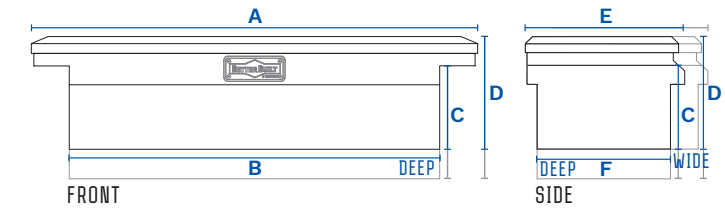

HD CROSSOVER BOX

STANDARD	ALUMINUM PART #		STEEL PART #		DIMENSIONS					
	QUANTUM SILVER	GLOSS BLACK	WHITE	BLACK	A	B	C	D	E	F
71" Crossover	37234810	37224267	37224176	37224189	70½"	59"	7"	13"	22"	19"
71" Deep Crossover	37234811	37224268	37224177	37224190	70½"	59"	13"	19"	22"	19"
71" Deep & Wide Crossover	37234812	37224269	37224178	37224191	70½"	59"	13"	16"	28"	24½"
67" Crossover	37234816	37224273	37224182	37224195	67"	56"	7"	13"	22"	19"
67" Deep Crossover	37234817	37224274	37224183	37224196	67"	56"	13"	19"	22"	19"
63" Crossover	37234818	37224275	37224184	37224197	63"	52"	7"	13"	22"	19"

LOW PROFILE	ALUMINUM PART #		STEEL PART #		DIMENSIONS					
	QUANTUM SILVER	GLOSS BLACK	WHITE	BLACK	A	B	C	D	E	F
71" Crossover	37234837	37224326	37224338	37224332	70½"	59½"	9"	13"	22"	19"
71" Deep Crossover	37234838	37224327	37224339	37224333	70½"	59½"	16"	19"	22"	19"
71" Deep & Wide Crossover	37234840	37224328	37224340	37224334	70½"	59½"	13"	16"	28"	24½"



BLACK ALUMINUM DEEP

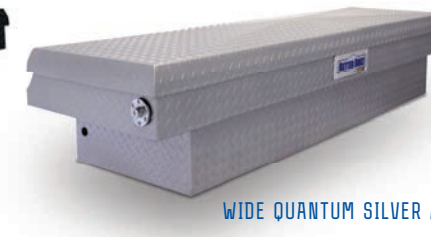

WIDE QUANTUM SILVER ALUMINUM

Refer to Our Fitment Guide for More Information (Page 6).



PATENTED QUANTUM® STORAGE SYSTEM

Well thought out organization keeps your tools where you know they should be.

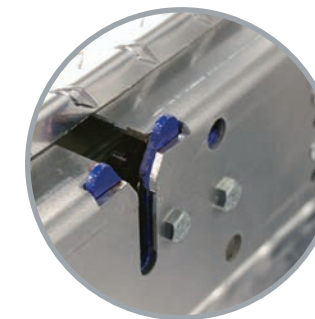

4-STAGE AUTOMOTIVE-GRADE ROTARY LATCH

Know your lid is securely closed with four satisfying clicks of our professional grade rotary latches.

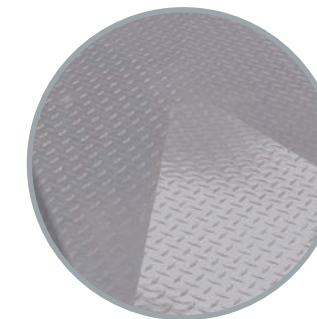

CROSSBROKEN LID

This manufacturing technique adds structural integrity and resists unwanted lid deformations.

BUILT TOUGH

"Exactly what I expected. Great looking box built quality tough. I'd recommend it to anyone."

- Bradley Paris, TX

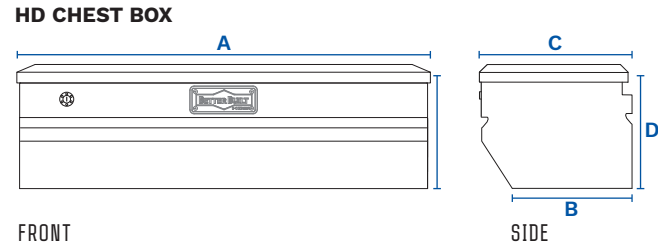

HD CHEST BOX

DESCRIPTION	ALUMINUM PART #		STEEL PART #		DIMENSIONS			
	QUANTUM SILVER	GLOSS BLACK	WHITE	BLACK	A	B	C	D
60" Chest Box	37234826	37224292	37224210	37224214	60"	15¾"	20"	18"
48" Chest Box	37234827	37224293	37224211	37224215	48"	15¾"	20"	18"



QUANTUM SILVER ALUMINUM CHEST BOX



INCLUDES PATENTED QUANTUM® STORAGE SYSTEM

Well thought out organization keeps your tools where you know they should be.

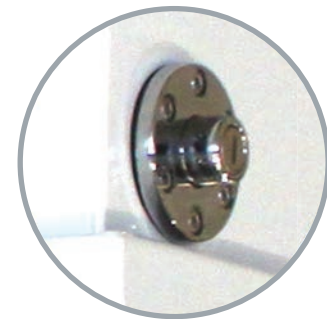

PUSH BUTTON BILLET LOCKS WITH 4-STAGE AUTOMOTIVE-GRADE ROTARY LATCH



CLIMATE LOCK SEAL



LOCKED UNLOCKED

4-Stage Automotive-Grade Rotary Latches With Billet Push Button Locks



Heavy Duty Keys



Heavy Duty Non-Slip Mat Included.

HEAVY DUTY CHEST BOX

FEATURES

- Climate Lock Seal
- Solid Full Length Piano Hinge
- Auto-Lift Heavy Duty Shocks
- 90° Lid Opening and Offset Lid
- Abrasion Resistant Powder Coat
- Heavy Duty Foam-Filled Lid
- Patented Self-Adjusting Strikers

- Cross Broken Lid for Strength
- Patented Quantum® Storage System Latch Rail, Compatible with Any of Your Peg Board Accessories
- Billet Push Buttons With 4-Stage Automotive-Grade Rotary Latches, with a High Polish Shine



BLACK ALUMINUM CHEST BOX



BLACK STEEL CHEST BOX

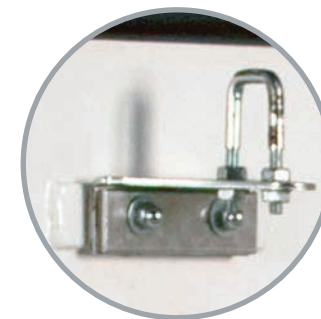

PATENTED SELF ADJUSTING STRIKERS



HEAVY DUTY GAS POWERED AUTO-LIFT SHOCKS

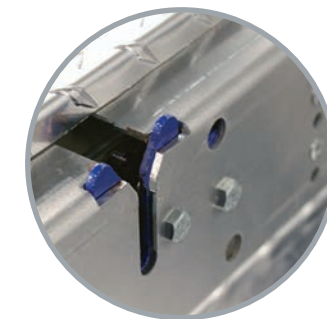

4-STAGE AUTOMOTIVE-GRADE ROTARY LATCH



HEAVY DUTY FOAM FILLED LID

FOR

THOSE LOOKING FOR EXTRA STRENGTH AND BEYOND TOP SHELF PERFORMANCE IN A MORE COMPACT FORM FACTOR



EMERGENCY TRAILER LIGHTS



HD TOP MOUNT BOX

DESCRIPTION	ALUMINUM PART #		STEEL PART #		DIMENSIONS		
	QUANTUM SILVER	GLOSS BLACK	WHITE	BLACK	L	W	H
96" Top Mount, Double Door	37234832	37224313			96"	16"	18"
90" Top Mount, Double Door	37234833	37224314			90"	16"	18"
72" Top Mount, Double Door	37234834	37224315	37224231	37224237	72"	16"	18"
60" Top Mount, Single Door	37234835	37224316	37224232	37224238	60"	16"	18"
46" Top Mount, Single Door	37234836	37224317	37224233	37224239	46"	16"	18"



HEAVY DUTY TOP MOUNT

FEATURES	
Heavy Duty Climate Lock Seal	Abrasion Resistant Powder Coat
Solid Full Length Piano Hinge	Removable Shelves and Peg Board that Fits Any Pegboard Accessories
Steel Door Cables Prevent Over-Extension of Door	Heavy Duty Dual Locking Cam Action Latches, with 3-Point Locks
90° Door Opening and Offset Door	



FOR THOSE WHO LIVE OUT OF AND MAKE A LIVING WITH THEIR TRUCK & SMALLER TOOLS NOT IN YOUR CHEST BOX

HD DOUBLE DOOR TOP MOUNT

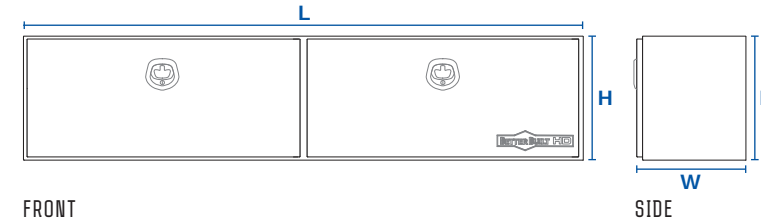

HD SINGLE DOOR TOP MOUNT

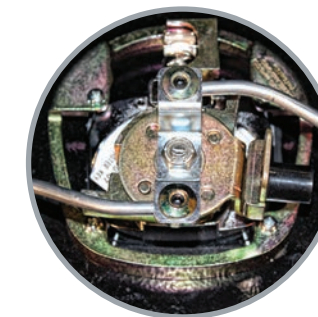
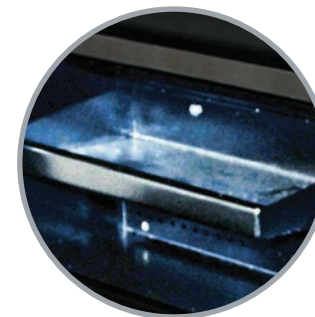
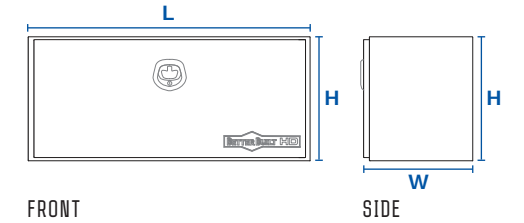

HEAVY DUTY SIDE MOUNT

FEATURES

Climate Lock Seal	Patented Self-Adjusting Strikers
Solid Full Length Piano Hinge	Cross Broken Lid for Strength
Auto-Lift Heavy Duty Shocks	Patented Quantum® Storage System
Abrasion Resistant Powder Coat	4-Stage Automotive-Grade Rotary Latches
Heavy Duty Foam-Filled Lid	



LOCKED UNLOCKED
4-Stage Automotive-Grade Rotary Latches With Billet Push Button Locks



No-Drill Grip-Rite® Mounting Kit Included.
Heavy Duty Keys

HD SIDE MOUNT BOX

STANDARD	ALUMINUM PART #		STEEL PART #		DIMENSIONS				
	QUANTUM SILVER	GLOSS BLACK	WHITE	BLACK	A	B	C	D	E
72" Side Mount	37234822	37224283	37224200	37224205	72"	17"	7½"	13"	12½"
60" Side Mount	37234823	37224284	37224201	37224206	60"	17"	7½"	13"	12½"
46" Side Mount	37234824	37224285	37224202	37224207	46"	17"	7½"	13"	12½"

LOW PROFILE	ALUMINUM PART #		STEEL PART #		DIMENSIONS				
	QUANTUM SILVER	GLOSS BLACK	WHITE	BLACK	A	B	C	D	E
46" Side Mount	37234844	37224346	37224350	37224348	46"	17"	10"	13"	12½"

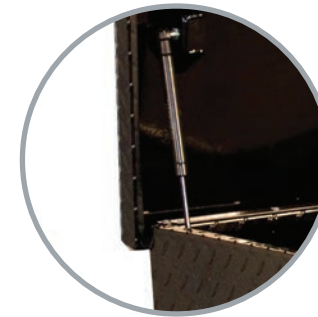
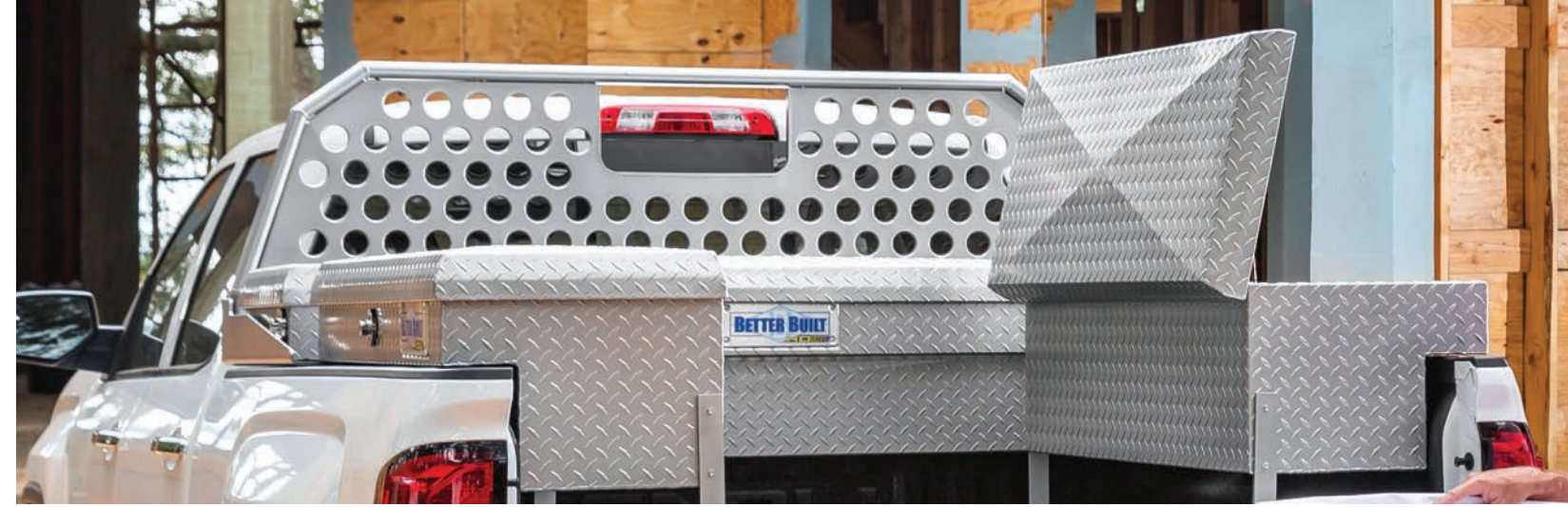

LID OPENS NEARLY 90° WITH HEAVY DUTY AUTO-LIFT SHOCKS



PATENTED QUANTUM® STORAGE SYSTEM

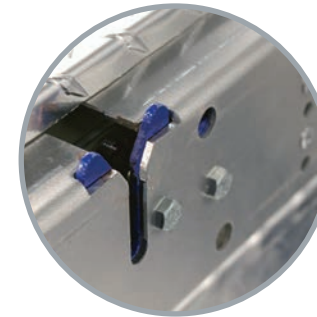

4-STAGE AUTOMOTIVE-GRADE ROTARY LATCH



HEAVY DUTY POWDER COAT FINISH

HD 71" SIDE MOUNT

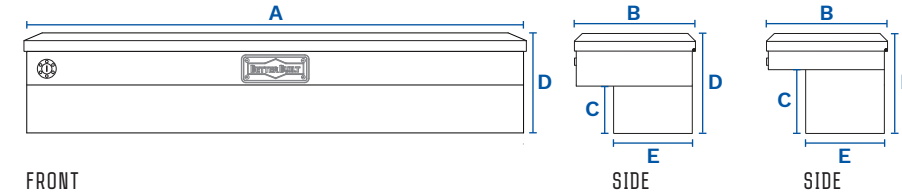

FRONT

SIDE

SIDE



HD 46" SIDE MOUNT

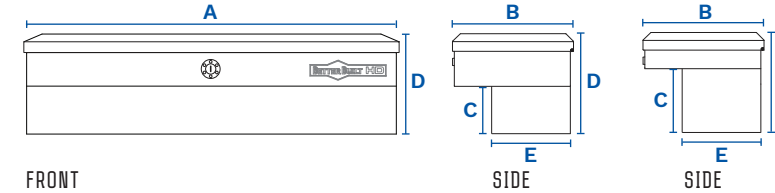

FRONT

SIDE

SIDE



BLACK STEEL SIDE MOUNT



WHITE STEEL SIDE MOUNT



FOR ADDITIONAL STORAGE PLUS MAXIMUM DURABILITY **&** SPARE WELDING RODS



HEAVY DUTY UNDERBODY BOX

FEATURES

Climate Lock Seal

Solid Full Length Piano Hinge

Heavy Duty Abrasion Resistant Powder Coat Finish Inside and Out

Dual Locking Cam Action Heavy Duty 3-point Latches, with a High Polish Shine

Heavy Duty Steel Door Chains Prevent Over-Extension of Door



Heavy Duty Keys

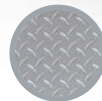

QUANTUM SILVER



GLOSS BLACK



BLACK STEEL



WHITE STEEL



DROP-DOOR DESIGN AND SLIDING SHELF



HEAVY DUTY 3-POINT LATCHES



DUAL LOCKING CAM ACTION LOCKS

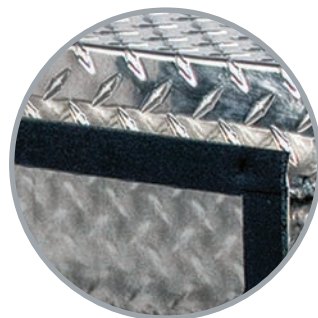

CLIMATE LOCK WEATHER SEAL

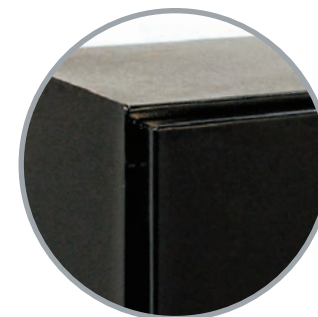

ABRASION RESISTANT POWDER COATING



29221128 UNDERBODY INSTALLATION KIT



QUANTUM SILVER ALUMINUM UNDERBODY 24"



BLACK ALUMINUM UNDERBODY 24"



BLACK STEEL UNDERBODY 60"

HD UNDERBODY BOX

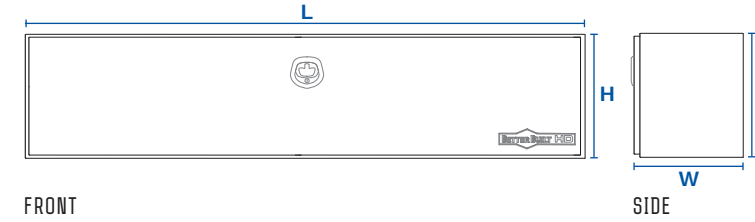

HD UNDERBODY BOX

DESCRIPTION	ALUMINUM PART #		STEEL PART #		DIMENSIONS		
	QUANTUM SILVER	GLOSS BLACK	WHITE	BLACK	L	W	H
60" Underbody	37234828	37224302	37224218	37224224	60"	17"	18"
48" Underbody	37234829	37224303	37224219	37224225	48"	17"	18"
36" Underbody	37234830	37224304	37224220	37224226	36"	17"	18"
NEW 30" Underbody	37234845	37224306		37224228	30"	17"	18"
24" Underbody	37234831	37224305	37224221	37224227	24"	17"	18"



HEAVY DUTY SITE SAFE

FEATURES

- Available in 36", 48" and 60" sizes
- Durable powder coat finish
- Stowable Handles
- Removable Parts Trays
- Made From 16 Gauge Steel



48" HD SITE SAFE

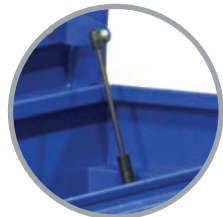

AUTO-LIFT SHOCKS

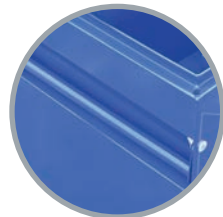

RETRACTABLE HANDLES



MULTI-FUNCTIONAL FEET



HIDEAWAY PADLOCK



REMOVABLE PARTS TRAYS

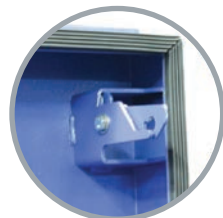

HAWKBILL LATCH & WEATHER STRIPPING

HD SITE SAFE JOBSITE BOX

DESCRIPTION	PART #	DIMENSIONS		
		L	W	H
NEW 60" HD Site Safe	37212272	60"	25½"	29"
NEW 48" HD Site Safe	37212273	48"	23"	29"
NEW 36" HD Site Safe	37212274	36"	17"	24"
NEW 60" HD Site Safe XL	37210269	60"	30"	46"



DROP FRONT DESIGN WITH HIGH QUALITY LIFT-ASSIST SHOCKS

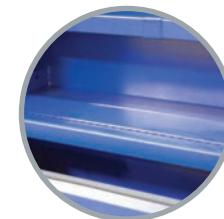

FOLDABLE CENTER SHELF



60" SITE SAFE XL

CASTER WHEEL KIT

Part# 29812062

Sold separately, the Caster Wheel Kit includes all necessary mounting hardware, supports up to 1100 lbs, and is comprised of two lockable rotating wheels and two stationary wheels.



Our new HD Headache Racks are the ideal solution for protecting your truck's cab and passengers from truck bed cargo damage, while simultaneously offering plenty of visibility from the rear window.



Cleat Tie-Downs compatible with Quantum™ Channel (sold separately)
PART# 29710693



QUANTUM SILVER HD HEADACHE RACK

GLOSS BLACK HD HEADACHE RACK

QUANTUM SILVER

GLOSS BLACK

HD HEADACHE RACKS

DESCRIPTION	PART #	
NEW HD Headache Rack: Chevrolet / Ford F-150 / GMC / Nissan / Toyota	QUANTUM SILVER	GLOSS BLACK
	29210697	29210735
NEW HD Headache Rack: Dodge Ram & Ford F-250 / F-350	29210699	29210736

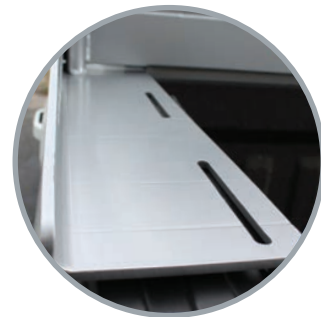

BEDRAIL MOUNTING SLOTS



QUANTUM™ CHANNEL



CENTER BRAKE LIGHT CUTOUT



REINFORCED GUARD

HD DRAWER BOXES

DESCRIPTION	ALUMINUM PART #	STEEL PART #	DIMENSIONS		
	MATTE BLACK	WHITE	L	W	H
HD SUV Drawer Box Short	76217121		28.5"	40"	23¼"
Truck Bed Drawer Box, Wide (4 Rows, 24 Dividers)		37210266	48"	40"	9"
Truck Bed Drawer Box, Tall (3 Rows, 18 Dividers)		37210267	48"	30"	12½"
Truck Bed Drawer Box, Tall & Wide (4 Rows, 24 Dividers)		37210268	48"	40"	12½"

HD SUV DRAWER BOX WITH TOP RAIL

The new and improved SUV Drawer Boxes incorporate many features requested by law enforcement and military personnel, making them suitable for both, as well as civilian use.



- Secure design prevents intrusion
- Top rails provide additional storage



WELL BUILT

"The drawer is smooth on egress and upon being pushed in."

- Cleo

HD TRUCK BED DRAWER BOXES

Our new HD truck bed drawer boxes are the perfect solution for plumbers, welders and any other profession that use small parts and tools on a daily basis, both on and off the jobsite.



- Removable dividers
- Locking T-handle latches
- 3 sizes to choose from



HD TRANSFER TANKS

DESCRIPTION	ALUMINUM PART #	STEEL PART #		DIMENSIONS		
		WHITE	BLACK	L	W	H
200 Gallon Rectangle Storage Tank		37224244		62"	28"	28"
150 Gallon Rectangle Storage Tank		37224243		48"	28"	28"
100 Gallon Rectangle Transfer Tank	37024151	29224164	29211677	45¼"	24"	24"
100 Gallon L-Shape Transfer Tank	37024149	29224167	29211581	60"	31"	29"
98 Gallon T-Top Transfer Tank		29221497	29222000	60"	33"	25"
88 Gallon L-Shape Transfer Tank	37024150	29224163	29211579	54¼"	31"	24"
75 Gallon L-Shape Transfer Tank	37024158			48¼"	31"	24"
75 Gallon L-Shape Transfer Tank (Steel Only)		29224162	29211580	42¾"	31"	24"
75 Gallon Combo Transfer Tank	37024159			48¼"	31"	24"
75 Gallon Combo Transfer Tank (Steel Only)		29224168	29211676	42¾"	31"	24"
50 Gallon Square Transfer Tank	37024152	29224165	29211583	24"	24"	24"
42 Gallon L-Shape Transfer Tank		29224095	29224100	27"	31"	24"
36 Gallon Vertical Transfer Tank	37024153	29224166	29211584	45¼"	11"	17"
NEW 62 Gallon Two-Lid Combo Tank			37224249	48"	30"	24"

75 GALLON COMBO TRANSFER TANK

50 GALLON SQUARE TANK



100 GALLON RECTANGLE TANK

36 GALLON VERTICAL TANK



75 GALLON ALUMINUM L-TANK

HEAVY DUTY TRANSFER TANKS

FEATURES

- Easy Transport of Non-Flammable liquid
- Overfill Restriction/Automatic Shutoff
- Constructed of Extra Heavy Weight Tread Plate Aluminum or 14 Gauge Steel
- Lockable Cap and Coupler
- Flush Mounted Dual 2" Reinforced Bungs

- Reinforced Pump Mounting Location
- Fully Welded Mounting Brackets
- Includes a Mounting Kit
- Baffles Add Strength While Preventing Contents From Shifting



BRITE UNCOATED

BLACK STEEL

WHITE STEEL

VERY HAPPY

"It was very easy to install, the black is perfect match for my truck. I could not be happier with the product!"

- Dennis
Ventura, CA



91 GALLON T-TOP TANK



62 GALLON TWO-LID COMBO TANK

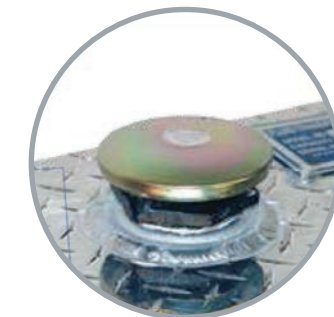

LOCKABLE CAP



MOUNTING KIT INCLUDED



This tank **DOES NOT MEET** Department of Transportation regulations for flammable fuels (such as gasoline).

These transfer tanks are designed and manufactured to be used as a liquid transfer tank **ONLY**. These are **SOLELY FOR PRIVATE USE** and not for interstate commerce or commercial applications. These are **NOT** designed for use as an auxiliary fuel tank to be connected to your vehicle's primary fuel system. Their intended use and design **DOES NOT** meet Title 49 of the U.S. Federal Register, governing transportation. These tanks **MUST BE VENTED AT ALL TIMES** to allow for expansion and to prevent any vacuum formation during liquid removal. These Liquid Transfer Tanks are intended for use with combustible fuels only (such as diesel fuels). These tanks **DO NOT MEET** Department of Transportation regulations for flammable fuels (such as gasoline).



ALL TANKS ARE 100% QUALITY INSPECTED WITH DUAL PRESSURE AND LEAK TESTS.

ACCESSORIES & GEAR



Grip-Rite® Mounting Kit 29510402

Don't drill holes in your truck. Use our Grip-Rite truck box mounting system to install your truck tool box without damaging your truck bed.

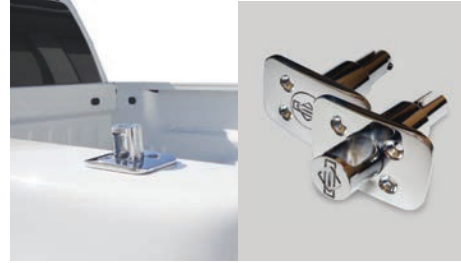

Stake Pocket Pop-Up 29910008

Removable clamping tie down anchor includes adjustable tie down straps to secure loads. Easy to install/remove without harming truck body or finish.

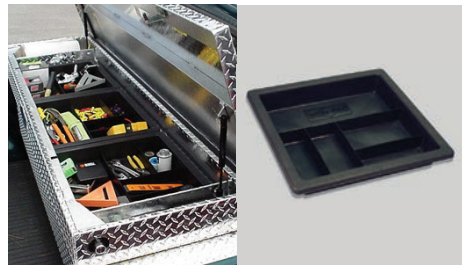

5 Pocket Organizer Tray 23512470

Made of durable plastic, the 5 Pocket Tray is great for keeping small items organized and easily accessible. Fits most major brands of truck boxes.



Diamond-Brite® Polish 29810184

Give your truck box a showroom shine, and keep it looking great for years to come. Also works great on any non-coated metal material. 8 oz.



Truck Box Mat 29410017

Keep your items from sliding around in your truck box. This liner has a soft finish to protect your items from damage. Can be cut to fit any size box.



Cleat Tie-Down Kit 29710693

Easily mounts onto any truck box. Provides a durable cleat tie-down for attaching rope or bungee cord. Made from durable, rust-proof cast aluminum powder coated finish.



LED Truck Box Light 29510016

Bright white LED truck tool box light comes with three settings, and attaches with a magnet or with a clip. Requires 3 AA Batteries (not included).

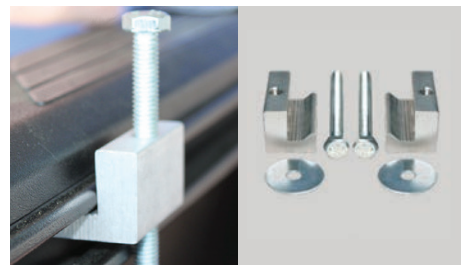

Toyota Mounting Kit 24201631

No drill, easy installation for your Better Built box. For Toyota trucks featuring the Toyota Track System only. For all others, please use the Grip-Rite kit.

ADDITIONAL GEAR

DESCRIPTION	PART #	AVAILABLE SIZES	DIMENSIONS
Navy Blue Drink Koozie	86835014		
Royal Blue Drink Koozie	86835015		
Tote Bag	86835018		
Cooler Bag	86835062		
Visor	86835010		
Blue Cap	86835011		
Two-Tone Baseball Cap, Navy Blue / White	86835012		
Two-Tone Baseball Cap, Khaki / White	86835013		
Polo (available in White, Heather Grey, Light Blue, Navy or Black)	See website	S / M / L / XL / XXL	
"Worktruck" T-Shirt	See website	S / M / L / XL / XXL	
"Fishing" T-Shirt, White	See website	S / M / L / XL / XXL	
SEC Counter Mat	86835052		24" x 15"
"Fishing" Banner	86835016		24" x 48"
"Logo" Banner (not pictured)	86835017		24" x 48"



Koozies



Hats & Visors



Tote Bags



Polos



T-Shirts



Cooler Bags



Counter Mats & Banners