

Table of Contents



Guide to using the catalog:

SoffSeal's catalog is divided into sections by **Make** and **Model**. Listed first in alphabetical order are the GM sections, then Performance Chrysler, followed by Ford, Street Rod and Universal. Each section is divided by Make, and for larger lines, Make and Model. The products are grouped by product type and sorted by years. So if you are looking for **door weatherstrips** for a **1957 Chevy Bel Air**, you would start with Chevrolet section, then navigate to the Bel Air section. Lastly, you would look for **product code "D"** for door related items, then find your year.

Code	What this includes
B	SoffSeal™ offers a wide variety of bumper and grommet sets to eliminate rattles and properly adjust components in your vehicle.
C	Glass channels and gaskets are one of the most important elements in weatherproofing your vehicle. Proper installation of glass channels or "windshield gaskets" will seal the elements out and your comfort in!
D	Installing door weatherstripping is a crucial step in weatherproofing your vehicle. Door weatherstripping eliminates rattles, wind noise, and prevents water damage.
E	SoffSeal offers a wide variety of universal extrusion for your custom project. Our selection includes both adhesive backed and metal grip for a variety of applications.
G	When finishing your vehicle, items not to be overlooked are the seals, gaskets and gasket kits . Genuine SoffSeal™ brand seals and gaskets are simple to install, inexpensive replacement parts that are necessary for a great finish!
H	SoffSeal offers a vast array of items to finish off your engine compartment. Genuine SoffSeal™ brand Under hood items are manufactured from the finest materials available and are backed by a lifetime warranty against manufacturers defects.
I	Finishing details are what makes the difference! Genuine SoffSeal™ brand interior parts are true to original and add that finishing touch to your vehicle's interior.
M	There are many miscellaneous items that are often overlooked but necessary for completing your project. Genuine SoffSeal™ brand items are vital for finishing your vehicle. Finishing details are what makes the difference!
N	SoffSeal's universal body mounts offer solutions for your projects.
P	SoffSeal's universal rubber bumpers are offered in an array of sizes for your metal and fiberglass applications. They protect your vehicle from vibration damage, eliminate rattles and properly adjust components in your vehicle.
R	Roofrail, Pillar post and Convertible weatherstripping is easily installed along the roofline of your car. Installing roofrail weatherstripping will eliminate wind noise and prevent water damage.
T	Trunk related items eliminate rattles, prevents water damage, and give your car a factory fresh look.
W	Often overlooked items are window related . <u>Window weatherstripping seals out the elements, eliminates rattles, and wind noise.</u>
Z	SoffSeal offers weatherstripping kits for many vehicles. You will find mini kits which include door, trunk and roofrail weatherstrips, as well as complete kits which include everything you will need from door weatherstrips to bumper kits.

Table of Contents

General Fit Miscellaneous.....	4	Chevrolet • Chevelle	137	Pontiac • Firebird	305
Application Tips.....	4	Chevrolet • Chevy II, Nova.....	155	Pontiac • Grand Am.....	316
Buick • Apollo	5	Chevrolet • Corvair	167	Pontiac • Grand Prix.....	317
Buick • Centurion	7	Chevrolet • Corvette	169	Pontiac • Grand Safari, Safari	321
Buick • Century	9	Chevrolet • Del Ray	172	Pontiac • Grand Ville	327
Buick • Electra.....	11	Chevrolet • El Camino.....	174	Pontiac • LeMans, GTO, Tempest	329
Buick • Estate & Roadmaster	19	Chevrolet • Impala	183	Pontiac • Parisienne	341
Buick • Invicta.....	21	Chevrolet • Malibu	211	Pontiac • Star Chief	343
Buick • LeSabre.....	25	Chevrolet • Monte Carlo.....	213	Pontiac • Sunbird, Sunfire.....	351
Buick • Park Avenue.....	36	Chevrolet • Monza, Vega, Beretta, Corsica, Lumina.....	219	Pontiac • Ventura	352
Buick • Regal	37	Chevrolet • Nomad.....	220	Performance Chrysler • Dodge, Plymouth.....	356
Buick • Riviera	39	Chevrolet • Yoeman.....	227	Ford • Mustang	376
Buick • Skyhawk.....	41	Chevrolet GM GMC • Truck, Van, SUV	228	Ford Taurus • Mercury Sable.....	378
Buick • Skylark & Gran Sport.....	42	Oldsmobile • 88, 98	241	Ford • Trucks, Vans, SUV.....	379
Buick • Wildcat.....	51	Oldsmobile • Custom Cruiser, Vista Cruiser	252	Street Rods & Customs	384
Cadillac • All Models	57	Oldsmobile • Cutlass, 442.....	254	Universal Items • Extrusion.....	406
Chevrolet • Bel Air.....	69	Oldsmobile • Starfire, Toronado	264	Universal Items • Bumpers	424
Chevrolet • Biscayne.....	94	Oldsmobile • Omega	268	Universal Items • Body Mounts	435
Chevrolet • Brookwood, Kingswood.....	107	Pontiac • Astre, Phoenix	270	Order Form	437
Chevrolet • Camaro	109	Pontiac • Bonneville	272	Shipping & Returns	438
Chevrolet • Caprice.....	127	Pontiac • Catalina.....	286	Catalog Notes.....	439
Chevrolet • Cavalier	136	Pontiac • Chieftain.....	298		

Body Style Information

Important Cowl Tag Information

A typical cowl tag of the 50's-60's is shown above. We suggest you always have these numbers when trying to service Chevrolet, Pontiac, Oldsmobile, Buick and Cadillac cars. With these numbers, we can tell you if the parts will interchange.

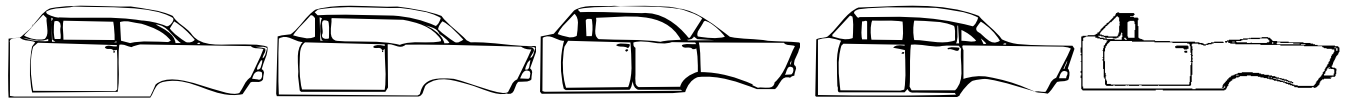
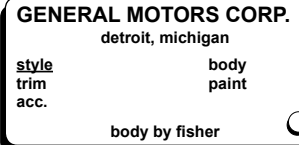

**TWO DOOR
SEDAN**

**TWO DOOR
HARDTOP**

**FOUR DOOR
HARDTOP**

**FOUR DOOR
SEDAN**

CONVERTIBLE

Hardtop/Sedan Body

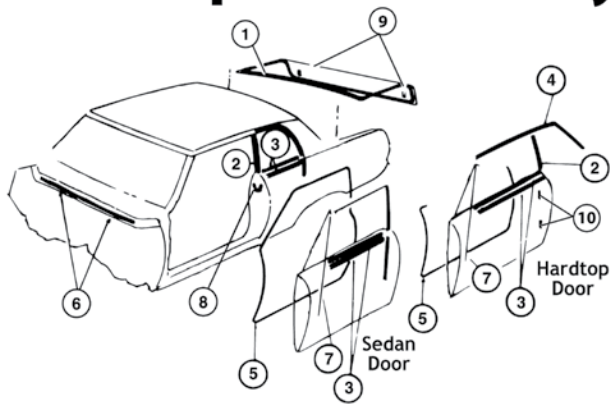

- | | |
|-----------------------|-----------------------------------|
| 1) Trunk w/strip | 6) Hood to cowl seal |
| 2) Qtr window seal | 7) Front window glass run channel |
| 3) Window w/strip kit | 8) Qtr window u-jambs |
| 4) Roofrail w/strip | 9) Trunk Bumpers |
| 5) Door w/strip | 10) Door bumpers |

Convertible Body

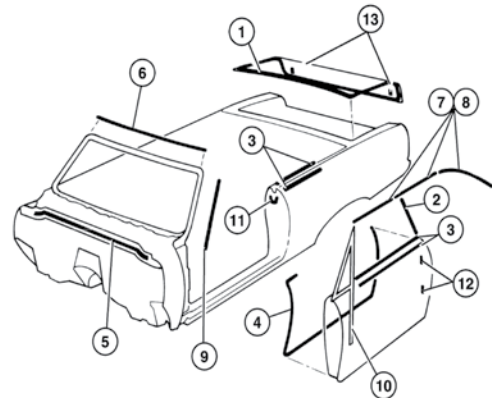

- | | |
|--------------------------------|------------------------------------|
| 1) Trunk w/strip | 7-8) Convertible top w/strip kit |
| 2) Qtr window seal | 9) Pillar post w/strip |
| 3) Window w/strip kit | 10) Front window glass run channel |
| 4) Door w/strip | 11) Qtr window u-jamb |
| 5) Hood to colw seal | 12) Door bumpers |
| 6) Convertible top header seal | 13) Trunk bumpers |

Street Rod Body

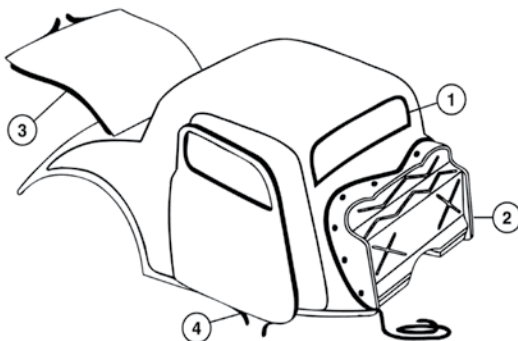

- 1) Window w/strip
- 2) Hood to cowl seal
- 3) Trunk w/strip
- 4) Door weatherstrip

Truck Body

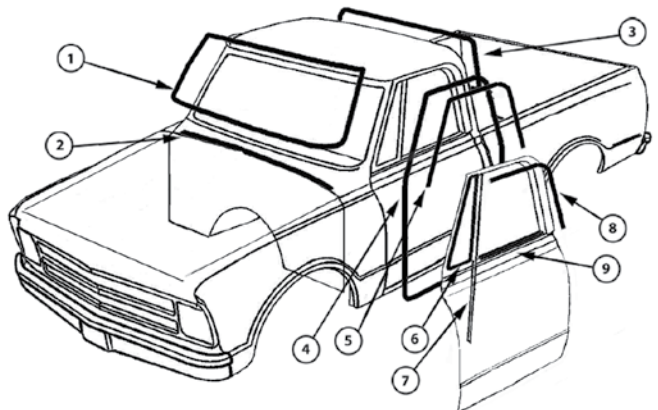

- | | |
|--------------------------------|------------------------|
| 1) Front glass channel | 6) Vent window w/strip |
| 2) Hood to cowl seal | 7) Division bar |
| 3) Rear glass channel | 8) Window run channel |
| 4) Door w/strip (fits on cab) | 9) Window felts |
| 5) Door w/strip (fits on door) | |

TYPICAL WEATHERSTRIP INSTALLATION TIPS

Installing **door weatherstripping** is a crucial step in weatherproofing your vehicle. Door weatherstripping eliminates rattles, wind noise, and prevents water damage.



- Remove the phillips screws (or black clips) that holds the old door weatherstrip in place.
- Pull out the old weatherstrips and remove nylon pins.
- Using firm thumb pressure, the molded end snaps right into place.
- The tool attached white nylon pins will line up perfectly and hold tight.
- Apply a very small bead of adhesive between pin holes.

Note: Look for CODE "D" when browsing the catalog for Door related weatherstripping.

Roofrail, Pillar post and Convertible weatherstripping is easily installed along the roofline of your car. Installing roofrail weatherstripping will eliminate wind noise and prevent water damage.

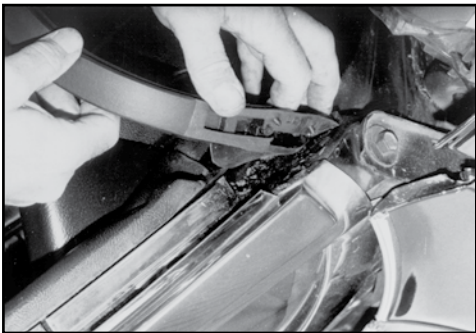

- Pop out the old black plastic anchor plugs with a screwdriver or needle-nose pliers.
- Pull out the old weatherstripping and clean the channel. The molded end snaps into place with firm thumb pressure.
- After you have applied a thin bead of glue, the rest of the weatherstrip will snap into place quickly and easily. Push 1 1/2-2" of excess length inside roof and quarter panel.

Note: Look for CODE "R" when browsing the catalog for Roofline related weatherstripping.

Often overlooked items are **window related**. Quarter Window weatherstripping seals out the elements, eliminates rattles, and wind noise.



- Remove the phillips screw that holds the old weatherstrip or U-shape rubber jamb in place.
- Using pliers, slide the old weatherstripping out.
- Apply soap or light oil to ease sliding, and clean out channel.
- Slide the new weatherstripping up into place in the channel.
- Replace the quarter window U-jamb.

Note: Look for CODE "W" when browsing the catalog for Window related weatherstripping.

Trunk weatherstrips and related items eliminate rattles, prevents water damage, and give your car a factory fresh look.



- Use a release agent, then a scraper to remove old trunk weatherstrip and glue residue. We recommend doing this before painting your car.
- After trunk groove is cleaned (and painted, if applicable), run a very small bead of weatherstrip adhesive in the groove.
- Take note of the shape of the cutaway edge of the weatherstrip illustrated. Be sure you lay in the strip correctly, according to the drawing.
- Snap the new weatherstrip into place.

Note: Look for CODE "T" when browsing the catalog for Trunk related weatherstripping.



General Fit Miscellaneous

CODE	IMAGE	YEAR	DESCRIPTION	BODY	FITS	ITEM#
M		00-99	Rubber hole plug 3/8 inch, used on floor, firewall & trunk	ALL BODY STYLES	All Makes And Models	0180
M		00-99	Rubber hole plugs 1/2 inch, used on floor, firewall & trunk	ALL BODY STYLES	All Makes And Models	0181
M		00-99	Rubber hole plug 5/8 inch, used on floor, firewall & trunk	ALL BODY STYLES	All Makes And Models	0182
M		00-99	Rubber hole plug 3/4 inch, used on floor, firewall & trunk	ALL BODY STYLES	All Makes And Models	0183
M		00-99	Rubber hole plug 7/8 inch, used on floor, firewall & trunk	ALL BODY STYLES	All Makes And Models	0184
M		00-99	Rubber hole plug 1 inch used on floor, firewall & trunk	ALL BODY STYLES	All Makes And Models	0185
M		00-99	Rubber hole plug 1 1/4 inch, used on floor, firewall & trunk	ALL BODY STYLES	All Makes And Models	0186
M		00-99	Window weld ribbon sealer 3/8 inch round	ALL BODY STYLES	All Makes And Models	08622
M		00-99	Black weatherstrip adhesive	2DR 4DR SDN HTP CNV	All Makes And Models	3M08008
M		00-99	Preservative for automotive plastic rubber & vinyl	ALL BODY STYLES	All Makes And Models	BOSSGLOSS
M		00-99	Soffseal heat & sound insulation 4ft x 6ft x 1/2 in thick aluminum heat barrier on one side	ALL BODY STYLES	All Makes And Models	INSUL1
M		00-99	Sticky stuff spray adhesive for heat & sound	ALL BODY STYLES	All Makes And Models	INSULADH
M		00-99	Seam tape for heat & sound insulation 2 in x 30 ft roll	ALL BODY STYLES	All Makes And Models	INSULTAPE

Using the proper tools during your installation of SoffSeal quality weatherstripping is essential for a smooth, easy application!



GUIDE TO SOFFSEAL'S PRODUCT CODES

B = Bumper sets **C** = Glass channels **D** = Door related **G** = Seals, gaskets **H** = Under hood items **I** = Interior parts
M = Miscellaneous items **R** = Roofrail, pillar post & convertible items **T** = Trunk related **W** = Window related **Z** = Weatherstrip kits







CODE	IMAGE	YEAR	DESCRIPTION	BODY	FITS	ITEM#
B		47-48-49-50-51-52-53-54-55-56-57-58-59-60-61-62-63-64-65-66-67-68-69-70-71-72-73-74-75-76-77-78-79-80-81-82-83-84-85-86-87	Glove box door bumpers	2DR 4DR HTP 2DR SDN CNV SWG TRK	All Chevrolet, Pontiac, Oldsmobile, Buick 47-87 Chevrolet, Gmc Truck	1069
D		68-69-70-71-72-73-74	Door weatherstrip with clips	2DR SDN	68-74 Nova 73-74 Apollo, Omega, 71-74 Ventura 2 Door Sedan	4020
D		68-69-70-71-72-73-74	Door weatherstrip front door with clips	4DR SDN	68-74 Nova 73-74 Buick Apollo, 73-74 Oldsmobile Omega, 71-74 Pontiac Ventura, 4 Door Sedan	4081
D		68-69-70-71-72-73-74	Door weatherstrip rear door with clips	4DR SDN	68-74 Nova 73-74 Buick Apollo, 73-74 Oldsmobile Omega, 71-74 Pontiac Ventura, 4 Door Sedan	4081A
D		75-76-77-78-79	Door weatherstrip front door with clips	4DR SDN	75-79 Chevy II Nova, 75 Buick Apollo, 76-79 Buick Skylark, 75-79 Oldsmobile Omega, 75-77 Pontiac Ventura, 78-79 Phoenix, 4 Door Sedan	40813
D		75-76-77-78-79	Door weatherstrip rear door with clips	4DR SDN	75-79 Chevy II Nova, 75 Buick Apollo, 76-79 Buick Skylark, 75-79 Oldsmobile Omega, 75-77 Pontiac Ventura, 78-79 Phoenix, 4 Door Sedan	40814
D		75-76-77-78-79	Door weatherstrip with clips	2DR SDN	75-79 Nova, 75 Apollo, 75-79 Oldsmobile Omega, 75-77 Pontiac Ventura, 77-79 Pontiac Phoenix 76-79 Buick Skylark, 2 Door Sedan	4024
H		ALL-MODELS-WHERE-APPLICABLE	Air cleaner lid seal, cut to fit	2DR 4DR HTP 2DR SDN CNV SWG	GM All	2099
I		64-65-66-67-68-69-70	Sun visor tip	2DR 4DR SDN HTP CNV	64-70 All Makes And Models	4006
M		00-99	Window weld ribbon sealer 3/8 inch round	ALL BODY STYLES	All Makes And Models	08622
M		67-68-69-70-71-72-73-74-75-76-77-78-79-80-81-82-83-84	Oil filler cap	2DR 4DR SDN HTP CNV	67-84 GM All Models	5044



WHAT IS A PRODUCT CODE?
 Our catalog is grouped by product CODE (type) then years. See page 1 for details explaining the different Product CODES.



Buick • Apollo

CODE	IMAGE	YEAR	DESCRIPTION	BODY	FITS	ITEM#
T		64-65-66-67-68-69-70-71-72-73-74-75-76-77	Trunk weatherstrip exact profile length 17 feet	2DR 4DR HTP 2DR SDN CNV	65-72 Chevy II, 65-72 Chevrolet Biscayne, 65-75 Chevrolet Bel Air, 65-76 Chevrolet Impala, 65-76 Chevrolet Caprice, 64-77 Chevrolet Chevelle, 70-77 Chevrolet Monte Carlo, 65-76 Buick LeSabre, 64-77 Buick Wildcat, 64-77 Buick Skylark, 71-73 Buick Centurion, 64-72 Buick Grand Special, 73-77 Buick Century, 73-88 Buick Regal, 73-88 Buick Grand National, 65-76 Buick Electra, 65-76 Oldsmobile Delta 88, 67-69 Oldsmobile Delmont 88, 65-66 Oldsmobile Dynamic 88, 65-66 Oldsmobile Starfire, 65 Oldsmobile Jetstar, 64-77 Oldsmobile Cutlass 442, 64-88 Oldsmobile Cutlass, 65-76 Oldsmobile 98, 65-76 Pontiac Parisienne, 64-72 Pontiac LeMans, 65-70 Pontiac Catalina, 65-66 Pontiac Star Chief, 67-70 Pontiac Executive, 71-75 Pontiac Grand Ville, 65-77 Pontiac Grand Prix, 64-72 Pontiac Tempest, 62-72 Nova, Ventura, 73-74 Non-Hatchback, Up to 1975 with groove channel, Apollo, Nova, Omega, Ventura 65-76 C-Body	2003
T		73-74	Hatchback weatherstrip	2DR CPE	73-74 Buick Apollo, Chevrolet Nova, Oldsmobile Omega, Pontiac Ventura, 2 Door Coupe	4013
T		75-76-77-78-79-80-81-82-83-84-85-86-87-88-89-90-91-92	Trunk and Hatchback weatherstrip	2DR 4DR SDN HTP CNV	77-85 Chevrolet Impala, 77-91 Chevrolet Caprice, 82-92 Chevrolet Camaro, 75-79 Chevrolet Nova, 78-88 Chevrolet Monte Carlo, 78-83 Chevrolet Malibu, 78-83 Pontiac LeMans, 82-92 Pontiac Firebird, 75-91 Pontiac Ventura, 77-86 Pontiac Parisienne, 77-81 Pontiac Catalina, 69-88 Pontiac Grand Prix, 64-87 Pontiac LeMans, Pontiac Grand Am, 64-77 Pontiac GTO, 73-79 Oldsmobile Omega, 77-85 Oldsmobile Delta 88, 77-84 Oldsmobile 98, 77-88 Oldsmobile Cutlass, 73-75 Buick Apollo, 76-79 Buick Skylark, 77-79 Phoenix, 73-88 Buick Regal, 77-84 Buick Electra, 77-85 Buick LeSabre, 77-78 Buick Riviera, 77-91 C-Body	2424
W		37-38-39-40-41-42-43-44-45-46-47-48-49-50-51-52-53-54	Mohair channel liner, 4 feet of 2 7/8 inch mohair lining material	CNV 2DR 4DR HTP	Bel Air 150 210, Nomad, Chieftain, 860/870 Star Chief, Safari, Super Chief, Bonneville, Nova, Omega, Apollo, Ventura, Skylark	0420



GUIDE TO SOFFSEAL'S PRODUCT CODES



B = Bumper sets **C** = Glass channels **D** = Door related **G** = Seals, gaskets **H** = Under hood items **I** = Interior parts
M = Miscellaneous items **R** = Roofrail, pillar post & convertible items **T** = Trunk related **W** = Window related **Z** = Weatherstrip kits



CODE	IMAGE	YEAR	DESCRIPTION	BODY	FITS	ITEM#
D		71-72-73-74	Door weatherstrip rear door with clips & molded ends	4DR HTP	71-74 Chevrolet Caprice, Impala, Buick LeSabre, Centurion, Oldsmobile 88, Pontiac, 4 Door Hardtop	2214
D		71-72-73-74-75-76	Door weatherstrip front doors with clips & molded ends	4DR HTP	71-76 Chevrolet Caprice, Impala, Buick, Electra, LeSabre, Centurion, Cadillac Calais, Deville, Oldsmobile 88 Oldsmobile 98, Catalina, Bonneville, Granville, 4 Door Hardtop	2213
D		71-72-73-74-75-76	Door weatherstrip with clips & molded ends	2DR HTP CNV	71-76 Chevrolet Impala, Caprice, Cadillac Calais, Deville, Buick 71-73 LeSabre, Centurion, Electra, 74-76 LeSabre, Electra, Oldsmobile 88 Oldsmobile 98, Pontiac Bonneville, Catalina, 71-75 Grandville 2 Door Hardtop Convertible	2512
D		75-76	Rear Door weatherstrip with clips & molded ends	4DR HTP	75-76 Chevrolet Impala, Caprice, Buick, LeSabre, Centurion, Oldsmobile 88, Pontiac, 4 Door Hardtop	2216
H		71-72-73-74-75-76-77-78	Hood to cowl seal	2DR SDN 2DR HTP CNV SWG	71-78 Chevrolet Impala, Caprice, Biscayne, Bel Air, Brookwood, Townsman, Kingswood, Buick Lesabre, Centurion, Electra 225, Estate Wagon, Cadillac Calais, Deville, Eldorado, Sixty Special Brougham, Oldsmobile 88, 98, Tornado, Pontiac Catalina, Bonneville, Grandville, Safari Full Size	2191
I		64-65-66-67-68-69-70-71-72-73-74	Park brake pedal pad	2DR HTP CNV	El Camino Cutlass Chevelle Chevy II Camaro Firebird LeMans Tempest GTO Grand Prix Full Size Centurion Century Electra Invicta LeSabre Regal Riviera Skylark Wildcat Monte Carlo	3094
R		71-72-73-74	Roofrail weatherstrip	4DR HTP	71-74 Chevrolet Caprice, Impala, Buick LeSabre, Centurion, Oldsmobile 88, Pontiac Catalina, Bonneville 4 Door Hardtop	2221
R		71-72-73-74-75-76	Pillar post weatherstrip with molded ends	CNV	71-75 Chevrolet Impala, Caprice 71-72 Oldsmobile 88, 71-75 Pontiac Catalina, Grandville, 71-75 Buick Lesabre, Centurion 71-76 Cadillac Eldorado, Convertible	2094
R		71-72-73-74-75-76	Weatherstrip kit for convertible top	CNV	71-72 Chevrolet Impala, 73-76 Caprice, 71-76 Cadillac Eldorado, 71-75 Oldsmobile Delta 88, 71, 72, 74 Buick LeSabre 71-73 Centurion, 71-72 Pontiac Catalina, 71-75 Grandville Convertible	2508
R		71-72-73-74-75-76	Header seal	CNV	71-75 Chevrolet Impala, Caprice, 71-72 Oldsmobile 88, 71-75 Pontiac Catalina, Grandville, 71-75 Buick Lesabre, Centurion, 71-76 Cadillac Eldorado, Convertible	2515

Buick • Centurion

BUICK • Centurion

CODE	IMAGE	YEAR	DESCRIPTION	BODY	FITS	ITEM#
T		64-65-66-67-68-69-70-71-72-73-74-75-76-77	Trunk weatherstrip exact profile length 17 feet	2DR 4DR HTP 2DR SDN CNV	65-72 Chevy II, 65-72 Chevrolet Biscayne, 65-75 Chevrolet Bel Air, 65-76 Chevrolet Impala, 65-76 Chevrolet Caprice, 64-77 Chevrolet Chevelle, 70-77 Chevrolet Monte Carlo, 65-76 Buick LeSabre, 64-77 Buick Wildcat, 64-77 Buick Skylark, 71-73 Buick Centurion, 64-72 Buick Grand Special, 73-77 Buick Century, 73-88 Buick Regal, 73-88 Buick Grand National, 65-76 Buick Electra, 65-76 Oldsmobile Delta 88, 67-69 Oldsmobile Delmont 88, 65-66 Oldsmobile Dynamic 88, 65-66 Oldsmobile Starfire, 65 Oldsmobile Jetstar, 64-77 Oldsmobile Cutlass 442, 64-88 Oldsmobile Cutlass, 65-76 Oldsmobile 98, 65-76 Pontiac Parisienne, 64-72 Pontiac LeMans, 65-70 Pontiac Catalina, 65-66 Pontiac Star Chief, 67-70 Pontiac Executive, 71-75 Pontiac Grand Ville, 65-77 Pontiac Grand Prix, 64-72 Pontiac Tempest, 62-72 Nova, Ventura, 73-74 Non-Hatchback, Up to 1975 with groove channel, Apollo, Nova, Omega, Ventura 65-76 C-Body	2003
W		71-72-73-74-75-76	Quarter window seals	2DR HTP CNV	71-75 Chevrolet Impala, Caprice, 71-76 Cadillac Eldorado Convertible Only, 71-76 Oldsmobile 88, 76 Oldsmobile 98, 71-73 Buick LeSabre, 71-73 Centurion, 71-75 Pontiac Catalina, Bonneville, Grandville 2 Door Hardtop Convertible	2308





GUIDE TO SOFFSEAL'S PRODUCT CODES

B = Bumper sets **C** = Glass channels **D** = Door related **G** = Seals, gaskets **H** = Under hood items **I** = Interior parts
M = Miscellaneous items **R** = Roofrail, pillar post & convertible items **T** = Trunk related **W** = Window related **Z** = Weatherstrip kits



CODE	IMAGE	YEAR	DESCRIPTION	BODY	FITS	ITEM#
B		47-48-49-50-51-52-53-54-55-56-57-58-59-60-61-62-63-64-65-66-67-68-69-70-71-72-73-74-75-76-77-78-79-80-81-82-83-84-85-86-87	Glove box door bumpers	2DR 4DR HTP 2DR SDN CNV SWG TRK	All Chevrolet, Pontiac, Oldsmobile, Buick 47-87 Chevrolet, Gmc Truck	1069
B		69	License panel bumpers rear	2DR 4DR SDN HTP CNV	69 Chevrolet Camaro, Pontiac Firebird, 64-72 Chevrolet Chevelle, Pontiac Tempest, LeMans, GTO, Grand Prix, Oldsmobile Cutlass, Buick Special, Skylark	31151
D		55-56-57-58-59-60	Door weatherstrip with clips sedan front and rear	2DR 4DR SDN SWG	55-60 Chevrolet Bel Air 150 210, Nomad, Pontiac Chieftain, Star Chief, Safari, Super Chief, Bonneville, Buick Century, Roadmaster, Special Also Station Wagon And Sedan Delivery	1003
D		58	Door weatherstrip with clips & molded ends	2DR HTP CNV	58 Chevrolet Impala, Cadillac, Oldsmobile 88 Convertible Only, Buick Century Convertible Only, Pontiac, 2 Door Hardtop Convertible	2010
D		58	Door j weatherstrip	2DR 4DR HTP 2DR SDN CNV SWG	58 Chevrolet Del Ray, Biscayne, Bel Air, Impala, 58 Cadillac, 57-58 Oldsmobile 88 Oldsmobile 98, 57-58 Buick Special Century, Super, Roadmaster, 58 Pontiac	2044
D		73-74-75-76-77	Door weatherstrip with clips & molded ends	2DR HTP	Grand Am 2 Door 73-77 Chevrolet, LeMans, Grand LeMans, Century, Regal, Cutlass, Chevelle Malibu Laguna, El Camino, 2 Door Hardtop	5017
G		78-79-80-81-82-83-84-85-86-87	Rear side marker gasket	SWG	78-87 Chevrolet El Camino, Gmc Caballero, 78-83 Chevrolet Malibu Wagon, 82-83 Pontiac Bonneville Wagon, 78-81 Pontiac LeMans Wagon, Oldsmobile Cutlass Wagon, 82-86 Oldsmobile Cutlass 4 Door Except Fwd, 78-82 Buick Century Wagon, Station Wagon	5214
H		ALL-MODELS-WHERE-APPLICABLE	Air cleaner lid seal, cut to fit	2DR 4DR HTP 2DR SDN CNV SWG	GM All	2099
I		58	Gear shift grommet column	2DR 4DR SDN HTP CNV	58 Chevrolet Del Ray, Biscayne, Bel Air, Impala, Cadillac, Oldsmobile 88 Oldsmobile 98, Buick Special, Century, Roadmaster, Riviera, Pontiac	2185
I		64-65-66-67-68-69-70-71-72-73-74	Park brake pedal pad	2DR HTP CNV	El Camino Cutlass Chevelle Chevy II Camaro Firebird LeMans Tempest GTO Grand Prix Full Size Centurion Century Electra Invicta LeSabre Regal Riviera Skylark Wildcat Monte Carlo	3094
R		73-74-75-76-77	Roofrail weatherstrip	2DR HTP	73-77 Chevrolet Malibu, Pontiac LeMans, Grand Am, Buick Century, Oldsmobile Cutlass, 2 Door Hardtop	5035

Buick • Century

CODE	IMAGE	YEAR	DESCRIPTION	BODY	FITS	ITEM#
T		64-65-66-67-68-69-70-71-72-73-74-75-76-77	Trunk weatherstrip exact profile length 17 feet	2DR 4DR HTP 2DR SDN CNV	65-72 Chevy II, 65-72 Chevrolet Biscayne, 65-75 Chevrolet Bel Air, 65-76 Chevrolet Impala, 65-76 Chevrolet Caprice, 64-77 Chevrolet Chevelle, 70-77 Chevrolet Monte Carlo, 65-76 Buick LeSabre, 64-77 Buick Wildcat, 64-77 Buick Skylark, 71-73 Buick Centurion, 64-72 Buick Grand Special, 73-77 Buick Century, 73-88 Buick Regal, 73-88 Buick Grand National, 65-76 Buick Electra, 65-76 Oldsmobile Delta 88, 67-69 Oldsmobile Delmont 88, 65-66 Oldsmobile Dynamic 88, 65-66 Oldsmobile Starfire, 65 Oldsmobile Jetstar, 64-77 Oldsmobile Cutlass 442, 64-88 Oldsmobile Cutlass, 65-76 Oldsmobile 98, 65-76 Pontiac Parisienne, 64-72 Pontiac LeMans, 65-70 Pontiac Catalina, 65-66 Pontiac Star Chief, 67-70 Pontiac Executive, 71-75 Pontiac Grand Ville, 65-77 Pontiac Grand Prix, 64-72 Pontiac Tempest, 62-72 Nova, Ventura, 73-74 Non-Hatchback, Up to 1975 with groove channel, Apollo, Nova, Omega, Ventura 65-76 C-Body	2003
W		58	Window weatherstrip original style with round bead	CNV	58 Chevrolet Impala, 58 Cadillac, 58 Oldsmobile 88 Oldsmobile 98, 58 Buick Special, Century, Roadmaster, 58 Pontiac, Convertible	2038
W		58-59-60-61-62-63-64	Quarter window seals	2DR HTP CNV	58-64 Chevrolet Impala, 58, 60-62 Bel Air, 58-64 Cadillac Series 62, Deville, Eldorado, 58 Oldsmobile 88 Oldsmobile 98, 59-60 Oldsmobile 88 Oldsmobile 98, 61-64 Oldsmobile 99, Starfire, 98, 64 Jetstar, 59-62 Buick LeSabre, Invicta, Electra 2 Door Hardtop Convertible	2300



GUIDE TO SOFFSEAL'S PRODUCT CODES

B = Bumper sets **C** = Glass channels **D** = Door related **G** = Seals, gaskets **H** = Under hood items **I** = Interior parts
M = Miscellaneous items **R** = Roofrail, pillar post & convertible items **T** = Trunk related **W** = Window related **Z** = Weatherstrip kits



CODE	IMAGE	YEAR	DESCRIPTION	BODY	FITS	ITEM#
B		59-60	Vent window bumpers upper	2DR HTP	59-60 Chevrolet Bel Air, Impala Pontiac Catalina, Star chief Oldsmobile Dynamic 88, Super 88, 98, Cadillac Deville, Eldorado, Series 62, Buick Lesabre, Invicta, Electra Full Size 2 Door Hardtop	2202
B		61-62	Upper vent window bumper	CNV	61-62 Chevrolet Impala, Bel Air, Pontiac Catalina, Bonneville, Oldsmobile 88, 98, Buick LeSabre, Electra 225, Cadillac Deville Convertible	2088
B		63-64	Upper vent window bumpers	CNV	63-64 Impala, Bonneville, Catalina, Oldsmobile 88, 98, LeSabre, Electra 225, Deville, Convertible	2203
B		63-64	Vent window bumpers, upper	2DR 4DR HTP	63-64 Chevrolet Impala, 63-64 Cadillac, Deville, 63-64 Oldsmobile 88, 98, 63-64 Buick LeSabre, Electra, 63-64 Pontiac Bonneville, Catalina, 2 Door 4 Door Hardtop	2204
B		67-68-69-70	Door bumpers	2DR 4DR HTP 2DR SDN CNV SWG	67-70 Chevrolet Biscayne, Bel Air, Impala Caprice, 67-70 Cadillac Calais, Deville, Fleetwood, 67-70 Oldsmobile 88, 98, 67-70 Buick LeSabre, Wildcat, Electra, 67-70 Pontiac	2323
C		59-60	Glass channel	2DR 4DR HTP CNV	59-60 Chevrolet Bel Air, Impala, Cadillac Series 62, Deville, Eldorado, Oldsmobile 88 Oldsmobile 98, Buick LeSabre, Invicta, Electra, Pontiac Catalina, Star Chief, Bonneville 2 Door 4 Door Hardtop Convertible	2080
C		61-62	Glass channel front	2DR HTP	61 Chevrolet Impala, 62 Chevrolet Bel Air, 61 Cadillac Series 62, 62 Cadillac Deville 4 Door S, 61-62 Oldsmobile 88 Oldsmobile 98, 61 Buick LeSabre, Invicta, Electra, 62 Buick, 61-62 Pontiac Catalina, Ventura, Star Chief, Bonneville 2 Door Hardtop	2161
C		61-62	Glass channel front	CNV HT	62 Chevrolet, Pontiac, Oldsmobile, Buick, Cadillac Formal Roof Hardtop, 61-62 Convertible, 61 Pontiac, Oldsmobile, Buick, Cadillac Formal Roof Hardtop	2162
C		63-64	Windshield gasket	2DR SDN SWG	63-64 Chevrolet Biscayne, Bel Air, Impala, 63-64 Cadillac Series 62, Deville, 63-64 Oldsmobile 88 Oldsmobile 98, 63-64 Buick LeSabre, Wildcat, Electra, 63-64 Pontiac, 2 Door Sedan Station Wagon	2020
C		63-64	Glass channel front	2DR HTP CNV	63-64 Chevrolet Impala, 63-64 Cadillac, 63-64 Oldsmobile 88, Oldsmobile 98 Starfire Convertible Only, 63-64 Buick LeSabre, Wildcat, Electra, 63-64 Pontiac, 2 Door Hardtop Convertible	2021
D		59-60	Door weatherstrip with clips & molded ends	2DR HTP CNV	59-60 Chevrolet Impala, Bel Air, Pontiac Catalina, Star Chief, Bonneville, Oldsmobile 88, 98, Buick LeSabre, Invicta, Electra, Cadillac Deville, Eldorado, Series 62 Hardtop Convertible	2011

CODE	IMAGE	YEAR	DESCRIPTION	BODY	FITS	ITEM#
D		59-60	Door weatherstrip rear door with clips & molded ends	4DR HTP	59-60 Chevrolet Impala, Bel Air, Buick Electra, Invicta, LeSabre, Cadillac 62 Deville, Eldorado, Oldsmobile 98 Oldsmobile 99, 4 Door Hardtop	2206
D		61-62	Door weatherstrip, front doors	4DR HTP	61-62 Chevrolet Impala, Bel Air, Buick Electra, LeSabre, Invicta, Cadillac Series 60, Oldsmobile 88 Oldsmobile 98, 4 Door Hardtop	2207
D		61-62	Door weatherstrip with clips & molded ends	2DR HTP CNV	61-62 Chevrolet Bel Air Impala, Cad Series 62, Deville, 61-62 Oldsmobile, 61 Hardtop Convertible 88 Star Fire, Oldsmobile 98/62 Oldsmobile 88 Oldsmobile 98 Starfire, 61-62 Buick 61 Hardtop Convertible, 62 Convertible Only LeSabre Invicta Electra, 61-62 Pontiac, 2 Door Hardtop Convertible	2013
D		61-62-63-64	Door weatherstrip rear door with clips	4DR SDN	61-64 Chevrolet Biscayne Bel Air Impala, 61-64 Oldsmobile 88, 98, 61-62 Cadillac, 61-64 Buick LeSabre Electra, 64 Wildcat, 61-64 Pontiac Catalina, Star Chief, 4 Door Sedan	2009
D		63-64	Door weatherstrip with clips & molded ends	2DR HTP CNV	63-64 Chevrolet Impala, 63-64 Cadillac Eldorado, Deville, 63-64 Oldsmobile 88 Oldsmobile 98 Starfire 63-64 Buick LeSabre Wildcat, Electra 63 Invicta, 63-64 Pontiac Catalina, Bonneville, Grand Prix, 2 Door Hardtop Convertible	2014
D		63-64	Front door weatherstrip with molded ends	4DR HTP	63-64 Chevrolet Biscayne, Bel Air, Impala, Buick Wildcat, Lesabre, Electra, Pontiac Catalina, Star Chief, Bonneville, Oldsmobile Dynamic 88, 98 4 Door Ht	2121
D		65-66	Door weatherstrip with clips & molded ends	2DR HTP CNV	65-66 Chevrolet Impala, Caprice, 65-66 Cadillac Calais, Deville, 65-66 Oldsmobile 88, Starfire, Oldsmobile 98, 65 Jet Star, 65-66 Buick LeSabre, Wildcat Electra, 65-66 Pontiac 2 Door Hardtop Convertible	2331
D		67-68	Front door weatherstrip with clips	4DR SDN SWG	67-68 Chevrolet Biscayne, Bel Air, Impala, 67-68 Cadillac Calais, Deville, Fleetwood, 67-68 Oldsmobile Delmont 88, Delta 88, 98, 67-68 Buick LeSabre, Wildcat, Electra 67-68 Pontiac Catalina, Executive, Bonneville, 4 Door Sedan Station Wagon	23321
D		67-68	Door weatherstrip with clips & molded ends	CNV 2DR HTP	67-68 Chevrolet Impala, Caprice, Except 68 Caprice 2 Door Hardtop, 67-68 Cadillac Calais, Deville, 67-68 Oldsmobile 88 Oldsmobile 98, 67-68 Buick Electra, Wildcat, 67 Pontiac Catalina, Bonneville, Executive, 67 Grand Prix Convertible 2 Door Hardtop	2342
D		69-70	Door weatherstrip with clips & molded ends	2DR HTP CNV	69-70 Chevrolet Impala, Caprice, 69-70 Cadillac Calais, Deville, 69-70 Oldsmobile 88 Oldsmobile 98, 69-70 Buick LeSabre, Wildcat, Electra, 69-70 Pontiac Catalina, Bonneville, Executive, 2 Door Hardtop Convertible	2357



GUIDE TO SOFFSEAL'S PRODUCT CODES

B = Bumper sets **C** = Glass channels **D** = Door related **G** = Seals, gaskets **H** = Under hood items **I** = Interior parts
M = Miscellaneous items **R** = Roofrail, pillar post & convertible items **T** = Trunk related **W** = Window related **Z** = Weatherstrip kits



CODE	IMAGE	YEAR	DESCRIPTION	BODY	FITS	ITEM#
D		71-72-73-74-75-76	Door weatherstrip with clips & molded ends	2DR HTP CNV	71-76 Chevrolet Impala, Caprice, Cadillac Calais, Deville, Buick 71-73 LeSabre, Centurion, Electra, 74-76 LeSabre, Electra, Oldsmobile 88 Oldsmobile 98, Pontiac Bonneville, Catalina, 71-75 Grandville 2 Door Hardtop Convertible	2512
D		71-72-73-74-75-76	Door weatherstrip front doors with clips & molded ends	4DR HTP	71-76 Chevrolet Caprice, Impala, Buick, Electra, LeSabre, Centurion, Cadillac Calais, Deville, Oldsmobile 88 Oldsmobile 98, Catalina, Bonneville, Granville, 4 Door Hardtop	2213
D		71-72-73-74-75-76	Door weatherstrip rear	4DR HTP	71-76 Buick Electra, Oldsmobile 98, 4 Door Hardtop	2215
D		77-78-79-80-81-82-83-84-85-86	Front door weatherstrip with clips	4DR SDN RWD	77-86 Impala Caprice, 77-84 Cadillac Deville Fleetwood, 85-86 Fleetwood, 77-84 Oldsmobile 88 89, 85 88, 77-84 Buick LeSabre Electra 85 LeSabre, 77-79 Buick Estate Wagon, 82-83 Buick Park Ave 77-81 Pontiac Bonneville, 83-86 Pontiac Parisienne, 77-80 Pontiac Catalina 4 Door Sedan, RWD Only	2500
D		77-78-79-80-81-82-83-84-85-86-87	Door weatherstrip with clips	2DR SDN RWD	84-87 Chevrolet Caprice, 77-81 Chevrolet Impala, 83 Chevrolet, 77-84 Cadillac Deville, 80-84 Fleetwood, 77-84 Oldsmobile 88 Oldsmobile 98, 85 Oldsmobile 88, 77-84 Buick LeSabre, Electra, 85 LeSabre, 77-81 Pontiac Bonneville, Catalina 2 Door Sedan, RWD Only	2359
D		77-78-79-80-81-82-83-84-85-86-87-88-89-90	Door weatherstrip rear door with clips	4DR SDN RWD	77-90 Chevrolet, 77-90 Cadillac Fleetwood, 77-84 Oldsmobile 98, 77-84 Buick Electra, Park Avenue 77-90 Pontiac, 4 Door Sedan, RWD Only	23591
D		77-78-79-80-81-82-83-84-85-86-87-88-89-90	Rear door weatherstrip with clips	4DR SDN RWD	77-86 Chevrolet Impala Caprice, 87-88 Caprice Caprice Classic, 89 Caprice, 90 Caprice Caprice Classic, 77-84 Cadillac Deville, 77-85 Oldsmobile 88, 77-78 Town Sedan, Custom Crusier, 77-84 Buick LeSabre Electra 85 LeSabre, 77-81 Pontiac Bonneville, Catalina, 83-86 Pontiac Parisienne 4 Door Sedan, RWD Only	2502
D		85-86-87-88-89-90	Door weatherstrip rear with clips	SWG FWD	85-90 Buick Electra, Oldsmobile 98, Station Wagon, FWD	2601
D		85-86-87-88-89-90	Door weatherstrip rear with clips	4DR SDN FWD	85-90 Buick Park Avenue, Electra, Oldsmobile 98, 4 Door Sedan Fwd	2606
D		85-86-87-88-89-90-91	Door weatherstrip front with clips	4DR SDN FWD SWG	85-91 Buick Electra, Oldsmobile 98, 86-91 Buick LeSabre, Oldsmobile 88, 87-91 Pontiac Bonneville, 85-90 Park Avenue, 4 Door Sedan Fwd Station Wagon	2605
D		86-87-88-89-90-91	Door weatherstrip with clips	2DR SDN FWD	86-91 Buick Regency LeSabre 85-87 Electra 86-91 Old Delta 88, 2 Door Sedan, FWD	2604

CODE	IMAGE	YEAR	DESCRIPTION	BODY	FITS	ITEM#
G		60-63-64-69-70	Door handle & lock gaskets	2DR 4DR HTP 2DR SDN CNV SWG	60 Chevrolet Biscayne, Impala, Bel Air, Cadillac, Oldsmobile 89 Oldsmobile 98, Buick LeSabre, Invicta, Electra, Wild Cat, Pontiac Catalina, Star Chief, Bonneville, Grand Prix, Ventura	2098
G		61-62-65-66-67-68	Door handle & lock gaskets	2DR 4DR HTP 2DR SDN CNV SWG	61-62 Chevrolet Biscayne, Bel Air, Impala, Cadillac, Oldsmobile 88 Oldsmobile 98, Buick LeSabre, Invicta, Electra, Pontiac	2145
G		71-72-73-74-75-76-77-78	Door handle gaskets	2DR HTP CNV 2DR SDN	71-76 Buick LeSabre, Electra, Oldsmobile 98 Oldsmobile 88, 71-78 Toronado, Cadillac, 74-76 Riviera	2514
H		64-65-66-67-68-69-70-71-72	Firewall wiring gutter plk	2DR 4DR HTP 2DR SDN SWG CNV	Chevy Chevelle, Biscayne, Bel Air, Impala, Caprice, Nova, Camaro, Cadillac Calais, Deville, Fleetwood, Oldsmobile 88, 98, Jetstar, Starfire, Pontiac Catalina, Bonneville, Firebird, Buick Lesabre, Wildcat, Electra	2328
H		67-68	Hood insulation	2DR 4DR HTP 2DR SDN CNV	67-68 Buick LeSabre, Wildcat, Electra	23911
H		71-72-73-74-75-76-77-78	Hood to cowl seal	2DR SDN 2DR HTP CNV SWG	71-78 Chevrolet Impala, Caprice, Biscayne, Bel Air, Brookwood, Townsman, Kingswood, Buick Lesabre, Centurion, Electra 225, Estate Wagon, Cadillac Calais, Deville, Eldorado, Sixty Special Brougham, Oldsmobile 88, 98, Toronado, Pontiac Catalina, Bonneville, Grandville, Safari Full Size	2191
I		59-60-61-62-63-64-65-66	Gear shift grommet column	2DR 4DR SDN HTP CNV	59-66 Chevrolet Biscayne, Bel Air, Impala, 59-66 Cadillac, 59-63 Oldsmobile 88 Oldsmobile 98, 61 Starfire, 64-66 Starfire, Jet Star, 59-66 Buick LeSabre, Invicta, Electra, 63 Wildcat, Riviera, 59-66 Pontiac	2185A
I		64-65-66-67-68-69-70-71-72-73-74	Park brake pedal pad	2DR HTP CNV	El Camino Cutlass Chevelle Chevy II Camaro Firebird LeMans Tempest GTO Grand Prix Full Size Centurion Century Electra Invicta LeSabre Regal Riviera Skylark Wildcat Monte Carlo	3094
R		58-59-60-61-62-63-64	Header seal	CNV	Chevy Impala, Cadillac Series 62 Eldorado, Pontiac Catalina, Bonneville, Oldsmobile 88, 98, Starfire, Buick Lesabre, Invicta, Electra	2153
R		59-60	Weatherstrip kit for convertible top	CNV	59-60 Cadillac Series 62, Eldorado, 59-60 Oldsmobile 98, 59-60 Buick Electra, 59-60 Pontiac, Convertible	2155
R		59-60	Roofrail weatherstrip with clips	2DR HTP	59-60 Chevrolet, Cadillac, Pontiac, Oldsmobile, Buick, 2 Door Hardtop	2090
R		59-60	Pillar post weatherstrip with clips and molded ends	CNV	59-60 Chevrolet Impala, Cadillac Eldorado Series 62, Pontiac Bonneville, Catalina, Oldsmobile 88 Oldsmobile 98, Buick LeSabre, Invicta, Electra	2091
R		61	Roofrail weatherstrip with molded ends	2DR HTP	61 Chevrolet, Buick, Oldsmobile, Pontiac 2 Door Hardtop	2129







GUIDE TO SOFFSEAL'S PRODUCT CODES

B = Bumper sets **C** = Glass channels **D** = Door related **G** = Seals, gaskets **H** = Under hood items **I** = Interior parts
M = Miscellaneous items **R** = Roofrail, pillar post & convertible items **T** = Trunk related **W** = Window related **Z** = Weatherstrip kits



CODE	IMAGE	YEAR	DESCRIPTION	BODY	FITS	ITEM#
R		62	Pillar post weatherstrip with molded ends	CNV	61-62 Chevrolet Impala, 61-62 Cadillac 61 Series 6200, Eldorado 62 Eldorado, 61-62 Oldsmobile 88 Oldsmobile 98, Starfire, 61-62 Buick Electra, Invicta, LeSabre, 61-62 Catalina, Bonneville, Convertible	2154
R		65	Pillar post weatherstrip with molded ends	CNV	65 Chevrolet Impala, 65 Cadillac Deville, Eldorado, 65 Oldsmobile 88 Oldsmobile 98, 65 Buick LeSabre, Wildcat, Electra, Invicta, 65 Pontiac, Convertible	2334
R		65-66	Roofrail weatherstrip with molded ends	2DR HTP	65-66 Chevrolet Impala, Caprice, 65-66 Cadillac Calais, Deville, 65-66 Oldsmobile 88, Jet Star, Star Fire, Oldsmobile 98, 65-66 Buick LeSabre, Wildcat, Electra, 65-66 Pontiac 2 Door Hardtop	2333
R		65-66-67-68-69-70	Header seal with clips and molded ends	CNV	65 Chevrolet, 66-70 Chevrolet Impala, 65-70 Cadillac Deville, 65-70 Oldsmobile 88 Oldsmobile 98, 65 Oldsmobile Starfire, 65-70 Buick LeSabre, Wildcat, Electra, 65-70 Pontiac, Convertible	23343
R		66-67-68-69-70	Weatherstrip kit for convertible top with out header seal	CNV	66-70 Cadillac Deville, 66 Cadillac Eldorado, 66-70 Oldsmobile 98, 66-70 Buick Electra, Convertible	23342
R		66-68	Pillar post weatherstrip with molded ends	CNV	66-68 Chevrolet Impala, 66-68 Cadillac Deville, 66 Cadillac Eldorado, 66-68 Oldsmobile 88 Oldsmobile 98, 66-68 Buick Electra, LeSabre, Wildcat, 66-68 Pontiac, Convertible	23341
R		67-68	Roofrail weatherstrip with molded ends	2DR HTP	67-68 Chevrolet Impala, Caprice, 67-68 Cadillac, 67-68 Oldsmobile 88, 67-68 Buick Electra, Wildcat, 67-68 Pontiac Catalina, Executive 2 Door Hardtop	2345
R		69-70	Roofrail weatherstrip	4DR HTP	69-70 Chevrolet Impala, Caprice, 69-70 Oldsmobile 88 Oldsmobile 98, 69-70 Buick LeSabre, Wildcat, Electra, 69-70 Pontiac Catalina, Bonneville, Executive 4 Door Hardtop	23561
R		69-70	Pillar post weatherstrip with molded ends	CNV	69-70 Chevrolet Impala, Caprice, 69-70 Cadillac Deville, 69-70 Oldsmobile 88 Oldsmobile 98, 69-70 Buick LeSabre, Wildcat, Electra, 69-70 Pontiac, Convertible	2358
R		71-72-73-74	Roofrail weatherstrip	4DR HTP	71-74 Buick Electra, Oldsmobile 98, Cadillac Deville, 4 Door Hardtop	2224
R		71-72-73-74-75	Roofrail weatherstrip	2DR HTP	71-73 Impala Custom Coupe Caprice, 74-75 Impala Sport Coupe, 71-76 Cadillac Calais Deville, 71-74 Electra, 74-76 LeSabre, 71-71 98, 74 Oldsmobile 98 Oldsmobile Delta 88, 75-76 Oldsmobile Delta 88, 71-73 Grandville, 74 Bonneville Catalina Grandville, 75-76 Catalina, 2 Door Hardtop	2509

CODE	IMAGE	YEAR	DESCRIPTION	BODY	FITS	ITEM#
T		58-59-60-61-62-63-64-65-66-67-68-69	Trunk weatherstrip exact profile	2DR 4DR HTP 2DR SDN CNV	58-64 Chevrolet Biscayne, 58-64 Chevrolet Bel Air, Chevrolet Impala, 60-69 Chevrolet Corvair, 59-64 Pontiac Parisienne, 59-64 Pontiac Catalina, 59-64 Pontiac Star Chief, 60-61 Pontiac Ventura, 62-64 Pontiac Grand Prix, 58-64 Oldsmobile Delta 88, 58-64 Oldsmobile Dynamic 88, Oldsmobile Super 88, Oldsmobile Super 98, 61-64 Oldsmobile Starfire, 64 Oldsmobile Jetstar, 59-64 Buick LeSabre, 59-62 Buick Invicta, 59-64 Buick Electra, 62-64 Buick Wildcat, 63-65 Buick Riviera, 58-60 Cadillac Deville, Cadillac Eldorado, Cadillac Series 62, Cadillac Series 60 Special, Cadillac Series 75, 58-64 C-Body	2001
T		64-65-66-67-68-69-70-71-72-73-74-75-76-77	Trunk weatherstrip exact profile length 17 feet	2DR 4DR HTP 2DR SDN CNV	65-72 Chevy II, 65-72 Chevrolet Biscayne, 65-75 Chevrolet Bel Air, 65-76 Chevrolet Impala, 65-76 Chevrolet Caprice, 64-77 Chevrolet Chevelle, 70-77 Chevrolet Monte Carlo, 65-76 Buick LeSabre, 64-77 Buick Wildcat, 64-77 Buick Skylark, 71-73 Buick Centurion, 64-72 Buick Grand Special, 73-77 Buick Century, 73-88 Buick Regal, 73-88 Buick Grand National, 65-76 Buick Electra, 65-76 Oldsmobile Delta 88, 67-69 Oldsmobile Delmont 88, 65-66 Oldsmobile Dynamic 88, 65-66 Oldsmobile Starfire, 65 Oldsmobile Jetstar, 64-77 Oldsmobile Cutlass 442, 64-88 Oldsmobile Cutlass, 65-76 Oldsmobile 98, 65-76 Pontiac Parisienne, 64-72 Pontiac LeMans, 65-70 Pontiac Catalina, 65-66 Pontiac Star Chief, 67-70 Pontiac Executive, 71-75 Pontiac Grand Ville, 65-77 Pontiac Grand Prix, 64-72 Pontiac Tempest, 62-72 Nova, Ventura, 73-74 Non-Hatchback, Up to 1975 with groove channel, Apollo, Nova, Omega, Ventura 65-76 C-Body	2003
T		75-76-77-78-79-80-81-82-83-84-85-86-87-88-89-90-91-92	Trunk and Hatchback weatherstrip	2DR 4DR SDN HTP CNV	77-85 Chevrolet Impala, 77-91 Chevrolet Caprice, 82-92 Chevrolet Camaro, 75-79 Chevrolet Nova, 78-88 Chevrolet Monte Carlo, 78-83 Chevrolet Malibu, 78-83 Pontiac LeMans, 82-92 Pontiac Firebird, 75-91 Pontiac Ventura, 77-86 Pontiac Parisienne, 77-81 Pontiac Catalina, 69-88 Pontiac Grand Prix, 64-87 Pontiac LeMans, Pontiac Grand Am, 64-77 Pontiac GTO, 73-79 Oldsmobile Omega, 77-85 Oldsmobile Delta 88, 77-84 Oldsmobile 98, 77-88 Oldsmobile Cutlass, 73-75 Buick Apollo, 76-79 Buick Skylark, 77-79 Phoenix, 73-88 Buick Regal, 77-84 Buick Electra, 77-85 Buick LeSabre, 77-78 Buick Riviera, 77-91 C-Body	2424
W		58-59-60	Quarter window u-jamb	CNV	58-60 Chevrolet Impala, 58 Cadillac, 59-60 Cadillac Series 62, Eldorado, 58-60 Oldsmobile 88 Oldsmobile 98, 58 Buick, 59-60 Buick LeSabre, Invicta, Electra, 58 Pontiac, Convertible	2286











GUIDE TO SOFFSEAL'S PRODUCT CODES

B = Bumper sets **C** = Glass channels **D** = Door related **G** = Seals, gaskets **H** = Under hood items **I** = Interior parts
M = Miscellaneous items **R** = Roofrail, pillar post & convertible items **T** = Trunk related **W** = Window related **Z** = Weatherstrip kits



CODE	IMAGE	YEAR	DESCRIPTION	BODY	FITS	ITEM#
W		58-59-60-61-62-63-64	Quarter window seals	2DR HTP CNV	58-64 Chevrolet Impala, 58, 60-62 Bel Air, 58-64 Cadillac Series 62, Deville, Eldorado, 58 Oldsmobile 88 Oldsmobile 98, 59-60 Oldsmobile 88 Oldsmobile 98, 61-64 Oldsmobile 99, Starfire, 98, 64 Jetstar, 59-62 Buick LeSabre, Invicta, Electra 2 Door Hardtop Convertible	2300
W		59-60	Rear quarter stationary vent window seals	4DR SDN	59-60 Chevrolet Buick, Style 4419, 4619, 4719 Oldsmobile, Pontiac 4 Door Sedan	2053
W		61-62	Vent window seals	2DR 4DR HTP CONV	61-62 Chevrolet Bel Air, Impala, 61-62 Cadillac Series 62, Eldorado, 61-62 Oldsmobile 88 Oldsmobile 98, 61-62 Buick LeSabre, Invicta, Electra, 61-62 Pontiac Bonneville, Catalina, Ventura 2 Door 4 Door Hardtop, Convertible	21615
W		61-62-63-64-65-66	Horizontal outer window seals	2DR 4DR HTP SDN CNV SWG	Chevy Biscayne, Bel Air, Impala, Caprice, Cadillac series 62 Deville, Eldorado, Fleetwood, Calais, Oldsmobile 88, Starfire, 98. Buick Lesabre, Invicta, Wildcat, Electra, Pontiac Catalina, Ventura, Star Chief, Bonneville	2310
W		63-64	Vent window seals	2DR HTP CNV	63-64 Chevrolet Impala, Buick Electra, Lesabre, Wildcat, Oldsmobile 98, Pontiac Catalina, Bonneville, 2 Door Hardtop Convertible, Starfire Convertible Only	21814
W		65-66	Quarter window seals	4DR HTP	65-66 Chevrolet Impala, 66 Chevrolet Caprice, 65-66 Cadillac Calais, Deville, 65-66 Oldsmobile 88 Oldsmobile 98, 65-66 Buick LeSabre, Wildcat, Electra, 65-66 Pontiac Bonneville, Catalina, Star Chief 4 Door Hardtop	23011
W		65-66	Door u-jamb seal	2DR HTP CNV	65-66 Chevrolet Impala, 66 Caprice, 65-66 Cadillac Calais, Deville, Eldorado, 65-66 Oldsmobile 88, Jetstar, Starfire, Oldsmobile 98, 65-66 Buick LeSabre, Wildcat, Electra, 65 Pontiac Bonneville, Catalina, Star Chief 2hardtop Convertible	2368
W		65-66-67-68	Vent window weatherstrip	2DR HTP CNV	65-68 Chevrolet Impala, Buick LeSabre, Electra, Wildcat, Cadillac Calais, Deville, Oldsmobile 88 Oldsmobile 98 Starfire, Pontiac Bonneville, Catalina, Star Chief 2 Door Hardtop Convertible	2217
W		65-66-67-68	Glass run channel front window	2DR HTP CNV	65-68 Chevrolet Impala, Caprice, 65-68 Cadillac Calais, Deville 65-66 Eldorado, 65-68 Oldsmobile 88 Oldsmobile 98, 65-66 Oldsmobile Jetstar, Starfire, 65-68 Buick LeSabre, Wildcat, Electra, 65-68 Pontiac Bonneville, Catalina, Executive 2 Door Hardtop Convertible	2350
W		67-68	Quarter window seals	2DR HTP	67-68 Chevrolet Impala, 67-68 Cadillac Calais, Deville 67-68 Oldsmobile 88, 98, 67-68 Buick LeSabre, Wildcat, Electra 67-68 Pontiac Catalina, Bonneville, Executive 2 Door Hardtop	2302

CODE	IMAGE	YEAR	DESCRIPTION	BODY	FITS	ITEM#
W		67-68	Quarter window seals	CNV	67-68 Chevrolet Impala, 67-68 Cadillac Deville, 67-68 Oldsmobile 88 Oldsmobile 98, 67-68 Buick LeSabre, Wildcat, Electra, 67-68 Pontiac Catalina, Bonneville Convertible	23021
W		67-68	Quarter window u-jamb	2DR HTP CNV	67-68 Chevrolet Impala, 67-68 Cadillac Calais, Deville, 67 Oldsmobile 98, 67-68 Buick, LeSabre, Wildcat, Electra, 67-68 Pontiac Bonneville, Catalina 2 Door Hardtop	2292
W		67-68	Quarter window u-jamb	2 DR CNV HTP	67-68 Chevy Impala Convertible 68 Caprice Sport Coupe, 67 Buick Lasabre, Wildcat Convertible, 67 Electra 2 Door Hardtop & Convertible, 68 Buick Wildcat, Electra, Lesabre 2 Door Hardtop & Convertible, 67 Cadillac Deville Convertible, 68 Cadillac Calais, Deville Hardtop & Convertible 67-68 Oldsmobile 88, Oldsmobile 98, 67-68 Pontiac Catalina, Bonneville, Executive, Grand Prix Hardtop & Convertible	2294
W		71-72-73	Qtr window u jamb	2DR HTP CNV	71-73 Buick LeSabre, Electra, Riviera, Chevrolet Impala, Caprice, Cadillac Calais, Deville, Oldsmobile 88 Oldsmobile 98, Pontiac Catalina, Bonneville, Grandville 2 Door Hardtop Convertible	2600
W		71-72-73-74-75-76	Quarter window seals	4DR HTP	71-75 Chevrolet Impala, Caprice, Cadillac Calais, Deville, Pontiac Catalina, Bonneville, Grandville Buick Lesabre, Electra, Oldsmobile 88, 98, 4 Door Hardtop	2309
W		74-75-76	Quarter window u-jamb	2DR HTP CNV	Impala Caprice LeSabre Electra Eldorado Oldsmobile Delta 88 Oldsmobile 98, Tornado Delta Bonneville Catalina Grandville Catalina	2295
W		77-78-79-80-81-82-83-84-85-86-87-88-89-90	Window weatherstrip outers only, rwd with chrome bead	2DR SDN	77-90 Chevrolet Impala, Caprice, Buick LeSabre, Electra, Oldsmobile 88 Oldsmobile 98, Pontiac Catalina, Bonneville, Cadillac Deville, 2 Door Sedan	2369
W		77-78-79-80-81-82-83-84-85-86-87-88-89-90	Window weatherstrip, outers only, rwd, with chrome bead	2DR SDN	77-90 Chevrolet Impala, Caprice, Buick LeSabre, Electra, Oldsmobile 88 Oldsmobile 98, Pontiac Catalina, Bonneville, Cadillac Deville, 2 Door Sedan	23691



GUIDE TO SOFFSEAL'S PRODUCT CODES









B = Bumper sets **C** = Glass channels **D** = Door related **G** = Seals, gaskets **H** = Under hood items **I** = Interior parts
M = Miscellaneous items **R** = Roofrail, pillar post & convertible items **T** = Trunk related **W** = Window related **Z** = Weatherstrip kits

Buick • Estate & Roadmaster



CODE	IMAGE	YEAR	DESCRIPTION	BODY	FITS	ITEM#
D		54-55-56	Door weatherstrip	CNV	54-56 Buick Super, Roadmaster Riviera, Cadillac Convertible	0549
D		55-56-57-58-59-60	Door weatherstrip with clips sedan front and rear	2DR 4DR SDN SWG	55-60 Chevrolet Bel Air 150 210, Nomad, Pontiac Chieftain, Star Chief, Safari, Super Chief, Bonneville, Buick Century, Roadmaster, Special Also Station Wagon And Sedan Delivery	1003
D		58	Door weatherstrip	2DR 4DR HTP 2DR SDN CNV SWG	58 Chevrolet Del Ray, Biscayne, Bel Air, Impala, 58 Cadillac, 57-58 Oldsmobile 88 Oldsmobile 98, 57-58 Buick Special Century, Super, Roadmaster, 58 Pontiac	2044
D		69-70	Rear door weatherstrip	SWG 4DR	69-70 Chevy Biscayne, Bel Air, Impala, Caprice, Estate, Oldsmobile Vista Cruiser, Pontiac Catalina, Bonneville, Executive, Gm Fullsize Station Wagon 4 Door	2519
D		71-72-73-74	Door weatherstrip rear with clips & molded ends	4DR SDN	71-74 Chevrolet Impala, Bel Air, Biscayne, Brookwood, Townsman, Kingswood, Buick Estate Station Wagon, Pontiac Catalina, Grand Safari, Bonneville, Oldsmobile Custom Cruiser, 4 Door Sedan	2225
D		71-72-73-74-75-76	Door weatherstrip rear with clips & molded ends	SWG 4DR	71-76 Chevrolet Bel Air, Caprice, Impala, Brookwood, Townsman, Kingswood, Oldsmobile Custom Cruiser, Pontiac Grand Safari, Buick Estate Wagon, 4 Door Station Wagon	2227
D		71-72-73-74-75-76	Door weatherstrip front with clips & molded ends	4DR SWG	71-76 Chevrolet Impala, Bel Air, Biscayne, Brookwood, Townsman, Kingswood, Buick Estate Station Wagon, Pontiac Catalina, Grand Safari, Bonneville, Oldsmobile Custom Cruiser, 4 Door Station Wagon	2228
D		75-76	Door weatherstrip rear with clips & molded ends	4DR SDN	75-76 Chevrolet Impala, Bel Air, Brookwood, Townsman, Kingwood, Buick Estate Station Wagon, Pontiac Catalina, Grand Safari, Bonneville, Oldsmobile Custom Cruiser, 4 Door Sedan	2226
D		77-78-79-80-81-82-83-84-85-86	Front door weatherstrip with clips	4DR SDN RWD	77-86 Impala Caprice, 77-84 Cadillac Deville Fleetwood, 85-86 Fleetwood, 77-84 Oldsmobile 88 89, 85 88, 77-84 Buick LeSabre Electra 85 LeSabre, 77-79 Buick Estate Wagon, 82-83 Buick Park Ave 77-81 Pontiac Bonneville, 83-86 Pontiac Parisienne, 77-80 Pontiac Catalina 4 Door Sedan, RWD Only	2500
D		77-78-79-80-81-82-83-84-85-86-87-88-89-90	Rear door weatherstrip with clips	4 DR SWG, RWD	77-86 Chevrolet Impala Caprice, 87-88 Caprice Caprice Classic, Cadillac, 77-85 Oldsmobile Custom Cruiser, 77-88 Estate Station Wagon, 77-81 Catalina Safari Bonneville Safari, 82 Bonneville Safari, 83 Bonneville Parisienne, 84-89 Parisienne Station Wagon, RWD Only	2503

Buick • Estate & RoadMaster

CODE	IMAGE	YEAR	DESCRIPTION	BODY	FITS	ITEM#
H		71-72-73-74-75-76-77-78	Hood to cowl seal	2DR SDN 2DR HTP CNV SWG	71-78 Chevrolet Impala, Caprice, Biscayne, Bel Air, Brookwood, Townsman, Kingswood, Buick Lesabre, Centurion, Electra 225, Estate Wagon, Cadillac Calais, Deville, Eldorado, Sixty Special Brougham, Oldsmobile 88, 98, Tornado, Pontiac Catalina, Bonneville, Grandville, Safari Full Size	2191
I		58	Gear shift grommet column	2DR 4DR SDN HTP CNV	58 Chevrolet Del Ray, Biscayne, Bel Air, Impala, Cadillac, Oldsmobile 88 Oldsmobile 98, Buick Special, Century, Roadmaster, Riviera, Pontiac	2185
T		49-50-51-52-53	Trunk weatherstrip	2DR SDN 4DR SDN 2DR HTP 4DR HTP CNV	49-52 Chevrolet, Pontiac, 49-53 Oldsmobile, 49-50 Buick	0494
T		62-63-64-65-66-67-68-69-70-71-72-73	Door and tailgate bottom drain hole seal	2DR 4DR HTP SDN CNV SWG CPE	62-73 Chevy Nova, Chevelle, Impala, Caprice Pontiac Catalina, Star Chief, Bonneville, Grand Prix Oldsmobile F85	2118
W		54-55-56-62	Vent window division post weatherstrip	CNV	54-56 Cadillac, Buick Super And Roadmaster 62 Eldorado Convertible	1034
W		56-57-58-59-60-61-62	Vent window weatherstrip	2DR HTP CNV	54-56 Cadillac Hardtop Convertible, 54-55 Buick Super And Roadmaster Hardtop Convertible, 56 Buick Super And Roadmaster Convertible	10341
W		58	Window weatherstrip original style with round bead	CNV	58 Chevrolet Impala, 58 Cadillac, 58 Oldsmobile 88 Oldsmobile 98, 58 Buick Special, Century, Roadmaster, 58 Pontiac, Convertible	2038
W		58-59-60-61-62-63-64	Quarter window seals	2DR HTP CNV	58-64 Chevrolet Impala, 58, 60-62 Bel Air, 58-64 Cadillac Series 62, Deville, Eldorado, 58 Oldsmobile 88 Oldsmobile 98, 59-60 Oldsmobile 88 Oldsmobile 98, 61-64 Oldsmobile 99, Starfire, 98, 64 Jetstar, 59-62 Buick LeSabre, Invicta, Electra 2 Door Hardtop Convertible	2300

















GUIDE TO SOFFSEAL'S PRODUCT CODES

B = Bumper sets **C** = Glass channels **D** = Door related **G** = Seals, gaskets **H** = Under hood items **I** = Interior parts
M = Miscellaneous items **R** = Roofrail, pillar post & convertible items **T** = Trunk related **W** = Window related **Z** = Weatherstrip kits



CODE	IMAGE	YEAR	DESCRIPTION	BODY	FITS	ITEM#
B		59-60	Vent window bumpers upper	2DR HTP	59-60 Chevrolet Bel Air, Impala Pontiac Catalina, Star chief Oldsmobile Dynamic 88, Super 88, 98, Cadillac Deville, Eldorado, Series 62, Buick Lesabre, Invicta, Electra Full Size 2 Door Hardtop	2202
C		59-60	Rear quarter stationary vent window seal	SWG 2DR 4DR	59-60 Chevrolet Nomad, Brookwood, Kingswood, Buick LeSabre, Invicta, Oldsmobile Fiesta 88, Pontiac Catalina, Bonneville, Safari 2 Door 4 Door Station Wagon	2218
C		59-60	Glass channel	2DR 4DR HTP CNV	59-60 Chevrolet Bel Air, Impala, Cadillac Series 62, Deville, Eldorado, Oldsmobile 88 Oldsmobile 98, Buick LeSabre, Invicta, Electra, Pontiac Catalina, Star Chief, Bonneville 2 Door 4 Door Hardtop Convertible	2080
C		61-62	Glass channel front	2DR HTP	61 Chevrolet Impala, 62 Chevrolet Bel Air, 61 Cadillac Series 62, 62 Cadillac Deville 4 Door S, 61-62 Oldsmobile 88 Oldsmobile 98, 61 Buick LeSabre, Invicta, Electra, 62 Buick, 61-62 Pontiac Catalina, Ventura, Star Chief, Bonneville 2 Door Hardtop	2161
C		61-62	Glass channel front	CNV HT	62 Chevrolet, Pontiac, Oldsmobile, Buick, Cadillac Formal Roof Hardtop, 61-62 Convertible, 61 Pontiac, Oldsmobile, Buick, Cadillac Formal Roof Hardtop	2162
C		62-63-64	Glass channel rear except 1963-64 gran prix	2DR HTP	62 Buick LeSabre, Invicta, 63-64 Buick LeSabre, Wildcat, 62-64 Chevrolet Impala, 62-63 Oldsmobile S88, 62-64 Oldsmobile D88, 64 Oldsmobile J88, 62-64 Pontiac Catalina 2 Door Hardtop	2184
D		59-60	Door weatherstrip front with clips & molded ends	4DR HTP	59-60 Chevrolet Impala, Bel Air, Buick Lesabre, Invicta, Oldsmobile 88, Pontiac Catalina, Star Chief, Bonneville 4 Door Hardtop	2205
D		59-60	Door weatherstrip rear door with clips & molded ends	4DR HTP	59-60 Chevrolet Impala, Bel Air, Buick Electra, Invicta, LeSabre, Cadillac 62 Deville, Eldorado, Oldsmobile 98 Oldsmobile 99, 4 Door Hardtop	2206
D		59-60	Door weatherstrip with clips & molded ends	2DR HTP CNV	59-60 Chevrolet Impala, Bel Air, Pontiac Catalina, Star Chief, Bonneville, Oldsmobile 88, 98, Buick LeSabre, Invicta, Electra, Cadillac Deville, Eldorado, Series 62 Hardtop Convertible	2011
D		61-62	Door weatherstrip with clips & molded ends	2DR HTP CNV	61-62 Chevrolet Bel Air Impala, Cad Series 62, Deville, 61-62 Oldsmobile, 61 Hardtop Convertible 88 Star Fire, Oldsmobile 98/62 Oldsmobile 88 Oldsmobile 98 Starfire, 61-62 Buick 61 Hardtop Convertible, 62 Convertible Only LeSabre Invicta Electra, 61-62 Pontiac, 2 Door Hardtop Convertible	2013
D		61-62	Door weatherstrip, front doors	4DR HTP	61-62 Chevrolet Impala, Bel Air, Buick Electra, LeSabre, Invicta, Cadillac Series 60, Oldsmobile 88 Oldsmobile 98, 4 Door Hardtop	2207

Buick • Invicta

CODE	IMAGE	YEAR	DESCRIPTION	BODY	FITS	ITEM#
D		61-62-63-64	Door weatherstrip rear with clips	4dr SWG	61-64 Chevrolet Biscayne, Bel Air, Impala, 61-64 Oldsmobile 88, 61-64 Buick LeSabre, 62-63 Invicta 63-64 Wildcat, 61-64 Pontiac Catalina, Bonneville, 4 Door Station Wagon	2018
D		63-64	Door weatherstrip with clips & molded ends	2DR HTP CNV	63-64 Chevrolet Impala, 63-64 Cadillac Eldorado, Deville, 63-64 Oldsmobile 88 Oldsmobile 98 Starfire 63-64 Buick LeSabre Wildcat, Electra 63 Invicta, 63-64 Pontiac Catalina, Bonneville, Grand Prix, 2 Door Hardtop Convertible	2014
G		60-63-64-69-70	Door handle & lock gaskets	2DR 4DR HTP 2DR SDN CNV SWG	60 Chevrolet Biscayne, Impala, Bel Air, Cadillac, Oldsmobile 89 Oldsmobile 98, Buick LeSabre, Invicta, Electra, Wild Cat, Pontiac Catalina, Star Chief, Bonneville, Grand Prix, Ventura	2098
G		61-62-65-66-67-68	Door handle & lock gaskets	2DR 4DR HTP 2DR SDN CNV SWG	61-62 Chevrolet Biscayne, Bel Air, Impala, Cadillac, Oldsmobile 88 Oldsmobile 98, Buick LeSabre, Invicta, Electra, Pontiac	2145
I		59-60-61-62-63-64-65-66	Gear shift grommet column	2DR 4DR SDN HTP CNV	59-66 Chevrolet Biscayne, Bel Air, Impala, 59-66 Cadillac, 59-63 Oldsmobile 88 Oldsmobile 98, 61 Starfire, 64-66 Starfire, Jet Star, 59-66 Buick LeSabre, Invicta, Electra, 63 Wildcat, Riviera, 59-66 Pontiac	2185A
I		64-65-66-67-68-69-70-71-72-73-74	Park brake pedal pad	2DR HTP CNV	El Camino Cutlass Chevelle Chevy II Camaro Firebird LeMans Tempest GTO Grand Prix Full Size Centurion Century Electra Invicta LeSabre Regal Riviera Skylark Wildcat Monte Carlo	3094
R		58-59-60-61-62-63-64	Header seal	CNV	Chevy Impala, Cadillac Series 62 Eldorado, Pontiac Catalina, Bonneville, Oldsmobile 88, 98, Starfire, Buick LeSabre, Invicta, Electra	2153
R		59-60	Roofrail weatherstrip with clips	2DR HTP	59-60 Chevrolet, Cadillac, Pontiac, Oldsmobile, Buick, 2 Door Hardtop	2090
R		59-60	Pillar post weatherstrip with clips and molded ends	CNV	59-60 Chevrolet Impala, Cadillac Eldorado Series 62, Pontiac Bonneville, Catalina, Oldsmobile 88 Oldsmobile 98, Buick LeSabre, Invicta, Electra	2091
R		59-60	Weatherstrip kit for convertible top with header seal	CNV	59-60 Chevrolet Impala, Cadillac, Oldsmobile 88, Buick LeSabre, Invicta, Pontiac, Convertible	2092
R		59-60	Roofrail weatherstrip	4DR HTP	59-60 Chevrolet Bel Air, Buick Impala, LeSabre, Invicta, 4 Door Hardtop	2220
R		61	Roofrail weatherstrip with molded ends	2DR HTP	61 Chevrolet, Buick, Oldsmobile, Pontiac 2 Door Hardtop	2129
R		61-62	Roofrail weatherstrip	4DR HTP	61-62 Chevrolet Bel Air, Impala, Buick, LeSabre, Invicta, Oldsmobile 88, Pontiac, 4 Door Hardtop	2223
R		61-62	Weatherstrip Kit For Convertible Top With 6-5/8 Between Center Stud	Cnv	61-62 Chevrolet Impala, 61-62 Olds 88, Starfire, 61 Buick LeSabre, 61-62 Invicta, 61-62 Pontiac, Catalina Bonneville Convertible	2156



GUIDE TO SOFFSEAL'S PRODUCT CODES



B = Bumper sets **C** = Glass channels **D** = Door related **G** = Seals, gaskets **H** = Under hood items **I** = Interior parts
M = Miscellaneous items **R** = Roofrail, pillar post & convertible items **T** = Trunk related **W** = Window related **Z** = Weatherstrip kits



CODE	IMAGE	YEAR	DESCRIPTION	BODY	FITS	ITEM#
R		62	Roofrail weatherstrip with molded ends	2DR HTP	62 Chevrolet Impala, 62 Cadillac, 62 Oldsmobile 88, 62 Buick LeSabre, Invicta, Pontiac 2 Door Hardtop	2164
R		62	Pillar post weatherstrip with molded ends	CNV	61-62 Chevrolet Impala, 61-62 Cadillac 61 Series 6200, Eldorado 62 Eldorado, 61-62 Oldsmobile 88 Oldsmobile 98, Starfire, 61-62 Buick Electra, Invicta, LeSabre, 61-62 Catalina, Bonneville, Convertible	2154
R		62-63-64	Weatherstrip kit for convertible top second type with 5 3/8" between center studs	CNV	62-64 Chevrolet Impala, Oldsmobile 88, Starfire, Buick LeSabre, Invicta, Pontiac, Bonneville, Catalina, 63-64 Buick Wildcat Convertible	2152
R		62-63-64	Weatherstrip kit for convertible top with 5 3/8" between center studs cloth covered	CNV	62-64 Chevrolet Impala, Cadillac, Oldsmobile 88, Starfire, Buick LeSabre, Invicta, Wildcat, Pontiac Catalina, Bonneville	2152C
R		65	Pillar post weatherstrip with molded ends	CNV	65 Chevrolet Impala, 65 Cadillac Deville, Eldorado, 65 Oldsmobile 88 Oldsmobile 98, 65 Buick LeSabre, Wildcat, Electra, Invicta, 65 Pontiac, Convertible	2334
T		58-59-60-61-62-63-64-65-66-67-68-69	Trunk weatherstrip exact profile	2DR 4DR HTP 2DR SDN CNV	58-64 Chevrolet Biscayne, 58-64 Chevrolet Bel Air, Chevrolet Impala, 60-69 Chevrolet Corvair, 59-64 Pontiac Parisienne, 59-64 Pontiac Catalina, 59-64 Pontiac Star Chief, 60-61 Pontiac Ventura, 62-64 Pontiac Grand Prix, 58-64 Oldsmobile Delta 88, 58-64 Oldsmobile Dynamic 88, Oldsmobile Super 88, Oldsmobile Super 98, 61-64 Oldsmobile Starfire, 64 Oldsmobile Jetstar, 59-64 Buick LeSabre, 59-62 Buick Invicta, 59-64 Buick Electra, 62-64 Buick Wildcat, 63-65 Buick Riviera, 58-60 Cadillac Deville, Cadillac Eldorado, Cadillac Series 62, Cadillac Series 60 Special, Cadillac Series 75, 58-64 C-Body	2001
T		62-63-64-65-66-67-68-69-70-71-72-73	Door and tailgate bottom drain hole seal	2DR 4DR HTP SDN CNV SWG CPE	62-73 Chevy Nova, Chevelle, Impala, Caprice Pontiac Catalina, Star Chief, Bonneville, Grand Prix Oldsmobile F85	2118
W		58-59-60	Quarter window u-jamb	CNV	58-60 Chevrolet Impala, 58 Cadillac, 59-60 Cadillac Series 62, Eldorado, 58-60 Oldsmobile 88 Oldsmobile 98, 58 Buick, 59-60 Buick LeSabre, Invicta, Electra, 58 Pontiac, Convertible	2286
W		58-59-60-61-62-63-64	Quarter window seals	2DR HTP CNV	58-64 Chevrolet Impala, 58, 60-62 Bel Air, 58-64 Cadillac Series 62, Deville, Eldorado, 58 Oldsmobile 88 Oldsmobile 98, 59-60 Oldsmobile 88 Oldsmobile 98, 61-64 Oldsmobile 99, Starfire, 98, 64 Jetstar, 59-62 Buick LeSabre, Invicta, Electra 2 Door Hardtop Convertible	2300
W		59-60	Rear quarter stationary vent window seals	4DR SDN	59-60 Chevrolet Buick, Style 4419, 4619, 4719 Oldsmobile, Pontiac 4 Door Sedan	2053

Buick • Invicta

BUICK • Invicta

CODE	IMAGE	YEAR	DESCRIPTION	BODY	FITS	ITEM#
W		61-62	Vent window seals	2DR 4DR HTP CONV	61-62 Chevrolet Bel Air, Impala, 61-62 Cadillac Series 62, Eldorado, 61-62 Oldsmobile 88 Oldsmobile 98, 61-62 Buick LeSabre, Invicta, Electra, 61-62 Pontiac Bonneville, Catalina, Ventura 2 Door 4 Door Hardtop, Convertible	21615
W		61-62-63-64-65-66	Horizontal outer window seals	2DR 4DR HTP SDN CNV SWG	Chevy Biscayne, Bel Air, Impala, Caprice, Cadillac series 62 Deville, Eldorado, Fleetwood, Calais, Oldsmobile 88, Starfire, 98. Buick Lesabre, Invicta, Wildcat, Electra, Pontiac Catalina, Ventura, Star Chief, Bonneville	2310



GUIDE TO SOFFSEAL'S PRODUCT CODES

B = Bumper sets **C** = Glass channels **D** = Door related **G** = Seals, gaskets **H** = Under hood items **I** = Interior parts
M = Miscellaneous items **R** = Roofrail, pillar post & convertible items **T** = Trunk related **W** = Window related **Z** = Weatherstrip kits



CODE	IMAGE	YEAR	DESCRIPTION	BODY	FITS	ITEM#
B		59-60	Vent window bumpers upper	2DR HTP	59-60 Chevrolet Bel Air, Impala Pontiac Catalina, Star chief Oldsmobile Dynamic 88, Super 88, 98, Cadillac Deville, Eldorado, Series 62, Buick LeSabre, Invicta, Electra Full Size 2 Door Hardtop	2202
B		61-62	Upper vent window bumper	CNV	61-62 Chevrolet Impala, Bel Air, Pontiac Catalina, Bonneville, Oldsmobile 88, 98, Buick LeSabre, Electra 225, Cadillac Deville Convertible	2088
B		63-64	Upper vent window bumpers	CNV	63-64 Impala, Bonneville, Catalina, Oldsmobile 88, 98, LeSabre, Electra 225, Deville, Convertible	2203
B		63-64	Vent window bumpers, upper	2DR 4DR HTP	63-64 Chevrolet Impala, 63-64 Cadillac, Deville, 63-64 Oldsmobile 88, 98, 63-64 Buick LeSabre, Electra, 63-64 Pontiac Bonneville, Catalina, 2 Door 4 Door Hardtop	2204
B		67-68-69-70	Door bumpers	2DR 4DR HTP 2DR SDN CNV SWG	67-70 Chevrolet Biscayne, Bel Air, Impala Caprice, 67-70 Cadillac Calais, Deville, Fleetwood, 67-70 Oldsmobile 88, 98, 67-70 Buick LeSabre, Wildcat, Electra, 67-70 Pontiac	2323
C		59-60	Rear quarter stationary vent window seal	SWG 2DR 4DR	59-60 Chevrolet Nomad, Brookwood, Kingswood, Buick LeSabre, Invicta, Oldsmobile Fiesta 88, Pontiac Catalina, Bonneville, Safari 2 Door 4 Door Station Wagon	2218
C		59-60	Glass channel	2DR 4DR HTP CNV	59-60 Chevrolet Bel Air, Impala, Cadillac Series 62, Deville, Eldorado, Oldsmobile 88 Oldsmobile 98, Buick LeSabre, Invicta, Electra, Pontiac Catalina, Star Chief, Bonneville 2 Door 4 Door Hardtop Convertible	2080
C		61-62	Glass channel front	2DR HTP	61 Chevrolet Impala, 62 Chevrolet Bel Air, 61 Cadillac Series 62, 62 Cadillac Deville 4 Door S, 61-62 Oldsmobile 88 Oldsmobile 98, 61 Buick LeSabre, Invicta, Electra, 62 Buick, 61-62 Pontiac Catalina, Ventura, Star Chief, Bonneville 2 Door Hardtop	2161
C		61-62	Glass channel front	CNV HT	62 Chevrolet, Pontiac, Oldsmobile, Buick, Cadillac Formal Roof Hardtop, 61-62 Convertible, 61 Pontiac, Oldsmobile, Buick, Cadillac Formal Roof Hardtop	2162
C		62-63-64	Glass channel rear except 1963-64 gran prix	2DR HTP	62 Buick LeSabre, Invicta, 63-64 Buick LeSabre, Wildcat, 62-64 Chevrolet Impala, 62-63 Oldsmobile S88, 62-64 Oldsmobile D88, 64 Oldsmobile J88, 62-64 Pontiac Catalina 2 Door Hardtop	2184
C		62-63-64	Glass channel rear	2DR 4DR SDN	62-63 Chevrolet Biscayne, Bel Air, Impala, 62-64 Cadillac, 62-64 Oldsmobile 88, 62-64 Buick LeSabre, 64 Wildcat, 62-64 Pontiac Catalina, Star Chief 2 Door 4 Door Sedan	2189
C		63-64	Glass channel rear	4DR HTP	63-64 Chevrolet Impala Sport Coupe, Oldsmobile 88 Holiday Sedan, Buick LeSabre, Wildcat, Pontiac Bonneville, Catalina, Star Chief 4 Door Hardtop	2188

CODE	IMAGE	YEAR	DESCRIPTION	BODY	FITS	ITEM#
C		63-64	Windshield gasket	2DR SDN SWG	63-64 Chevrolet Biscayne, Bel Air, Impala, 63-64 Cadillac Series 62, Deville, 63-64 Oldsmobile 88 Oldsmobile 98, 63-64 Buick LeSabre, Wildcat, Electra, 63-64 Pontiac, 2 Door Sedan Station Wagon	2020
C		63-64	Glass channel front	2DR HTP CNV	63-64 Chevrolet Impala, 63-64 Cadillac, 63-64 Oldsmobile 88, Oldsmobile 98 Starfire Convertible Only, 63-64 Buick LeSabre, Wildcat, Electra, 63-64 Pontiac, 2 Door Hardtop Convertible	2021
D		59-60	Door weatherstrip with clips & molded ends	2DR HTP CNV	59-60 Chevrolet Impala, Bel Air, Pontiac Catalina, Star Chief, Bonneville, Oldsmobile 88, 98, Buick LeSabre, Invicta, Electra, Cadillac Deville, Eldorado, Series 62 Hardtop Convertible	2011
D		59-60	Door weatherstrip front with clips & molded ends	4DR HTP	59-60 Chevrolet Impala, Bel Air, Buick LeSabre, Invicta, Oldsmobile 88, Pontiac Catalina, Star Chief, Bonneville 4 Door Hardtop	2205
D		59-60	Door weatherstrip rear door with clips & molded ends	4DR HTP	59-60 Chevrolet Impala, Bel Air, Buick Electra, Invicta, LeSabre, Cadillac 62 Deville, Eldorado, Oldsmobile 98 Oldsmobile 99, 4 Door Hardtop	2206
D		61-62	Door weatherstrip, front doors	4DR HTP	61-62 Chevrolet Impala, Bel Air, Buick Electra, LeSabre, Invicta, Cadillac Series 60, Oldsmobile 88 Oldsmobile 98, 4 Door Hardtop	2207
D		61-62	Door weatherstrip with clips & molded ends	2DR HTP CNV	61-62 Chevrolet Bel Air Impala, Cad Series 62, Deville, 61-62 Oldsmobile, 61 Hardtop Convertible 88 Star Fire, Oldsmobile 98/62 Oldsmobile 88 Oldsmobile 98 Starfire, 61-62 Buick 61 Hardtop Convertible, 62 Convertible Only LeSabre Invicta Electra, 61-62 Pontiac, 2 Door Hardtop Convertible	2013
D		61-62-63-64	Door weatherstrip with clips	2DR SDN	61-64 Chevrolet, Pontiac, Buick, Oldsmobile, 2 Door Sedan	2005
D		61-62-63-64	Door weatherstrip rear door with clips	4DR SDN	61-64 Chevrolet Biscayne Bel Air Impala, 61-64 Oldsmobile 88, 98, 61-62 Cadillac, 61-64 Buick LeSabre Electra, 64 Wildcat, 61-64 Pontiac Catalina, Star Chief, 4 Door Sedan	2009
D		61-62-63-64	Door weatherstrip rear with clips	4dr SWG	61-64 Chevrolet Biscayne, Bel Air, Impala, 61-64 Oldsmobile 88, 61-64 Buick LeSabre, 62-63 Invicta 63-64 Wildcat, 61-64 Pontiac Catalina, Bonneville, 4 Door Station Wagon	2018
D		61-62-63-64	Door weatherstrip, rear doors with clips & molded ends	4DR HTP	61-64 Chevrolet Impala, Buick LeSabre, Oldsmobile Wildcat, 88, Pontiac Catalina Starchief Bonneville 4 Door Hardtop	2122
D		63-64	Front door weatherstrip with molded ends	4DR HTP	63-64 Chevrolet Biscayne, Bel Air, Impala, Buick Wildcat, LeSabre, Electra, Pontiac Catalina, Star Chief, Bonneville, Oldsmobile Dynamic 88, 98 4 Door Ht	2121



GUIDE TO SOFFSEAL'S PRODUCT CODES











B = Bumper sets **C** = Glass channels **D** = Door related **G** = Seals, gaskets **H** = Under hood items **I** = Interior parts
M = Miscellaneous items **R** = Roofrail, pillar post & convertible items **T** = Trunk related **W** = Window related **Z** = Weatherstrip kits



CODE	IMAGE	YEAR	DESCRIPTION	BODY	FITS	ITEM#
D		63-64	Door weatherstrip with clips & molded ends	2DR HTP CNV	63-64 Chevrolet Impala, 63-64 Cadillac Eldorado, Deville, 63-64 Oldsmobile 88 Oldsmobile 98 Starfire 63-64 Buick LeSabre Wildcat, Electra 63 Invicta, 63-64 Pontiac Catalina, Bonneville, Grand Prix, 2 Door Hardtop Convertible	2014
D		63-64	Door weatherstrip front with clips	4DR SDN SWG	63-64 Chevrolet Biscayne, Bel Air, Impala, 63-64 Cadillac, 63-64 Oldsmobile 88, 63-64 Buick LeSabre, Wildcat, 63-64 Pontiac, 4 Door Sedan Station Wagon	2017
D		65-66	Door weatherstrip front with clips	4DR SDN SWG	65-66 Chevrolet Biscayne Bel Air Impala, 65-66 Cadillac Calais Deville Fleetwood, 65-66 Oldsmobile 88, 65-66 Buick LeSabre Wildcat, 65-66 Pontiac Bonneville, Catalina, Star chief, 4 Door Sedan Swg	2006
D		65-66	Rear door weatherstrip with clips	4DR SDN	65-66 Chevrolet Biscayne Bel Air Impala 65-66 Cadillac Calais Deville Fleetwood 65-66 Oldsmobile 88, 65-66 Buick LeSabre Wildcat, 65-66 Pontiac Catalina, Star Chief, 4 Door Sedan	2007
D		65-66	Door weatherstrip rear doors with clips & molded ends	4DR HTP	65-66 Buick, LeSabre, Wildcat, 4 Door Hardtop	2208
D		65-66	Door weatherstrip with clips & molded ends	2DR HTP CNV	65-66 Chevrolet Impala, Caprice, 65-66 Cadillac Calais, Deville, 65-66 Oldsmobile 88, Starfire, Oldsmobile 98, 65 Jet Star, 65-66 Buick LeSabre, Wildcat Electra, 65-66 Pontiac 2 Door Hardtop Convertible	2331
D		65-66-67-68	Door weatherstrip front door with clips & molded ends	4DR HTP	65-68 Chevrolet Impala, Buick, Wildcat, LeSabre, Cadillac Calais, Deville, Oldsmobile 98 Oldsmobile 99, Pontiac, 4 Door Hardtop	2210
D		67-68	Front door weatherstrip with clips	4DR SDN SWG	67-68 Chevrolet Biscayne, Bel Air, Impala, 67-68 Cadillac Calais, Deville, Fleetwood, 67-68 Oldsmobile Delmont 88, Delta 88, 98, 67-68 Buick LeSabre, Wildcat, Electra 67-68 Pontiac Catalina, Executive, Bonneville, 4 Door Sedan Station Wagon	23321
D		67-68	Door weatherstrip rear with clips	4DR SDN	67-68 Chevrolet Biscayne, Bel Air, Impala, 67-68 Cadillac Calais, Deville, Fleetwood, 67-68 Oldsmobile 88, 67-68 Buick LeSabre, Wildcat, 67-68 Pontiac Bonneville Station Wagon, 67-68 Pontiac Executive, Catalina, 4 Door Sedan	23322
D		69-70	Door weatherstrip with clips & molded ends	2DR HTP CNV	69-70 Chevrolet Impala, Caprice, 69-70 Cadillac Calais, Deville, 69-70 Oldsmobile 88 Oldsmobile 98, 69-70 Buick LeSabre, Wildcat, Electra, 69-70 Pontiac Catalina, Bonneville, Executive, 2 Door Hardtop Convertible	2357
D		71-72-73-74	Door weatherstrip rear door with clips & molded ends	4DR HTP	71-74 Chevrolet Caprice, Impala, Buick LeSabre, Centurion, Oldsmobile 88, Pontiac, 4 Door Hardtop	2214

Buick • LeSabre

BUICK • LeSabre

CODE	IMAGE	YEAR	DESCRIPTION	BODY	FITS	ITEM#
D		71-72-73-74-75-76	Door weatherstrip front doors with clips & molded ends	4DR HTP	71-76 Chevrolet Caprice, Impala, Buick, Electra, LeSabre, Centurion, Cadillac Calais, Deville, Oldsmobile 88 Oldsmobile 98, Catalina, Bonneville, Granville, 4 Door Hardtop	2213
D		71-72-73-74-75-76	Door weatherstrip with clips & molded ends	2DR HTP CNV	71-76 Chevrolet Impala, Caprice, Cadillac Calais, Deville, Buick 71-73 LeSabre, Centurion, Electra, 74-76 LeSabre, Electra, Oldsmobile 88 Oldsmobile 98, Pontiac Bonneville, Catalina, 71-75 Grandville 2 Door Hardtop Convertible	2512
D		75-76	Rear Door weatherstrip with clips & molded ends	4DR HTP	75-76 Chevrolet Impala, Caprice, Buick, LeSabre, Centurion, Oldsmobile 88, Pontiac, 4 Door Hardtop	2216
D		77-78-79-80-81-82-83-84-85-86	Front door weatherstrip with clips	4DR SDN RWD	77-86 Impala Caprice, 77-84 Cadillac Deville Fleetwood, 85-86 Fleetwood, 77-84 Oldsmobile 88 89, 85 88, 77-84 Buick LeSabre Electra 85 LeSabre, 77-79 Buick Estate Wagon, 82-83 Buick Park Ave 77-81 Pontiac Bonneville, 83-86 Pontiac Parisienne, 77-80 Pontiac Catalina 4 Door Sedan, RWD Only	2500
D		77-78-79-80-81-82-83-84-85-86-87	Door weatherstrip with clips	2DR SDN RWD	84-87 Chevrolet Caprice, 77-81 Chevrolet Impala, 83 Chevrolet, 77-84 Cadillac Deville, 80-84 Fleetwood, 77-84 Oldsmobile 88 Oldsmobile 98, 85 Oldsmobile 88, 77-84 Buick LeSabre, Electra, 85 LeSabre, 77-81 Pontiac Bonneville, Catalina 2 Door Sedan, RWD Only	2359
D		77-78-79-80-81-82-83-84-85-86-87-88-89-90	Rear door weatherstrip with clips	4DR SDN RWD	77-86 Chevrolet Impala Caprice, 87-88 Caprice Caprice Classic, 89 Caprice, 90 Caprice Caprice Classic, 77-84 Cadillac Deville, 77-85 Oldsmobile 88, 77-78 Town Sedan, Custom Crusier, 77-84 Buick LeSabre Electra 85 LeSabre, 77-81 Pontiac Bonneville, Catalina, 83-86 Pontiac Parisienne 4 Door Sedan, RWD Only	2502
D		85-86-87-88-89-90-91	Door weatherstrip front with clips	4DR SDN FWD SWG	85-91 Buick Electra, Oldsmobile 98, 86-91 Buick LeSabre, Oldsmobile 88, 87-91 Pontiac Bonneville, 85-90 Park Avenue, 4 Door Sedan Fwd Station Wagon	2605
D		86-87-88-89-90-91	Rear door weatherstrip with clips	4DR SDN FWD	86-91 Buick LeSabre, Oldsmobile 87-91 Pontiac Bonneville, 4 Door Sedan Fwd	2603
D		86-87-88-89-90-91	Door weatherstrip with clips	2DR SDN FWD	86-91 Buick Regency LeSabre 85-87 Electra 86-91 Old Delta 88, 2 Door Sedan, FWD	2604
G		60-63-64-69-70	Door handle & lock gaskets	2DR 4DR HTP 2DR SDN CNV SWG	60 Chevrolet Biscayne, Impala, Bel Air, Cadillac, Oldsmobile 89 Oldsmobile 98, Buick LeSabre, Invicta, Electra, Wild Cat, Pontiac Catalina, Star Chief, Bonneville, Grand Prix, Ventura	2098
G		61-62-65-66-67-68	Door handle & lock gaskets	2DR 4DR HTP 2DR SDN CNV SWG	61-62 Chevrolet Biscayne, Bel Air, Impala, Cadillac, Oldsmobile 88 Oldsmobile 98, Buick LeSabre, Invicta, Electra, Pontiac	2145















GUIDE TO SOFFSEAL'S PRODUCT CODES

B = Bumper sets **C** = Glass channels **D** = Door related **G** = Seals, gaskets **H** = Under hood items **I** = Interior parts
M = Miscellaneous items **R** = Roofrail, pillar post & convertible items **T** = Trunk related **W** = Window related **Z** = Weatherstrip kits



CODE	IMAGE	YEAR	DESCRIPTION	BODY	FITS	ITEM#
G		71-72-73-74-75-76-77-78	Door handle gaskets	2DR HTP CNV 2DR SDN	71-76 Buick LeSabre, Electra, Oldsmobile 98 Oldsmobile 88, 71-78 Toronado, Cadillac, 74-76 Riviera	2514
H		64-65-66-67-68-69-70-71-72	Firewall wiring gutter plk	2DR 4DR HTP 2DR SDN SWG CNV	Chevy Chevelle, Biscayne, Bel Air, Impala, Caprice, Nova, Camaro, Cadillac Calais, Deville, Fleetwood, Oldsmobile 88, 98, Jetstar, Starfire, Pontiac Catalina, Bonneville, Firebird, Buick LeSabre, Wildcat, Electra	2328
H		67-68	Hood insulation	2DR 4DR HTP 2DR SDN CNV	67-68 Buick LeSabre, Wildcat, Electra	23911
H		71-72-73-74-75-76-77-78	Hood to cowl seal	2DR SDN 2DR HTP CNV SWG	71-78 Chevrolet Impala, Caprice, Biscayne, Bel Air, Brookwood, Townsman, Kingswood, Buick LeSabre, Centurion, Electra 225, Estate Wagon, Cadillac Calais, Deville, Eldorado, Sixty Special Brougham, Oldsmobile 88, 98, Toronado, Pontiac Catalina, Bonneville, Grandville, Safari Full Size	2191
I		59-60-61-62-63-64-65-66	Gear shift grommet column	2DR 4DR SDN HTP CNV	59-66 Chevrolet Biscayne, Bel Air, Impala, 59-66 Cadillac, 59-63 Oldsmobile 88 Oldsmobile 98, 61 Starfire, 64-66 Starfire, Jet Star, 59-66 Buick LeSabre, Invicta, Electra, 63 Wildcat, Riviera, 59-66 Pontiac	2185A
I		64-65-66-67-68-69-70-71-72-73-74	Park brake pedal pad	2DR HTP CNV	El Camino Cutlass Chevelle Chevy II Camaro Firebird LeMans Tempest GTO Grand Prix Full Size Centurion Century Electra Invicta LeSabre Regal Riviera Skylark Wildcat Monte Carlo	3094
R		58-59-60-61-62-63-64	Header seal	CNV	Chevy Impala, Cadillac Series 62 Eldorado, Pontiac Catalina, Bonneville, Oldsmobile 88, 98, Starfire, Buick LeSabre, Invicta, Electra	2153
R		59-60	Roofrail weatherstrip with clips	2DR HTP	59-60 Chevrolet, Cadillac, Pontiac, Oldsmobile, Buick, 2 Door Hardtop	2090
R		59-60	Pillar post weatherstrip with clips and molded ends	CNV	59-60 Chevrolet Impala, Cadillac Eldorado Series 62, Pontiac Bonneville, Catalina, Oldsmobile 88 Oldsmobile 98, Buick LeSabre, Invicta, Electra	2091
R		59-60	Weatherstrip kit for convertible top with header seal	CNV	59-60 Chevrolet Impala, Cadillac, Oldsmobile 88, Buick LeSabre, Invicta, Pontiac, Convertible	2092
R		59-60	Roofrail weatherstrip	4DR HTP	59-60 Chevrolet Bel Air, Buick Impala, LeSabre, Invicta, 4 Door Hardtop	2220
R		61	Roofrail weatherstrip with molded ends	2DR HTP	61 Chevrolet, Buick, Oldsmobile, Pontiac 2 Door Hardtop	2129
R		61-62	Roofrail weatherstrip	4DR HTP	61-62 Chevrolet Bel Air, Impala, Buick, LeSabre, Invicta, Oldsmobile 88, Pontiac, 4 Door Hardtop	2223
R		61-62	Weatherstrip Kit For Convertible Top With 6-5/8 Between Center Stud	Cnv	61-62 Chevrolet Impala, 61-62 Olds 88, Starfire, 61 Buick LeSabre, 61-62 Invicta, 61-62 Pontiac, Catalina Bonneville Convertible	2156

Buick • LeSabre

CODE	IMAGE	YEAR	DESCRIPTION	BODY	FITS	ITEM#
R		62	Pillar post weatherstrip with molded ends	CNV	61-62 Chevrolet Impala, 61-62 Cadillac 61 Series 6200, Eldorado 62 Eldorado, 61-62 Oldsmobile 88 Oldsmobile 98, Starfire, 61-62 Buick Electra, Invicta, LeSabre, 61-62 Catalina, Bonneville, Convertible	2154
R		62	Roofrail weatherstrip with molded ends	2DR HTP	62 Chevrolet Impala, 62 Cadillac, 62 Oldsmobile 88, 62 Buick LeSabre, Invicta, Pontiac 2 Door Hardtop	2164
R		62-63-64	Weatherstrip kit for convertible top second type with 5 3/8" between center studs	CNV	62-64 Chevrolet Impala, Oldsmobile 88, Starfire, Buick LeSabre, Invicta, Pontiac, Bonneville, Catalina, 63-64 Buick Wildcat Convertible	2152
R		62-63-64	Weatherstrip kit for convertible top with 5 3/8" between center studs cloth covered	CNV	62-64 Chevrolet Impala, Cadillac, Oldsmobile 88, Starfire, Buick LeSabre, Invicta, Wildcat, Pontiac Catalina, Bonneville	2152C
R		63-64	Pillar post weatherstrip with molded ends	CNV	63-64 Chevrolet Impala, 63-64 Cadillac 63 Series 6200, Eldorado 64 Deville, Eldorado, 63-64 Oldsmobile 88 Oldsmobile 98, Starfire, 63-64 Buick LeSabre, Wildcat, 63-64 Pontiac, Convertible	2193
R		63-64	Roofrail weatherstrip with molded ends	2DR HTP	63-64 Chevrolet Impala, 63-64 Cadillac, 63-64 Oldsmobile 88, 63-64 Buick LeSabre, Wildcat, 63-64 Pontiac 2 Door Hardtop	2194
R		63-64	Roofrail weatherstrip with molded ends	4DR HTP	63-64 Chevrolet Impala, Buick LeSabre, Wildcat, Oldsmobile 88, Pontiac, 4 Door Hardtop	2194A
R		65	Weatherstrip kit for convertible top	CNV	65 Chevrolet Impala, 65 Cadillac, 65 Oldsmobile, 65 Buick LeSabre, Wildcat, 65 Pontiac, Convertible	2365
R		65	Pillar post weatherstrip with molded ends	CNV	65 Chevrolet Impala, 65 Cadillac Deville, Eldorado, 65 Oldsmobile 88 Oldsmobile 98, 65 Buick LeSabre, Wildcat, Electra, Invicta, 65 Pontiac, Convertible	2334
R		65-66	Roofrail weatherstrip with molded ends	2DR HTP	65-66 Chevrolet Impala, Caprice, 65-66 Cadillac Calais, Deville, 65-66 Oldsmobile 88, Jet Star, Star Fire, Oldsmobile 98, 65-66 Buick LeSabre, Wildcat, Electra, 65-66 Pontiac 2 Door Hardtop	2333
R		65-66	Roofrail weatherstrip with molded ends	4DR HTP	65-66 Chevrolet Impala, Caprice, 65-66 Cadillac, 65-66 Oldsmobile 88, 65-66 Buick LeSabre, 65-66 Pontiac, 4 Door Hardtop	2333A
R		65-66-67-68-69-70	Header seal with clips and molded ends	CNV	65 Chevrolet, 66-70 Chevrolet Impala, 65-70 Cadillac Deville, 65-70 Oldsmobile 88 Oldsmobile 98, 65 Oldsmobile Starfire, 65-70 Buick LeSabre, Wildcat, Electra, 65-70 Pontiac, Convertible	23343
R		66-68	Pillar post weatherstrip with molded ends	CNV	66-68 Chevrolet Impala, 66-68 Cadillac Deville, 66 Cadillac Eldorado, 66-68 Oldsmobile 88 Oldsmobile 98, 66-68 Buick Electra, LeSabre, Wildcat, 66-68 Pontiac, Convertible	23341







GUIDE TO SOFFSEAL'S PRODUCT CODES

B = Bumper sets **C** = Glass channels **D** = Door related **G** = Seals, gaskets **H** = Under hood items **I** = Interior parts
M = Miscellaneous items **R** = Roofrail, pillar post & convertible items **T** = Trunk related **W** = Window related **Z** = Weatherstrip kits



CODE	IMAGE	YEAR	DESCRIPTION	BODY	FITS	ITEM#
R		66-67-68-69-70	Weatherstrip kit for convertible top includes header seal (7 piece kit)	CNV	66-70 Chevrolet Impala, 66-70 Oldsmobile 88, 66-70 Buick LeSabre, Wildcat, 66-70 Pontiac Bonneville, Catalina, 67 Pontiac Grand Prix, Convertible	2366
R		67-68	Roofrail weatherstrip with thick c pillar section	4DR HTP	67-68 Chevrolet Impala, Caprice, Buick LeSabre, Wildcat, Pontiac Bonneville, Catalina, Executive 4 Door Hardtop	2351
R		69-70	Roofrail weatherstrip with molded ends	2DR HTP	69-70 Chevrolet Caprice, Impala, 69-70 Cadillac, 69-70 Oldsmobile 88, 69-70 Buick LeSabre, Wildcat, 69-70 Pontiac 2 Door Hardtop	2356
R		69-70	Roofrail weatherstrip	4DR HTP	69-70 Chevrolet Impala, Caprice, 69-70 Oldsmobile 88 Oldsmobile 98, 69-70 Buick LeSabre, Wildcat, Electra, 69-70 Pontiac Catalina, Bonneville, Executive 4 Door Hardtop	23561
R		69-70	Pillar post weatherstrip with molded ends	CNV	69-70 Chevrolet Impala, Caprice, 69-70 Cadillac Deville, 69-70 Oldsmobile 88 Oldsmobile 98, 69-70 Buick LeSabre, Wildcat, Electra, 69-70 Pontiac, Convertible	2358
R		71-72-73	Roofrail weatherstrip	2DR HTP	71-73 Chevrolet Impala, 71-73 Cadillac, 71-73 Oldsmobile 88, 71-73 Pontiac, 2 Door Hardtop	2420
R		71-72-73-74	Roofrail weatherstrip	4DR HTP	71-74 Chevrolet Caprice, Impala, Buick LeSabre, Centurion, Oldsmobile 88, Pontiac Catalina, Bonneville 4 Door Hardtop	2221
R		71-72-73-74-75	Roofrail weatherstrip	2DR HTP	71-73 Impala Custom Coupe Caprice, 74-75 Impala Sport Coupe, 71-76 Cadillac Calais Deville, 71-74 Electra, 74-76 LeSabre, 71-71 98, 74 Oldsmobile 98 Oldsmobile Delta 88, 75-76 Oldsmobile Delta 88, 71-73 Grandville, 74 Bonneville Catalina Grandville, 75-76 Catalina, 2 Door Hardtop	2509
R		71-72-73-74-75-76	Weatherstrip kit for convertible top	CNV	71-72 Chevrolet Impala, 73-76 Caprice, 71-76 Cadillac Eldorado, 71-75 Oldsmobile Delta 88, 71,72, 74 Buick LeSabre 71-73 Centurion, 71-72 Pontiac Catalina, 71-75 Grandville Convertible	2508
R		71-72-73-74-75-76	Header seal	CNV	71-75 Chevrolet Impala, Caprice, 71-72 Oldsmobile 88, 71-75 Pontiac Catalina, Grandville, 71-75 Buick LeSabre, Centurion, 71-76 Cadillac Eldorado, Convertible	2515
R		71-72-73-74-75-76	Pillar post weatherstrip with molded ends	CNV	71-75 Chevrolet Impala, Caprice 71-72 Oldsmobile 88, 71-75 Pontiac Catalina, Grandville, 71-75 Buick LeSabre, Centurion 71-76 Cadillac Eldorado, Convertible	2094

CODE	IMAGE	YEAR	DESCRIPTION	BODY	FITS	ITEM#
T		58-59-60-61-62-63-64-65-66-67-68-69	Trunk weatherstrip exact profile	2DR 4DR HTP 2DR SDN CNV	58-64 Chevrolet Biscayne, 58-64 Chevrolet Bel Air, Chevrolet Impala, 60-69 Chevrolet Corvair, 59-64 Pontiac Parisienne, 59-64 Pontiac Catalina, 59-64 Pontiac Star Chief, 60-61 Pontiac Ventura, 62-64 Pontiac Grand Prix, 58-64 Oldsmobile Delta 88, 58-64 Oldsmobile Dynamic 88, Oldsmobile Super 88, Oldsmobile Super 98, 61-64 Oldsmobile Starfire, 64 Oldsmobile Jetstar, 59-64 Buick LeSabre, 59-62 Buick Invicta, 59-64 Buick Electra, 62-64 Buick Wildcat, 63-65 Buick Riviera, 58-60 Cadillac Deville, Cadillac Eldorado, Cadillac Series 62, Cadillac Series 60 Special, Cadillac Series 75, 58-64 C-Body	2001
T		62-63-64-65-66-67-68-69-70-71-72-73	Door and tailgate bottom drain hole seal	2DR 4DR HTP SDN CNV SWG CPE	62-73 Chevy Nova, Chevelle, Impala, Caprice Pontiac Catalina, Star Chief, Bonneville, Grand Prix Oldsmobile F85	2118
T		64-65-66-67-68-69-70-71-72-73-74-75-76-77	Trunk weatherstrip exact profile length 17 feet	2DR 4DR HTP 2DR SDN CNV	65-72 Chevy II, 65-72 Chevrolet Biscayne, 65-75 Chevrolet Bel Air, 65-76 Chevrolet Impala, 65-76 Chevrolet Caprice, 64-77 Chevrolet Chevelle, 70-77 Chevrolet Monte Carlo, 65-76 Buick LeSabre, 64-77 Buick Wildcat, 64-77 Buick Skylark, 71-73 Buick Centurion, 64-72 Buick Grand Special, 73-77 Buick Century, 73-88 Buick Regal, 73-88 Buick Grand National, 65-76 Buick Electra, 65-76 Oldsmobile Delta 88, 67-69 Oldsmobile Delmont 88, 65-66 Oldsmobile Dynamic 88, 65-66 Oldsmobile Starfire, 65 Oldsmobile Jetstar, 64-77 Oldsmobile Cutlass 442, 64-88 Oldsmobile Cutlass, 65-76 Oldsmobile 98, 65-76 Pontiac Parisienne, 64-72 Pontiac LeMans, 65-70 Pontiac Catalina, 65-66 Pontiac Star Chief, 67-70 Pontiac Executive, 71-75 Pontiac Grand Ville, 65-77 Pontiac Grand Prix, 64-72 Pontiac Tempest, 62-72 Nova, Ventura, 73-74 Non-Hatchback, Up to 1975 with groove channel, Apollo, Nova, Omega, Ventura 65-76 C-Body	2003
T		75-76-77-78-79-80-81-82-83-84-85-86-87-88-89-90-91-92	Trunk and Hatchback weatherstrip	2DR 4DR SDN HTP CNV	77-85 Chevrolet Impala, 77-91 Chevrolet Caprice, 82-92 Chevrolet Camaro, 75-79 Chevrolet Nova, 78-88 Chevrolet Monte Carlo, 78-83 Chevrolet Malibu, 78-83 Pontiac LeMans, 82-92 Pontiac Firebird, 75-91 Pontiac Ventura, 77-86 Pontiac Parisienne, 77-81 Pontiac Catalina, 69-88 Pontiac Grand Prix, 64-87 Pontiac LeMans, Pontiac Grand Am, 64-77 Pontiac GTO, 73-79 Oldsmobile Omega, 77-85 Oldsmobile Delta 88, 77-84 Oldsmobile 98, 77-88 Oldsmobile Cutlass, 73-75 Buick Apollo, 76-79 Buick Skylark, 77-79 Phoenix, 73-88 Buick Regal, 77-84 Buick Electra, 77-85 Buick LeSabre, 77-78 Buick Riviera, 77-91 C-Body	2424













GUIDE TO SOFFSEAL'S PRODUCT CODES

B = Bumper sets **C** = Glass channels **D** = Door related **G** = Seals, gaskets **H** = Under hood items **I** = Interior parts
M = Miscellaneous items **R** = Roofrail, pillar post & convertible items **T** = Trunk related **W** = Window related **Z** = Weatherstrip kits



CODE	IMAGE	YEAR	DESCRIPTION	BODY	FITS	ITEM#
W		58-59-60	Quarter window u-jamb	CNV	58-60 Chevrolet Impala, 58 Cadillac, 59-60 Cadillac Series 62, Eldorado, 58-60 Oldsmobile 88 Oldsmobile 98, 58 Buick, 59-60 Buick LeSabre, Invicta, Electra, 58 Pontiac, Convertible	2286
W		58-59-60-61-62-63-64	Quarter window seals	2DR HTP CNV	58-64 Chevrolet Impala, 58, 60-62 Bel Air, 58-64 Cadillac Series 62, Deville, Eldorado, 58 Oldsmobile 88 Oldsmobile 98, 59-60 Oldsmobile 88 Oldsmobile 98, 61-64 Oldsmobile 99, Starfire, 98, 64 Jetstar, 59-62 Buick LeSabre, Invicta, Electra 2 Door Hardtop Convertible	2300
W		59-60	Rear quarter stationary vent window seals	4DR SDN	59-60 Chevrolet Buick, Style 4419, 4619, 4719 Oldsmobile, Pontiac 4 Door Sedan	2053
W		61-62	Vent window seals	2DR 4DR HTP CONV	61-62 Chevrolet Bel Air, Impala, 61-62 Cadillac Series 62, Eldorado, 61-62 Oldsmobile 88 Oldsmobile 98, 61-62 Buick LeSabre, Invicta, Electra, 61-62 Pontiac Bonneville, Catalina, Ventura 2 Door 4 Door Hardtop, Convertible	21615
W		61-62-63-64-65-66	Horizontal outer window seals	2DR 4DR HTP SDN CNV SWG	Chevy Biscayne, Bel Air, Impala, Caprice, Cadillac series 62 Deville, Eldorado, Fleetwood, Calais, Oldsmobile 88, Starfire, 98. Buick LeSabre, Invicta, Wildcat, Electra, Pontiac Catalina, Ventura, Star Chief, Bonneville	2310
W		63-64	Vent window seals	2DR HTP CNV	63-64 Chevrolet Impala, Buick Electra, LeSabre, Wildcat, Oldsmobile 98, Pontiac Catalina, Bonneville, 2 Door Hardtop Convertible, Starfire Convertible Only	21814
W		63-64	Vent window weatherstrip	2DR 4DR HTP	63-64 LeSabre Wildcat Coupe Deville Starfire Grand Prix	21815
W		63-64	Vent window weatherstrip	2DR 4 DR SDN SWG	63-64 Chevrolet, Buick LeSabre, Oldsmobile, Pontiac 2 & 4 Door Sedan And Station Wagon	2283
W		65-66	Quarter window seals	2DR HTP CNV	65-66 Chevrolet Impala, 66 Chevrolet Caprice, 65-66 Cadillac Calais, Deville 65-66 Oldsmobile 88, Jetstar, 65-66 Buick LeSabre, Wildcat, 65-66 Pontiac Bonneville, Catalina, Star Chief 2 Door Hardtop Convertible	2301
W		65-66	Quarter window seals	4DR HTP	65-66 Chevrolet Impala, 66 Chevrolet Caprice, 65-66 Cadillac Calais, Deville, 65-66 Oldsmobile 88 Oldsmobile 98, 65-66 Buick LeSabre, Wildcat, Electra, 65-66 Pontiac Bonneville, Catalina, Star Chief 4 Door Hardtop	23011
W		65-66	Door u-jamb seal	2DR HTP CNV	65-66 Chevrolet Impala, 66 Caprice, 65-66 Cadillac Calais, Deville, Eldorado, 65-66 Oldsmobile 88, Jetstar, Starfire, Oldsmobile 98, 65-66 Buick LeSabre, Wildcat, Electra, 65 Pontiac Bonneville, Catalina, Star Chief 2hardtop Convertible	2368



CODE	IMAGE	YEAR	DESCRIPTION	BODY	FITS	ITEM#
W		65-66-67-68	Vent window weatherstrip	2DR HTP CNV	65-68 Chevrolet Impala, Buick LeSabre, Electra, Wildcat, Cadillac Calais, Deville, Oldsmobile 88 Oldsmobile 98 Starfire, Pontiac Bonneville, Catalina, Star Chief 2 Door Hardtop Convertible	2217
W		65-66-67-68	Glass run channel front window	2DR HTP CNV	65-68 Chevrolet Impala, Caprice, 65-68 Cadillac Calais, Deville 65-66 Eldorado, 65-68 Oldsmobile 88 Oldsmobile 98, 65-66 Oldsmobile Jetstar, Starfire, 65-68 Buick LeSabre, Wildcat, Electra, 65-68 Pontiac Bonneville, Catalina, Executive 2 Door Hardtop Convertible	2350
W		67-68	Quarter window u-jamb	2DR HTP CNV	67-68 Chevrolet Impala, 67-68 Cadillac Calais, Deville, 67 Oldsmobile 98, 67-68 Buick LeSabre, Wildcat, Electra, 67-68 Pontiac Bonneville, Catalina 2 Door Hardtop	2292
W		67-68	Quarter window seals	2DR HTP	67-68 Chevrolet Impala, 67-68 Cadillac Calais, Deville 67-68 Oldsmobile 88, 98, 67-68 Buick LeSabre, Wildcat, Electra 67-68 Pontiac Catalina, Bonneville, Executive 2 Door Hardtop	2302
W		67-68	Quarter window seals	CNV	67-68 Chevrolet Impala, 67-68 Cadillac Deville, 67-68 Oldsmobile 88 Oldsmobile 98, 67-68 Buick LeSabre, Wildcat, Electra, 67-68 Pontiac Catalina, Bonneville Convertible	23021
W		67-68	Quarter window u-jamb	2 DR CNV HTP	67-68 Chevy Impala Convertible 68 Caprice Sport Coupe, 67 Buick LeSabre, Wildcat Convertible, 67 Electra 2 Door Hardtop & Convertible, 68 Buick Wildcat, Electra, LeSabre 2 Door Hardtop & Convertible, 67 Cadillac Deville Convertible, 68 Cadillac Calais, Deville Hardtop & Convertible 67-68 Oldsmobile 88, Oldsmobile 98, 67-68 Pontiac Catalina, Bonneville, Executive, Grand Prix Hardtop & Convertible	2294
W		69-70	Qtr window u jamb	CNV 2DR HTP	69-70 Chevrolet Impala, 69-70 Cadillac, Eldorado, 69-70 Oldsmobile 88 Oldsmobile 98, 69-70 Buick LeSabre, Wildcat, 69 Pontiac Catalina, Executive, Bonneville Convertible 2 Door Hardtop	2293
W		71-72-73	Qtr window u jamb	2DR HTP CNV	71-73 Buick LeSabre, Electra, Riviera, Chevrolet Impala, Caprice, Cadillac Calais, Deville, Oldsmobile 88 Oldsmobile 98, Pontiac Catalina, Bonneville, Grandville 2 Door Hardtop Convertible	2600
W		71-72-73-74-75-76	Quarter window seals	2DR HTP CNV	71-75 Chevrolet Impala, Caprice, 71-76 Cadillac Eldorado Convertible Only, 71-76 Oldsmobile 88, 76 Oldsmobile 98, 71-73 Buick LeSabre, 71-73 Centurion, 71-75 Pontiac Catalina, Bonneville, Grandville 2 Door Hardtop Convertible	2308
W		71-72-73-74-75-76	Quarter window seals	4DR HTP	71-75 Chevrolet Impala, Caprice, Cadillac Calais, Deville, Pontiac Catalina, Bonneville, Grandville Buick LeSabre, Electra, Oldsmobile 88, 98, 4 Door Hardtop	2309







GUIDE TO SOFFSEAL'S PRODUCT CODES

B = Bumper sets **C** = Glass channels **D** = Door related **G** = Seals, gaskets **H** = Under hood items **I** = Interior parts
M = Miscellaneous items **R** = Roofrail, pillar post & convertible items **T** = Trunk related **W** = Window related **Z** = Weatherstrip kits



CODE	IMAGE	YEAR	DESCRIPTION	BODY	FITS	ITEM#
W		74-75-76	Quarter window u-jamb	2DR HTP CNV	Impala Caprice LeSabre Electra Eldorado Oldsmobile Delta 88 Oldsmobile 98, Tornado Delta Bonneville Catalina Grandville Catalina	2295
W		77-78-79-80-81-82-83-84-85-86-87-88-89-90	Window weatherstrip outers only, rwd with chrome bead	2DR SDN	77-90 Chevrolet Impala, Caprice, Buick LeSabre, Electra, Oldsmobile 88 Oldsmobile 98, Pontiac Catalina, Bonneville, Cadillac Deville, 2 Door Sedan	2369
W		77-78-79-80-81-82-83-84-85-86-87-88-89-90	Window weatherstrip, outers only, rwd, with o chrome bead	2DR SDN	77-90 Chevrolet Impala, Caprice, Buick LeSabre, Electra, Oldsmobile 88 Oldsmobile 98, Pontiac Catalina, Bonneville, Cadillac Deville, 2 Door Sedan	23691

Buick • Park Avenue

CODE	IMAGE	YEAR	DESCRIPTION	BODY	FITS	ITEM#
D		77-78-79-80-81-82-83-84-85-86	Front door weatherstrip with clips	4DR SDN RWD	77-86 Impala Caprice, 77-84 Cadillac Deville Fleetwood, 85-86 Fleetwood, 77-84 Oldsmobile 88 89, 85 88, 77-84 Buick LeSabre Electra 85 LeSabre, 77-79 Buick Estate Wagon, 82-83 Buick Park Ave 77-81 Pontiac Bonneville, 83-86 Pontiac Parisienne, 77-80 Pontiac Catalina 4 Door Sedan, RWD Only	2500
D		77-78-79-80-81-82-83-84-85-86-87-88-89-90	Door weatherstrip rear door with clips	4DR SDN RWD	77-90 Chevrolet, 77-90 Cadillac Fleetwood, 77-84 Oldsmobile 98, 77-84 Buick Electra, Park Avenue 77-90 Pontiac, 4 Door Sedan, RWD Only	23591
D		85-86-87-88-89-90	Door weatherstrip rear with clips	4DR SDN FWD	85-90 Buick Park Avenue, Electra, Oldsmobile 98, 4 Door Sedan Fwd	2606
D		85-86-87-88-89-90-91	Door weatherstrip front with clips	4DR SDN FWD SWG	85-91 Buick Electra, Oldsmobile 98, 86-91 Buick LeSabre, Oldsmobile 88, 87-91 Pontiac Bonneville, 85-90 Park Avenue, 4 Door Sedan Fwd Station Wagon	2605









GUIDE TO SOFFSEAL'S PRODUCT CODES

B = Bumper sets **C** = Glass channels **D** = Door related **G** = Seals, gaskets **H** = Under hood items **I** = Interior parts
M = Miscellaneous items **R** = Roofrail, pillar post & convertible items **T** = Trunk related **W** = Window related **Z** = Weatherstrip kits



CODE	IMAGE	YEAR	DESCRIPTION	BODY	FITS	ITEM#
B		47-48-49-50-51-52-53-54-55-56-57-58-59-60-61-62-63-64-65-66-67-68-69-70-71-72-73-74-75-76-77-78-79-80-81-82-83-84-85-86-87	Glove box door bumpers	2DR 4DR HTP 2DR SDN CNV SWG TRK	All Chevrolet, Pontiac, Oldsmobile, Buick 47-87 Chevrolet, Gmc Truck	1069
B		69	License panel bumpers rear	2DR 4DR SDN HTP CNV	69 Chevrolet Camaro, Pontiac Firebird, 64-72 Chevrolet Chevelle, Pontiac Tempest, LeMans, GTO, Grand Prix, Oldsmobile Cutlass, Buick Special, Skylark	31151
D		73-74-75-76-77	Door weatherstrip with clips & molded ends	2DR HTP	Grand Am 2 Door 73-77 Chevrolet, LeMans, Grand LeMans, Century, Regal, Cutlass, Chevelle Malibu Laguna, El Camino, 2 Door Hardtop	5017
D		78-79-80-81-82-83-84-85-86-87	Door weatherstrip rear door with clips	4DR SDN	78-87 Chevrolet Malibu, Buick Regal, Oldsmobile Cutlass, Pontiac LeMans, 4 Door Sedan	5037
D		78-79-80-81-82-83-84-85-86-87	Door weatherstrip rear door with clips	SWG	78-87 Chevrolet Malibu, Buick Regal, Oldsmobile Cutlass, Pontiac LeMans, Station Wagon	5038
D		78-79-80-81-82-83-84-85-86-87-88	Door weatherstrip a-body with clips & molded ends	2DR HTP	78-88 Chevrolet Malibu, El Camino, Monte Carlo, Oldsmobile Cutlass, Buick Regal, Pontiac LeMans, Grand Prix 2 Door, Replacement Part For Buick, Oldsmobile And Pontiac, 82-88 Is A G Body	5025
D		78-79-80-81-82-83-84-85-87	Door weatherstrip front door with clips	4DR SDN	78-87 Chevrolet Malibu, Buick Regal, Oldsmobile Cutlass, Pontiac LeMans, 4 Door Sedan	5036
H		ALL-MODELS-WHERE-APPLICABLE	Air cleaner lid seal, cut to fit	2DR 4DR HTP 2DR SDN CNV SWG	GM All	2099
I		64-65-66-67-68-69-70-71-72-73-74	Park brake pedal pad	2DR HTP CNV	El Camino Cutlass Chevelle Chevy II Camaro Firebird LeMans Tempest GTO Grand Prix Full Size Centurion Century Electra Invicta LeSabre Regal Riviera Skylark Wildcat Monte Carlo	3094
R		73-74-75-76-77	Roofrail weatherstrip	2DR HTP	73-77 Cutlass Supreme, Salon, Brougham, Regal, 2 Door Hardtop	5035A
R		78-79-80-81-82-83-84-85-86-87-88	Roofrail weatherstrip	2DR HTP	78-88 Chevrolet Monte Carlo, Oldsmobile Cutlass, Buick Regal, Pontiac Grand Prix, 2 Door	5400
R		78-79-80-81-82-83-84-85-86-87-88	Auxiliary t-top sealing strips	2DR HTP	78-88 Chevrolet Monte Carlo, Oldsmobile Cutlass, Buick Regal, Pontiac Grand Prix, 2 Door Hardtop	5404
R		78-79-80-81-82-83-84-85-86-87-88	T-top weatherstrip fits on body	2DR HTP	78-88 Chevrolet Monte Carlo, Oldsmobile Cutlass, Buick Regal, Pontiac Grand Prix, 2 Door Hardtop	5402
R		78-79-80-81-82-83-84-85-86-87-88	T-top weatherstrip fits on t-top	2DR HTP	78-88 Chevrolet Monte Carlo, Oldsmobile Cutlass, Buick Regal, Pontiac Grand Prix, 2 Door Hardtop	5403

CODE	IMAGE	YEAR	DESCRIPTION	BODY	FITS	ITEM#
T		64-65-66-67-68-69-70-71-72-73-74-75-76-77	Trunk weatherstrip exact profile length 17 feet	2DR 4DR HTP 2DR SDN CNV	65-72 Chevy II, 65-72 Chevrolet Biscayne, 65-75 Chevrolet Bel Air, 65-76 Chevrolet Impala, 65-76 Chevrolet Caprice, 64-77 Chevrolet Chevelle, 70-77 Chevrolet Monte Carlo, 65-76 Buick LeSabre, 64-77 Buick Wildcat, 64-77 Buick Skylark, 71-73 Buick Centurion, 64-72 Buick Grand Special, 73-77 Buick Century, 73-88 Buick Regal, 73-88 Buick Grand National, 65-76 Buick Electra, 65-76 Oldsmobile Delta 88, 67-69 Oldsmobile Delmont 88, 65-66 Oldsmobile Dynamic 88, 65-66 Oldsmobile Starfire, 65 Oldsmobile Jetstar, 64-77 Oldsmobile Cutlass 442, 64-88 Oldsmobile Cutlass, 65-76 Oldsmobile 98, 65-76 Pontiac Parisienne, 64-72 Pontiac LeMans, 65-70 Pontiac Catalina, 65-66 Pontiac Star Chief, 67-70 Pontiac Executive, 71-75 Pontiac Grand Ville, 65-77 Pontiac Grand Prix, 64-72 Pontiac Tempest, 62-72 Nova, Ventura, 73-74 Non-Hatchback, Up to 1975 with groove channel, Apollo, Nova, Omega, Ventura 65-76 C-Body	2003
T		75-76-77-78-79-80-81-82-83-84-85-86-87-88-89-90-91-92	Trunk and Hatchback weatherstrip	2DR 4DR SDN HTP CNV	77-85 Chevrolet Impala, 77-91 Chevrolet Caprice, 82-92 Chevrolet Camaro, 75-79 Chevrolet Nova, 78-88 Chevrolet Monte Carlo, 78-83 Chevrolet Malibu, 78-83 Pontiac LeMans, 82-92 Pontiac Firebird, 75-91 Pontiac Ventura, 77-86 Pontiac Parisienne, 77-81 Pontiac Catalina, 69-88 Pontiac Grand Prix, 64-87 Pontiac LeMans, Pontiac Grand Am, 64-77 Pontiac GTO, 73-79 Oldsmobile Omega, 77-85 Oldsmobile Delta 88, 77-84 Oldsmobile 98, 77-88 Oldsmobile Cutlass, 73-75 Buick Apollo, 76-79 Buick Skylark, 77-79 Phoenix, 73-88 Buick Regal, 77-84 Buick Electra, 77-85 Buick LeSabre, 77-78 Buick Riviera, 77-91 C-Body	2424
W	 <small>IMAGE COMING SOON</small>	81-82-83-84-85-86-87-88	Window weatherstrip replacement style	2DR HTP	81-88 Oldsmobile Cutlass, Buick Regal, 2 Door Hardtop	7080
W		81-82-83-84-85-86-87-88	Window weatherstrip, original style with round bead	2DR HTP	81-88 Oldsmobile Cutlass, Buick Regal, 2 Door Hardtop	7081
Z		78-79-80-81-82-83-84-85-86-87-88	Weatherstrip kit, includes door weatherstrip, roofrail weatherstrip, trunk weatherstrip	2DR HTP	78-88 Chevrolet Monte Carlo, Buick Regal, Oldsmobile Cutlass, Pontiac Grand Prix, 2 Door Hardtop	KIT539X
Z		78-79-80-81-82-83-84-85-86-87-88	Weatherstrip kit, includes door weatherstrip, roofrail weatherstrip, trunk weatherstrip	2DR HTP	78-88 Chevrolet Monte Carlo, Buick Regal, Oldsmobile Cutlass, Pontiac Grand Prix, 2 Door Hardtop	KIT539X







GUIDE TO SOFFSEAL'S PRODUCT CODES

B = Bumper sets **C** = Glass channels **D** = Door related **G** = Seals, gaskets **H** = Under hood items **I** = Interior parts
M = Miscellaneous items **R** = Roofrail, pillar post & convertible items **T** = Trunk related **W** = Window related **Z** = Weatherstrip kits



CODE	IMAGE	YEAR	DESCRIPTION	BODY	FITS	ITEM#
D		54-55-56	Door weatherstrip	CNV	54-56 Buick Super, Roadmaster Riviera, Cadillac Convertible	0549
G		71-72-73-74-75- 76-7-78	Door handle gaskets	2DR HTP CNV 2DR SDN	71-76 Buick LeSabre, Electra, Oldsmobile 98 Oldsmobile 88, 71-78 Tornado, Cadillac, 74-76 Riviera	2514
I		58	Gear shift grommet column	2DR 4DR SDN HTP CNV	58 Chevrolet Del Ray, Biscayne, Bel Air, Impala, Cadillac, Oldsmobile 88 Oldsmobile 98, Buick Special, Century, Roadmaster, Riviera, Pontiac	2185
I		59-60-61-62-63- 64-65-66	Gear shift grommet column	2DR 4DR SDN HTP CNV	59-66 Chevrolet Biscayne, Bel Air, Impala, 59-66 Cadillac, 59-63 Oldsmo- bile 88 Oldsmobile 98, 61 Starfire, 64-66 Starfire, Jet Star, 59-66 Buick LeSabre, Invicta, Electra, 63 Wildcat, Riviera, 59-66 Pontiac	2185A
I		64-65-66-67-68- 69-70-71-72-73-74	Park brake pedal pad	2DR HTP CNV	El Camino Cutlass Chevelle Chevy II Camaro Firebird LeMans Tempest GTO Grand Prix Full Size Centurion Century Electra Invicta LeSabre Regal Riviera Skylark Wildcat Monte Carlo	3094
M		63-64-65	Door handle gaskets	2DR HTP	63-65 Buick Riviera	8521
M		65	Trunk lock gasket door handle lock gasket	2DR HTP	65 Buick Riviera	8526
T		58-59-60-61-62- 63-64-65-66-67- 68-69	Trunk weatherstrip exact profile	2DR 4DR HTP 2DR SDN CNV	58-64 Chevrolet Biscayne, 58-64 Chevrolet Bel Air, Chevrolet Impala, 60-69 Chevrolet Corvair, 59-64 Pontiac Pariseinne, 59-64 Pontiac Catalina, 59-64 Pontiac Star Chief, 60-61 Pontiac Ventura, 62-64 Pontiac Grand Prix, 58-64 Oldsmobile Delta 88, 58-64 Oldsmobile Dynamic 88, Oldsmobile Super 88, Oldsmobile Super 98, 61-64 Oldsmobile Starfire, 64 Oldsmobile Jetstar, 59-64 Buick LeSabre, 59-62 Buick Invicta, 59-64 Buick Electra, 62-64 Buick Wildcat, 63-65 Buick Riviera, 58-60 Cadillac Deville, Cadillac Eldorado, Cadillac Series 62, Cadillac Series 60 Special, Cadillac Series 75, 58-64 C-Body	2001
T		75-76-77-78-79-80- 81-82-83-84-85- 86-87-88-89-90- 91-92	Trunk and Hatchback weatherstrip	2DR 4DR SDN HTP CNV	77-85 Chevrolet Impala, 77-91 Chev- rolet Caprice, 82-92 Chevrolet Camaro, 75-79 Chevrolet Nova, 78-88 Chev- rolet Monte Carlo, 78-83 Chevrolet Malibu, 78-83 Pontiac LeMans, 82-92 Pontiac Firebird, 75-91 Pontiac Ven- tura, 77-86 Pontiac Parisienne, 77-81 Pontiac Catalina, 69-88 Pontiac Grand Prix, 64-87 Pontiac LeMans, Pontiac Grand Am, 64-77 Pontiac GTO, 73-79 Oldsmobile Omega, 77-85 Oldsmobile Delta 88, 77-84 Oldsmobile 98, 77-88 Oldsmobile Cutlass, 73-75 Buick Apollo, 76-79 Buick Skylark, 77-79 Phoenix, 73-88 Buick Regal, 77-84 Buick Electra, 77-85 Buick LeSabre, 77-78 Buick Riviera, 77-91 C-Body	2424

Buick • Riviera

CODE	IMAGE	YEAR	DESCRIPTION	BODY	FITS	ITEM#
W		48-49	Windshield post weatherstrip seals	CPE CNV	49 Buick Riviera, Cadillac Coupe Deville, Oldsmobile 98, Holiday Coupe, 48-49 Cadillac, Oldsmobile 98 Convertible	0553
W		63-64-65	Quarter window seals	2DR 4DR SDN HTP CNV	63-65 Buick Riviera, 2 Door 4 Door Sedan Hardtop Convertible	2299
W		63-64-65	Window weatherstrip, original style with round bead 8 piece	2DR HTP	63-65 Buick Riviera, 2 Door Hardtop	21813
W		71-72-73	Qtr window u jamb	2DR HTP CNV	71-73 Buick LeSabre, Electra, Riviera, Chevrolet Impala, Caprice, Cadillac Calais, Deville, Oldsmobile 88 Oldsmobile 98, Pontiac Catalina, Bonneville, Grandville 2 Door Hardtop Convertible	2600







GUIDE TO SOFFSEAL'S PRODUCT CODES













B = Bumper sets **C** = Glass channels **D** = Door related **G** = Seals, gaskets **H** = Under hood items **I** = Interior parts
M = Miscellaneous items **R** = Roofrail, pillar post & convertible items **T** = Trunk related **W** = Window related **Z** = Weatherstrip kits

Buick • Skyhawk



CODE	IMAGE	YEAR	DESCRIPTION	BODY	FITS	ITEM#
D		75-76-77-78-79-80	Door weatherstrip	2DR SDN	75-80 Chevrolet Monza, Oldsmobile Starfire, Buick Skyhawk, Pontiac Sunbird H-Body Coupe	8029
D		82-83-84-85-86-87-88-89-90-91-92	Door weatherstrip front/rear	All	82-89 Skyhawk 92-97 Skylark 82-88 Cimarron 93-96 Fleetwood 82-94 Beretta 82-94 Cavalier 91-96 Caprice 82-96 Corsica 82-94 Lumina 82-93 S10 83-94 S10 Blazer 82-05 Chev Van 83-94 GMC Jimmy 82-93 GMC Sonoma 82-05 GMC Van 82-94 Achieva 82-85 Custom Cruiser 82-94 Firenza 82-94 Grand Am 82-94 Sunbird	9110
M		00-99	Window weld ribbon sealer 3/8 inch round	ALL BODY STYLES	All Makes And Models	08622
M		75-76-77-78-79-80	Door weatherstrip hatchback	2DR SDN	75-80 Chevrolet Monza, Oldsmobile Starfire, Buick Skyhawk, Pontiac Sunbird H-Body	8028

Buick • Skylark & Gran Sport

CODE	IMAGE	YEAR	DESCRIPTION	BODY	FITS	ITEM#
B		47-48-49-50-51-52-53-54-55-56-57-58-59-60-61-62-63-64-65-66-67-68-69-70-71-72-73-74-75-76-77-78-79-80-81-82-83-84-85-86-87	Glove box door bumpers	2DR 4DR HTP 2DR SDN CNV SWG TRK	All Chevrolet, Pontiac, Oldsmobile, Buick 47-87 Chevrolet, Gmc Truck	1069
B		59-60-61-62-63-64-65-66-67	Door bumpers	2DR HTP 2DR SDN 2DR SDN CNV SWG	59-67 Chevrolet, Pontiac, Oldsmobile, Buick, Cadillac, 62-67 Chevy II, Nova, 66-67 Chevrolet Chevelle, Oldsmobile Cutlass, Buick Skylark, Pontiac Tempest, LeMans, GTO	2320
B		62-63-64-65-66-67-68-69-70-71-72-73-74-75	Trunk bumpers	2DR HTP 2DR SDN CNV	70-75 Chevrolet Camaro, Pontiac Firebird, 62-73 Chevy II Nova, 64-72, Pontiac GTO, Tempest, Le Mans, Chevrolet Chevelle, Monte Carlo, Buick Skylark, Oldsmobile Cutlass, 65-69 Chevrolet Corvair, 65-70 Full Size Chevrolet	3112
B		64-65-66	Door bumpers	2DR 4DR HTP 2DR SDN CNV SWG	64-66 Chevrolet Chevelle, El Camino, Nova, Pontiac GTO, Tempest, LeMans, Buick Skylark, Oldsmobile Cutlass	5080
B		64-65-66-67-68-69-70-71-72	Hood adjustment bumper 1in x 1 3/4 in long x 5/16 bolt	2DR SDN 2DR 4DR HTP CNV SWG	64-66 Pontiac Tempest, LeMans, GTO, Buick Skylark, Oldsmobile Cutlass	6022
B		65-66-67-68-69-70-71-72-73-74-75-76-77-78-79-80-81-82-83-84-85-86-87-88-89-90-91-92-93-94-95-96-97-98-99-00-01-02	Door bumpers	2DR 4DR HTP 2DR SDN SWG CNV	65-66 Chevrolet, Pontiac, Oldsmobile, Buick, 65-69 Corvair, 70-02 Chevrolet Camaro, Pontiac Firebird, 68-81 Chevelle, GTO, Cutlass, Skylark, 68-72 El Camino, Tempest, LeMans GTO, 70-72 Monte Carlo	2321
B		69	License panel bumpers rear	2DR 4DR SDN HTP CNV	69 Chevrolet Camaro, Pontiac Firebird, 64-72 Chevrolet Chevelle, Pontiac Tempest, LeMans, GTO, Grand Prix, Oldsmobile Cutlass, Buick Special, Skylark	31151
C		53-54	Windshield channel	2DR SDN	53-54 Chevrolet Bel Air 210 Oldsmobile, Pontiac, Sedan	0522
D		64-65	Door weatherstrip with clips	2DR SDN	64-65 Chevrolet Chevelle, Oldsmobile Cutlass, Buick Skylark, Pontiac Tempest, LeMans, GTO, Buick Special 2 Door Sedan	5003
D		64-65	Door weatherstrip with clips & molded ends	2DR HTP CNV	64-65 Chevrolet Chevelle, Pontiac GTO, LeMans, Oldsmobile Cutlass, Buick Skylark 2 Door Hardtop And Convertible	5004
D		64-65-66-67	Door weatherstrip rear door with clips	4DR SDN WGN	64-67 Chevelle, LeMans, Skylark, Cutlass, Except Sport Station Wagon And Vista Cruiser, 4 Door Sedan Station Wagon	5001A
D		66-67	Door weatherstrip with clips	2DR SDN	66-67 Chevrolet Chevelle, Pontiac Tempest, LeMans, GTO, Oldsmobile Cutlass, 442, Buick Special, Skylark 2 Door Sedan	5000



GUIDE TO SOFFSEAL'S PRODUCT CODES

B = Bumper sets **C** = Glass channels **D** = Door related **G** = Seals, gaskets **H** = Under hood items **I** = Interior parts
M = Miscellaneous items **R** = Roofrail, pillar post & convertible items **T** = Trunk related **W** = Window related **Z** = Weatherstrip kits

Buick • Skylark & Gran Sport



CODE	IMAGE	YEAR	DESCRIPTION	BODY	FITS	ITEM#
D		66-67	Door weatherstrip with clips & molded ends	2DR HTP CNV	66-67 Pontiac GTO, LeMans, Oldsmobile Cutlass, Buick Skylark, Hardtop Convertible	6407
D		68	Door weatherstrip with clips & molded ends	2DR HTP CNV	68 Chevrolet Chevelle, Oldsmobile Cutlass, Buick Skylark, 2 Door Hardtop And Convertible	5011
D		68-69-70-71-72	Door weatherstrip front door with clips	4DR SWG	68-72 Chevrolet Chevelle, Pontiac LeMans, Buick Skylark, 68-72 Oldsmobile Cutlass 4 Door Station Wagon	5020
D		68-69-70-72-72	Door weatherstrip rear door with clips	4DR SDN SWG	68-72 Chevrolet Chevelle, Pontiac LeMans, Buick Skylark, Oldsmobile Cutlass 4 Door Sedan And Station Wagon Except Sport Station Wagon And Vista Cruiser	5020A
D		68-69-70-71-72	Door weatherstrip with clips	2DR SDN	68-72 Chevelle, Pontiac Tempest, LeMans, GTO, Oldsmobile Cutlass 442, Buick Special, Buick Skylark, 2 Door Sedan	5002
D		69-70-71-72	Door weatherstrip with clips & molded ends	2DR HTP CNV	69-72 Chevelle, Grand Prix, Monte Carlo, Skylark, Cutlass, 2 Door Hardtop And Convertible	5022
D		73-74-75-76-77	Front door weatherstrip with clips & molded ends	2DR 4DR SDN HTP CNV	73-77 Chevrolet Malibu, Buick Skylark, Oldsmobile Cutlass, 4 Door Sedan	5026
D		75-76-77-78-79	Door weatherstrip with clips	2DR SDN	75-79 Nova, 75 Apollo, 75-79 Oldsmobile Omega, 75-77 Pontiac Ventura, 77-79 Pontiac Phoenix 76-79 Buick Skylark, 2 Door Sedan	4024
D		75-76-77-78-79	Door weatherstrip front door with clips	4DR SDN	75-79 Chevy II Nova, 75 Buick Apollo, 76-79 Buick Skylark, 75-79 Oldsmobile Omega, 75-77 Pontiac Ventura, 78-79 Phoenix, 4 Door Sedan	40813
D		75-76-77-78-79	Door weatherstrip rear door with clips	4DR SDN	75-79 Chevy II Nova, 75 Buick Apollo, 76-79 Buick Skylark, 75-79 Oldsmobile Omega, 75-77 Pontiac Ventura, 78-79 Phoenix, 4 Door Sedan	40814
D		82-83-84-85-86-87-88-89-90-91-92	Door weatherstrip front/rear	All	82-89 Skyhawk 92-97 Skylark 82-88 Cimarron 93-96 Fleetwood 82-94 Beretta 82-94 Cavalier 91-96 Caprice 82-96 Corsica 82-94 Lumina 82-93 S10 83-94 S10 Blazer 82-05 Chev Van 83-94 GMC Jimmy 82-93 GMC Sonoma 82-05 GMC Van 82-94 Achieva 82-85 Custom Cruiser 82-94 Firenza 82-94 Grand Am 82-94 Sunbird	9110
G		64-65-66-67	Steering column sponge seal	2DR SDN CNV 2DR 4DR HTP SWG	64-67 Chevrolet Chevelle, El Camino, Pontiac LeMans, GTO, Oldsmobile Cutlass, Buick Skylark	5162
G		64-65-66-67	Cowl vent gaskets	2DR 4DR HTP 2DR SDN CNV	64-67 Buick Skylark, Oldsmobile Cutlass, Pontiac GTO, Chevrolet Chevelle	5073
G		66-67-68-69-70-71-72	Door handle & lock gaskets set	2DR HTP 2DR SDN CNV	67-69 Chevrolet Camaro, Pontiac Firebird, 66-72 Chevy II Nova, 64-72 Chevrolet Chevelle, Pontiac Tempest, LeMans, GTO, Buick Skylark, Oldsmobile Cutlass, 70-72 Chevrolet Monte Carlo	3021

BUICK • Skylark & Gran Sport

Buick • Skylark & Gran Sport

BUICK • Skylark & Gran Sport

CODE	IMAGE	YEAR	DESCRIPTION	BODY	FITS	ITEM#
G		68-69	Taillamp lens gaskets	2DR HTP 2DR SDN CNV	68-69 Skylark Gran Sport	7070
G		68-69-70-71-72	Steering column sponge seal	2DR SDN CNV 2DR HTP SWG	68-72 Chevelle El Camino Monte Carlo, Buick Skylark, Oldsmobile Cutlass	5161
H		68-69	Hood to cowl seal clip kit steel	2DR 4DR HTP 2DR SDN CNV SWG	68-69 Chevelle, El Camino, Monte Carlo, GTO, LeMans, Buick Skylark, Oldsmobile Cutlass	5075
H		68-69-70-71-72	Hood to cowl seal clip kit plastic	2DR 4DR HTP 2DR SDN CNV SWG	68-72 Chevrolet Chevelle, El Camino, Monte Carlo, Pontiac LeMans, Buick Skylark, Oldsmobile Cutlass	5077
H		68-69-70-71-72	Hood to cowl seal dense	2DR 4DR HTP 2DR SDN CNV SWG	68-72 Chevrolet Chevelle, El Camino, Monte Carlo, Pontiac GTO, LeMans, Buick Skylark, Oldsmobile Cutlass	5074
H		68-69-70-71-72	Hood to cowl seal sponge	2DR 4DR HTP 2DR SDN CNV SWG	68-72 Chevrolet Chevelle, El Camino, Monte Carlo, Pontiac GTO, LeMans, Buick Skylark, Oldsmobile Cutlass	50741
H		68-69-70-71-72	Firewall clutch boot	2DR HTP 2DR SDN CNV	68-72 Chevrolet Chevelle, El Camino, Monte Carlo, Pontiac LeMans, Tempest, GTO, Buick Skylark, Oldsmobile Cutlass	5053
H		68-69-70-71-72	A-arm seals with staples	2DR HTP 2DR SDN CNV	68-72 Buick Skylark	7053
H		68-69-70-71-72	Hood insulation	2DR HTP 2DR SDN CNV	68-72 Buick Skylark	7055
H		ALL-MODELS-WHERE-APPLICABLE	Air cleaner lid seal, cut to fit	2DR 4DR HTP 2DR SDN CNV SWG	GM All	2099
I		62-63-64-65-66-67-68-69-70-71	Accelerator pedal hp with deluxe trim	2DR 4DR HTP 2DR SDN CNV SWG	62-71 Chevrolet Biscayne Bel Air Impala, 64-67 Chevelle, 70-71 Camaro Hi Perfor, 64-67 Buick Special-Skylark El Camino, 64-65 Pontiac A Body	2069
I		64-65-66-67-68-69-70	Sun visor tip	2DR 4DR SDN HTP CNV	64-70 All Makes And Models	4006
I		64-65-66-67-68-69-70-71-72-73-74	Park brake pedal pad	2DR HTP CNV	El Camino Cutlass Chevelle Chevy II Camaro Firebird LeMans Tempest GTO Grand Prix Full Size Centurion Century Electra Invicta LeSabre Regal Riviera Skylark Wildcat Monte Carlo	3094
I		65-66-67-68-69-70-71-72	4 speed shift boot upper	2DR SDN 2DR HTP CNV	65-72 Buick Skylark Gran Sport	7024
I		65-66-67-68-69-70-71-72	4 speed shift boot lower	2DR SDN 2DR HTP CNV	65-72 Buick Skylark Gran Sport	7025
I		68-69-70-71-72	Automatic brake pad	2DR 4DR HTP 2DR SDN CNV SWG	68-72 Chevrolet Chevelle, El Camino, Monte Carlo, Buick Skylark, Oldsmobile Cutlass, 71-72 Pontiac LeMans, Tempest, GTO	5058



GUIDE TO SOFFSEAL'S PRODUCT CODES

B = Bumper sets **C** = Glass channels **D** = Door related **G** = Seals, gaskets **H** = Under hood items **I** = Interior parts
M = Miscellaneous items **R** = Roofrail, pillar post & convertible items **T** = Trunk related **W** = Window related **Z** = Weatherstrip kits











Buick • Skylark & Gran Sport



CODE	IMAGE	YEAR	DESCRIPTION	BODY	FITS	ITEM#
M		00-99	Window weld ribbon sealer 3/8 inch round	ALL BODY STYLES	All Makes And Models	08622
M		64-65-66-67	Firewall pad with clips	2DR SDN 4DR HTP CNV SWG	64-67 Chevrolet Chevelle, El Camino, Buick Skylark, Oldsmobile Cutlass, Pontiac GTO, LeMans	5163
M		64-65-66-67-68-69	Rocker panel flap plug, requires 2	2DR 4DR SDN HTP CNV	64-68 Chevrolet Chevelle, Pontiac GTO, Oldsmobile Cutlass, Buick Skylark, 67-69 Chevrolet Camaro, Pontiac Firebird, 2 Door 4 Door Sedan Hardtop Convertible	5013
M		67-68-69-70-71-72-73-74-75-76-77-78-79-80-81-82-83-84	Oil filler cap	2DR 4DR SDN HTP CNV	67-84 GM All Models	5044
M		68-69-70-71-72	Firewall insulation pad with clips non a/c	2DR SDN CNV 4DR HTP SWG	68-72 Chevrolet Chevelle, El Camino, Buick Skylark, Oldsmobile Cutlass, Pontiac GTO, LeMans	51631
M		68-69-70-71-72	Firewall insulation pad with clips with a/c	2DR SDN CNV 2DR 4DR HTP SWG	68-72 Chevrolet Chevelle, El Camino, Buick Skylark, Oldsmobile Cutlass, Pontiac GTO, LeMans, All Models	51632
M		68-69-70-71-72	Body mount bolt kit	2DR HTP 2DR SDN	68-72 Chevelle, Cutlass LeMans Skylark, 2 Door 4 Door Hardtop	51646
M		68-69-70-71-72	Cnv body mount bolt kit	CNV	68-72 Chevrolet Chevelle, Oldsmobile Cutlass, Pontiac LeMans, Buick Skylark, Convertible	51647
M		68-69-70-71-72	Core support bushing bolt kit	2DR 4DR HTP 2DR SDN CNV SWG	68-72 Chevelle El Camino Skylark Special Gran Sport Sports Wagon 442 Cutlass F85 Vista Cruiser Wagon Tempest LeMans GTO T37 Monte Carlo Impala	5167
R		64-65	Weatherstrip kit for convertible top	CNV	64-65 Chevrolet Chevelle, Pontiac GTO, LeMans, Oldsmobile Cutlass, 442, Buick Skylark Convertible	5090
R		64-65	Pillar post weatherstrip with molded ends	CNV	64-65 Chevrolet Chevelle, Pontiac GTO, Buick Skylark, Oldsmobile Cutlass, Convertible	5039
R		64-65	Roofrail weatherstrip with molded ends	2DR HTP	64-65 Chevrolet Chevelle, Buick Skylark, Oldsmobile Cutlass, Pontiac LeMans, GTO, 2 Door Hardtop	5005
R		64-65-66-67	Header seal with clips, without molded ends	CNV	64-67 Chevrolet Chevelle, Pontiac GTO, LeMans, Oldsmobile Cutlass, 442, Buick Skylark, Convertible	5091
R		66-67	Header seal with clips and molded ends	CNV	66-67 Chevrolet Chevelle A Body Pontiac LeMans GTO Old Cutlass 442 Buick Special Skylark Convertible	50911
R		66-67	Weatherstrip kit for convertible top	CNV	66-67 Chevrolet Chevelle, Pontiac GTO, LeMans, Oldsmobile Cutlass 442, Buick Special, Skylark, Convertible	5092

Buick • Skylark & Gran Sport

BUICK • Skylark & Gran Sport

CODE	IMAGE	YEAR	DESCRIPTION	BODY	FITS	ITEM#
R		66-67	Roofrail weatherstrip with molded ends	2DR HTP	66-67 Chevelle, Pontiac Tempest, LeMans, GTO, Oldsmobile Cutlass 442, Buick Special, Skylark, 2 Door Hardtop	5009
R		66-67	Pillar post weatherstrip with molded ends	CNV	66-67 Chevrolet Chevelle, Pontiac GTO, LeMans, Oldsmobile Cutlass, Buick Skylark Convertible	5040
R		68	Pillar post weatherstrip with molded ends	CNV	68 Chevrolet Chevelle, Pontiac GTO, LeMans, Buick Skylark, Oldsmobile Cutlass Convertible	5041
R		68	Roofrail weatherstrip with molded ends	2DR HTP	68 Chevrolet Chevelle, Pontiac LeMans, GTO, Buick Skylark, Oldsmobile Cutlass, 2 Door Hardtop	5012
R		68-69-70-71-72	Weatherstrip kit for convertible top	CNV	68-72 Chevrolet Chevelle, Buick Skylark, Oldsmobile Cutlass, Pontiac LeMans, Convertible	5093
R		68-69-70-71-72	Header seal with clips and molded ends	CNV	68-72 Chevrolet Chevelle, Buick Skylark, Oldsmobile Cutlass, Pontiac LeMans, Convertible	5094
R		68-69-70-71-72	Conv. top Header Seal	Conv.	68-72 Chevrolet Chevelle, Pontiac LeMans, Tempest, GTO, Buick Skylark, Olds Cutlass	5054
R		69-70-71-72	Pillar post weatherstrip with molded ends	CNV	69-72 Chevrolet Chevelle, Pontiac LeMans, GTO, Buick Skylark, Oldsmobile Cutlass Convertible	5042
R		69-70-71-72	Roofrail weatherstrip with molded ends	2DR HTP CNV	69-72 Chevrolet, Pontiac GTO, LeMans, Grand Prix, Buick Skylark, Oldsmobile Cutlass 442, 2 Door Hardtop	5024
T		64-65-66-67-68-69-70-71-72-73-74-75-76-77	Trunk weatherstrip exact profile length 17 feet	2DR 4DR HTP 2DR SDN CNV	65-72 Chevy II, 65-72 Chevrolet Biscayne, 65-75 Chevrolet Bel Air, 65-76 Chevrolet Impala, 65-76 Chevrolet Caprice, 64-77 Chevrolet Chevelle, 70-77 Chevrolet Monte Carlo, 65-76 Buick LeSabre, 64-77 Buick Wildcat, 64-77 Buick Skylark, 71-73 Buick Centurion, 64-72 Buick Grand Special, 73-77 Buick Century, 73-88 Buick Regal, 73-88 Buick Grand National, 65-76 Buick Electra, 65-76 Oldsmobile Delta 88, 67-69 Oldsmobile Delmont 88, 65-66 Oldsmobile Dynamic 88, 65-66 Oldsmobile Starfire, 65 Oldsmobile Jetstar, 64-77 Oldsmobile Cutlass 442, 64-88 Oldsmobile Cutlass, 65-76 Oldsmobile 98, 65-76 Pontiac Parisienne, 64-72 Pontiac LeMans, 65-70 Pontiac Catalina, 65-66 Pontiac Star Chief, 67-70 Pontiac Executive, 71-75 Pontiac Grand Ville, 65-77 Pontiac Grand Prix, 64-72 Pontiac Tempest, 62-72 Nova, Ventura, 73-74 Non-Hatchback, Up to 1975 with groove channel, Apollo, Nova, Omega, Ventura 65-76 C-Body	2003

















GUIDE TO SOFFSEAL'S PRODUCT CODES

B = Bumper sets **C** = Glass channels **D** = Door related **G** = Seals, gaskets **H** = Under hood items **I** = Interior parts
M = Miscellaneous items **R** = Roofrail, pillar post & convertible items **T** = Trunk related **W** = Window related **Z** = Weatherstrip kits

Buick • Skylark & Gran Sport



CODE	IMAGE	YEAR	DESCRIPTION	BODY	FITS	ITEM#
T		66	Trunk mat	2DR HTP 2DR SDN CNV	66 Buick Skylark, Gran Sport	7033
T		67	Trunk mat	2DR HTP 2DR SDN CNV	67 Buick Skylark, Gran Sport	7034
T		68-69-70-71-72	Trunk mat rubber	2DR HTP 2DR SDN CNV	68-72 Buick Skylark, Gran Sport	7035
T		68-69-70-71-72	Trunk mat felt	2DR HTP 2DR SDN CNV	68-72 Buick Skylark, Gran Sport	7036
T		75-76-77-78-79-80-81-82-83-84-85-86-87-88-89-90-91-92	Trunk and Hatchback weatherstrip	2DR 4DR SDN HTP CNV	77-85 Chevrolet Impala, 77-91 Chevrolet Caprice, 82-92 Chevrolet Camaro, 75-79 Chevrolet Nova, 78-88 Chevrolet Monte Carlo, 78-83 Chevrolet Malibu, 78-83 Pontiac LeMans, 82-92 Pontiac Firebird, 75-91 Pontiac Ventura, 77-86 Pontiac Parisienne, 77-81 Pontiac Catalina, 69-88 Pontiac Grand Prix, 64-87 Pontiac LeMans, Pontiac Grand Am, 64-77 Pontiac GTO, 73-79 Oldsmobile Omega, 77-85 Oldsmobile Delta 88, 77-84 Oldsmobile 98, 77-88 Oldsmobile Cutlass, 73-75 Buick Apollo, 76-79 Buick Skylark, 77-79 Phoenix, 73-88 Buick Regal, 77-84 Buick Electra, 77-85 Buick LeSabre, 77-78 Buick Riviera, 77-91 C-Body	2424
W		37-38-39-40-41-42-43-44-45-46-47-48-49-50-51-52-53-54	Mohair channel liner, 4 feet of 2 7/8 inch mohair lining material	CNV 2DR 4DR HTP	Bel Air 150 210, Nomad, Chieftain, 860/870 Star Chief, Safari, Super Chief, Bonneville, Nova, Omega, Apollo, Ventura, Skylark	0420
W		64	Window weatherstrip replacement style	2DR HTP	64 Buick Skylark, 2 Door Hardtop	7029
W		64	Window weatherstrip, original style with round bead	CNV	64 Buick Skylark Convertible	7030
W		64-65	Glass run channel front door window	2DR 4DR HTP CNV	64-65 Chevrolet Chevelle, Pontiac GTO, LeMans, Oldsmobile Cutlass, 442, Buick Skylark, 2 Door 4 Door Hardtop Convertible	5100
W		64-65	Vent window seals	2DR HTP CNV	64-65 Chevrolet Chevelle, Pontiac GTO, LeMans, Oldsmobile Cutlass, Buick Skylark, 2 Door Hardtop Convertible	5102
W		64-65	Rubber door jams u shape	2DR HTP CNV	64-65 Chevrolet Chevelle, Pontiac LeMans, GTO, Oldsmobile Cutlass, Buick Skylark 2 Door Hardtop Convertible	5113
W		64-65	Quarter window seals steel insert	HTP	64-65 Chevrolet Chevelle, Pontiac LeMans, GTO, Oldsmobile Cutlass, Buick Skylark, Hardtop	5109M
W		64-65	Quarter window seals all rubber	2DR HTP	64-65 Chevrolet Chevelle, Pontiac LeMans, GTO, Oldsmobile Cutlass, Buick Skylark, 2 Door Hardtop	5109R
W		64-65	Quarter window seals steel insert	CNV	64-65 Chevrolet Chevelle, Pontiac GTO, LeMans, Oldsmobile Cutlass, Buick Skylark, Convertible	5110M

BUICK • Skylark & Gran Sport

Buick • Skylark & Gran Sport

BUICK • Skylark & Gran Sport

CODE	IMAGE	YEAR	DESCRIPTION	BODY	FITS	ITEM#
W		64-65	Quarter window seals all rubber	CNV	64-65 Chevrolet Chevelle, Pontiac GTO, LeMans, Oldsmobile Cutlass, Buick Skylark, Convertible	5110R
W		64-65-66-67	Vent window seals	2DR 4DR SDN	64-67 Chevelle, El Camino, 66-67 Oldsmobile Cutlass, Buick Skylark, 64-65 Pontiac GTO, LeMans 2 Door 4 Door Sedan	51021
W		64-65-66-67	Quarter window seal rear	CNV	64-67 Chevrolet Chevelle, Pontiac Tempest, LeMans, GTO, Oldsmobile Cutlass, 442, Buick Skylark, Convertible	5108
W		65	Window weatherstrip, original style with round bead	CNV	65 Buick Skylark Convertible	70301
W		65	Window weatherstrip	2DR HTP	65 Buick Skylark, 2 Door Hardtop	70302
W		66-67	Window weatherstrip replacement style	2DR HTP	66-67 Buick Skylark, 2 Door Hardtop	7031
W		66-67	Window weatherstrip replacement style	CNV	66-67 Buick Skylark Convertible	7032
W		66-67	Quarter window seals, steel insert	2DR HTP CNV	66-67 Pontiac GTO, LeMans, Oldsmobile Cutlass, Buick Skylark, 2 Door Hardtop Convertible	6497M
W		66-67	Quarter window seals, all rubber	2DR HTP CNV	66-67 Buick Special, Skylark, Gran Sport, Oldsmobile F85, Cutlass, 442, Pontiac Tempest, LeMans, GTO, 2 Door Hardtop Convertible	6497R
W		66-67	Rubber door jambs u shape	2DR HTP CNV	66-67 Chevrolet Chevelle, Pontiac LeMans, GTO, Oldsmobile Cutlass, Buick Skylark, 2 Door Hardtop Convertible	51131
W		66-67	Vent window seals	2DR HTP CNV	66-67 Chevrolet Chevelle, Pontiac GTO, LeMans, Oldsmobile Cutlass, Buick Skylark, 2 Door Hardtop Convertible	5103
W		66-67	Quarter window seals with steel insert	2DR HTP CNV	66-67 Chevrolet Chevelle, Buick Skylark, Pontiac GTO, Oldsmobile Cutlass, 2 Door Hardtop Convertible	5111M
W		66-67	Quarter window seals all rubber	2DR HTP CNV	66-67 Chevrolet Chevelle, Buick Skylark, Pontiac GTO, Oldsmobile Cutlass, 2 Door Hardtop Convertible	5111R
W		66-67	Glass run channel front door window	2DR 4DR HTP CNV	66-67 Chevrolet Chevelle, Pontiac GTO, LeMans, Oldsmobile Cutlass, 442, Buick Skylark, Hardtop Convertible	5101
W		67-68	Glass run channel front door window	2DR 4DR HTP CNV	67 Chevrolet Camaro, Pontiac Firebird, 68 Chevrolet Chevelle, Oldsmobile Cutlass 68, Buick Special, Skylark, 2 Door 4 Door Hardtop Convertible	3126
W		68	Vent window weatherstrip	2DR 4DR HTP	68 Chevrolet Chevelle, Pontiac LeMans, GTO, Oldsmobile Cutlass 442, Buick Special, Skylark, 2 Door Hardtop Convertible	51022
W		68	Window weatherstrip replacement style	2DR HTP	68 Buick Skylark, 2 Door Hardtop	70321

















GUIDE TO SOFFSEAL'S PRODUCT CODES

B = Bumper sets **C** = Glass channels **D** = Door related **G** = Seals, gaskets **H** = Under hood items **I** = Interior parts
M = Miscellaneous items **R** = Roofrail, pillar post & convertible items **T** = Trunk related **W** = Window related **Z** = Weatherstrip kits









Buick • Skylark & Gran Sport



CODE	IMAGE	YEAR	DESCRIPTION	BODY	FITS	ITEM#
W		68	Window weatherstrip replacement style	CNV	68 Buick Skylark Convertible	70322
W		68-69-70-71-72	Vent window weatherstrip	2DR 4DR SDN	68 Chevrolet Chevelle, Pontiac Le Mans, GTO, Oldsmobile Cutlass, 442, Buick Skylark, 68-72 Chevrolet El Camino, Sedan	51031
W		68-69-70-71-72	Rubber door jambs u shape	2DR HTP CNV	68-72 Chevelle GTO Cutlass Skylark, 2 Door Hardtop Convertible	51132
W		68-69-70-71-72	Quarter window seals, with steel insert	2DR HTP CNV	68-72 Chevrolet Chevelle, Oldsmobile Cutlass, Buick Skylark, Pontiac Le-Mans, 69-70 Chevrolet Impala, 70-72 Chevrolet Monte Carlo, 2 Door Hardtop Convertible	5112M
W		68-69-70-71-72	Quarter window seals, all rubber	2DR HTP CNV	68-72 Chevrolet Chevelle, Oldsmobile Cutlass, Buick Skylark, Pontiac Le-Mans, 69-70 Chevrolet Impala, 70-72 Chevrolet Monte Carlo, 2 Door Hardtop Convertible	5112R
W		69	Window weatherstrip	2DR HTP	69 Buick Skylark 2 Door Hardtop	70323
W		69	Window weatherstrip replacement style	CNV	69 Buick Skylark Convertible	70324
W		70-71-72	Window weatherstrip replacement style	2DR HTP	70-72 Buick Skylark, 2 Door Hardtop	70325
W		70-71-72	Window weatherstrip replacement style	2DR HTP	70-72 Buick Skylark Gran Sport, 2 Door Hardtop	703251
W		70-71-72	Window weatherstrip replacement style	CNV	70-72 Buick Skylark Convertible	70326
Z		64	Weatherstrip kit, includes convertible top kit, door weatherstrips, lock gaskets, pillar post seals, quarter window seals, trunk weatherstrip, door u jambs, window weatherstrips	CNV	64 Buick Skylark Convertible	KIT704
Z		64	Weatherstrip kit, includes door weatherstrips, lock gaskets, quarter window seals, roofrail weatherstrips, trunk weatherstrips, door u jambs, window weatherstrips	2DR HTP	64 Buick Skylark, 2 Door Hardtop	KIT708
Z		65	Weatherstrip kit, includes door weatherstrips, lock gaskets, quarter window seals, roofrail weatherstrips, trunk weatherstrips, door u jambs, window weatherstrips	2DR HTP	65 Buick Skylark, 2 Door Hardtop	KIT709
Z		65	Weatherstrip kit, includes convertible top kit, door weatherstrips, lock gaskets, pillar post seals, quarter window seals, trunk weatherstrip, door u jambs, window weatherstrips	CNV	65 Buick Skylark Convertible	KIT726

BUICK • Skylark & Gran Sport

Buick • Skylark & Gran Sport

CODE	IMAGE	YEAR	DESCRIPTION	BODY	FITS	ITEM#
Z		66-67	Weatherstrip kit, includes door weatherstrips, lock gaskets, quarter window seals, roofrail weatherstrips, trunk weatherstrips, door u jombs, window weatherstrips	2DR HTP	66-67 Buick Skylark 2 Door Hardtop	KIT710
Z		66-67	Weatherstrip kit, includes convertible top kit, door weatherstrips, lock gaskets, pillar post seals, quarter window seals, trunk weatherstrip, door u jombs, window weatherstrips	CNV	66-67 Oldsmobile Cutlass, 442, Buick Skylark, Convertible	KIT712
Z		68	Weatherstrip kit, includes door weatherstrips, lock gaskets, quarter window seals, roofrail weatherstrips, trunk weatherstrips, door u jombs, window weatherstrips, hood to cowl seal & clips	2DR HTP	68 Buick Skylark 2 Door Hardtop	KIT716
Z		68	Weatherstrip kit, includes convertible top kit, door weatherstrips, lock gaskets, pillar post seals, quarter window seals, trunk weatherstrip, door u jombs, window weatherstrips, hood to cowl seal & clips	CNV	68 Buick Skylark, Convertible	KIT722
Z		69	Weatherstrip kit, includes convertible top kit, door weatherstrips, lock gaskets, pillar post seals, quarter window seals, trunk weatherstrip, door u jombs, window weatherstrips, hood to cowl seal & clips	CNV	69 Buick Skylark Convertible	KIT723
Z		69	Weatherstrip kit, includes door weatherstrips, lock gaskets, quarter window seals, roofrail weatherstrips, trunk weatherstrips, door u jombs, window weatherstrips, hood to cowl seal & clips	2DR HTP	69 Buick Skylark 2 Door Hardtop	KIT717
Z		69-70-71-72	Weatherstrip kit, includes trunk weatherstrip, door weatherstrip, roofrail weatherstrip	2DR HTP	69-72 Buick Skylark, Chevrolet Chevelle, Oldsmobile Cutlass, 442, 2 Door Hardtop	KIT510X
Z		70-71-72	Weatherstrip kit, includes convertible top kit, door weatherstrips, lock gaskets, pillar post seals, quarter window seals, trunk weatherstrip, door u jombs, window weatherstrips, hood to cowl seal & clips	CNV	70-72 Buick Skylark, Convertible	KIT724
Z		70-71-72	Weatherstrip kit, includes door weatherstrips, lock gaskets, quarter window seals, roofrail weatherstrips, trunk weatherstrips, door u jombs, window weatherstrips, hood to cowl & clips	2DR HTP	70-72 Buick Skylark 2 Door Hardtop	KIT718













GUIDE TO SOFFSEAL'S PRODUCT CODES

B = Bumper sets **C** = Glass channels **D** = Door related **G** = Seals, gaskets **H** = Under hood items **I** = Interior parts
M = Miscellaneous items **R** = Roofrail, pillar post & convertible items **T** = Trunk related **W** = Window related **Z** = Weatherstrip kits



CODE	IMAGE	YEAR	DESCRIPTION	BODY	FITS	ITEM#
B		67-68-69-70	Door bumpers	2DR 4DR HTP 2DR SDN CNV SWG	67-70 Chevrolet Biscayne, Bel Air, Impala Caprice, 67-70 Cadillac Calais, Deville, Fleetwood, 67-70 Oldsmobile 88, 98, 67-70 Buick LeSabre, Wildcat, Electra, 67-70 Pontiac	2323
C		62-63-64	Glass channel rear	2DR 4DR SDN	62-63 Chevrolet Biscayne, Bel Air, Impala, 62-64 Cadillac, 62-64 Oldsmobile 88, 62-64 Buick LeSabre, 64 Wildcat, 62-64 Pontiac Catalina, Star Chief 2 Door 4 Door Sedan	2189
C		62-63-64	Glass channel rear except 1963-64 gran prix	2DR HTP	62 Buick LeSabre, Invicta, 63-64 Buick LeSabre, Wildcat, 62-64 Chevrolet Impala, 62-63 Oldsmobile S88, 62-64 Oldsmobile D88, 64 Oldsmobile J88, 62-64 Pontiac Catalina 2 Door Hardtop	2184
C		63-64	Windshield gasket	2DR SDN SWG	63-64 Chevrolet Biscayne, Bel Air, Impala, 63-64 Cadillac Series 62, Deville, 63-64 Oldsmobile 88 Oldsmobile 98, 63-64 Buick LeSabre, Wildcat, Electra, 63-64 Pontiac, 2 Door Sedan Station Wagon	2020
C		63-64	Glass channel front	2DR HTP CNV	63-64 Chevrolet Impala, 63-64 Cadillac, 63-64 Oldsmobile 88, Oldsmobile 98 Starfire Convertible Only, 63-64 Buick LeSabre, Wildcat, Electra, 63-64 Pontiac, 2 Door Hardtop Convertible	2021
C		63-64	Glass channel rear	4DR HTP	63-64 Chevrolet Impala Sport Coupe, Oldsmobile 88 Holiday Sedan, Buick LeSabre, Wildcat, Pontiac Bonneville, Catalina, Star Chief 4 Door Hardtop	2188
D		61-62-63-64	Door weatherstrip rear door with clips	4DR SDN	61-64 Chevrolet Biscayne Bel Air Impala, 61-64 Oldsmobile 88, 98, 61-62 Cadillac, 61-64 Buick LeSabre Electra, 64 Wildcat, 61-64 Pontiac Catalina, Star Chief, 4 Door Sedan	2009
D		61-62-63-64	Door weatherstrip rear with clips	4dr SWG	61-64 Chevrolet Biscayne, Bel Air, Impala, 61-64 Oldsmobile 88, 61-64 Buick LeSabre, 62-63 Invicta 63-64 Wildcat, 61-64 Pontiac Catalina, Bonneville, 4 Door Station Wagon	2018
D		61-62-63-64	Door weatherstrip, rear doors with clips & molded ends	4DR HTP	61-64 Chevrolet Impala, Buick LeSabre, Oldsmobile Wildcat, 88, Pontiac Catalina Starchief Bonneville 4 Door Hardtop	2122
D		63-64	Front door weatherstrip with molded ends	4DR HTP	63-64 Chevrolet Biscayne, Bel Air, Impala, Buick Wildcat, LeSabre, Electra, Pontiac Catalina, Star Chief, Bonneville, Oldsmobile Dynamic 88, 98 4 Door Ht	2121
D		63-64	Door weatherstrip with clips & molded ends	2DR HTP CNV	63-64 Chevrolet Impala, 63-64 Cadillac Eldorado, Deville, 63-64 Oldsmobile 88 Oldsmobile 98 Starfire 63-64 Buick LeSabre Wildcat, Electra 63 Invicta, 63-64 Pontiac Catalina, Bonneville, Grand Prix, 2 Door Hardtop Convertible	2014

Buick • Wildcat

CODE	IMAGE	YEAR	DESCRIPTION	BODY	FITS	ITEM#
D		63-64	Door weatherstrip front with clips	4DR SDN SWG	63-64 Chevrolet Biscayne, Bel Air, Impala, 63-64 Cadillac, 63-64 Oldsmobile 88, 63-64 Buick LeSabre, Wildcat, 63-64 Pontiac, 4 Door Sedan Station Wagon	2017
D		65-66	Door weatherstrip front with clips	4DR SDN SWG	65-66 Chevrolet Biscayne Bel Air Impala, 65-66 Cadillac Calais Deville Fleetwood, 65-66 Oldsmobile 88, 65-66 Buick LeSabre Wildcat, 65-66 Pontiac Bonneville, Catalina, Star chief, 4 Door Sedan Swg	2006
D		65-66	Rear door weatherstrip with clips	4DR SDN	65-66 Chevrolet Biscayne Bel Air Impala 65-66 Cadillac Calais Deville Fleetwood 65-66 Oldsmobile 88, 65-66 Buick LeSabre Wildcat, 65-66 Pontiac Catalina, Star Chief, 4 Door Sedan	2007
D		65-66	Door weatherstrip rear doors with clips & molded ends	4DR HTP	65-66 Buick, LeSabre, Wildcat, 4 Door Hardtop	2208
D		65-66	Door weatherstrip with clips & molded ends	2DR HTP CNV	65-66 Chevrolet Impala, Caprice, 65-66 Cadillac Calais, Deville, 65-66 Oldsmobile 88, Starfire, Oldsmobile 98, 65 Jet Star, 65-66 Buick LeSabre, Wildcat Electra, 65-66 Pontiac 2 Door Hardtop Convertible	2331
D		65-66-67-68	Door weatherstrip front door with clips & molded ends	4DR HTP	65-68 Chevrolet Impala, Buick, Wildcat, LeSabre, Cadillac Calais, Deville, Oldsmobile 98 Oldsmobile 99, Pontiac, 4 Door Hardtop	2210
D		67-68	Front door weatherstrip with clips	4DR SDN SWG	67-68 Chevrolet Biscayne, Bel Air, Impala, 67-68 Cadillac Calais, Deville, Fleetwood, 67-68 Oldsmobile Delmont 88, Delta 88, 98, 67-68 Buick LeSabre, Wildcat, Electra 67-68 Pontiac Catalina, Executive, Bonneville, 4 Door Sedan Station Wagon	23321
D		67-68	Door weatherstrip rear with clips	4DR SDN	67-68 Chevrolet Biscayne, Bel Air, Impala, 67-68 Cadillac Calais, Deville, Fleetwood, 67-68 Oldsmobile 88, 67-68 Buick LeSabre, Wildcat, 67-68 Pontiac Bonneville Station Wagon, 67-68 Pontiac Executive, Catalina, 4 Door Sedan	23322
D		67-68	Door weatherstrip with clips & molded ends	CNV 2DR HTP	67-68 Chevrolet Impala, Caprice, Except 68 Caprice 2 Door Hardtop, 67-68 Cadillac Calais, Deville, 67-68 Oldsmobile 88 Oldsmobile 98, 67-68 Buick Electra, Wildcat, 67 Pontiac Catalina, Bonneville, Executive, 67 Grand Prix Convertible 2 Door Hardtop	2342
D		69-70	Door weatherstrip with clips & molded ends	2DR HTP CNV	69-70 Chevrolet Impala, Caprice, 69-70 Cadillac Calais, Deville, 69-70 Oldsmobile 88 Oldsmobile 98, 69-70 Buick LeSabre, Wildcat, Electra, 69-70 Pontiac Catalina, Bonneville, Executive, 2 Door Hardtop Convertible	2357
D		69-70	Door weatherstrip front doors with clips	4DR SDN SWG	69-70 Chevrolet Biscayne, Bel Air, Impala, Cadillac, Buick La Sabre, Wildcat, Pontiac, 4 Door Sedan Station Wagon	2510













GUIDE TO SOFFSEAL'S PRODUCT CODES

B = Bumper sets **C** = Glass channels **D** = Door related **G** = Seals, gaskets **H** = Under hood items **I** = Interior parts
M = Miscellaneous items **R** = Roofrail, pillar post & convertible items **T** = Trunk related **W** = Window related **Z** = Weatherstrip kits



CODE	IMAGE	YEAR	DESCRIPTION	BODY	FITS	ITEM#
G		60-63-64-69-70	Door handle & lock gaskets	2DR 4DR HTP 2DR SDN CNV SWG	60 Chevrolet Biscayne, Impala, Bel Air, Cadillac, Oldsmobile 89 Oldsmobile 98, Buick LeSabre, Invicta, Electra, Wild Cat, Pontiac Catalina, Star Chief, Bonneville, Grand Prix, Ventura	2098
H		64-65-66-67-68-69-70-71-72	Firewall wiring gutter plk	2DR 4DR HTP 2DR SDN SWG CNV	Chevy Chevelle, Biscayne, Bel Air, Impala, Caprice, Nova, Camaro, Cadillac Calais, Deville, Fleetwood, Oldsmobile 88, 98, Jetstar, Starfire, Pontiac Catalina, Bonneville, Firebird, Buick Lesabre, Wildcat, Electra	2328
H		67-68	Hood insulation	2DR 4DR HTP 2DR SDN CNV	67-68 Buick LeSabre, Wildcat, Electra	23911
I		59-60-61-62-63-64-65-66	Gear shift grommet column	2DR 4DR SDN HTP CNV	59-66 Chevrolet Biscayne, Bel Air, Impala, 59-66 Cadillac, 59-63 Oldsmobile 88 Oldsmobile 98, 61 Starfire, 64-66 Starfire, Jet Star, 59-66 Buick LeSabre, Invicta, Electra, 63 Wildcat, Riviera, 59-66 Pontiac	2185A
I		64-65-66-67-68-69-70-71-72-73-74	Park brake pedal pad	2DR HTP CNV	El Camino Cutlass Chevelle Chevy II Camaro Firebird LeMans Tempest GTO Grand Prix Full Size Centurion Century Electra Invicta LeSabre Regal Riviera Skylark Wildcat Monte Carlo	3094
R		62-63-64	Weatherstrip kit for convertible top second type with 5 3/8" between center studs	CNV	62-64 Chevrolet Impala, Oldsmobile 88, Starfire, Buick LeSabre, Invicta, Pontiac, Bonneville, Catalina, 63-64 Buick Wildcat Convertible	2152
R		62-63-64	Weatherstrip kit for convertible top with 5 3/8" between center studs cloth covered	CNV	62-64 Chevrolet Impala, Cadillac, Oldsmobile 88, Starfire, Buick LeSabre, Invicta, Wildcat, Pontiac Catalina, Bonneville	2152C
R		63-64	Pillar post weatherstrip with molded ends	CNV	63-64 Chevrolet Impala, 63-64 Cadillac 63 Series 6200, Eldorado 64 Deville, Eldorado, 63-64 Oldsmobile 88 Oldsmobile 98, Starfire, 63-64 Buick LeSabre, Wildcat, 63-64 Pontiac, Convertible	2193
R		63-64	Roofrail weatherstrip with molded ends	2DR HTP	63-64 Chevrolet Impala, 63-64 Cadillac, 63-64 Oldsmobile 88, 63-64 Buick LeSabre, Wildcat, 63-64 Pontiac 2 Door Hardtop	2194
R		63-64	Roofrail weatherstrip with molded ends	4DR HTP	63-64 Chevrolet Impala, Buick LeSabre, Wildcat, Oldsmobile 88, Pontiac, 4 Door Hardtop	2194A
R		65	Weatherstrip kit for convertible top	CNV	65 Chevrolet Impala, 65 Cadillac, 65 Oldsmobile, 65 Buick LeSabre, Wildcat, 65 Pontiac, Convertible	2365
R		65	Pillar post weatherstrip with molded ends	CNV	65 Chevrolet Impala, 65 Cadillac Deville, Eldorado, 65 Oldsmobile 88 Oldsmobile 98, 65 Buick LeSabre, Wildcat, Electra, Invicta, 65 Pontiac, Convertible	2334







CODE	IMAGE	YEAR	DESCRIPTION	BODY	FITS	ITEM#
R		65-66	Roofrail weatherstrip with molded ends	2DR HTP	65-66 Chevrolet Impala, Caprice, 65-66 Cadillac Calais, Deville, 65-66 Oldsmobile 88, Jet Star, Star Fire, Oldsmobile 98, 65-66 Buick LeSabre, Wildcat, Electra, 65-66 Pontiac 2 Door Hardtop	2333
R		65-66-67-68-69-70	Header seal with clips and molded ends	CNV	65 Chevrolet, 66-70 Chevrolet Impala, 65-70 Cadillac Deville, 65-70 Oldsmobile 88 Oldsmobile 98, 65 Oldsmobile Starfire, 65-70 Buick LeSabre, Wildcat, Electra, 65-70 Pontiac, Convertible	23343
R		66-68	Pillar post weatherstrip with molded ends	CNV	66-68 Chevrolet Impala, 66-68 Cadillac Deville, 66 Cadillac Eldorado, 66-68 Oldsmobile 88 Oldsmobile 98, 66-68 Buick Electra, LeSabre, Wildcat, 66-68 Pontiac, Convertible	23341
R		66-67-68-69-70	Weatherstrip kit for convertible top includes header seal (7 piece kit)	CNV	66-70 Chevrolet Impala, 66-70 Oldsmobile 88, 66-70 Buick LeSabre, Wildcat, 66-70 Pontiac Bonneville, Catalina, 67 Pontiac Grand Prix, Convertible	2366
R		67-68	Roofrail weatherstrip with molded ends	2DR HTP	67-68 Chevrolet Impala, Caprice, 67-68 Cadillac, 67-68 Oldsmobile 88, 67-68 Buick Electra, Wildcat, 67-68 Pontiac Catalina, Executive 2 Door Hardtop	2345
R		67-68	Roofrail weatherstrip with thick c pillar section	4DR HTP	67-68 Chevrolet Impala, Caprice, Buick LeSabre, Wildcat, Pontiac Bonneville, Catalina, Executive 4 Door Hardtop	2351
R		69-70	Roofrail weatherstrip with molded ends	2DR HTP	69-70 Chevrolet Caprice, Impala, 69-70 Cadillac, 69-70 Oldsmobile 88, 69-70 Buick LeSabre, Wildcat, 69-70 Pontiac 2 Door Hardtop	2356
R		69-70	Roofrail weatherstrip	4DR HTP	69-70 Chevrolet Impala, Caprice, 69-70 Oldsmobile 88 Oldsmobile 98, 69-70 Buick LeSabre, Wildcat, Electra, 69-70 Pontiac Catalina, Bonneville, Executive 4 Door Hardtop	23561
R		69-70	Pillar post weatherstrip with molded ends	CNV	69-70 Chevrolet Impala, Caprice, 69-70 Cadillac Deville, 69-70 Oldsmobile 88 Oldsmobile 98, 69-70 Buick LeSabre, Wildcat, Electra, 69-70 Pontiac, Convertible	2358
T		58-59-60-61-62-63-64-65-66-67-68-69	Trunk weatherstrip exact profile	2DR 4DR HTP 2DR SDN CNV	58-64 Chevrolet Biscayne, 58-64 Chevrolet Bel Air, Chevrolet Impala, 60-69 Chevrolet Corvair, 59-64 Pontiac Parisienne, 59-64 Pontiac Catalina, 59-64 Pontiac Star Chief, 60-61 Pontiac Ventura, 62-64 Pontiac Grand Prix, 58-64 Oldsmobile Delta 88, 58-64 Oldsmobile Dynamic 88, Oldsmobile Super 88, Oldsmobile Super 98, 61-64 Oldsmobile Starfire, 64 Oldsmobile Jetstar, 59-64 Buick LeSabre, 59-62 Buick Invicta, 59-64 Buick Electra, 62-64 Buick Wildcat, 63-65 Buick Riviera, 58-60 Cadillac Deville, Cadillac Eldorado, Cadillac Series 62, Cadillac Series 60 Special, Cadillac Series 75, 58-64 C-Body	2001









GUIDE TO SOFFSEAL'S PRODUCT CODES

B = Bumper sets **C** = Glass channels **D** = Door related **G** = Seals, gaskets **H** = Under hood items **I** = Interior parts
M = Miscellaneous items **R** = Roofrail, pillar post & convertible items **T** = Trunk related **W** = Window related **Z** = Weatherstrip kits



CODE	IMAGE	YEAR	DESCRIPTION	BODY	FITS	ITEM#
T		64-65-66-67-68-69-70-71-72-73-74-75-76-77	Trunk weatherstrip exact profile length 17 feet	2DR 4DR HTP 2DR SDN CNV	65-72 Chevy II, 65-72 Chevrolet Biscayne, 65-75 Chevrolet Bel Air, 65-76 Chevrolet Impala, 65-76 Chevrolet Caprice, 64-77 Chevrolet Chevelle, 70-77 Chevrolet Monte Carlo, 65-76 Buick LeSabre, 64-77 Buick Wildcat, 64-77 Buick Skylark, 71-73 Buick Centurion, 64-72 Buick Grand Special, 73-77 Buick Century, 73-88 Buick Regal, 73-88 Buick Grand National, 65-76 Buick Electra, 65-76 Oldsmobile Delta 88, 67-69 Oldsmobile Delmont 88, 65-66 Oldsmobile Dynamic 88, 65-66 Oldsmobile Starfire, 65 Oldsmobile Jetstar, 64-77 Oldsmobile Cutlass 442, 64-88 Oldsmobile Cutlass, 65-76 Oldsmobile 98, 65-76 Pontiac Parisienne, 64-72 Pontiac LeMans, 65-70 Pontiac Catalina, 65-66 Pontiac Star Chief, 67-70 Pontiac Executive, 71-75 Pontiac Grand Ville, 65-77 Pontiac Grand Prix, 64-72 Pontiac Tempest, 62-72 Nova, Ventura, 73-74 Non-Hatchback, Up to 1975 with groove channel, Apollo, Nova, Omega, Ventura 65-76 C-Body	2003
W		61-62-63-64-65-66	Horizontal outer window seals	2DR 4DR HTP SDN CNV SWG	Chevy Biscayne, Bel Air, Impala, Caprice, Cadillac series 62 Deville, Eldorado, Fleetwood, Calais, Oldsmobile 88, Starfire, 98. Buick LeSabre, Invicta, Wildcat, Electra, Pontiac Catalina, Ventura, Star Chief, Bonneville	2310
W		63-64	Vent window seals	2DR HTP CNV	63-64 Chevrolet Impala, Buick Electra, LeSabre, Wildcat, Oldsmobile 98, Pontiac Catalina, Bonneville, 2 Door Hardtop Convertible, Starfire Convertible Only	21814
W		63-64	Vent window weatherstrip	2DR 4DR HTP	63-64 LeSabre Wildcat Coupe Deville Starfire Grand Prix	21815
W		65-66	Quarter window seals	2DR HTP CNV	65-66 Chevrolet Impala, 66 Chevrolet Caprice, 65-66 Cadillac Calais, Deville 65-66 Oldsmobile 88, Jetstar, 65-66 Buick LeSabre, Wildcat, 65-66 Pontiac Bonneville, Catalina, Star Chief 2 Door Hardtop Convertible	2301
W		65-66	Quarter window seals	4DR HTP	65-66 Chevrolet Impala, 66 Chevrolet Caprice, 65-66 Cadillac Calais, Deville, 65-66 Oldsmobile 88 Oldsmobile 98, 65-66 Buick LeSabre, Wildcat, Electra, 65-66 Pontiac Bonneville, Catalina, Star Chief 4 Door Hardtop	23011
W		65-66	Door u-jamb seal	2DR HTP CNV	65-66 Chevrolet Impala, 66 Caprice, 65-66 Cadillac Calais, Deville, Eldorado, 65-66 Oldsmobile 88, Jetstar, Starfire, Oldsmobile 98, 65-66 Buick LeSabre, Wildcat, Electra, 65 Pontiac Bonneville, Catalina, Star Chief 2hardtop Convertible	2368

CODE	IMAGE	YEAR	DESCRIPTION	BODY	FITS	ITEM#
W		65-66-67-68	Vent window weatherstrip	2DR HTP CNV	65-68 Chevrolet Impala, Buick LeSabre, Electra, Wildcat, Cadillac Calais, Deville, Oldsmobile 88 Oldsmobile 98 Starfire, Pontiac Bonneville, Catalina, Star Chief 2 Door Hardtop Convertible	2217
W		65-66-67-68	Glass run channel front window	2DR HTP CNV	65-68 Chevrolet Impala, Caprice, 65-68 Cadillac Calais, Deville 65-66 Eldorado, 65-68 Oldsmobile 88 Oldsmobile 98, 65-66 Oldsmobile Jetstar, Starfire, 65-68 Buick LeSabre, Wildcat, Electra, 65-68 Pontiac Bonneville, Catalina, Executive 2 Door Hardtop Convertible	2350
W		67-68	Quarter window u-jamb	2DR HTP CNV	67-68 Chevrolet Impala, 67-68 Cadillac Calais, Deville, 67 Oldsmobile 98, 67-68 Buick LeSabre, Wildcat, Electra, 67-68 Pontiac Bonneville, Catalina 2 Door Hardtop	2292
W		67-68	Quarter window seals	2DR HTP	67-68 Chevrolet Impala, 67-68 Cadillac Calais, Deville 67-68 Oldsmobile 88, 98, 67-68 Buick LeSabre, Wildcat, Electra 67-68 Pontiac Catalina, Bonneville, Executive 2 Door Hardtop	2302
W		67-68	Quarter window seals	CNV	67-68 Chevrolet Impala, 67-68 Cadillac Deville, 67-68 Oldsmobile 88 Oldsmobile 98, 67-68 Buick LeSabre, Wildcat, Electra, 67-68 Pontiac Catalina, Bonneville Convertible	23021
W		67-68	Quarter window u-jamb	2 DR CNV HTP	67-68 Chevy Impala Convertible 68 Caprice Sport Coupe, 67 Buick LeSabre, Wildcat Convertible, 67 Electra 2 Door Hardtop & Convertible, 68 Buick Wildcat, Electra, LeSabre 2 Door Hardtop & Convertible, 67 Cadillac Deville Convertible, 68 Cadillac Calais, Deville Hardtop & Convertible 67-68 Oldsmobile 88, Oldsmobile 98, 67-68 Pontiac Catalina, Bonneville, Executive, Grand Prix Hardtop & Convertible	2294
W		69-70	Qtr window u jamb	CNV 2DR HTP	69-70 Chevrolet Impala, 69-70 Cadillac, Eldorado, 69-70 Oldsmobile 88 Oldsmobile 98, 69-70 Buick LeSabre, Wildcat, 69 Pontiac Catalina, Executive, Bonneville Convertible 2 Door Hardtop	2293



GUIDE TO SOFFSEAL'S PRODUCT CODES

B = Bumper sets **C** = Glass channels **D** = Door related **G** = Seals, gaskets **H** = Under hood items **I** = Interior parts
M = Miscellaneous items **R** = Roofrail, pillar post & convertible items **T** = Trunk related **W** = Window related **Z** = Weatherstrip kits



CODE	IMAGE	YEAR	DESCRIPTION	BODY	FITS	ITEM#
B		51-52-53-54-55-56-57-58	Upper vent window bumpers	2DR 4DR HTP 2DR SDN CNV SWG	51-58 Chevrolet 150 210 Bel Air Nomad Del Ray Biscayne Impala, 51-54 Chevrolet, Pontiac, Oldsmobile, Buick, Cadillac, Hardtop Convertible	1224
B		58-59-60-61-62-63-64-65-66-67-68	Trunk bumpers	2DR 4DR HTP 2DR SDN CNV SWG	58-64 Chevrolet, Pontiac, Oldsmobile, Buick, Cadillac, 67-68 Pontiac Firebird, Chevrolet Camaro	2322
B		59-60	Vent window bumpers upper	2DR HTP	59-60 Chevrolet Bel Air, Impala Pontiac Catalina, Star chief Oldsmobile Dynamic 88, Super 88, 98, Cadillac Deville, Eldorado, Series 62, Buick Lesabre, Invicta, Electra Full Size 2 Door Hardtop	2202
B		59-60-61-62-63-64-65-66-67	Door bumpers	2DR HTP 2DR SDN 2DR SDN CNV SWG	59-67 Chevrolet, Pontiac, Oldsmobile, Buick, Cadillac, 62-67 Chevy II, Nova, 66-67 Chevrolet Chevelle, Oldsmobile Cutlass, Buick Skylark, Pontiac Tempest, LeMans, GTO	2320
B		61-62	Upper vent window bumper	2DR HTP	61-62 Chevrolet Bel Air, Impala, Pontiac Catalina, Bonneville, Ventura, Cadillac, Buick, Oldsmobile, 2 Door 4 Door Hardtop	2087
B		61-62	Upper vent window bumper	CNV	61-62 Chevrolet Impala, Bel Air, Pontiac Catalina, Bonneville, Oldsmobile 88, 98, Buick LeSabre, Electra 225, Cadillac Deville Convertible	2088
B		62-63-64	Gas door bumpers	2DR 4DR HTP 2DR SDN CNV SWG	62-64 Chevrolet Biscayne, Bel Air, Impala, Cadillac, Oldsmobile, Buick, Pontiac	2143
B		63-64	Upper vent window bumpers	CNV	63-64 Impala, Bonneville, Catalina, Oldsmobile 88, 98, LeSabre, Electra 225, Deville, Convertible	2203
B		63-64	Vent window bumpers, upper	2DR 4DR HTP	63-64 Chevrolet Impala, 63-64 Cadillac, Deville, 63-64 Oldsmobile 88, 98, 63-64 Buick LeSabre, Electra, 63-64 Pontiac Bonneville, Catalina, 2 Door 4 Door Hardtop	2204
B		65	Hood side bumpers	2DR 4DR HTP 2DR SDN CNV SWG	65 Chevrolet Biscayne, Impala, Bel Air, Caprice, Chevelle, Malibu, 65 Cadillac, 65 Oldsmobile, 65 Buick, 65 Pontiac	2182
B		66-67-68-69-70-71-72	Hood side bumpers	2DR 4DR SDN HTP CNV	66-72 Chevrolet Biscayne, Bel Air, Impala, Caprice, 73-75 Nova, 66-72 Cadillac, 66-72 Oldsmobile, 66-72 Buick, 66-72 Pontiac	2179
B		66-67-68-69-70-71-72	Bumper kit, includes: door hood trunk glove box	2DR 4DR HTP 2DR SDN CNV SWG	66 Chevrolet Biscayne, Bel Air, Impala, Caprice, 68-69 Chevelle, 70-71 Chevelle, Monte Carlo, 72 Chevelle, 66-72 Cadillac, 66-72 Oldsmobile, 66-72 Buick, 66-72 Pontiac	2371
B		67-68-69-70	Door bumpers	2DR 4DR HTP 2DR SDN CNV SWG	67-70 Chevrolet Biscayne, Bel Air, Impala Caprice, 67-70 Cadillac Calais, Deville, Fleetwood, 67-70 Oldsmobile 88, 98, 67-70 Buick LeSabre, Wildcat, Electra, 67-70 Pontiac	2323

Cadillac • All Models

CODE	IMAGE	YEAR	DESCRIPTION	BODY	FITS	ITEM#
C		58	Glass channel front	2DR HTP CNV	58 Chevrolet Impala, 58 Cadillac, 58 Oldsmobile, 58 Buick, 58 Pontiac, 2 Door Hardtop	2040
C		59-60	Glass channel	2DR 4DR HTP CNV	59-60 Chevrolet Bel Air, Impala, Cadillac Series 62, Deville, Eldorado, Oldsmobile 88 Oldsmobile 98, Buick LeSabre, Invicta, Electra, Pontiac Catalina, Star Chief, Bonneville 2 Door 4 Door Hardtop Convertible	2080
C		61-62	Glass channel front	2DR HTP	61 Chevrolet Impala, 62 Chevrolet Bel Air, 61 Cadillac Series 62, 62 Cadillac Deville 4 Door S, 61-62 Oldsmobile 88 Oldsmobile 98, 61 Buick LeSabre, Invicta, Electra, 62 Buick, 61-62 Pontiac Catalina, Ventura, Star Chief, Bonneville 2 Door Hardtop	2161
C		61-62	Glass channel front	CNV HT	62 Chevrolet, Pontiac, Oldsmobile, Buick, Cadillac Formal Roof Hardtop, 61-62 Convertible, 61 Pontiac, Oldsmobile, Buick, Cadillac Formal Roof Hardtop	2162
C		62-63-64	Glass channel rear	2DR 4DR SDN	62-63 Chevrolet Biscayne, Bel Air, Impala, 62-64 Cadillac, 62-64 Oldsmobile 88, 62-64 Buick LeSabre, 64 Wildcat, 62-64 Pontiac Catalina, Star Chief 2 Door 4 Door Sedan	2189
C		63-64	Glass channel front	4DR HTP	63-64 Chevrolet Impala, 63-64 Cadillac, 63-64 Oldsmobile 88 Oldsmobile 98, 63-64 Buick, 63-64 Pontiac, 4 Door Hardtop	21841
C		63-64	Windshield gasket	2DR SDN SWG	63-64 Chevrolet Biscayne, Bel Air, Impala, 63-64 Cadillac Series 62, Deville, 63-64 Oldsmobile 88 Oldsmobile 98, 63-64 Buick LeSabre, Wildcat, Electra, 63-64 Pontiac, 2 Door Sedan Station Wagon	2020
C		63-64	Glass channel front	2DR HTP CNV	63-64 Chevrolet Impala, 63-64 Cadillac, 63-64 Oldsmobile 88, Oldsmobile 98 Starfire Convertible Only, 63-64 Buick LeSabre, Wildcat, Electra, 63-64 Pontiac, 2 Door Hardtop Convertible	2021
D		54-55-56	Door weatherstrip	CNV	54-56 Buick Super, Roadmaster Riviera, Cadillac Convertible	0549
D		58	Door weatherstrip with clips & molded ends	2DR HTP CNV	58 Chevrolet Impala, Cadillac, Oldsmobile 88 Convertible Only, Buick Century Convertible Only, Pontiac, 2 Door Hardtop Convertible	2010
D		58	Door j weatherstrip	2DR 4DR HTP 2DR SDN CNV SWG	58 Chevrolet Del Ray, Biscayne, Bel Air, Impala, 58 Cadillac, 57-58 Oldsmobile 88 Oldsmobile 98, 57-58 Buick Special Century, Super, Roadmaster, 58 Pontiac	2044
D		59-60	Door j weatherstrip	2DR 4DR HTP SWG 2DR SDN 4DR SDN	59-60 Chevrolet, Pontiac, Oldsmobile, Buick, Cadillac	2093













GUIDE TO SOFFSEAL'S PRODUCT CODES

B = Bumper sets **C** = Glass channels **D** = Door related **G** = Seals, gaskets **H** = Under hood items **I** = Interior parts
M = Miscellaneous items **R** = Roofrail, pillar post & convertible items **T** = Trunk related **W** = Window related **Z** = Weatherstrip kits



CODE	IMAGE	YEAR	DESCRIPTION	BODY	FITS	ITEM#
D		59-60	Door weatherstrip with clips & molded ends	2DR HTP CNV	59-60 Chevrolet Impala, Bel Air, Pontiac Catalina, Star Chief, Bonneville, Oldsmobile 88, 98, Buick LeSabre, Invicta, Electra, Cadillac Deville, Eldorado, Series 62 Hardtop Convertible	2011
D		59-60	Door weatherstrip rear door with clips & molded ends	4DR HTP	59-60 Chevrolet Impala, Bel Air, Buick Electra, Invicta, LeSabre, Cadillac 62 Deville, Eldorado, Oldsmobile 98 Oldsmobile 99, 4 Door Hardtop	2206
D		61-62	Door weatherstrip, front doors	4DR HTP	61-62 Chevrolet Impala, Bel Air, Buick Electra, LeSabre, Invicta, Cadillac Series 60, Oldsmobile 88 Oldsmobile 98, 4 Door Hardtop	2207
D		61-62	Door weatherstrip with clips & molded ends	2DR HTP CNV	61-62 Chevrolet Bel Air Impala, Cad Series 62, Deville, 61-62 Oldsmobile, 61 Hardtop Convertible 88 Star Fire, Oldsmobile 98/62 Oldsmobile 88 Oldsmobile 98 Starfire, 61-62 Buick 61 Hardtop Convertible, 62 Convertible Only LeSabre Invicta Electra, 61-62 Pontiac, 2 Door Hardtop Convertible	2013
D		61-62-63-64	Door weatherstrip rear door with clips	4DR SDN	61-64 Chevrolet Biscayne Bel Air Impala, 61-64 Oldsmobile 88, 98, 61-62 Cadillac, 61-64 Buick LeSabre Electra, 64 Wildcat, 61-64 Pontiac Catalina, Star Chief, 4 Door Sedan	2009
D		63-64	Door weatherstrip with clips & molded ends	2DR HTP CNV	63-64 Chevrolet Impala, 63-64 Cadillac Eldorado, Deville, 63-64 Oldsmobile 88 Oldsmobile 98 Starfire 63-64 Buick LeSabre Wildcat, Electra 63 Invicta, 63-64 Pontiac Catalina, Bonneville, Grand Prix, 2 Door Hardtop Convertible	2014
D		63-64	Door weatherstrip front with clips	4DR SDN SWG	63-64 Chevrolet Biscayne, Bel Air, Impala, 63-64 Cadillac, 63-64 Oldsmobile 88, 63-64 Buick LeSabre, Wildcat, 63-64 Pontiac, 4 Door Sedan Station Wagon	2017
D		65-66	Door weatherstrip front with clips	4DR SDN SWG	65-66 Chevrolet Biscayne Bel Air Impala, 65-66 Cadillac Calais Deville Fleetwood, 65-66 Oldsmobile 88, 65-66 Buick LeSabre Wildcat, 65-66 Pontiac Bonneville, Catalina, Star chief, 4 Door Sedan Swg	2006
D		65-66	Rear door weatherstrip with clips	4DR SDN	65-66 Chevrolet Biscayne Bel Air Impala 65-66 Cadillac Calais Deville Fleetwood 65-66 Oldsmobile 88, 65-66 Buick LeSabre Wildcat, 65-66 Pontiac Catalina, Star Chief, 4 Door Sedan	2007
D		65-66	Door weatherstrip with clips & molded ends	2DR HTP CNV	65-66 Chevrolet Impala, Caprice, 65-66 Cadillac Calais, Deville, 65-66 Oldsmobile 88, Starfire, Oldsmobile 98, 65 Jet Star, 65-66 Buick LeSabre, Wildcat Electra, 65-66 Pontiac 2 Door Hardtop Convertible	2331
D		65-66	Door weatherstrip with clips	2DR SDN	65-66 Chevrolet Biscayne, Bel Air, 65-66 Cadillac, 65-66 Oldsmobile, 65-66 Buick, 65-66 Pontiac, 2 Door Sedan	2332

Cadillac • All Models

CODE	IMAGE	YEAR	DESCRIPTION	BODY	FITS	ITEM#
D		65-66-67-68	Door weatherstrip front door with clips & molded ends	4DR HTP	65-68 Chevrolet Impala, Buick Wildcat, LeSabre, Cadillac Calais, Deville, Oldsmobile 98 Oldsmobile 99, Pontiac, 4 Door Hardtop	2210
D		67-68	Door weatherstrip rear door	4DR HTP	67-68 Cadillac Calais, Deville, 4 Door Hardtop	2209
D		67-68	Front door weatherstrip with clips	4DR SDN SWG	67-68 Chevrolet Biscayne, Bel Air, Impala, 67-68 Cadillac Calais, Deville, Fleetwood, 67-68 Oldsmobile Delmont 88, Delta 88, 98, 67-68 Buick LeSabre, Wildcat, Electra 67-68 Pontiac Catalina, Executive, Bonneville, 4 Door Sedan Station Wagon	23321
D		67-68	Door weatherstrip rear with clips	4DR SDN	67-68 Chevrolet Biscayne, Bel Air, Impala, 67-68 Cadillac Calais, Deville, Fleetwood, 67-68 Oldsmobile 88, 67-68 Buick LeSabre, Wildcat, 67-68 Pontiac Bonneville Station Wagon, 67-68 Pontiac Executive, Catalina, 4 Door Sedan	23322
D		67-68	Door weatherstrip with clips	2DR SDN	67-68 Chevrolet Biscayne, Bel Air, 67-68 Cadillac, 67-68 Oldsmobile, 67-68 Buick, 67-68 Pontiac, 2 Door Sedan	2329
D		67-68	Door weatherstrip with clips & molded ends	CNV 2DR HTP	67-68 Chevrolet Impala, Caprice, Except 68 Caprice 2 Door Hardtop, 67-68 Cadillac Calais, Deville, 67-68 Oldsmobile 88 Oldsmobile 98, 67-68 Buick Electra, Wildcat, 67 Pontiac Catalina, Bonneville, Executive, 67 Grand Prix Convertible 2 Door Hardtop	2342
D		69-70	Door weatherstrip with clips & molded ends	2DR HTP CNV	69-70 Chevrolet Impala, Caprice, 69-70 Cadillac Calais, Deville, 69-70 Oldsmobile 88 Oldsmobile 98, 69-70 Buick LeSabre, Wildcat, Electra, 69-70 Pontiac Catalina, Bonneville, Executive, 2 Door Hardtop Convertible	2357
D		69-70	Door weatherstrip front doors with clips	4DR SDN SWG	69-70 Chevrolet Biscayne, Bel Air, Impala, Cadillac, Buick La Sabre, Wildcat, Pontiac, 4 Door Sedan Station Wagon	2510
D		69-70	Door weatherstrip rear doors with clips	4DR SDN	69-70 Chevrolet, Buick, Oldsmobile Delta 88, Pontiac Catalina, Bonneville Executive, 4 Door Sedan	2511
D		71-72-73-74-75-76	Door weatherstrip with clips & molded ends	2DR HTP CNV	71-76 Chevrolet Impala, Caprice, Cadillac Calais, Deville, Buick 71-73 LeSabre, Centurion, Electra, 74-76 LeSabre, Electra, Oldsmobile 88 Oldsmobile 98, Pontiac Bonneville, Catalina, 71-75 Grandville 2 Door Hardtop Convertible	2512
D		71-72-73-74-75-76	Door weatherstrip front doors with clips & molded ends	4DR HTP	71-76 Chevrolet Caprice, Impala, Buick, Electra, LeSabre, Centurion, Cadillac Calais, Deville, Oldsmobile 88 Oldsmobile 98, Catalina, Bonneville, Granville, 4 Door Hardtop	2213















GUIDE TO SOFFSEAL'S PRODUCT CODES

B = Bumper sets **C** = Glass channels **D** = Door related **G** = Seals, gaskets **H** = Under hood items **I** = Interior parts
M = Miscellaneous items **R** = Roofrail, pillar post & convertible items **T** = Trunk related **W** = Window related **Z** = Weatherstrip kits



CODE	IMAGE	YEAR	DESCRIPTION	BODY	FITS	ITEM#
D		77-78-79-80-81-82-83-84-85-86	Front door weatherstrip with clips	4DR SDN RWD	77-86 Impala Caprice, 77-84 Cadillac Deville Fleetwood, 85-86 Fleetwood, 77-84 Oldsmobile 88 89, 85 88, 77-84 Buick LeSabre Electra 85 LeSabre, 77-79 Buick Estate Wagon, 82-83 Buick Park Ave 77-81 Pontiac Bonneville, 83-86 Pontiac Parisienne, 77-80 Pontiac Catalina 4 Door Sedan, RWD Only	2500
D		77-78-79-80-81-82-83-84-85-86-87	Door weatherstrip with clips	2DR SDN RWD	84-87 Chevrolet Caprice, 77-81 Chevrolet Impala, 83 Chevrolet, 77-84 Cadillac Deville, 80-84 Fleetwood, 77-84 Oldsmobile 88 Oldsmobile 98, 85 Oldsmobile 88, 77-84 Buick LeSabre, Electra, 85 LeSabre, 77-81 Pontiac Bonneville, Catalina 2 Door Sedan, RWD Only	2359
D		77-78-79-80-81-82-83-84-85-86-87-88-89-90	Door weatherstrip rear door with clips	4DR SDN RWD	77-90 Chevrolet, 77-90 Cadillac Fleetwood, 77-84 Oldsmobile 98, 77-84 Buick Electra, Park Avenue 77-90 Pontiac, 4 Door Sedan, RWD Only	23591
D		77-78-79-80-81-82-83-84-85-86-87-88-89-90	Rear door weatherstrip with clips	4DR SDN RWD	77-86 Chevrolet Impala Caprice, 87-88 Caprice Caprice Classic, 89 Caprice, 90 Caprice Caprice Classic, 77-84 Cadillac Deville, 77-85 Oldsmobile 88, 77-78 Town Sedan, Custom Crusier, 77-84 Buick LeSabre Electra 85 LeSabre, 77-81 Pontiac Bonneville, Catalina, 83-86 Pontiac Parisienne 4 Door Sedan, RWD Only	2502
D		77-78-79-80-81-82-83-84-85-86-87-88-89-90	Rear door weatherstrip with clips	4 DR SWG, RWD	77-86 Chevrolet Impala Caprice, 87-88 Caprice Caprice Classic, Cadillac, 77-85 Oldsmobile Custom Cruiser, 77-88 Estate Station Wagon, 77-81 Catalina Safari Bonneville Safari, 82 Bonneville Safari, 83 Bonneville Parisienne, 84-89 Parisienne Station Wagon, RWD Only	2503
D		82-83-84-85-86-87-88-89-90-91-92	Door weatherstrip front/rear	All	82-89 Skyhawk 92-97 Skylark 82-88 Cimarron 93-96 Fleetwood 82-94 Beretta 82-94 Cavalier 91-96 Caprice 82-96 Corsica 82-94 Lumina 82-93 S10 83-94 S10 Blazer 82-05 Chev Van 83-94 GMC Jimmy 82-93 GMC Sonoma 82-05 GMC Van 82-94 Achieva 82-85 Custom Cruiser 82-94 Firenza 82-94 Grand Am 82-94 Sunbird	9110
D		85-86-87-88-89-90-91	Door weatherstrip with clips	2DR SDN RWD	85-91 Cadillac Coupe Deville, RWD Only	23592
D		87-88-89-9087-88-89-9087-88-89-90	Front door weatherstrip with clips	4DR SDN RWD Only	87-90 Chevrolet Caprice, Caprice Classic Brougham, 87-90 Cadillac, 87-90 Oldsmobile, 87-90 Buick, Pontiac, 4 Door Sedan, RWD Only	2501
G		00-99	Gas tank anti squeak strips	2DR 4DR HTP SDN CNV SWG TRK	All Except Camaro And Firebird	1012

Cadillac • All Models

CODE	IMAGE	YEAR	DESCRIPTION	BODY	FITS	ITEM#
G		49-50-51-52-53-54	Door handle and lock gasket set	2DR 4DR HTP SDN CNV SWG CPE	All Buick, Cadillac, Chevrolet, Olds, Pontiac	0421
G		60-63-64-69-70	Door handle & lock gaskets	2DR 4DR HTP 2DR SDN CNV SWG	60 Chevrolet Biscayne, Impala, Bel Air, Cadillac, Oldsmobile 89 Oldsmobile 98, Buick LeSabre, Invicta, Electra, Wild Cat, Pontiac Catalina, Star Chief, Bonneville, Grand Prix, Ventura	2098
G		61-62-65-66-67-68	Door handle & lock gaskets	2DR 4DR HTP 2DR SDN CNV SWG	61-62 Chevrolet Biscayne, Bel Air, Impala, Cadillac, Oldsmobile 88 Oldsmobile 98, Buick LeSabre, Invicta, Electra, Pontiac	2145
G		71-72-73-74-75- 76-77-78	Door handle gaskets	2DR HTP CNV 2DR SDN	71-76 Buick LeSabre, Electra, Oldsmobile 98 Oldsmobile 88, 71-78 Tornado, Cadillac, 74-76 Riviera	2514
H		64-65-66-67-68- 69-70-71-72	Firewall wiring gutter plk	2DR 4DR HTP 2DR SDN SWG CNV	Chevy Chevelle, Biscayne, Bel Air, Impala, Caprice, Nova, Camaro, Cadillac Calais, Deville, Fleetwood, Oldsmobile 88, 98, Jetstar, Starfire, Pontiac Catalina, Bonneville, Firebird, Buick Lesabre, Wildcat, Electra	2328
H		65-66	Splash flap set 8 piece	2DR HTP CNV	65-66 Cadillac Deville Fleetwood	23241
H		65-66	Hood insulation	2DR 4DR HTP CNV 4DR SDN	65-66 Cadillac Calais Deville Fleetwood	23901
H		71-72-73-74-75-76- 77-78	Hood to cowl seal	2DR SDN 2DR HTP CNV SWG	71-78 Chevrolet Impala, Caprice, Biscayne, Bel Air, Brookwood, Townsmen, Kingswood, Buick Lesabre, Centurion, Electra 225, Estate Wagon, Cadillac Calais, Deville, Eldorado, Sixty Special Brougham, Oldsmobile 88, 98, Tornado, Pontiac Catalina, Bonneville, Grandville, Safari Full Size	2191
I		58	Gear shift grommet column	2DR 4DR SDN HTP CNV	58 Chevrolet Del Ray, Biscayne, Bel Air, Impala, Cadillac, Oldsmobile 88 Oldsmobile 98, Buick Special, Century, Roadmaster, Riviera, Pontiac	2185
I		59-60-61-62-63- 64-65-66	Gear shift grommet column	2DR 4DR SDN HTP CNV	59-66 Chevrolet Biscayne, Bel Air, Impala, 59-66 Cadillac, 59-63 Oldsmo- bile 88 Oldsmobile 98, 61 Starfire, 64-66 Starfire, Jet Star, 59-66 Buick LeSabre, Invicta, Electra, 63 Wildcat, Riviera, 59-66 Pontiac	2185A
M		00-99	Black weatherstrip adhesive	2DR 4DR SDN HTP CNV	All Makes And Models	3M08008
M		57-58-59-60-61- 62-63-64-65-66- 67-68-69-70-71-72- 73-74-75-76-77-78- 79-80-81	Bellhousing to clutch fork rubber boot	2DR 4DR HTP SDN CNV SWG	57-81 GM All Manual Transmission	2196
M		61-62	Bellhousing fork boot	2DR 4DR HTP SDN CNV SWG	61-62 Chevrolet Biscayne, Bel Air, Impala, 61-62 Cadillac, 61-62 Oldsmo- bile, 61-62 Buick, 61-62 Buick, 2 Door 4 Door Hardtop Sedan Convertible Station Wagon	2198









GUIDE TO SOFFSEAL'S PRODUCT CODES

B = Bumper sets **C** = Glass channels **D** = Door related **G** = Seals, gaskets **H** = Under hood items **I** = Interior parts
M = Miscellaneous items **R** = Roofrail, pillar post & convertible items **T** = Trunk related **W** = Window related **Z** = Weatherstrip kits



CODE	IMAGE	YEAR	DESCRIPTION	BODY	FITS	ITEM#
R		58	Roofrail weatherstrip with clips	2DR HTP	58 Chevrolet Impala, Cadillac, Oldsmobile, Buick, Pontiac, 2 Door Hardtop	2043
R		58-59-60-61-62-63-64	Header seal	CNV	Chevy Impala, Cadillac Series 62 Eldorado, Pontiac Catalina, Bonneville, Oldsmobile 88, 98, Starfire, Buick Lesabre, Invicta, Electra	2153
R		59-60	Roofrail weatherstrip with clips	2DR HTP	59-60 Chevrolet, Cadillac, Pontiac, Oldsmobile, Buick, 2 Door Hardtop	2090
R		59-60	Pillar post weatherstrip with clips and molded ends	CNV	59-60 Chevrolet Impala, Cadillac Eldorado Series 62, Pontiac Bonneville, Catalina, Oldsmobile 88 Oldsmobile 98, Buick LeSabre, Invicta, Electra	2091
R		59-60	Weatherstrip kit for convertible top with header seal	CNV	59-60 Chevrolet Impala, Cadillac, Oldsmobile 88, Buick LeSabre, Invicta, Pontiac, Convertible	2092
R		59-60	Weatherstrip kit for convertible top	CNV	59-60 Cadillac Series 62, Eldorado, 59-60 Oldsmobile 98, 59-60 Buick Electra, 59-60 Pontiac, Convertible	2155
R		59-60	Roofrail weatherstrip	4DR HTP SDN	59-60 Cadillac Deville, Fleetwood, 60 Special, 6 Window Sedan 4 Door Hardtop	2219
R		62	Roofrail weatherstrip with molded ends	2DR HTP	62 Chevrolet Impala, 62 Cadillac, 62 Oldsmobile 88, 62 Buick LeSabre, Invicta, Pontiac 2 Door Hardtop	2164
R		62	Pillar post weatherstrip with molded ends	CNV	61-62 Chevrolet Impala, 61-62 Cadillac 61 Series 6200, Eldorado 62 Eldorado, 61-62 Oldsmobile 88 Oldsmobile 98, Starfire, 61-62 Buick Electra, Invicta, LeSabre, 61-62 Catalina, Bonneville, Convertible	2154
R		62-63-64	Weatherstrip kit for convertible top with 5 3/8" between center studs cloth covered	CNV	62-64 Chevrolet Impala, Cadillac, Oldsmobile 88, Starfire, Buick LeSabre, Invicta, Wildcat, Pontiac Catalina, Bonneville	2152C
R		63-64	Pillar post weatherstrip with molded ends	CNV	63-64 Chevrolet Impala, 63-64 Cadillac 63 Series 6200, Eldorado 64 Deville, Eldorado, 63-64 Oldsmobile 88 Oldsmobile 98, Starfire, 63-64 Buick LeSabre, Wildcat, 63-64 Pontiac, Convertible	2193
R		63-64	Roofrail weatherstrip with molded ends	2DR HTP	63-64 Chevrolet Impala, 63-64 Cadillac, 63-64 Oldsmobile 88, 63-64 Buick LeSabre, Wildcat, 63-64 Pontiac 2 Door Hardtop	2194
R		65	Weatherstrip kit for convertible top	CNV	65 Chevrolet Impala, 65 Cadillac, 65 Oldsmobile, 65 Buick LeSabre, Wildcat, 65 Pontiac, Convertible	2365
R		65	Pillar post weatherstrip with molded ends	CNV	65 Chevrolet Impala, 65 Cadillac Deville, Eldorado, 65 Oldsmobile 88 Oldsmobile 98, 65 Buick LeSabre, Wildcat, Electra, Invicta, 65 Pontiac, Convertible	2334

Cadillac • All Models







CODE	IMAGE	YEAR	DESCRIPTION	BODY	FITS	ITEM#
R		65-66	Roofrail weatherstrip with molded ends	2DR HTP	65-66 Chevrolet Impala, Caprice, 65-66 Cadillac Calais, Deville, 65-66 Oldsmobile 88, Jet Star, Star Fire, Oldsmobile 98, 65-66 Buick LeSabre, Wildcat, Electra, 65-66 Pontiac 2 Door Hardtop	2333
R		65-66	Roofrail weatherstrip with molded ends	4DR HTP	65-66 Chevrolet Impala, Caprice, 65-66 Cadillac, 65-66 Oldsmobile 88, 65-66 Buick LeSabre, 65-66 Pontiac, 4 Door Hardtop	2333A
R		65-66-67-68-69-70	Header seal with clips and molded ends	CNV	65 Chevrolet, 66-70 Chevrolet Impala, 65-70 Cadillac Deville, 65-70 Oldsmobile 88 Oldsmobile 98, 65 Oldsmobile Starfire, 65-70 Buick LeSabre, Wildcat, Electra, 65-70 Pontiac, Convertible	23343
R		66-67-68-69-70	Weatherstrip kit for convertible top with out header seal	CNV	66-70 Cadillac Deville, 66 Cadillac Eldorado, 66-70 Oldsmobile 98, 66-70 Buick Electra, Convertible	23342
R		66-68	Pillar post weatherstrip with molded ends	CNV	66-68 Chevrolet Impala, 66-68 Cadillac Deville, 66 Cadillac Eldorado, 66-68 Oldsmobile 88 Oldsmobile 98, 66-68 Buick Electra, LeSabre, Wildcat, 66-68 Pontiac, Convertible	23341
R		67-68	Roofrail weatherstrip with molded ends	2DR HTP	67-68 Chevrolet Impala, Caprice, 67-68 Cadillac, 67-68 Oldsmobile 88, 67-68 Buick Electra, Wildcat, 67-68 Pontiac Catalina, Executive 2 Door Hardtop	2345
R		69-70	Pillar post weatherstrip with molded ends	CNV	69-70 Chevrolet Impala, Caprice, 69-70 Cadillac Deville, 69-70 Oldsmobile 88 Oldsmobile 98, 69-70 Buick LeSabre, Wildcat, Electra, 69-70 Pontiac, Convertible	2358
R		69-70	Roofrail weatherstrip with molded ends	2DR HTP	69-70 Chevrolet Caprice, Impala, 69-70 Cadillac, 69-70 Oldsmobile 88, 69-70 Buick LeSabre, Wildcat, 69-70 Pontiac 2 Door Hardtop	2356
R		71-72-73	Roofrail weatherstrip	2DR HTP	71-73 Chevrolet Impala, 71-73 Cadillac, 71-73 Oldsmobile 88, 71-73 Pontiac, 2 Door Hardtop	2420
R		71-72-73-74	Roofrail weatherstrip	4DR HTP	71-74 Buick Electra, Oldsmobile 98, Cadillac Deville, 4 Door Hardtop	2224
R		71-72-73-74-75	Roofrail weatherstrip	2DR HTP	71-73 Impala Custom Coupe Caprice, 74-75 Impala Sport Coupe, 71-76 Cadillac Calais Deville, 71-74 Electra, 74-76 LeSabre, 71-71 98, 74 Oldsmobile 98 Oldsmobile Delta 88, 75-76 Oldsmobile Delta 88, 71-73 Grandville, 74 Bonneville Catalina Grandville, 75-76 Catalina, 2 Door Hardtop	2509
R		71-72-73-74-75-76	Weatherstrip kit for convertible top	CNV	71-72 Chevrolet Impala, 73-76 Caprice, 71-76 Cadillac Eldorado, 71-75 Oldsmobile Delta 88, 71,72, 74 Buick LeSabre 71-73 Centurion, 71-72 Pontiac Catalina, 71-75 Grandville Convertible	2508





GUIDE TO SOFFSEAL'S PRODUCT CODES

B = Bumper sets **C** = Glass channels **D** = Door related **G** = Seals, gaskets **H** = Under hood items **I** = Interior parts
M = Miscellaneous items **R** = Roofrail, pillar post & convertible items **T** = Trunk related **W** = Window related **Z** = Weatherstrip kits



CODE	IMAGE	YEAR	DESCRIPTION	BODY	FITS	ITEM#
R		71-72-73-74-75-76	Header seal	CNV	71-75 Chevrolet Impala, Caprice, 71-72 Oldsmobile 88, 71-75 Pontiac Catalina, Grandville, 71-75 Buick Lesabre, Centurion, 71-76 Cadillac Eldorado, Convertible	2515
R		71-72-73-74-75-76	Pillar post weatherstrip with molded ends	CNV	71-75 Chevrolet Impala, Caprice 71-72 Oldsmobile 88, 71-75 Pontiac Catalina, Grandville, 71-75 Buick Lesabre, Centurion 71-76 Cadillac Eldorado, Convertible	2094
T		58-59-60-61-62-63-64-65-66-67-68-69	Trunk weatherstrip exact profile	2DR 4DR HTP 2DR SDN CNV	58-64 Chevrolet Biscayne, 58-64 Chevrolet Bel Air, Chevrolet Impala, 60-69 Chevrolet Corvair, 59-64 Pontiac Parisienne, 59-64 Pontiac Catalina, 59-64 Pontiac Star Chief, 60-61 Pontiac Ventura, 62-64 Pontiac Grand Prix, 58-64 Oldsmobile Delta 88, 58-64 Oldsmobile Dynamic 88, Oldsmobile Super 88, Oldsmobile Super 98, 61-64 Oldsmobile Starfire, 64 Oldsmobile Jetstar, 59-64 Buick LeSabre, 59-62 Buick Invicta, 59-64 Buick Electra, 62-64 Buick Wildcat, 63-65 Buick Riviera, 58-60 Cadillac Deville, Cadillac Eldorado, Cadillac Series 62, Cadillac Series 60 Special, Cadillac Series 75, 58-64 C-Body	2001
T		62-63-64-65-66-67-68-69-70-71-72-73	Door and tailgate bottom drain hole seal	2DR 4DR HTP SDN CNV SWG CPE	62-73 Chevy Nova, Chevelle, Impala, Caprice Pontiac Catalina, Star Chief, Bonneville, Grand Prix Oldsmobile F85	2118
T		75-76-77-78-79-80-81-82-83-84-85-86-87-88-89-90-91-92	Trunk and Hatchback weatherstrip	2DR 4DR SDN HTP CNV	77-85 Chevrolet Impala, 77-91 Chevrolet Caprice, 82-92 Chevrolet Camaro, 75-79 Chevrolet Nova, 78-88 Chevrolet Monte Carlo, 78-83 Chevrolet Malibu, 78-83 Pontiac LeMans, 82-92 Pontiac Firebird, 75-91 Pontiac Ventura, 77-86 Pontiac Parisienne, 77-81 Pontiac Catalina, 69-88 Pontiac Grand Prix, 64-87 Pontiac LeMans, Pontiac Grand Am, 64-77 Pontiac GTO, 73-79 Oldsmobile Omega, 77-85 Oldsmobile Delta 88, 77-84 Oldsmobile 98, 77-88 Oldsmobile Cutlass, 73-75 Buick Apollo, 76-79 Buick Skylark, 77-79 Phoenix, 73-88 Buick Regal, 77-84 Buick Electra, 77-85 Buick LeSabre, 77-78 Buick Riviera, 77-91 C-Body	2424
W		33-34-35-36-37-38-39-40-41-42-43-44-45-46-47-48-49-50-51-52-53-54-55-56-57-58-59-60-61-62-63	Vent window division bar channel, upper 16 in long	2DR 4DR SDN HTP CNV SWG	33-63 Chevrolet, Buick, Oldsmobile, Pontiac, 2 Door 4 Door Sedan Hardtop Convertible Station Wagon	2246
W		33-34-35-36-37-38-39-40-41-42-43-44-45-46-47-48-49-50-51-52-53-54-55-56-57-58-59-60-61-62-63	Vent window division bar channel, lower 16 in long	2DR SDN 4DR HTP CNV SWG	33-63 Chevrolet, Buick, Cadillac, Pontiac, 2 Door Sedan 4 Door Hardtop Convertible Station Wagon	2247

Cadillac • All Models

CODE	IMAGE	YEAR	DESCRIPTION	BODY	FITS	ITEM#
W		48-49	Windshield post weatherstrip seals	CPE CNV	49 Buick Riviera, Cadillac Coupe Deville, Oldsmobile 98, Holiday Coupe, 48-49 Cadillac, Oldsmobile 98 Convertible	0553
W		54-55-56-62	Vent window division post weatherstrip	CNV	54-56 Cadillac, Buick Super And Roadmaster 62 Eldorado Convertible	1034
W	 IMAGE COMING SOON	56-57-58-59-60-61-62	Vent window weatherstrip	2DR HTP CNV	54-56 Cadillac Hardtop Convertible, 54-55 Buick Super And Roadmaster Hardtop Convertible, 56 Buick Super And Roadmaster Convertible	10341
W		58	Window weatherstrip original style with round bead	CNV	58 Chevrolet Impala, 58 Cadillac, 58 Oldsmobile 88 Oldsmobile 98, 58 Buick Special, Century, Roadmaster, 58 Pontiac, Convertible	2038
W		58	Quarter window u-jamb	2DR HTP	58 Chevrolet Impala, Cadillac, Oldsmobile, Buick, Pontiac, 2 Door Hardtop	2285
W		58-59-60	Quarter window u-jamb	CNV	58-60 Chevrolet Impala, 58 Cadillac, 59-60 Cadillac Series 62, Eldorado, 58-60 Oldsmobile 88 Oldsmobile 98, 58 Buick, 59-60 Buick LeSabre, Invicta, Electra, 58 Pontiac, Convertible	2286
W		58-59-60-61-62-63-64	Quarter window seals	2DR HTP CNV	58-64 Chevrolet Impala, 58, 60-62 Bel Air, 58-64 Cadillac Series 62, Deville, Eldorado, 58 Oldsmobile 88 Oldsmobile 98, 59-60 Oldsmobile 88 Oldsmobile 98, 61-64 Oldsmobile 99, Starfire, 98, 64 Jetstar, 59-62 Buick LeSabre, Invicta, Electra 2 Door Hardtop Convertible	2300
W		61-62	Vent window seals	2DR 4DR HTP CONV	61-62 Chevrolet Bel Air, Impala, 61-62 Cadillac Series 62, Eldorado, 61-62 Oldsmobile 88 Oldsmobile 98, 61-62 Buick LeSabre, Invicta, Electra, 61-62 Pontiac Bonneville, Catalina, Ventura 2 Door 4 Door Hardtop, Convertible	21615
W		61-62-63-64-65-66	Horizontal outer window seals	2DR 4DR HTP SDN CNV SWG	Chevy Biscayne, Bel Air, Impala, Caprice, Cadillac series 62 Deville, Eldorado, Fleetwood, Calais, Oldsmobile 88, Starfire, 98, Buick Lesabre, Invicta, Wildcat, Electra, Pontiac Catalina, Ventura, Star Chief, Bonneville	2310
W		65-66	Quarter window seals	2DR HTP CNV	65-66 Chevrolet Impala, 66 Chevrolet Caprice, 65-66 Cadillac Calais, Deville 65-66 Oldsmobile 88, Jetstar, 65-66 Buick LeSabre, Wildcat, 65-66 Pontiac Bonneville, Catalina, Star Chief 2 Door Hardtop Convertible	2301
W		65-66	Quarter window seals	4DR HTP	65-66 Chevrolet Impala, 66 Chevrolet Caprice, 65-66 Cadillac Calais, Deville, 65-66 Oldsmobile 88 Oldsmobile 98, 65-66 Buick LeSabre, Wildcat, Electra, 65-66 Pontiac Bonneville, Catalina, Star Chief 4 Door Hardtop	23011











GUIDE TO SOFFSEAL'S PRODUCT CODES

B = Bumper sets **C** = Glass channels **D** = Door related **G** = Seals, gaskets **H** = Under hood items **I** = Interior parts
M = Miscellaneous items **R** = Roofrail, pillar post & convertible items **T** = Trunk related **W** = Window related **Z** = Weatherstrip kits



CODE	IMAGE	YEAR	DESCRIPTION	BODY	FITS	ITEM#
W		65-66	Door u-jamb seal	2DR HTP CNV	65-66 Chevrolet Impala, 66 Caprice, 65-66 Cadillac Calais, Deville, Eldorado, 65-66 Oldsmobile 88, Jetstar, Starfire, Oldsmobile 98, 65-66 Buick LeSabre, Wildcat, Electra, 65 Pontiac Bonneville, Catalina, Star Chief 2hardtop Convertible	2368
W		65-66-67-68	Vent window weatherstrip	2DR HTP CNV	65-68 Chevrolet Impala, Buick LeSabre, Electra, Wildcat, Cadillac Calais, Deville, Oldsmobile 88 Oldsmobile 98 Starfire, Pontiac Bonneville, Catalina, Star Chief 2 Door Hardtop Convertible	2217
W		65-66-67-68	Glass run channel front window	2DR HTP CNV	65-68 Chevrolet Impala, Caprice, 65-68 Cadillac Calais, Deville 65-66 Eldorado, 65-68 Oldsmobile 88 Oldsmobile 98, 65-66 Oldsmobile Jetstar, Starfire, 65-68 Buick LeSabre, Wildcat, Electra, 65-68 Pontiac Bonneville, Catalina, Executive 2 Door Hardtop Convertible	2350
W		67-68	Quarter window seals	2DR HTP	67-68 Chevrolet Impala, 67-68 Cadillac Calais, Deville 67-68 Oldsmobile 88, 98, 67-68 Buick LeSabre, Wildcat, Electra 67-68 Pontiac Catalina, Bonneville, Executive 2 Door Hardtop	2302
W		67-68	Quarter window seals	CNV	67-68 Chevrolet Impala, 67-68 Cadillac Deville, 67-68 Oldsmobile 88 Oldsmobile 98, 67-68 Buick LeSabre, Wildcat, Electra, 67-68 Pontiac Catalina, Bonneville Convertible	23021
W		67-68	Quarter window u-jamb	2 DR CNV HTP	67-68 Chevy Impala Convertible 68 Caprice Sport Coupe, 67 Buick Lasabre, Wildcat Convertible, 67 Electra 2 Door Hardtop & Convertible, 68 Buick Wildcat, Electra, Lesabre 2 Door Hardtop & Convertible, 67 Cadillac Deville Convertible, 68 Cadillac Calais, Deville Hardtop & Convertible 67-68 Oldsmobile 88, Oldsmobile 98, 67-68 Pontiac Catalina, Bonneville, Executive, Grand Prix Hardtop & Convertible	2294
W		67-68	Quarter window u-jamb	2DR HTP CNV	67-68 Chevrolet Impala, 67-68 Cadillac Calais, Deville, 67 Oldsmobile 98, 67-68 Buick, LeSabre, Wildcat, Electra, 67-68 Pontiac Bonneville, Catalina 2 Door Hardtop	2292
W		69-70	Qtr window u jamb	CNV 2DR HTP	69-70 Chevrolet Impala, 69-70 Cadillac, Eldorado, 69-70 Oldsmobile 88 Oldsmobile 98, 69-70 Buick LeSabre, Wildcat, 69 Pontiac Catalina, Executive, Bonneville Convertible 2 Door Hardtop	2293
W		69-70	Window weatherstrip, original style with round bead	CNV	69-70 Cadillac Deville, Convertible	2360
W		69-70	Window weatherstrip, original style with round bead	2DR HTP	69-70 Cadillac Deville, 2 Door Hardtop	2367

Cadillac • All Models

CODE	IMAGE	YEAR	DESCRIPTION	BODY	FITS	ITEM#
W		71-72-73	Qtr window u jamb	2DR HTP CNV	71-73 Buick LeSabre, Electra, Riviera, Chevrolet Impala, Caprice, Cadillac Calais, Deville, Oldsmobile 88 Oldsmobile 98, Pontiac Catalina, Bonneville, Grandville 2 Door Hardtop Convertible	2600
W		71-72-73-74-75-76	Quarter window seals	2DR HTP CNV	71-75 Chevrolet Impala, Caprice, 71-76 Cadillac Eldorado Convertible Only, 71-76 Oldsmobile 88, 76 Oldsmobile 98, 71-73 Buick LeSabre, 71-73 Centurion, 71-75 Pontiac Catalina, Bonneville, Grandville 2 Door Hardtop Convertible	2308
W		71-72-73-74-75-76	Quarter window seals	4DR HTP	71-75 Chevrolet Impala, Caprice, Cadillac Calais, Deville, Pontiac Catalina, Bonneville, Grandville Buick Lesabre, Electra, Oldsmobile 88, 98, 4 Door Hardtop	2309
W		74-75-76	Quarter window u-jamb	2DR HTP CNV	Impala Caprice LeSabre Electra Eldorado Oldsmobile Delta 88 Oldsmobile 98, Tornado Delta Bonneville Catalina Grandville Catalina	2295
W		77-78-79-80-81-82-83-84-85-86-87-88-89-90	Window weatherstrip outers only, rwd with chrome bead	2DR SDN	77-90 Chevrolet Impala, Caprice, Buick LeSabre, Electra, Oldsmobile 88 Oldsmobile 98, Pontiac Catalina, Bonneville, Cadillac Deville, 2 Door Sedan	2369
W		77-78-79-80-81-82-83-84-85-86-87-88-89-90	Window weatherstrip, outers only, rwd, with o chrome bead	2DR SDN	77-90 Chevrolet Impala, Caprice, Buick LeSabre, Electra, Oldsmobile 88 Oldsmobile 98, Pontiac Catalina, Bonneville, Cadillac Deville, 2 Door Sedan	23691
Z		61	Weatherstrip kit includes trunk weatherstrip, door weatherstrip, roofrail weatherstrip	2DR HTP	61 Chevrolet Impala, Buick, Cadillac, Oldsmobile, Pontiac 2 Door Hardtop	KIT209X
Z		63-64	Weatherstrip kit, includes trunk weatherstrip, door weatherstrip, roofrail weatherstrip	2DR HTP	63-64 Chevrolet Impala, Buick, Cadillac, Oldsmobile, Pontiac, 2 Door Hardtop	KIT217X
Z		65-66	Weatherstrip kit, includes trunk weatherstrip, door weatherstrip, roofrail weatherstrip	2DR HTP	65-66 Chevrolet Impala, Buick, Cadillac, Oldsmobile, Pontiac, 2 Door Hardtop	KIT213X

















GUIDE TO SOFFSEAL'S PRODUCT CODES

B = Bumper sets **C** = Glass channels **D** = Door related **G** = Seals, gaskets **H** = Under hood items **I** = Interior parts
M = Miscellaneous items **R** = Roofrail, pillar post & convertible items **T** = Trunk related **W** = Window related **Z** = Weatherstrip kits



CODE	IMAGE	YEAR	DESCRIPTION	BODY	FITS	ITEM#
B		39-40-41-42-43-44-45-46-47-48-49-50-51-52-53-54-57-64-65-66-67-68-69-70-71-72	Brake clutch pedal bumpers	2DR 4DR HTP 2DR SDN CNV SWG	39-54 And 57 Chevrolet, 55-57 Pontiac, 64-72 Chevrolet	1058
B		41-42-43-44-45-46-47-48-49-50-51-52-53-54-55-56-57	Firewall/cowl bumper, 41-48 top of firewall, 41-54 side cowl	ALL BODY STYLES	41-57 Chevrolet	0457
B		47-48-49-50-51-52-53-54-55-56-57-58-59-60-61-62-63-64-65-66-67-68-69-70-71-72-73-74-75-76-77-78-79-80-81-82-83-84-85-86-87	Glove box door bumpers	2DR 4DR HTP 2DR SDN CNV SWG TRK	All Chevrolet, Pontiac, Oldsmobile, Buick 47-87 Chevrolet, Gmc Truck	1069
B		49-50-51-52-53-54-55	Gas door bumpers	2DR 4DR HTP 2DR SDN SWG CNV	49-55 Chevrolet 150 210 Bel Air, Nomad, Pontiac, Oldsmobile	1071
B		49-50-51-52-53-54-55-56-57	Door bumpers screw in upper	2DR SDN SWG	49-57 Chevrolet 150 210 Bel Air Styleline Fleetline, Pontiac Sedan, Plus Universal Applications	1054
B		51-52-53-54-55-56-57-58	Upper vent window bumpers	2DR 4DR HTP 2DR SDN CNV SWG	51-58 Chevrolet 150 210 Bel Air Nomad Del Ray Biscayne Impala, 51-54 Chevrolet, Pontiac, Oldsmobile, Buick, Cadillac, Hardtop Convertible	1224
B		55	Hood adjustment bumpers front & rear	2DR 4DR HTP 2DR SDN CNV SWG	55 Chevrolet 150 210 Bel Air Nomad, Pontiac	1072
B		55	Hood to fender bumpers 6 piece	2DR 4DR HTP 2DR SDN CNV SWG	55 Chevrolet 150 210 Bel Air Nomad	1073
B		55-56	Brake clutch pedal bumper	2DR 4DR HTP 2DR SDN CNV SWG	55-56 Chevrolet 150 210 Bel Air, Pontiac, Olds	1057
B		55-56	Seat back rest bumper	2DR 4DR HTP 2DR SDN CNV SWG	55-56 Chevrolet 150 210 Bel Air Nomad, Pontiac, Safari	1059
B		55-56-57	Body bumper kit	2DR HTP CNV	55-57 Chevrolet 210 Bel Air, 2 Door Hardtop Convertible	1055
B		55-56-57	Body bumper kit	2DR SDN	55-57 Chevrolet 150 210 Bel Air, Pontiac, 2 Door, Sedan	1056
B		55-56-57	Door bumpers	4DR SWG	55-57 Chevrolet 150 210 Bel Air, Pontiac, Oldsmobile, All Station Wagons, 4 Door Sedan Station Wagon	10541
B		55-56-57	Door upper bumpers push in	2DR 4DR SDN	55-57 Chevrolet 150 210 Bel Air, Pontiac, Oldsmobile, Sedan	10542

Chevrolet • Bel Air

CODE	IMAGE	YEAR	DESCRIPTION	BODY	FITS	ITEM#
B		55-56-57	Trunk bumpers	2DR 4DR HTP 2DR SDN CNV	55-57 Chevrolet 150 210 Bel Air, Pontiac	1052
B		55-56-57	Quarter window bumpers	CNV	55-57 Chevrolet Bel Air, Convertible	1221
B		55-56-57	Tailgate liftgate bumpers	SWG	55-57 Chevrolet 150 210 Bel Air, Pontiac, Station Wagon	1227
B		55-56-57	Clutch pedal rebound bumper	2DR SDN 2DR 4DR HTP CNV SWG	55-57 Chevrolet, Pontiac	1096
B		55-56-57-58	Door bumpers	2DR 4DR HTP 2DR SDN CNV SWG	55-58 Chevrolet, Pontiac, Olds	1053
B		55-56-57-58-59	Upper trunk or rear license plate bumper	2DR 4DR HTP 2DR SDN CNV SWG	55-59 Chevrolet 150 210 Bel Air Nomad, Pontiac, Olds	10521
B		56-57	Door bumpers	4DR HTP	56-57 Chevrolet 210 Bel Air, Pontiac, Oldsmobile, 4 Door Hardtop	10543
B		56-57	Hood to fender bumpers	2DR 4DR HTP 2DR SDN CNV SWG	56-57 Chevrolet 150 210 Bel Air Nomad	1223
B		56-57-58-59-60- 61-62-63-64-65- 66-67-68-69-70- 71-72-73-74	Hood adjustment bumpers round	2DR 4DR HTP 2DR SDN CNV SWG	56-74 Chevrolet, Pontiac, All Models	1222
B		57	Seat back rest bumpers	2DR 4DR HTP 2DR SDN CNV SWG	57 Chevrolet 150 210 Bel Air Nomad, Pontiac, Safari, Oldsmobile	1061
B		58-59	Gas door bumper	2DR 4DR HTP 2DR SDN CNV SWG	58-59 Chevrolet Del Ray, Biscayne, Bel Air, Impala	2074
B		59	Hood panel grille bumpers	2DR 4DR HTP SDN CNV SWG	59 Chevrolet Biscayne, Bel Air, Impala	20721
B		59-60	Vent window bumpers upper	2DR HTP	59-60 Chevrolet Bel Air, Impala Pontiac Catalina, Star chief Oldsmobile Dynamic 88, Super 88, 98, Cadillac Deville, Eldorado, Series 62, Buick Lesabre, Invicta, Electra Full Size 2 Door Hardtop	2202
B		59-60-61	Hood side bumpers	2DR 4DR HTP 2DR SDN CNV SWG	59-61 Chevrolet Biscayne, Bel Air, Impala	2072
B		61-62	Upper vent window bumper	2DR HTP	61-62 Chevrolet Bel Air, Impala, Pontiac Catalina, Bonneville, Ventura, Cadillac, Buick, Oldsmobile, 2 Door 4 Door Hardtop	2087

















GUIDE TO SOFFSEAL'S PRODUCT CODES

B = Bumper sets **C** = Glass channels **D** = Door related **G** = Seals, gaskets **H** = Under hood items **I** = Interior parts
M = Miscellaneous items **R** = Roofrail, pillar post & convertible items **T** = Trunk related **W** = Window related **Z** = Weatherstrip kits



CODE	IMAGE	YEAR	DESCRIPTION	BODY	FITS	ITEM#
B		61-62	Upper vent window bumper	CNV	61-62 Chevrolet Impala, Bel Air, Pontiac Catalina, Bonneville, Oldsmobile 88, 98, Buick LeSabre, Electra 225, Cadillac Deville Convertible	2088
B		62	Bumper kit	2DR HTP CNV 2DR SDN	62 Chevrolet Biscayne, Bel Air, Impala, 2 Door Hardtop Convertible Sedan	2316
B		62	Hood side bumper	2DR 4DR HTP 2DR SDN CNV SWG	62 Chevrolet Biscayne, Impala, Bel Air	21812
B		62-63-64	Gas door bumpers	2DR 4DR HTP 2DR SDN CNV SWG	62-64 Chevrolet Biscayne, Bel Air, Impala, Cadillac, Oldsmobile, Buick, Pontiac	2143
B		63-64	Bumper kit	2DR HTP CNV 2DR SDN	63-64 Chevrolet Biscayne, Bel Air, Impala	2317
B		63-64	Hood side bumpers	2DR 4DR HTP 2DR SDN CNV SWG	63-64 Chevrolet Biscayne, Impala, Bel Air, 64 Chevelle	2181
B		65	Hood side bumpers	2DR 4DR HTP 2DR SDN CNV SWG	65 Chevrolet Biscayne, Impala, Bel Air, Caprice, Chevelle, Malibu, 65 Cadillac, 65 Oldsmobile, 65 Buick, 65 Pontiac	2182
B		65	Bumper kit, includes: door hood trunk glove box	2DR HTP 2DR SDN	65 Chevrolet Biscayne, Bel Air, Impala, 2 Door Hardtop Sedan	2370
B		66-67-68-69-70-71-72	Bumper kit, includes: door hood trunk glove box	2DR 4DR HTP 2DR SDN CNV SWG	66 Chevrolet Biscayne, Bel Air, Impala, Caprice, 68-69 Chevelle, 70-71 Chevelle, Monte Carlo, 72 Chevelle, 66-72 Cadillac, 66-72 Oldsmobile, 66-72 Buick, 66-72 Pontiac	2371
B		66-67-68-69-70-71-72	Hood side bumpers	2DR 4DR SDN HTP CNV	66-72 Chevrolet Biscayne, Bel Air, Impala, Caprice, 73-75 Nova, 66-72 Cadillac, 66-72 Oldsmobile, 66-72 Buick, 66-72 Pontiac	2179
B		67-68-69-70	Door bumpers	2DR 4DR HTP 2DR SDN CNV SWG	67-70 Chevrolet Biscayne, Bel Air, Impala Caprice, 67-70 Cadillac Calais, Deville, Fleetwood, 67-70 Oldsmobile 88, 98, 67-70 Buick LeSabre, Wildcat, Electra, 67-70 Pontiac	2323
B		67-68-69-70	Bumper kit, includes: door hood trunk glove box	2DR HTP 2DR SDN	67-70 Chevrolet Biscayne, Bel Air, Impala, Caprice, 2 Door Hardtop Sedan	2372
C		49-50-51-52	Windshield channel with chrome	2DR HTP CNV	49-52 Chevrolet Bel Air Hardtop Convertible	0520
C		50-51-52	Rear glass channel, with chrome	2DR HTP	50-52 Oldsmobile, Pontiac, Chevrolet Bel Air Hardtop	0530
C		53-54	Rear glass channel	2DR HTP	53-54 Old, Pontiac, Chevrolet Bel Air Hardtop	0532

Chevrolet • Bel Air

CODE	IMAGE	YEAR	DESCRIPTION	BODY	FITS	ITEM#
C		53-54	Windshield channel	2DR SDN	53-54 Chevrolet Bel Air 210 Oldsmobile, Pontiac, Sedan	0522
C		53-54	Windshield channel	2DR HTP CNV	53-54 Chevrolet Bel Air, Oldsmobile, Buick, Pontiac, Hardtop Convertible	0524
C		55	Rear glass channel	2DR 4DR SDN	55 Chevrolet 210 Bel Air, Pontiac 2 Door 4 Door Sedan	1203
C		55-56-57	Glass channel rear side window curved 4 door station wagon	SWG 4DR	55-57 Chevrolet, Pontiac, 4 Door Station Wagon	1120
C		55-56-57	Glass channel rear side window curved	2DR SWG	55-57 Chevrolet, Pontiac, Except Nomad And Safari, 2 Door Station Wagon	1121
C		55-56-57	Front glass channel	2DR 4DR HTP 2DR SDN CNV SWG	55-57 Chevrolet, Pontiac Safari, Except 55, 150 Convertible	1201
C		55-56-57	Front glass channel	CNV	55-57 Chevrolet Bel Air, Pontiac, Convertible	1201B
C		55-56-57	Glass channel rear	2DR HTP	55-57 Chevrolet 210 Bel Air, Pontiac, Hardtop	1202
C		56-57	Glass channel rear	4DR HTP	56-57 Chevrolet 210 Bel Air, Pontiac, 4 Door Hardtop	1202A
C		56-57	Rear glass channel	2DR 4DR SDN	56-57 Chevrolet 210 Bel Air, Pontiac, 2 Door 4 Door Sedan	1203A
C		59-60	Glass channel	2DR 4DR HTP CNV	59-60 Chevrolet Bel Air, Impala, Cadillac Series 62, Deville, Eldorado, Oldsmobile 88 Oldsmobile 98, Buick LeSabre, Invicta, Electra, Pontiac Catalina, Star Chief, Bonneville 2 Door 4 Door Hardtop Convertible	2080
C		61	Glass channel rear	2DR HTP	61 Chevrolet, Pontiac, Oldsmobile, Buick, 62 Chevrolet Bubble Top, Bel Air, 2 Door Hardtop	2163
C		61-62	Glass channel front	2DR HTP	61 Chevrolet Impala, 62 Chevrolet Bel Air, 61 Cadillac Series 62, 62 Cadillac Deville 4 Door S, 61-62 Oldsmobile 88 Oldsmobile 98, 61 Buick LeSabre, Invicta, Electra, 62 Buick, 61-62 Pontiac Catalina, Ventura, Star Chief, Bonneville 2 Door Hardtop	2161
C		61-62	Glass channel front	CNV HT	62 Chevrolet, Pontiac, Oldsmobile, Buick, Cadillac Formal Roof Hardtop, 61-62 Convertible, 61 Pontiac, Oldsmobile, Buick, Cadillac Formal Roof Hardtop	2162
C		61-62	Front glass channel	2DR SDN SWG 4DR	61-62 Chevrolet, Pontiac, 2 Door 4 Door Sedan And Station Wagon	21621











GUIDE TO SOFFSEAL'S PRODUCT CODES

B = Bumper sets **C** = Glass channels **D** = Door related **G** = Seals, gaskets **H** = Under hood items **I** = Interior parts
M = Miscellaneous items **R** = Roofrail, pillar post & convertible items **T** = Trunk related **W** = Window related **Z** = Weatherstrip kits



CODE	IMAGE	YEAR	DESCRIPTION	BODY	FITS	ITEM#
C		62-63-64	Glass channel rear	2DR 4DR SDN	62-63 Chevrolet Biscayne, Bel Air, Impala, 62-64 Cadillac, 62-64 Oldsmobile 88, 62-64 Buick LeSabre, 64 Wildcat, 62-64 Pontiac Catalina, Star Chief 2 Door 4 Door Sedan	2189
C		63-64	Glass channel rear side stationary window	4DR SWG	61-64 Chevrolet, Buick, Oldsmobile, Pontiac 4 Door Station Wagon, All	2123
C		63-64	Windshield gasket	2DR SDN SWG	63-64 Chevrolet Biscayne, Bel Air, Impala, 63-64 Cadillac Series 62, Deville, 63-64 Oldsmobile 88 Oldsmobile 98, 63-64 Buick LeSabre, Wildcat, Electra, 63-64 Pontiac, 2 Door Sedan Station Wagon	2020
D		55-56-57	Lower gate weatherstrip with clips & molded corner	SWG	55-57 Chevrolet 150 210 Bel Air, Pontiac Station Wagon	1226
D		55-56-57	Upper gate weatherstrip with clips & molded ends	SWG	55-57 Chevrolet 150 210 Bel Air, Pontiac, Station Wagon	1228
D		55-56-57	Door j weatherstrip with clips	2DR 4DR HTP 2DR SDN CNV SWG	55-57 Chevrolet, Pontiac, All Models	1204
D		55-56-57	Door weatherstrip with clips & molded ends	2DR HTP CNV	55-57 Chevrolet, Pontiac, 2 Door Hardtop Convertible	1000
D		55-56-57	Door weatherstrip with clips with out molded ends	2DR HTP CNV	55-57 Chevrolet, Pontiac, 2 Door Hardtop Convertible	1001
D		55-56-57-58-59-60	Door weatherstrip with clips sedan front and rear	2DR 4DR SDN SWG	55-60 Chevrolet Bel Air 150 210, Nomad, Pontiac Chieftain, Star Chief, Safari, Super Chief, Bonneville, Buick Century, Roadmaster, Special Also Station Wagon And Sedan Delivery	1003
D		55-56-57-58-59-60	Door weatherstrip rear with clips	SWG	55-57 Chevrolet Bel Air 150 210 55-56 Pontiac Chieftain 860 870, Star Chief, 58-60 Chevrolet Sedan Delivery	1230
D		56-57	Rear door weatherstrip with clips & molded ends	4DR HTP	56-57 Chevrolet 210 Bel Air, Pontiac, 4 Door Hardtop	1004
D		56-57	Front door weatherstrip with clips & molded ends	4DR HTP	56-57 Chevrolet 210 Bel Air, Pontiac, 4 Door Hardtop	1005
D		58	Door weatherstrip with molded corner	2DR SDN	58 Chevrolet Bel Air, Del Ray, Pontiac Chieftain, Catalina, 2 Door Sedan	2004
D		58	Door j weatherstrip	2DR 4DR HTP 2DR SDN CNV SWG	58 Chevrolet Del Ray, Biscayne, Bel Air, Impala, 58 Cadillac, 57-58 Oldsmobile 88 Oldsmobile 98, 57-58 Buick Special Century, Super, Roadmaster, 58 Pontiac	2044
D		59-60	Door j weatherstrip	2DR 4DR HTP SWG 2DR SDN 4DR SDN	59-60 Chevrolet, Pontiac, Oldsmobile, Buick, Cadillac	2093

Chevrolet • Bel Air

CODE	IMAGE	YEAR	DESCRIPTION	BODY	FITS	ITEM#
D		59-60	Door weatherstrip front with clips & molded ends	4DR HTP	59-60 Chevrolet Impala, Bel Air, Buick Lesabre, Invicta, Oldsmobile 88, Pontiac Catalina, Star Chief, Bonneville 4 Door Hardtop	2205
D		59-60	Door weatherstrip rear door with clips & molded ends	4DR HTP	59-60 Chevrolet Impala, Bel Air, Buick Electra, Invicta, LeSabre, Cadillac 62 Deville, Eldorado, Oldsmobile 98 Oldsmobile 99, 4 Door Hardtop	2206
D		59-60	Door weatherstrip with clips & molded ends	2DR HTP CNV	59-60 Chevrolet Impala, Bel Air, Pontiac Catalina, Star Chief, Bonneville, Oldsmobile 88, 98, Buick LeSabre, Invicta, Electra, Cadillac Deville, Eldorado, Series 62 Hardtop Convertible	2011
D		61-62	Door weatherstrip with clips & molded ends	2DR HTP CNV	61-62 Chevrolet Bel Air Impala, Cad Series 62, Deville, 61-62 Oldsmobile, 61 Hardtop Convertible 88 Star Fire, Oldsmobile 98/62 Oldsmobile 88 Oldsmobile 98 Starfire, 61-62 Buick 61 Hardtop Convertible, 62 Convertible Only LeSabre Invicta Electra, 61-62 Pontiac, 2 Door Hardtop Convertible	2013
D		61-62	Door weatherstrip front with clips	SWG 4 DR SDN	61-62 Chevrolet BelAir, Biscayne, Impala, Pontiac, Station Wagon & 4 Dr Sedan	2019
D		61-62	Door weatherstrip, front doors	4DR HTP	61-62 Chevrolet Impala, Bel Air, Buick Electra, LeSabre, Invicta, Cadillac Series 60, Oldsmobile 88 Oldsmobile 98, 4 Door Hardtop	2207
D		61-62-63-64	Door weatherstrip rear with clips	4dr SWG	61-64 Chevrolet Biscayne, Bel Air, Impala, 61-64 Oldsmobile 88, 61-64 Buick LeSabre, 62-63 Invicta 63-64 Wildcat, 61-64 Pontiac Catalina, Bonneville, 4 Door Station Wagon	2018
D		61-62-63-64	Door weatherstrip with clips	2DR SDN	61-64 Chevrolet, Pontiac, Buick, Oldsmobile, 2 Door Sedan	2005
D		61-62-63-64	Door weatherstrip rear door with clips	4DR SDN	61-64 Chevrolet Biscayne Bel Air Impala, 61-64 Oldsmobile 88, 98, 61-62 Cadillac, 61-64 Buick LeSabre Electra, 64 Wildcat, 61-64 Pontiac Catalina, Star Chief, 4 Door Sedan	2009
D		63-64	Door weatherstrip front with clips	4DR SDN SWG	63-64 Chevrolet Biscayne, Bel Air, Impala, 63-64 Cadillac, 63-64 Oldsmobile 88, 63-64 Buick LeSabre, Wildcat, 63-64 Pontiac, 4 Door Sedan Station Wagon	2017
D		63-64	Front door weatherstrip with molded ends	4DR HTP	63-64 Chevrolet Biscayne, Bel Air, Impala, Buick Wildcat, Lesabre, Electra, Pontiac Catalina, Star Chief, Bonneville, Oldsmobile Dynamic 88, 98 4 Door Ht	2121
D		65-66	Door weatherstrip with clips	2DR SDN	65-66 Chevrolet Biscayne, Bel Air, 65-66 Cadillac, 65-66 Oldsmobile, 65-66 Buick, 65-66 Pontiac, 2 Door Sedan	2332















GUIDE TO SOFFSEAL'S PRODUCT CODES

B = Bumper sets **C** = Glass channels **D** = Door related **G** = Seals, gaskets **H** = Under hood items **I** = Interior parts
M = Miscellaneous items **R** = Roofrail, pillar post & convertible items **T** = Trunk related **W** = Window related **Z** = Weatherstrip kits



CODE	IMAGE	YEAR	DESCRIPTION	BODY	FITS	ITEM#
D		65-66	Door weatherstrip front with clips	4DR SDN SWG	65-66 Chevrolet Biscayne Bel Air Impala, 65-66 Cadillac Calais Deville Fleetwood, 65-66 Oldsmobile 88, 65-66 Buick LeSabre Wildcat, 65-66 Pontiac Bonneville, Catalina, Star chief, 4 Door Sedan Swg	2006
D		65-66	Rear door weatherstrip with clips	4DR SDN	65-66 Chevrolet Biscayne Bel Air Impala 65-66 Cadillac Calais Deville Fleetwood 65-66 Oldsmobile 88, 65-66 Buick LeSabre Wildcat, 65-66 Pontiac Catalina, Star Chief, 4 Door Sedan	2007
D		65-66	Door weatherstrip rear station wagon with clips	4DR SWG	65-66 Chevrolet Biscayne, Bel Air, Impala, 65-66 Oldsmobile, 65-66 Buick, 65-66 Pontiac	2008
D		67-68	Front door weatherstrip with clips	4DR SDN SWG	67-68 Chevrolet Biscayne, Bel Air, Impala, 67-68 Cadillac Calais, Deville, Fleetwood, 67-68 Oldsmobile Delmont 88, Delta 88, 98, 67-68 Buick LeSabre, Wildcat, Electra 67-68 Pontiac Catalina, Executive, Bonneville, 4 Door Sedan Station Wagon	23321
D		67-68	Door weatherstrip rear with clips	4DR SDN	67-68 Chevrolet Biscayne, Bel Air, Impala, 67-68 Cadillac Calais, Deville, Fleetwood, 67-68 Oldsmobile 88, 67-68 Buick LeSabre, Wildcat, 67-68 Pontiac Bonneville Station Wagon, 67-68 Pontiac Executive, Catalina, 4 Door Sedan	23322
D		67-68	Door weatherstrip with clips	2DR SDN	67-68 Chevrolet Biscayne, Bel Air, 67-68 Cadillac, 67-68 Oldsmobile, 67-68 Buick, 67-68 Pontiac, 2 Door Sedan	2329
D		69-70	Door weatherstrip front doors with clips	4DR SDN SWG	69-70 Chevrolet Biscayne, Bel Air, Impala, Cadillac, Buick La Sabre, Wildcat, Pontiac, 4 Door Sedan Station Wagon	2510
D		69-70	Rear door weatherstrip	SWG 4DR	69-70 Chevy Biscayne, Bel Air, Impala, Caprice, Estate, Oldsmobile Vista Cruiser, Pontiac Catalina, Bonneville, Executive, Gm Fullsize Station Wagon 4 Door	2519
D		71-72-73-74	Door weatherstrip rear with clips & molded ends	4DR SDN	71-74 Chevrolet Impala, Bel Air, Biscayne, Brookwood, Townsman, Kingswood, Buick Estate Station Wagon, Pontiac Catalina, Grand Safari, Bonneville, Oldsmobile Custom Cruiser, 4 Door Sedan	2225
D		71-72-73-74-75-76	Door weatherstrip rear with clips & molded ends	SWG 4DR	71-76 Chevrolet Bel Air, Caprice, Impala, Brookwood, Townsman, Kingswood, Oldsmobile Custom Cruiser, Pontiac Grand Safari, Buick Estate Wagon, 4 Door Station Wagon	2227
D		71-72-73-74-75-76	Door weatherstrip front with clips & molded ends	4DR SWG	71-76 Chevrolet Impala, Bel Air, Biscayne, Brookwood, Townsman, Kingswood, Buick Estate Station Wagon, Pontiac Catalina, Grand Safari, Bonneville, Oldsmobile Custom Cruiser, 4 Door Station Wagon	2228

Chevrolet • Bel Air

CODE	IMAGE	YEAR	DESCRIPTION	BODY	FITS	ITEM#
D		75-76	Door weatherstrip rear with clips & molded ends	4DR SDN	75-76 Chevrolet Impala, Bel Air, Brookwood, Townsman, Kingwood, Buick Estate Station Wagon, Pontiac Catalina, Grand Safari, Bonneville, Oldsmobile Custom Cruiser, 4 Door Sedan	2226
G		38-39-40-41-42-43-44-45-46-47-48-49-50-51-52-53-54-55-56-57-58-59-60-61-62-63-64-65-66	Gas tank sending unit gasket	2DR 4DR HTP 2DR SDN CNV SWG	38-60 Chevrolet, Pontiac, Oldsmobile, 47-66 Chevrolet Gmc Truck	10522
G		49-50-51-52-53-54-55-56	Door jam switch gasket	2DR 4DR HTP 2DR SDN CNV SWG	49-56 Chevrolet 150 210 Bel Air Nomad, Pontiac Safari, Oldsmobile	1060
G		53-54-55-56-57	Windshield wiper drive seals	2DR 4DR HTP 2DR SDN SWG CNV	53-57 Chevrolet All	1036
G		55	Anti-squeak fender kit	2DR 4DR HTP 2DR SDN CNV SWG	55 Chevrolet 150 210 Bel Air Nomad	1074
G		55	Rear body to bumper seal	2DR SDN 2DR 4DR HTP CNV SWG	55 Chevrolet 150, 210 Bel Air, Nomad	1070
G		55	Lens gasket kit parklight, taillight/backup light, gaskets	2DR 4DR HTP 2DR SDN CNV SWG	55 Chevrolet 150 210 Bel Air	1112
G		55-56	Anti-squeak hood kit	2DR 4DR HTP 2DR SDN CNV SWG	55-56 Chevrolet 150 210 Bel Air Nomad	1093
G		55-56	Steering column seal auto inner	2DR 4DR HTP 2DR SDN CNV SWG	55-56 Chevrolet 150 210 Nomad Bel Air, Pontiac	1214
G		55-56	Steering column seal standard inner	2DR 4DR HTP 2DR SDN CNV SWG	55-56 Chevrolet 150 210 Nomad Bel Air, Pontiac	1215
G		55-56	Deluxe heater seal kit	2DR 4DR HTP 2DR SDN CNV SWG	55-56 Chevrolet 150 210 Bel Air Nomad	1083
G		55-56-57	Gas tank o ring	2DR 4DR HTP 2DR SDN CNV SWG	55-57 Chevrolet 150 210 Bel Air Nomad	10523
G		55-56-57	Door handle & lock gasket set	2DR 4DR HTP 2DR SDN CNV SWG	55-57 Chevrolet, Pontiac, 2 Door	1019



GUIDE TO SOFFSEAL'S PRODUCT CODES

B = Bumper sets **C** = Glass channels **D** = Door related **G** = Seals, gaskets **H** = Under hood items **I** = Interior parts
M = Miscellaneous items **R** = Roofrail, pillar post & convertible items **T** = Trunk related **W** = Window related **Z** = Weatherstrip kits



CODE	IMAGE	YEAR	DESCRIPTION	BODY	FITS	ITEM#
G		55-56-57	Paint gasket kit	2DR HTP 2DR SDN CNV SWG	55-57 Chevrolet 2 Door	1020
G		55-56-57	Paint gasket kit	4DR HTP SWG	55-57 Chevrolet 4 Door	1021
G		55-56-57	Door handle gaskets	2DR 4DR HTP 2DR SDN CNV SWG	55-57 Chevrolet, Pontiac	1022
G		55-56-57	Lock cylinder gasket	2DR 4DR HTP 2DR SDN CNV SWG	55-57 Chevrolet, Pontiac	1023
G		55-56-57	Antenna base gasket	2DR 4DR HTP 2DR SDN SWG CNV	55-57 Chevrolet, Pontiac	1024
G		55-56-57	Mirror gasket	2DR 4DR HTP 2DR SDN SWG CNV	55-57 Chevrolet, Pontiac	1025
G		55-56-57	Steering column seal auto sponge	2DR 4DR HTP 2DR SDN CNV SWG	55-57 Chevrolet 150 210 Nomad Bel Air, Pontiac	1213
G		55-56-57	Rear wheel housing seal all	ALL BODY STYLES	55-57 Chevrolet, Pontiac	1220A
G		55-56-57	Chevy Steering Column Firewall Seal, Standard Transmission	2DR 4DR HTP 2DR SDN CNV SWG	55-57 Chevrolet 150 210 Nomad Bel Air, Pontiac	1216
G		55-56-57-58-59-60-61-62-63-64	Fender skirt rubber	2DR 4DR HTP 2DR SDN CNV SWG	55-64 Chevrolet Impala, 150 210 Bel Air, Pontiac Chiefton, Superchief, Starchief	1075
G		56	Taillight, lower seal fits between inner body bezel	2DR 4DR HTP 2DR SDN CNV SWG	56 Chevrolet 150 210 Bel Air Nomad	1085
G		56	Anti-squeak fender kit	2DR 4DR HTP 2DR SDN CNV SWG	56 Chevrolet 150 210 Bel Air Nomad	1092
G		56	Lens gasket kit parklight, taillight, & backup light, gaskets	2DR 4DR HTP 2DR SDN CNV SWG	56 Chevrolet 150 210 Bel Air	1113
G		56-57	56 taillight, door seals, 57 headlight, bezel seals	2DR 4DR HTP 2DR SDN CNV SWG	56-57 Chevrolet 150 210 Bel Air Nomad	1091
G		56-58	Rear body to bumper seal	2DR 4DR HTP 2DR SDN CNV SWG	56, 58 Chevrolet	1090

Chevrolet • Bel Air

CODE	IMAGE	YEAR	DESCRIPTION	BODY	FITS	ITEM#
G		57	Lens gasket kit parklight, taillight, & backup light, gaskets	2DR 4DR HTP 2DR SDN CNV SWG	57 Chevrolet 150 210 Bel Air	1114
G		57	Air inlet hose	2DR 4DR HTP 2DR SDN CNV SWG	57 Chevrolet 150 210 Bel Air	1115
G		57	Splash pan seals	2DR 4DR HTP 2DR SDN CNV SWG	57 Chevrolet 150 210 Bel Air	1104
G		57	Anti-squeak hood kit	2DR 4DR HTP 2DR SDN CNV SWG	57 Chevrolet 150 210 Bel Air	1105
G		57	Anti-squeak fender kit	2DR 4DR HTP 2DR SDN CNV SWG	57 Chevrolet 150 210 Bel Air	1106
G		57	Fresh air duct seals	2DR 4DR HTP 2DR SDN CNV SWG	57 Chevrolet 150 210 Bel Air	1107
G		57	Deluxe heater seals	2DR 4DR HTP 2DR SDN CNV SWG	57 Chevrolet 150 210 Bel Air	1108
G		57	Under taillight, seals	2DR 4DR HTP 2DR SDN CNV SWG	57 Chevrolet 150 210 Bel Air	1109
G		57	Tail lamp to body seals	2DR 4DR HTP 2DR SDN CNV SWG	57 Chevrolet 150 210 Bel Air	1110
G		57	Rear bumper to body seal	2DR 4DR HTP 2DR SDN CNV SWG	57 Chevrolet 150 210 Bel Air	1100
G		57	Steering column seal auto inner	2DR 4DR HTP 2DR SDN CNV SWG	57 Chevrolet 150 210 Nomad Bel Air, Pontiac	1214A
G		57	Steering column seal standard inner	2DR 4DR HTP 2DR SDN CNV SWG	57 Chevrolet 150 210 Nomad Bel Air, Pontiac	1215A
G		57	License lens gasket	2DR 4DR HTP 2DR SDN CNV SWG	57 Chevrolet 150 210 Bel Air Nomad	1237
G		57-58-59-60	Inner to outer fender seals	2DR 4DR HTP 2DR SDN CNV SWG	57-60 Chevrolet	1103











GUIDE TO SOFFSEAL'S PRODUCT CODES

B = Bumper sets **C** = Glass channels **D** = Door related **G** = Seals, gaskets **H** = Under hood items **I** = Interior parts
M = Miscellaneous items **R** = Roofrail, pillar post & convertible items **T** = Trunk related **W** = Window related **Z** = Weatherstrip kits



CODE	IMAGE	YEAR	DESCRIPTION	BODY	FITS	ITEM#
G		58	Heater plenum to firewall gasket	2DR 4DR HTP 2DR SDN CNV SWG	58 Chevrolet Del Ray Biscayne Impala Bel Air	2037
G		58	Heater box seal kit non a/c 2 piece	2DR 4DR HTP 2DR SDN CNV SWG	58 Chevrolet Del Ray Biscayne Impala Bel Air	20371
G		58	A-arm seals w/o clips	2DR 4DR HTP 2DR SDN CNV SWG	58 Chevrolet Del Ray Biscayne Impala Bel Air	2042
G		58	Lens gasket kit	2DR 4DR HTP 2DR SDN CNV SWG	58 Chevrolet Del Ray Biscayne Impala Bel Air	2045
G		58	Antenna base gasket	2DR 4DR HTP 2DR SDN CNV SWG	58 Chevrolet Del Ray Biscayne Impala Bel Air	2046
G		58	Steering column seal with automatic trans	2DR 4DR HTP 2DR SDN CNV SWG	58 Chevrolet Pontiac	2056
G		58	Steering column seal sponge	2DR 4DR HTP 2DR SDN CNV SWG SR	58 Chevrolet Pontiac, Universal Fit Street Rod And Custom, Standard Transmission	2056A
G		58	Anti-squeak fender seals	2DR 4DR HTP 2DR SDN CNV SWG	58 Chevrolet Del Ray Biscayne Impala Bel Air	2057
G		58	Front splash pan seals	2DR 4DR HTP 2DR SDN SWG CNV	58 Chevrolet Del Ray Biscayne Impala Bel Air	2058
G		58	Door handle & lock gaskets	2DR 4DR HTP 2DR SDN SWG CNV	58 Chevrolet Pontiac	2059
G		59	Door handle & lock gaskets	2DR 4DR HTP 2DR SDN CNV SWG	59 Chevrolet Pontiac	2073
G		59	Antenna gasket left or right, rear	2DR SDN 2DR 4DR HTP CNV SWG	59 Chevrolet Biscayne Bel Air Impala	2071
G		59	Lens gasket kit 4 piece parklight, taillight	2DR 4DR HTP 2DR SDN CNV SWG	59 Chevrolet Biscayne Bel Air Impala	2176
G		59	Tail lamp assembly to body seal	2DR 4DR HTP 2DR SDN CNV SWG	59 Chevrolet Biscayne Bel Air Impala	21761

Chevrolet • Bel Air

CODE	IMAGE	YEAR	DESCRIPTION	BODY	FITS	ITEM#
G		59-60	Backup housing gaskets	2DR 4DR HTP 2DR SDN CNV SWG	59 Chevrolet Impala, 59 And 60 Bel Air Station Wagon, El Camino	2075
G		59-60	Steering column floor seal with felt washer & metal retainer standard. transmission	SWG	59-60 Chevrolet Biscayne, Bel Air, Impala, El Camino, Station Wagon	2117
G		59-60	Heater Box Seal Under Hood Deluxe Heater	2 DR 4DR HTP SDN CNV SWG CPE	59-60 Chevy Impala, Bel Air, ElCamino 2 & 4 Dr HTP SDN CNV SWG CPE	2352
G		59-90	Steering column floor seal automatic transmission	SWG	59-60 Chevrolet Biscayne, Bel Air, Impala, El Camino, Station Wagon	2116
G		60	Antenna gasket right, rear	2DR 4DR HTP 2DR SDN CNV SWG	60 Chevrolet Biscayne Bel Air Impala	2084
G		60	Antenna gasket left rear	2DR 4DR HTP 2DR SDN CNV SWG	60 Chevrolet Biscayne Bel Air Impala	2085
G		60	Lens gasket kit 8 piece parklight, taillight, brake & backup	2DR 4DR HTP 2DR SDN CNV SWG	60 Chevrolet Biscayne Bel Air Impala	2177
G		60	Taillight, housing to body seals	2DR 4DR HTP 2DR SDN CNV SWG	60 Chevrolet Impala Biscayne Bel Air	21772
G		60-63-64-69-70	Door handle & lock gaskets	2DR 4DR HTP 2DR SDN CNV SWG	60 Chevrolet Biscayne, Impala, Bel Air, Cadillac, Oldsmobile 89 Oldsmobile 98, Buick LeSabre, Invicta, Electra, Wild Cat, Pontiac Catalina, Star Chief, Bonneville, Grand Prix, Ventura	2098
G		61	Steering column dust cover	2DR 4DR HTP 2DR SDN CNV SWG	61 Chevrolet Biscayne Bel Air Impala	2115
G		61	Lens gasket kit 8 piece parklight, taillight, brake & backup	2DR 4DR HTP 2DR SDN CNV SWG	61 Chevrolet Biscayne Bel Air Impala	2178
G		61	Taillamp housing to body seal	2DR 4DR HTP 2DR SDN CNV SWG	61 Chevrolet Impala Biscayne Bel Air	21781
G		61	Inner taillamp housing seals	2DR 4DR HTP 2DR SDN CNV SWG	61 Impala Bel Air Impala Biscayne	21782
G		61-62	Antenna gasket left rear	2DR SDN 2DR 4DR HTP CNV SWG	61-62 Chevrolet Biscayne, Bel Air, Impala	2125



GUIDE TO SOFFSEAL'S PRODUCT CODES

B = Bumper sets **C** = Glass channels **D** = Door related **G** = Seals, gaskets **H** = Under hood items **I** = Interior parts
M = Miscellaneous items **R** = Roofrail, pillar post & convertible items **T** = Trunk related **W** = Window related **Z** = Weatherstrip kits



CODE	IMAGE	YEAR	DESCRIPTION	BODY	FITS	ITEM#
G		61-62	Heater box kit non a/c 7 piece	2DR 4DR HTP 2DR SDN CNV SWG	61-62 Chevrolet Impala Biscayne Bel Air	2112
G		61-62	Cowl panel to cowl filler gasket	2DR 4DR HTP 2DR SDN CNV SWG	61-62 Chevrolet Biscayne Bel Air Impala	2061
G		61-62-63-64	Steering column outer seal standard shift only	2DR 4DR HTP 2DR SDN CNV SWG	61-64 Chevrolet Biscayne Bel Air Impala	2113
G		61-62-64	Steering column outer seal automatic	2DR 4DR HTP 2DR SDN CNV SWG	61-64 Chevrolet Biscayne Bel Air Impala	2114
G		61-62-65-66-67-68	Door handle & lock gaskets	2DR 4DR HTP 2DR SDN CNV SWG	61-62 Chevrolet Biscayne, Bel Air, Impala, Cadillac, Oldsmobile 88 Oldsmobile 98, Buick LeSabre, Invicta, Electra, Pontiac	2145
G		61-62-63-64	License plate light lens gasket	2DR 4DR HTP 2DR SDN CNV SWG	61-64 Chevrolet Bel Air Biscayne Impala	2307
G		61-62-63-64-65	Outside mirror gasket	2DR 4DR HTP 2DR SDN CNV SWG	61-65 Chevrolet 68-69 Chevelle Malibu El Camino 63-64 Impala Biscayne Bel Air	2306
G		62	Park lens gaskets	2DR 4DR HTP 2DR SDN CNV SWG	62 Chevrolet Biscayne Bel Air Impala	2165
G		62	Taillight gasket	2DR 4DR HTP 2DR SDN CNV SWG	62 Chevrolet Full Size Only	2166
G		62	Lens gasket kit 8 piece parklight, taillight, brake & backup	2DR 4DR HTP 2DR SDN CNV SWG	62 Chevrolet Biscayne Bel Air Impala	2173
G		62	Inner taillamp housing seals	2DR 4DR HTP 2DR SDN CNV SWG	62 Chevrolet Impala Bel Air Impala	21783
G		62	Outer rear bumper seals	2DR 4DR HTP 2DR SDN CNV SWG	62 Chevrolet Biscayne Bel Air Impala	2160
G		62-63	Tail lamp to body seals	2DR 4DR HTP 2DR SDN CNV SWG	62-63 Chevrolet Biscayne Bel Air Impala	2170
G		62-63-64	Steering column dust cover	2DR 4DR HTP 2DR SDN CNV SWG	62-64 Chevrolet Biscayne Bel Air Impala	21151

Chevrolet • Bel Air

CODE	IMAGE	YEAR	DESCRIPTION	BODY	FITS	ITEM#
G		63	Lens gasket kit 8 piece parklight, taillight, brake & backup	2DR 4DR HTP 2DR SDN CNV SWG	63 Chevrolet Biscayne Bel Air Impala	2174
G		63	Park lens gaskets	2DR 4DR HTP 2DR SDN CNV SWG	63 Chevrolet Biscayne Bel Air Impala	2167
G		63	Tail lens gaskets	2DR 4DR HTP 2DR SDN CNV SWG	63 Chevrolet Biscayne Bel Air Impala	21671
G		63	Inner taillamp housing seals	2DR 4DR HTP 2DR SDN CNV SWG	63 Impala Bel Air Biscayne	21784
G		63	Rear body to bumper seal	2DR 4DR HTP 2DR SDN CNV SWG	63 Chevrolet Biscayne Bel Air Impala	2201
G		63-64-65	Heater to firewall gasket under dash non a/c	2DR 4DR SDN HTP CNV	63-65 Chevrolet Impala Bel Air Biscayne	2513
G		64	Rear bumper to body seal	2DR 4DR HTP 2DR SDN CNV SWG	64 Chevrolet Biscayne Bel Air Impala	2197
G		64	Park light lens gaskets	2DR 4DR HTP 2DR SDN CNV SWG	64 Chevrolet Biscayne Bel Air Impala Chevelle El Camino Malibu	2168
G		64	Park lamp housing gaskets	2DR 4DR HTP 2DR SDN CNV SWG	64 Chevrolet Biscayne Bel Air Impala	2169
G		64	Lens gasket kit 8 piece parklight, taillight, brake & backup	2DR 4DR HTP 2DR SDN CNV SWG	64 Chevrolet Biscayne Bel Air Impala	2175
G		64	Tail lens gaskets	2DR 4DR HTP 2DR SDN CNV SWG	64 Chevrolet Biscayne Bel Air Impala	2171
G		64	Taillight, housing to body seal	2DR 4DR HTP 2DR SDN CNV SWG	64 Chevrolet Biscayne Bel Air Impala	21711
G		65-66	Outside mirror gasket without remote	2DR 4DR HTP 2DR SDN CNV SWG	65-66 Chevrolet Bel Air Biscayne Impala	2304
G		65-66	Steering column seal fits all	2DR 4DR HTP 2DR SDN CNV SWG	65-66 Chevrolet Impala Biscayne Caprice Bel Air	2405
G		65-66-67	Cowl vent panel to cowl seals	2DR 4DR SDN HTP CNV	65-67 Chevrolet All	2340



GUIDE TO SOFFSEAL'S PRODUCT CODES

B = Bumper sets **C** = Glass channels **D** = Door related **G** = Seals, gaskets **H** = Under hood items **I** = Interior parts
M = Miscellaneous items **R** = Roofrail, pillar post & convertible items **T** = Trunk related **W** = Window related **Z** = Weatherstrip kits



CODE	IMAGE	YEAR	DESCRIPTION	BODY	FITS	ITEM#
G		65-66-67-68-69-70-71-72-73-74-75-76-77-78-79	Mirror gasket	2DR 4DR HTP 2DR SDN CNV SWG	68-69 Chevrolet 65-66 Bel Air Biscayne Impala 67-79 Chevrolet Camaro 66-72 Nova 66-72 Chevelle 70 El Camino 67-68 Pontiac Firebird	2305
G		66-67-68-69-70-71-72	License light gasket	2DR 4DR HTP SDN CNV SWG	66-72 Chevy II Nova, Biscayne, Bel Air, Impala, Chevelle, 67-72 Chevrolet Camaro, Pontiac Firebird	2378
G		67	Park light lens gaskets	2DR SDN 2DR 4DR HTP CNV SWG	67 Chevrolet Impala Bel Air Caprice Biscayne	2382
G		67	Rear bumper to body seal	2DR SDN 2DR 4DR HTP CNV SWG	67 Chevrolet Biscayne Bel Air Impala Caprice	2346
G		67-68	Steering column seal fits all	2DR 4DR HTP 2DR SDN CNV SWG	67-68 Chevrolet Impala Biscayne Caprice Bel Air	2406
G		68	Taillight lens gaskets 6 piece	2DR SDN 2DR 4DR HTP CNV SWG	68 Chevrolet Impala Caprice Bel Air	2383
G		68	Park lens gaskets	2DR SDN 2DR 4DR HTP CNV SWG	68 Chevrolet Impala Biscayne Bel Air	2384
G		68	Rear side marker light	2DR 4DR HTP SWG CNV	68 Chevrolet All	23841
G		68	Front side marker gaskets	2DR 4DR HTP SWG CNV	68 Chevrolet All	23842
G		68	Rear body to bumper seal	2DR 4DR HTP 2DR SDN CNV SWG	68 Chevrolet Impala Biscayne Caprice Bel Air	2408
G		69-70	Steering column seal	2DR 4DR HTP 2DR SDN CNV SWG	69-70 Chevrolet Impala Biscayne Caprice Bel Air	2402
G		70	Taillight lens gaskets	2DR 4DR HTP CNV	70 Chevrolet Impala	2389
G		70	Park light lens gaskets	2DR 4DR HTP SWG CNV	70 Chevrolet	23891
H		55-56	Hood to cowl seal clips	2DR 4DR HTP 2DR SDN CNV SWG	55-56 Chevrolet 150 210 Bel Air Nomad, Pontiac Safari, Oldsmobile, Chevrolet, Gmc Truck	1081
H		55-56-57	Firewall grommet	2DR 4DR HTP 2DR SDN SWG CNV	55-57 Chevrolet All, Pontiac, Olds	1026

Chevrolet • Bel Air

CODE	IMAGE	YEAR	DESCRIPTION	BODY	FITS	ITEM#
H		55-56-57-58-59	Hood to cowl seal	2DR 4DR HTP 2DR SDN SWG CNV TRK	55-56 Chevrolet, Pontiac, Oldsmobile, 55-59 Chevrolet, Gmc Truck	1080
H		56	A-arm seals with cloth backing	2DR 4DR HTP 2DR SDN CNV SWG	56 Chevrolet 150 210 Bel Air Nomad	1082
H		56-57-58-59-60	Firewall grommet main wiring harness	2DR 4DR HTP 2DR SDN 2DR SDN SWG CNV	56-60 Chevrolet, Pontiac, Olds	1027
H		57	A-arm seals with staples	2DR 4DR HTP 2DR SDN CNV SWG	57 Chevrolet 150 210 Bel Air Nomad	1084
H		57	Hood to cowl seal	2DR 4DR HTP 2DR SDN CNV SWG	57 Chevrolet 150 210 Bel Air	1101
H		57	Hood to cowl seal clips & screws	2DR 4DR HTP 2DR SDN CNV SWG	57 Chevrolet 150 210 Bel Air	1102
H		58	Hood insulation	2DR 4DR HTP 2DR SDN CNV SWG	58 Chevrolet Del Ray Biscayne Bel Air Impala	21451
H		58	Hood to fender bumpers	2DR 4DR SDN HTP CNV	58 Chevrolet	2086
H		58-59-60	Hood to cowl seal	2DR 4DR HTP 2DR SDN CNV SWG	58-60 Chevrolet Del Ray Biscayne Impala Bel Air	2060
H		59	A-arm seals without clips	2DR 4DR HTP 2DR SDN CNV SWG	59 Chevrolet Biscayne Bel Air Impala	2101
H		59-60	Hood insulation	2DR 4DR HTP 2DR SDN CNV SWG	59-60 Chevrolet Biscayne Bel Air Impala	21452
H		60	A-arm seals without clips	2DR 4DR HTP 2DR SDN CNV SWG	60 Chevrolet Biscayne, Biscane Fleet- master, Bel Air, Impala, Brookwood, Parkwood, Kingswood, Nomad, El Camino	2100
H		61	Hood insulation	2DR 4DR HTP 2DR SDN CNV SWG	61 Chevrolet Biscayne Bel Air Impala	2146
H		61	A-arm seals with staples	2DR 4DR HTP 2DR SDN CNV SWG	61 Chevrolet Biscayne Bel Air Impala	2111















GUIDE TO SOFFSEAL'S PRODUCT CODES

B = Bumper sets **C** = Glass channels **D** = Door related **G** = Seals, gaskets **H** = Under hood items **I** = Interior parts
M = Miscellaneous items **R** = Roofrail, pillar post & convertible items **T** = Trunk related **W** = Window related **Z** = Weatherstrip kits



CODE	IMAGE	YEAR	DESCRIPTION	BODY	FITS	ITEM#
H		61-62	Hood to cowl seal	2DR 4DR HTP 2DR SDN CNV SWG	61-62 Chevrolet Biscayne Bel Air Impala	2130
H		62	Hood insulation	2DR 4DR HTP 2DR SDN SWG CNV	62 Chevrolet Biscayne Bel Air Impala	2147
H		62-63-64	A-arm seals with staples	2DR 4DR HTP 2DR SDN CNV SWG	62-64 Chevrolet Biscayne Bel Air Impala	2183
H		63	Hood insulation	2DR 4DR HTP 2DR SDN SWG CNV	63 Chevrolet Biscayne Bel Air Impala	2148
H		63-64	Hood to cowl seal	2DR 4DR HTP 2DR SDN CNV SWG	63-64 Chevrolet Impala Biscayne Bel Air	2192
H		64	Hood insulation	2DR 4DR HTP 2DR SDN SWG CNV	64 Chevrolet Biscayne Bel Air Impala	2149
H		64-65-66-67-68- 69-70-71-72	Firewall wiring gutter plk	2DR 4DR HTP 2DR SDN SWG CNV	Chevy Chevelle, Biscayne, Bel Air, Impala, Caprice, Nova, Camaro, Cadillac Calais, Deville, Fleetwood, Oldsmobile 88, 98, Jetstar, Starfire, Pontiac Catalina, Bonneville, Firebird, Buick Lesabre, Wildcat, Electra	2328
H		65	A-arm seals with staples	2DR SDN 2DR 4DR HTP CNV SWG	65 Chevrolet Biscayne Bel Air Impala	2324
H		65-66-67	Hood to cowl seal	2DR SDN 2DR 4DR HTP CNV SWG	65-67 Chevrolet Biscayne Bel Air Impala	2330
H		66	A-arm seals with staples	2DR 4DR HTP CNV	66 Chevrolet Biscayne Bel Air Impala	2325
H		67	Hood insulation with clips	2DR 4DR HTP 2DR SDN CNV SWG	67 Chevrolet Biscayne Bel Air Impala Caprice	2391
H		67-68	A-arm seals with staples	2DR 4DR HTP CNV	67-68 Chevrolet Biscayne Bel Air Impala	2326
H		69-70	A-arm seals with staples	2DR 4DR HTP CNV	69-70 Chevrolet Biscayne Bel Air Impala	2327
H		69-70	Hood insulation with clips	2DR 4DR HTP 2DR SDN CNV SWG	69-70 Chevrolet Impala Biscayne Caprice Bel Air	2403

Chevrolet • Bel Air

CODE	IMAGE	YEAR	DESCRIPTION	BODY	FITS	ITEM#
H		71-72-73-74-75-76-77-78	Hood to cowl seal	2DR SDN 2DR HTP CNV SWG	71-78 Chevrolet Impala, Caprice, Biscayne, Bel Air, Brookwood, Townsman, Kingswood, Buick Lesabre, Centurion, Electra 225, Estate Wagon, Cadillac Calais, Deville, Eldorado, Sixty Special Brougham, Oldsmobile 88, 98, Tornado, Pontiac Catalina, Bonneville, Grandville, Safari Full Size	2191
I		55-56-57	Gear shift grommet	2DR 4DR HTP 2DR SDN CNV SWG	55-57 Chevrolet, Pontiac, Oldsmobile All	1094
I		55-56-57-61-62-63-64	Glove box arm grommet	2DR 4DR HTP 2DR SDN CNV SWG	55-57 And 61-64 Chevrolet, Pontiac, Oldsmobile All	10691
I		58	Gear shift grommet column	2DR 4DR SDN HTP CNV	58 Chevrolet Del Ray, Biscayne, Bel Air, Impala, Cadillac, Oldsmobile 88 Oldsmobile 98, Buick Special, Century, Roadmaster, Riviera, Pontiac	2185
I		58-59-60-61-62-63-64	Emergency brake pedal pad with inverted letter	2DR 4DR HTP 2DR SDN CNV SWG	58-64 Chevrolet Del Ray Biscayne Bel Air Impala	2067
I		58-59-60-61-62-63-64-65-66-67	Accelerator pedal	2DR 4DR HTP 2DR SDN CNV SWG	58-67 Chevrolet Del Ray Biscayne Bel Air Impala Caprice, 62-67 Chevy II	2068
I		59-60-61-62-63-64-65-66	Gear shift grommet column	2DR 4DR SDN HTP CNV	59-66 Chevrolet Biscayne, Bel Air, Impala, 59-66 Cadillac, 59-63 Oldsmobile 88 Oldsmobile 98, 61 Starfire, 64-66 Starfire, Jet Star, 59-66 Buick LeSabre, Invicta, Electra, 63 Wildcat, Riviera, 59-66 Pontiac	2185A
I		60-61-62-63	Shift boot 4-speed bench seat	2DR 4DR HTP 2DR SDN CNV SWG	60-63 Chevrolet Biscayne Bel Air Impala	2105
I		61-62	Instrument panel dash seal rubber	2DR 4DR HTP 2DR SDN CNV SWG	61-62 Chevrolet Biscayne Bel Air Impala	2076
I		62	Shift boot 4-speed ss, with console	2DR 4DR HTP 2DR SDN CNV SWG	62 Chevrolet Biscayne Bel Air Impala	2104
I		62-63-64-65-66-67-68-69-70-71	Accelerator pedal hp with deluxe trim	2DR 4DR HTP 2DR SDN CNV SWG	62-71 Chevrolet Biscayne Bel Air Impala, 64-67 Chevelle, 70-71 Camaro Hi Perfor, 64-67 Buick Special-Skylark El Camino, 64-65 Pontiac A Body	2069
I		63-64	Dash mounted tach housing seal	2DR 4DR HTP 2DR SDN CNV SWG	63-64 Chevrolet Biscayne Bel Air Impala	2199
I		64	Shift boot 4-speed with console, upper	2DR 4DR HTP 2DR SDN CNV SWG	64 Chevrolet Biscayne Bel Air Impala	2107



















GUIDE TO SOFFSEAL'S PRODUCT CODES

B = Bumper sets **C** = Glass channels **D** = Door related **G** = Seals, gaskets **H** = Under hood items **I** = Interior parts
M = Miscellaneous items **R** = Roofrail, pillar post & convertible items **T** = Trunk related **W** = Window related **Z** = Weatherstrip kits



CODE	IMAGE	YEAR	DESCRIPTION	BODY	FITS	ITEM#
I		64	Shift boot ss lower	2DR 4DR HTP 2DR SDN CNV SWG	64 Chevrolet Biscayne Bel Air Impala	2109
I		64-65-66-67	Automatic console slider	2DR 4DR HTP 2DR SDN CNV SWG	64-67 Chevy II, Nova, Chevelle, Biscayne, Bel Air, Impala, 67 Chevrolet Camaro	2108
I		65-66-67-68-69-70	Accelerator pedal pad trim fit part 2069	2DR 4DR HTP SDN SWG CNV	65-70 Chevrolet Biscayne, Bel Air, Impala, Caprice, 2 Door 4 Door Hardtop Sedan Station Wagon Convertible	2069A
I		65-66-67-68-69-70	Parking brake pedal pad	2DR SDN 2DR 4DR HTP CNV SWG	65-70 Chevrolet Biscayne, Bel Air, Impala, Caprice	20671
I		65-66-67-68-69-70	Deluxe clutch & brake pad	2DR 4DR HTP 2DR SDN CNV SWG	65-70 Chevrolet Biscayne, Bel Air, Impala	20641
I		65-66-67-68-69-70	Deluxe manual brake & clutch pedal pad trim fits part 20641	2DR SDN 2DR 4DR HTP CNV SWG	65-70 Chevrolet Bel Air Biscayne Impala	20641A
I		65-66-67-68-69-70	Automatic brake pedal pad with disc brakes	2DR SDN 2DR 4DR HTP CNV SWG	65-70 Chevrolet Biscayne, Bel Air, Impala, Caprice	20642
I		65-66-67-70	Deluxe automatic brake pad trim fits part 2064	2DR SDN 2DR 4DR HTP CNV SWG	65-70 Chevrolet Biscayne, Bel Air, Impala	2064A
M		55	Firewall pad	2DR 4DR HTP SDN CNV SWG	55 Chevrolet 150 210 Bel Air Nomad, 2 Door 4 Door Hardtop Sedan Convertible Station Wagon	1232
M		55-56	Firewall pad seal	2DR 4DR HTP SDN CNV SWG	55-56 Chevrolet 150 210 Bel Air Nomad, 2 Door 4 Door Hardtop Sedan Convertible Station Wagon	1235
M		55-56-57	Lower speedo cable wiring harness grommet	2DR 4DR HTP SDN CNV SWG	55-57 Chevrolet, Pontiac, 2 Door 4 Door Hardtop Sedan Convertible Station Wagon	1099
M		55-56-57	Body to frame mounts htp	2DR HTP	55-57 Chevrolet 210 Bel Air, Pontiac, 2 Door Hardtop	1205
M		55-56-57	Body to frame mounts	CNV	55-57 Chevrolet Bel Air, Pontiac, Convertible	1207
M		55-56-57	Radiator core support bushing kit	2DR 4DR HTP SDN CNV SWG	55-57 Chevrolet 150 210 Bel Air Nomad, 2 Door 4 Door Hardtop Sedan Convertible Station Wagon	1209
M		55-56-57	Accelerator pedal	2DR 4DR HTP SDN CNV SWG	55-57 Chevrolet 150 210 Bel Air Nomad, Pontiac, 55-57 Corvette, 2 Door 4 Door Hardtop Sedan Convertible Station Wagon	1050
M		55-56-57-59-60-61	Gear tube grommet	2DR 4DR HTP SDN CNV SWG	55-57 And 59-60 Chevrolet Pontiac, Oldsmobile, 60-61 Chevrolet Truck, Gmc Truck, 2 Door 4 Door Hardtop Sedan Convertible Station Wagon	1095

Chevrolet • Bel Air

CODE	IMAGE	YEAR	DESCRIPTION	BODY	FITS	ITEM#
M		56	Firewall pad	2DR 4DR HTP SDN SWG CNV	56 Chevrolet 150 210 Bel Air Nomad, 2 Door 4 Door Hardtop Sedan Station Wagon Convertible	1233
M		57	Firewall pad	2DR 4DR HTP SDN CNV SWG	57 Chevrolet 150 210 Bel Air Nomad, 2 Door 4 Door Hardtop Sedan Convert- ible Station Wagon	1234
M		57	Firewall pad seal	2DR SDN 4DR HTP	57 Chevrolet 150 210 Bel Air Nomad, 2 Door Sedan 4 Door Hardtop	1236
M		57	Blower motor sleeve	2DR 4DR HTP SDN CNV SWG	57 Chevrolet, All Except A/C Models, 2 Door 4 Door Hardtop Sedan Convert- ible Station Wagon	1116
M		57	Bumper guard bullets	2DR 4DR HTP SDN CNV SWG	57 Chevrolet 150 210 Bel Air Nomad, 2 Door 4 Door Hardtop Sedan Convert- ible Station Wagon	1076
M		57-58-59-60-61- 62-63-64-65-66- 67-68-69-70-71-72- 73-74-75-76-77-78- 79-80-81	Bellhousing to clutch fork rubber boot	2DR 4DR HTP SDN CNV SWG	57-81 GM All Manual Transmission	2196
M		58-59-60-61-62- 63-64-65	Automatic power brake pad	2DR 4DR HTP SDN CNV SWG	58-65 Chevrolet Del Ray Biscayne Bel Air, 62-67 Chevy II Nova Caprice, 63- 67 Corvette, 2 Door 4 Door Hardtop Sedan Convertible Station Wagon	2063
M		58-59-60-61-62- 63-64-65	Power brake pedal pad with standard trans	2DR 4DR HTP SDN CNV SWG	58-65 Full-Size Chevrolet Biscayne Bel Air Impala Caprice, 58-62 Corvette, 58 Del Ray, 2 Door 4 Door Hardtop Sedan Convertible Station Wagon	20651
M		58-59-60-61-62- 63-64-65-66-67	Standard brake & clutch pedal pads	2DR 4DR HTP 2DR SDN CNV SWG	58-67 Chevrolet Del Ray Biscayne Bel Air Impala, 62-67 Chevy II, Nova Caprice 58-62 Corvette	2065
M		58-59-60-61-62- 63-64-65-66-67- 68-69	Automatic brake pad with out power brakes	2DR 4DR HTP SDN CNV SWG	58-69 Chevrolet Biscayne Bel Air Im- pala, 63-67 Corvette 62-67 Chevy II, 65-69 Corvair, 2 Door 4 Door Hardtop Sedan Convertible Station Wagon	2066
M		59	Body mounts	2DR 4DR HTP 2DR SDN SWG	59 Chevrolet Biscayne Bel Air Impala, Except Convertible	2070
M		60-61-62-63-64	Frame to body mount kit	2DR 4DR HTP SDN CNV SWG	60-64 Chevrolet Biscayne Bel Air Impala, 2 Door 4 Door Hardtop Sedan Convertible Station Wagon	2110
M		61-62	Bellhousing fork boot	2DR 4DR HTP SDN CNV SWG	61-62 Chevrolet Biscayne, Bel Air, Impala, 61-62 Cadillac, 61-62 Oldsmo- bile, 61-62 Buick, 61-62 Buick, 2 Door 4 Door Hardtop Sedan Convertible Station Wagon	2198
M		61-62	Windshield post drain gutters	2DR 4DR HTP SDN CNV SWG	61-62 Chevrolet Biscayne Bel Air Impala, 2 Door 4 Door Hardtop Sedan Convertible Station Wagon	21614
M		61-62-63-64	Frame to body mount bolt kit	2DR 4DR HTP 2DR SDN	61-64 Chevrolet Biscayne Bel Air Impala, 2 Door 4 Door Hardtop Sedan	2110A
M		63-64	Firewall pad	2DR 4DR HTP SDN CNV SWG	63-64 Chevrolet Biscayne Bel Air Impala, 2 Door 4 Door Hardtop Sedan Convertible Station Wagon	21724











GUIDE TO SOFFSEAL'S PRODUCT CODES					
B = Bumper sets	C = Glass channels	D = Door related	G = Seals, gaskets	H = Under hood items	I = Interior parts
M = Miscellaneous items	R = Roofrail, pillar post & convertible items	T = Trunk related	W = Window related	Z = Weatherstrip kits	



CODE	IMAGE	YEAR	DESCRIPTION	BODY	FITS	ITEM#
M		65-66	Body mount bolt kit	2DR HTP 2DR SDN	65-66 Chevrolet Impala Caprice Bel Air Biscayne, 2 Door Hardtop, Sedan	2398
M		65-66	Body mount kit	2DR HTP 2DR SDN	65-66 Chevrolet Impala Caprice, Biscayne, Bel Air, 2 Door Hardtop, Sedan	2392
M		66-67-68	Radiator support bushings & hardware kit	2DR 4DR HTP SDN CNV SWG	66-68 Chevrolet Biscayne Impala Caprice Bel Air, 2 Door 4 Door Hardtop Sedan Convertible Station Wagon	2407
M		67-68	Body mount bolt kit	2DR HTP 2DR SDN CNV	67-68 Chevrolet Impala Caprice Bel Air Biscayne, 2 Door Hardtop Sedan Convertible	2400
M		67-68	Body mount kit	2DR HTP 2DR SDN	67-68 Chevrolet Impala Caprice Bel Air Biscayne, 2 Door Hardtop, Sedan	2394
M		69-70	Body mount bolt kit	2DR HTP SDN CNV	69-70 Chevrolet Impala Caprice Bel Air Biscayne, 2 Door Hardtop Sedan Convertible	2401
R		55-56-57	Weatherstrip kit for convertible top cloth covered	CNV	55-57 Chevrolet Bel Air, Pontiac Starchief	1030C
R		55-56-57	Weatherstrip kit for convertible top non cloth covered	CNV	55-57 Chevrolet Bel Air, Pontiac Starchief	1030U
R		55-56-57	Header seal	CNV	55-57 Chevrolet Bel Air, Pontiac Convertible	1031
R		56-57	Roofrail weatherstrip	4DR HTP	56-57 Chevrolet 210 Bel Air, Pontiac, 4 Door Hardtop	1028
R		58	Roofrail weatherstrip	2DR HTP	58 Chevrolet Bel Air Sport Coupe, Pontiac Chieftain, 2 Door Hardtop	20431
R		59-60	Roofrail weatherstrip	4DR HTP	59-60 Chevrolet Bel Air, Buick Impala, LeSabre, Invicta, 4 Door Hardtop	2220
R		61	Roofrail weatherstrip with molded ends	2DR HTP	61 Chevrolet, Buick, Oldsmobile, Pontiac 2 Door Hardtop	2129
R		61-62	Roofrail weatherstrip	4DR HTP	61-62 Chevrolet Bel Air, Impala, Buick, LeSabre, Invicta, Oldsmobile 88, Pontiac, 4 Door Hardtop	2223
T		55-56	Trunk weatherstrip	2DR 4DR HTP 2DR SDN CNV	55-56 Chevrolet 150, Chevrolet 210, Chevrolet Bel Air, Chevrolet Nomad, Oldsmobile 98, Pontiac Chieftan, Pontiac 860, Pontiac 870, Pontiac Super Chief, Pontiac Bonneville, Pontiac Star Chief, Pontiac Safari	6012
T		55-56-57	Trunk mat	2DR 4DR HTP 2DR SDN 4DR SDN	55-57 Chevrolet 150 210 Bel Air, Pontiac, Hardtop Sedan	1217
T		55-56-57	Trunk mat	CNV	55-57 Chevrolet Bel Air, Pontiac, Convertible	1217A

Chevrolet • Bel Air

CODE	IMAGE	YEAR	DESCRIPTION	BODY	FITS	ITEM#
T		55-56-57	Trunk area access plugs	2DR 4DR HTP 2DR SDN CNV	55-57 Chevrolet 150 210 Bel Air, Pontiac	1218
T		55-56-57	Spare tire well plugs	2DR 4DR HTP 2DR SDN CNV	55-57 Chevrolet 150 210 Bel Air, Pontiac Chieftain, Starchief, Super Chief, Oldsmobile	1219
T		57	Trunk weatherstrip with clips	2DR 4DR HTP 2DR SDN CNV	57 Chevrolet, Pontiac Except Star Chief	1011
T		58-59-60-61-62- 63-64-65-66-67- 68-69	Trunk weatherstrip exact profile	2DR 4DR HTP 2DR SDN CNV	58-64 Chevrolet Biscayne, 58-64 Chevrolet Bel Air, Chevrolet Impala, 60-69 Chevrolet Corvair, 59-64 Pontiac Parisienne, 59-64 Pontiac Catalina, 59-64 Pontiac Star Chief, 60-61 Pontiac Ventura, 62-64 Pontiac Grand Prix, 58-64 Oldsmobile Delta 88, 58-64 Oldsmobile Dynamic 88, Oldsmobile Super 88, Oldsmobile Super 98, 61-64 Oldsmobile Starfire, 64 Oldsmobile Jetstar, 59-64 Buick LeSabre, 59-62 Buick Invicta, 59-64 Buick Electra, 62-64 Buick Wildcat, 63-65 Buick Riviera, 58-60 Cadillac Deville, Cadillac Eldorado, Cadillac Series 62, Cadillac Series 60 Special, Cadillac Series 75, 58-64 C-Body	2001
T		62-63-64	Trunk mat, sport coupe	2DR HTP 2DR SDN	62-64 Chevrolet Biscayne Bel Air Impala	2186
T		64-65-66-67-68- 69-70-71-72-73-74- 75-76-77	Trunk weatherstrip exact profile length 17 feet	2DR 4DR HTP 2DR SDN CNV	65-72 Chevy II, 65-72 Chevrolet Biscayne, 65-75 Chevrolet Bel Air, 65- 76 Chevrolet Impala, 65-76 Chevrolet Caprice, 64-77 Chevrolet Chevelle, 70-77 Chevrolet Monte Carlo, 65-76 Buick LeSabre, 64-77 Buick Wildcat, 64-77 Buick Skylark, 71-73 Buick Centurion, 64-72 Buick Grand Special, 73-77 Buick Century, 73-88 Buick Regal, 73-88 Buick Grand National, 65-76 Buick Electra, 65-76 Oldsmobile Delta 88, 67-69 Oldsmobile Delmont 88, 65-66 Oldsmobile Dynamic 88, 65-66 Oldsmobile Starfire, 65 Oldsmobile Jetstar, 64-77 Oldsmobile Cutlass 442, 64-88 Oldsmobile Cutlass, 65-76 Oldsmobile 98, 65-76 Pontiac Parisienne, 64-72 Pontiac LeMans, 65-70 Pontiac Catalina, 65-66 Pontiac Star Chief, 67-70 Pontiac Executive, 71-75 Pontiac Grand Ville, 65-77 Pontiac Grand Prix, 64-72 Pontiac Tempest, 62-72 Nova, Ventura, 73-74 Non-Hatchback, Up to 1975 with groove channel, Apollo, Nova, Omega, Ventura 65-76 C-Body	2003
W		37-38-39-40-41- 42-43-44-45-46- 47-48-49-50-51-52- 53-54	Mohair channel liner, 4 feet of 2 7/8 inch mohair lining material	CNV 2DR 4DR HTP	Bel Air 150 210, Nomad, Chieftain, 860/870 Star Chief, Safari, Super Chief, Bonneville, Nova, Omega, Apollo, Ventura, Skylark	0420
W		49-50-51-52-53-54- 55-56-57	Quarter glass vertical seals cloth covered	2DR HTP CNV	53-57 Chevrolet Bel Air, 49-52 Styleline, Fleetline, Pontiac, 2 Door Hardtop Convertible	1212



GUIDE TO SOFFSEAL'S PRODUCT CODES

B = Bumper sets **C** = Glass channels **D** = Door related **G** = Seals, gaskets **H** = Under hood items **I** = Interior parts
M = Miscellaneous items **R** = Roofrail, pillar post & convertible items **T** = Trunk related **W** = Window related **Z** = Weatherstrip kits



CODE	IMAGE	YEAR	DESCRIPTION	BODY	FITS	ITEM#
W		49-50-51-52-53-54-55-56-57	Quarter glass vertical seals not cloth covered	2DR HTP CNV	53-57 Chevrolet Bel Air, 49-52 Styleline, Pontiac, 2 Door Hardtop Convertible	1212A
W		55-56-57	Glass setting channel, doors only	2DR HTP 2DR SDN	55-57 Chevrolet, Pontiac Safari, Oldsmobile, 2 Door Hardtop	1211
W		55-56-57	Window weatherstrip with division bar & window channel replacement style	4DR SWG	55-57 Chevrolet Bel Air, Pontiac Star Chief 4 Door Station Wagon	1048
W		55-56-57	Front of door flipper stops	2DR HTP	55-57 Chevrolet, Pontiac, Oldsmobile 2 Door Hardtop	1086
W		55-56-57	Front flipper to vent stop	2DR HTP	55-57 Chevrolet, Pontiac, Oldsmobile, 2 Door Hardtop	1088
W		55-56-57	Flipper reline kit	2DR HTP	55-57 Chevrolet, Oldsmobile, Pontiac, 2 Door Hardtop	1089
W		55-56-57	Cozy vent seals	2DR 4DR HTP CNV	55-57 Chevrolet All, Nomad, Pontiac All, Safari, 2 Door 4 Door Hardtop Convertible	1032
W		55-56-57	Cozy vent seals	2DR SDN 4DR SDN SWG	55-57 Chevrolet, Pontiac, 2 Door And 4 Door Sedan And Station Wagon Except Nomad And Safari	1033
W		55-56-57	Window weatherstrip replacement style	2DR HTP	55-57 Chevrolet Bel Air, Pontiac, 2 Door Hardtop	1040
W		55-56-57	Window weatherstrip replacement style	CNV	55-57 Chevrolet Bel Air, Pontiac, Convertible	1041
W		55-56-57	Window weatherstrip with division bar & window channel replacement style	2DR SDN	55-57 Chevrolet 150 210 Bel Air, Pontiac, 2 Door, Sedan	1042
W		55-56-57	Window weatherstrip replacement style	2DR SDN	55-57 Chevrolet 150 210 Bel Air, Pontiac 2 Door Sedan	1042A
W		55-56-57	Window weatherstrip with division bar & window channel replacement style	4DR SDN	55-57 Chevrolet 150 210 Bel Air, Pontiac, 4 Door Sedan	1043
W		56-57	Window weatherstrip replacement style	4DR HTP	56-57 Chevrolet 210 Bel Air, Pontiac, 4 Door Hardtop	1044
W		56-57	Quarter window seals	4DR HTP	56-57 Chevrolet And Pontiac, 4 Door Hardtop	1239
W		58	Vent window weatherstrip	2DR 4DR HTP	58 Chevrolet Bel Air, Pontiac Catalina, Super Chief, 2d4, 4 Door Hardtop	2278
W		58-59-60-61-62-63-64	Quarter window seals	2DR HTP CNV	58-64 Chevrolet Impala, 58, 60-62 Bel Air, 58-64 Cadillac Series 62, Deville, Eldorado, 58 Oldsmobile 88 Oldsmobile 98, 59-60 Oldsmobile 88 Oldsmobile 98, 61-64 Oldsmobile 99, Starfire, 98, 64 Jetstar, 59-62 Buick LeSabre, Invicta, Electra 2 Door Hardtop Convertible	2300

Chevrolet • Bel Air

CODE	IMAGE	YEAR	DESCRIPTION	BODY	FITS	ITEM#
W		59-60	Window weatherstrip replacement style	2DR SDN	59-60 Chevrolet Biscayne, Bel Air, 2 Door Sedan	20961
W		59-60	Window weatherstrip replacement style	2DR HTP	59-60 Chevrolet Bel Air Impala, 2 Door Hardtop	2138
W		59-60	Rear quarter stationary vent window seals	4DR SDN	59-60 Chevrolet Buick, Style 4419, 4619, 4719 Oldsmobile, Pontiac 4 Door Sedan	2053
W		61-62	Window weatherstrip replacement style	2DR HTP	61 Chevrolet Impala, 62 Chevrolet Bel Air Bubbletop, 2 Door Hardtop	2139
W		61-62	Vent window seals	2DR 4DR HTP CONV	61-62 Chevrolet Bel Air, Impala, 61-62 Cadillac Series 62, Eldorado, 61-62 Oldsmobile 88 Oldsmobile 98, 61-62 Buick LeSabre, Invicta, Electra, 61-62 Pontiac Bonneville, Catalina, Ventura 2 Door 4 Door Hardtop, Convertible	21615
W		61-62-63-64-65-66	Horizontal outer window seals	2DR 4DR HTP SDN CNV SWG	Chevy Biscayne, Bel Air, Impala, Caprice, Cadillac series 62 Deville, Eldorado, Fleetwood, Calais, Oldsmobile 88, Starfire, 98. Buick Lesabre, Invicta, Wildcat, Electra, Pontiac Catalina, Ventura, Star Chief, Bonneville	2310
W		62	Window weatherstrip replacement style	2DR HTP	62 Chevrolet Bel Air Impala, 2 Door Hardtop	2141
W		65-66-67-68	Vent window weatherstrip	2DR SDN SWG 4DR	65-68 2 Door 4 Door Sedan And Station Wagon	2284
W		65-66-67-68-69	Doorglass run channel, upper & rear	2DR SDN	65-72 Chevrolet Pontiac, 2 Door Sedan	2517
Z		55	Weatherstrip kit, includes door weatherstrip w/ molded ends, trunk weatherstrip, paint gasket kit, window weatherstrip replacement style, body bumper kit, hood to cowl seal and clips, lens gasket kit parklight, tail light/backup gasket, door j weatherstrip w/ clips, quarter glass vertical seals cloth covered, pillar post seals	2DR HTP	55 Chevrolet 210 Bel Air 2 Door Hardtop	KIT105
Z		55	Weatherstrip kit, includes bumper kit, convertible top kit, door weatherstrips, hood to cowl with clips, door j weatherstrips, lens gaskets, paint gaskets, pillar post seals, quarter window seals, trunk weatherstrip, window weatherstrips	CNV	55 Chevrolet Bel Air Convertible	KIT108
Z		55	Weatherstrip kit, includes bumper kit, door weatherstrips, hood to cowl seal with clips, door j weatherstrips, lens gaskets, paint gaskets, trunk weatherstrip, window weatherstrips	2DR SDN	55 Chevrolet 150 210 Bel Air 2 Door Sedan	KIT111



GUIDE TO SOFFSEAL'S PRODUCT CODES

B = Bumper sets **C** = Glass channels **D** = Door related **G** = Seals, gaskets **H** = Under hood items **I** = Interior parts
M = Miscellaneous items **R** = Roofrail, pillar post & convertible items **T** = Trunk related **W** = Window related **Z** = Weatherstrip kits



CODE	IMAGE	YEAR	DESCRIPTION	BODY	FITS	ITEM#
Z		56	Weatherstrip kit, includes a arm seals, bumper kit, door weatherstrips, hood to cowl seal with clips, door j weatherstrips, lens gaskets, paint gaskets, trunk weatherstrip, window weatherstrips	2DR SDN	56 Chevrolet 150 210 Bel Air 2 Door Sedan	KIT112
Z		56	Weatherstrip kit, includes a arm seals, bumper kit, convertible top kit, door weatherstrips, hood to cowl with clips, door j weatherstrips, lens gaskets, paint gaskets, pillar post seals, quarter window seals, trunk weatherstrip, window weatherstrips	CNV	56 Chevrolet Bel Air Convertible	KIT109
Z		56	Weatherstrip kit, includes bumper kit, door weatherstrips, hood to cowl seal with clips, door j weatherstrip, lens gasket, paint gaskets, pillar post seals, quarter. window seals, trunk weatherstrips, window weatherstrips	2DR HTP	56 Chevrolet 210 Bel Air 2 Door Hardtop	KIT106
Z		57	Weatherstrip kit, includes a arm seals, bumper kit, door weatherstrips, hood to cowl seal with clips, door j weatherstrip, lens gasket, paint gaskets, pillar post seals, quarter. window seals, trunk weatherstrips, window weatherstrips	2DR HTP	57 Chevrolet 210 Bel Air 2 Door Hardtop	KIT107
Z		57	Weatherstrip kit, includes a arm seals, bumper kit, convertible top kit, door weatherstrips, hood to cowl with clips, door j weatherstrips, lens gaskets, paint gaskets, pillar post seals, quarter window seals, trunk weatherstrip, window weatherstrips	CNV	57 Chevrolet Bel Air Convertible	KIT110
Z		57	Weatherstrip kit, includes a arm seals, door weatherstrips, hood to cowl seal, door j weatherstrips, lens gaskets, trunk weatherstrip, window felt, pillar post, quarter window seal, roofrail weatherstrip	2DR SDN	57 Chevrolet 150 210 Bel Air 2 Door Sedan	KIT113

Chevrolet • Biscayne

CODE	IMAGE	YEAR	DESCRIPTION	BODY	FITS	ITEM#
B		51-52-53-54-55-56-57-58	Upper vent window bumpers	2DR 4DR HTP 2DR SDN CNV SWG	51-58 Chevrolet 150 210 Bel Air Nomad Del Ray Biscayne Impala, 51-54 Chevrolet, Pontiac, Oldsmobile, Buick, Cadillac, Hardtop Convertible	1224
B		58-59	Gas door bumper	2DR 4DR HTP 2DR SDN CNV SWG	58-59 Chevrolet Del Ray, Biscayne, Bel Air, Impala	2074
B		59	Hood panel grille bumpers	2DR 4DR HTP SDN CNV SWG	59 Chevrolet Biscayne, Bel Air, Impala	20721
B		59-60-61	Hood side bumpers	2DR 4DR HTP 2DR SDN CNV SWG	59-61 Chevrolet Biscayne, Bel Air, Impala	2072
B		62	Hood side bumper	2DR 4DR HTP 2DR SDN CNV SWG	62 Chevrolet Biscayne, Impala, Bel Air	21812
B		62	Bumper kit	2DR HTP CNV 2DR SDN	62 Chevrolet Biscayne, Bel Air, Impala, 2 Door Hardtop Convertible Sedan	2316
B		62-63-64	Gas door bumpers	2DR 4DR HTP 2DR SDN CNV SWG	62-64 Chevrolet Biscayne, Bel Air, Impala, Cadillac, Oldsmobile, Buick, Pontiac	2143
B		63-64	Bumper kit	2DR HTP CNV 2DR SDN	63-64 Chevrolet Biscayne, Bel Air, Impala	2317
B		63-64	Hood side bumpers	2DR 4DR HTP 2DR SDN CNV SWG	63-64 Chevrolet Biscayne, Impala, Bel Air, 64 Chevelle	2181
B		65	Hood side bumpers	2DR 4DR HTP 2DR SDN CNV SWG	65 Chevrolet Biscayne, Impala, Bel Air, Caprice, Chevelle, Malibu, 65 Cadillac, 65 Oldsmobile, 65 Buick, 65 Pontiac	2182
B		65	Bumper kit, includes: door hood trunk glove box	2DR HTP 2DR SDN	65 Chevrolet Biscayne, Bel Air, Impala, 2 Door Hardtop Sedan	2370
B		66-67-68-69-70-71-72	Bumper kit, includes: door hood trunk glove box	2DR 4DR HTP 2DR SDN CNV SWG	66 Chevrolet Biscayne, Bel Air, Impala, Caprice, 68-69 Chevelle, 70-71 Chevelle, Monte Carlo, 72 Chevelle, 66-72 Cadillac, 66-72 Oldsmobile, 66-72 Buick, 66-72 Pontiac	2371
B		66-67-68-69-70-71-72	Hood side bumpers	2DR 4DR SDN HTP CNV	66-72 Chevrolet Biscayne, Bel Air, Impala, Caprice, 73-75 Nova, 66-72 Cadillac, 66-72 Oldsmobile, 66-72 Buick, 66-72 Pontiac	2179
B		67-68-69-70	Door bumpers	2DR 4DR HTP 2DR SDN CNV SWG	67-70 Chevrolet Biscayne, Bel Air, Impala Caprice, 67-70 Cadillac Calais, Deville, Fleetwood, 67-70 Oldsmobile 88, 98, 67-70 Buick LeSabre, Wildcat, Electra, 67-70 Pontiac	2323
B		67-68-69-70	Bumper kit, includes: door hood trunk glove box	2DR HTP 2DR SDN	67-70 Chevrolet Biscayne, Bel Air, Impala, Caprice, 2 Door Hardtop Sedan	2372



GUIDE TO SOFFSEAL'S PRODUCT CODES

B = Bumper sets **C** = Glass channels **D** = Door related **G** = Seals, gaskets **H** = Under hood items **I** = Interior parts
M = Miscellaneous items **R** = Roofrail, pillar post & convertible items **T** = Trunk related **W** = Window related **Z** = Weatherstrip kits

Chevrolet • Biscayne



CODE	IMAGE	YEAR	DESCRIPTION	BODY	FITS	ITEM#
C		61-62	Front glass channel	2DR SDN SWG 4DR	61-62 Chevrolet, Pontiac, 2 Door 4 Door Sedan And Station Wagon	21621
C		62-63-64	Glass channel rear	2DR 4DR SDN	62-63 Chevrolet Biscayne, Bel Air, Impala, 62-64 Cadillac, 62-64 Oldsmobile 88, 62-64 Buick LeSabre, 64 Wildcat, 62-64 Pontiac Catalina, Star Chief 2 Door 4 Door Sedan	2189
C		63-64	Glass channel rear side stationary window	4DR SWG	61-64 Chevrolet, Buick, Oldsmobile, Pontiac 4 Door Station Wagon, All	2123
C		63-64	Windshield gasket	2DR SDN SWG	63-64 Chevrolet Biscayne, Bel Air, Impala, 63-64 Cadillac Series 62, Deville, 63-64 Oldsmobile 88 Oldsmobile 98, 63-64 Buick LeSabre, Wildcat, Electra, 63-64 Pontiac, 2 Door Sedan Station Wagon	2020
D		58	Door j weatherstrip	2DR 4DR HTP 2DR SDN CNV SWG	58 Chevrolet Del Ray, Biscayne, Bel Air, Impala, 58 Cadillac, 57-58 Oldsmobile 88 Oldsmobile 98, 57-58 Buick Special Century, Super, Roadmaster, 58 Pontiac	2044
D		59-60	Door j weatherstrip	2DR 4DR HTP SWG 2DR SDN 4DR SDN	59-60 Chevrolet, Pontiac, Oldsmobile, Buick, Cadillac	2093
D		61-62	Door weatherstrip front with clips	SWG 4 DR SDN	61-62 Chevrolet BelAir, Biscayne, Impala, Pontiac, Station Wagon & 4 Dr Sedan	2019
D		61-62-63-64	Door weatherstrip rear with clips	4dr SWG	61-64 Chevrolet Biscayne, Bel Air, Impala, 61-64 Oldsmobile 88, 61-64 Buick LeSabre, 62-63 Invicta 63-64 Wildcat, 61-64 Pontiac Catalina, Bonneville, 4 Door Station Wagon	2018
D		61-62-63-64	Door weatherstrip rear door with clips	4DR SDN	61-64 Chevrolet Biscayne Bel Air Impala, 61-64 Oldsmobile 88, 98, 61-62 Cadillac, 61-64 Buick LeSabre Electra, 64 Wildcat, 61-64 Pontiac Catalina, Star Chief, 4 Door Sedan	2009
D		61-62-63-64	Door weatherstrip with clips	2DR SDN	61-64 Chevrolet, Pontiac, Buick, Oldsmobile, 2 Door Sedan	2005
D		63-64	Door weatherstrip front with clips	4DR SDN SWG	63-64 Chevrolet Biscayne, Bel Air, Impala, 63-64 Cadillac, 63-64 Oldsmobile 88, 63-64 Buick LeSabre, Wildcat, 63-64 Pontiac, 4 Door Sedan Station Wagon	2017
D		63-64	Front door weatherstrip with molded ends	4DR HTP	63-64 Chevrolet Biscayne, Bel Air, Impala, Buick Wildcat, Lesabre, Electra, Pontiac Catalina, Star Chief, Bonneville, Oldsmobile Dynamic 88, 98 4 Door Ht	2121
D		65-66	Door weatherstrip with clips	2DR SDN	65-66 Chevrolet Biscayne, Bel Air, 65-66 Cadillac, 65-66 Oldsmobile, 65-66 Buick, 65-66 Pontiac, 2 Door Sedan	2332

Chevrolet • Biscayne

CODE	IMAGE	YEAR	DESCRIPTION	BODY	FITS	ITEM#
D		65-66	Door weatherstrip front with clips	4DR SDN SWG	65-66 Chevrolet Biscayne Bel Air Impala, 65-66 Cadillac Calais Deville Fleetwood, 65-66 Oldsmobile 88, 65-66 Buick LeSabre Wildcat, 65-66 Pontiac Bonneville, Catalina, Star chief, 4 Door Sedan Swg	2006
D		65-66	Rear door weatherstrip with clips	4DR SDN	65-66 Chevrolet Biscayne Bel Air Impala 65-66 Cadillac Calais Deville Fleetwood 65-66 Oldsmobile 88, 65-66 Buick LeSabre Wildcat, 65-66 Pontiac Catalina, Star Chief, 4 Door Sedan	2007
D		65-66	Door weatherstrip rear station wagon with clips	4DR SWG	65-66 Chevrolet Biscayne, Bel Air, Impala, 65-66 Oldsmobile, 65-66 Buick, 65-66 Pontiac	2008
D		67-68	Front door weatherstrip with clips	4DR SDN SWG	67-68 Chevrolet Biscayne, Bel Air, Impala, 67-68 Cadillac Calais, Deville, Fleetwood, 67-68 Oldsmobile Delmont 88, Delta 88, 98, 67-68 Buick LeSabre, Wildcat, Electra 67-68 Pontiac Catalina, Executive, Bonneville, 4 Door Sedan Station Wagon	23321
D		67-68	Door weatherstrip rear with clips	4DR SDN	67-68 Chevrolet Biscayne, Bel Air, Impala, 67-68 Cadillac Calais, Deville, Fleetwood, 67-68 Oldsmobile 88, 67-68 Buick LeSabre, Wildcat, 67-68 Pontiac Bonneville Station Wagon, 67-68 Pontiac Executive, Catalina, 4 Door Sedan	23322
D		67-68	Door weatherstrip with clips	2DR SDN	67-68 Chevrolet Biscayne, Bel Air, 67-68 Cadillac, 67-68 Oldsmobile, 67-68 Buick, 67-68 Pontiac, 2 Door Sedan	2329
D		69-70	Door weatherstrip front doors with clips	4DR SDN SWG	69-70 Chevrolet Biscayne, Bel Air, Impala, Cadillac, Buick La Sabre, Wildcat, Pontiac, 4 Door Sedan Station Wagon	2510
D		69-70	Rear door weatherstrip	SWG 4DR	69-70 Chevy Biscayne, Bel Air, Impala, Caprice, Estate, Oldsmobile Vista Cruiser, Pontiac Catalina, Bonneville, Executive, Gm Fullsize Station Wagon 4 Door	2519
D		71-72-73-74	Door weatherstrip rear with clips & molded ends	4DR SDN	71-74 Chevrolet Impala, Bel Air, Biscayne, Brookwood, Townsman, Kingswood, Buick Estate Station Wagon, Pontiac Catalina, Grand Safari, Bonneville, Oldsmobile Custom Cruiser, 4 Door Sedan	2225
D		71-72-73-74-75-76	Door weatherstrip front with clips & molded ends	4DR SWG	71-76 Chevrolet Impala, Bel Air, Biscayne, Brookwood, Townsman, Kingswood, Buick Estate Station Wagon, Pontiac Catalina, Grand Safari, Bonneville, Oldsmobile Custom Cruiser, 4 Door Station Wagon	2228
G		56-58	Rear body to bumper seal	2DR 4DR HTP 2DR SDN CNV SWG	56, 58 Chevrolet	1090
G		57-58-59-60	Inner to outer fender seals	2DR 4DR HTP 2DR SDN CNV SWG	57-60 Chevrolet	1103



GUIDE TO SOFFSEAL'S PRODUCT CODES

B = Bumper sets **C** = Glass channels **D** = Door related **G** = Seals, gaskets **H** = Under hood items **I** = Interior parts
M = Miscellaneous items **R** = Roofrail, pillar post & convertible items **T** = Trunk related **W** = Window related **Z** = Weatherstrip kits



CODE	IMAGE	YEAR	DESCRIPTION	BODY	FITS	ITEM#
G		58	Heater plenum to firewall gasket	2DR 4DR HTP 2DR SDN CNV SWG	58 Chevrolet Del Ray Biscayne Impala Bel Air	2037
G		58	Heater box seal kit non a/c 2 piece	2DR 4DR HTP 2DR SDN CNV SWG	58 Chevrolet Del Ray Biscayne Impala Bel Air	20371
G		58	A-arm seals w/o clips	2DR 4DR HTP 2DR SDN CNV SWG	58 Chevrolet Del Ray Biscayne Impala Bel Air	2042
G		58	Lens gasket kit	2DR 4DR HTP 2DR SDN CNV SWG	58 Chevrolet Del Ray Biscayne Impala Bel Air	2045
G		58	Antenna base gasket	2DR 4DR HTP 2DR SDN CNV SWG	58 Chevrolet Del Ray Biscayne Impala Bel Air	2046
G		58	Steering column seal with automatic trans	2DR 4DR HTP 2DR SDN CNV SWG	58 Chevrolet Pontiac	2056
G		58	Steering column seal sponge	2DR 4DR HTP 2DR SDN CNV SWG SR	58 Chevrolet Pontiac, Universal Fit Street Rod And Custom, Standard Transmission	2056A
G		58	Anti-squeak fender seals	2DR 4DR HTP 2DR SDN CNV SWG	58 Chevrolet Del Ray Biscayne Impala Bel Air	2057
G		58	Front splash pan seals	2DR 4DR HTP 2DR SDN SWG CNV	58 Chevrolet Del Ray Biscayne Impala Bel Air	2058
G		58	Door handle & lock gaskets	2DR 4DR HTP 2DR SDN SWG CNV	58 Chevrolet Pontiac	2059
G		59	Antenna gasket left or right, rear	2DR SDN 2DR 4DR HTP CNV SWG	59 Chevrolet Biscayne Bel Air Impala	2071
G		59	Door handle & lock gaskets	2DR 4DR HTP 2DR SDN CNV SWG	59 Chevrolet Pontiac	2073
G		59	Lens gasket kit 4 piece parklight, taillight	2DR 4DR HTP 2DR SDN CNV SWG	59 Chevrolet Biscayne Bel Air Impala	2176
G		59	Tail lamp assembly to body seal	2DR 4DR HTP 2DR SDN CNV SWG	59 Chevrolet Biscayne Bel Air Impala	21761

Chevrolet • Biscayne

CODE	IMAGE	YEAR	DESCRIPTION	BODY	FITS	ITEM#
G		59-60	Steering column floor seal with felt washer & metal retainer standard. transmission	SWG	59-60 Chevrolet Biscayne, Bel Air, Impala, El Camino, Station Wagon	2117
G		59-60	Backup housing gaskets	2DR 4DR HTP 2DR SDN CNV SWG	59 Chevrolet Impala, 59 And 60 Bel Air Station Wagon, El Camino	2075
G		59-90	Steering column floor seal automatic transmission	SWG	59-60 Chevrolet Biscayne, Bel Air, Impala, El Camino, Station Wagon	2116
G		60	Antenna gasket right, rear	2DR 4DR HTP 2DR SDN CNV SWG	60 Chevrolet Biscayne Bel Air Impala	2084
G		60	Antenna gasket left rear	2DR 4DR HTP 2DR SDN CNV SWG	60 Chevrolet Biscayne Bel Air Impala	2085
G		60	Lens gasket kit 8 piece parklight, taillight, brake & backup	2DR 4DR HTP 2DR SDN CNV SWG	60 Chevrolet Biscayne Bel Air Impala	2177
G		60	Taillight, housing to body seals	2DR 4DR HTP 2DR SDN CNV SWG	60 Chevrolet Impala Biscayne Bel Air	21772
G		60-63-64-69-70	Door handle & lock gaskets	2DR 4DR HTP 2DR SDN CNV SWG	60 Chevrolet Biscayne, Impala, Bel Air, Cadillac, Oldsmobile 89 Oldsmobile 98, Buick LeSabre, Invicta, Electra, Wild Cat, Pontiac Catalina, Star Chief, Bonneville, Grand Prix, Ventura	2098
G		61	Steering column dust cover	2DR 4DR HTP 2DR SDN CNV SWG	61 Chevrolet Biscayne Bel Air Impala	2115
G		61	Lens gasket kit 8 piece parklight, taillight, brake & backup	2DR 4DR HTP 2DR SDN CNV SWG	61 Chevrolet Biscayne Bel Air Impala	2178
G		61	Taillamp housing to body seal	2DR 4DR HTP 2DR SDN CNV SWG	61 Chevrolet Impala Biscayne Bel Air	21781
G		61	Inner taillamp housing seals	2DR 4DR HTP 2DR SDN CNV SWG	61 Impala Bel Air Impala Biscayne	21782
G		61-62	Antenna gasket right, rear	2DR 4DR HTP 2DR SDN CNV SWG	61-62 Chevrolet Biscayne Bel Air Impala	2124
G		61-62	Antenna gasket left rear	2DR SDN 2DR 4DR HTP CNV SWG	61-62 Chevrolet Biscayne, Bel Air, Impala	2125















GUIDE TO SOFFSEAL'S PRODUCT CODES

B = Bumper sets **C** = Glass channels **D** = Door related **G** = Seals, gaskets **H** = Under hood items **I** = Interior parts
M = Miscellaneous items **R** = Roofrail, pillar post & convertible items **T** = Trunk related **W** = Window related **Z** = Weatherstrip kits



CODE	IMAGE	YEAR	DESCRIPTION	BODY	FITS	ITEM#
G		61-62	Heater box kit non a/c 7 piece	2DR 4DR HTP 2DR SDN CNV SWG	61-62 Chevrolet Impala Biscayne Bel Air	2112
G		61-62	Cowl panel to cowl filler gasket	2DR 4DR HTP 2DR SDN CNV SWG	61-62 Chevrolet Biscayne Bel Air Impala	2061
G		61-62-63-64	Steering column outer seal standard shift only	2DR 4DR HTP 2DR SDN CNV SWG	61-64 Chevrolet Biscayne Bel Air Impala	2113
G		61-62-64	Steering column outer seal automatic	2DR 4DR HTP 2DR SDN CNV SWG	61-64 Chevrolet Biscayne Bel Air Impala	2114
G		61-62-65-66-67-68	Door handle & lock gaskets	2DR 4DR HTP 2DR SDN CNV SWG	61-62 Chevrolet Biscayne, Bel Air, Impala, Cadillac, Oldsmobile 88 Oldsmobile 98, Buick LeSabre, Invicta, Electra, Pontiac	2145
G		61-62-63-64	License plate light lens gasket	2DR 4DR HTP 2DR SDN CNV SWG	61-64 Chevrolet Bel Air Biscayne Impala	2307
G		61-62-63-64-65	Outside mirror gasket	2DR 4DR HTP 2DR SDN CNV SWG	61-65 Chevrolet 68-69 Chevelle Malibu El Camino 63-64 Impala Biscayne Bel Air	2306
G		62	Lens gasket kit 8 piece parklight, taillight, brake & backup	2DR 4DR HTP 2DR SDN CNV SWG	62 Chevrolet Biscayne Bel Air Impala	2173
G		62	Outer rear bumper seals	2DR 4DR HTP 2DR SDN CNV SWG	62 Chevrolet Biscayne Bel Air Impala	2160
G		62	Inner taillamp housing seals	2DR 4DR HTP 2DR SDN CNV SWG	62 Chevrolet Impala Bel Air Impala	21783
G		62	Park lens gaskets	2DR 4DR HTP 2DR SDN CNV SWG	62 Chevrolet Biscayne Bel Air Impala	2165
G		62	Taillight gasket	2DR 4DR HTP 2DR SDN CNV SWG	62 Chevrolet Full Size Only	2166
G		62-63	Tail lamp to body seals	2DR 4DR HTP 2DR SDN CNV SWG	62-63 Chevrolet Biscayne Bel Air Impala	2170
G		62-63-64	Steering column dust cover	2DR 4DR HTP 2DR SDN CNV SWG	62-64 Chevrolet Biscayne Bel Air Impala	21151

Chevrolet • Biscayne

CODE	IMAGE	YEAR	DESCRIPTION	BODY	FITS	ITEM#
G		63	Park lens gaskets	2DR 4DR HTP 2DR SDN CNV SWG	63 Chevrolet Biscayne Bel Air Impala	2167
G		63	Tail lens gaskets	2DR 4DR HTP 2DR SDN CNV SWG	63 Chevrolet Biscayne Bel Air Impala	21671
G		63	Inner taillamp housing seals	2DR 4DR HTP 2DR SDN CNV SWG	63 Impala Bel Air Biscayne	21784
G		63	Lens gasket kit 8 piece parklight, taillight, brake & backup	2DR 4DR HTP 2DR SDN CNV SWG	63 Chevrolet Biscayne Bel Air Impala	2174
G		63	Rear body to bumper seal	2DR 4DR HTP 2DR SDN CNV SWG	63 Chevrolet Biscayne Bel Air Impala	2201
G		63-64-65	Heater to firewall gasket under dash non a/c	2DR 4DR SDN HTP CNV	63-65 Chevrolet Impala Bel Air Biscayne	2513
G		64	Rear bumper to body seal	2DR 4DR HTP 2DR SDN CNV SWG	64 Chevrolet Biscayne Bel Air Impala	2197
G		64	Lens gasket kit 8 piece parklight, taillight, brake & backup	2DR 4DR HTP 2DR SDN CNV SWG	64 Chevrolet Biscayne Bel Air Impala	2175
G		64	Park light lens gaskets	2DR 4DR HTP 2DR SDN CNV SWG	64 Chevrolet Biscayne Bel Air Impala Chevelle El Camino Malibu	2168
G		64	Park lamp housing gaskets	2DR 4DR HTP 2DR SDN CNV SWG	64 Chevrolet Biscayne Bel Air Impala	2169
G		64	Tail lens gaskets	2DR 4DR HTP 2DR SDN CNV SWG	64 Chevrolet Biscayne Bel Air Impala	2171
G		64	Taillight, housing to body seal	2DR 4DR HTP 2DR SDN CNV SWG	64 Chevrolet Biscayne Bel Air Impala	21711
G		65-66	Outside mirror gasket without remote	2DR 4DR HTP 2DR SDN CNV SWG	65-66 Chevrolet Bel Air Biscayne Impala	2304
G		65-66	Steering column seal fits all	2DR 4DR HTP 2DR SDN CNV SWG	65-66 Chevrolet Impala Biscayne Caprice Bel Air	2405
G		65-66-67	Cowl vent panel to cowl seals	2DR 4DR SDN HTP CNV	65-67 Chevrolet All	2340



GUIDE TO SOFFSEAL'S PRODUCT CODES

B = Bumper sets **C** = Glass channels **D** = Door related **G** = Seals, gaskets **H** = Under hood items **I** = Interior parts
M = Miscellaneous items **R** = Roofrail, pillar post & convertible items **T** = Trunk related **W** = Window related **Z** = Weatherstrip kits

Chevrolet • Biscayne



CODE	IMAGE	YEAR	DESCRIPTION	BODY	FITS	ITEM#
G		65-66-67-68-69-70-71-72-73-74-75-76-77-78-79	Mirror gasket	2DR 4DR HTP 2DR SDN CNV SWG	68-69 Chevrolet 65-66 Bel Air Biscayne Impala 67-79 Chevrolet Camaro 66-72 Nova 66-72 Chevelle 70 El Camino 67-68 Pontiac Firebird	2305
G		66-67-68-69-70-71-72	License light gasket	2DR 4DR HTP SDN CNV SWG	66-72 Chevy II Nova, Biscayne, Bel Air, Impala, Chevelle, 67-72 Chevrolet Camaro, Pontiac Firebird	2378
G		67	Park light lens gaskets	2DR SDN 2DR 4DR HTP CNV SWG	67 Chevrolet Impala Bel Air Caprice Biscayne	2382
G		67	Rear bumper to body seal	2DR SDN 2DR 4DR HTP CNV SWG	67 Chevrolet Biscayne Bel Air Impala Caprice	2346
G		67-68	Steering column seal fits all	2DR 4DR HTP 2DR SDN CNV SWG	67-68 Chevrolet Impala Biscayne Caprice Bel Air	2406
G		68	Park lens gaskets	2DR SDN 2DR 4DR HTP CNV SWG	68 Chevrolet Impala Biscayne Bel Air	2384
G		68	Rear side marker light	2DR 4DR HTP SWG CNV	68 Chevrolet All	23841
G		68	Front side marker gaskets	2DR 4DR HTP SWG CNV	68 Chevrolet All	23842
G		68	Rear body to bumper seal	2DR 4DR HTP 2DR SDN CNV SWG	68 Chevrolet Impala Biscayne Caprice Bel Air	2408
G		69-70	Steering column seal	2DR 4DR HTP 2DR SDN CNV SWG	69-70 Chevrolet Impala Biscayne Caprice Bel Air	2402
G		70	Taillight lens gaskets	2DR 4DR HTP CNV	70 Chevrolet Impala	2389
G		70	Park light lens gaskets	2DR 4DR HTP SWG CNV	70 Chevrolet	23891
H		58	Hood insulation	2DR 4DR HTP 2DR SDN CNV SWG	58 Chevrolet Del Ray Biscayne Bel Air Impala	21451
H		58	Hood to fender bumpers	2DR 4DR SDN HTP CNV	58 Chevrolet	2086
H		58-59-60	Hood to cowl seal	2DR 4DR HTP 2DR SDN CNV SWG	58-60 Chevrolet Del Ray Biscayne Impala Bel Air	2060

Chevrolet • Biscayne

CODE	IMAGE	YEAR	DESCRIPTION	BODY	FITS	ITEM#
H		59	A-arm seals without clips	2DR 4DR HTP 2DR SDN CNV SWG	59 Chevrolet Biscayne Bel Air Impala	2101
H		59-60	Hood insulation	2DR 4DR HTP 2DR SDN CNV SWG	59-60 Chevrolet Biscayne Bel Air Impala	21452
H		60	A-arm seals without clips	2DR 4DR HTP 2DR SDN CNV SWG	60 Chevrolet Biscayne, Biscane Fleetmaster, Bel Air, Impala, Brookwood, Parkwood, Kingswood, Nomad, El Camino	2100
H		61	A-arm seals with staples	2DR 4DR HTP 2DR SDN CNV SWG	61 Chevrolet Biscayne Bel Air Impala	2111
H		61	Hood insulation	2DR 4DR HTP 2DR SDN CNV SWG	61 Chevrolet Biscayne Bel Air Impala	2146
H		61-62	Hood to cowl seal	2DR 4DR HTP 2DR SDN CNV SWG	61-62 Chevrolet Biscayne Bel Air Impala	2130
H		62	Hood insulation	2DR 4DR HTP 2DR SDN SWG CNV	62 Chevrolet Biscayne Bel Air Impala	2147
H		62-63-64	A-arm seals with staples	2DR 4DR HTP 2DR SDN CNV SWG	62-64 Chevrolet Biscayne Bel Air Impala	2183
H		63	Hood insulation	2DR 4DR HTP 2DR SDN SWG CNV	63 Chevrolet Biscayne Bel Air Impala	2148
H		63-64	Hood to cowl seal	2DR 4DR HTP 2DR SDN CNV SWG	63-64 Chevrolet Impala Biscayne Bel Air	2192
H		64	Hood insulation	2DR 4DR HTP 2DR SDN SWG CNV	64 Chevrolet Biscayne Bel Air Impala	2149
H		64-65-66-67-68-69-70-71-72	Firewall wiring gutter plk	2DR 4DR HTP 2DR SDN SWG CNV	Chevy Chevelle, Biscayne, Bel Air, Impala, Caprice, Nova, Camaro, Cadillac Calais, Deville, Fleetwood, Oldsmobile 88, 98, Jetstar, Starfire, Pontiac Catalina, Bonneville, Firebird, Buick Lesabre, Wildcat, Electra	2328
H		65	A-arm seals with staples	2DR SDN 2DR 4DR HTP CNV SWG	65 Chevrolet Biscayne Bel Air Impala	2324
H		65-66-67	Hood to cowl seal	2DR SDN 2DR 4DR HTP CNV SWG	65-67 Chevrolet Biscayne Bel Air Impala	2330



GUIDE TO SOFFSEAL'S PRODUCT CODES







B = Bumper sets **C** = Glass channels **D** = Door related **G** = Seals, gaskets **H** = Under hood items **I** = Interior parts
M = Miscellaneous items **R** = Roofrail, pillar post & convertible items **T** = Trunk related **W** = Window related **Z** = Weatherstrip kits

Chevrolet • Biscayne



CODE	IMAGE	YEAR	DESCRIPTION	BODY	FITS	ITEM#
H		66	A-arm seals with staples	2DR 4DR HTP CNV	66 Chevrolet Biscayne Bel Air Impala	2325
H		67	Hood insulation with clips	2DR 4DR HTP 2DR SDN CNV SWG	67 Chevrolet Biscayne Bel Air Impala Caprice	2391
H		67-68	A-arm seals with staples	2DR 4DR HTP CNV	67-68 Chevrolet Biscayne Bel Air Impala	2326
H		69-70	A-arm seals with staples	2DR 4DR HTP CNV	69-70 Chevrolet Biscayne Bel Air Impala	2327
H		69-70	Hood insulation with clips	2DR 4DR HTP 2DR SDN CNV SWG	69-70 Chevrolet Impala Biscayne Caprice Bel Air	2403
H		71-72-73-74-75-76- 77-78	Hood to cowl seal	2DR SDN 2DR HTP CNV SWG	71-78 Chevrolet Impala, Caprice, Biscayne, Bel Air, Brookwood, Townsmen, Kingswood, Buick Lesabre, Centurion, Electra 225, Estate Wagon, Cadillac Calais, Deville, Eldorado, Sixty Special Brougham, Oldsmobile 88, 98, Tornado, Pontiac Catalina, Bonneville, Grandville, Safari Full Size	2191
I		55-56-57-61-62- 63-64	Glove box arm grommet	2DR 4DR HTP 2DR SDN CNV SWG	55-57 And 61-64 Chevrolet, Pontiac, Oldsmobile All	10691
I		58	Gear shift grommet column	2DR 4DR SDN HTP CNV	58 Chevrolet Del Ray, Biscayne, Bel Air, Impala, Cadillac, Oldsmobile 88 Oldsmobile 98, Buick Special, Century, Roadmaster, Riviera, Pontiac	2185
I		58-59-60-61-62- 63-64	Emergency brake pedal pad with inverted letter	2DR 4DR HTP 2DR SDN CNV SWG	58-64 Chevrolet Del Ray Biscayne Bel Air Impala	2067
I		58-59-60-61-62- 63-64-65-66-67	Accelerator pedal	2DR 4DR HTP 2DR SDN CNV SWG	58-67 Chevrolet Del Ray Biscayne Bel Air Impala Caprice, 62-67 Chevy II	2068
I		59-60-61-62-63- 64-65-66	Gear shift grommet column	2DR 4DR SDN HTP CNV	59-66 Chevrolet Biscayne, Bel Air, Impala, 59-66 Cadillac, 59-63 Oldsmo- bile 88 Oldsmobile 98, 61 Starfire, 64-66 Starfire, Jet Star, 59-66 Buick LeSabre, Invicta, Electra, 63 Wildcat, Riviera, 59-66 Pontiac	2185A
I		60-61-62-63	Shift boot 4-speed bench seat	2DR 4DR HTP 2DR SDN CNV SWG	60-63 Chevrolet Biscayne Bel Air Impala	2105
I		61-62	Instrument panel dash seal rubber	2DR 4DR HTP 2DR SDN CNV SWG	61-62 Chevrolet Biscayne Bel Air Impala	2076
I		62	Shift boot 4-speed ss, with console	2DR 4DR HTP 2DR SDN CNV SWG	62 Chevrolet Biscayne Bel Air Impala	2104

Chevrolet • Biscayne

CODE	IMAGE	YEAR	DESCRIPTION	BODY	FITS	ITEM#
I		62-63-64-65-66-67-68-69-70-71	Accelerator pedal hp with deluxe trim	2DR 4DR HTP 2DR SDN CNV SWG	62-71 Chevrolet Biscayne Bel Air Impala, 64-67 Chevelle, 70-71 Camaro Hi Perfor, 64-67 Buick Special-Skylark El Camino, 64-65 Pontiac A Body	2069
I		63-64	Dash mounted tach housing seal	2DR 4DR HTP 2DR SDN CNV SWG	63-64 Chevrolet Biscayne Bel Air Impala	2199
I		64	Shift boot 4-speed with console, upper	2DR 4DR HTP 2DR SDN CNV SWG	64 Chevrolet Biscayne Bel Air Impala	2107
I		64	Shift boot ss lower	2DR 4DR HTP 2DR SDN CNV SWG	64 Chevrolet Biscayne Bel Air Impala	2109
I		64-65-66-67	Automatic console slider	2DR 4DR HTP 2DR SDN CNV SWG	64-67 Chevy II, Nova, Chevelle, Biscayne, Bel Air, Impala, 67 Chevrolet Camaro	2108
I		65-66-67-68-69-70	Accelerator pedal pad trim fit part 2069	2DR 4DR HTP SDN SWG CNV	65-70 Chevrolet Biscayne, Bel Air, Impala, Caprice, 2 Door 4 Door Hardtop Sedan Station Wagon Convertible	2069A
I		65-66-67-68-69-70	Parking brake pedal pad	2DR SDN 2DR 4DR HTP CNV SWG	65-70 Chevrolet Biscayne, Bel Air, Impala, Caprice	20671
I		65-66-67-68-69-70	Deluxe clutch & brake pad	2DR 4DR HTP 2DR SDN CNV SWG	65-70 Chevrolet Biscayne, Bel Air, Impala	20641
I		65-66-67-68-69-70	Deluxe manual brake & clutch pedal pad trim fits part 20641	2DR SDN 2DR 4DR HTP CNV SWG	65-70 Chevrolet Bel Air Biscayne Impala	20641A
I		65-66-67-68-69-70	Automatic brake pedal pad with disc brakes	2DR SDN 2DR 4DR HTP CNV SWG	65-70 Chevrolet Biscayne, Bel Air, Impala, Caprice	20642
I		65-66-67-70	Deluxe automatic brake pad trim fits part 2064	2DR SDN 2DR 4DR HTP CNV SWG	65-70 Chevrolet Biscayne, Bel Air, Impala	2064A
M		55-56-57-59-60-61	Gear tube grommet	2DR 4DR HTP SDN CNV SWG	55-57 And 59-60 Chevrolet Pontiac, Oldsmobile, 60-61 Chevrolet Truck, Gmc Truck, 2 Door 4 Door Hardtop Sedan Convertible Station Wagon	1095
M		57-58-59-60-61-62-63-64-65-66-67-68-69-70-71-72-73-74-75-76-77-78-79-80-81	Bellhousing to clutch fork rubber boot	2DR 4DR HTP SDN CNV SWG	57-81 GM All Manual Transmission	2196
M		58-59-60-61-62-63-64-65	Automatic power brake pad	2DR 4DR HTP SDN CNV SWG	58-65 Chevrolet Del Ray Biscayne Bel Air, 62-67 Chevy II Nova Caprice, 63-67 Corvette, 2 Door 4 Door Hardtop Sedan Convertible Station Wagon	2063











GUIDE TO SOFFSEAL'S PRODUCT CODES

B = Bumper sets **C** = Glass channels **D** = Door related **G** = Seals, gaskets **H** = Under hood items **I** = Interior parts
M = Miscellaneous items **R** = Roofrail, pillar post & convertible items **T** = Trunk related **W** = Window related **Z** = Weatherstrip kits



CODE	IMAGE	YEAR	DESCRIPTION	BODY	FITS	ITEM#
M		58-59-60-61-62-63-64-65	Power brake pedal pad with standard trans	2DR 4DR HTP SDN CNV SWG	58-65 Full-Size Chevrolet Biscayne Bel Air Impala Caprice, 58-62 Corvette, 58 Del Ray, 2 Door 4 Door Hardtop Sedan Convertible Station Wagon	20651
M		58-59-60-61-62-63-64-65-66-67	Standard brake & clutch pedal pads	2DR 4DR HTP 2DR SDN CNV SWG	58-67 Chevrolet Del Ray Biscayne Bel Air Impala, 62-67 Chevy II, Nova Caprice 58-62 Corvette	2065
M		58-59-60-61-62-63-64-65-66-67-68-69	Automatic brake pad with out power brakes	2DR 4DR HTP SDN CNV SWG	58-69 Chevrolet Biscayne Bel Air Impala, 63-67 Corvette 62-67 Chevy II, 65-69 Corvair, 2 Door 4 Door Hardtop Sedan Convertible Station Wagon	2066
M		59	Body mounts	2DR 4DR HTP 2DR SDN SWG	59 Chevrolet Biscayne Bel Air Impala, Except Convertible	2070
M		60-61-62-63-64	Frame to body mount kit	2DR 4DR HTP SDN CNV SWG	60-64 Chevrolet Biscayne Bel Air Impala, 2 Door 4 Door Hardtop Sedan Convertible Station Wagon	2110
M		61-62	Bellhousing fork boot	2DR 4DR HTP SDN CNV SWG	61-62 Chevrolet Biscayne, Bel Air, Impala, 61-62 Cadillac, 61-62 Oldsmobile, 61-62 Buick, 61-62 Buick, 2 Door 4 Door Hardtop Sedan Convertible Station Wagon	2198
M		61-62	Windshield post drain gutters	2DR 4DR HTP SDN CNV SWG	61-62 Chevrolet Biscayne Bel Air Impala, 2 Door 4 Door Hardtop Sedan Convertible Station Wagon	21614
M		61-62-63-64	Frame to body mount bolt kit	2DR 4DR HTP 2DR SDN	61-64 Chevrolet Biscayne Bel Air Impala, 2 Door 4 Door Hardtop Sedan	2110A
M		63-64	Firewall pad	2DR 4DR HTP SDN CNV SWG	63-64 Chevrolet Biscayne Bel Air Impala, 2 Door 4 Door Hardtop Sedan Convertible Station Wagon	21724
M		65-66	Body mount bolt kit	2DR HTP 2DR SDN	65-66 Chevrolet Impala Caprice Bel Air Biscayne, 2 Door Hardtop, Sedan	2398
M		65-66	Body mount kit	2DR HTP 2DR SDN	65-66 Chevrolet Impala Caprice, Biscayne, Bel Air, 2 Door Hardtop, Sedan	2392
M		66-67-68	Radiator support bushings & hardware kit	2DR 4DR HTP SDN CNV SWG	66-68 Chevrolet Biscayne Impala Caprice Bel Air, 2 Door 4 Door Hardtop Sedan Convertible Station Wagon	2407
M		67-68	Body mount bolt kit	2DR HTP 2DR SDN CNV	67-68 Chevrolet Impala Caprice Bel Air Biscayne, 2 Door Hardtop Sedan Convertible	2400
M		67-68	Body mount kit	2DR HTP 2DR SDN	67-68 Chevrolet Impala Caprice Bel Air Biscayne, 2 Door Hardtop, Sedan	2394
M		69-70	Body mount bolt kit	2DR HTP SDN CNV	69-70 Chevrolet Impala Caprice Bel Air Biscayne, 2 Door Hardtop Sedan Convertible	2401

Chevrolet • Biscayne

CODE	IMAGE	YEAR	DESCRIPTION	BODY	FITS	ITEM#
T		58-59-60-61-62-63-64-65-66-67-68-69	Trunk weatherstrip exact profile	2DR 4DR HTP 2DR SDN CNV	58-64 Chevrolet Biscayne, 58-64 Chevrolet Bel Air, Chevrolet Impala, 60-69 Chevrolet Corvair, 59-64 Pontiac Parisienne, 59-64 Pontiac Catalina, 59-64 Pontiac Star Chief, 60-61 Pontiac Ventura, 62-64 Pontiac Grand Prix, 58-64 Oldsmobile Delta 88, 58-64 Oldsmobile Dynamic 88, Oldsmobile Super 88, Oldsmobile Super 98, 61-64 Oldsmobile Starfire, 64 Oldsmobile Jetstar, 59-64 Buick LeSabre, 59-62 Buick Invicta, 59-64 Buick Electra, 62-64 Buick Wildcat, 63-65 Buick Riviera, 58-60 Cadillac Deville, Cadillac Eldorado, Cadillac Series 62, Cadillac Series 60 Special, Cadillac Series 75, 58-64 C-Body	2001
T		62-63-64	Trunk mat, sport coupe	2DR HTP 2DR SDN	62-64 Chevrolet Biscayne Bel Air Impala	2186
T		64-65-66-67-68-69-70-71-72-73-74-75-76-77	Trunk weatherstrip exact profile length 17 feet	2DR 4DR HTP 2DR SDN CNV	65-72 Chevy II, 65-72 Chevrolet Biscayne, 65-75 Chevrolet Bel Air, 65-76 Chevrolet Impala, 65-76 Chevrolet Caprice, 64-77 Chevrolet Chevelle, 70-77 Chevrolet Monte Carlo, 65-76 Buick LeSabre, 64-77 Buick Wildcat, 64-77 Buick Skylark, 71-73 Buick Centurion, 64-72 Buick Grand Special, 73-77 Buick Century, 73-88 Buick Regal, 73-88 Buick Grand National, 65-76 Buick Electra, 65-76 Oldsmobile Delta 88, 67-69 Oldsmobile Delmont 88, 65-66 Oldsmobile Dynamic 88, 65-66 Oldsmobile Starfire, 65 Oldsmobile Jetstar, 64-77 Oldsmobile Cutlass 442, 64-88 Oldsmobile Cutlass, 65-76 Oldsmobile 98, 65-76 Pontiac Parisienne, 64-72 Pontiac LeMans, 65-70 Pontiac Catalina, 65-66 Pontiac Star Chief, 67-70 Pontiac Executive, 71-75 Pontiac Grand Ville, 65-77 Pontiac Grand Prix, 64-72 Pontiac Tempest, 62-72 Nova, Ventura, 73-74 Non-Hatchback, Up to 1975 with groove channel, Apollo, Nova, Omega, Ventura 65-76 C-Body	2003
W		59-60	Rear quarter stationary vent window seals	4DR SDN	59-60 Chevrolet Buick, Style 4419, 4619, 4719 Oldsmobile, Pontiac 4 Door Sedan	2053
W		59-60	Window weatherstrip replacement style	2DR SDN	59-60 Chevrolet Biscayne, Bel Air, 2 Door Sedan	20961
W		61-62-63-64-65-66	Horizontal outer window seals	2DR 4DR HTP SDN CNV SWG	Chevy Biscayne, Bel Air, Impala, Caprice, Cadillac series 62 Deville, Eldorado, Fleetwood, Calais, Oldsmobile 88, Starfire, 98. Buick LeSabre, Invicta, Wildcat, Electra, Pontiac Catalina, Ventura, Star Chief, Bonneville	2310
W		65-66-67-68	Vent window weatherstrip	2DR SDN SWG 4DR	65-68 2 Door 4 Door Sedan And Station Wagon	2284
W		65-66-67-68-69	Doorglass run channel, upper & rear	2DR SDN	65-72 Chevrolet Pontiac, 2 Door Sedan	2517



GUIDE TO SOFFSEAL'S PRODUCT CODES





B = Bumper sets **C** = Glass channels **D** = Door related **G** = Seals, gaskets **H** = Under hood items **I** = Interior parts
M = Miscellaneous items **R** = Roofrail, pillar post & convertible items **T** = Trunk related **W** = Window related **Z** = Weatherstrip kits

Chevrolet • Brookwood, Kingswood



CODE	IMAGE	YEAR	DESCRIPTION	BODY	FITS	ITEM#
C		59-60	Rear quarter stationary vent window seal	SWG 2DR 4DR	59-60 Chevrolet Nomad, Brookwood, Kingswood, Buick LeSabre, Invicta, Oldsmobile Fiesta 88, Pontiac Catalina, Bonneville, Safari 2 Door 4 Door Station Wagon	2218
D		59-60	Door j weatherstrip	2DR 4DR HTP SWG 2DR SDN 4DR SDN	59-60 Chevrolet, Pontiac, Oldsmobile, Buick, Cadillac	2093
D		61-62	Door weatherstrip front with clips	SWG 4 DR SDN	61-62 Chevrolet BelAir, Biscayne, Impala, Pontiac, Station Wagon & 4 Dr Sedan	2019
D		71-72-73-74	Door weatherstrip rear with clips & molded ends	4DR SDN	71-74 Chevrolet Impala, Bel Air, Biscayne, Brookwood, Townsman, Kingswood, Buick Estate Station Wagon, Pontiac Catalina, Grand Safari, Bonneville, Oldsmobile Custom Cruiser, 4 Door Sedan	2225
D		71-72-73-74-75-76	Door weatherstrip rear with clips & molded ends	SWG 4DR	71-76 Chevrolet Bel Air, Caprice, Impala, Brookwood, Townsman, Kingswood, Oldsmobile Custom Cruiser, Pontiac Grand Safari, Buick Estate Wagon, 4 Door Station Wagon	2227
D		71-72-73-74-75-76	Door weatherstrip front with clips & molded ends	4DR SWG	71-76 Chevrolet Impala, Bel Air, Biscayne, Brookwood, Townsman, Kingswood, Buick Estate Station Wagon, Pontiac Catalina, Grand Safari, Bonneville, Oldsmobile Custom Cruiser, 4 Door Station Wagon	2228
D		75-76	Door weatherstrip rear with clips & molded ends	4DR SDN	75-76 Chevrolet Impala, Bel Air, Brookwood, Townsman, Kingwood, Buick Estate Station Wagon, Pontiac Catalina, Grand Safari, Bonneville, Oldsmobile Custom Cruiser, 4 Door Sedan	2226
G		56-58	Rear body to bumper seal	2DR 4DR HTP 2DR SDN CNV SWG	56, 58 Chevrolet	1090
G		57-58-59-60	Inner to outer fender seals	2DR 4DR HTP 2DR SDN CNV SWG	57-60 Chevrolet	1103
G		58	Steering column seal with automatic trans	2DR 4DR HTP 2DR SDN CNV SWG	58 Chevrolet Pontiac	2056
G		58	Steering column seal sponge	2DR 4DR HTP 2DR SDN CNV SWG SR	58 Chevrolet Pontiac, Universal Fit Street Rod And Custom, Standard Transmission	2056A
G		58	Door handle & lock gaskets	2DR 4DR HTP 2DR SDN SWG CNV	58 Chevrolet Pontiac	2059
G		59	Door handle & lock gaskets	2DR 4DR HTP 2DR SDN CNV SWG	59 Chevrolet Pontiac	2073

Chevrolet • Brookwood, Kingswood

CODE	IMAGE	YEAR	DESCRIPTION	BODY	FITS	ITEM#
H		58	Hood to fender bumpers	2DR 4DR SDN HTP CNV	58 Chevrolet	2086
H		60	A-arm seals without clips	2DR 4DR HTP 2DR SDN CNV SWG	60 Chevrolet Biscayne, Biscane Fleet-master, Bel Air, Impala, Brookwood, Parkwood, Kingswood, Nomad, El Camino	2100
H		71-72-73-74-75-76-77-78	Hood to cowl seal	2DR SDN 2DR HTP CNV SWG	71-78 Chevrolet Impala, Caprice, Biscayne, Bel Air, Brookwood, Townsman, Kingswood, Buick Lesabre, Centurion, Electra 225, Estate Wagon, Cadillac Calais, Deville, Eldorado, Sixty Special Brougham, Oldsmobile 88, 98, Tornado, Pontiac Catalina, Bonneville, Grandville, Safari Full Size	2191
I		55-56-57-61-62-63-64	Glove box arm grommet	2DR 4DR HTP 2DR SDN CNV SWG	55-57 And 61-64 Chevrolet, Pontiac, Oldsmobile All	10691
M		55-56-57-59-60-61	Gear tube grommet	2DR 4DR HTP SDN CNV SWG	55-57 And 59-60 Chevrolet Pontiac, Oldsmobile, 60-61 Chevrolet Truck, Gmc Truck, 2 Door 4 Door Hardtop Sedan Convertible Station Wagon	1095



GUIDE TO SOFFSEAL'S PRODUCT CODES

B = Bumper sets **C** = Glass channels **D** = Door related **G** = Seals, gaskets **H** = Under hood items **I** = Interior parts
M = Miscellaneous items **R** = Roofrail, pillar post & convertible items **T** = Trunk related **W** = Window related **Z** = Weatherstrip kits



CODE	IMAGE	YEAR	DESCRIPTION	BODY	FITS	ITEM#
B		47-48-49-50-51-52-53-54-55-56-57-58-59-60-61-62-63-64-65-66-67-68-69-70-71-72-73-74-75-76-77-78-79-80-81-82-83-84-85-86-87	Glove box door bumpers	2DR 4DR HTP 2DR SDN CNV SWG TRK	All Chevrolet, Pontiac, Oldsmobile, Buick 47-87 Chevrolet, Gmc Truck	1069
B		56-57-58-59-60-61-62-63-64-65-66-67-68-69-70-71-72-73-74	Hood adjustment bumpers round	2DR 4DR HTP 2DR SDN CNV SWG	56-74 Chevrolet, Pontiac, All Models	1222
B		58-59-60-61-62-63-64-65-66-67-68	Trunk bumpers	2DR 4DR HTP 2DR SDN CNV SWG	58-64 Chevrolet, Pontiac, Oldsmobile, Buick, Cadillac, 67-68 Pontiac Firebird, Chevrolet Camaro	2322
B		62-63-64-65-66-67-68-69-70-71-72-73-74-75	Trunk bumpers	2DR HTP 2DR SDN CNV	70-75 Chevrolet Camaro, Pontiac Firebird, 62-73 Chevy II Nova, 64-72, Pontiac GTO, Tempest, Le Mans, Chevrolet Chevelle, Monte Carlo, Buick Skylark, Oldsmobile Cutlass, 65-69 Chevrolet Corvair, 65-70 Full Size Chevrolet	3112
B		65-66-67-68-69-70-71-72-73-74-75-76-77-78-79-80-81-82-83-84-85-86-87-88-89-90-91-92-93-94-95-96-97-98-99-00-01-02	Door bumpers	2DR 4DR HTP 2DR SDN SWG CNV	65-66 Chevrolet, Pontiac, Oldsmobile, Buick, 65-69 Corvair, 70-02 Chevrolet Camaro, Pontiac Firebird, 68-81 Chevelle, GTO, Cutlass, Skylark, 68-72 El Camino, Tempest, LeMans GTO, 70-72 Monte Carlo	2321
B		67	Fold down seat bumper	2DR HTP CNV	67 Chevrolet Camaro, Pontiac Firebird 2 Door Hardtop Convertible	30702
B		67-68	Bumper kit, includes: doors hood trunk glove console	2DR HTP CNV	67-68 Chevrolet Camaro 2 Door Hardtop Convertible	3058
B		67-68-69	Bucket seat bumpers	2DR HTP CNV	67-69 Chevrolet Camaro, Pontiac Firebird 2 Door Hardtop Convertible	3070
B		67-68-69	Door bumpers	2DR HTP CNV	67-69 Chevrolet Camaro, Pontiac Firebird 2 Door Hardtop Convertible	31101
B		67-68-69	Bumper kit convertible top	CNV	67-69 Chevrolet Camaro, Pontiac Firebird Convertible	30431
B		67-68-69-70-71-72	Rubber ash tray bumpers 2 per car	2DR HTP CNV	67-72 Chevrolet Camaro, Pontiac Firebird 2 Door Hardtop Coupe Convertible	3057
B		67-68-69-70-71-72-73-74-75-76-77	Hood side bumper, 2 pr. required	2DR HTP CNV 2DR SDN SWG	67-69 Chevrolet Camaro Chevelle, 73-77 Monte Carlo,	3024
B		68-69	Headlight door bumpers	2DR HTP CNV	68-69 Chevrolet Camaro RS Only 2 Door Hardtop Convertible	3048
B		68-69	Fold down seat bumper	2DR HTP CNV	68-69 Chevrolet Camaro, Pontiac Firebird 2 Door Hardtop Convertible	30701

Chevrolet • Camaro

CODE	IMAGE	YEAR	DESCRIPTION	BODY	FITS	ITEM#
B		69	Bumper kit	2DR HTP CNV	69 Chevrolet Camaro 2 Door Hardtop Convertible	30581
B		69	Trunk bumpers	2DR HTP CNV	69 Chevrolet Camaro, Pontiac Firebird 2 Door Hardtop Convertible	3113
B		69	License panel bumpers rear	2DR 4DR SDN HTP CNV	69 Chevrolet Camaro, Pontiac Firebird, 64-72 Chevrolet Chevelle, Pontiac Tempest, LeMans, GTO, Grand Prix, Oldsmobile Cutlass, Buick Special, Skylark	31151
B		70-71-72-73-74-75-76-77-78-79-80-81	Bumper kit, includes: doors hood trunk glove console	2DR HTP CNV	70-81 Chevrolet Camaro Coupe	3059
B		70-71-72-73-74-75-76-77-78-79-80-81	Hood side bumpers 4 per car	2DR HTP	70-81 Chevrolet Camaro, Pontiac Firebird 2 Door Hardtop Coupe	30241
D		67	Door weatherstrip with clips & molded ends	2DR HTP CNV	67 Chevrolet Camaro, Pontiac Firebird 2 Door Hardtop Convertible	3000
D		68-69	Door weatherstrip with clips & molded ends	2DR HTP CNV	68-69 Chevrolet Camaro, Pontiac Firebird, 2 Door Hardtop Convertible	3010
D		70-71-72-73-74-75-76-77-78-79-80-81	Door weatherstrip with clips & molded ends	2DR CPE	70-81 Chevrolet Camaro, Pontiac Firebird, F-Body, 2 Door Coupe	3015
D		82-83-84-85-86-87-88-89-90-91-92	Door weatherstrip with clips & molded ends	2DR CPE	82-92 Chevrolet Camaro, Pontiac Firebird, 2 Door Coupe	3016
D		93-94-95-96-97-98-99-00-01-02	Bottom of Door Seal	2DR CNV T-TOP	93-02 Chevrolet Camaro, 93-02 Pontiac Firebird	3202
D		93-94-95-96-97-98-99-00-01-02	Top of door seal front	2DR CNV T-TOP	93-02 Chevrolet Camaro, 93-02 Pontiac Firebird	3203
D		93-94-95-96-97-98-99-00-01-02	Top of Door Seal, Rear	2DR CNV T-TOP	93-02 Chevrolet Camaro, 93-02 Pontiac Firebird	3204
D		93-94-95-96-97-98-99-00-01-02	Header / Front of door seal	2DR CNV	93-02 Chevrolet Camaro, 93-02 Pontiac Firebird	3206
D		93-94-95-96-97-98-99-00-01-02	Rear of door seal	2DR CNV	93-02 Chevrolet Camaro, 93-02 Pontiac Firebird	3207
D		93-94-95-96-97-98-99-2000-2001-2002	Door Weatherstrips	2DR CPE	93-02 Fourth Generation Chevrolet Camaro Pontiac Firebird	3197
D		93-94-95-96-97-98-99-2000-2001-2002	T-Top door seal weatherstrip	2DR CPE	93-02 Fourth Generation Chevrolet Camaro Pontiac Firebird	3198
D		93-94-95-96-97-98-99-2000-2001-2002	T-Top Weatherstrip end of t top seal	2DR CPE	93-02 Fourth Generation Chevrolet Camaro Pontiac Firebird	3199



GUIDE TO SOFFSEAL'S PRODUCT CODES

















B = Bumper sets **C** = Glass channels **D** = Door related **G** = Seals, gaskets **H** = Under hood items **I** = Interior parts
M = Miscellaneous items **R** = Roofrail, pillar post & convertible items **T** = Trunk related **W** = Window related **Z** = Weatherstrip kits

Chevrolet • Camaro



CODE	IMAGE	YEAR	DESCRIPTION	BODY	FITS	ITEM#
G		00-99	Gas tank anti squeak strips	2DR 4DR HTP SDN CNV SWG TRK	All Except Camaro And Firebird	1012
G		65-66-67-68-69	Antenna gasket	2DR 4DR SDN HTP CNV	68 Chevrolet 67-69 Chevrolet Camaro, Pontiac Firebird, 68-69 Chevrolet Chevelle, El Camino, 66-69 Chevrolet Nova	2409
G		65-66-67-68-69-70-71-72-73-74-75-76-77-78-79	Mirror gasket	2DR 4DR HTP 2DR SDN CNV SWG	68-69 Chevrolet 65-66 Bel Air Biscayne Impala 67-79 Chevrolet Camaro 66-72 Nova 66-72 Chevelle 70 El Camino 67-68 Pontiac Firebird	2305
G		66-67-68-69-70-71-72	Door handle & lock gaskets set	2DR HTP 2DR SDN CNV	67-69 Chevrolet Camaro, Pontiac Firebird, 66-72 Chevy II Nova, 64-72 Chevrolet Chevelle, Pontiac Tempest, LeMans, GTO, Buick Skylark, Oldsmobile Cutlass, 70-72 Chevrolet Monte Carlo	3021
G		66-67-68-69-70-71-72	License light gasket	2DR 4DR HTP SDN CNV SWG	66-72 Chevy II Nova, Biscayne, Bel Air, Impala, Chevelle, 67-72 Chevrolet Camaro, Pontiac Firebird	2378
G		67	Paint gasket set	2DR HTP CNV	67 Chevrolet Camaro 2 Door Hardtop Convertible	3050
G		67	Wiper motor to firewall seal	2DR HTP CNV	67 Chevrolet Camaro, Pontiac Firebird 2 Door Hardtop Convertible	30301
G		67	Park light lens gasket	2DR HTP CNV	67 Chevrolet Camaro Standard 2 Door Hardtop Convertible	3175
G		67-68	Taillight lens gasket	2DR HTP CNV	67-68 Camaro Standard RS 2 Door Hardtop Convertible	3178
G		67-68	Backup lens gaskets	2DR HTP CNV	67-68 Camaro RS 2 Door Hardtop Convertible	3179
G		67-68	Park light lens gasket	2DR HTP CNV	67-68 Chevrolet Camaro RS 2 Door Hardtop Convertible	3174
G		67-68	Taillight, housing gaskets 2 per set	2DR HTP CNV	67-68 Chevrolet Camaro 2 Door Hardtop Convertible	30501
G		67-68	Taillight, housing molded gaskets	2DR HTP CNV	67-68 Chevrolet Camaro 2 Door Hardtop Convertible	30502
G		67-68	Extra paint gasket kit	2DR HTP CNV	67-68 Chevrolet Camaro RS 2 Door Hardtop Convertible	3056
G		67-68-69	Heater seal kit small block	2DR HTP CNV 2DR SDN 4DR SDN	67-69 Chevy II, Nova, Camaro 2 Door Hardtop Convertible	3064
G		67-68-69	Heater seal kit big block	2DR HTP CNV	67-69 Chevrolet Camaro 2 Door Hardtop Convertible	3065

Chevrolet • Camaro

CODE	IMAGE	YEAR	DESCRIPTION	BODY	FITS	ITEM#
G		67-68-69-70-71-72-73-74-75-76-77-78-79-80-81	Door lock cylinder gasket	2DR HTP 2DR SDN CNV	67-81 Chevrolet Camaro, Pontiac Firebird 2 Door Hardtop Coupe Convertible	30211
G		68	Astro ventilation kit	2DR HTP CNV	68 Chevrolet Camaro 2 Door Hardtop Convertible	3060
G		68	Paint gasket kit	2DR HTP CNV	68 Chevrolet Camaro 2 Door Hardtop Convertible	3052
G		68	Side marker gaskets 4 piece	2DR 4DR SDN HTP CNV	68 Chevrolet Camaro 2 Door Hardtop Convertible	30521
G		68	Park light lens gasket	2DR HTP CNV	68 Chevrolet Camaro Standard 2 Door Hardtop Convertible	3176
G		68-69	Wiper motor to firewall seal	2DR HTP CNV	68-69 Chevy II Nova, Chevelle, Camaro, Pontiac Firebird	30303
G		69	Paint gasket kit	2DR HTP CNV	69 Chevrolet Camaro 2 Door Hardtop Convertible	3054
G		69	Taillight, housing gasket 2 per set	2DR HTP CNV	69 Chevrolet Camaro 2 Door Hardtop Convertible	30541
G		69	Astro ventilation kit	2DR HTP CNV	69 Chevrolet Camaro 2 Door Hardtop Convertible	3062
G		69	Park light lens gasket	2DR HTP CNV	69 Chevrolet Camaro Standard RS 2 Door Hardtop Convertible	3177
G		69	Back up light lens gasket	2DR HTP CNV	69 Chevrolet Camaro RS 2 Door Hardtop Convertible	3181
G		70-71-72-73	License lamp gaskets	2DR HTP	70-73 Chevrolet Camaro Coupe	3173
G		70-71-72-73	Taillight, assembly to body seal	2DR HTP	70-73 Chevrolet Camaro Coupe	3194
G		70-71-72-73	Parklamp lens gaskets	2DR HTP CNV	70-73 Chevrolet Camaro Coupe	3053
G		70-71-72-73	Front & rear side marker gasket set	2DR HTP CNV	70-73 Chevrolet Camaro Coupe	3051
G		74-75-76-77	Front side marker gaskets	2DR HTP CNV	74-77 Chevrolet Camaro, Pontiac Firebird 2 Door Hardtop Coupe Convertible	30511
G		78-79-80-81	Front side marker gaskets	2DR HTP CNV	78-81 Chevrolet Camaro, Pontiac Firebird 2 Door Hardtop Coupe Convertible	30512



GUIDE TO SOFFSEAL'S PRODUCT CODES

B = Bumper sets **C** = Glass channels **D** = Door related **G** = Seals, gaskets **H** = Under hood items **I** = Interior parts
M = Miscellaneous items **R** = Roofrail, pillar post & convertible items **T** = Trunk related **W** = Window related **Z** = Weatherstrip kits

Chevrolet • Camaro



CODE	IMAGE	YEAR	DESCRIPTION	BODY	FITS	ITEM#
H		64-65-66-67-68-69-70-71-72	Firewall wiring gutter plk	2DR 4DR HTP 2DR SDN SWG CNV	Chevy Chevelle, Biscayne, Bel Air, Impala, Caprice, Nova, Camaro, Cadillac Calais, Deville, Fleetwood, Oldsmobile 88, 98, Jetstar, Starfire, Pontiac Catalina, Bonneville, Firebird, Buick Lesabre, Wildcat, Electra	2328
H		67	Cowl firewall seal set	2DR HTP CNV	67 Chevrolet Camaro, Pontiac Firebird 2 Door Hardtop Convertible	30302
H		67-68	Splash flap with staples, 5 pc set	2DR HTP CNV	67-68 Chevrolet Camaro, Pontiac Firebird 2 Door Hardtop Convertible	3045
H		67-68-69	Wiper motor grommets	2DR HTP CNV	67-69 Chevrolet Camaro, Pontiac Firebird 2 Door Hardtop Convertible	3046
H		67-68-69	Standard hood insulation with clips	2DR HTP CNV	67-69 Chevrolet Camaro 2 Door Hardtop Convertible	3031
H		67-68-69	hood insulation with clips, cowl induction	2DR HTP CNV	67-69 Chevrolet Camaro 2 Door Hardtop Convertible	3031A
H		67-68-69	Hood to cowl seal	2DR HTP CNV	67-69 Chevrolet Camaro, Pontiac Firebird, 2 Door Hardtop And Convertible	3023
H		67-68-69	Heater hose kit with inner fender bracket, big block	2DR HTP CNV	67-69 Chevrolet Camaro 2 Door Hardtop Convertible	30651
H		67-68-69	Heater hose kit small block with inner fender bracket	2DR HTP CNV	67-69 Chevrolet Camaro 2 Door Hardtop Convertible	30641
H		67-68-69-70-71-72-73-74-75	Firewall clutch boot	2DR HTP CNV	67-75 Chevy II Nova, Camaro,	3071
H		67-68-69	Speedo cable grommets	2DR HTP CNV	67-69 Chevrolet Camaro, Pontiac Firebird 2 Door Hardtop Convertible	3047
H		68	Cowl firewall seal set	2DR HTP CNV	68 Chevrolet Camaro, Pontiac Firebird 2 Door Hardtop Convertible	3030
H		68-69	Cowl induction hood grommet	2DR HTP CNV	68-69 Chevrolet Camaro 2 Door Hardtop Convertible	30291
H		68-69	Firewall grommet	2DR HTP CNV	68-69 Chevrolet Camaro, Pontiac Firebird 2 Door Hardtop Convertible	30331
H		68-69	Park light, wiring harness seal grommet	2DR HTP CNV	68-69 Chevrolet Camaro 2 Door Hardtop Convertible	30461
H		68-69	Core support to radiator seal with a/c	2DR HTP CNV	68-69 Chevrolet Camaro, Pontiac Firebird, 2 Door Hardtop And Convertible	30235
H		68-69-70-71-72-73-74	Firewall cowl seal set	2DR HTP CNV	69 Chevrolet Camaro, Pontiac Firebird, 68-74 Chevy II Nova	3032

Chevrolet • Camaro

CODE	IMAGE	YEAR	DESCRIPTION	BODY	FITS	ITEM#
H		69	Splash flap set with staples 5 piece	2DR HTP CNV	69 Chevrolet Camaro, Pontiac Firebird 2 Door Hardtop Convertible	3045A
H		70-71-72-73	Front of hood seal with a/c	2DR HTP CNV	70-73 Chevrolet Camaro, Pontiac Firebird 2 Door Hardtop Coupe Convertible	30233
H		70-71-72-73-74-75-76-77-78-79-80-81	Hood to cowl seal	2DR HTP	70-81 Chevrolet Camaro, Pontiac Firebird 2 Door Hardtop Coupe	30231
H		70-71-72-73-74-75-76-77-78-79-80-81	Hood to cowl seal clip kit, plastic	2DR HTP	70-81 Chevrolet Camaro, Pontiac Firebird 2 Door Hardtop Coupe	30232
H		70-71-72-73-74-75-76-77-78-79-80-81	Hood insulation with clips	2DR HTP CNV	70-81 Chevrolet Camaro, Pontiac Firebird, Except 80-81 Air Induction	3039
H		82-83-84-85-86-87-88-89-90-91-92	Hood to cowl seal with clips	2DR HTP	82-92 Chevrolet Camaro, Pontiac Firebird 2 Door Coupe Hardtop	30236
H		ALL-MODELS-WHERE-APPLICABLE	Air cleaner lid seal, cut to fit	2DR 4DR HTP 2DR SDN CNV SWG	GM All	2099
I		62-63-64-65-66-67-68-69-70-71	Accelerator pedal hp with deluxe trim	2DR 4DR HTP 2DR SDN CNV SWG	62-71 Chevrolet Biscayne Bel Air Impala, 64-67 Chevelle, 70-71 Camaro Hi Perfor, 64-67 Buick Special-Skylark El Camino, 64-65 Pontiac A Body	2069
I		64-65-66-67	Automatic console slider	2DR 4DR HTP 2DR SDN CNV SWG	64-67 Chevy II, Nova, Chevelle, Biscayne, Bel Air, Impala, 67 Chevrolet Camaro	2108
I		64-65-66-67-68-69-70	Sun visor tip	2DR 4DR SDN HTP CNV	64-70 All Makes And Models	4006
I		64-65-66-67-68-69-70-71-72-73-74	Park brake pedal pad	2DR HTP CNV	El Camino Cutlass Chevelle Chevy II Camaro Firebird LeMans Tempest GTO Grand Prix Full Size Centurion Century Electra Invicta LeSabre Regal Riviera Skylark Wildcat Monte Carlo	3094
I		65-66-67-68	Standard horn cap rubber retainer ring	2DR HTP CNV 2DR SDN SWG	67-68 Chevrolet Camaro, Pontiac Firebird 65-67 Chevelle	3079
I		66-67-68-69-70-71-72	Brake pedal pad standard disc	2DR HTP 2DR 4DR SDN CNV SWG	67-69 Chevrolet Camaro 66-72 Chevrolet Chevelle 70-72 Chevrolet Monte Carlo	3041
I		67	Upper shift cover seal 3 & 4 speed with console	2DR HTP CNV	67 Chevrolet Camaro 2 Door Hardtop Convertible	3076
I		67	Console slider 4 speed	2DR HTP CNV	67 Chevy II Nova, Camaro	3083
I		67-68	Park brake trim plate	2DR HTP CNV	67-68 Chevrolet Camaro 2 Door Hardtop Convertible	3093
I		67-68-69	Brake & clutch trim plate	2DR HTP CNV	67-69 Chevrolet Camaro 2 Door Hardtop Convertible	3098









GUIDE TO SOFFSEAL'S PRODUCT CODES

B = Bumper sets **C** = Glass channels **D** = Door related **G** = Seals, gaskets **H** = Under hood items **I** = Interior parts
M = Miscellaneous items **R** = Roofrail, pillar post & convertible items **T** = Trunk related **W** = Window related **Z** = Weatherstrip kits



CODE	IMAGE	YEAR	DESCRIPTION	BODY	FITS	ITEM#
I		67-68-69	Automatic brake pedal trim plate	2DR HTP CNV	67-69 Chevrolet Camaro 2 Door Hardtop Convertible	3099
I		67-68-69	Shift boot 4-speed replacement	2DR HTP CNV	67-69 Chevrolet Camaro 3 Speed with 0 Console 2 Door Hardtop Convertible	3074
I		67-68-69	Lower steering column boot	2DR HTP CNV	67-69 Chevrolet Camaro, Pontiac Firebird 2 Door Hardtop Convertible	3075
I		67-68-69	Shift boot 3 & 4-speed with console	2DR HTP 2DR SDN CNV	67-69 Chevrolet Camaro, 67 Pontiac Firebird, 68-73 Chevrolet Nova	3072
I		67-68-69	Brake pedal pad automatic disc	2DR HTP CNV	67-69 Chevrolet Camaro, Pontiac Firebird 2 Door Hardtop Convertible	3040
I		67-68-69-70-71-72-73-74	Automatic brake pedal pad	2DR HTP CNV 2DR SDN	67-72 Chevrolet Camaro A Body, 68-74 Nova, 68-69 Corvette, 65-69 Corvair	3097
I		68	Upper shift cover seal 4-speed with console	2DR HTP CNV	68 Chevrolet Camaro 2 Door Hardtop Convertible	30761
I		68	Console slider 4-speed black	2DR HTP CNV	68 Chevrolet Camaro 2 Door Hardtop Convertible	3085
I		68-69	Automatic console rubber seals	2DR HTP CNV	68-69 Chevrolet Camaro 2 Door Hardtop Convertible	3081
I		68-69-70-71-72	Shift boot 4-speed with console	2DR HTP 2DR SDN CNV	69 Chevrolet Camaro with Console, 67 GTO without Console, 68-72 GTO with & without Console	30731
I		69-70-71-72-73-74-75	Park brake pedal pad	2DR HTP CNV	69-75 Chevy II Nova, Camaro, Pontiac Firebird	3095
I		70-71-72-73-74-75	Upper shift boot	2DR HTP CNV	70-75 Chevrolet Camaro, Pontiac Firebird 2 Door Hardtop Convertible	3077
I		73-74-75-76-77-78-79-80-81	Clutch pedal pad	2DR HTP CNV	73-81 Chevrolet Camaro, Pontiac Firebird 2 Door Hardtop Coupe Convertible	30961
K		87-88-89-90-91-92	Kit, includes horizontal and vertical roofrails, rear bow seal, header seal	2DR CNV	87-92 Chevrolet Camaro, Pontiac Firebird 2 Door Convertible	3187
M		00-99	Window weld ribbon sealer 3/8 inch round	ALL BODY STYLES	All Makes And Models	08622
M		57-58-59-60-61-62-63-64-65-66-67-68-69-70-71-72-73-74-75-76-77-78-79-80-81	Bellhousing to clutch fork rubber boot	2DR 4DR HTP SDN CNV SWG	57-81 GM All Manual Transmission	2196
M		64-65-66-67-68-69	Rocker panel flap plug, requires 2	2DR 4DR SDN HTP CNV	64-68 Chevrolet Chevelle, Pontiac GTO, Oldsmobile Cutlass, Buick Skylark, 67-69 Chevrolet Camaro, Pontiac Firebird, 2 Door 4 Door Sedan Hardtop Convertible	5013

Chevrolet • Camaro

CODE	IMAGE	YEAR	DESCRIPTION	BODY	FITS	ITEM#
M		66-67-68-69-70-71-72-73-74-75	Accelerator pedal	2DR HTP CNV SDN SWG	67-75 Chevrolet Camaro, Pontiac Firebird, 68-72 Chevrolet Corvette, Chevelle, 68-75 Chevy II Nova, 66-72 Pontiac Tempest, LeMans, GTO, 2 Door Hardtop Convertible Sedan Station Wagon	3090
M		67	Headlight, bushing kit	2DR HTP CNV	67 Chevrolet Camaro RS 2 Door Hardtop Convertible	30481
M		67-68-69	Front bumper guard cushion	2DR HTP CNV	67-69 Chevrolet Camaro, 67-68 Camaro Rear 67-69 Front, 2 Door Hardtop Convertible	3049
M		67-68-69	Windshield washer hose kit	2DR HTP CNV	67-69 Chevrolet Camaro, 2 Door Hardtop Convertible	3068
M		67-68-69	Anti-squeak gas tank kit	2DR HTP CNV	67-69 Chevrolet Camaro, Pontiac Firebird, 2 Door Hardtop Convertible	3117
M		67-68-69-70-71-72	Core support bushing & bolt kit	2DR HTP CNV SDN	67-72 Chevy II Nova 2 Door 4 Door Sedan, Camaro, Pontiac Firebird, 2 Door Hardtop Convertible	3069
M		67-68-69-70-71-72	Firewall insulation pad with clips with a/c	2DR SDN 4DR HTP CNV SWG	67-69 Chevrolet Camaro, Pontiac Firebird 2 Door Hardtop Convertible, 68-72 Nova, 2 Door 4 Door Sedan	3033A
M		67-68-69-70-71-72	Firewall insulation pad with clips without a/c	2DR SDN 4DR HTP CNV	67-69 Chevrolet Camaro, Pontiac Firebird 2 Door Hardtop Convertible, 68-72 Chevrolet Nova, 2 Door 4 Door Sedan	3033
M		67-68-69-70-71-72	Body mount hardware kit	2DR HTP CNV SDN	67-72 Chevrolet Camaro, Pontiac Firebird 2 Door Hardtop Convertible, 68-72 Chevrolet Nova, 2 Door 4 Door Sedan	3027
M		67-68-69-70-71-72	Body mount set with steel sleeves	2DR HTP CNV SDN	67-72 Chevrolet Camaro, Pontiac Firebird, 68-72 Nova, 2 Door 4 Door Sedan	3025
M		67-68-69-70-71-72	Body Mount/bushing Bolt Kit	ALL BODY STYLES	67-72 Chevrolet Camaro, Pontiac Firebird, 68-72 Nova, 2 Door 4 Door Sedan	3025K
M		67-68-69-70-71-72-73-74-75-76-77-78-79-80-81	Accelerator pedal trim	2DR SDN HTP CNV	67-81 Chevrolet Camaro 2 Door Hardtop, Convertible, 68-72 Corvette, Coupe, Convertible	3091
M		67-68-69-70-71-72-73-74-75-76-77-78-79-80-81-82-83-84	Oil filler cap	2DR 4DR SDN HTP CNV	67-84 GM All Models	5044
M		68-69	Headlight hose kit	2DR HTP CNV	68-69 Chevrolet Camaro RS 2 Door Hardtop Convertible	3066
M		68-69	Headlight, bushing kit	2DR HTP CNV	68-69 Chevrolet Camaro RS 2 Door Hardtop Convertible	30482
M		68-69-70-71-72	Door jamb louver	2DR HTP CNV SDN	68-69 Chevrolet Camaro, Pontiac Firebird, 2 Door Hardtop Convertible, Chevrolet Nova 2 Door Sedan	3026



GUIDE TO SOFFSEAL'S PRODUCT CODES

B = Bumper sets **C** = Glass channels **D** = Door related **G** = Seals, gaskets **H** = Under hood items **I** = Interior parts
M = Miscellaneous items **R** = Roofrail, pillar post & convertible items **T** = Trunk related **W** = Window related **Z** = Weatherstrip kits

Chevrolet • Camaro



CODE	IMAGE	YEAR	DESCRIPTION	BODY	FITS	ITEM#
M		68-69-70-71-72-73-74-75-76-77-78-79	Brake & clutch pedal pad	2DR HTP CNV SDN	67-72 Chevrolet Camaro Standard, Pontiac Firebird, 68-79 Chevrolet Corvette, 68-72 Chevrolet Nova, 64-72 Chevrolet Chevelle, 70-72 Monte Carlo 71-72 GTO, 2 Door Hardtop Convertible Sedan	3096
M		69	Headlight, washer hose kit	2DR HTP CNV	69 Chevrolet Camaro RS 2 Door Hardtop Convertible	3067
M		69	Rear bumper guard cushion	2DR HTP CNV	69 Chevrolet Camaro, 2 Door Hardtop Convertible	30491
M		70-71-72-73-74-75-76-77-78-79-80-81	Firewall pad with clips with a/c	2DR SDN 4DR HTP CNV SWG	70-81 Chevrolet Camaro, Pontiac Firebird, 2 Door Coupe	30332
M		70-71-72-73-74-75-76-77-78-79-80-81	Firewall pad with clips without a/c	2DR CPE	70-81 Chevrolet Camaro, Pontiac Firebird, 2 Door Coupe	30333
P		00-99	Hood side bumpers; has a width of 1.2", a length of 10/16", and an installed height of 1.2". It is typically used in metal applications and has a drill/slot size of .172".	ALL BODY STYLES	Universal Fit	K123
R		67	Pillar post weatherstrip with molded ends	CNV	67 Chevrolet Camaro, Pontiac Firebird Convertible	3140
R		67	Roofrail weatherstrip with molded ends	2DR HTP	67 Chevrolet Camaro, Pontiac Firebird, 2 Door Hardtop	3002
R		67-68-69	Weatherstrip kit for convertible top	CNV	67-69 Chevrolet Camaro, Pontiac Firebird, Convertible	3043
R		67-68-69	Header seal kit with clips and molded end	CNV	67-69 Chevrolet Camaro, Pontiac Firebird Convertible	3044
R		67-68-69	Header seal with clips and without molded ends	CNV	67-69 Chevrolet Camaro, Pontiac Firebird, Convertible	3044A
R		68-69	Roofrail weatherstrip with molded ends	2DR HTP CNV	68-69 Chevrolet Camaro, Pontiac Firebird, 2 Door Hardtop	3013
R		68-69	Pillar post weatherstrip and molded ends	CNV	68-69 Chevrolet Camaro, Pontiac Firebird Convertible	3142
R		70-71-72-73-74-75-76-77-78-79-80-81	Roofrail weatherstrip with molded ends	2DR CPE	70-81 Chevrolet Camaro, Pontiac Firebird, 2 Door Coupe	3100
R		78-79-80-81	T-top weatherstrip kit for body, outer edge of t-top and auxiliary seal	2DR	78-81 Chevrolet Camaro, Pontiac Firebird	3189

Chevrolet • Camaro

CODE	IMAGE	YEAR	DESCRIPTION	BODY	FITS	ITEM#
R		78-79-80-81	T-top seals fisher style single release	2DR CPE	78-81 Chevrolet Camaro, Pontiac Firebird, 2 Door Coupe	3190
R		78-79-80-81	T-top weatherstrip fits on outer edge of t-top includes auxiliary seal, fisher t-tops only	2DR CPE	78-81 Chevrolet Camaro, Pontiac Firebird, 2 Door Coupe	3192
R		78-79-80-81	Auxiliary t-top sealing strips	2DR CPE	78-81 Chevrolet Camaro, Pontiac Firebird, 2 Door Coupe	3192A
R		82-83-84-85-86-87-88-89-90-91-92	T-top roofrail weatherstrip fits t-top	2DR CPE	82-92 Chevrolet Camaro, Pontiac Firebird, 2 Door Coupe	3193
R		82-83-84-85-86-87-88-89-90-91-92	T-top weatherstrip on body	2DR CPE	82-92 Chevrolet Camaro, Pontiac Firebird, 2 Door Coupe	3191
R		82-83-84-85-86-87-88-89-90-91-92	T-top weatherstrip kit seal for body & outer edge of t-top	2DR CPE	82-92 Chevrolet Camaro, Pontiac Firebird, 2 Door Coupe	3196
R		82-83-84-85-86-87-88-89-90-91-92	T-Top Auxiliary Seal	2DR	82-92 Chevrolet Camaro Pontiac Firebird	3188
R		82-83-84-85-86-87-88-89-90-91-92	Roofrail weatherstrip third generation f-body	2DR CPE	82-92 Chevrolet Camaro, Pontiac Firebird, 2 Door Coupe	3101
R		87-88-89-90-91-92	Horizontal and vertical roofrails	2DR CNV	87-92 Chevrolet Camaro, Pontiac Firebird 2 Door Convertible	3184
R		87-88-89-90-91-92	Rear bow seal	2DR CNV	87-92 Chevrolet Camaro, Pontiac Firebird 2 Door Convertible	3185
R		87-88-89-90-91-92	Header seal	2DR CNV	87-92 Chevrolet Camaro, Pontiac Firebird 2 Door Convertible	3186
R		93-94-95-96-97-98-99-00-01-02	Convertible Top Seals, 4 pieces, No Header Seal	2DR CNV	93-02 Chevrolet Camaro, 93-02 Pontiac Firebird	3208
R		93-94-95-96-97-98-99-00-01-02	Quarter Panel to Convertible Top Seal	2DR CNV	93-02 Chevrolet Camaro, Pontiac Firebird	3210
T		67-68	Trunk mat aqua	2DR HTP CNV	67-68 Chevrolet Camaro, Pontiac Firebird 2 Door Hardtop Convertible	3120
T		67-68-69-70-71-72	Filler neck hose	2DR HTP 2DR SDN CNV	67-68 Chevrolet Camaro, Pontiac Firebird, 68-72 Nova	3028
T		67-68-69-70-71-72	Gas tank filler neck sleeve	2DR HTP 2DR SDN CNV	67-68 Chevrolet Camaro, Pontiac Firebird, 68-72 Nova	3029
T		67-68-69-70-71-72-73-74-75-76-77-78-79-80-81	Trunk weatherstrip	2DR HTP	67-81 Chevrolet Camaro, Pontiac Firebird 2 Door Hardtop Coupe	3020
T		69	Trunk mat	2DR HTP CNV	69 Chevrolet Camaro, Pontiac Firebird 2 Door Hardtop Convertible	3122



GUIDE TO SOFFSEAL'S PRODUCT CODES

B = Bumper sets **C** = Glass channels **D** = Door related **G** = Seals, gaskets **H** = Under hood items **I** = Interior parts
M = Miscellaneous items **R** = Roofrail, pillar post & convertible items **T** = Trunk related **W** = Window related **Z** = Weatherstrip kits

Chevrolet • Camaro



CODE	IMAGE	YEAR	DESCRIPTION	BODY	FITS	ITEM#
T		75-76-77-78-79-80-81-82-83-84-85-86-87-88-89-90-91-92	Trunk and Hatchback weatherstrip	2DR 4DR SDN HTP CNV	77-85 Chevrolet Impala, 77-91 Chevrolet Caprice, 82-92 Chevrolet Camaro, 75-79 Chevrolet Nova, 78-88 Chevrolet Monte Carlo, 78-83 Chevrolet Malibu, 78-83 Pontiac LeMans, 82-92 Pontiac Firebird, 75-91 Pontiac Ventura, 77-86 Pontiac Parisienne, 77-81 Pontiac Catalina, 69-88 Pontiac Grand Prix, 64-87 Pontiac LeMans, Pontiac Grand Am, 64-77 Pontiac GTO, 73-79 Oldsmobile Omega, 77-85 Oldsmobile Delta 88, 77-84 Oldsmobile 98, 77-88 Oldsmobile Cutlass, 73-75 Buick Apollo, 76-79 Buick Skylark, 77-79 Phoenix, 73-88 Buick Regal, 77-84 Buick Electra, 77-85 Buick LeSabre, 77-78 Buick Riviera, 77-91 C-Body	2424
T		93-94-95-96-97-98-99-00-01-02	Trunk Weatherstrip, 2 Door Coupe and T-Top	2DR CPE T-TOP	93-02 Chevrolet Camaro, 93-02 Pontiac Firebird	3201
T		93-94-95-96-97-98-99-00-01-02	Trunk Weatherstrip	2DR CNV	93-02 Chevrolet Camaro, 93-02 Pontiac Firebird	3205
W		67	Window weatherstrip, original style with round bead outers only	2DR HTP	67 Chevrolet Camaro, Pontiac Firebird 2 Door Hardtop	31322
W		67	Vent window seals	2DR HTP CNV	67 Chevrolet Camaro, Pontiac Firebird, 2 Door Hardtop Convertible	3125
W		67	Window weatherstrip, replacement style	2DR HTP	67 Chevrolet Camaro, Pontiac Firebird, 2 Door Hardtop	3130
W		67	Window weatherstrip, original style with round bead	2DR HTP	67 Chevrolet Camaro, Pontiac Firebird, 2 Door Hardtop	31301
W		67	Window weatherstrip, replacement style	CNV	67 Chevrolet Camaro, Pontiac Firebird Convertible	3131
W		67	Window weatherstrip, original style with round bead	CNV	67 Chevrolet Camaro, Pontiac Firebird, Convertible	31310
W		67-68	Glass run channel front door window	2DR 4DR HTP CNV	67 Chevrolet Camaro, Pontiac Firebird, 68 Chevrolet Chevelle, Oldsmobile Cutlass 68, Buick Special, Skylark, 2 Door 4 Door Hardtop Convertible	3126
W		67-68-69	Rubber door jamb u-shape	2DR HTP CNV	67-69 Chevrolet Camaro, Pontiac Firebird, 2 Door Hardtop And Convertible	3022A
W		67-68-69	Quarter window seals exact steel insert	2DR HTP CNV	67-69 Chevrolet Camaro, Pontiac Firebird, 2 Door Hardtop Convertible	3022M
W		67-68-69	Quarter window seals, all rubber	CNV 2DR HTP	67-69 Chevrolet Camaro, Pontiac Firebird 2 Door Hardtop Convertible	3022R

Chevrolet • Camaro









CODE	IMAGE	YEAR	DESCRIPTION	BODY	FITS	ITEM#
W		68	Window weatherstrip, original style with round bead	2DR HTP	68 Chevrolet Camaro, Pontiac Firebird, Standard Interior, 2 Door Hardtop	3134
W		68	Window weatherstrip, original style with round bead	2DR HTP	68 Chevrolet Camaro Deluxe Interior 2 Door Hardtop	3134A
W		68	Window weatherstrip, original style with round bead	CNV	68 Chevrolet Camaro, Pontiac Firebird, Standard Interior, Convertible	3135
W		68	Window weatherstrip, original style with round bead, deluxe interior	CNV	68 Chevrolet Camaro Convertible	3135A
W		68-67-69	Window weatherstrip replacement style	2DR HTP	68-69 Chevrolet Camaro, Pontiac Firebird 2 Door Hardtop	3132
W		68-69	Window weatherstrip, original style with round bead	2DR HTP	68-69 Chevrolet Camaro, Pontiac Firebird, Deluxe Interior, 2 Door Hardtop	31321
W		68-69	Window weatherstrip, original style with round bead, outers only	2DR HTP	68-69 Chevrolet Camaro, Pontiac Firebird 2 Door Hardtop	313221
W		68-69	Window weatherstrip, original style with round bead	2DR HTP	68-69 Chevrolet Camaro Standard Interior, 2 Door Hardtop	3132A
W		68-69	Window weatherstrip replacement style	CNV	68-69 Chevrolet Camaro, Pontiac Firebird Convertible	3133
W		68-69	Window weatherstrip, original style with round bead	CNV	68-69 Chevrolet Camaro, Pontiac Firebird Convertible	31331
W		68-69	Window weatherstrip, original style with round bead	CNV	68-69 Chevrolet Camaro Convertible	31331A
W		70-71-72-73-74-75-76-77-78-79-80-81	Window weatherstrip original style with flat bead (replacement style)	2DR CPE	78-81 Chevrolet Camaro Z28, Berlinetta, 70-81 Pontiac Firebird, Trans Am 2 Door Coupe	3141
W		70-71-72-73-74-75-76-77-78-79-80-81	Window weatherstrip, original style with flat bead 4 piece	2DR CPE	70-81 Chevrolet Camaro Except Z-28 And Berlinetta, Pontiac Firebird Except Trans-Am	3136
W		70-71-72-73-74-75-76-77-78-79-80-81	Window weatherstrip, original style with flat bead, outers only	2DR CPE	70-81 Chevrolet Camaro, Pontiac Firebird, 2 Door Coupe	31360
W		70-71-72-73-74-75-76-77-78-79-80-81	Window weatherstrip, original style	2DR CPE	70-81 Chevrolet Camaro, Pontiac Firebird, 2 Door Coupe	3137
W		70-71-72-73-74-75-76-77-78-79-80-81	Window weatherstrip original style, outers only	2DR CPE	70-81 Chevrolet Camaro, Pontiac Firebird, 2 Door Coupe	31370
W		82-83-84-85-86-87-88-89-90-91-92	Window weatherstrip outers only, original style	2DR CPE	82-92 Chevrolet Camaro, Pontiac Firebird, 2 Door Coupe	3138
W		82-83-84-85-86-87-88-89-90-91-92	Window weatherstrip inners only, original style with round bead	2DR CPE	82-92 Chevrolet Camaro, Pontiac Firebird, 2 Door Coupe	3139



GUIDE TO SOFFSEAL'S PRODUCT CODES

B = Bumper sets **C** = Glass channels **D** = Door related **G** = Seals, gaskets **H** = Under hood items **I** = Interior parts
M = Miscellaneous items **R** = Roofrail, pillar post & convertible items **T** = Trunk related **W** = Window related **Z** = Weatherstrip kits



CODE	IMAGE	YEAR	DESCRIPTION	BODY	FITS	ITEM#
W		82-83-84-85-86-87-88-89-90-91-92	Front door glass seals	2DR CPE	82-92 Chevrolet Camaro, Pontiac Firebird, 2 Door Coupe	3195
Z		67	Weatherstrip kit, includes convertible top kit, bumper kit, door u jambs, door weatherstrips, hood to cowl seal, paint gaskets, park lens gaskets, pillar post seals, quarter window seals, splash flaps, trunk weatherstrip, window weatherstrips, tail lens gaskets	CNV	67 Chevrolet Camaro Convertible	KIT308
Z		67	Weatherstrip kit, includes convertible top kit, bumper kit, door u jambs, door weatherstrips, hood to cowl seal, paint gaskets, park lens gaskets, pillar post seals, quarter window seals, splash flaps, trunk weatherstrip, window weatherstrips, tail lens gaskets, extra paint gasket	CNV	67 Chevrolet Camaro RS Convertible	KIT308A
Z		67	Weatherstrip kit, includes bumper kit, door weatherstrips, hood to cowl seal, roofrail weatherstrips, trunk weatherstrip, window weatherstrips, door u jambs, paint gaskets, park lens gaskets, quarter window seals, splash flaps, tail lens gaskets	2DR HTP	67 Chevrolet Camaro 2 Door Hardtop	KIT305
Z		67	Weatherstrip kit, includes bumper kit, door weatherstrips, hood to cowl seal, roofrail weatherstrips, trunk weatherstrip, window weatherstrips, door u jambs, paint gaskets, extra rs paint gaskets, park lens gaskets, quarter window seals, splash flaps, taillight lens gasket	2DR HTP	67 Chevrolet Camaro RS 2 Door Hardtop	KIT305A
Z		67	Weatherstrip kit, includes trunk weatherstrip, door weatherstrip, roofrail weatherstrip	2DR HTP	67 Chevrolet Camaro, Pontiac Firebird 2 Door Hardtop	KIT305X
Z		68	Weatherstrip kit, includes door weatherstrip, roofrail weatherstrip, trunk weatherstrip, quarter window seals, rubber door u jamb, hood to cowl seal, splash flap set, paint gasket kit, bumper kit, window weatherstrip, park light lens gasket, taillight lens gasket	2DR HTP	68 Chevrolet Camaro 2 Door Hardtop	KIT306
Z		68	Weatherstrip kit, includes bumper kit, door weatherstrips, hood to cowl seal, roofrail weatherstrips, trunk weatherstrip, window weatherstrips, door u jambs, paint gaskets, extra paint gaskets, park lens gaskets, quarter window seals, splash flaps, taillight lens gasket	2DR HTP	68 Chevrolet Camaro RS 2 Door Hardtop	KIT306A

Chevrolet • Camaro

CODE	IMAGE	YEAR	DESCRIPTION	BODY	FITS	ITEM#
Z		68	Weatherstrip kit with deluxe coupe window weatherstrip with spec molding original, includes door, roofrail, window and trunk weatherstrip, quarter window seals, rubber door jamb, hood to cowl seal, splash flap, paint gasket kit and extra paint gasket kit, bumper kit, park light, taillight gasket	2DR HTP	68 Chevrolet Camaro 2 Door Hardtop	KIT306B
Z		68	Weatherstrip kit deluxe interior window weatherstrip original round bead, includes door, roofrail, trunk weatherstrip, quarter window seals, rubber door jamb, hood to cowl seal, splash flap, paint gasket, bumper kit, window weatherstrip, park light lens, taillight lens gasket	2DR HTP	68 Chevrolet Camaro 2 Door Hardtop	KIT306C
Z		68	Weatherstrip kit w/o wide belt chrome, includes door, roofrail, trunk weatherstrip, quarter window seals, rubber door u jamb, hood to cowl seal, splash flap set, paint gasket kit, bumper kit, window weatherstrip, park light lens gasket, taillight lens gasket	2DR HTP	68 Chevrolet Camaro 2 Door Hardtop	KIT306D
Z		68	Weatherstrip kit with wide belt chrome, includes door, roofrail, trunk weatherstrip, quarter window seals, rubber door u jamb, hood to cowl seal, splash flap set, paint gasket kit, bumper kit, window weatherstrip, park light lens gasket, taillight lens gasket	2DR HTP	68 Chevrolet Camaro 2 Door Hardtop	KIT306E
Z		68	Weatherstrip Kit, includes door weatherstrip, roofrail weatherstrip, trunk weatherstrip, window weatherstrip, quarter window seal, rubber door jamb u-shape, hood to cowl seal, splash flar set, bumper kit, paint gasket, park light lens gasket, taillight lens gasket	2DR HTP	68 Chevrolet Camaro 2 Door Hardtop Custom Interior	KIT306F
Z		68	Weatherstrip Kit, includes door weatherstrip, roofrail weatherstrip, trunk weatherstrip, rubber door jamb u-shape, quarter window seal, hood to cowl seal, splash flap, paint gasket kit, bumper kit, park light lens gasket, taillight lens gasket, extra paint gasket kit, window weatherstrip	2DR HTP RS	68 Chevrolet Camaro 2 Door Hardtop RS	KIT306G









GUIDE TO SOFFSEAL'S PRODUCT CODES

B = Bumper sets **C** = Glass channels **D** = Door related **G** = Seals, gaskets **H** = Under hood items **I** = Interior parts
M = Miscellaneous items **R** = Roofrail, pillar post & convertible items **T** = Trunk related **W** = Window related **Z** = Weatherstrip kits

Chevrolet • Camaro



CODE	IMAGE	YEAR	DESCRIPTION	BODY	FITS	ITEM#
Z		68	Weatherstrip kit, includes convertible top kit, bumper kit, door u jambs, door weatherstrips, hood to cowl seal, paint gaskets, park lens gaskets, pillar post seals, quarter window seals, splash flaps, trunk weatherstrip, window weatherstrips, tail lens gaskets	CNV	68 Chevrolet Camaro Convertible	KIT309
Z		68	Weatherstrip kit, includes convertible top kit, bumper kit, door u jambs, door weatherstrips, hood to cowl seal, paint gaskets, park lens gaskets, pillar post seals, quarter window seals, splash flaps, trunk weatherstrip, window weatherstrips, tail lens gaskets, extra paint gasket	CNV	68 Chevrolet Camaro RS Convertible	KIT309A
Z		68	Weatherstrip kit with extra paint gasket, includes convertible top kit, bumper kit, door u jambs, door weatherstrips, hood to cowl seal, paint gaskets, pillar post seals, quarter window seals, splash flaps, trunk weatherstrip, window weatherstrips, tail lens gaskets, extra paint gaskets	CNV	68 Chevrolet Camaro RS Convertible	KIT309C
Z		68	Weatherstrip kit, includes door, trunk weatherstrip, rubber door jamb u shape, quarter window seals, hood to cowl seal, weatherstrip kit convertible top, splash flap, paint gasket kit, bumper kit, window weatherstrip, pillar post, park light lens gasket, taillight lens gaskets	CNV	68 Chevrolet Camaro	KIT309D
Z		68	Weatherstrip Kit, includes door weatherstrips, trunk weatherstrips, rubber door jambs u-shape, quarter window seals, hood to cowl seals, conv top kit, splash flap, paint gasket kit, bumper kit, pillar post, park light lens gaskets, taillight lens gaskets, window weatherstrips	CNV	68 Chevrolet Camaro Convertible Standard Interior	KIT309E
Z		68	Weatherstrip Kit, includes door weatherstrips, trunk weatherstrips, rubber door jambs u-shape, quarter window seals, hood to cowl seals, conv top kit, splash flap, paint gasket, bumper kit, pillar post seals, park light lens gaskets, taillight lens gaskets, window weatherstrips	CNV	68 Chevrolet Camaro Convertible With Custom Interior	KIT309F

Chevrolet • Camaro

CODE	IMAGE	YEAR	DESCRIPTION	BODY	FITS	ITEM#
Z		68	Weatherstrip Kit, includes door weatherstrips, trunk weatherstrips, rubber door jambs u-shape, quarter window seals, hood to cowl seals, conv top kit, splash flap, paint gasket kit, bumper kit, pillar post seals, park light lens gaskets, taillight lens gaskets, extra paint gasket kit, window weatherstrips	CNV	68 Chevrolet Camaro Convertible With Custom Interior	KIT309G
Z		68-69	Weatherstrip kit, includes trunk weatherstrip, door weatherstrip, roofrail weatherstrip	2DR HTP	68-69 Chevrolet Camaro, Pontiac Firebird, 2 Door Hardtop	KIT306X
Z		69	Weatherstrip kit, includes bumper kit, door weatherstrips, hood to cowl seal, roofrail weatherstrips, trunk weatherstrip, window weatherstrips, door u jambs, paint gaskets, park lens gaskets, quarter window seals, splash flaps	2DR HTP	69 Chevrolet Camaro 2 Door Hardtop	KIT307
Z		69	Weatherstrip kit with original style window felts, includes door, roofrail, trunk weatherstrip, quarter. window seals, hood to cowl, rubber door u jamb, splash flap set, paint gasket kit, bumper kit, window weatherstrip, park light lens gasket	2DR HTP	69 Chevrolet Camaro 2 Door Hardtop	KIT307A
Z		69	Weatherstrip kit with original round bead window felts, includes door, roofrail, trunk weatherstrip, quarter. window seals, rubber door u jamb, hood to cowl seal, splash flap set, paint gasket kit, bumper kit, window weatherstrip, park light lens gasket	2DR HTP	69 Chevrolet Camaro Deluxe Interior 2 Door Hardtop	KIT307B
Z		69	Weatherstrip kit, includes convertible top kit, bumper kit, door u jambs, door weatherstrips, hood to cowl seal, paint gaskets, park lens gaskets, pillar post seals, quarter window seals, splash flaps, trunk weatherstrip, window weatherstrips	CNV	69 Chevrolet Camaro Convertible	KIT310
Z		69	Weatherstrip kit deluxe interior authentic with felts, includes convertible top kit, bumper kit, door u jambs door weatherstrips, hood to cowl seal, paint gaskets, park light lens gaskets, pillar post seals, quarter window seals, splash flaps, trunk weatherstrips, window weatherstrips, door weatherstrips	CNV	69 Chevrolet Camaro Convertible	KIT310A



GUIDE TO SOFFSEAL'S PRODUCT CODES







B = Bumper sets **C** = Glass channels **D** = Door related **G** = Seals, gaskets **H** = Under hood items **I** = Interior parts
M = Miscellaneous items **R** = Roofrail, pillar post & convertible items **T** = Trunk related **W** = Window related **Z** = Weatherstrip kits

Chevrolet • Camaro



CODE	IMAGE	YEAR	DESCRIPTION	BODY	FITS	ITEM#
Z		69	Weatherstrip kit original style with round bead window weatherstrip, includes convertible top kit, bumper kit, door u jambs, door weatherstrips, hood to cowl seal, paint gaskets, park light lens gaskets, pillar post seals, quarter window seals, splash flaps, trunk weatherstrips, window weatherstrips	CNV	69 Chevrolet Camaro	KIT310B
Z		69	Weatherstrip kit with deluxe int window weatherstrip original, includes door, trunk weatherstrips, door jamb, quarter window seals, hood to cowl seal, convertible top kit, splash flap, paint gasket kit, bumper kit, window weatherstrips, pillar post weatherstrip, park light lens gasket, taillight lens gasket	CNV	69 Chevrolet Camaro Convertible	KIT309B
Z		70-71-72-73-74-75-76-77-78-79-80-81	Weatherstrip kit, includes bumper kit, door weatherstrips, hood to cowl seal, roofrail weatherstrips, trunk weatherstrip, window weatherstrips, hood to cowl seal clips	2DR CPE	70-81 Chevrolet Camaro, Pontiac Firebird, 2 Door Coupe	KIT311
Z		70-71-72-73-74-75-76-77-78-79-80-81	Weatherstrip kit, includes bumper kit, door weatherstrips, hood to cowl seal, roofrail weatherstrips, trunk weatherstrip, window weatherstrips, hood to cowl seal clips, attaches to special 1 inch chrome molding	2DR CPE	70-81 Chevrolet Camaro 2 Door Coupe	KIT311A
Z		70-71-72-73-74-75-76-77-78-79-80-81	Weatherstrip kit, includes trunk weatherstrip, door weatherstrip, roofrail weatherstrip	2DR CPE	70-81 Chevrolet Camaro, Pontiac Firebird 2 Door Coupe	KIT311X
Z		70-71-72-73-74-75-76-77-78-79-80-81	Weatherstrip kit, includes door weatherstrip, trunk weatherstrip, hood to cowl seal, hood to cowl seal clip kit, bumper kit, roofrail weatherstrip, window weatherstrip with round bead	2DR HTP CPE	70-81 Chevrolet Camaro, Berlinetta, Z-28, Pontiac Firebird, Trans Am, 2 Door Hardtop Coupe	KIT311B
Z		78-79-80-81	Weatherstrip kit, includes door weatherstrip, trunk weatherstrip, hood to cowl seal, hood to cowl seal clip kit, bumper kit, t-top weatherstrip, window weatherstrip with round bead	2DR CPE	78-81 Chevrolet Camaro, Pontiac Firebird, 2 Door Coupe	KIT311BT
Z		78-79-80-81	Weatherstrip kit, includes door weatherstrip, trunk weatherstrip, hood to cowl seal, hood to cowl seal clip kit, bumper kit, t-top weatherstrip, window weatherstrip with flat bead	2DR CPE	78-81 Chevrolet Camaro, Pontiac Firebird, 2 Door Coupe	KIT311T

Chevrolet • Camaro

CODE	IMAGE	YEAR	DESCRIPTION	BODY	FITS	ITEM#
Z		78-79-80-81	Weatherstrip kit, includes door, trunk and t-top roofrail weatherstrips	2DR CPE	78-81 Chevrolet Camaro, Pontiac Firebird, 2 Door Coupe	KIT311XT
Z		78-79-80-81	Weatherstrip kit, includes door weatherstrip, trunk weatherstrip, hood to cowl seal, hood to cowl seal clip kit, bumper kit, t-top weatherstrip, window weatherstrip	2DR CPE	78-81 Chevrolet Camaro, Pontiac Firebird, 2 Door Coupe	KIT311AT
Z		82-83-84-85-86-87-88-89-90-91-92	Weatherstrip kit, includes hood to cowl seal with clips, door weatherstrips, roofrail weatherstrips, hatch seal, outer window weatherstrips only	2DR CPE	82-92 Chevrolet Camaro, Pontiac Firebird 2 Door Coupe	KIT312
Z		82-83-84-85-86-87-88-89-90-91-92	Weatherstrip kit, includes trunk weatherstrip, door weatherstrip, hood to cowl seal with clips, window weatherstrip, and t-top weatherstrip	2DR CPE	82-92 Chevrolet Camaro, Pontiac Firebird, 2 Door Coupe	KIT312T
Z		82-83-84-85-86-87-88-89-90-91-92	Weatherstrip kit, includes trunk weatherstrip, door weatherstrip, roofrail weatherstrip	2DR CPE	82-92 Chevrolet Camaro, Pontiac Firebird, 2 Door Coupe	KIT312X
Z		82-83-84-85-86-87-88-89-90-91-92	Weatherstrip kit, includes trunk, door and t-top roofrail weatherstrip	2DR CPE	82-92 Chevrolet Camaro, Pontiac Firebird, 2 Door, Coupe	KIT312XT



WHAT IS A PRODUCT CODE?

Our catalog is grouped by product CODE (type) then years. See page 1 for details explaining the different Product CODES.



GUIDE TO SOFFSEAL'S PRODUCT CODES









B = Bumper sets **C** = Glass channels **D** = Door related **G** = Seals, gaskets **H** = Under hood items **I** = Interior parts
M = Miscellaneous items **R** = Roofrail, pillar post & convertible items **T** = Trunk related **W** = Window related **Z** = Weatherstrip kits

Chevrolet • Caprice



CODE	IMAGE	YEAR	DESCRIPTION	BODY	FITS	ITEM#
B		65	Hood side bumpers	2DR 4DR HTP 2DR SDN CNV SWG	65 Chevrolet Biscayne, Impala, Bel Air, Caprice, Chevelle, Malibu, 65 Cadillac, 65 Oldsmobile, 65 Buick, 65 Pontiac	2182
B		66-67-68-69-70-71-72	Hood side bumpers	2DR 4DR SDN HTP CNV	66-72 Chevrolet Biscayne, Bel Air, Impala, Caprice, 73-75 Nova, 66-72 Cadillac, 66-72 Oldsmobile, 66-72 Buick, 66-72 Pontiac	2179
B		66-67-68-69-70-71-72	Bumper kit, includes: door hood trunk glove box	2DR 4DR HTP 2DR SDN CNV SWG	66 Chevrolet Biscayne, Bel Air, Impala, Caprice, 68-69 Chevelle, 70-71 Chevelle, Monte Carlo, 72 Chevelle, 66-72 Cadillac, 66-72 Oldsmobile, 66-72 Buick, 66-72 Pontiac	2371
B		67-68-69-70	Door bumpers	2DR 4DR HTP 2DR SDN CNV SWG	67-70 Chevrolet Biscayne, Bel Air, Impala Caprice, 67-70 Cadillac Calais, Deville, Fleetwood, 67-70 Oldsmobile 88, 98, 67-70 Buick LeSabre, Wildcat, Electra, 67-70 Pontiac	2323
B		67-68-69-70	Bumper kit, includes: door hood trunk glove box	2DR HTP 2DR SDN	67-70 Chevrolet Biscayne, Bel Air, Impala, Caprice, 2 Door Hardtop Sedan	2372
B		77-78-79-80-81-82-83-84-85-86-87-88-89-90	Hoodsides bumpers	2DR HTP	77-90 Chevrolet Caprice, Impala 78-88 Chevrolet El Camino, Malibu, Monte Carlo, 2 Door Hardtop	2373
D		65-66	Door weatherstrip with clips & molded ends	2DR HTP CNV	65-66 Chevrolet Impala, Caprice, 65-66 Cadillac Calais, Deville, 65-66 Oldsmobile 88, Starfire, Oldsmobile 98, 65 Jet Star, 65-66 Buick LeSabre, Wildcat Electra, 65-66 Pontiac 2 Door Hardtop Convertible	2331
D		67-68	Door weatherstrip with clips & molded ends	CNV 2DR HTP	67-68 Chevrolet Impala, Caprice, Except 68 Caprice 2 Door Hardtop, 67-68 Cadillac Calais, Deville, 67-68 Oldsmobile 88 Oldsmobile 98, 67-68 Buick Electra, Wildcat, 67 Pontiac Catalina, Bonneville, Executive, 67 Grand Prix Convertible 2 Door Hardtop	2342
D		69-70	Door weatherstrip with clips & molded ends	2DR HTP CNV	69-70 Chevrolet Impala, Caprice, 69-70 Cadillac Calais, Deville, 69-70 Oldsmobile 88 Oldsmobile 98, 69-70 Buick LeSabre, Wildcat, Electra, 69-70 Pontiac Catalina, Bonneville, Executive, 2 Door Hardtop Convertible	2357
D		69-70	Rear door weatherstrip	SWG 4DR	69-70 Chevy Biscayne, Bel Air, Impala, Caprice, Estate, Oldsmobile Vista Cruiser, Pontiac Catalina, Bonneville, Executive, Gm Fullsize Station Wagon 4 Door	2519
D		71-72-73-74	Door weatherstrip rear door with clips & molded ends	4DR HTP	71-74 Chevrolet Caprice, Impala, Buick LeSabre, Centurion, Oldsmobile 88, Pontiac, 4 Door Hardtop	2214
D		71-72-73-74-75-76	Door weatherstrip front doors with clips & molded ends	4DR HTP	71-76 Chevrolet Caprice, Impala, Buick, Electra, LeSabre, Centurion, Cadillac Calais, Deville, Oldsmobile 88 Oldsmobile 98, Catalina, Bonneville, Granville, 4 Door Hardtop	2213

Chevrolet • Caprice

CODE	IMAGE	YEAR	DESCRIPTION	BODY	FITS	ITEM#
D		71-72-73-74-75-76	Door weatherstrip rear with clips & molded ends	SWG 4DR	71-76 Chevrolet Bel Air, Caprice, Impala, Brookwood, Townsman, Kingswood, Oldsmobile Custom Cruiser, Pontiac Grand Safari, Buick Estate Wagon, 4 Door Station Wagon	2227
D		71-72-73-74-75-76	Door weatherstrip with clips & molded ends	2DR HTP CNV	71-76 Chevrolet Impala, Caprice, Cadillac Calais, Deville, Buick 71-73 LeSabre, Centurion, Electra, 74-76 LeSabre, Electra, Oldsmobile 88 Oldsmobile 98, Pontiac Bonneville, Catalina, 71-75 Grandville 2 Door Hardtop Convertible	2512
D		75-76	Rear Door weatherstrip with clips & molded ends	4DR HTP	75-76 Chevrolet Impala, Caprice, Buick, LeSabre, Centurion, Oldsmobile 88, Pontiac, 4 Door Hardtop	2216
D		77-78-79-80-81-82-83-84-85-86	Front door weatherstrip with clips	4DR SDN RWD	77-86 Impala Caprice, 77-84 Cadillac Deville Fleetwood, 85-86 Fleetwood, 77-84 Oldsmobile 88 89, 85 88, 77-84 Buick LeSabre Electra 85 LeSabre, 77-79 Buick Estate Wagon, 82-83 Buick Park Ave 77-81 Pontiac Bonneville, 83-86 Pontiac Parisienne, 77-80 Pontiac Catalina 4 Door Sedan, RWD Only	2500
D		77-78-79-80-81-82-83-84-85-86-87	Door weatherstrip with clips	2DR SDN RWD	84-87 Chevrolet Caprice, 77-81 Chevrolet Impala, 83 Chevrolet, 77-84 Cadillac Deville, 80-84 Fleetwood, 77-84 Oldsmobile 88 Oldsmobile 98, 85 Oldsmobile 88, 77-84 Buick LeSabre, Electra, 85 LeSabre, 77-81 Pontiac Bonneville, Catalina 2 Door Sedan, RWD Only	2359
D		77-78-79-80-81-82-83-84-85-86-87-88-89-90	Rear door weatherstrip with clips	4DR SDN RWD	77-86 Chevrolet Impala Caprice, 87-88 Caprice Caprice Classic, 89 Caprice, 90 Caprice Caprice Classic, 77-84 Cadillac Deville, 77-85 Oldsmobile 88, 77-78 Town Sedan, Custom Crusier, 77-84 Buick LeSabre Electra 85 LeSabre, 77-81 Pontiac Bonneville, Catalina, 83-86 Pontiac Parisienne 4 Door Sedan, RWD Only	2502
D		77-78-79-80-81-82-83-84-85-86-87-88-89-90	Rear door weatherstrip with clips	4 DR SWG, RWD	77-86 Chevrolet Impala Caprice, 87-88 Caprice Caprice Classic, Cadillac, 77-85 Oldsmobile Custom Cruiser, 77-88 Estate Station Wagon, 77-81 Catalina Safari Bonneville Safari, 82 Bonneville Safari, 83 Bonneville Parisienne, 84-89 Parisienne Station Wagon, RWD Only	2503
D		82-83-84-85-86-87-88-89-90-91-92	Door weatherstrip front/rear	All	82-89 Skyhawk 92-97 Skylark 82-88 Cimarron 93-96 Fleetwood 82-94 Beretta 82-94 Cavalier 91-96 Caprice 82-96 Corsica 82-94 Lumina 82-93 S10 83-94 S10 Blazer 82-05 Chev Van 83-94 GMC Jimmy 82-93 GMC Sonoma 82-05 GMC Van 82-94 Achieva 82-85 Custom Cruiser 82-94 Firenza 82-94 Grand Am 82-94 Sunbird	9110
D		87-88-89-9087-88-89-90	Front door weatherstrip with clips	4DR SDN RWD Only	87-90 Chevrolet Caprice, Caprice Classic Brougham, 87-90 Cadillac, 87-90 Oldsmobile, 87-90 Buick, Pontiac, 4 Door Sedan, RWD Only	2501



GUIDE TO SOFFSEAL'S PRODUCT CODES













B = Bumper sets **C** = Glass channels **D** = Door related **G** = Seals, gaskets **H** = Under hood items **I** = Interior parts
M = Miscellaneous items **R** = Roofrail, pillar post & convertible items **T** = Trunk related **W** = Window related **Z** = Weatherstrip kits

Chevrolet • Caprice



CODE	IMAGE	YEAR	DESCRIPTION	BODY	FITS	ITEM#
D		91-92-93-94-95-96	Door weatherstrip frt or rear	4DR SDN SWG RWD	91-96 Chevrolet Caprice, 4 Door Sedan Station Wagon, RWD	2602
G		61-62-65-66-67-68	Door handle & lock gaskets	2DR 4DR HTP 2DR SDN CNV SWG	61-62 Chevrolet Biscayne, Bel Air, Impala, Cadillac, Oldsmobile 88 Oldsmobile 98, Buick LeSabre, Invicta, Electra, Pontiac	2145
G		65-66	Steering column seal fits all	2DR 4DR HTP 2DR SDN CNV SWG	65-66 Chevrolet Impala Biscayne Caprice Bel Air	2405
G		65-66-67	Cowl vent panel to cowl seals	2DR 4DR SDN HTP CNV	65-67 Chevrolet All	2340
G		66	Park lens gaskets	2DR 4DR HTP SWG CNV	66 Chevrolet All	2388
G		67	Park light lens gaskets	2DR SDN 2DR 4DR HTP CNV SWG	67 Chevrolet Impala Bel Air Caprice Biscayne	2382
G		67	Rear bumper to body seal	2DR SDN 2DR 4DR HTP CNV SWG	67 Chevrolet Biscayne Bel Air Impala Caprice	2346
G		67-68	Steering column seal fits all	2DR 4DR HTP 2DR SDN CNV SWG	67-68 Chevrolet Impala Biscayne Caprice Bel Air	2406
G		68	Quarter panel extension seal	2DR 4DR HTP 2DR SDN CNV SWG	68 Chevrolet Impala Caprice	2364
G		68	Taillight lens gaskets 6 piece	2DR SDN 2DR 4DR HTP CNV SWG	68 Chevrolet Impala Caprice Bel Air	2383
G		68	Rear side marker light	2DR 4DR HTP SWG CNV	68 Chevrolet All	23841
G		68	Front side marker gaskets	2DR 4DR HTP SWG CNV	68 Chevrolet All	23842
G		68	Rear body to bumper seal	2DR 4DR HTP 2DR SDN CNV SWG	68 Chevrolet Impala Biscayne Caprice Bel Air	2408
G		69-70	Steering column seal	2DR 4DR HTP 2DR SDN CNV SWG	69-70 Chevrolet Impala Biscayne Caprice Bel Air	2402
G		70	Taillight lens gaskets	2DR 4DR HTP CNV	70 Chevrolet Impala	2389
G		70	Park light lens gaskets	2DR 4DR HTP SWG CNV	70 Chevrolet	23891

Chevrolet • Caprice

CODE	IMAGE	YEAR	DESCRIPTION	BODY	FITS	ITEM#
H		64-65-66-67-68-69-70-71-72	Firewall wiring gutter plk	2DR 4DR HTP 2DR SDN SWG CNV	Chevy Chevelle, Biscayne, Bel Air, Impala, Caprice, Nova, Camaro, Cadillac Calais, Deville, Fleetwood, Oldsmobile 88, 98, Jetstar, Starfire, Pontiac Catalina, Bonneville, Firebird, Buick Lesabre, Wildcat, Electra	2328
H		67	Hood insulation with clips	2DR 4DR HTP 2DR SDN CNV SWG	67 Chevrolet Biscayne Bel Air Impala Caprice	2391
H		69-70	Hood insulation with clips	2DR 4DR HTP 2DR SDN CNV SWG	69-70 Chevrolet Impala Biscayne Caprice Bel Air	2403
H		71-72-73-74-75-76-77-78	Hood to cowl seal	2DR SDN 2DR HTP CNV SWG	71-78 Chevrolet Impala, Caprice, Biscayne, Bel Air, Brookwood, Townsman, Kingswood, Buick Lesabre, Centurion, Electra 225, Estate Wagon, Cadillac Calais, Deville, Eldorado, Sixty Special Brougham, Oldsmobile 88, 98, Tornado, Pontiac Catalina, Bonneville, Grandville, Safari Full Size	2191
I		58-59-60-61-62-63-64-65-66-67	Accelerator pedal	2DR 4DR HTP 2DR SDN CNV SWG	58-67 Chevrolet Del Ray Biscayne Bel Air Impala Caprice, 62-67 Chevy II	2068
I		65-66-67-68-69-70	Accelerator pedal pad trim fit part 2069	2DR 4DR HTP SDN SWG CNV	65-70 Chevrolet Biscayne, Bel Air, Impala, Caprice, 2 Door 4 Door Hardtop Sedan Station Wagon Convertible	2069A
I		65-66-67-68-69-70	Automatic brake pedal pad with disc brakes	2DR SDN 2DR 4DR HTP CNV SWG	65-70 Chevrolet Biscayne, Bel Air, Impala, Caprice	20642
I		65-66-67-68-69-70	Parking brake pedal pad	2DR SDN 2DR 4DR HTP CNV SWG	65-70 Chevrolet Biscayne, Bel Air, Impala, Caprice	20671
M		57-58-59-60-61-62-63-64-65-66-67-68-69-70-71-72-73-74-75-76-77-78-79-80-81	Bellhousing to clutch fork rubber boot	2DR 4DR HTP SDN CNV SWG	57-81 GM All Manual Transmission	2196
M		58-59-60-61-62-63-64-65	Power brake pedal pad with standard trans	2DR 4DR HTP SDN CNV SWG	58-65 Full-Size Chevrolet Biscayne Bel Air Impala Caprice, 58-62 Corvette, 58 Del Ray, 2 Door 4 Door Hardtop Sedan Convertible Station Wagon	20651
M		58-59-60-61-62-63-64-65	Automatic power brake pad	2DR 4DR HTP SDN CNV SWG	58-65 Chevrolet Del Ray Biscayne Bel Air, 62-67 Chevy II Nova Caprice, 63-67 Corvette, 2 Door 4 Door Hardtop Sedan Convertible Station Wagon	2063
M		58-59-60-61-62-63-64-65-66-67	Standard brake & clutch pedal pads	2DR 4DR HTP 2DR SDN CNV SWG	58-67 Chevrolet Del Ray Biscayne Bel Air Impala, 62-67 Chevy II, Nova Caprice 58-62 Corvette	2065
M		65-66	Body mount bolt kit	2DR HTP 2DR SDN	65-66 Chevrolet Impala Caprice Bel Air Biscayne, 2 Door Hardtop, Sedan	2398



GUIDE TO SOFFSEAL'S PRODUCT CODES







B = Bumper sets **C** = Glass channels **D** = Door related **G** = Seals, gaskets **H** = Under hood items **I** = Interior parts
M = Miscellaneous items **R** = Roofrail, pillar post & convertible items **T** = Trunk related **W** = Window related **Z** = Weatherstrip kits

Chevrolet • Caprice



CODE	IMAGE	YEAR	DESCRIPTION	BODY	FITS	ITEM#
M		65-66	Body mount kit	2DR HTP 2DR SDN	65-66 Chevrolet Impala Caprice, Biscayne, Bel Air, 2 Door Hardtop, Sedan	2392
M		65-67-68	Firewall clutch rod boot	2DR HTP CNV 2DR SDN	65-68 Chevrolet Impala Caprice Corvette	2516
M		66-67-68	Radiator support bushings & hardware kit	2DR 4DR HTP SDN CNV SWG	66-68 Chevrolet Biscayne Impala Caprice Bel Air, 2 Door 4 Door Hardtop Sedan Convertible Station Wagon	2407
M		67-68	Body mount kit	2DR HTP 2DR SDN	67-68 Chevrolet Impala Caprice Bel Air Biscayne, 2 Door Hardtop, Sedan	2394
M		67-68	Body mount bolt kit	2DR HTP 2DR SDN CNV	67-68 Chevrolet Impala Caprice Bel Air Biscayne, 2 Door Hardtop Sedan Convertible	2400
M		69-70	Body mount bolt kit	2DR HTP SDN CNV	69-70 Chevrolet Impala Caprice Bel Air Biscayne, 2 Door Hardtop Sedan Convertible	2401
R		65-66	Roofrail weatherstrip with molded ends	2DR HTP	65-66 Chevrolet Impala, Caprice, 65-66 Cadillac Calais, Deville, 65-66 Oldsmobile 88, Jet Star, Star Fire, Oldsmobile 98, 65-66 Buick LeSabre, Wildcat, Electra, 65-66 Pontiac 2 Door Hardtop	2333
R		65-66	Roofrail weatherstrip with molded ends	4DR HTP	65-66 Chevrolet Impala, Caprice, 65-66 Cadillac, 65-66 Oldsmobile 88, 65-66 Buick LeSabre, 65-66 Pontiac, 4 Door Hardtop	2333A
R		67-68	Roofrail weatherstrip with thick c pillar section	4DR HTP	67-68 Chevrolet Impala, Caprice, Buick LeSabre, Wildcat, Pontiac Bonneville, Catalina, Executive 4 Door Hardtop	2351
R		67-68	Roofrail weatherstrip with molded ends	2DR HTP	67-68 Chevrolet Impala, Caprice, 67-68 Cadillac, 67-68 Oldsmobile 88, 67-68 Buick Electra, Wildcat, 67-68 Pontiac Catalina, Executive 2 Door Hardtop	2345
R		69-70	Roofrail weatherstrip with molded ends	2DR HTP	69-70 Chevrolet Caprice, Impala, 69-70 Cadillac, 69-70 Oldsmobile 88, 69-70 Buick LeSabre, Wildcat, 69-70 Pontiac 2 Door Hardtop	2356
R		69-70	Roofrail weatherstrip	4DR HTP	69-70 Chevrolet Impala, Caprice, 69-70 Oldsmobile 88 Oldsmobile 98, 69-70 Buick LeSabre, Wildcat, Electra, 69-70 Pontiac Catalina, Bonneville, Executive 4 Door Hardtop	23561
R		69-70	Pillar post weatherstrip with molded ends	CNV	69-70 Chevrolet Impala, Caprice, 69-70 Cadillac Deville, 69-70 Oldsmobile 88 Oldsmobile 98, 69-70 Buick LeSabre, Wildcat, Electra, 69-70 Pontiac, Convertible	2358
R		71-72-73-74	Roofrail weatherstrip	4DR HTP	71-74 Chevrolet Caprice, Impala, Buick LeSabre, Centurion, Oldsmobile 88, Pontiac Catalina, Bonneville 4 Door Hardtop	2221

Chevrolet • Caprice

CODE	IMAGE	YEAR	DESCRIPTION	BODY	FITS	ITEM#
R		71-72-73-74-75	Roofrail weatherstrip	2DR HTP	71-73 Impala Custom Coupe Caprice, 74-75 Impala Sport Coupe, 71-76 Cadillac Calais Deville, 71-74 Electra, 74-76 LeSabre, 71-71 98, 74 Oldsmobile 98 Oldsmobile Delta 88, 75-76 Oldsmobile Delta 88, 71-73 Grandville, 74 Bonneville Catalina Grandville, 75-76 Catalina, 2 Door Hardtop	2509
R		71-72-73-74-75-76	Weatherstrip kit for convertible top	CNV	71-72 Chevrolet Impala, 73-76 Caprice, 71-76 Cadillac Eldorado, 71-75 Oldsmobile Delta 88, 71,72, 74 Buick LeSabre 71-73 Centurion, 71-72 Pontiac Catalina, 71-75 Grandville Convertible	2508
R		71-72-73-74-75-76	Header seal	CNV	71-75 Chevrolet Impala, Caprice, 71-72 Oldsmobile 88, 71-75 Pontiac Catalina, Grandville, 71-75 Buick Lesabre, Centurion, 71-76 Cadillac Eldorado, Convertible	2515
R		71-72-73-74-75-76	Pillar post weatherstrip with molded ends	CNV	71-75 Chevrolet Impala, Caprice 71-72 Oldsmobile 88, 71-75 Pontiac Catalina, Grandville, 71-75 Buick Lesabre, Centurion 71-76 Cadillac Eldorado, Convertible	2094
T		62-63-64-65-66-67-68-69-70-71-72-73	Door and tailgate bottom drain hole seal	2DR 4DR HTP SDN CNV SWG CPE	62-73 Chevy Nova, Chevelle, Impala, Caprice Pontiac Catalina, Star Chief, Bonneville, Grand Prix Oldsmobile F85	2118
T		64-65-66-67-68-69-70-71-72-73-74-75-76-77	Trunk weatherstrip exact profile length 17 feet	2DR 4DR HTP 2DR SDN CNV	65-72 Chevy II, 65-72 Chevrolet Biscayne, 65-75 Chevrolet Bel Air, 65-76 Chevrolet Impala, 65-76 Chevrolet Caprice, 64-77 Chevrolet Chevelle, 70-77 Chevrolet Monte Carlo, 65-76 Buick LeSabre, 64-77 Buick Wildcat, 64-77 Buick Skylark, 71-73 Buick Centurion, 64-72 Buick Grand Special, 73-77 Buick Century, 73-88 Buick Regal, 73-88 Buick Grand National, 65-76 Buick Electra, 65-76 Oldsmobile Delta 88, 67-69 Oldsmobile Delmont 88, 65-66 Oldsmobile Dynamic 88, 65-66 Oldsmobile Starfire, 65 Oldsmobile Jetstar, 64-77 Oldsmobile Cutlass 442, 64-88 Oldsmobile Cutlass, 65-76 Oldsmobile 98, 65-76 Pontiac Parisienne, 64-72 Pontiac LeMans, 65-70 Pontiac Catalina, 65-66 Pontiac Star Chief, 67-70 Pontiac Executive, 71-75 Pontiac Grand Ville, 65-77 Pontiac Grand Prix, 64-72 Pontiac Tempest, 62-72 Nova, Ventura, 73-74 Non-Hatchback, Up to 1975 with groove channel, Apollo, Nova, Omega, Ventura 65-76 C-Body	2003



GUIDE TO SOFFSEAL'S PRODUCT CODES













B = Bumper sets **C** = Glass channels **D** = Door related **G** = Seals, gaskets **H** = Under hood items **I** = Interior parts
M = Miscellaneous items **R** = Roofrail, pillar post & convertible items **T** = Trunk related **W** = Window related **Z** = Weatherstrip kits

Chevrolet • Caprice



CODE	IMAGE	YEAR	DESCRIPTION	BODY	FITS	ITEM#
T		75-76-77-78-79-80-81-82-83-84-85-86-87-88-89-90-91-92	Trunk and Hatchback weatherstrip	2DR 4DR SDN HTP CNV	77-85 Chevrolet Impala, 77-91 Chevrolet Caprice, 82-92 Chevrolet Camara, 75-79 Chevrolet Nova, 78-88 Chevrolet Monte Carlo, 78-83 Chevrolet Malibu, 78-83 Pontiac LeMans, 82-92 Pontiac Firebird, 75-91 Pontiac Ventura, 77-86 Pontiac Parisienne, 77-81 Pontiac Catalina, 69-88 Pontiac Grand Prix, 64-87 Pontiac LeMans, Pontiac Grand Am, 64-77 Pontiac GTO, 73-79 Oldsmobile Omega, 77-85 Oldsmobile Delta 88, 77-84 Oldsmobile 98, 77-88 Oldsmobile Cutlass, 73-75 Buick Apollo, 76-79 Buick Skylark, 77-79 Phoenix, 73-88 Buick Regal, 77-84 Buick Electra, 77-85 Buick LeSabre, 77-78 Buick Riviera, 77-91 C-Body	2424
W		61-62-63-64-65-66	Horizontal outer window seals	2DR 4DR HTP SDN CNV SWG	Chevy Biscayne, Bel Air, Impala, Caprice, Cadillac series 62 Deville, Eldorado, Fleetwood, Calais, Oldsmobile 88, Starfire, 98. Buick Lesabre, Invicta, Wildcat, Electra, Pontiac Catalina, Ventura, Star Chief, Bonneville	2310
W		65-66	Quarter window seals	2DR HTP CNV	65-66 Chevrolet Impala, 66 Chevrolet Caprice, 65-66 Cadillac Calais, Deville 65-66 Oldsmobile 88, Jetstar, 65-66 Buick LeSabre, Wildcat, 65-66 Pontiac Bonneville, Catalina, Star Chief 2 Door Hardtop Convertible	2301
W		65-66	Quarter window seals	4DR HTP	65-66 Chevrolet Impala, 66 Chevrolet Caprice, 65-66 Cadillac Calais, Deville, 65-66 Oldsmobile 88 Oldsmobile 98, 65-66 Buick LeSabre, Wildcat, Electra, 65-66 Pontiac Bonneville, Catalina, Star Chief 4 Door Hardtop	23011
W		65-66	Door u-jamb seal	2DR HTP CNV	65-66 Chevrolet Impala, 66 Caprice, 65-66 Cadillac Calais, Deville, Eldorado, 65-66 Oldsmobile 88, Jetstar, Starfire, Oldsmobile 98, 65-66 Buick LeSabre, Wildcat, Electra, 65 Pontiac Bonneville, Catalina, Star Chief 2hardtop Convertible	2368
W		65-66-67-68	Vent window weatherstrip	2DR SDN SWG 4DR	65-68 2 Door 4 Door Sedan And Station Wagon	2284
W		65-66-67-68	Glass run channel front window	2DR HTP CNV	65-68 Chevrolet Impala, Caprice, 65-68 Cadillac Calais, Deville 65-66 Eldorado, 65-68 Oldsmobile 88 Oldsmobile 98, 65-66 Oldsmobile Jetstar, Starfire, 65-68 Buick LeSabre, Wildcat, Electra, 65-68 Pontiac Bonneville, Catalina, Executive 2 Door Hardtop Convertible	2350
W		66	Window weatherstrip replacement style	2DR HTP	66 Chevrolet Caprice Custom 2 Door Hardtop	23371

Chevrolet • Caprice

CODE	IMAGE	YEAR	DESCRIPTION	BODY	FITS	ITEM#
W		67-68	Quarter window u-jamb	2 DR CNV HTP	67-68 Chevy Impala Convertible 68 Caprice Sport Coupe, 67 Buick Lasabre, Wildcat Convertible, 67 Electra 2 Door Hardtop & Convertible, 68 Buick Wildcat, Electra, Lesabre 2 Door Hardtop & Convertible, 67 Cadillac Deville Convertible, 68 Cadillac Calais, Deville Hardtop & Convertible 67-68 Oldsmobile 88, Oldsmobile 98, 67-68 Pontiac Catalina, Bonneville, Executive, Grand Prix Hardtop & Convertible	2294
W		67-68	Quarter window seals	2DR HTP	67-68 Chevrolet Impala, 67-68 Cadillac Calais, Deville 67-68 Oldsmobile 88, 98, 67-68 Buick LeSabre, Wildcat, Electra 67-68 Pontiac Catalina, Bonneville, Executive 2 Door Hardtop	2302
W		67-68	Window weatherstrip replacement style	2DR HTP	67-68 Chevrolet Caprice Custom, Impala 2 Door Hardtop	2341
W		68	Window weatherstrip replacement style	2DR HTP	68 Chevrolet Caprice, 2 Door Hardtop	2344
W	 IMAGE COMING SOON	69-70	Window weatherstrip replacement style	2DR HTP	69-70 Chevrolet Caprice Custom Impala Custom 2 Door Hardtop	2361
W		71-72-73	Qtr window u jamb	2DR HTP CNV	71-73 Buick LeSabre, Electra, Riviera, Chevrolet Impala, Caprice, Cadillac Calais, Deville, Oldsmobile 88 Oldsmobile 98, Pontiac Catalina, Bonneville, Grandville 2 Door Hardtop Convertible	2600
W		71-72-73-74-75	Window weatherstrip replacement style outer only	CNV	71-75 Chevrolet Impala, Caprice Convertible	2425
W		71-72-73-74-75-76	Window weatherstrip door outers only replacement style	2DR HTP	71-76 Chevrolet Impala Caprice 2 Door Hardtop	2426
W		71-72-73-74-75-76	Quarter window seals	2DR HTP CNV	71-75 Chevrolet Impala, Caprice, 71-76 Cadillac Eldorado Convertible Only, 71-76 Oldsmobile 88, 76 Oldsmobile 98, 71-73 Buick LeSabre, 71-73 Centurion, 71-75 Pontiac Catalina, Bonneville, Grandville 2 Door Hardtop Convertible	2308
W		71-72-73-74-75-76	Quarter window seals	4DR HTP	71-75 Chevrolet Impala, Caprice, Cadillac Calais, Deville, Pontiac Catalina, Bonneville, Grandville Buick Lesabre, Electra, Oldsmobile 88, 98, 4 Door Hardtop	2309
W		74-75-76	Quarter window u-jamb	2DR HTP CNV	Impala Caprice LeSabre Electra Eldorado Oldsmobile Delta 88 Oldsmobile 98, Tornado Delta Bonneville Catalina Grandville Catalina	2295
W		77-78-79-80-81-82-83-84-85-86-87-88-89-90	Window weatherstrip outers only, rwd with chrome bead	2DR SDN	77-90 Chevrolet Impala, Caprice, Buick LeSabre, Electra, Oldsmobile 88 Oldsmobile 98, Pontiac Catalina, Bonneville, Cadillac Deville, 2 Door Sedan	2369



GUIDE TO SOFFSEAL'S PRODUCT CODES











B = Bumper sets **C** = Glass channels **D** = Door related **G** = Seals, gaskets **H** = Under hood items **I** = Interior parts
M = Miscellaneous items **R** = Roofrail, pillar post & convertible items **T** = Trunk related **W** = Window related **Z** = Weatherstrip kits

Chevrolet • Caprice



CODE	IMAGE	YEAR	DESCRIPTION	BODY	FITS	ITEM#
W		77-78-79-80-81-82-83-84-85-86-87-88-89-90	Window weatherstrip, outers only, rwd, with o chrome bead	2DR SDN	77-90 Chevrolet Impala, Caprice, Buick LeSabre, Electra, Oldsmobile 88 Oldsmobile 98, Pontiac Catalina, Bonneville, Cadillac Deville, 2 Door Sedan	23691
Z		66	Weatherstrip kit, includes a arm seals, door weatherstrips, quarter window seals, roofrail weatherstrips, trunk weatherstrip, window weatherstrips, hood to cowl seal, bumper kit	2DR HTP	66 Chevrolet Caprice 2 Door Hardtop	KIT222A

Chevrolet • Cavalier

CODE	IMAGE	YEAR	DESCRIPTION	BODY	FITS	ITEM#
D		82-83-84-85-86-87	Door Weatherstrips	Cnv	82-87 Chevrolet Cavalier, Pontiac Sunbird	8703
D		82-83-84-85-86-87-88-89-90-91-92	Door weatherstrip front/rear	All	82-89 Skyhawk 92-97 Skylark 82-88 Cimarron 93-96 Fleetwood 82-94 Beretta 82-94 Cavalier 91-96 Caprice 82-96 Corsica 82-94 Lumina 82-93 S10 83-94 S10 Blazer 82-05 Chev Van 83-94 GMC Jimmy 82-93 GMC Sonoma 82-05 GMC Van 82-94 Achieva 82-85 Custom Cruiser 82-94 Firenza 82-94 Grand Am 82-94 Sunbird	9110
D		88-89-90-91-92-93-94	Door weatherstrips	Cnv	88-94 Chevrolet Cavalier, Pontiac Sunbird Convertible	8704
D		95-96-97-98-99-00	Door Weatherstrips	CNV	95-00 Chevrolet Cavalier, Pontiac Sunfire Convertible	8700
R		82-83-84-85-86-87-88-89-90-91-92-93-94	Convertible top kit	CNV	82-94 Chevrolet Cavalier, Pontiac Sunbird Convertible	8705
R		95-96-97-98-99-00	Header seal	CNV	95-00 Chevrolet Cavalier, Pontiac Sunfire Convertible	8701
R		95-96-97-98-99-00	Roofrail weatherstrips	CNV	95-00 Chevrolet Cavalier, Pontiac Sunfire Convertible	8702
T		82-83-84-85-86-87-88-89-90-91-92-93-94-95-96-97-98-99-00	Trunk weatherstrip	CNV	82-00 Chevrolet Cavalier Pontiac Sunbird, Sunfire Convertible	8706
W		83-84-85-86-87-88-89-90-91-92-93-94	Quarter Window Leading Edge Seal, CNV only	CNV	83-94 Pontiac Sunbird, Chevrolet Cavalier	8708
W		88-89-90-91-92-93-94	Rear of Door Glass Seal	CNV	88-94 Cavalier, Sunbird	8707



WHAT IS A PRODUCT CODE?
 Our catalog is grouped by product CODE (type) then years. See page 1 for details explaining the different Product CODES.



GUIDE TO SOFFSEAL'S PRODUCT CODES						
B = Bumper sets	C = Glass channels	D = Door related	G = Seals, gaskets	H = Under hood items	I = Interior parts	Z = Weatherstrip kits
M = Miscellaneous items	R = Roofrail, pillar post & convertible items		T = Trunk related	W = Window related		



CODE	IMAGE	YEAR	DESCRIPTION	BODY	FITS	ITEM#
B		59-60-61-62-63-64-65-66-67	Door bumpers	2DR HTP 2DR SDN 2DR SDN CNV SWG	59-67 Chevrolet, Pontiac, Oldsmobile, Buick, Cadillac, 62-67 Chevy II, Nova, 66-67 Chevrolet Chevelle, Oldsmobile Cutlass, Buick Skylark, Pontiac Tempest, LeMans, GTO	2320
B		62-63-64	Seat back bumpers	2DR HTP CNV	62-64 Chevrolet Impala, Nova, Chevelle, El Camino, For SS	2172
B		62-63-64-65-66-67-68-69-70-71-72-73-74-75	Trunk bumpers	2DR HTP 2DR SDN CNV	70-75 Chevrolet Camaro, Pontiac Firebird, 62-73 Chevy II Nova, 64-72, Pontiac GTO, Tempest, Le Mans, Chevrolet Chevelle, Monte Carlo, Buick Skylark, Oldsmobile Cutlass, 65-69 Chevrolet Corvair, 65-70 Full Size Chevrolet	3112
B		63-64	Hood side bumpers	2DR 4DR HTP 2DR SDN CNV SWG	63-64 Chevrolet Biscayne, Impala, Bel Air, 64 Chevelle	2181
B		64	Bumper kit, includes: door hood trunk glove box	2DR HTP 2DR SDN CNV	64 Chevrolet Chevelle	5104
B		64-65-66	Door bumpers	2DR 4DR HTP 2DR SDN CNV SWG	64-66 Chevrolet Chevelle, El Camino, Nova, Pontiac GTO, Tempest, LeMans, Buick Skylark, Oldsmobile Cutlass	5080
B		65	Bumper kit, includes: door hood trunk glove box	2DR HTP 2DR SDN CNV	65 Chevrolet Chevelle	5105
B		65	Hood side bumpers	2DR 4DR HTP 2DR SDN CNV SWG	65 Chevrolet Biscayne, Impala, Bel Air, Caprice, Chevelle, Malibu, 65 Cadillac, 65 Oldsmobile, 65 Buick, 65 Pontiac	2182
B		65-66-67-68-69-70-71-72-73-74-75-76-77-78-79-80-81-82-83-84-85-86-87-88-89-90-91-92-93-94-95-96-97-98-99-00-01-02	Door bumpers	2DR 4DR HTP 2DR SDN SWG CNV	65-66 Chevrolet, Pontiac, Oldsmobile, Buick, 65-69 Corvair, 70-02 Chevrolet Camaro, Pontiac Firebird, 68-81 Chevelle, GTO, Cutlass, Skylark, 68-72 El Camino, Tempest, LeMans GTO, 70-72 Monte Carlo	2321
B		66	Bumper kit, includes: door hood trunk glove box	2DR HTP 2DR SDN CNV	66 Chevrolet Chevelle	5106
B		66	Hood side bumpers	2DR 4DR HTP 2DR SDN CNV SWG	66 Chevrolet Chevelle, El Camino	5076
B		66-67	License plate bumpers rear	2DR 4DR HTP 2DR SDN CNV SWG	66-67 Chevrolet Chevelle, El Camino	5081
B		66-67	Bumpers bucket seat back oval 4 per car	2DR HTP CNV 2DR SDN	66-67 Chevrolet Chevelle, El Camino, Nova, Pontiac GTO, Tempest, LeMans, Grand Prix	5085
B		66-67-68-69-70-71-72	Bumper kit, includes: door hood trunk glove box	2DR 4DR HTP 2DR SDN CNV SWG	66 Chevrolet Biscayne, Bel Air, Impala, Caprice, 68-69 Chevelle, 70-71 Chevelle, Monte Carlo, 72 Chevelle, 66-72 Cadillac, 66-72 Oldsmobile, 66-72 Buick, 66-72 Pontiac	2371

Chevrolet • Chevelle

CODE	IMAGE	YEAR	DESCRIPTION	BODY	FITS	ITEM#
B		67	Bumper kit, includes: door hood trunk glove box	2DR HTP 2DR SDN CNV	67 Chevrolet Chevelle	5107
B		67-68-69-70-71-72-73-74-75-76-77	Hood side bumper, 2 pr. required	2DR HTP CNV 2DR SDN SWG	67-69 Chevrolet Camaro Chevelle, 73-77 Monte Carlo,	3024
B		68-69-70-71-72	Rear hood bumpers	2DR 4DR HTP 2DR SDN CNV SWG	68-72 Chevrolet Chevelle 68-70 Chevrolet Impala	5078
B		68-69-70-71-72-73-74-75-76-77	Hood to cowl bumper	2DR SDN 2DR 4DR HTP CNV SWG	68-72 Pontiac GTO, LeMans, 73-77 Chevrolet Monte Carlo, Chevelle	6472
B		69	License panel bumpers rear	2DR 4DR SDN HTP CNV	69 Chevrolet Camaro, Pontiac Firebird, 64-72 Chevrolet Chevelle, Pontiac Tempest, LeMans, GTO, Grand Prix, Oldsmobile Cutlass, Buick Special, Skylark	31151
D		64-65	Door weatherstrip with clips	2DR SWG	64-65 Chevelle 2 Door Station Wagon	5001B
D		64-65	Door weatherstrip with clips	2DR SDN	64-65 Chevrolet Chevelle, Oldsmobile Cutlass, Buick Skylark, Pontiac Tempest, LeMans, GTO, Buick Special 2 Door Sedan	5003
D		64-65	Door weatherstrip with clips & molded ends	2DR HTP CNV	64-65 Chevrolet Chevelle, Pontiac GTO, LeMans, Oldsmobile Cutlass, Buick Skylark 2 Door Hardtop And Convertible	5004
D		64-65-66-67	Door weatherstrip front door with clips	4DR SDN WGN	64-67 Chevrolet Chevelle, Pontiac LeMans, Oldsmobile Cutlass, 4 Door Sedan Wagon	5001
D		64-65-66-67	Door weatherstrip rear door with clips	4DR SDN WGN	64-67 Chevelle, LeMans, Skylark, Cutlass, Except Sport Station Wagon And Vista Cruiser, 4 Door Sedan Station Wagon	5001A
D		64-65-66-67	Tailgate weatherstrip	SWG	64-67 Chevrolet Chevelle, Buick Special, Oldsmobile Vista Cruiser, F85, Pontiac, Station Wagon	5142
D		66-67	Door weatherstrip with clips & molded ends	2DR HTP CNV	66-67 Chevrolet Chevelle 2 Door Hardtop Convertible	5007
D		66-67	Door weatherstrip with clips	2DR SDN	66-67 Chevrolet Chevelle, Pontiac Tempest, LeMans, GTO, Oldsmobile Cutlass, 442, Buick Special, Skylark 2 Door Sedan	5000
D		68	Door weatherstrip with clips & molded ends	2DR HTP CNV	68 Chevrolet Chevelle, Oldsmobile Cutlass, Buick Skylark, 2 Door Hardtop And Convertible	5011
D		68-69-70-71-72	Door weatherstrip front door with clips	4DR SWG	68-72 Chevrolet Chevelle, Pontiac LeMans, Buick Skylark, 68-72 Oldsmobile Cutlass 4 Door Station Wagon	5020



GUIDE TO SOFFSEAL'S PRODUCT CODES

B = Bumper sets **C** = Glass channels **D** = Door related **G** = Seals, gaskets **H** = Under hood items **I** = Interior parts
M = Miscellaneous items **R** = Roofrail, pillar post & convertible items **T** = Trunk related **W** = Window related **Z** = Weatherstrip kits

Chevrolet • Chevelle



CODE	IMAGE	YEAR	DESCRIPTION	BODY	FITS	ITEM#
D		68-69-70-72-72	Door weatherstrip rear door with clips	4DR SDN SWG	68-72 Chevrolet Chevelle, Pontiac LeMans, Buick Skylark, Oldsmobile Cutlass 4 Door Sedan And Station Wagon Except Sport Station Wagon And Vista Cruiser	5020A
D		68-69-70-71-72	Door weatherstrip with clips	2DR SDN	68-72 Chevelle, Pontiac Tempest, LeMans, GTO, Oldsmobile Cutlass 442, Buick Special, Buick Skylark, 2 Door Sedan	5002
D		69-70-71-72	Door weatherstrip with clips & molded ends	2DR HTP CNV	69-72 Chevelle, Grand Prix, Monte Carlo, Skylark, Cutlass, 2 Door Hardtop And Convertible	5022
D		73-74-75-76-77	Door weatherstrip with clips & molded ends	2DR HTP	Grand Am 2 Door 73-77 Chevrolet, LeMans, Grand LeMans, Century, Regal, Cutlass, Chevelle Malibu Laguna, El Camino, 2 Door Hardtop	5017
G		61-62-63-64-65	Outside mirror gasket	2DR 4DR HTP 2DR SDN CNV SWG	61-65 Chevrolet 68-69 Chevelle Malibu El Camino 63-64 Impala Biscayne Bel Air	2306
G		64	Park light lens gaskets	2DR 4DR HTP 2DR SDN CNV SWG	64 Chevrolet Biscayne Bel Air Impala Chevelle El Camino Malibu	2168
G		64	Taillight lens gasket set of 4	2DR HTP 2DR SDN CNV SWG	64-Chevelle El Camino	5184
G		64	Paint gasket set	2DR HTP 2DR SDN CNV	64 Chevelle	51911
G		64-65	License lens gaskets	2DR HTP 2DR SDN CNV SWG	64-65 Chevrolet Chevelle	5182
G		64-65	Hood panel filler seal	2DR HTP 2DR SDN CNV SWG	64-65 Chevrolet Chevelle	5079
G		64-65	Rear body to bumper seals	2DR HTP 2DR SDN CNV SWG	64-65 Chevrolet Chevelle, El Camino	5083A
G		64-65	Side cowl panel to grill seal	2DR 4DR HTP 2DR SDN CNV SWG	64-65 Chevrolet Chevelle, El Camino	5072
G		64-65-66-67	Cowl vent gaskets	2DR 4DR HTP 2DR SDN CNV	64-67 Buick Skylark, Oldsmobile Cutlass, Pontiac GTO, Chevrolet Chevelle	5073
G		64-65-66-67	Steering column sponge seal	2DR SDN CNV 2DR 4DR HTP SWG	64-67 Chevrolet Chevelle, El Camino, Pontiac LeMans, GTO, Oldsmobile Cutlass, Buick Skylark	5162
G		64-65-66-67-68-69-70-71-72	Heater seal kit with o ac	2DR SDN 2DR 4DR HTP CNV SWG	64-72 Chevrolet Chevelle	5088
G		65	Taillight lens gaskets	2DR HTP 2DR SDN CNV SWG	65 Chevelle El Camino	5185

Chevrolet • Chevelle

CODE	IMAGE	YEAR	DESCRIPTION	BODY	FITS	ITEM#
G		65	Paint gasket set	2DR HTP 2DR SDN	65 Chevrolet Chevelle	51851
G		65-66-67	Park light lens gasket	2DR HTP 2DR SDN CNV SWG	65-67 Chevy II Nova, 65-66 Chevelle	4151
G		65-66-67-68-69	Antenna gasket	2DR 4DR SDN HTP CNV	68 Chevrolet 67-69 Chevrolet Camaro, Pontiac Firebird, 68-69 Chevrolet Chevelle, El Camino, 66-69 Chevrolet Nova	2409
G		65-66-67-68-69-70-71-72-73-74-75-76-77-78-79	Mirror gasket	2DR 4DR HTP 2DR SDN CNV SWG	68-69 Chevrolet 65-66 Bel Air Biscayne Impala 67-79 Chevrolet Camaro 66-72 Nova 66-72 Chevelle 70 El Camino 67-68 Pontiac Firebird	2305
G		66	Inner taillight, housing to body seals	2DR HTP 2DR SDN CNV SWG	66 Chevelle El Camino	5186
G		66	Taillight lens gaskets	2DR HTP 2DR SDN CNV SWG	66 Chevelle El Camino	51861
G		66	Taillight, bezel seals	2DR HTP 2DR SDN CNV SWG	66 Chevrolet Chevelle, El Camino	5189
G		66	Paint gasket set	2DR HTP 2DR SDN CNV SWG	66 Chevrolet Chevelle	5366
G		66-67	Quarter panel extension to body seals	2DR HTP 2DR SDN 4DR SDN	66-67 Chevelle El Camino	5187
G		66-67	Heater box to fender seal with a/c	2DR 4DR HTP 2DR SDN CNV SWG	66-67 Chevrolet Chevelle	5087
G		66-67	Remote mirror gasket	ALL BODY STYLES	66-67 Chevrolet All, Nova, Chevelle	2051
G		66-67	Rear body to bumper seals	2DR 4DR HTP 2DR SDN CNV SWG	66-67 Chevrolet Chevelle, El Camino	5083
G		66-67-68-69-70-71-72	License light gasket	2DR 4DR HTP SDN CNV SWG	66-72 Chevy II Nova, Biscayne, Bel Air, Impala, Chevelle, 67-72 Chevrolet Camaro, Pontiac Firebird	2378
G		66-67-68-69-70-71-72	Door handle & lock gaskets set	2DR HTP 2DR SDN CNV	67-69 Chevrolet Camaro, Pontiac Firebird, 66-72 Chevy II Nova, 64-72 Chevrolet Chevelle, Pontiac Tempest, LeMans, GTO, Buick Skylark, Oldsmobile Cutlass, 70-72 Chevrolet Monte Carlo	3021
G		67	Taillight lens gasket	2DR HTP 2DR SDN CNV SWG	67 Chevelle El Camino	5192
G		67	Rear taillight, bezel to body seal	2DR HTP 2DR SDN CNV SWG	67 Chevrolet Chevelle	5196



GUIDE TO SOFFSEAL'S PRODUCT CODES

B = Bumper sets **C** = Glass channels **D** = Door related **G** = Seals, gaskets **H** = Under hood items **I** = Interior parts
M = Miscellaneous items **R** = Roofrail, pillar post & convertible items **T** = Trunk related **W** = Window related **Z** = Weatherstrip kits

Chevrolet • Chevelle



CODE	IMAGE	YEAR	DESCRIPTION	BODY	FITS	ITEM#
G		67	Rear taillight, housing to lamp socket gasket	2DR HTP 2DR SDN CNV SWG	67 Chevelle	5197
G		67	Paint gasket set	2DR HTP 2DR SDN CNV SWG	67 Chevrolet Chevelle Hardtop Convertible Sedan Station Wagon	5367
G		67-68	Park light lens gaskets	2DR HTP 2DR SDN CNV SWG	67-68 Chevrolet Chevelle	5191
G		68	Paint gasket set	2DR HTP 2DR SDN CNV	68 Chevelle El Camino	51961
G		68	Taillight lens gaskets	2DR SDN 2DR HTP CNV SWG	68 Chevrolet Chevelle	5210
G		68	Inner taillight, housing seals	2DR HTP 2DR SDN CNV SWG	68 Chevrolet Chevelle	5215
G		68-69	Taillight, housing to body seals	2DR HTP 2DR SDN CNV SWG	68-69 Chevrolet Chevelle, El Camino	5188
G		68-69	Wiper motor to firewall seal	2DR HTP CNV	68-69 Chevy II Nova, Chevelle, Camaro, Pontiac Firebird	30303
G		68-69	Park light lens gasket	2DR HTP 2DR SDN CNV	68-69 Chevy II Nova, 68 Chevelle	4157
G		68-69	Trunk lock retainer seal	2DR 4DR HTP 2DR SDN 4DR SDN	68-69 Chevrolet Chevelle, Monte Carlo, El Camino	5086
G		68-69-70-71-72	Heater seal kit with ac	2DR SDN 2DR 4DR HTP CNV SWG	68-72 Chevrolet Chevelle	5089
G		68-69-70-71-72	Steering column sponge seal	2DR SDN CNV 2DR HTP SWG	68-72 Chevelle El Camino Monte Carlo, Buick Skylark, Oldsmobile Cutlass	5161
G		69	Taillight lens gaskets	2DR SDN 2DR HTP CNV SWG	69 Chevrolet Chevelle	5211
G		69	Taillight, bezel to housing seals	2DR SDN 2DR HTP CNV SWG	69 Chevrolet Chevelle, El Camino	52111
G		69	Park light lens gaskets	2DR HTP 2DR SDN CNV SWG	69 Chevelle	5198
G		69	Inner taillight, housing to body seal	2DR HTP 2DR SDN CNV SWG	69 Chevelle El Camino	51981
G		69	Paint gasket set	2DR HTP 2DR SDN CNV SWG	69 Chevrolet Chevelle Hardtop Convertible Sedan Station Wagon	5369
G		70	Park light lens gaskets	2DR HTP 2DR SDN CNV SWG	70 Chevrolet Chevelle, El Camino, Monte Carlo	5200

Chevrolet • Chevelle

CODE	IMAGE	YEAR	DESCRIPTION	BODY	FITS	ITEM#
G		70	Paint gasket set	2DR HTP 2DR SDN CNV	70 Chevrolet Chevelle, El Camino	52001
G		70	Taillight lens gaskets	2DR HTP 2DR SDN CNV SWG	70 Chevrolet Chevelle, El Camino	5201
G		70-71-72	Rear side marker gasket	2DR HTP 2DR SDN CNV SWG	70-72 Chevrolet Chevelle	5218
G		71-72	Paint gasket set	2DR HTP CNV	71-72 Chevrolet Chevelle Hardtop Convertible Sedan Station Wagon	5371
G		71-72	Park lens gaskets passenger	2DR HTP 2DR SDN CNV	71-72 Chevrolet Chevelle, El Camino, Monte Carlo	5203
G		71-72	Taillight lens gaskets set of 4	2DR SDN 2DR HTP CNV SWG	71-72 Chevrolet Chevelle	5212
H		64-65	Hood insulation	2DR HTP 2DR SDN CNV SWG	64-65 Chevrolet Chevelle	5170
H		64-65	A-arm seal with staples	2DR 4DR HTP 2DR SDN CNV SWG	64-65 Chevrolet Chevelle, El Camino	5065
H		64-65-66-67	Hood to cowl seal	2DR 4DR HTP 2DR SDN CNV SWG	64-67 Chevrolet Chevelle, El Camino, Pontiac GTO, LeMans	5070
H		64-65-66-67-68-69-70-71-72	Firewall wiring gutter plk	2DR 4DR HTP 2DR SDN SWG CNV	Chevy Chevelle, Biscayne, Bel Air, Impala, Caprice, Nova, Camaro, Cadillac Calais, Deville, Fleetwood, Oldsmobile 88, 98, Jetstar, Starfire, Pontiac Catalina, Bonneville, Firebird, Buick Lesabre, Wildcat, Electra	2328
H		66	A-arm seal with staples	2DR 4DR HTP 2DR SDN CNV SWG	66 Chevrolet Chevelle, El Camino	5066
H		66	Hood insulation	2DR HTP 2DR SDN CNV SWG	66 Chevrolet Chevelle	5172
H		67	Hood insulation	2DR HTP 2DR SDN CNV SWG	67 Chevrolet Chevelle	5173
H		67	A-arm seal with staples	2DR 4DR HTP 2DR SDN CNV SWG	67 Chevrolet Chevelle, El Camino	5067
H		68-69	Hood to cowl seal clip kit steel	2DR 4DR HTP 2DR SDN CNV SWG	68-69 Chevelle, El Camino, Monte Carlo, GTO, LeMans, Buick Skylark, Oldsmobile Cutlass	5075
H		68-69	Hood insulation	2DR HTP 2DR SDN CNV SWG	68-69 Chevelle Standard & Special	5175



















GUIDE TO SOFFSEAL'S PRODUCT CODES

B = Bumper sets **C** = Glass channels **D** = Door related **G** = Seals, gaskets **H** = Under hood items **I** = Interior parts
M = Miscellaneous items **R** = Roofrail, pillar post & convertible items **T** = Trunk related **W** = Window related **Z** = Weatherstrip kits



CODE	IMAGE	YEAR	DESCRIPTION	BODY	FITS	ITEM#
H		68-69-70-71-72	Anti squeak strips	2DR 4DR HTP SDN CNV SWG CPE TRK	68-72 Chevrolet Chevelle, El Camino, 2 Door 4 Door Hardtop Sedan Convertible Station Wagon Coupe Truck	5064
H		68-69-70-71-72	Hood to cowl seal clip kit plastic	2DR 4DR HTP 2DR SDN CNV SWG	68-72 Chevrolet Chevelle, El Camino, Monte Carlo, Pontiac GTO LeMans, Buick Skylark, Oldsmobile Cutlass	5077
H		68-69-70-71-72	Hood to cowl seal dense	2DR 4DR HTP 2DR SDN CNV SWG	68-72 Chevrolet Chevelle, El Camino, Monte Carlo, Pontiac GTO, LeMans, Buick Skylark, Oldsmobile Cutlass	5074
H		68-69-70-71-72	Hood to cowl seal sponge	2DR 4DR HTP 2DR SDN CNV SWG	68-72 Chevrolet Chevelle, El Camino, Monte Carlo, Pontiac GTO, LeMans, Buick Skylark, Oldsmobile Cutlass	50741
H		68-69-70-71-72	A-arm seal steel inner fenders with staples	2DR 4DR HTP 2DR SDN CNV SWG	68-72 Chevrolet Chevelle, El Camino	5068
H		68-69-70-71-72	Rear hood seal	2DR 4DR HTP 2DR SDN CNV SWG	68-72 Chevrolet Chevelle, El Camino, Monte Carlo	5070A
H		68-69-70-71-72	Firewall clutch boot	2DR HTP 2DR SDN CNV	68-72 Chevrolet Chevelle, El Camino, Monte Carlo, Pontiac LeMans, Tempest, GTO, Buick Skylark, Oldsmobile Cutlass	5053
H		69-70-71-72	A-arm seal plastic inner fenders with staples	2DR 4DR HTP 2DR SDN CNV SWG	69-72 Chevrolet Chevelle, El Camino	5069
H		70-71-72	Hood insulation	2DR HTP 2DR SDN CNV SWG	70-72 Chevrolet Chevelle, El Camino	5176
H		70-71-72	Cowl hood insulation with & with out flapper	2DR HTP CNV	70-72 Chevrolet Chevelle	5181
H		73-74-75-76-77	Hood insulation with clips	ALL BODY STYLES	73-77 Chevelle Malibu	5177
I		62-63-64-65-66-67-68-69-70-71	Accelerator pedal hp with deluxe trim	2DR 4DR HTP 2DR SDN CNV SWG	62-71 Chevrolet Biscayne Bel Air Impala, 64-67 Chevelle, 70-71 Camaro Hi Perfor, 64-67 Buick Special-Skylark El Camino, 64-65 Pontiac A Body	2069
I		64-65	Shift boot 4-speed with console	2DR HTP 2DR SDN CNV	64-65 Chevelle El Camino	50611
I		64-65-66	Shift boot 4-speed with o console	2DR HTP 2DR SDN CNV	64-66 Chevelle El Camino	5061
I		64-65-66-67	Automatic console slider	2DR 4DR HTP 2DR SDN CNV SWG	64-67 Chevy II, Nova, Chevelle, Biscayne, Bel Air, Impala, 67 Chevrolet Camaro	2108
I		64-65-66-67-68-69-70	Sun visor tip	2DR 4DR SDN HTP CNV	64-70 All Makes And Models	4006

Chevrolet • Chevelle

CODE	IMAGE	YEAR	DESCRIPTION	BODY	FITS	ITEM#
I		64-65-66-67-68-69-70-71-72-73-74	Park brake pedal pad	2DR HTP CNV	El Camino Cutlass Chevelle Chevy II Camaro Firebird LeMans Tempest GTO Grand Prix Full Size Centurion Century Electra Invicta LeSabre Regal Riviera Skylark Wildcat Monte Carlo	3094
I		65-66-67-68	Standard horn cap rubber retainer ring	2DR HTP CNV 2DR SDN SWG	67-68 Chevrolet Camaro, Pontiac Firebird 65-67 Chevelle	3079
I		66-67	Shift boot 4-speed with console	2DR HTP 2DR SDN CNV	66-67 Chevrolet Chevelle, El Camino	5060
I		66-67-68-69-70-71-72	Auto disc pad	2DR 4DR HTP 2DR SDN CNV SWG	66-72 Chevrolet Chevelle, El Camino, Monte Carlo	5058A
I		66-67-68-69-70-71-72	Brake pedal pad standard disc	2DR HTP 2DR 4DR SDN CNV SWG	67-69 Chevrolet Camaro 66-72 Chevrolet Chevelle 70-72 Chevrolet Monte Carlo	3041
I		68-69-70-71-72	Rubber console sealing strip 4 pre cut	2DR 4DR HTP 2DR SDN CNV SWG	68-72 Chevrolet Chevelle, El Camino, 70-72 Monte Carlo	5059
I		68-69-70-71-72	Automatic brake pad	2DR 4DR HTP 2DR SDN CNV SWG	68-72 Chevrolet Chevelle, El Camino, Monte Carlo, Buick Skylark, Oldsmobile Cutlass, 71-72 Pontiac LeMans, Tempest, GTO	5058
I		68-69-70-71-72	Shift boot 4-speed with o console	2DR HTP 2DR SDN CNV	68-72 Chevrolet Chevelle, El Camino, Monte Carlo	5062
I		68-69-70-71-72	Shift boot 4 speed with console	2DR 4DR SDN HTP CNV	68-72 Chevelle, El Camino, Monte Carlo	5063
M		57-58-59-60-61-62-63-64-65-66-67-68-69-70-71-72-73-74-75-76-77-78-79-80-81	Bellhousing to clutch fork rubber boot	2DR 4DR HTP SDN CNV SWG	57-81 GM All Manual Transmission	2196
M		64-65-66	Rear spring insulator	2DR SDN 2DR 4DR HTP CNV SWG	64-66 Chevrolet Chevelle	5205
M		64-65-66-67	Firewall pad with clips	2DR SDN 4DR HTP CNV SWG	64-67 Chevrolet Chevelle, El Camino, Buick Skylark, Oldsmobile Cutlass, Pontiac GTO, LeMans	5163
M		64-65-66-67	Body mounts with steel sleeves	2DR HTP 2DR SDN SWG	64-67 Chevrolet Chevelle, Also 67 SS 396, El Camino	5164
M		64-65-66-67	Body mounts with steel sleeves	2DR HTP SDN	64-67 Chevrolet Chevelle, El Camino, Hardtop, Sedan Except 67 SS Hardtop	51641
M		64-65-66-67	Body mounts with steel sleeves	2DR HTP	64-67 Chevrolet Chevelle, El Camino, Pontiac LeMans, GTO, 2 Door Hardtop Sedan	51642
M		64-65-66-67	Body mount bolt kit	2DR SDN CNV 2DR HTP SWG	64-67 Chevrolet Chevelle, El Camino	51643

















GUIDE TO SOFFSEAL'S PRODUCT CODES

B = Bumper sets **C** = Glass channels **D** = Door related **G** = Seals, gaskets **H** = Under hood items **I** = Interior parts
M = Miscellaneous items **R** = Roofrail, pillar post & convertible items **T** = Trunk related **W** = Window related **Z** = Weatherstrip kits



CODE	IMAGE	YEAR	DESCRIPTION	BODY	FITS	ITEM#
M		64-65-66-67	Body mount bolt kit	2DR SDN SWG	64-67 Chevelle, El Camino, Also 67 396 SS, 2 Door Sedan Station Wagon	51644
M		64-65-66-67	Body mount bolt kit	CNV	64-67 Chevrolet Chevelle, Pontiac LeMans, GTO, Convertible	51645
M		64-65-66-67	Firewall clutch boot	2DR HTP SDN CNV	64-67 Chevrolet Chevelle, El Camino, Pontiac GTO, 2 Door Hardtop Sedan Convertible	50521
M		64-65-66-67-68-69	Rocker panel flap plug, requires 2	2DR 4DR SDN HTP CNV	64-68 Chevrolet Chevelle, Pontiac GTO, Oldsmobile Cutlass, Buick Skylark, 67-69 Chevrolet Camaro, Pontiac Firebird, 2 Door 4 Door Sedan Hardtop Convertible	5013
M		65-66-67	Core support bushing bolt kit	2DR HTP4DR HTP 2DR SDN CNV SWG	65-67 Chevelle 65 Impala	5166
M		66-67-68-69-70-71-72-73-74-75	Accelerator pedal	2DR HTP CNV SDN SWG	67-75 Chevrolet Camaro, Pontiac Firebird, 68-72 Chevrolet Corvette, Chevelle, 68-75 Chevy II Nova, 66-72 Pontiac Tempest, LeMans, GTO, 2 Door Hardtop Convertible Sedan Station Wagon	3090
M		67	Bumper guard inserts front rear	2DR 4DR HTP 2DR SDN CNV SWG	67 Chevrolet Chevelle, El Camino	5082
M		68-69-70-71-72	Core support bushing bolt kit	2DR 4DR HTP 2DR SDN CNV SWG	68-72 Chevelle El Camino Skylark Special Gran Sport Sports Wagon 442 Cutlass F85 Vista Cruiser Wagon Tempest LeMans GTO T37 Monte Carlo Impala	5167
M		68-69-70-71-72	Body mount bolt kit	2DR HTP 2DR SDN	68-72 Chevelle, Cutlass LeMans Skylark, 2 Door 4 Door Hardtop	51646
M		68-69-70-71-72	Cnv body mount bolt kit	CNV	68-72 Chevrolet Chevelle, Oldsmobile Cutlass, Pontiac LeMans, Buick Skylark, Convertible	51647
M		68-69-70-71-72	Body mounts with steel sleeves	2DR HTP 2DR SDN SWG	68-72 Chevrolet Chevelle, El Camino, Sedan Station Wagon Hardtop	5165
M		68-69-70-71-72	Body mounts with steel sleeves	CNV	68-72 Chevrolet Chevelle Convertible	51651
M		68-69-70-71-72	Firewall insulation pad with clips non a/c	2DR SDN CNV 4DR HTP SWG	68-72 Chevrolet Chevelle, El Camino, Buick Skylark, Oldsmobile Cutlass, Pontiac GTO, LeMans	51631
M		68-69-70-71-72	Firewall insulation pad with clips with a/c	2DR SDN CNV 2DR 4DR HTP SWG	68-72 Chevrolet Chevelle, El Camino, Buick Skylark, Oldsmobile Cutlass, Pontiac GTO, LeMans, All Models	51632
M		68-69-70-71-72-73-74-75-76-77-78-79	Brake & clutch pedal pad	2DR HTP CNV SDN	67-72 Chevrolet Camaro Standard, Pontiac Firebird, 68-79 Chevrolet Corvette, 68-72 Chevrolet Nova, 64-72 Chevrolet Chevelle, 70-72 Monte Carlo 71-72 GTO, 2 Door Hardtop Convertible Sedan	3096

Chevrolet • Chevelle

CODE	IMAGE	YEAR	DESCRIPTION	BODY	FITS	ITEM#
M		69	Door jamb louvers	2DR 4DR HTP 2DR SDN CNV SWG	69 Chevelle, El Camino, Monte Carlo, Pontiac LeMans, GTO, Tempest	5043
P		00-99	Rear hood bumpers; has a width of 1.46", a length of 1", and an installed height of .375". It is typically used in metal applications and has a drill/slot of .312".	ALL BODY STYLES	Universal Fit And Chevelle	K145
P		66-67	Rear license plate bumper; has a diameter of .55", a length of .34", and an installed height of .51". It is typically used in metal applications and has a drill/slot of .281" with a cone shaped head.	ALL BODY STYLES	Universal Fit And 66-67 Chevelle	K163
R		64-65	Pillar post weatherstrip with molded ends	CNV	64-65 Chevrolet Chevelle, Pontiac GTO, Buick Skylark, Oldsmobile Cutlass, Convertible	5039
R		64-65	Roofrail weatherstrip with molded ends	2DR HTP	64-65 Chevrolet Chevelle, Buick Skylark, Oldsmobile Cutlass, Pontiac LeMans, GTO, 2 Door Hardtop	5005
R		64-65	Weatherstrip kit for convertible top	CNV	64-65 Chevrolet Chevelle, Pontiac GTO, LeMans, Oldsmobile Cutlass, 442, Buick Skylark Convertible	5090
R		64-65-66-67	Header seal with clips, without molded ends	CNV	64-67 Chevrolet Chevelle, Pontiac GTO, LeMans, Oldsmobile Cutlass, 442, Buick Skylark, Convertible	5091
R		66-67	Header seal with clips and molded ends	CNV	66-67 Chevrolet Chevelle A Body Pontiac LeMans GTO Old Cutlass 442 Buick Special Skylark Convertible	50911
R		66-67	Weatherstrip kit for convertible top	CNV	66-67 Chevrolet Chevelle, Pontiac GTO, LeMans, Oldsmobile Cutlass 442, Buick Special, Skylark, Convertible	5092
R		66-67	Roofrail weatherstrip with molded ends	2DR HTP	66-67 Chevelle, Pontiac Tempest, LeMans, GTO, Oldsmobile Cutlass 442, Buick Special, Skylark, 2 Door Hardtop	5009
R		66-67	Pillar post weatherstrip with molded ends	CNV	66-67 Chevrolet Chevelle, Pontiac GTO, LeMans, Oldsmobile Cutlass, Buick Skylark Convertible	5040
R		68	Pillar post weatherstrip with molded ends	CNV	68 Chevrolet Chevelle, Pontiac GTO, LeMans, Buick Skylark, Oldsmobile Cutlass Convertible	5041
R		68	Roofrail weatherstrip with molded ends	2DR HTP	68 Chevrolet Chevelle, Pontiac LeMans, GTO, Buick Skylark, Oldsmobile Cutlass, 2 Door Hardtop	5012
R		68-69-70-71-72	Weatherstrip kit for convertible top	CNV	68-72 Chevrolet Chevelle, Buick Skylark, Oldsmobile Cutlass, Pontiac LeMans, Convertible	5093















GUIDE TO SOFFSEAL'S PRODUCT CODES

B = Bumper sets **C** = Glass channels **D** = Door related **G** = Seals, gaskets **H** = Under hood items **I** = Interior parts
M = Miscellaneous items **R** = Roofrail, pillar post & convertible items **T** = Trunk related **W** = Window related **Z** = Weatherstrip kits



CODE	IMAGE	YEAR	DESCRIPTION	BODY	FITS	ITEM#
R		68-69-70-71-72	Header seal with clips and molded ends	CNV	68-72 Chevrolet Chevelle, Buick Skylark, Oldsmobile Cutlass, Pontiac LeMans, Convertible	5094
R		68-69-70-71-72	Conv. top Header Seal	Conv.	68-72 Chevrolet Chevelle, Pontiac LeMans, Tempest, GTO, Buick Skylark, Olds Cutlass	5054
R		69-70-71-72	Pillar post weatherstrip with molded ends	CNV	69-72 Chevrolet Chevelle, Pontiac LeMans, GTO, Buick Skylark, Oldsmobile Cutlass Convertible	5042
T		62-63-64-65-66-67-68-69-70-71-72-73	Door and tailgate bottom drain hole seal	2DR 4DR HTP SDN CNV SWG CPE	62-73 Chevy Nova, Chevelle, Impala, Caprice Pontiac Catalina, Star Chief, Bonneville, Grand Prix Oldsmobile F85	2118
T		64-65	Trunk mat rubber	2DR HTP 2DR SDN CNV	64-65 Chevelle	5141
T		64-65-66-67-68-69-70-71-72-73-74-75-76-77	Trunk weatherstrip exact profile length 17 feet	2DR 4DR HTP 2DR SDN CNV	65-72 Chevy II, 65-72 Chevrolet Biscayne, 65-75 Chevrolet Bel Air, 65-76 Chevrolet Impala, 65-76 Chevrolet Caprice, 64-77 Chevrolet Chevelle, 70-77 Chevrolet Monte Carlo, 65-76 Buick LeSabre, 64-77 Buick Wildcat, 64-77 Buick Skylark, 71-73 Buick Centurion, 64-72 Buick Grand Special, 73-77 Buick Century, 73-88 Buick Regal, 73-88 Buick Grand National, 65-76 Buick Electra, 65-76 Oldsmobile Delta 88, 67-69 Oldsmobile Delmont 88, 65-66 Oldsmobile Dynamic 88, 65-66 Oldsmobile Starfire, 65 Oldsmobile Jetstar, 64-77 Oldsmobile Cutlass 442, 64-88 Oldsmobile Cutlass, 65-76 Oldsmobile 98, 65-76 Pontiac Parisienne, 64-72 Pontiac LeMans, 65-70 Pontiac Catalina, 65-66 Pontiac Star Chief, 67-70 Pontiac Executive, 71-75 Pontiac Grand Ville, 65-77 Pontiac Grand Prix, 64-72 Pontiac Tempest, 62-72 Nova, Ventura, 73-74 Non-Hatchback, Up to 1975 with groove channel, Apollo, Nova, Omega, Ventura 65-76 C-Body	2003
T		66	Trunk mat rubber	2DR HTP 2DR SDN CNV	66 Chevelle	5143
T		67	Trunk mat rubber	2DR HTP 2DR SDN CNV	67 Chevrolet Chevelle	5145
T		68-69	Trunk mat	2DR HTP 2DR SDN CNV	68-69 Chevrolet Chevelle	5146
T		70	Trunk mat	2DR HTP 2DR SDN CNV	70 Chevrolet Chevelle, Monte Carlo	5147
T		71-72	Trunk mat	2DR HTP 2DR SDN CNV	71-72 Chevrolet Chevelle	5149

Chevrolet • Chevelle

CODE	IMAGE	YEAR	DESCRIPTION	BODY	FITS	ITEM#
W		62-63-64-65-66-67	Door glass run channel, upper & rear	2DR 4DR SDN	62-67 Chevy II Nova, Chevelle, 2 Door 4 Door Sedan	4039
W		64	Window weatherstrip	2DR HTP	64 Chevrolet Chevelle 2 Door Hardtop	5114
W	 <small>IMAGE COMING SOON</small>	64	Window weatherstrip original style with round bead	4DR SDN	64 Chevrolet Chevelle 4 Door Sedan	51141
W		64	Window weatherstrip, original style with round bead	2DR SDN	64 Chevrolet Chevelle 2 Door Sedan	51142
W		64	Window weatherstrip, original style with round bead 8 piece	2DR HTP	64 Chevelle Hardtop	5114A
W		64	Window weatherstrip replacement style	CNV	64 Chevrolet Chevelle Convertible	5115
W		64	Window weatherstrip, original style with round bead 8 piece	CNV	64 Chevelle Convertible	5115A
W		64-65	Glass run channel front door window	2DR 4DR HTP CNV	64-65 Chevrolet Chevelle, Pontiac GTO, LeMans, Oldsmobile Cutlass, 442, Buick Skylark, 2 Door 4 Door Hardtop Convertible	5100
W		64-65	Vent window seals	2DR HTP CNV	64-65 Chevrolet Chevelle, Pontiac GTO, LeMans, Oldsmobile Cutlass, Buick Skylark, 2 Door Hardtop Convertible	5102
W		64-65	Rubber door jams u shape	2DR HTP CNV	64-65 Chevrolet Chevelle, Pontiac LeMans, GTO, Oldsmobile Cutlass, Buick Skylark 2 Door Hardtop Convertible	5113
W		64-65	Quarter window seals steel insert	HTP	64-65 Chevrolet Chevelle, Pontiac LeMans, GTO, Oldsmobile Cutlass, Buick Skylark, Hardtop	5109M
W		64-65	Quarter window seals all rubber	2DR HTP	64-65 Chevrolet Chevelle, Pontiac LeMans, GTO, Oldsmobile Cutlass, Buick Skylark, 2 Door Hardtop	5109R
W		64-65	Quarter window seals steel insert	CNV	64-65 Chevrolet Chevelle, Pontiac GTO, LeMans, Oldsmobile Cutlass, Buick Skylark, Convertible	5110M
W		64-65	Quarter window seals all rubber	CNV	64-65 Chevrolet Chevelle, Pontiac GTO, LeMans, Oldsmobile Cutlass, Buick Skylark, Convertible	5110R
W		64-65-66-67	Vent window seals	2DR 4DR SDN	64-67 Chevelle, El Camino, 66-67 Oldsmobile Cutlass, Buick Skylark, 64-65 Pontiac GTO, LeMans 2 Door 4 Door Sedan	51021
W		64-65-66-67	Quarter window seal rear	CNV	64-67 Chevrolet Chevelle, Pontiac Tempest, LeMans, GTO, Oldsmobile Cutlass, 442, Buick Skylark, Convertible	5108
W		65	Window weatherstrip replacement style	2DR HTP	65 Chevrolet Chevelle 2 Door Hardtop	5116



GUIDE TO SOFFSEAL'S PRODUCT CODES

B = Bumper sets **C** = Glass channels **D** = Door related **G** = Seals, gaskets **H** = Under hood items **I** = Interior parts
M = Miscellaneous items **R** = Roofrail, pillar post & convertible items **T** = Trunk related **W** = Window related **Z** = Weatherstrip kits

Chevrolet • Chevelle



CODE	IMAGE	YEAR	DESCRIPTION	BODY	FITS	ITEM#
W		65	Window weatherstrip	4DR SDN	65 Chevrolet Chevelle 4 Door Sedan	51161
W		65	Window weatherstrip, original style with round bead 8 piece	2DR SDN	65 Chevrolet Chevelle 2 Door Sedan	51162
W		65	Window weatherstrip, original style with round bead 8pc	2DR SDN	65 Chevelle 2 Door, Sedan	51162A
W		65	Window weatherstrip, original style with round bead 8 piece	2DR HTP	65 Chevelle Hardtop	5116A
W		65	Window weatherstrip replacement style	CNV	65 Chevrolet Chevelle Convertible	5117
W		65	Window weatherstrip, original style with round bead 8 piece	CNV	65 Chevelle Convertible	5117A
W		66-67	Window weatherstrip replacement style	2DR HTP	66-67 Chevrolet Chevelle, 2 Door Hardtop	5118
W		66-67	Window weatherstrip, original style with round bead 8 piece	2DR HTP	66-67 Chevrolet Chevelle, 2 Door Hardtop	51181
W		66-67	Window weatherstrip	4DR SDN	66-67 Chevrolet Chevelle 4 Door Sedan	51182
W		66-67	Window weatherstrip replacement style	2DR SDN	66-67 Chevrolet Chevelle 2 Door Sedan	5118A
W		66-67	Window weatherstrip, original style with round bead 8 piece	2DR SDN	66-67 Chevelle 2 Door Sedan	5118AA
W		66-67	Window weatherstrip replacement style	CNV	66-67 Chevrolet Chevelle Convertible	5119
W		66-67	Window weatherstrip, original style with round bead	CNV	66-67 Chevelle Convertible	51191
W		66-67	Window weatherstrip, original style with round bead outers only	2DR HTP	66-67 Chevelle, 2 Door Hardtop	51192
W		66-67	Vent window seals	2DR HTP CNV	66-67 Chevrolet Chevelle, Pontiac GTO, LeMans, Oldsmobile Cutlass, Buick Skylark, 2 Door Hardtop Convertible	5103
W		66-67	Glass run channel front door window	2DR 4DR HTP CNV	66-67 Chevrolet Chevelle, Pontiac GTO, LeMans, Oldsmobile Cutlass, 442, Buick Skylark, Hardtop Convertible	5101
W		66-67	Quarter window seals with steel insert	2DR HTP CNV	66-67 Chevrolet Chevelle, Buick Skylark, Pontiac GTO, Oldsmobile Cutlass, 2 Door Hardtop Convertible	5111M
W		66-67	Quarter window seals all rubber	2DR HTP CNV	66-67 Chevrolet Chevelle, Buick Skylark, Pontiac GTO, Oldsmobile Cutlass, 2 Door Hardtop Convertible	5111R

Chevrolet • Chevelle

CODE	IMAGE	YEAR	DESCRIPTION	BODY	FITS	ITEM#
W		66-67	Rubber door jambs u shape	2DR HTP CNV	66-67 Chevrolet Chevelle, Pontiac LeMans, GTO, Oldsmobile Cutlass, Buick Skylark, 2 Door Hardtop Convertible	51131
W		66-67	Window weatherstrip, original style with round bead 4 piece	2DR SDN	66-67 Chevrolet Chevelle, El Camino 2 Door Sedan	5130A
W		67-68	Glass run channel front door window	2DR 4DR HTP CNV	67 Chevrolet Camaro, Pontiac Firebird, 68 Chevrolet Chevelle, Oldsmobile Cutlass 68, Buick Special, Skylark, 2 Door 4 Door Hardtop Convertible	3126
W		68	Vent window weatherstrip	2DR 4DR HTP	68 Chevrolet Chevelle, Pontiac LeMans, GTO, Oldsmobile Cutlass 442, Buick Special, Skylark, 2 Door Hardtop Convertible	51022
W		68	Window weatherstrip, original style with round bead outers only	2DR HTP	68 Chevelle, 2 Door Hardtop	51193
W		68	Window weatherstrip replacement style	2DR HTP	68 Chevrolet Chevelle 2 Door Hardtop	5120
W		68	Window weatherstrip, original style with round bead	2DR HTP	68 Chevrolet Chevelle 2 Door Hardtop	51201
W		68	Window weatherstrip replacement style	2DR SDN	68 Chevrolet Chevelle 2 Door Sedan	51202
W		68	Window weatherstrip, original style with round bead 8pc	2DR SDN	68 Chevelle 2 Door, Sedan	51202A
W		68	Window weatherstrip replacement style	CNV	68 Chevrolet Chevelle Convertible	5121
W		68	Window weatherstrip, original style with round bead	CNV	68 Chevrolet Chevelle Convertible	51210
W		68-69-70-71-72	Vent window weatherstrip	2DR 4DR SDN	68 Chevrolet Chevelle, Pontiac Le Mans, GTO, Oldsmobile Cutlass, 442, Buick Skylark, 68-72 Chevrolet El Camino, Sedan	51031
W		68-69-70-71-72	Rubber door jambs u shape	2DR HTP CNV	68-72 Chevelle GTO Cutlass Skylark, 2 Door Hardtop Convertible	51132
W		68-69-70-71-72	Quarter window seals, with steel insert	2DR HTP CNV	68-72 Chevrolet Chevelle, Oldsmobile Cutlass, Buick Skylark, Pontiac LeMans, 69-70 Chevrolet Impala, 70-72 Chevrolet Monte Carlo, 2 Door Hardtop Convertible	5112M
W		68-69-70-71-72	Quarter window seals, all rubber	2DR HTP CNV	68-72 Chevrolet Chevelle, Oldsmobile Cutlass, Buick Skylark, Pontiac LeMans, 69-70 Chevrolet Impala, 70-72 Chevrolet Monte Carlo, 2 Door Hardtop Convertible	5112R
W		68-69-70-71-72	Rear quarter window seals	CNV	68-72 Chevrolet Chevelle Convertible	5505



GUIDE TO SOFFSEAL'S PRODUCT CODES

B = Bumper sets **C** = Glass channels **D** = Door related **G** = Seals, gaskets **H** = Under hood items **I** = Interior parts
M = Miscellaneous items **R** = Roofrail, pillar post & convertible items **T** = Trunk related **W** = Window related **Z** = Weatherstrip kits

Chevrolet • Chevelle



CODE	IMAGE	YEAR	DESCRIPTION	BODY	FITS	ITEM#
W		69	Window weatherstrip, original style with round bead 8 piece	CNV	69 Chevelle Convertible	5123A
W		69	Window weatherstrip replacement style	2DR HTP	69 Chevrolet Chevelle, 2 Door Hardtop	5122
W		69	Window weatherstrip replacement style	2DR SDN	69 Chevrolet Chevelle 2 Door Sedan	51221
W		69	Window weatherstrip, original style with round bead 8 piece	2DR SDN	69 Chevelle 2 Door, Sedan	51221A
W		69	Window weatherstrip, original style with round bead 8 piece	2DR HTP	69 Chevelle 2 Door Hardtop	5122A
W		69	Window weatherstrip replacement style	CNV	69 Chevrolet Chevelle Convertible	5123
W		69	Window weatherstrip, original style with round bead, outers	2DR HTP	69 Chevrolet Chevelle 2 Door Hardtop	51231
W		70-71-72	Window weatherstrip, original style with round bead, outers	2DR HTP	70-72 Chevrolet Chevelle 2 Door Hardtop	51232
W		70-71-72	Window weatherstrip replacement style	2DR HTP	70-72 Chevrolet Chevelle, 2 Door Hardtop	5124
W		70-71-72	Window weatherstrip, original style with round bead, 8 piece	2DR HTP	70-72 Chevelle 2 Door Hardtop	5124A
W		70-71-72	Window weatherstrip replacement style	CNV	70-72 Chevrolet Chevelle Convertible	5125
W		70-71-72	Window weatherstrip, original style with round bead 8 piece	CNV	70-72 Chevelle Convertible	5125A
Z		64	Weatherstrip kit, includes a arm seals, bumper kit, door weatherstrips, hood to cowl seal, paint gaskets, quarter window seals, roofrail weatherstrips, trunk weatherstrip, door u jambs, window weatherstrips	2DR HTP	64 Chevrolet Chevelle 2 Door Hardtop	KIT505
Z		64	Weatherstrip kit, includes a arm seals, bumper kit, door weatherstrips, hood to cowl seal, paint gaskets, trunk weatherstrip, window weatherstrips	2DR SDN	64 Chevrolet Chevelle 2 Door Sedan	KIT517
Z		64	Weatherstrip kit, includes a arm seals, bumper kit, convertible top kit, door weatherstrips, hood to cowl seal, paint gaskets, pillar post seals, quarter window seals, trunk weatherstrip, door u jambs, window weatherstrips	CNV	64 Chevrolet Chevelle Convertible	KIT521

Chevrolet • Chevelle

CODE	IMAGE	YEAR	DESCRIPTION	BODY	FITS	ITEM#
Z		64-65	Weatherstrip kit, includes trunk weatherstrip, door weatherstrip, roofrail weatherstrip	2DR HTP	64-65 Chevrolet Chevelle 2 Door Hardtop	KIT505X
Z		65	Weatherstrip kit, includes a arm seals, bumper kit, door weatherstrips, hood to cowl seal, paint gaskets, quarter window seals, roofrail weatherstrips, trunk weatherstrip, door u jamba, window weatherstrips	2DR HTP	65 Chevrolet Chevelle 2 Door Hardtop	KIT506
Z		65	Weatherstrip kit, includes a arm seals, bumper kit, convertible top kit, door weatherstrips, hood to cowl seal, paint gaskets, pillar post seals, quarter window seals, trunk weatherstrip, door u jamba, window weatherstrips	CNV	65 Chevrolet Chevelle Convertible	KIT522
Z		65	Weatherstrip kit, includes a arm seals, bumper kit, door weatherstrips, hood to cowl seal, paint gaskets, trunk weatherstrip, window weatherstrips	2DR SDN	65 Chevrolet Chevelle 2 Door Sedan	KIT518
Z		66	Weatherstrip kit, includes a arm seals, bumper kit, door weatherstrips, hood to cowl seal, paint gaskets, trunk weatherstrip, window weatherstrips	2DR SDN	66 Chevrolet Chevelle 2 Door Sedan	KIT519
Z		66	Weatherstrip kit, includes a arm seals, bumper kit, convertible top kit, door weatherstrips, hood to cowl seal, paint gaskets, pillar post seals, quarter window seals, trunk weatherstrip, door u jamba, window weatherstrips	CNV	66 Chevrolet Chevelle Convertible	KIT523
Z		66	Weatherstrip kit, includes a arm seals, bumper kit, door weatherstrips, hood to cowl seal, paint gaskets, quarter window seals, roofrail weatherstrips, trunk weatherstrip, door u jamba, window weatherstrips	2DR HTP	66 Chevrolet Chevelle 2 Door Hardtop	KIT507
Z		66-67	Weatherstrip kit, includes trunk weatherstrip, door weatherstrip, roofrail weatherstrip	2DR HTP	66-67 Chevrolet Chevelle 2 Door Hardtop	KIT507X
Z		67	Weatherstrip kit includes a arm seals, bumper kit, door weatherstrips, hood to cowl seal, paint gaskets, quarter window seals, roofrail weatherstrips, trunk weatherstrip, door u jamba, window weatherstrips	2DR HTP	67 Chevrolet Chevelle 2 Door Hardtop	KIT508
Z		67	Weatherstrip kit, includes a arm seals, bumper kit, convertible top kit, door weatherstrips, hood to cowl seal, paint gaskets, pillar post seals, quarter window seals, trunk weatherstrip, door u jamba, window weatherstrips	CNV	67 Chevrolet Chevelle Convertible	KIT524



GUIDE TO SOFFSEAL'S PRODUCT CODES



B = Bumper sets **C** = Glass channels **D** = Door related **G** = Seals, gaskets **H** = Under hood items **I** = Interior parts
M = Miscellaneous items **R** = Roofrail, pillar post & convertible items **T** = Trunk related **W** = Window related **Z** = Weatherstrip kits

Chevrolet • Chevelle



CODE	IMAGE	YEAR	DESCRIPTION	BODY	FITS	ITEM#
Z		67	Weatherstrip kit, includes a arm seals, bumper kit, door weatherstrips, hood to cowl seal, paint gaskets, trunk weatherstrip, window weatherstrips	2DR SDN	67 Chevrolet Chevelle 2 Door Sedan	KIT520
Z		68	Weatherstrip kit, includes a arm seals, bumper kit, door weatherstrips, hood to cowl seal, paint gaskets, quarter window seals, roofrail weatherstrips, trunk weatherstrip, door u jamba, window weatherstrips, hood to cowl clips	2DR HTP	68 Chevrolet Chevelle 2 Door Hardtop	KIT509
Z		68	Weatherstrip kit, includes trunk weatherstrip, door weatherstrip, roofrail weatherstrip	2DR HTP	68 Chevrolet Chevelle 2 Door Hardtop	KIT509X
Z		68	Weatherstrip kit, includes a arm seals, bumper kit, convertible top kit, door weatherstrips, hood to cowl seal, paint gaskets, pillar post seals, quarter window seals, trunk weatherstrip, door u jamba, window weatherstrips, hood to cowl seal clips	CNV	68 Chevrolet Chevelle Convertible	KIT513
Z		69	Weatherstrip kit, includes a arm seals, bumper kit, convertible top kit, door weatherstrips, hood to cowl seal, paint gaskets, pillar post seals, quarter window seals, trunk weatherstrip, door u jamba, window weatherstrips, hood to cowl clips	CNV	69 Chevrolet Chevelle Convertible	KIT514
Z		69	Weatherstrip kit, includes a arm seals, bumper kit, door weatherstrips, hood to cowl seal, paint gaskets, quarter window seals, roofrail weatherstrips, trunk weatherstrip, door u jamba, window weatherstrips, hood to cowl seal clips	2DR HTP	69 Chevrolet Chevelle 2 Door Hardtop	KIT510
Z		69-70-71-72	Weatherstrip kit, includes trunk weatherstrip, door weatherstrip, roofrail weatherstrip	2DR HTP	69-72 Buick Skylark, Chevrolet Chevelle, Oldsmobile Cutlass, 442, 2 Door Hardtop	KIT510X
Z		70	Weatherstrip kit, includes a arm seals, bumper kit, door weatherstrips, hood to cowl seal, paint gaskets, quarter window seals, roofrail weatherstrips, trunk weatherstrip, door u jamba, window weatherstrips, hood to cowl seal clips	2DR HTP	70 Chevrolet Chevelle 2 Door Hardtop	KIT511
Z		70	Weatherstrip kit, includes a arm seals, bumper kit, convertible top kit, door weatherstrips, hood to cowl seal, paint gaskets, pillar post seals, quarter window seals, trunk weatherstrip, door u jamba, window weatherstrips, hood to cowl seal clips	CNV	70 Chevrolet Chevelle Convertible	KIT515

Chevrolet • Chevelle

CODE	IMAGE	YEAR	DESCRIPTION	BODY	FITS	ITEM#
Z		71-72	Weatherstrip kit, includes a arm seals, bumper kit, convertible top kit, door weatherstrips, hood to cowl seal, paint gaskets, pillar post seals, quarter window seals, trunk weatherstrip, door u jambs, window weatherstrips, hood to cowl seal clips	CNV	71-72 Chevrolet Chevelle Convertible	KIT516
Z		71-72	Weatherstrip kit, includes a arm seals, bumper kit, door weatherstrips, hood to cowl seal, paint gaskets, quarter window seals, roofrail weatherstrips, trunk weatherstrip, door u jambs, window weatherstrips, hood to cowl seal clips	2DR HTP	71-72 Chevrolet Chevelle 2 Door Hardtop	KIT512



GUIDE TO SOFFSEAL'S PRODUCT CODES

B = Bumper sets **C** = Glass channels **D** = Door related **G** = Seals, gaskets **H** = Under hood items **I** = Interior parts
M = Miscellaneous items **R** = Roofrail, pillar post & convertible items **T** = Trunk related **W** = Window related **Z** = Weatherstrip kits

Chevrolet • Chevy II, Nova



CODE	IMAGE	YEAR	DESCRIPTION	BODY	FITS	ITEM#
B		47-48-49-50-51-52-53-54-55-56-57-58-59-60-61-62-63-64-65-66-67-68-69-70-71-72-73-74-75-76-77-78-79-80-81-82-83-84-85-86-87	Glove box door bumpers	2DR 4DR HTP 2DR SDN CNV SWG TRK	All Chevrolet, Pontiac, Oldsmobile, Buick 47-87 Chevrolet, Gmc Truck	1069
B		56-57-58-59-60-61-62-63-64-65-66-67-68-69-70-71-72-73-74	Hood adjustment bumpers round	2DR 4DR HTP 2DR SDN CNV SWG	56-74 Chevrolet, Pontiac, All Models	1222
B		59-60-61-62-63-64-65-66-67	Door bumpers	2DR HTP 2DR SDN 2DR SDN CNV SWG	59-67 Chevrolet, Pontiac, Oldsmobile, Buick, Cadillac, 62-67 Chevy II, Nova, 66-67 Chevrolet Chevelle, Oldsmobile Cutlass, Buick Skylark, Pontiac Tempest, LeMans, GTO	2320
B		62-63-64	Seat back bumpers	2DR HTP CNV	62-64 Chevrolet Impala, Nova, Chevelle, El Camino, For SS	2172
B		62-63-64-65	License plate bumper front rear	2DR SDN 2DR HTP CNV SWG	62-65 Chevy II Nova	4048
B		62-63-64-65	Bumper kit, includes: door hood trunk glove box	2DR HTP	62-65 Chevy II Nova	4091
B		62-63-64-65	Hood side bumpers 4 per car	2DR HTP 2DR SDN CNV SWG	62-65 Chevy II Nova	4067
B		62-63-64-65	Upper vent window bumpers	2DR HTP CNV	62-65 Chevy II, Nova 2 Door Hardtop Convertible	4078
B		62-63-64-65-66-67-68-69-70-71-72-73-74-75	Trunk bumpers	2DR HTP 2DR SDN CNV	70-75 Chevrolet Camaro, Pontiac Firebird, 62-73 Chevy II Nova, 64-72, Pontiac GTO, Tempest, Le Mans, Chevrolet Chevelle, Monte Carlo, Buick Skylark, Oldsmobile Cutlass, 65-69 Chevrolet Corvair, 65-70 Full Size Chevrolet	3112
B		64-65-66	Door bumpers	2DR 4DR HTP 2DR SDN CNV SWG	64-66 Chevrolet Chevelle, El Camino, Nova, Pontiac GTO, Tempest, LeMans, Buick Skylark, Oldsmobile Cutlass	5080
B		66-67	Bumpers bucket seat back oval 4 per car	2DR HTP CNV 2DR SDN	66-67 Chevrolet Chevelle, El Camino, Nova, Pontiac GTO, Tempest, LeMans, Grand Prix	5085
B		66-67	Upper vent window bumpers	2DR HTP CNV	66-67 Chevy II Nova Hardtop	4079
B		66-67	Hood side bumpers 2 per car	2DR HTP SWG	66-67 Chevy II Nova	4068
B		66-67	Bumper kit, includes: door hood trunk glove box	2DR HTP	66-67 Chevy II Nova	4093
B		66-67	Fender to cowl grille panel bumpers	2DR HTP SWG	66-67 Chevy II Nova	4053

CHEVROLET • Chevy II, Nova

Chevrolet • Chevy II, Nova

CHEVROLET • Chevy II, Nova

CODE	IMAGE	YEAR	DESCRIPTION	BODY	FITS	ITEM#
B		66-67-68-69-70-71-72	Hood side bumpers	2DR 4DR SDN HTP CNV	66-72 Chevrolet Biscayne, Bel Air, Impala, Caprice, 73-75 Nova, 66-72 Cadillac, 66-72 Oldsmobile, 66-72 Buick, 66-72 Pontiac	2179
B		68-69-70-71-72-73-74	Door bumper set	2DR 4DR SDN	68-74 Chevy II Nova	40511
B		68-69-70-71-72-73-74	Bumper kit, includes: door hood trunk glove box	2DR SDN	68-74 Chevy II Nova	4094
C		62-63-64	Back glass channel	2DR SDN SWG 4DR	62-64 Chevy II Nova, 2 Door 4 Door Sedan	4038
C		62-63-64-65	Back glass channel	HTP	62-65 Chevy II Nova Hardtop	4036
C		62-63-64-65-66-67	Windshield channel	2DR HTP	62-67 Chevy II Nova 2 Door Hardtop	4035
C		62-63-64-65-66-67	Windshield channel	2DR 4DR SDN	62-67 Chevy II Nova, 2 Door 4 Door Sedan	4037
C		65	Rear glass channel	4DR SDN	65 Chevy II Nova 4 Door Sedan	40381
D		62-63-64-65-66-67	Door weatherstrip rear doors with clips	SWG	62-67 Chevy II, Nova, Station Wagon	4080B
D		62-63-64-65-66-67	Door weatherstrip rear with clips	4DR SDN	62-67 Chevy II, Nova, 4 Door Sedan	4080A
D		62-63-64-65-66-67	Door weatherstrip front doors with clips	SWG 4DR	62-67 Chevy II, Nova, Station Wagon 4 Door	4080
D		62-63-64-65-66-67	Door weatherstrip with clips	2DR SDN	62-67 Chevy II, Nova, 2 Door Sedan	4000
D		62-63-64-65-66-67	Door weatherstrip with clips & molded end	2DR HTP CNV	62-67 Chevy II, Nova, 2 Door Hardtop Convertible	4002
D		68-69-70-71-72-73-74	Door weatherstrip front door with clips	4DR SDN	68-74 Nova 73-74 Buick Apollo, 73-74 Oldsmobile Omega, 71-74 Pontiac Ventura, 4 Door Sedan	4081
D		68-69-70-71-72-73-74	Door weatherstrip rear door with clips	4DR SDN	68-74 Nova 73-74 Buick Apollo, 73-74 Oldsmobile Omega, 71-74 Pontiac Ventura, 4 Door Sedan	4081A
D		68-69-70-71-72-73-74	Door weatherstrip with clips	2DR SDN	68-74 Nova 73-74 Apollo, Omega, 71-74 Ventura 2 Door Sedan	4020
D		75-76-77-78-79	Door weatherstrip with clips	2DR SDN	75-79 Nova, 75 Apollo, 75-79 Oldsmobile Omega, 75-77 Pontiac Ventura, 77-79 Pontiac Phoenix 76-79 Buick Skylark, 2 Door Sedan	4024



GUIDE TO SOFFSEAL'S PRODUCT CODES

B = Bumper sets **C** = Glass channels **D** = Door related **G** = Seals, gaskets **H** = Under hood items **I** = Interior parts
M = Miscellaneous items **R** = Roofrail, pillar post & convertible items **T** = Trunk related **W** = Window related **Z** = Weatherstrip kits

















Chevrolet • Chevy II, Nova



CODE	IMAGE	YEAR	DESCRIPTION	BODY	FITS	ITEM#
D		75-76-77-78-79	Door weatherstrip rear door with clips	4DR SDN	75-79 Chevy II Nova, 75 Buick Apollo, 76-79 Buick Skylark, 75-79 Oldsmobile Omega, 75-77 Pontiac Ventura, 78-79 Phoenix, 4 Door Sedan	40814
D		75-76-77-78-79	Door weatherstrip front door with clips	4DR SDN	75-79 Chevy II Nova, 75 Buick Apollo, 76-79 Buick Skylark, 75-79 Oldsmobile Omega, 75-77 Pontiac Ventura, 78-79 Phoenix, 4 Door Sedan	40813
G		62-63-64	Taillight, body to fender seals	2DR HTP 2DR SDN SWG CNV	62-64 Chevy II Nova	4155
G		62-63-64	Taillight lens gasket	2DR HTP 2DR SDN CNV SWG	62-64 Chevy II Nova	4152
G		62-63-64	Park light lens gasket	2DR HTP 2DR SDN CNV SWG	62-64 Chevy II Nova	4150
G		62-63-64	Paint gasket set	2DR HTP 2DR SDN CNV	62-64 Chevy II Nova	4201
G		62-63-64-65	Door handle lock gasket set	2DR HTP 2DR SDN CNV SWG	62-65 Chevy II Nova	41522
G		62-63-64-65	License lamp gasket	2DR HTP 2DR SDN CNV SWG	62-65 Chevy II Nova	41521
G		62-63-64-65	Rear body to bumper seal	2DR HTP 2DR SDN SWG CNV	62-65 Chevy II Nova	4060
G		62-63-64-65	Heater motor to firewall seal	2DR SDN 2DR HTP CNV SWG	62-65 Chevy II Nova	40441
G		62-63-64-65	Rear door stationary vent seals	4DR SDN	62-65 Chevy II Nova 4 Door Sedan	4015
G		62-63-64-65	Main wiring harness to firewall seal	2DR SDN 2DR HTP CNV SWG	62-65 Chevy II Nova	4046
G		62-63-64-65-66	Sponge steering column firewall seal	2DR SDN 2DR HTP CNV SWG	62-66 Chevy II Nova	4044
G		62-63-64-65-66-67	Inner front fender seal	2DR HTP 2DR SDN SWG CNV	62-67 Chevy II/Nova	4059
G		62-63-64-65-66-67	Fuel filler neck to body seal	2DR HTP 2DR SDN CNV SWG	62-67 Chevy II Nova	40602
G		65	Paint gasket set	2DR HTP 2DR SDN	65 Chevy II Nova	4203
G		65	Taillight lens gaskets & backup lights, 2 required	2DR HTP SWG	65 Chevy II Nova	4153
G		65-66-67	Park light lens gasket	2DR HTP 2DR SDN CNV SWG	65-67 Chevy II Nova, 65-66 Chevelle	4151

Chevrolet • Chevy II, Nova

CHEVROLET • Chevy II, Nova

CODE	IMAGE	YEAR	DESCRIPTION	BODY	FITS	ITEM#
G		65-66-67-68-69	Antenna gasket	2DR 4DR SDN HTP CNV	68 Chevrolet 67-69 Chevrolet Camaro, Pontiac Firebird, 68-69 Chevrolet Chevelle, El Camino, 66-69 Chevrolet Nova	2409
G		65-66-67-68-69-70-71-72-73-74-75-76-77-78-79	Mirror gasket	2DR 4DR HTP 2DR SDN CNV SWG	68-69 Chevrolet 65-66 Bel Air Biscayne Impala 67-79 Chevrolet Camaro 66-72 Nova 66-72 Chevelle 70 El Camino 67-68 Pontiac Firebird	2305
G		66-67	Front antenna gasket	2DR HTP 2DR SDN 4DR SDN	66-67 Chevy II Nova	4052
G		66-67	Paint gasket set	2DR HTP 2DR SDN SWG	66-67 Chevy II Nova	41561
G		66-67	Taillight, bezel seals	2DR HTP 2DR SDN SWG	66-67 Chevy II Nova	4156
G		66-67	Remote mirror gasket	ALL BODY STYLES	66-67 Chevrolet All, Nova, Chevelle	2051
G		66-67	Taillight lens gaskets	2DR HTP 2DR SDN SWG	66-67 Chevy II Nova	4154
G		66-67-68-69-70-71-72	Door handle & lock gaskets set	2DR HTP 2DR SDN CNV	67-69 Chevrolet Camaro, Pontiac Firebird, 66-72 Chevy II Nova, 64-72 Chevrolet Chevelle, Pontiac Tempest, LeMans, GTO, Buick Skylark, Oldsmobile Cutlass, 70-72 Chevrolet Monte Carlo	3021
G		66-67-68-69-70-71-72	License light gasket	2DR 4DR HTP SDN CNV SWG	66-72 Chevy II Nova, Biscayne, Bel Air, Impala, Chevelle, 67-72 Chevrolet Camaro, Pontiac Firebird	2378
G		67	Sponge steering column firewall seal	2DR SDN 2DR HTP CNV SWG	67 Chevy II Nova	4045
G		67	Headlamp bezel seals	2DR HTP 2DR SDN SWG	67 Chevrolet Nova	41562
G		67-68-69	Heater seal kit small block	2DR HTP CNV 2DR SDN 4DR SDN	67-69 Chevy II, Nova, Camaro 2 Door Hardtop Convertible	3064
G		68-69	Taillight lens gaskets	2DR 4DR SDN	68-69 Chevy II Nova	4158
G		68-69	Taillight, bezel seals	2DR 4DR SDN	68-69 Chevy II Nova	41581
G		68-69	Park light lens gasket	2DR HTP 2DR SDN CNV	68-69 Chevy II Nova, 68 Chevelle	4157
G		68-69	Paint gasket set	2DR SDN	68-69 Chevy II Nova	4206



GUIDE TO SOFFSEAL'S PRODUCT CODES

















B = Bumper sets **C** = Glass channels **D** = Door related **G** = Seals, gaskets **H** = Under hood items **I** = Interior parts
M = Miscellaneous items **R** = Roofrail, pillar post & convertible items **T** = Trunk related **W** = Window related **Z** = Weatherstrip kits

Chevrolet • Chevy II, Nova



CODE	IMAGE	YEAR	DESCRIPTION	BODY	FITS	ITEM#
G		68-69	Wiper motor to firewall seal	2DR HTP CNV	68-69 Chevy II Nova, Chevelle, Camaro, Pontiac Firebird	30303
G		68-69-70	Core support shroud filler seal radiator, rad to core suppor	2DR SDN	68-70 Nova Big Block Only Chevy II	40603
G		68-69-70-71-72	Rear body to bumper seal	2DR 4DR SDN	68-72 Chevy II Nova 2 Door 4 Door Sedan	40601
G		70	Taillight lens gaskets	2DR 4DR SDN	70 Chevrolet Nova	4159
G		70	Paint gasket set	2DR SDN	70 Chevy II Nova	4207
G		70-71-72	Taillight, bezel seals	2DR 4DR SDN	70-72 Chevy II Nova	41592
G		70-71-72	Park light lens gaskets	2DR 4DR SDN	70-72 Chevy II Nova	4160
G		70-71-72-73-74	Side marker gaskets front rear	2DR 4DR SDN	70-74 Chevy II Nova	4161
G		71-72	Taillight lens gaskets	2DR 4DR SDN	71-72 Chevrolet Nova	41591
G		71-72	Paint gasket set	2DR SDN	71-72 Chevy II Nova	4208
H		62-63-64-65	Hood insulation	2DR HTP 2DR SDN CNV SWG	62-65 Chevy II Nova	4082
H		62-63-64-65-66-67	Hood to cowl seal with clips	2DR HTP 2DR SDN SWG CNV	62-67 Chevy II Nova	4058
H		64-65-66-67-68-69-70-71-72	Firewall wiring gutter plk	2DR 4DR HTP 2DR SDN SWG CNV	Chevy Chevelle, Biscayne, Bel Air, Impala, Caprice, Nova, Camaro, Cadillac Calais, Deville, Fleetwood, Oldsmobile 88, 98, Jetstar, Starfire, Pontiac Catalina, Bonneville, Firebird, Buick Lesabre, Wildcat, Electra	2328
H		66-67	Hood insulation	2DR HTP 2DR SDN CNV SWG	66-67 Chevy II Nova	4083
H		67-68-69-70-71-72-73-74-75	Firewall clutch boot	2DR HTP CNV	67-75 Chevy II Nova, Camaro,	3071
H		68	A-arm seals with staples	2DR 4DR SDN	68 Nova Chevy II	40611
H		68-69-70-71-72	Hood insulation	2DR 4DR SDN	68-72 Chevy II Nova	4085

Chevrolet • Chevy II, Nova

CODE	IMAGE	YEAR	DESCRIPTION	BODY	FITS	ITEM#
H		68-69-70-71-72-73-74	Hood to cowl seal	2DR 4DR SDN	68-74 Chevy II Nova	4055
H		68-69-70-71-72-73-74	Firewall cowl seal set	2DR HTP CNV	69 Chevrolet Camaro, Pontiac Firebird, 68-74 Chevy II Nova	3032
H		69	A-arm seals with staples	2DR 4DR SDN	69 Chevy II Nova	4063
H		70-71-72-73-74-75	A-arm seals with staples	2DR 4DR SDN	70-75 Chevy II Nova	4061
H		ALL-MODELS-WHERE-APPLICABLE	Air cleaner lid seal, cut to fit	2DR 4DR HTP 2DR SDN CNV SWG	GM All	2099
I		58-59-60-61-62-63-64-65-66-67	Accelerator pedal	2DR 4DR HTP 2DR SDN CNV SWG	58-67 Chevrolet Del Ray Biscayne Bel Air Impala Caprice, 62-67 Chevy II	2068
I		60-61-62-63-64-65-66-67-68-69	Brake & clutch pad with horizontal ribs	2DR SDN 2DR HTP CNV SWG	62-67 Chevy II Nova, 65-69 Corvair, 63-67 Corvette	4047
I		62-63-64-65-66-67	Brake pedal pad standard shift with power brakes	2DR SDN 2DR HTP CNV SWG	62-67 Chevy II Nova, 63-67 Chevrolet Corvette	40471
I		63-64	Automatic slider seals with console	2DR 4DR HTP 2DR SDN CNV SWG	63 Chevrolet Impala, 63-64 Chevrolet Nova	2120
I		63-64-65-66-67-68-69-70	Sun visor sleeve, black plastic	ALL BODY STYLES	63-70 Gm All Models, 64-70 Chrysler All Models	2022
I		64-65-66-67	Automatic console slider	2DR 4DR HTP 2DR SDN CNV SWG	64-67 Chevy II, Nova, Chevelle, Biscayne, Bel Air, Impala, 67 Chevrolet Camaro	2108
I		64-65-66-67-68-69-70	Sun visor tip	2DR 4DR SDN HTP CNV	64-70 All Makes And Models	4006
I		64-65-66-67-68-69-70-71-72-73-74	Park brake pedal pad	2DR HTP CNV	El Camino Cutlass Chevelle Chevy II Camaro Firebird LeMans Tempest GTO Grand Prix Full Size Centurion Century Electra Invicta LeSabre Regal Riviera Skylark Wildcat Monte Carlo	3094
I		67	Console slider 4 speed	2DR HTP CNV	67 Chevy II Nova, Camaro	3083
I		67-68-69	Shift boot 3 & 4-speed with console	2DR HTP 2DR SDN CNV	67-69 Chevrolet Camaro, 67 Pontiac Firebird, 68-73 Chevrolet Nova	3072
I		67-68-69-70-71-72-73-74	Automatic brake pedal pad	2DR HTP CNV 2DR SDN	67-72 Chevrolet Camaro A Body, 68-74 Nova, 68-69 Corvette, 65-69 Corvair	3097



GUIDE TO SOFFSEAL'S PRODUCT CODES

B = Bumper sets **C** = Glass channels **D** = Door related **G** = Seals, gaskets **H** = Under hood items **I** = Interior parts
M = Miscellaneous items **R** = Roofrail, pillar post & convertible items **T** = Trunk related **W** = Window related **Z** = Weatherstrip kits













Chevrolet • Chevy II, Nova



CODE	IMAGE	YEAR	DESCRIPTION	BODY	FITS	ITEM#
I		69-70-71-72-73-74-75	Park brake pedal pad	2DR HTP CNV	69-75 Chevy II Nova, Camaro, Pontiac Firebird	3095
M		00-99	Window weld ribbon sealer 3/8 inch round	ALL BODY STYLES	All Makes And Models	08622
M		57-58-59-60-61-62-63-64-65-66-67-68-69-70-71-72-73-74-75-76-77-78-79-80-81	Bellhousing to clutch fork rubber boot	2DR 4DR HTP SDN CNV SWG	57-81 GM All Manual Transmission	2196
M		58-59-60-61-62-63-64-65	Automatic power brake pad	2DR 4DR HTP SDN CNV SWG	58-65 Chevrolet Del Ray Biscayne Bel Air, 62-67 Chevy II Nova Caprice, 63-67 Corvette, 2 Door 4 Door Hardtop Sedan Convertible Station Wagon	2063
M		58-59-60-61-62-63-64-65-66-67	Standard brake & clutch pedal pads	2DR 4DR HTP 2DR SDN CNV SWG	58-67 Chevrolet Del Ray Biscayne Bel Air Impala, 62-67 Chevy II, Nova Caprice 58-62 Corvette	2065
M		58-59-60-61-62-63-64-65-66-67-68-69	Automatic brake pad with out power brakes	2DR 4DR HTP SDN CNV SWG	58-69 Chevrolet Biscayne Bel Air Impala, 63-67 Corvette 62-67 Chevy II, 65-69 Corvair, 2 Door 4 Door Hardtop Sedan Convertible Station Wagon	2066
M		62-63-64-65-66-67	Clutch fork boot	2DR HTP SDN CNV SWG	62-67 Chevy II Nova, 2 Door Hardtop Sedan Convertible Station Wagon	4095
M		66-67-68-69-70-71-72-73-74-75	Accelerator pedal	2DR HTP CNV SDN SWG	67-75 Chevrolet Camaro, Pontiac Firebird, 68-72 Chevrolet Corvette, Chevelle, 68-75 Chevy II Nova, 66-72 Pontiac Tempest, LeMans, GTO, 2 Door Hardtop Convertible Sedan Station Wagon	3090
M		67-68-69-70-71-72	Firewall insulation pad with clips with a/c	2DR SDN 4DR HTP CNV SWG	67-69 Chevrolet Camaro, Pontiac Firebird 2 Door Hardtop Convertible, 68-72 Nova, 2 Door 4 Door Sedan	3033A
M		67-68-69-70-71-72	Body Mount/bushing Bolt Kit	ALL BODY STYLES	67-72 Chevrolet Camaro, Pontiac Firebird, 68-72 Nova, 2 Door 4 Door Sedan	3025K
M		67-68-69-70-71-72	Core support bushing & bolt kit	2DR HTP CNV SDN	67-72 Chevy II Nova 2 Door 4 Door Sedan, Camaro, Pontiac Firebird, 2 Door Hardtop Convertible	3069
M		67-68-69-70-71-72	Body mount hardware kit	2DR HTP CNV SDN	67-72 Chevrolet Camaro, Pontiac Firebird 2 Door Hardtop Convertible, 68-72 Chevrolet Nova, 2 Door 4 Door Sedan	3027
M		67-68-69-70-71-72	Body mount set with steel sleeves	2DR HTP CNV SDN	67-72 Chevrolet Camaro, Pontiac Firebird, 68-72 Nova, 2 Door 4 Door Sedan	3025
M		67-68-69-70-71-72	Firewall insulation pad with clips without a/c	2DR SDN 4DR HTP CNV	67-69 Chevrolet Camaro, Pontiac Firebird 2 Door Hardtop Convertible, 68-72 Chevrolet Nova, 2 Door 4 Door Sedan	3033
M		67-68-69-70-71-72-73-74-75-76-77-78-79-80-81-82-83-84	Oil filler cap	2DR 4DR SDN HTP CNV	67-84 GM All Models	5044

Chevrolet • Chevy II, Nova

CHEVROLET • Chevy II, Nova

CODE	IMAGE	YEAR	DESCRIPTION	BODY	FITS	ITEM#
M		68-69-70-71-72	Door jamb louver	2DR HTP CNV SDN	68-69 Chevrolet Camaro, Pontiac Firebird, 2 Door Hardtop Convertible, Chevrolet Nova 2 Door Sedan	3026
M		68-69-70-71-72-73-74-75-76-77-78-79	Brake & clutch pedal pad	2DR HTP CNV SDN	67-72 Chevrolet Camaro Standard, Pontiac Firebird, 68-79 Chevrolet Corvette, 68-72 Chevrolet Nova, 64-72 Chevrolet Chevelle, 70-72 Monte Carlo 71-72 GTO, 2 Door Hardtop Convertible Sedan	3096
P		62-63-64-65	Hood side bumper; has a width of .82", a length of 10/16", and an installed height of .73". It is typically used in metal applications and has a drill/slot size of .172".	ALL BODY STYLES	Universal Fit And 62-65 Nova	K113
P		66-67	Hood side bumper; has a width of 1.255", a length of 1", and an installed height of 1.5". It is typically used in metal applications and has a drill/slot size of .250".	ALL BODY STYLES	Universal Fit And 66-67 Nova	K114
P		68-69-70-71-72-73-74	Door bumpers; has a width of .64" at the base and .45" thru the body, a length of 1", and an installed height of .78". It is typically used in metal applications and has a drill/slot size of 2x.25@.45" and sits off center.	ALL BODY STYLES	Universal Fit And 68-74 Nova	K126
R		62-63	Pillar post seal	CNV	62-63 Chevy II, Nova Convertible	4009
R		62-63	Weatherstrip kit for convertible top	CNV	62-63 Chevy II Nova, Convertible	4029
R		62-63-64	Roofrail weatherstrip with molded ends	2DR HTP	62-64 Chevy II Nova, 2 Door Hardtop	4030
R		62-63-64-65	Front rear license plate bumper; has a diameter of .48", and an installed height of 1". It is typically used in fiberglass applications and has a drill/slot of .281" with a 3/32" radius on top and a center hole.	ALL BODY STYLES	Universal Fit And 62-65 Chevy II And Universal Fit Street Rod And Custom	K162
R		65	Roofrail weatherstrip with molded ends	2DR HTP	65 Chevy II Nova, 2 Door Hardtop	4031
R		66-67	Roofrail weatherstrip with molded ends	2DR HTP	66-67 Chevy II Nova, 2 Door Hardtop	4005
T		62-63-64-65-66	Trunk mat rubber	2DR HTP 2DR SDN CNV	62-66 Chevy II Nova	4062
T		62-63-64-65-66-67	Tailgate weatherstrip with molded ends	SWG	62-67 Chevrolet Nova, Chevy II, Station Wagon	4014



GUIDE TO SOFFSEAL'S PRODUCT CODES









B = Bumper sets **C** = Glass channels **D** = Door related **G** = Seals, gaskets **H** = Under hood items **I** = Interior parts
M = Miscellaneous items **R** = Roofrail, pillar post & convertible items **T** = Trunk related **W** = Window related **Z** = Weatherstrip kits

Chevrolet • Chevy II, Nova



CODE	IMAGE	YEAR	DESCRIPTION	BODY	FITS	ITEM#
T		62-63-64-65-66-67-68-69-70-71-72-73	Door and tailgate bottom drain hole seal	2DR 4DR HTP SDN CNV SWG CPE	62-73 Chevy Nova, Chevelle, Impala, Caprice Pontiac Catalina, Star Chief, Bonneville, Grand Prix Oldsmobile F85	2118
T		64-65-66-67-68-69-70-71-72-73-74-75-76-77	Trunk weatherstrip exact profile length 17 feet	2DR 4DR HTP 2DR SDN CNV	65-72 Chevy II, 65-72 Chevrolet Biscayne, 65-75 Chevrolet Bel Air, 65-76 Chevrolet Impala, 65-76 Chevrolet Caprice, 64-77 Chevrolet Chevelle, 70-77 Chevrolet Monte Carlo, 65-76 Buick LeSabre, 64-77 Buick Wildcat, 64-77 Buick Skylark, 71-73 Buick Centurion, 64-72 Buick Grand Special, 73-77 Buick Century, 73-88 Buick Regal, 73-88 Buick Grand National, 65-76 Buick Electra, 65-76 Oldsmobile Delta 88, 67-69 Oldsmobile Delmont 88, 65-66 Oldsmobile Dynamic 88, 65-66 Oldsmobile Starfire, 65 Oldsmobile Jetstar, 64-77 Oldsmobile Cutlass 442, 64-88 Oldsmobile Cutlass, 65-76 Oldsmobile 98, 65-76 Pontiac Parisienne, 64-72 Pontiac LeMans, 65-70 Pontiac Catalina, 65-66 Pontiac Star Chief, 67-70 Pontiac Executive, 71-75 Pontiac Grand Ville, 65-77 Pontiac Grand Prix, 64-72 Pontiac Tempest, 62-72 Nova, Ventura, 73-74 Non-Hatchback, Up to 1975 with groove channel, Apollo, Nova, Omega, Ventura 65-76 C-Body	2003
T		67	Trunk mat rubber	2DR HTP CNV	67 Chevy II Nova	4065
T		67-68-69-70-71-72	Filler neck hose	2DR HTP 2DR SDN CNV	67-68 Chevrolet Camaro, Pontiac Firebird, 68-72 Nova	3028
T		67-68-69-70-71-72	Gas tank filler neck sleeve	2DR HTP 2DR SDN CNV	67-68 Chevrolet Camaro, Pontiac Firebird, 68-72 Nova	3029
T		68-69-70-71-72	Trunk mat	2DR 4DR SDN	68-72 Chevy II Nova	4066
T		73-74	Hatchback weatherstrip	2DR CPE	73-74 Buick Apollo, Chevrolet Nova, Oldsmobile Omega, Pontiac Ventura, 2 Door Coupe	4013
T		75-76-77-78-79-80-81-82-83-84-85-86-87-88-89-90-91-92	Trunk and Hatchback weatherstrip	2DR 4DR SDN HTP CNV	77-85 Chevrolet Impala, 77-91 Chevrolet Caprice, 82-92 Chevrolet Camaro, 75-79 Chevrolet Nova, 78-88 Chevrolet Monte Carlo, 78-83 Chevrolet Malibu, 78-83 Pontiac LeMans, 82-92 Pontiac Firebird, 75-91 Pontiac Ventura, 77-86 Pontiac Parisienne, 77-81 Pontiac Catalina, 69-88 Pontiac Grand Prix, 64-87 Pontiac LeMans, Pontiac Grand Am, 64-77 Pontiac GTO, 73-79 Oldsmobile Omega, 77-85 Oldsmobile Delta 88, 77-84 Oldsmobile 98, 77-88 Oldsmobile Cutlass, 73-75 Buick Apollo, 76-79 Buick Skylark, 77-79 Phoenix, 73-88 Buick Regal, 77-84 Buick Electra, 77-85 Buick LeSabre, 77-78 Buick Riviera, 77-91 C-Body	2424

Chevrolet • Chevy II, Nova















CODE	IMAGE	YEAR	DESCRIPTION	BODY	FITS	ITEM#
W		37-38-39-40-41-42-43-44-45-46-47-48-49-50-51-52-53-54	Mohair channel liner, 4 feet of 7/8 inch mohair lining material	CNV 2DR 4DR HTP	Bel Air 150 210, Nomad, Chieftain, 860/870 Star Chief, Safari, Super Chief, Bonneville, Nova, Omega, Apollo, Ventura, Skylark	0420
W		62-63	Window weatherstrip replacement style	CNV	62-63 Chevy II Nova Convertible	40692
W		62-63-64-65	Quarter window seals	2DR HTP CNV	62-65 Chevy II Nova 2 Door Hardtop, 62-63 Convertible	4032
W		62-63-64-65	Window weatherstrip replacement style	2DR HTP	62-65 Chevy II Nova, 2 Door Hardtop	4070
W		62-63-64-65	Window weatherstrip replacement style	2DR SDN	62-65 Chevy II Nova 2 Door Sedan	4069
W		62-63-64-65-66-67	Door glass run channel, upper & rear	2DR 4DR SDN	62-67 Chevy II Nova, Chevelle, 2 Door 4 Door Sedan	4039
W		62-63-64-65-66-67	Vent window seal	CNV 2DR HTP	62-67 Chevy II Nova, Convertible 2 Door Hardtop	40401
W		62-63-64-65-66-67	Rubber door jambs	2DR HTP CNV	62-67 Chevy II, Nova 2 Door Hardtop Convertible	4034
W		62-63-64-65-66-67	Rear door stationary vent window seals	4DR SWG	62-67 Chevy II, Nova 4 Door Station Wagon Only	4057
W		62-63-64-65-66-67	Rear stationary side window weatherstrip	SWG	62-67 Chevrolet Nova Station Wagon	4056
W		62-63-64-65-66-67	Vent window division bar channel	2DR 4DR CNV	62-67 Chevy II Nova, Oldsmobile, Buick, Pontiac, 2 Door 4 Door Convertible	2245
W		62-63-64-65-66-67	Rear side quarter window seal	2DR SDN	62-67 Chevy II Nova, 2 Door, Sedan	2244
W		62-63-64-65	Window weatherstrip	4DR SDN	62-65 Chevy II Nova, 4 Door Sedan	4073
W		66-67	Window weatherstrip replacement style	2DR SDN	66-67 Chevy II Nova 2 Door Sedan	4069A
W		66-67	Quarter window seals	2DR HTP CNV	66-67 Chevy II Nova 2 Door Hardtop	4033
W		66-67	Window weatherstrip, original style with round bead	2DR HTP	66-67 Chevrolet Nova, 2 Door Hardtop	4071A
W		66-67	Window weatherstrip original style with round bead	4DR SDN	66-67 Chevy II Nova, 4 Door Sedan	4072
W		66-67	Window weatherstrip replacement style	2DR HTP	66-67 Chevy II Nova, 2 Door Hardtop	4071



GUIDE TO SOFFSEAL'S PRODUCT CODES
B = Bumper sets **C** = Glass channels **D** = Door related **G** = Seals, gaskets **H** = Under hood items **I** = Interior parts
M = Miscellaneous items **R** = Roofrail, pillar post & convertible items **T** = Trunk related **W** = Window related **Z** = Weatherstrip kits

Chevrolet • Chevy II, Nova



CODE	IMAGE	YEAR	DESCRIPTION	BODY	FITS	ITEM#
W		68-69-70-71-72	Window weatherstrip replacement style	4DR SDN	68-72 Chevy II Nova, 4 Door Sedan	40742
W		68-69-70-71-72	Window weatherstrip, original style with round bead	2DR SDN	68-72 Chevrolet Nova, 68 Chevy II, 2 Door	40741
W		68-69-70-71-72	Window weatherstrip replacement style	2DR SDN	68-72 Chevy II Nova, 2 Door Sedan	4074
W		68-69-70-71-72	Vent window division bar channel	2DR 4DR SDN	68-72 Nova Chevy II	40403
W		68-69-70-71-72	Vent window weatherstrip	2DR 4DR SDN	68-72 Chevrolet Nova 2 Door 4 Door Sedan	40402
W		68-69-70-71-72	Quarter glass run channel, front, top & back	2DR SDN	68-72 Chevrolet Nova, 2 Door, Sedan	4077
W		68-69-70-71-72-73-74	Door glass run channel fits in door frame upper & rear	2DR SDN	68-72 Chevrolet El Camino, 68-74 Chevrolet Nova, 2 Door Sedan	5126
W		73-74	Window weatherstrip replacement style	2DR SDN	73-74 Chevrolet Nova, 2 Door Sedan	4075
W		75-76-77-78-79	Window weatherstrip	2DR SDN	75-79 Chevrolet Nova, 2 Door Sedan	4076
Z		62-63	Weatherstrip kit, includes bumper kit, door weatherstrips, hood to cowl seal, paint gaskets, trunk weatherstrip, window weatherstrips, quarter window seals, roofrail weatherstrips, door u jamba	2DR HTP	62-63 Chevrolet Nova 2 Door Hardtop	KIT405
Z		62-63	Weatherstrip kit, includes bumper kit, door weatherstrips, hood to cowl seal, paint gaskets, trunk weatherstrip, window weatherstrips	2DR SDN	62-63 Chevrolet Nova 2 Door Sedan	KIT410
Z		62-63-64	Weatherstrip kit, includes trunk weatherstrip, door weatherstrip, roofrail weatherstrip	2DR HTP	62-64 Chevrolet Nova 2 Door Hardtop	KIT405X
Z		64	Weatherstrip kit, includes bumper kit, door weatherstrips, hood to cowl seal, paint gaskets, trunk weatherstrip, window weatherstrips, quarter window seals, roofrail weatherstrips, door u jamba	2DR HTP	64 Chevrolet Nova 2 Door Hardtop	KIT406
Z		64	Weatherstrip kit, includes bumper kit, door weatherstrips, hood to cowl seal, paint gaskets, trunk weatherstrip, window weatherstrips	2DR SDN	64 Chevrolet Nova 2 Door Sedan	KIT411

Chevrolet • Chevy II, Nova

CODE	IMAGE	YEAR	DESCRIPTION	BODY	FITS	ITEM#
Z		65	Weatherstrip kit, includes bumper kit, door weatherstrips, hood to cowl seal, paint gaskets, trunk weatherstrip, window weatherstrips, quarter window seals, roofrail weatherstrips, door u jamba	2DR HTP	65 Chevrolet Nova 2 Door Hardtop	KIT407
Z		65	Weatherstrip kit, includes trunk weatherstrip, door weatherstrip, roofrail weatherstrip	2DR HTP	65 Chevrolet Nova 2 Door Hardtop	KIT407X
Z		65	Weatherstrip kit, includes bumper kit, door weatherstrips, hood to cowl seal, paint gaskets, trunk weatherstrip, window weatherstrips	2DR SDN	65 Chevrolet Nova 2 Door Sedan	KIT412
Z		66	Weatherstrip kit, includes bumper kit, door weatherstrips, hood to cowl seal, paint gaskets, trunk weatherstrip, window weatherstrips	2DR SDN	66 Chevrolet Nova 2 Door Sedan	KIT413
Z		66	Weatherstrip kit, includes bumper kit, door weatherstrips, hood to cowl seal, paint gaskets, trunk weatherstrip, window weatherstrips, quarter window seals, roofrail weatherstrips, door u jamba	2DR HTP	66 Chevrolet Nova 2 Door Hardtop	KIT408
Z		66-67	Weatherstrip kit, includes trunk weatherstrip, door weatherstrip, roofrail weatherstrip	2DR HTP	66-67 Chevrolet Nova 2 Door Hardtop	KIT408X
Z		67	Weatherstrip kit, includes bumper kit, door weatherstrips, hood to cowl seal, paint gaskets, trunk weatherstrip, window weatherstrips	2DR SDN	67 Chevrolet Nova 2 Door Sedan	KIT414
Z		67	Weatherstrip kit, includes bumper kit, door weatherstrips, hood to cowl seal, paint gaskets, trunk weatherstrip, window weatherstrips, quarter window seals, roofrail weatherstrips, door u jamba	2DR HTP	67 Chevrolet Nova 2 Door Hardtop	KIT409
Z		68	Weatherstrip kit, includes bumper kit, door weatherstrips, hood to cowl seal, paint gaskets, trunk weatherstrip, window weatherstrips, a arms seals	2DR SDN	68 Chevrolet Nova 2 Door Sedan	KIT415
Z		69	Weatherstrip kit, includes bumper kit, door weatherstrips, hood to cowl seal, paint gaskets, trunk weatherstrip, window weatherstrips, a arm seals	2DR SDN	69 Chevrolet Nova 2 Door Sedan	KIT418
Z		70	Weatherstrip kit, includes bumper kit, door weatherstrips, hood to cowl seal, paint gaskets, trunk weatherstrip, window weatherstrips, a arm seals	2DR SDN	70 Chevrolet Nova 2 Door Sedan	KIT416
Z		71-72	Weatherstrip kit, includes bumper kit, door weatherstrips, hood to cowl seal, paint gaskets, trunk weatherstrip, window weatherstrips, a arm seals	2DR HTP	71-72 Chevrolet Nova 2 Door Hardtop	KIT417















GUIDE TO SOFFSEAL'S PRODUCT CODES

B = Bumper sets **C** = Glass channels **D** = Door related **G** = Seals, gaskets **H** = Under hood items **I** = Interior parts
M = Miscellaneous items **R** = Roofrail, pillar post & convertible items **T** = Trunk related **W** = Window related **Z** = Weatherstrip kits



CODE	IMAGE	YEAR	DESCRIPTION	BODY	FITS	ITEM#
B		62-63-64-65-66-67-68-69-70-71-72-73-74-75	Trunk bumpers	2DR HTP 2DR SDN CNV	70-75 Chevrolet Camaro, Pontiac Firebird, 62-73 Chevy II Nova, 64-72, Pontiac GTO, Tempest, Le Mans, Chevrolet Chevelle, Monte Carlo, Buick Skylark, Oldsmobile Cutlass, 65-69 Chevrolet Corvair, 65-70 Full Size Chevrolet	3112
B		65-66-67-68-69-70-71-72-73-74-75-76-77-78-79-80-81-82-83-84-85-86-87-88-89-90-91-92-93-94-95-96-97-98-99-00-01-02	Door bumpers	2DR 4DR HTP 2DR SDN SWG CNV	65-66 Chevrolet, Pontiac, Oldsmobile, Buick, 65-69 Corvair, 70-02 Chevrolet Camaro, Pontiac Firebird, 68-81 Chevelle, GTO, Cutlass, Skylark, 68-72 El Camino, Tempest, LeMans GTO, 70-72 Monte Carlo	2321
D		60-61-62-63-64	Door weatherstrip with clips	2DR SDN	60-64 Chevrolet Corvair 2 Door Sedan	8006
D		60-61-62-63-64	Door weatherstrip front door with clips	4DR SDN	60-64 Chevrolet Corvair 4 Door Sedan	8007
D		60-61-62-63-64	Door weatherstrip rear door with clips	4DR SDN	60-64 Chevrolet Corvair 4 Door Sedan	8008
D		65-66-67-68-69	Door weatherstrip with clips and molded ends	2DR HTP CNV	65-69 Chevrolet Corvair Hardtop Convertible	8002
H		60-61-62-63-64-65-66-67-68-69	Rear engine compartment weatherstrip	2DR HTP CNV	60-69 Chevrolet Corvair, 2 Door Hardtop Convertible	8010
H		ALL-MODELS-WHERE-APPLICABLE	Air cleaner lid seal, cut to fit	2DR 4DR HTP 2DR SDN CNV SWG	GM All	2099
I		60-61-62-63-64-65-66-67-68-69	Brake & clutch pad with horizontal ribs	2DR SDN 2DR HTP CNV SWG	62-67 Chevy II Nova, 65-69 Corvair, 63-67 Corvette	4047
I		67-68-69-70-71-72-73-74	Automatic brake pedal pad	2DR HTP CNV 2DR SDN	67-72 Chevrolet Camaro A Body, 68-74 Nova, 68-69 Corvette, 65-69 Corvair	3097
M		00-99	Window weld ribbon sealer 3/8 inch round	ALL BODY STYLES	All Makes And Models	08622
M		58-59-60-61-62-63-64-65-66-67-68-69	Automatic brake pad with out power brakes	2DR 4DR HTP SDN CNV SWG	58-69 Chevrolet Biscayne Bel Air Impala, 63-67 Corvette 62-67 Chevy II, 65-69 Corvair, 2 Door 4 Door Hardtop Sedan Convertible Station Wagon	2066
R		62-63-64	Convertible top header seal with clips	CNV	62-64 Chevrolet Corvair Convertible	8050
R		65-66-67	Roofrail weatherstrip	4DR HTP	65-67 Chevrolet Corvair 4 Door Hardtop	8070
R		65-66-67-68-69	Pillar post weatherstrip with molded ends	CNV	65-69 Chevrolet Corvair Convertible	8003

Chevrolet • Corvair

CODE	IMAGE	YEAR	DESCRIPTION	BODY	FITS	ITEM#
R		65-66-67-68-69	Roofrail weatherstrip	2DR HTP	65-69 Chevrolet Corvair, 2 Door Hardtop	8004
R		65-66-67-68-69	Header seal with clips and molded ends	CNV	65-69 Chevrolet Corvair Convertible	8005
T		58-59-60-61-62-63-64-65-66-67-68-69	Trunk weatherstrip exact profile	2DR 4DR HTP 2DR SDN CNV	58-64 Chevrolet Biscayne, 58-64 Chevrolet Bel Air, Chevrolet Impala, 60-69 Chevrolet Corvair, 59-64 Pontiac Parisienne, 59-64 Pontiac Catalina, 59-64 Pontiac Star Chief, 60-61 Pontiac Ventura, 62-64 Pontiac Grand Prix, 58-64 Oldsmobile Delta 88, 58-64 Oldsmobile Dynamic 88, Oldsmobile Super 88, Oldsmobile Super 98, 61-64 Oldsmobile Starfire, 64 Oldsmobile Jetstar, 59-64 Buick LeSabre, 59-62 Buick Invicta, 59-64 Buick Electra, 62-64 Buick Wildcat, 63-65 Buick Riviera, 58-60 Cadillac Deville, Cadillac Eldorado, Cadillac Series 62, Cadillac Series 60 Special, Cadillac Series 75, 58-64 C-Body	2001
W		60-61-62-63-64	Window weatherstrip replacement style	2DR SDN	60-64 Chevrolet Corvair, 2 Door Sedan	8020
W		60-61-62-63-64	Window weatherstrip replacement style	4DR SDN	60-64 Chevrolet Corvair, 4 Door Sedan	8022
W		61-62-63-64	Window weatherstrip replacement style	SWG	61-64 Chevrolet Corvair Station Wagon	8023
W		62-63-64	Window weatherstrip replacement style	CNV	62-64 Chevrolet Corvair Convertible	8021
W		65-66-67-68-69	Window weatherstrip replacement style	2DR HTP	65-69 Chevrolet Corvair 2 Door Hardtop	8025
W		65-66-67-68-69	Window weatherstrip replacement style	CNV	65-69 Chevrolet Corvair Convertible	8026
W		65-66-67-68-69	Window weatherstrip	4DR HTP	65-69 Chevrolet Corvair 4 Door Hardtop	8027
W		65-66-69	Quarter window seals	2DR HTP CNV	65-69 Chevrolet Corvair, Hardtop Convertible	8112
Z		65-66-67-68-69	Weatherstrip kit, includes door weatherstrips, front deck weatherstrip, quarter window seals, rear hood weatherstrip, window weatherstrips, convertible header seal, pillar post seals	CNV	65-69 Chevrolet Corvair Convertible	KIT806
Z		65-68-69	Weatherstrip kit, includes door weatherstrips, front deck weatherstrip, quarter window seals, rear hood weatherstrip, window weatherstrips, roofrail weatherstrips	2DR HTP	65-69 Chevrolet Corvair 2 Door Hardtop	KIT805

















GUIDE TO SOFFSEAL'S PRODUCT CODES

B = Bumper sets **C** = Glass channels **D** = Door related **G** = Seals, gaskets **H** = Under hood items **I** = Interior parts
M = Miscellaneous items **R** = Roofrail, pillar post & convertible items **T** = Trunk related **W** = Window related **Z** = Weatherstrip kits



CODE	IMAGE	YEAR	DESCRIPTION	BODY	FITS	ITEM#
D		69-70-71-72-73-74-75-76-77	Door weatherstrip with molded ends	2DR HTP	69-77 Chevrolet Corvette Coupe	8312
D		78-79-80-81-82	Door weatherstrip with molded ends	2DR HTP	78-82 Chevrolet Corvette Coupe	8311
D		84-85-86-87-88-89-90-91-92-93-94-95-96	Door weatherstrip with clips & molded ends	2DR HTP	84-96 Chevrolet Corvette Coupe	8300
G		59-60-61-62-63-64-65-67	Heater blower motor seal with air flow	2DR HTP SDN CNV SWG TRK	59-62 Passenger 60-63 Truck 63-67 Chevrolet Corvette, 2 Door Hardtop Sedan Convertible Station Wagon Tr	2097
G		68-69	Side marker gasket	2DR HTP	68-69 Chevrolet Corvette Coupe	8602
G		68-69-70-71-72	Rear lamp housing lens gasket	2DR HTP	68-72 Chevrolet Corvette Coupe	8600
G		68-69-70-71-72	Rear lamp housing body mount gasket	2DR HTP	68-72 Chevrolet Corvette Coupe	8601
G		91-92	Taillight lens gaskets	CPE CNV	91-92 Chevrolet Corvette Zr1 Coupe Convertible	8603
H		63-64-65-66-67-68-69-70-71-72-73-74-75-76-77-78-79-80-81-82	Hood to cowl seal	2DR HTP	63-82 Chevrolet Corvette Coupe	8313
I		60-61-62-63-64-65-66-67-68-69	Brake & clutch pad with horizontal ribs	2DR SDN 2DR HTP CNV SWG	62-67 Chevy II Nova, 65-69 Corvair, 63-67 Corvette	4047
I		62-63-64-65-66-67	Brake pedal pad standard shift with power brakes	2DR SDN 2DR HTP CNV SWG	62-67 Chevy II Nova, 63-67 Chevrolet Corvette	40471
I		67-68-69-70-71-72-73-74	Automatic brake pedal pad	2DR HTP CNV 2DR SDN	67-72 Chevrolet Camaro A Body, 68-74 Nova, 68-69 Corvette, 65-69 Corvair	3097
M		00-99	Window weld ribbon sealer 3/8 inch round	ALL BODY STYLES	All Makes And Models	08622
M		55-56-57	Accelerator pedal	2DR 4DR HTP SDN CNV SWG	55-57 Chevrolet 150 210 Bel Air Nomad, Pontiac, 55-57 Corvette, 2 Door 4 Door Hardtop Sedan Convertible Station Wagon	1050
M		55-56-57	Clutch & brake pads	2DR 4DR HTP SDN CNV SWG	55-57 Chevrolet, Pontiac All Models, Oldsmobile, Corvette, 2 Door 4 Door Hardtop Sedan Convertible Station Wagon	1051
M		57-58-59-60-61-62-63-64-65-66-67-68-69-70-71-72-73-74-75-76-77-78-79-80-81	Bellhousing to clutch fork rubber boot	2DR 4DR HTP SDN CNV SWG	57-81 GM All Manual Transmission	2196

Chevrolet • Corvette

CODE	IMAGE	YEAR	DESCRIPTION	BODY	FITS	ITEM#
M		58-59-60-61-62-63-64-65	Automatic power brake pad	2DR 4DR HTP SDN CNV SWG	58-65 Chevrolet Del Ray Biscayne Bel Air, 62-67 Chevy II Nova Caprice, 63-67 Corvette, 2 Door 4 Door Hardtop Sedan Convertible Station Wagon	2063
M		58-59-60-61-62-63-64-65	Power brake pedal pad with standard trans	2DR 4DR HTP SDN CNV SWG	58-65 Full-Size Chevrolet Biscayne Bel Air Impala Caprice, 58-62 Corvette, 58 Del Ray, 2 Door 4 Door Hardtop Sedan Convertible Station Wagon	20651
M		58-59-60-61-62-63-64-65-66-67	Standard brake & clutch pedal pads	2DR 4DR HTP 2DR SDN CNV SWG	58-67 Chevrolet Del Ray Biscayne Bel Air Impala, 62-67 Chevy II, Nova Caprice 58-62 Corvette	2065
M		58-59-60-61-62-63-64-65-66-67-68-69	Automatic brake pad with out power brakes	2DR 4DR HTP SDN CNV SWG	58-69 Chevrolet Biscayne Bel Air Impala, 63-67 Corvette 62-67 Chevy II, 65-69 Corvair, 2 Door 4 Door Hardtop Sedan Convertible Station Wagon	2066
M	 <small>IMAGE COMING SOON</small>	63-64-65-66-67	Accelerator pedal	2DR HTP	63-67 Chevrolet Corvette Coupe	8001
M		65-67-68	Firewall clutch rod boot	2DR HTP CNV 2DR SDN	65-68 Chevrolet Impala Caprice Corvette	2516
M		66-67-68-69-70-71-72-73-74-75	Accelerator pedal	2DR HTP CNV SDN SWG	67-75 Chevrolet Camaro, Pontiac Firebird, 68-72 Chevrolet Corvette, Chevelle, 68-75 Chevy II Nova, 66-72 Pontiac Tempest, LeMans, GTO, 2 Door Hardtop Convertible Sedan Station Wagon	3090
M		67-68-69-70-71-72-73-74-75-76-77-78-79-80-81	Accelerator pedal trim	2DR SDN HTP CNV	67-81 Chevrolet Camaro 2 Door Hardtop, Convertible, 68-72 Corvette, Coupe, Convertible	3091
M		68-69	Carpet insert for seat belts	2DR HTP CNV	68-69 Chevrolet Corvette Coupe, Convertible	0900
M		68-69-70-71-72-73-74-75-76-77-78-79	Brake & clutch pedal pad	2DR HTP CNV SDN	67-72 Chevrolet Camaro Standard, Pontiac Firebird, 68-79 Chevrolet Corvette, 68-72 Chevrolet Nova, 64-72 Chevrolet Chevelle, 70-72 Monte Carlo 71-72 GTO, 2 Door Hardtop Convertible Sedan	3096
M	 <small>IMAGE COMING SOON</small>	84-85-86-87-88-89-90-91-92-93-94-95-96	Brake pedal pad	ALL BODY STYLES	84-96 Chevrolet Corvette Coupe	8316
R		63-64-65-66-67	Pillar post	2DR HTP	63-67 Chevrolet Corvette Coupe	8310
R		68-69-70-71-72	Pillar post with attached hinge pillar	2DR HTP	68-72 Chevrolet Corvette Coupe	8309
R		68-69-70-71-72-73-74-75-76-77-78-79-80-81-82	Pillar post with out hinge pillar	ALL BODY STYLES	68-82 Chevrolet Corvette Coupe	8308
R		69-70-71-72-73-74-75-76-77	Rear pillar	2DR HTP	69-77 Chevrolet Corvette Coupe	8307



GUIDE TO SOFFSEAL'S PRODUCT CODES

B = Bumper sets **C** = Glass channels **D** = Door related **G** = Seals, gaskets **H** = Under hood items **I** = Interior parts
M = Miscellaneous items **R** = Roofrail, pillar post & convertible items **T** = Trunk related **W** = Window related **Z** = Weatherstrip kits

Chevrolet • Corvette



CODE	IMAGE	YEAR	DESCRIPTION	BODY	FITS	ITEM#
R		69-70-71-72-73-74-75-76-77	T-top seals	2DR HTP	69-77 Chevrolet Corvette Coupe	8305
R		78-79-80-81-82	T-top seals	2DR HTP	78-82 Chevrolet Corvette Coupe	8304
R		78-79-80-81-82-83-84-85	Rear pillar	2DR HTP	78-82 Chevrolet Corvette Coupe	8306
R		84-85-86-87-88-89-90-91-92-93-94-95-96	Rear roof seal b pillar	2DR HTP	84-96 Chevrolet Corvette Coupe	8301
R		84-85-86-87-88-89-90-91-92-93-94-95-96	Header seal, targa	2DR HTP CNV	84-96 Chevrolet Corvette Coupe, Convertible	8302
R		84-85-86-87-88-89-90-91-92-93-94-95-96	Targa top side seal	2DR HTP	84-96 Chevrolet Corvette Coupe	8303
R		86-87-88-89-90-91-92-93-94-95-96-97-98	Weatherstrip kit for convertible top 6 piece	CNV	86-96 Chevrolet Corvette Convertible	8314
T		84-85-86-87-88-89-90-91-92-93-94-95-96	Hatch seal	2DR HTP CNV	84-96 Chevrolet Corvette Coupe	8315
W		69-70-71-72-73-74-75-76-77-78-79-80-81-82	Window weatherstrip original style with round bead outers only	2DR HTP	69-82 Chevrolet Corvette Coupe	8604
W		69-70-71-72-73-74-75-76-77-78-79-80-81-82	Window weatherstrip original style with round bead	CNV	69-82 Chevrolet Corvette Convertible	8605
W		84-85-86-87-88-89	Window weatherstrip original style with round bead	2DR HTP CNV	84-89 Chevrolet Corvette, Coupe, Convertible	8606
W		90-91-92-93-94-95	Window weatherstrip original style with round bead	2DR HTP CNV	90-95 Chevrolet Corvette, Coupe, Convertible	8607
Z		69-70-71-72	Weatherstrip kit, includes door weatherstrips, pillar post seals, rear pillar seals, t top seals, hood to cowl seal, window weatherstrips	2DR HTP	69-72 Chevrolet Corvette Coupe	KIT813
Z		73-74-75-76-77	Weatherstrip kit, includes door weatherstrips, pillar post seals, rear pillar seals, t top seal, hood to cowl seal, window weatherstrips	2DR HTP	73-77 Chevrolet Corvette Coupe	KIT812
Z		78-79-80-81-82	Weatherstrip kit, includes door weatherstrips, pillar post seals, rear pillar seals, t top seal, hood to cowl seal, window weatherstrips	2DR HTP	78-82 Chevrolet Corvette Coupe	KIT811
Z		84-85-86-87-88-89-90-91-92-93-94-95-96	Weatherstrip kit, includes door weatherstrips, front, rear & side targa seals	2DR HTP	84-96 Chevrolet Corvette Coupe	KIT810

Chevrolet • Del Ray

CODE	IMAGE	YEAR	DESCRIPTION	BODY	FITS	ITEM#
B		51-52-53-54-55-56-57-58	Upper vent window bumpers	2DR 4DR HTP 2DR SDN CNV SWG	51-58 Chevrolet 150 210 Bel Air Nomad Del Ray Biscayne Impala, 51-54 Chevrolet, Pontiac, Oldsmobile, Buick, Cadillac, Hardtop Convertible	1224
B		58-59	Gas door bumper	2DR 4DR HTP 2DR SDN CNV SWG	58-59 Chevrolet Del Ray, Biscayne, Bel Air, Impala	2074
D		58	Door weatherstrip with molded corner	2DR SDN	58 Chevrolet Bel Air, Del Ray, Pontiac Chieftain, Catalina, 2 Door Sedan	2004
D		58	Door j weatherstrip	2DR 4DR HTP 2DR SDN CNV SWG	58 Chevrolet Del Ray, Biscayne, Bel Air, Impala, 58 Cadillac, 57-58 Oldsmobile 88 Oldsmobile 98, 57-58 Buick Special Century, Super, Roadmaster, 58 Pontiac	2044
G		56-58	Rear body to bumper seal	2DR 4DR HTP 2DR SDN CNV SWG	56, 58 Chevrolet	1090
G		57-58-59-60	Inner to outer fender seals	2DR 4DR HTP 2DR SDN CNV SWG	57-60 Chevrolet	1103
G		58	Heater plenum to firewall gasket	2DR 4DR HTP 2DR SDN CNV SWG	58 Chevrolet Del Ray Biscayne Impala Bel Air	2037
G		58	Heater box seal kit non a/c 2 piece	2DR 4DR HTP 2DR SDN CNV SWG	58 Chevrolet Del Ray Biscayne Impala Bel Air	20371
G		58	A-arm seals w/o clips	2DR 4DR HTP 2DR SDN CNV SWG	58 Chevrolet Del Ray Biscayne Impala Bel Air	2042
G		58	Lens gasket kit	2DR 4DR HTP 2DR SDN CNV SWG	58 Chevrolet Del Ray Biscayne Impala Bel Air	2045
G		58	Antenna base gasket	2DR 4DR HTP 2DR SDN CNV SWG	58 Chevrolet Del Ray Biscayne Impala Bel Air	2046
G		58	Steering column seal with automatic trans	2DR 4DR HTP 2DR SDN CNV SWG	58 Chevrolet Pontiac	2056
G		58	Steering column seal sponge	2DR 4DR HTP 2DR SDN CNV SWG SR	58 Chevrolet Pontiac, Universal Fit Street Rod And Custom, Standard Transmission	2056A
G		58	Anti-squeak fender seals	2DR 4DR HTP 2DR SDN CNV SWG	58 Chevrolet Del Ray Biscayne Impala Bel Air	2057





GUIDE TO SOFFSEAL'S PRODUCT CODES

B = Bumper sets **C** = Glass channels **D** = Door related **G** = Seals, gaskets **H** = Under hood items **I** = Interior parts
M = Miscellaneous items **R** = Roofrail, pillar post & convertible items **T** = Trunk related **W** = Window related **Z** = Weatherstrip kits



CODE	IMAGE	YEAR	DESCRIPTION	BODY	FITS	ITEM#
G		58	Front splash pan seals	2DR 4DR HTP 2DR SDN SWG CNV	58 Chevrolet Del Ray Biscayne Impala Bel Air	2058
G		58	Door handle & lock gaskets	2DR 4DR HTP 2DR SDN SWG CNV	58 Chevrolet Pontiac	2059
H		58	Hood to fender bumpers	2DR 4DR SDN HTP CNV	58 Chevrolet	2086
H		58	Hood insulation	2DR 4DR HTP 2DR SDN CNV SWG	58 Chevrolet Del Ray Biscayne Bel Air Impala	21451
H		58-59-60	Hood to cowl seal	2DR 4DR HTP 2DR SDN CNV SWG	58-60 Chevrolet Del Ray Biscayne Impala Bel Air	2060
I		58	Gear shift grommet column	2DR 4DR SDN HTP CNV	58 Chevrolet Del Ray, Biscayne, Bel Air, Impala, Cadillac, Oldsmobile 88 Oldsmobile 98, Buick Special, Century, Roadmaster, Riviera, Pontiac	2185
I		58-59-60- 61-62-63-64	Emergency brake pedal pad with inverted letter	2DR 4DR HTP 2DR SDN CNV SWG	58-64 Chevrolet Del Ray Biscayne Bel Air Impala	2067
I		58-59-60-61-62- 63-64-65-66-67	Accelerator pedal	2DR 4DR HTP 2DR SDN CNV SWG	58-67 Chevrolet Del Ray Biscayne Bel Air Impala Caprice, 62-67 Chevy II	2068
M		58-59-60-61- 62-63-64-65	Automatic power brake pad	2DR 4DR HTP SDN CNV SWG	58-65 Chevrolet Del Ray Biscayne Bel Air, 62-67 Chevy II Nova Caprice, 63- 67 Corvette, 2 Door 4 Door Hardtop Sedan Convertible Station Wagon	2063
M		58-59-60-61- 62-63-64-65	Power brake pedal pad with standard trans	2DR 4DR HTP SDN CNV SWG	58-65 Full-Size Chevrolet Biscayne Bel Air Impala Caprice, 58-62 Corvette, 58 Del Ray, 2 Door 4 Door Hardtop Sedan Convertible Station Wagon	20651
M		58-59-60-61-62- 63-64-65-66-67	Standard brake & clutch pedal pads	2DR 4DR HTP 2DR SDN CNV SWG	58-67 Chevrolet Del Ray Biscayne Bel Air Impala, 62-67 Chevy II, Nova Caprice 58-62 Corvette	2065
M		58-59-60-61- 62-63-64-65- 66-67-68-69	Automatic brake pad with out power brakes	2DR 4DR HTP SDN CNV SWG	58-69 Chevrolet Biscayne Bel Air Im- pala, 63-67 Corvette 62-67 Chevy II, 65-69 Corvair, 2 Door 4 Door Hardtop Sedan Convertible Station Wagon	2066

Chevrolet • El Camino

CODE	IMAGE	YEAR	DESCRIPTION	BODY	FITS	ITEM#
B		62-63-64	Seat back bumpers	2DR HTP CNV	62-64 Chevrolet Impala, Nova, Chevelle, El Camino, For SS	2172
B		64-65-66	Door bumpers	2DR 4DR HTP 2DR SDN CNV SWG	64-66 Chevrolet Chevelle, El Camino, Nova, Pontiac GTO, Tempest, LeMans, Buick Skylark, Oldsmobile Cutlass	5080
B		65-66-67-68-69-70-71-72-73-74-75-76-77-78-79-80-81-82-83-84-85-86-87-88-89-90-91-92-93-94-95-96-97-98-99-00-01-02	Door bumpers	2DR 4DR HTP 2DR SDN SWG CNV	65-66 Chevrolet, Pontiac, Oldsmobile, Buick, 65-69 Corvair, 70-02 Chevrolet Camaro, Pontiac Firebird, 68-81 Chevelle, GTO, Cutlass, Skylark, 68-72 El Camino, Tempest, LeMans GTO, 70-72 Monte Carlo	2321
B		66	Hood side bumpers	2DR 4DR HTP 2DR SDN CNV SWG	66 Chevrolet Chevelle, El Camino	5076
B		66-67	License plate bumpers rear	2DR 4DR HTP 2DR SDN CNV SWG	66-67 Chevrolet Chevelle, El Camino	5081
B		66-67	Bumpers bucket seat back oval 4 per car	2DR HTP CNV 2DR SDN	66-67 Chevrolet Chevelle, El Camino, Nova, Pontiac GTO, Tempest, LeMans, Grand Prix	5085
B		77-78-79-80-81-82-83-84-85-86-87-88-89-90	Hoodside bumpers	2DR HTP	77-90 Chevrolet Caprice, Impala 78-88 Chevrolet El Camino, Malibu, Monte Carlo, 2 Door Hardtop	2373
C		59-60	Front glass channel with chrome	2DR SDN SWG	59-60 Impala, 2&4 Door Sedan/Delivery, El Camino, Chevrolet, Pontiac	2081
C		59-60	Glass channel rear	2DR SDN	59-60 Chevrolet El Camino	2083
C		78-79-80-81-82-83-84-85-86-87	Window weatherstrip outers only, replacement style	2DR HTP	78-87 Chevrolet El Camino	51370
D		59-60	Door weatherstrip with clips	2DR SDN	59-60 Chevrolet El Camino	2200
D		64-65	Door weatherstrip with clips	2DR SDN	64-65 Chevrolet El Camino	5030
D		66-67	Door weatherstrip with clips	2DR SDN	66-67 Chevrolet El Camino	5031
D		68-69-70-71-72	Door weatherstrip with clips	2DR SDN	68-72 Chevrolet El Camino, 72 Gmc Sprint	5032
D		73-74-75-76-77	Door weatherstrip with clips & molded ends	2DR HTP	Grand Am 2 Door 73-77 Chevrolet, LeMans, Grand LeMans, Century, Regal, Cutlass, Chevelle Malibu Laguna, El Camino, 2 Door Hardtop	5017



GUIDE TO SOFFSEAL'S PRODUCT CODES

B = Bumper sets **C** = Glass channels **D** = Door related **G** = Seals, gaskets **H** = Under hood items **I** = Interior parts
M = Miscellaneous items **R** = Roofrail, pillar post & convertible items **T** = Trunk related **W** = Window related **Z** = Weatherstrip kits

Chevrolet • El Camino



CODE	IMAGE	YEAR	DESCRIPTION	BODY	FITS	ITEM#
D		78-79-80-81-82-83-84-85-86-87-88	Door weatherstrip a-body with clips & molded ends	2DR HTP	78-88 Chevrolet Malibu, El Camino, Monte Carlo, Oldsmobile Cutlass, Buick Regal, Pontiac LeMans, Grand Prix 2 Door, Replacement Part For Buick, Oldsmobile And Pontiac, 82-88 Is A G Body	5025
D		78-79-80-81-82-83-84-85-86-87-88	Lower tailgate seal	2DR HTP	78-88 Chevrolet Elcamino	5139
G		59-60	Heater Box Seal Under Hood Deluxe Heater	2 DR 4DR HTP SDN CNV SWG CPE	59-60 Chevy Impala, Bel Air, ElCamino 2 & 4 Dr HTP SDN CNV SWG CPE	2352
G		59-60	Backup housing gaskets	2DR 4DR HTP 2DR SDN CNV SWG	59 Chevrolet Impala, 59 And 60 Bel Air Station Wagon, El Camino	2075
G		59-60	Steering column floor seal with felt washer & metal retainer standard. transmission	SWG	59-60 Chevrolet Biscayne, Bel Air, Impala, El Camino, Station Wagon	2117
G		59-90	Steering column floor seal automatic transmission	SWG	59-60 Chevrolet Biscayne, Bel Air, Impala, El Camino, Station Wagon	2116
G		61-62-63-64-65	Outside mirror gasket	2DR 4DR HTP 2DR SDN CNV SWG	61-65 Chevrolet 68-69 Chevelle Malibu El Camino 63-64 Impala Biscayne Bel Air	2306
G		64	Park light lens gaskets	2DR 4DR HTP 2DR SDN CNV SWG	64 Chevrolet Biscayne Bel Air Impala Chevelle El Camino Malibu	2168
G		64	Taillight lens gasket set of 4	2DR HTP 2DR SDN CNV SWG	64-Chevelle El Camino	5184
G		64	Taillight lens gaskets	2DR SDN	64 Chevrolet El Camino	5204
G		64	Paint gasket set	2DR SDN	64 Chevrolet El Camino	52041
G		64-65	Rear body to bumper seals	2DR HTP 2DR SDN CNV SWG	64-65 Chevrolet Chevelle, El Camino	5083A
G		64-65	Side cowl panel to grill seal	2DR 4DR HTP 2DR SDN CNV SWG	64-65 Chevrolet Chevelle, El Camino	5072
G		64-65-66-67	Steering column sponge seal	2DR SDN CNV 2DR 4DR HTP SWG	64-67 Chevrolet Chevelle, El Camino, Pontiac LeMans, GTO, Oldsmobile Cutlass, Buick Skylark	5162
G		65	Taillight lens gaskets	2DR HTP 2DR SDN CNV SWG	65 Chevelle El Camino	5185
G		65	Paint gasket set	2DR SDN	65 Chevrolet El Camino	51901

CHEVROLET • El Camino

Chevrolet • El Camino

CODE	IMAGE	YEAR	DESCRIPTION	BODY	FITS	ITEM#
G		65	Taillight lens gaskets	2DR SDN	65 Chevrolet El Camino	51902
G		65-66-67-68-69	Antenna gasket	2DR 4DR SDN HTP CNV	68 Chevrolet 67-69 Chevrolet Camaro, Pontiac Firebird, 68-69 Chevrolet Chevelle, El Camino, 66-69 Chevrolet Nova	2409
G		65-66-67-68-69-70-71-72-73-74-75-76-77-78-79	Mirror gasket	2DR 4DR HTP 2DR SDN CNV SWG	68-69 Chevrolet 65-66 Bel Air Biscayne Impala 67-79 Chevrolet Camaro 66-72 Nova 66-72 Chevelle 70 El Camino 67-68 Pontiac Firebird	2305
G		66	Taillight lens gaskets	2DR SDN	66 Chevrolet El Camino	5206
G		66	Inner taillight, housing to body seals	2DR HTP 2DR SDN CNV SWG	66 Chevelle El Camino	5186
G		66	Taillight lens gaskets	2DR HTP 2DR SDN CNV SWG	66 Chevelle El Camino	51861
G		66	Paint gasket set	2DR SDN	66 Chevrolet El Camino	53661
G		66	Taillight, bezel seals	2DR HTP 2DR SDN CNV SWG	66 Chevrolet Chevelle, El Camino	5189
G		66-67	Quarter panel extension to body seals	2DR HTP 2DR SDN 4DR SDN	66-67 Chevelle El Camino	5187
G		66-67	Rear body to bumper seals	2DR 4DR HTP 2DR SDN CNV SWG	66-67 Chevrolet Chevelle, El Camino	5083
G		67	Taillight lens gaskets	2DR SDN	67 Chevrolet El Camino	5207
G		67	Taillight lens gasket	2DR HTP 2DR SDN CNV SWG	67 Chevelle El Camino	5192
G		67	Paint gasket set	2DR HTP 2DR SDN CNV SWG	67 Chevrolet Chevelle Hardtop Convertible Sedan Station Wagon	5367
G		67	Paint gasket set	2DR SDN	67 Chevrolet El Camino	53671
G		68	Paint gasket set	2DR HTP 2DR SDN CNV	68 Chevelle El Camino	51961
G		68	Paint gasket set	2DR SDN	68 Chevrolet El Camino	52081
G		68-69	Taillight lens gaskets	2DR SDN	68-69 Chevrolet El Camino	5208



GUIDE TO SOFFSEAL'S PRODUCT CODES















B = Bumper sets **C** = Glass channels **D** = Door related **G** = Seals, gaskets **H** = Under hood items **I** = Interior parts
M = Miscellaneous items **R** = Roofrail, pillar post & convertible items **T** = Trunk related **W** = Window related **Z** = Weatherstrip kits

Chevrolet • El Camino



CODE	IMAGE	YEAR	DESCRIPTION	BODY	FITS	ITEM#
G		68-69	Taillight, housing to body seals	2DR HTP 2DR SDN CNV SWG	68-69 Chevrolet Chevelle, El Camino	5188
G		68-69	Trunk lock retainer seal	2DR 4DR HTP 2DR SDN 4DR SDN	68-69 Chevrolet Chevelle, Monte Carlo, El Camino	5086
G		68-69-70-71-72	Rear body seal	2DR SDN	68-72 Chevrolet El Camino, Sprint	5084
G		68-69-70-71-72	Steering column sponge seal	2DR SDN CNV 2DR HTP SWG	68-72 Chevelle El Camino Monte Carlo, Buick Skylark, Oldsmobile Cutlass	5161
G		69	Paint gasket set	2DR SDN	69 Chevrolet El Camino	52082
G		69	Inner taillight, housing to body seal	2DR HTP 2DR SDN CNV SWG	69 Chevelle El Camino	51981
G		69	Park lens gaskets	2DR SDN	69 Chevrolet El Camino	51991
G		69	Taillight, bezel to housing seals	2DR SDN 2DR HTP CNV SWG	69 Chevrolet Chevelle, El Camino	52111
G		70	Paint gasket set	2DR SDN	70 Chevrolet El Camino	52091
G		70	Park lens gaskets	2DR HTP 2DR SDN	70 Chevrolet Monte Carlo, El Camino	5238
G		70	Park light lens gaskets	2DR HTP 2DR SDN CNV SWG	70 Chevrolet Chevelle, El Camino, Monte Carlo	5200
G		70	Paint gasket set	2DR HTP 2DR SDN CNV	70 Chevrolet Chevelle, El Camino	52001
G		70	Taillight lens gaskets	2DR HTP 2DR SDN CNV SWG	70 Chevrolet Chevelle, El Camino	5201
G		70-71-72	Taillight lens gaskets	2DR SDN	70-72 Chevrolet El Camino	5209
G		70-71-72	Rear bumper reflector gasket, backup lens gasket	2DR SDN 2DR HTP CNV SWG	70-72 Chevrolet El Camino, Monte Carlo, SWG	5241
G		71-72	Paint gasket set	2DR SDN	71-72 Chevrolet El Camino	5372
G		71-72	Park lens gaskets	2DR SDN SWG	71-72 Chevrolet El Camino	5202
G		71-72	Park lens gaskets passenger	2DR HTP 2DR SDN CNV	71-72 Chevrolet Chevelle, El Camino, Monte Carlo	5203

Chevrolet • El Camino

CODE	IMAGE	YEAR	DESCRIPTION	BODY	FITS	ITEM#
G		73-74-75-76-77	Rear side marker light	2DR HTP	73-77 Chevrolet El Camino	5213
G		78-79-80-81-82-83-84-85-86-87	Rear side marker gasket	SWG	78-87 Chevrolet El Camino, Gmc Caballero, 78-83 Chevrolet Malibu Wagon, 82-83 Pontiac Bonneville Wagon, 78-81 Pontiac LeMans Wagon, Oldsmobile Cutlass Wagon, 82-86 Oldsmobile Cutlass 4 Door Except Fwd, 78-82 Buick Century Wagon, Station Wagon	5214
H		60	A-arm seals without clips	2DR 4DR HTP 2DR SDN CNV SWG	60 Chevrolet Biscayne, Biscane Fleetmaster, Bel Air, Impala, Brookwood, Parkwood, Kingswood, Nomad, El Camino	2100
H		64-65	A-arm seal with staples	2DR 4DR HTP 2DR SDN CNV SWG	64-65 Chevrolet Chevelle, El Camino	5065
H		64-65-66-67	Hood to cowl seal	2DR 4DR HTP 2DR SDN CNV SWG	64-67 Chevrolet Chevelle, El Camino, Pontiac GTO, LeMans	5070
H		66	A-arm seal with staples	2DR 4DR HTP 2DR SDN CNV SWG	66 Chevrolet Chevelle, El Camino	5066
H		67	A-arm seal with staples	2DR 4DR HTP 2DR SDN CNV SWG	67 Chevrolet Chevelle, El Camino	5067
H		68-69	Hood to cowl seal clip kit steel	2DR 4DR HTP 2DR SDN CNV SWG	68-69 Chevelle, El Camino, Monte Carlo, GTO, LeMans, Buick Skylark, Oldsmobile Cutlass	5075
H		68-69-70-71-72	Anti squeak strips	2DR 4DR HTP SDN CNV SWG CPE TRK	68-72 Chevrolet Chevelle, El Camino, 2 Door 4 Door Hardtop Sedan Convertible Station Wagon Coupe Truck	5064
H		68-69-70-71-72	Hood to cowl seal clip kit plastic	2DR 4DR HTP 2DR SDN CNV SWG	68-72 Chevrolet Chevelle, El Camino, Monte Carlo, Pontiac GTO LeMans, Buick Skylark, Oldsmobile Cutlass	5077
H		68-69-70-71-72	Rear hood seal	2DR 4DR HTP 2DR SDN CNV SWG	68-72 Chevrolet Chevelle, El Camino, Monte Carlo	5070A
H		68-69-70-71-72	Hood to cowl seal dense	2DR 4DR HTP 2DR SDN CNV SWG	68-72 Chevrolet Chevelle, El Camino, Monte Carlo, Pontiac GTO, LeMans, Buick Skylark, Oldsmobile Cutlass	5074
H		68-69-70-71-72	Hood to cowl seal sponge	2DR 4DR HTP 2DR SDN CNV SWG	68-72 Chevrolet Chevelle, El Camino, Monte Carlo, Pontiac GTO, LeMans, Buick Skylark, Oldsmobile Cutlass	50741
H		68-69-70-71-72	A-arm seal steel inner fenders with staples	2DR 4DR HTP 2DR SDN CNV SWG	68-72 Chevrolet Chevelle, El Camino	5068



GUIDE TO SOFFSEAL'S PRODUCT CODES

B = Bumper sets **C** = Glass channels **D** = Door related **G** = Seals, gaskets **H** = Under hood items **I** = Interior parts
M = Miscellaneous items **R** = Roofrail, pillar post & convertible items **T** = Trunk related **W** = Window related **Z** = Weatherstrip kits

Chevrolet • El Camino



CODE	IMAGE	YEAR	DESCRIPTION	BODY	FITS	ITEM#
H		68-69-70-71-72	Firewall clutch boot	2DR HTP 2DR SDN CNV	68-72 Chevrolet Chevelle, El Camino, Monte Carlo, Pontiac LeMans, Tempest, GTO, Buick Skylark, Oldsmobile Cutlass	5053
H		69-70-71-72	A-arm seal plastic inner fenders with staples	2DR 4DR HTP 2DR SDN CNV SWG	69-72 Chevrolet Chevelle, El Camino	5069
H		70-71-72	Hood insulation	2DR HTP 2DR SDN CNV SWG	70-72 Chevrolet Chevelle, El Camino	5176
I		62-63-64-65-66-67-68-69-70-71	Accelerator pedal hp with deluxe trim	2DR 4DR HTP 2DR SDN CNV SWG	62-71 Chevrolet Biscayne Bel Air Impala, 64-67 Chevelle, 70-71 Camaro Hi Perfor, 64-67 Buick Special-Skylark El Camino, 64-65 Pontiac A Body	2069
I		64-65	Shift boot 4-speed with console	2DR HTP 2DR SDN CNV	64-65 Chevelle El Camino	50611
I		64-65-66	Shift boot 4-speed with o console	2DR HTP 2DR SDN CNV	64-66 Chevelle El Camino	5061
I		64-65-66-67-68-69-70	Sun visor tip	2DR 4DR SDN HTP CNV	64-70 All Makes And Models	4006
I		64-65-66-67-68-69-70-71-72-73-74	Park brake pedal pad	2DR HTP CNV	El Camino Cutlass Chevelle Chevy II Camaro Firebird LeMans Tempest GTO Grand Prix Full Size Centurion Century Electra Invicta LeSabre Regal Riviera Skylark Wildcat Monte Carlo	3094
I		66-67	Shift boot 4-speed with console	2DR HTP 2DR SDN CNV	66-67 Chevrolet Chevelle, El Camino	5060
I		66-67-68-69-70-71-72	Auto disc pad	2DR 4DR HTP 2DR SDN CNV SWG	66-72 Chevrolet Chevelle, El Camino, Monte Carlo	5058A
I		68-69-70-71-72	Rubber console sealing strip 4 pre cut	2DR 4DR HTP 2DR SDN CNV SWG	68-72 Chevrolet Chevelle, El Camino, 70-72 Monte Carlo	5059
I		68-69-70-71-72	Automatic brake pad	2DR 4DR HTP 2DR SDN CNV SWG	68-72 Chevrolet Chevelle, El Camino, Monte Carlo, Buick Skylark, Oldsmobile Cutlass, 71-72 Pontiac LeMans, Tempest, GTO	5058
I		68-69-70-71-72	Shift boot 4-speed with o console	2DR HTP 2DR SDN CNV	68-72 Chevrolet Chevelle, El Camino, Monte Carlo	5062
I		68-69-70-71-72	Shift boot 4 speed with console	2DR 4DR SDN HTP CNV	68-72 Chevelle, El Camino, Monte Carlo	5063
M		64-65-66-67	Firewall clutch boot	2DR HTP SDN CNV	64-67 Chevrolet Chevelle, El Camino, Pontiac GTO, 2 Door Hardtop Sedan Convertible	50521
M		64-65-66-67	Firewall pad with clips	2DR SDN 4DR HTP CNV SWG	64-67 Chevrolet Chevelle, El Camino, Buick Skylark, Oldsmobile Cutlass, Pontiac GTO, LeMans	5163

CHEVROLET • El Camino

Chevrolet • El Camino

CODE	IMAGE	YEAR	DESCRIPTION	BODY	FITS	ITEM#
M		64-65-66-67	Body mounts with steel sleeves	2DR HTP 2DR SDN SWG	64-67 Chevrolet Chevelle, Also 67 SS 396, El Camino	5164
M		64-65-66-67	Body mounts with steel sleeves	2DR HTP SDN	64-67 Chevrolet Chevelle, El Camino, Hardtop, Sedan Except 67 SS Hardtop	51641
M		64-65-66-67	Body mounts with steel sleeves	2DR HTP	64-67 Chevrolet Chevelle, El Camino, Pontiac LeMans, GTO, 2 Door Hardtop Sedan	51642
M		64-65-66-67	Body mount bolt kit	2DR SDN CNV 2DR HTP SWG	64-67 Chevrolet Chevelle, El Camino	51643
M		64-65-66-67	Body mount bolt kit	2DR SDN SWG	64-67 Chevelle, El Camino, Also 67 396 SS, 2 Door Sedan Station Wagon	51644
M		64-65-66-67	Filler Neck Hose	All	64-67 El Camino	5027
M		67	Bumper guard inserts front rear	2DR 4DR HTP 2DR SDN CNV SWG	67 Chevrolet Chevelle, El Camino	5082
M		68-69-70-71-72	Body mounts with steel sleeves	2DR HTP 2DR SDN SWG	68-72 Chevrolet Chevelle, El Camino, Sedan Station Wagon Hardtop	5165
M		68-69-70-71-72	Core support bushing bolt kit	2DR 4DR HTP 2DR SDN CNV SWG	68-72 Chevelle El Camino Skylark Special Gran Sport Sports Wagon 442 Cutlass F85 Vista Cruizer Wagon Tempest LeMans GTO T37 Monte Carlo Impala	5167
M		68-69-70-71-72	Firewall insulation pad with clips non a/c	2DR SDN CNV 4DR HTP SWG	68-72 Chevrolet Chevelle, El Camino, Buick Skylark, Oldsmobile Cutlass, Pontiac GTO, LeMans	51631
M		68-69-70-71-72	Firewall insulation pad with clips with a/c	2DR SDN CNV 2DR 4DR HTP SWG	68-72 Chevrolet Chevelle, El Camino, Buick Skylark, Oldsmobile Cutlass, Pontiac GTO, LeMans, All Models	51632
M		69	Door jamb louvers	2DR 4DR HTP 2DR SDN CNV SWG	69 Chevelle, El Camino, Monte Carlo, Pontiac LeMans, GTO, Tempest	5043
R		73-74-75-76-77	Roofrail weatherstrip with molded ends	2DR HTP	73-77 Chevrolet El Camino, Gmc Sprint	5034
R		78-79-80-81-82-83-84-85-86-87	Roofrail weatherstrip	2DR HTP	78-87 Chevrolet El Camino, Baballero, Diable, 2 Door Hardtop	5049
W		59	Vent window weatherstrip	2DR 4DR SDN SWG	59 Chevrolet, Buick, Oldsmobile, Pontiac, El Camino, 2 Door 4 Door Sedan Station Wagon	2280
W		59-60	Window weatherstrip 4 piece kit original style with round bead	2DR SDN	59-60 Chevrolet El Camino	10491
W		60	Vent window weatherstrip	2DR SDN SWG 4DR	60 Chevrolet, Buick, Oldsmobile, Pontiac, El Camino, 2 Door, 4 Door Sedan, Station Wagon	2281



GUIDE TO SOFFSEAL'S PRODUCT CODES

B = Bumper sets **C** = Glass channels **D** = Door related **G** = Seals, gaskets **H** = Under hood items **I** = Interior parts
M = Miscellaneous items **R** = Roofrail, pillar post & convertible items **T** = Trunk related **W** = Window related **Z** = Weatherstrip kits







Chevrolet • El Camino



CODE	IMAGE	YEAR	DESCRIPTION	BODY	FITS	ITEM#
W		64	Window weatherstrip replacement style	2DR	64 Chevrolet El Camino	5127
W		64	Window weatherstrip, original style with round bead 4 piece	2DR SDN SWG	64 Chevrolet El Camino	5127A
W		64-65-66-67	Vent window seals	2DR 4DR SDN	64-67 Chevelle, El Camino, 66-67 Oldsmobile Cutlass, Buick Skylark, 64-65 Pontiac GTO, LeMans 2 Door 4 Door Sedan	51021
W		65	Window weatherstrip replacement style	2DR SDN	65 Chevrolet El Camino	5129
W		65	Window weatherstrip, original style with round bead, doors only 4 piece	2DR SDN	65 Chevrolet El Camino	5129A
W		66-67	Window weatherstrip replacement style	2DR SDN	66-67 Chevrolet El Camino	5130
W		66-67	Window weatherstrip, original style with round bead 4 piece	2DR SDN	66-67 Chevrolet Chevelle, El Camino 2 Door Sedan	5130A
W		68-69-70-71-72	Window weatherstrip replacement style	2DR SDN	68-72 Chevrolet El Camino	5131
W		68-69-70-71-72	Window weatherstrip, original style with round bead	2DR SDN	68-72 Chevrolet El Camino	51310
W		68-69-70-71-72	Window weatherstrip, original style with round bead outers only	2DR SDN	68-72 Chevrolet El Camino	5133
W		68-69-70-71-72	Vent window weatherstrip	2DR 4DR SDN	68 Chevrolet Chevelle, Pontiac Le Mans, GTO, Oldsmobile Cutlass, 442, Buick Skylark, 68-72 Chevrolet El Camino, Sedan	51031
W		68-69-70-71-72-73-74	Door glass run channel fits in door frame upper & rear	2DR SDN	68-72 Chevrolet El Camino, 68-74 Chevrolet Nova, 2 Door Sedan	5126
W		78-79-80-81-82-83-84-85-86-87	Window weatherstrip replacement style	2DR HTP	78-87 Chevrolet El Camino, 78-83 Chevrolet Malibu	5137
W		78-79-80-81-82-83-84-85-86-87	Window felts inners only, replacement style	2DR 4DR SDN HTP CNV	78-87 Chevrolet El Camino	5138
Z		64	Weatherstrip kit, includes a arm seals, bumper kit, door weatherstrips, hood to cowl seal, paint gaskets, window weatherstrips	2DR HTP	64 Chevrolet El Camino	KIT528
Z		65	Weatherstrip kit, includes a arm seals, bumper kit, door weatherstrips, hood to cowl seal, paint gaskets, window weatherstrips	2DR HTP	65 Chevrolet El Camino	KIT529

CHEVROLET • El Camino

Chevrolet • El Camino

CODE	IMAGE	YEAR	DESCRIPTION	BODY	FITS	ITEM#
Z		66	Weatherstrip kit, includes a arm seals, bumper kit, door weatherstrips, hood to cowl seal, paint gaskets, window weatherstrips	2DR HTP	66 Chevrolet El Camino	KIT530
Z		67	Weatherstrip kit, includes a arm seals, bumper kit, door weatherstrips, hood to cowl seal, paint gaskets, window weatherstrips	2DR HTP	67 Chevrolet El Camino	KIT531
Z		68	Weatherstrip kit, includes a arm seals, bumper kit, door weatherstrips, hood to cowl seal, paint gaskets, window weatherstrips, hood to cowl clips, rear body seal	2DR HTP	68 Chevrolet El Camino	KIT532
Z		69	Weatherstrip kit, includes a arm seals, bumper kit, door weatherstrips, hood to cowl seal, paint gaskets, window weatherstrips, hood to cowl clips, rear body seal	2DR HTP	69 Chevrolet El Camino	KIT533
Z		70	Weatherstrip kit, includes a arm seals, bumper kit, door weatherstrips, hood to cowl seal, paint gaskets, window weatherstrips, hood to cowl clips, rear body seal	2DR HTP	70 Chevrolet El Camino	KIT534
Z		71-72	Weatherstrip kit, includes a arm seals, bumper kit, door weatherstrips, hood to cowl seal, paint gaskets, window weatherstrips, hood to cowl clips, rear body seal	2DR HTP	71-72 Chevrolet El Camino	KIT535



GUIDE TO SOFFSEAL'S PRODUCT CODES

B = Bumper sets **C** = Glass channels **D** = Door related **G** = Seals, gaskets **H** = Under hood items **I** = Interior parts
M = Miscellaneous items **R** = Roofrail, pillar post & convertible items **T** = Trunk related **W** = Window related **Z** = Weatherstrip kits



CODE	IMAGE	YEAR	DESCRIPTION	BODY	FITS	ITEM#
B		51-52-53-54-55-56-57-58	Upper vent window bumpers	2DR 4DR HTP 2DR SDN CNV SWG	51-58 Chevrolet 150 210 Bel Air Nomad Del Ray Biscayne Impala, 51-54 Chevrolet, Pontiac, Oldsmobile, Buick, Cadillac, Hardtop Convertible	1224
B		58-59	Gas door bumper	2DR 4DR HTP 2DR SDN CNV SWG	58-59 Chevrolet Del Ray, Biscayne, Bel Air, Impala	2074
B		59	Hood panel grille bumpers	2DR 4DR HTP SDN CNV SWG	59 Chevrolet Biscayne, Bel Air, Impala	20721
B		59-60	Vent window bumpers upper	2DR HTP	59-60 Chevrolet Bel Air, Impala Pontiac Catalina, Star chief Oldsmobile Dynamic 88, Super 88, 98, Cadillac Deville, Eldorado, Series 62, Buick Lesabre, Invicta, Electra Full Size 2 Door Hardtop	2202
B		59-60-61	Hood side bumpers	2DR 4DR HTP 2DR SDN CNV SWG	59-61 Chevrolet Biscayne, Bel Air, Impala	2072
B		61-62	Upper vent window bumper	2DR HTP	61-62 Chevrolet Bel Air, Impala, Pontiac Catalina, Bonneville, Ventura, Cadillac, Buick, Oldsmobile, 2 Door 4 Door Hardtop	2087
B		61-62	Upper vent window bumper	CNV	61-62 Chevrolet Impala, Bel Air, Pontiac Catalina, Bonneville, Oldsmobile 88, 98, Buick LeSabre, Electra 225, Cadillac Deville Convertible	2088
B		62	Hood side bumper	2DR 4DR HTP 2DR SDN CNV SWG	62 Chevrolet Biscayne, Impala, Bel Air	21812
B		62	Bumper kit	2DR HTP CNV 2DR SDN	62 Chevrolet Biscayne, Bel Air, Impala, 2 Door Hardtop Convertible Sedan	2316
B		62-63-64	Seat back bumpers	2DR HTP CNV	62-64 Chevrolet Impala, Nova, Chevelle, El Camino, For SS	2172
B		62-63-64	Gas door bumpers	2DR 4DR HTP 2DR SDN CNV SWG	62-64 Chevrolet Biscayne, Bel Air, Impala, Cadillac, Oldsmobile, Buick, Pontiac	2143
B		63-64	Hood side bumpers	2DR 4DR HTP 2DR SDN CNV SWG	63-64 Chevrolet Biscayne, Impala, Bel Air, 64 Chevelle	2181
B		63-64	Bumper kit	2DR HTP CNV 2DR SDN	63-64 Chevrolet Biscayne, Bel Air, Impala	2317
B		63-64	Upper vent window bumpers	CNV	63-64 Impala, Bonneville, Catalina, Oldsmobile 88, 98, LeSabre, Electra 225, Deville, Convertible	2203
B		63-64	Vent window bumpers, upper	2DR 4DR HTP	63-64 Chevrolet Impala, 63-64 Cadillac, Deville, 63-64 Oldsmobile 88, 98, 63-64 Buick LeSabre, Electra, 63-64 Pontiac Bonneville, Catalina, 2 Door 4 Door Hardtop	2204

Chevrolet • Impala

CODE	IMAGE	YEAR	DESCRIPTION	BODY	FITS	ITEM#
B		65	Bumper kit, includes: door hood trunk glove box	2DR HTP 2DR SDN	65 Chevrolet Biscayne, Bel Air, Impala, 2 Door Hardtop Sedan	2370
B		65	Hood side bumpers	2DR 4DR HTP 2DR SDN CNV SWG	65 Chevrolet Biscayne, Impala, Bel Air, Caprice, Chevelle, Malibu, 65 Cadillac, 65 Oldsmobile, 65 Buick, 65 Pontiac	2182
B		66-67-68-69-70-71-72	Hood side bumpers	2DR 4DR SDN HTP CNV	66-72 Chevrolet Biscayne, Bel Air, Impala, Caprice, 73-75 Nova, 66-72 Cadillac, 66-72 Oldsmobile, 66-72 Buick, 66-72 Pontiac	2179
B		66-67-68-69-70-71-72	Bumper kit, includes: door hood trunk glove box	2DR 4DR HTP 2DR SDN CNV SWG	66 Chevrolet Biscayne, Bel Air, Impala, Caprice, 68-69 Chevelle, 70-71 Chevelle, Monte Carlo, 72 Chevelle, 66-72 Cadillac, 66-72 Oldsmobile, 66-72 Buick, 66-72 Pontiac	2371
B		67-68-69-70	Door bumpers	2DR 4DR HTP 2DR SDN CNV SWG	67-70 Chevrolet Biscayne, Bel Air, Impala Caprice, 67-70 Cadillac Calais, Deville, Fleetwood, 67-70 Oldsmobile 88, 98, 67-70 Buick LeSabre, Wildcat, Electra, 67-70 Pontiac	2323
B		67-68-69-70	Bumper kit, includes: door hood trunk glove box	2DR HTP 2DR SDN	67-70 Chevrolet Biscayne, Bel Air, Impala, Caprice, 2 Door Hardtop Sedan	2372
B		68-69-70-71-72	Rear hood bumpers	2DR 4DR HTP 2DR SDN CNV SWG	68-72 Chevrolet Chevelle 68-70 Chevrolet Impala	5078
B		77-78-79-80-81-82-83-84-85-86-87-88-89-90	Hoodside bumpers	2DR HTP	77-90 Chevrolet Caprice, Impala 78-88 Chevrolet El Camino, Malibu, Monte Carlo, 2 Door Hardtop	2373
C		58	Glass channel front	2DR HTP CNV	58 Chevrolet Impala, 58 Cadillac, 58 Oldsmobile, 58 Buick, 58 Pontiac, 2 Door Hardtop	2040
C		58	Glass channel rear	2DR HTP	58 Chevrolet Impala Sport Coupe, Pontiac Bonneville Sport Coupe 2 Door Coupe	2041
C		59-60	Glass channel	2DR 4DR HTP CNV	59-60 Chevrolet Bel Air, Impala, Cadillac Series 62, Deville, Eldorado, Oldsmobile 88 Oldsmobile 98, Buick LeSabre, Invicta, Electra, Pontiac Catalina, Star Chief, Bonneville 2 Door 4 Door Hardtop Convertible	2080
C		59-60	Front glass channel with chrome	2DR SDN SWG	59-60 Impala, 2&4 Door Sedan/Delivery, El Camino, Chevrolet, Pontiac	2081
C		61-62	Glass channel front	CNV HT	62 Chevrolet, Pontiac, Oldsmobile, Buick, Cadillac Formal Roof Hardtop, 61-62 Convertible, 61 Pontiac, Oldsmobile, Buick, Cadillac Formal Roof Hardtop	2162
C		61-62	Front glass channel	2DR SDN SWG 4DR	61-62 Chevrolet, Pontiac, 2 Door 4 Door Sedan And Station Wagon	21621



GUIDE TO SOFFSEAL'S PRODUCT CODES

B = Bumper sets **C** = Glass channels **D** = Door related **G** = Seals, gaskets **H** = Under hood items **I** = Interior parts
M = Miscellaneous items **R** = Roofrail, pillar post & convertible items **T** = Trunk related **W** = Window related **Z** = Weatherstrip kits



CODE	IMAGE	YEAR	DESCRIPTION	BODY	FITS	ITEM#
C		61-62	Glass channel front	2DR HTP	61 Chevrolet Impala, 62 Chevrolet Bel Air, 61 Cadillac Series 62, 62 Cadillac Deville 4 Door S, 61-62 Oldsmobile 88 Oldsmobile 98, 61 Buick LeSabre, Invicta, Electra, 62 Buick, 61-62 Pontiac Catalina, Ventura, Star Chief, Bonneville 2 Door Hardtop	2161
C		62-63-64	Glass channel rear except 1963-64 gran prix	2DR HTP	62 Buick LeSabre, Invicta, 63-64 Buick LeSabre, Wildcat, 62-64 Chevrolet Impala, 62-63 Oldsmobile S88, 62-64 Oldsmobile D88, 64 Oldsmobile J88, 62-64 Pontiac Catalina 2 Door Hardtop	2184
C		62-63-64	Glass channel rear	2DR 4DR SDN	62-63 Chevrolet Biscayne, Bel Air, Impala, 62-64 Cadillac, 62-64 Oldsmobile 88, 62-64 Buick LeSabre, 64 Wildcat, 62-64 Pontiac Catalina, Star Chief 2 Door 4 Door Sedan	2189
C		63-64	Glass channel rear	4DR HTP	63-64 Chevrolet Impala Sport Coupe, Oldsmobile 88 Holiday Sedan, Buick LeSabre, Wildcat, Pontiac Bonneville, Catalina, Star Chief 4 Door Hardtop	2188
C		63-64	Glass channel front	4DR HTP	63-64 Chevrolet Impala, 63-64 Cadillac, 63-64 Oldsmobile 88 Oldsmobile 98, 63-64 Buick, 63-64 Pontiac, 4 Door Hardtop	21841
C		63-64	Glass channel rear side stationary window	4DR SWG	61-64 Chevrolet, Buick, Oldsmobile, Pontiac 4 Door Station Wagon, All	2123
C		63-64	Windshield gasket	2DR SDN SWG	63-64 Chevrolet Biscayne, Bel Air, Impala, 63-64 Cadillac Series 62, Deville, 63-64 Oldsmobile 88 Oldsmobile 98, 63-64 Buick LeSabre, Wildcat, Electra, 63-64 Pontiac, 2 Door Sedan Station Wagon	2020
C		63-64	Glass channel front	2DR HTP CNV	63-64 Chevrolet Impala, 63-64 Cadillac, 63-64 Oldsmobile 88, Oldsmobile 98 Starfire Convertible Only, 63-64 Buick LeSabre, Wildcat, Electra, 63-64 Pontiac, 2 Door Hardtop Convertible	2021
D		58	Door j weatherstrip	2DR 4DR HTP 2DR SDN CNV SWG	58 Chevrolet Del Ray, Biscayne, Bel Air, Impala, 58 Cadillac, 57-58 Oldsmobile 88 Oldsmobile 98, 57-58 Buick Special Century, Super, Roadmaster, 58 Pontiac	2044
D		58	Door weatherstrip with clips & molded ends	2DR HTP CNV	58 Chevrolet Impala, Cadillac, Oldsmobile 88 Convertible Only, Buick Century Convertible Only, Pontiac, 2 Door Hardtop Convertible	2010
D		59-60	Door weatherstrip with clips & molded ends	2DR HTP CNV	59-60 Chevrolet Impala, Bel Air, Pontiac Catalina, Star Chief, Bonneville, Oldsmobile 88, 98, Buick LeSabre, Invicta, Electra, Cadillac Deville, Eldorado, Series 62 Hardtop Convertible	2011
D		59-60	Door j weatherstrip	2DR 4DR HTP SWG 2DR SDN 4DR SDN	59-60 Chevrolet, Pontiac, Oldsmobile, Buick, Cadillac	2093

Chevrolet • Impala

CODE	IMAGE	YEAR	DESCRIPTION	BODY	FITS	ITEM#
D		59-60	Door weatherstrip front with clips & molded ends	4DR HTP	59-60 Chevrolet Impala, Bel Air, Buick Lesabre, Invicta, Oldsmobile 88, Pontiac Catalina, Star Chief, Bonneville 4 Door Hardtop	2205
D		59-60	Door weatherstrip rear door with clips & molded ends	4DR HTP	59-60 Chevrolet Impala, Bel Air, Buick Electra, Invicta, LeSabre, Cadillac 62 Deville, Eldorado, Oldsmobile 98 Oldsmobile 99, 4 Door Hardtop	2206
D		61-62	Door weatherstrip, front doors	4DR HTP	61-62 Chevrolet Impala, Bel Air, Buick Electra, LeSabre, Invicta, Cadillac Series 60, Oldsmobile 88 Oldsmobile 98, 4 Door Hardtop	2207
D		61-62	Door weatherstrip with clips & molded ends	2DR HTP CNV	61-62 Chevrolet Bel Air Impala, Cad Series 62, Deville, 61-62 Oldsmobile, 61 Hardtop Convertible 88 Star Fire, Oldsmobile 98/62 Oldsmobile 88 Oldsmobile 98 Starfire, 61-62 Buick 61 Hardtop Convertible, 62 Convertible Only LeSabre Invicta Electra, 61-62 Pontiac, 2 Door Hardtop Convertible	2013
D		61-62	Door weatherstrip front with clips	SWG 4 DR SDN	61-62 Chevrolet Bel Air, Biscayne, Impala, Pontiac, Station Wagon & 4 Dr Sedan	2019
D		61-62-63-64	Door weatherstrip rear with clips	4dr SWG	61-64 Chevrolet Biscayne, Bel Air, Impala, 61-64 Oldsmobile 88, 61-64 Buick LeSabre, 62-63 Invicta 63-64 Wildcat, 61-64 Pontiac Catalina, Bonneville, 4 Door Station Wagon	2018
D		61-62-63-64	Door weatherstrip rear door with clips	4DR SDN	61-64 Chevrolet Biscayne Bel Air Impala, 61-64 Oldsmobile 88, 98, 61-62 Cadillac, 61-64 Buick LeSabre Electra, 64 Wildcat, 61-64 Pontiac Catalina, Star Chief, 4 Door Sedan	2009
D		61-62-63-64	Door weatherstrip with clips	2DR SDN	61-64 Chevrolet, Pontiac, Buick, Oldsmobile, 2 Door Sedan	2005
D		61-62-63-64	Door weatherstrip, rear doors with clips & molded ends	4DR HTP	61-64 Chevrolet Impala, Buick LeSabre, Oldsmobile Wildcat, 88, Pontiac Catalina Star Chief Bonneville 4 Door Hardtop	2122
D		63-64	Front door weatherstrip with molded ends	4DR HTP	63-64 Chevrolet Biscayne, Bel Air, Impala, Buick Wildcat, Lesabre, Electra, Pontiac Catalina, Star Chief, Bonneville, Oldsmobile Dynamic 88, 98 4 Door Ht	2121
D		63-64	Door weatherstrip with clips & molded ends	2DR HTP CNV	63-64 Chevrolet Impala, 63-64 Cadillac Eldorado, Deville, 63-64 Oldsmobile 88 Oldsmobile 98 Starfire 63-64 Buick LeSabre Wildcat, Electra 63 Invicta, 63-64 Pontiac Catalina, Bonneville, Grand Prix, 2 Door Hardtop Convertible	2014
D		63-64	Door weatherstrip front with clips	4DR SDN SWG	63-64 Chevrolet Biscayne, Bel Air, Impala, 63-64 Cadillac, 63-64 Oldsmobile 88, 63-64 Buick LeSabre, Wildcat, 63-64 Pontiac, 4 Door Sedan Station Wagon	2017



GUIDE TO SOFFSEAL'S PRODUCT CODES					
B = Bumper sets	C = Glass channels	D = Door related	G = Seals, gaskets	H = Under hood items	I = Interior parts
M = Miscellaneous items	R = Roofrail, pillar post & convertible items	T = Trunk related	W = Window related	Z = Weatherstrip kits	



CODE	IMAGE	YEAR	DESCRIPTION	BODY	FITS	ITEM#
D		65-66	Door weatherstrip front with clips	4DR SDN SWG	65-66 Chevrolet Biscayne Bel Air Impala, 65-66 Cadillac Calais Deville Fleetwood, 65-66 Oldsmobile 88, 65-66 Buick LeSabre Wildcat, 65-66 Pontiac Bonneville, Catalina, Star chief, 4 Door Sedan Swg	2006
D		65-66	Rear door weatherstrip with clips	4DR SDN	65-66 Chevrolet Biscayne Bel Air Impala 65-66 Cadillac Calais Deville Fleetwood 65-66 Oldsmobile 88, 65-66 Buick LeSabre Wildcat, 65-66 Pontiac Catalina, Star Chief, 4 Door Sedan	2007
D		65-66	Door weatherstrip rear station wagon with clips	4DR SWG	65-66 Chevrolet Biscayne, Bel Air, Impala, 65-66 Oldsmobile, 65-66 Buick, 65-66 Pontiac	2008
D		65-66	Door weatherstrip rear doors with clips & molded ends	4DR HTP	65-66 Chevrolet Impala, Pontiac Catalina, Bonneville, 4 Door Hardtop	2211
D		65-66	Door weatherstrip with clips & molded ends	2DR HTP CNV	65-66 Chevrolet Impala, Caprice, 65-66 Cadillac Calais, Deville, 65-66 Oldsmobile 88, Starfire, Oldsmobile 98, 65 Jet Star, 65-66 Buick LeSabre, Wildcat Electra, 65-66 Pontiac 2 Door Hardtop Convertible	2331
D		65-66-67-68	Door weatherstrip front door with clips & molded ends	4DR HTP	65-68 Chevrolet Impala, Buick, Wildcat, LeSabre, Cadillac Calais, Deville, Oldsmobile 98 Oldsmobile 99, Pontiac, 4 Door Hardtop	2210
D		67-68	Door weatherstrip rear doors with clips & molded ends	4DR HTP	67-68 Chevrolet Impala, Pontiac Catalina, Bonneville, 4 Door Hardtop	2212
D		67-68	Front door weatherstrip with clips	4DR SDN SWG	67-68 Chevrolet Biscayne, Bel Air, Impala, 67-68 Cadillac Calais, Deville, Fleetwood, 67-68 Oldsmobile Delmont 88, Delta 88, 98, 67-68 Buick LeSabre, Wildcat, Electra 67-68 Pontiac Catalina, Executive, Bonneville, 4 Door Sedan Station Wagon	23321
D		67-68	Door weatherstrip rear with clips	4DR SDN	67-68 Chevrolet Biscayne, Bel Air, Impala, 67-68 Cadillac Calais, Deville, Fleetwood, 67-68 Oldsmobile 88, 67-68 Buick LeSabre, Wildcat, 67-68 Pontiac Bonneville Station Wagon, 67-68 Pontiac Executive, Catalina, 4 Door Sedan	23322
D		67-68	Door weatherstrip with clips & molded ends	CNV 2DR HTP	67-68 Chevrolet Impala, Caprice, Except 68 Caprice 2 Door Hardtop, 67-68 Cadillac Calais, Deville, 67-68 Oldsmobile 88 Oldsmobile 98, 67-68 Buick Electra, Wildcat, 67 Pontiac Catalina, Bonneville, Executive, 67 Grand Prix Convertible 2 Door Hardtop	2342
D		69-70	Door weatherstrip with clips & molded ends	2DR HTP CNV	69-70 Chevrolet Impala, Caprice, 69-70 Cadillac Calais, Deville, 69-70 Oldsmobile 88 Oldsmobile 98, 69-70 Buick LeSabre, Wildcat, Electra, 69-70 Pontiac Catalina, Bonneville, Executive, 2 Door Hardtop Convertible	2357

Chevrolet • Impala

CODE	IMAGE	YEAR	DESCRIPTION	BODY	FITS	ITEM#
D		69-70	Rear door weatherstrip	SWG 4DR	69-70 Chevy Biscayne, Bel Air, Impala, Caprice, Estate, Oldsmobile Vista Cruiser, Pontiac Catalina, Bonneville, Executive, Gm Fullsize Station Wagon 4 Door	2519
D		69-70	Door weatherstrip front doors with clips	4DR SDN SWG	69-70 Chevrolet Biscayne, Bel Air, Impala, Cadillac, Buick La Sabre, Wildcat, Pontiac, 4 Door Sedan Station Wagon	2510
D		71-72-73-74	Door weatherstrip rear door with clips & molded ends	4DR HTP	71-74 Chevrolet Caprice, Impala, Buick LeSabre, Centurion, Oldsmobile 88, Pontiac, 4 Door Hardtop	2214
D		71-72-73-74	Door weatherstrip rear with clips & molded ends	4DR SDN	71-74 Chevrolet Impala, Bel Air, Biscayne, Brookwood, Townsman, Kingswood, Buick Estate Station Wagon, Pontiac Catalina, Grand Safari, Bonneville, Oldsmobile Custom Cruiser, 4 Door Sedan	2225
D		71-72-73-74-75-76	Door weatherstrip rear with clips & molded ends	SWG 4DR	71-76 Chevrolet Bel Air, Caprice, Impala, Brookwood, Townsman, Kingswood, Oldsmobile Custom Cruiser, Pontiac Grand Safari, Buick Estate Wagon, 4 Door Station Wagon	2227
D		71-72-73-74-75-76	Door weatherstrip front with clips & molded ends	4DR SWG	71-76 Chevrolet Impala, Bel Air, Biscayne, Brookwood, Townsman, Kingswood, Buick Estate Station Wagon, Pontiac Catalina, Grand Safari, Bonneville, Oldsmobile Custom Cruiser, 4 Door Station Wagon	2228
D		71-72-73-74-75-76	Door weatherstrip front doors with clips & molded ends	4DR HTP	71-76 Chevrolet Caprice, Impala, Buick, Electra, LeSabre, Centurion, Cadillac Calais, Deville, Oldsmobile 88 Oldsmobile 98, Catalina, Bonneville, Granville, 4 Door Hardtop	2213
D		71-72-73-74-75-76	Door weatherstrip with clips & molded ends	2DR HTP CNV	71-76 Chevrolet Impala, Caprice, Cadillac Calais, Deville, Buick 71-73 LeSabre, Centurion, Electra, 74-76 LeSabre, Electra, Oldsmobile 88 Oldsmobile 98, Pontiac Bonneville, Catalina, 71-75 Grandville 2 Door Hardtop Convertible	2512
D		75-76	Rear Door weatherstrip with clips & molded ends	4DR HTP	75-76 Chevrolet Impala, Caprice, Buick, LeSabre, Centurion, Oldsmobile 88, Pontiac, 4 Door Hardtop	2216
D		75-76	Door weatherstrip rear with clips & molded ends	4DR SDN	75-76 Chevrolet Impala, Bel Air, Brookwood, Townsman, Kingwood, Buick Estate Station Wagon, Pontiac Catalina, Grand Safari, Bonneville, Oldsmobile Custom Cruiser, 4 Door Sedan	2226
D		77-78-79-80-81-82-83-84-85-86	Front door weatherstrip with clips	4DR SDN RWD	77-86 Impala Caprice, 77-84 Cadillac Deville Fleetwood, 85-86 Fleetwood, 77-84 Oldsmobile 88 89, 85 88, 77-84 Buick LeSabre Electra 85 LeSabre, 77-79 Buick Estate Wagon, 82-83 Buick Park Ave 77-81 Pontiac Bonneville, 83-86 Pontiac Parisienne, 77-80 Pontiac Catalina 4 Door Sedan, RWD Only	2500



GUIDE TO SOFFSEAL'S PRODUCT CODES

B = Bumper sets **C** = Glass channels **D** = Door related **G** = Seals, gaskets **H** = Under hood items **I** = Interior parts
M = Miscellaneous items **R** = Roofrail, pillar post & convertible items **T** = Trunk related **W** = Window related **Z** = Weatherstrip kits



CODE	IMAGE	YEAR	DESCRIPTION	BODY	FITS	ITEM#
D		77-78-79-80-81-82-83-84-85-86-87	Door weatherstrip with clips	2DR SDN RWD	84-87 Chevrolet Caprice, 77-81 Chevrolet Impala, 83 Chevrolet, 77-84 Cadillac Deville, 80-84 Fleetwood, 77-84 Oldsmobile 88 Oldsmobile 98, 85 Oldsmobile 88, 77-84 Buick LeSabre, Electra, 85 LeSabre, 77-81 Pontiac Bonneville, Catalina 2 Door Sedan, RWD Only	2359
D		77-78-79-80-81-82-83-84-85-86-87-88-89-90	Rear door weatherstrip with clips	4DR SDN RWD	77-86 Chevrolet Impala Caprice, 87-88 Caprice Caprice Classic, 89 Caprice, 90 Caprice Caprice Classic, 77-84 Cadillac Deville, 77-85 Oldsmobile 88, 77-78 Town Sedan, Custom Crusier, 77-84 Buick LeSabre Electra 85 LeSabre, 77-81 Pontiac Bonneville, Catalina, 83-86 Pontiac Parisienne 4 Door Sedan, RWD Only	2502
D		77-78-79-80-81-82-83-84-85-86-87-88-89-90	Rear door weatherstrip with clips	4 DR SWG, RWD	77-86 Chevrolet Impala Caprice, 87-88 Caprice Caprice Classic, Cadillac, 77-85 Oldsmobile Custom Cruiser, 77-88 Estate Station Wagon, 77-81 Catalina Safari Bonneville Safari, 82 Bonneville Safari, 83 Bonneville Parisienne, 84-89 Parisienne Station Wagon, RWD Only	2503
G		57-58-59-60	Inner to outer fender seals	2DR 4DR HTP 2DR SDN CNV SWG	57-60 Chevrolet	1103
G		58	Lens gasket kit	2DR 4DR HTP 2DR SDN CNV SWG	58 Chevrolet Del Ray Biscayne Impala Bel Air	2045
G		58	Antenna base gasket	2DR 4DR HTP 2DR SDN CNV SWG	58 Chevrolet Del Ray Biscayne Impala Bel Air	2046
G		58	Anti-squeak fender seals	2DR 4DR HTP 2DR SDN CNV SWG	58 Chevrolet Del Ray Biscayne Impala Bel Air	2057
G		58	Front splash pan seals	2DR 4DR HTP 2DR SDN SWG CNV	58 Chevrolet Del Ray Biscayne Impala Bel Air	2058
G		58	Heater plenum to firewall gasket	2DR 4DR HTP 2DR SDN CNV SWG	58 Chevrolet Del Ray Biscayne Impala Bel Air	2037
G		58	Heater box seal kit non a/c 2 piece	2DR 4DR HTP 2DR SDN CNV SWG	58 Chevrolet Del Ray Biscayne Impala Bel Air	20371
G		58	A-arm seals w/o clips	2DR 4DR HTP 2DR SDN CNV SWG	58 Chevrolet Del Ray Biscayne Impala Bel Air	2042

Chevrolet • Impala

CODE	IMAGE	YEAR	DESCRIPTION	BODY	FITS	ITEM#
G		59	Antenna gasket left or right, rear	2DR SDN 2DR 4DR HTP CNV SWG	59 Chevrolet Biscayne Bel Air Impala	2071
G		59	Door handle & lock gaskets	2DR 4DR HTP 2DR SDN CNV SWG	59 Chevrolet Pontiac	2073
G		59	Lens gasket kit 4 piece parklight, taillight	2DR 4DR HTP 2DR SDN CNV SWG	59 Chevrolet Biscayne Bel Air Impala	2176
G		59	Tail lamp assembly to body seal	2DR 4DR HTP 2DR SDN CNV SWG	59 Chevrolet Biscayne Bel Air Impala	21761
G		59-60	Steering column floor seal with felt washer & metal retainer standard. transmission	SWG	59-60 Chevrolet Biscayne, Bel Air, Impala, El Camino, Station Wagon	2117
G		59-60	Backup housing gaskets	2DR 4DR HTP 2DR SDN CNV SWG	59 Chevrolet Impala, 59 And 60 Bel Air Station Wagon, El Camino	2075
G		59-60	Heater Box Seal Under Hood Deluxe Heater	2 DR 4DR HTP SDN CNV SWG CPE	59-60 Chevy Impala, Bel Air, ElCamino 2 & 4 Dr HTP SDN CNV SWG CPE	2352
G		59-90	Steering column floor seal automatic transmission	SWG	59-60 Chevrolet Biscayne, Bel Air, Impala, El Camino, Station Wagon	2116
G		60	Lens gasket kit 8 piece parklight, taillight, brake & backup	2DR 4DR HTP 2DR SDN CNV SWG	60 Chevrolet Biscayne Bel Air Impala	2177
G		60	Taillight, housing to body seals	2DR 4DR HTP 2DR SDN CNV SWG	60 Chevrolet Impala Biscayne Bel Air	21772
G		60	Antenna gasket right, rear	2DR 4DR HTP 2DR SDN CNV SWG	60 Chevrolet Biscayne Bel Air Impala	2084
G		60	Antenna gasket left rear	2DR 4DR HTP 2DR SDN CNV SWG	60 Chevrolet Biscayne Bel Air Impala	2085
G		60-63-64-69-70	Door handle & lock gaskets	2DR 4DR HTP 2DR SDN CNV SWG	60 Chevrolet Biscayne, Impala, Bel Air, Cadillac, Oldsmobile 89 Oldsmobile 98, Buick LeSabre, Invicta, Electra, Wild Cat, Pontiac Catalina, Star Chief, Bonneville, Grand Prix, Ventura	2098
G		61	Lens gasket kit 8 piece parklight, taillight, brake & backup	2DR 4DR HTP 2DR SDN CNV SWG	61 Chevrolet Biscayne Bel Air Impala	2178

















GUIDE TO SOFFSEAL'S PRODUCT CODES

B = Bumper sets **C** = Glass channels **D** = Door related **G** = Seals, gaskets **H** = Under hood items **I** = Interior parts
M = Miscellaneous items **R** = Roofrail, pillar post & convertible items **T** = Trunk related **W** = Window related **Z** = Weatherstrip kits



CODE	IMAGE	YEAR	DESCRIPTION	BODY	FITS	ITEM#
G		61	Taillamp housing to body seal	2DR 4DR HTP 2DR SDN CNV SWG	61 Chevrolet Impala Biscayne Bel Air	21781
G		61	Inner taillamp housing seals	2DR 4DR HTP 2DR SDN CNV SWG	61 Impala Bel Air Impala Biscayne	21782
G		61	Steering column dust cover	2DR 4DR HTP 2DR SDN CNV SWG	61 Chevrolet Biscayne Bel Air Impala	2115
G		61-62	Heater box kit non a/c 7 piece	2DR 4DR HTP 2DR SDN CNV SWG	61-62 Chevrolet Impala Biscayne Bel Air	2112
G		61-62	Antenna gasket left rear	2DR SDN 2DR 4DR HTP CNV SWG	61-62 Chevrolet Biscayne, Bel Air, Impala	2125
G		61-62	Cowl panel to cowl filler gasket	2DR 4DR HTP 2DR SDN CNV SWG	61-62 Chevrolet Biscayne Bel Air Impala	2061
G		61-62-63	Tunnel extension seal	2DR HTP CNV	61-63 Chevrolet Impala 4-Speed Impala SS Automatic	2311
G		61-62-63-64	Steering column outer seal standard shift only	2DR 4DR HTP 2DR SDN CNV SWG	61-64 Chevrolet Biscayne Bel Air Impala	2113
G		61-62-64	Steering column outer seal automatic	2DR 4DR HTP 2DR SDN CNV SWG	61-64 Chevrolet Biscayne Bel Air Impala	2114
G		61-62-65-66-67-68	Door handle & lock gaskets	2DR 4DR HTP 2DR SDN CNV SWG	61-62 Chevrolet Biscayne, Bel Air, Impala, Cadillac, Oldsmobile 88 Oldsmobile 98, Buick LeSabre, Invicta, Electra, Pontiac	2145
G		61-62-63-64	License plate light lens gasket	2DR 4DR HTP 2DR SDN CNV SWG	61-64 Chevrolet Bel Air Biscayne Impala	2307
G		61-62-63-64-65	Outside mirror gasket	2DR 4DR HTP 2DR SDN CNV SWG	61-65 Chevrolet 68-69 Chevelle Malibu El Camino 63-64 Impala Biscayne Bel Air	2306
G		62	Inner taillamp housing seals	2DR 4DR HTP 2DR SDN CNV SWG	62 Chevrolet Impala Bel Air Impala	21783
G		62	Outer rear bumper seals	2DR 4DR HTP 2DR SDN CNV SWG	62 Chevrolet Biscayne Bel Air Impala	2160

Chevrolet • Impala

CODE	IMAGE	YEAR	DESCRIPTION	BODY	FITS	ITEM#
G		62	Park lens gaskets	2DR 4DR HTP 2DR SDN CNV SWG	62 Chevrolet Biscayne Bel Air Impala	2165
G		62	Taillight gasket	2DR 4DR HTP 2DR SDN CNV SWG	62 Chevrolet Full Size Only	2166
G		62	Lens gasket kit 8 piece parklight, taillight, brake & backup	2DR 4DR HTP 2DR SDN CNV SWG	62 Chevrolet Biscayne Bel Air Impala	2173
G		62-63	Tail lamp to body seals	2DR 4DR HTP 2DR SDN CNV SWG	62-63 Chevrolet Biscayne Bel Air Impala	2170
G		62-63-64	Steering column dust cover	2DR 4DR HTP 2DR SDN CNV SWG	62-64 Chevrolet Biscayne Bel Air Impala	21151
G		63	Lens gasket kit 8 piece parklight, taillight, brake & backup	2DR 4DR HTP 2DR SDN CNV SWG	63 Chevrolet Biscayne Bel Air Impala	2174
G		63	Park lens gaskets	2DR 4DR HTP 2DR SDN CNV SWG	63 Chevrolet Biscayne Bel Air Impala	2167
G		63	Tail lens gaskets	2DR 4DR HTP 2DR SDN CNV SWG	63 Chevrolet Biscayne Bel Air Impala	21671
G		63	Inner taillamp housing seals	2DR 4DR HTP 2DR SDN CNV SWG	63 Impala Bel Air Biscayne	21784
G		63	Rear body to bumper seal	2DR 4DR HTP 2DR SDN CNV SWG	63 Chevrolet Biscayne Bel Air Impala	2201
G		63-64-65	Heater to firewall gasket under dash non a/c	2DR 4DR SDN HTP CNV	63-65 Chevrolet Impala Bel Air Biscayne	2513
G		64	Rear bumper to body seal	2DR 4DR HTP 2DR SDN CNV SWG	64 Chevrolet Biscayne Bel Air Impala	2197
G		64	Park light lens gaskets	2DR 4DR HTP 2DR SDN CNV SWG	64 Chevrolet Biscayne Bel Air Impala Chevelle El Camino Malibu	2168
G		64	Park lamp housing gaskets	2DR 4DR HTP 2DR SDN CNV SWG	64 Chevrolet Biscayne Bel Air Impala	2169



















GUIDE TO SOFFSEAL'S PRODUCT CODES					
B = Bumper sets	C = Glass channels	D = Door related	G = Seals, gaskets	H = Under hood items	I = Interior parts
M = Miscellaneous items	R = Roofrail, pillar post & convertible items	T = Trunk related	W = Window related	Z = Weatherstrip kits	



CODE	IMAGE	YEAR	DESCRIPTION	BODY	FITS	ITEM#
G		64	Lens gasket kit 8 piece parklight, taillight, brake & backup	2DR 4DR HTP 2DR SDN CNV SWG	64 Chevrolet Biscayne Bel Air Impala	2175
G		64	Tail lens gaskets	2DR 4DR HTP 2DR SDN CNV SWG	64 Chevrolet Biscayne Bel Air Impala	2171
G		64	Taillight, housing to body seal	2DR 4DR HTP 2DR SDN CNV SWG	64 Chevrolet Biscayne Bel Air Impala	21711
G		65	Taillight lens gasket	2DR HTP CNV SWG	65 Chevrolet Impala	2380
G		65	Taillight, housing gaskets	2DR HTP CNV SWG	65 Chevrolet Impala	2381
G		65-66	Steering column seal fits all	2DR 4DR HTP 2DR SDN CNV SWG	65-66 Chevrolet Impala Biscayne Caprice Bel Air	2405
G		65-66	Outside mirror gasket without remote	2DR 4DR HTP 2DR SDN CNV SWG	65-66 Chevrolet Bel Air Biscayne Impala	2304
G		65-66-67	Cowl vent panel to cowl seals	2DR 4DR SDN HTP CNV	65-67 Chevrolet All	2340
G		65-66-67-68-69-70-71-72-73-74-75-76-77-78-79	Mirror gasket	2DR 4DR HTP 2DR SDN CNV SWG	68-69 Chevrolet 65-66 Bel Air Biscayne Impala 67-79 Chevrolet Camaro 66-72 Nova 66-72 Chevelle 70 El Camino 67-68 Pontiac Firebird	2305
G		66	Taillight lens gaskets	2DR 4DR HTP SWG CNV	66 Chevrolet Impala	2385
G		66	Park lens gaskets	2DR 4DR HTP SWG CNV	66 Chevrolet All	2388
G		66-67-68-69-70-71-72	License light gasket	2DR 4DR HTP SDN CNV SWG	66-72 Chevy II Nova, Biscayne, Bel Air, Impala, Chevelle, 67-72 Chevrolet Camaro, Pontiac Firebird	2378
G		67	Quarter panel extension seal	2DR HTP	67 Chevrolet Impala Fastback	23641
G		67	Rear bumper to body seal	2DR SDN 2DR 4DR HTP CNV SWG	67 Chevrolet Biscayne Bel Air Impala Caprice	2346
G		67	Park light lens gaskets	2DR SDN 2DR 4DR HTP CNV SWG	67 Chevrolet Impala Bel Air Caprice Biscayne	2382
G		67	Taillight lens gaskets	2DR 4DR HTP SWG CNV	67 Chevrolet Impala	2386

Chevrolet • Impala

CODE	IMAGE	YEAR	DESCRIPTION	BODY	FITS	ITEM#
G		67-68	Steering column seal fits all	2DR 4DR HTP 2DR SDN CNV SWG	67-68 Chevrolet Impala Biscayne Caprice Bel Air	2406
G		67-68-69-70	Rear body to bumper seal	ALL BODY STYLES	69-70 Chevrolet Impala	2415
G		68	Rear body to bumper seal	2DR 4DR HTP 2DR SDN CNV SWG	68 Chevrolet Impala Biscayne Caprice Bel Air	2408
G		68	Front cornering light, gaskets	2DR 4DR HTP CNV SWG	68 Chevrolet Impala	2410
G		68	Taillight lens gaskets 6 piece	2DR SDN 2DR 4DR HTP CNV SWG	68 Chevrolet Impala Caprice Bel Air	2383
G		68	Park lens gaskets	2DR SDN 2DR 4DR HTP CNV SWG	68 Chevrolet Impala Biscayne Bel Air	2384
G		68	Rear side marker light	2DR 4DR HTP SWG CNV	68 Chevrolet All	23841
G		68	Front side marker gaskets	2DR 4DR HTP SWG CNV	68 Chevrolet All	23842
G		68	Quarter panel extension seal	2DR 4DR HTP 2DR SDN CNV SWG	68 Chevrolet Impala Caprice	2364
G		69	Front bumper filler	2DR 4DR HTP SWG CNV	69 Chevrolet Impala	2506
G		69-70	Steering column seal	2DR 4DR HTP 2DR SDN CNV SWG	69-70 Chevrolet Impala Biscayne Caprice Bel Air	2402
G		70	Lens gasket set, park light/ taillight lens	2DR 4DR SDN HTP CNV	70 Chevrolet Impala	2411
G		70	Taillight lens gaskets	2DR 4DR HTP CNV	70 Chevrolet Impala	2389
G		70	Park light lens gaskets	2DR 4DR HTP SWG CNV	70 Chevrolet	23891
H		58	Hood insulation	2DR 4DR HTP 2DR SDN CNV SWG	58 Chevrolet Del Ray Biscayne Bel Air Impala	21451
H		58-59-60	Hood to cowl seal	2DR 4DR HTP 2DR SDN CNV SWG	58-60 Chevrolet Del Ray Biscayne Impala Bel Air	2060















GUIDE TO SOFFSEAL'S PRODUCT CODES

B = Bumper sets **C** = Glass channels **D** = Door related **G** = Seals, gaskets **H** = Under hood items **I** = Interior parts
M = Miscellaneous items **R** = Roofrail, pillar post & convertible items **T** = Trunk related **W** = Window related **Z** = Weatherstrip kits



CODE	IMAGE	YEAR	DESCRIPTION	BODY	FITS	ITEM#
H		59	A-arm seals without clips	2DR 4DR HTP 2DR SDN CNV SWG	59 Chevrolet Biscayne Bel Air Impala	2101
H		59-60	Hood insulation	2DR 4DR HTP 2DR SDN CNV SWG	59-60 Chevrolet Biscayne Bel Air Impala	21452
H		60	A-arm seals without clips	2DR 4DR HTP 2DR SDN CNV SWG	60 Chevrolet Biscayne, Biscane Fleetmaster, Bel Air, Impala, Brookwood, Parkwood, Kingswood, Nomad, El Camino	2100
H		61	Hood insulation	2DR 4DR HTP 2DR SDN CNV SWG	61 Chevrolet Biscayne Bel Air Impala	2146
H		61	A-arm seals with staples	2DR 4DR HTP 2DR SDN CNV SWG	61 Chevrolet Biscayne Bel Air Impala	2111
H		61-62	Hood to cowl seal	2DR 4DR HTP 2DR SDN CNV SWG	61-62 Chevrolet Biscayne Bel Air Impala	2130
H		62	Hood insulation	2DR 4DR HTP 2DR SDN SWG CNV	62 Chevrolet Biscayne Bel Air Impala	2147
H		62-63-64	A-arm seals with staples	2DR 4DR HTP 2DR SDN CNV SWG	62-64 Chevrolet Biscayne Bel Air Impala	2183
H		63	Hood insulation	2DR 4DR HTP 2DR SDN SWG CNV	63 Chevrolet Biscayne Bel Air Impala	2148
H		63-64	Hood to cowl seal	2DR 4DR HTP 2DR SDN CNV SWG	63-64 Chevrolet Impala Biscayne Bel Air	2192
H		64	Hood insulation	2DR 4DR HTP 2DR SDN SWG CNV	64 Chevrolet Biscayne Bel Air Impala	2149
H		64-65-66-67-68-69-70-71-72	Firewall wiring gutter plk	2DR 4DR HTP 2DR SDN SWG CNV	Chevy Chevelle, Biscayne, Bel Air, Impala, Caprice, Nova, Camaro, Cadillac Calais, Deville, Fleetwood, Oldsmobile 88, 98, Jetstar, Starfire, Pontiac Catalina, Bonneville, Firebird, Buick Lesabre, Wildcat, Electra	2328
H		65	A-arm seals with staples	2DR SDN 2DR 4DR HTP CNV SWG	65 Chevrolet Biscayne Bel Air Impala	2324
H		65-66	Hood insulation with clips	2DR 4DR HTP CNV SWG	65-66 Chevrolet Impala	2390

Chevrolet • Impala

CODE	IMAGE	YEAR	DESCRIPTION	BODY	FITS	ITEM#
H		65-66-67	Hood to cowl seal	2DR SDN 2DR 4DR HTP CNV SWG	65-67 Chevrolet Biscayne Bel Air Impala	2330
H		66	A-arm seals with staples	2DR 4DR HTP CNV	66 Chevrolet Biscayne Bel Air Impala	2325
H		67	Hood insulation with clips	2DR 4DR HTP 2DR SDN CNV SWG	67 Chevrolet Biscayne Bel Air Impala Caprice	2391
H		67-68	A-arm seals with staples	2DR 4DR HTP CNV	67-68 Chevrolet Biscayne Bel Air Impala	2326
H		69-70	A-arm seals with staples	2DR 4DR HTP CNV	69-70 Chevrolet Biscayne Bel Air Impala	2327
H		69-70	Hood insulation with clips	2DR 4DR HTP 2DR SDN CNV SWG	69-70 Chevrolet Impala Biscayne Caprice Bel Air	2403
H		71-72-73-74-75-76- 77-78	Hood to cowl seal	2DR SDN 2DR HTP CNV SWG	71-78 Chevrolet Impala, Caprice, Biscayne, Bel Air, Brookwood, Townsmen, Kingswood, Buick Lesabre, Centurion, Electra 225, Estate Wagon, Cadillac Calais, Deville, Eldorado, Sixty Special Brougham, Oldsmobile 88, 98, Tornado, Pontiac Catalina, Bonneville, Grandville, Safari Full Size	2191
I		55-56-57-61-62- 63-64	Glove box arm grommet	2DR 4DR HTP 2DR SDN CNV SWG	55-57 And 61-64 Chevrolet, Pontiac, Oldsmobile All	10691
I		58	Gear shift grommet column	2DR 4DR SDN HTP CNV	58 Chevrolet Del Ray, Biscayne, Bel Air, Impala, Cadillac, Oldsmobile 88 Oldsmobile 98, Buick Special, Century, Roadmaster, Riviera, Pontiac	2185
I		58-59-60-61-62- 63-64	Emergency brake pedal pad with inverted letter	2DR 4DR HTP 2DR SDN CNV SWG	58-64 Chevrolet Del Ray Biscayne Bel Air Impala	2067
I		58-59-60-61-62- 63-64-65-66-67	Accelerator pedal	2DR 4DR HTP 2DR SDN CNV SWG	58-67 Chevrolet Del Ray Biscayne Bel Air Impala Caprice, 62-67 Chevy II	2068
I		59-60-61-62-63- 64-65-66	Gear shift grommet column	2DR 4DR SDN HTP CNV	59-66 Chevrolet Biscayne, Bel Air, Impala, 59-66 Cadillac, 59-63 Oldsmo- bile 88 Oldsmobile 98, 61 Starfire, 64-66 Starfire, Jet Star, 59-66 Buick LeSabre, Invicta, Electra, 63 Wildcat, Riviera, 59-66 Pontiac	2185A
I		60-61-62-63	Shift boot 4-speed bench seat	2DR 4DR HTP 2DR SDN CNV SWG	60-63 Chevrolet Biscayne Bel Air Impala	2105
I		61-62	Instrument panel dash seal rubber	2DR 4DR HTP 2DR SDN CNV SWG	61-62 Chevrolet Biscayne Bel Air Impala	2076



GUIDE TO SOFFSEAL'S PRODUCT CODES

B = Bumper sets **C** = Glass channels **D** = Door related **G** = Seals, gaskets **H** = Under hood items **I** = Interior parts
M = Miscellaneous items **R** = Roofrail, pillar post & convertible items **T** = Trunk related **W** = Window related **Z** = Weatherstrip kits



CODE	IMAGE	YEAR	DESCRIPTION	BODY	FITS	ITEM#
I		62	Shift boot 4-speed ss, with console	2DR 4DR HTP 2DR SDN CNV SWG	62 Chevrolet Biscayne Bel Air Impala	2104
I		62-63-64-65-66-67-68-69-70-71	Accelerator pedal hp with deluxe trim	2DR 4DR HTP 2DR SDN CNV SWG	62-71 Chevrolet Biscayne Bel Air Impala, 64-67 Chevelle, 70-71 Camaro Hi Perfor, 64-67 Buick Special-Skylark El Camino, 64-65 Pontiac A Body	2069
I		63-64	Automatic slider seals with console	2DR 4DR HTP 2DR SDN CNV SWG	63 Chevrolet Impala, 63-64 Chevrolet Nova	2120
I		63-64	Dash mounted tach housing seal	2DR 4DR HTP 2DR SDN CNV SWG	63-64 Chevrolet Biscayne Bel Air Impala	2199
I		64	Shift boot 4-speed with console, upper	2DR 4DR HTP 2DR SDN CNV SWG	64 Chevrolet Biscayne Bel Air Impala	2107
I		64	Shift boot ss lower	2DR 4DR HTP 2DR SDN CNV SWG	64 Chevrolet Biscayne Bel Air Impala	2109
I		64-65-66-67	Automatic console slider	2DR 4DR HTP 2DR SDN CNV SWG	64-67 Chevy II, Nova, Chevelle, Biscayne, Bel Air, Impala, 67 Chevrolet Camaro	2108
I		65-66-67-68-69-70	Accelerator pedal pad trim fit part 2069	2DR 4DR HTP SDN SWG CNV	65-70 Chevrolet Biscayne, Bel Air, Impala, Caprice, 2 Door 4 Door Hardtop Sedan Station Wagon Convertible	2069A
I		65-66-67-68-69-70	Parking brake pedal pad	2DR SDN 2DR 4DR HTP CNV SWG	65-70 Chevrolet Biscayne, Bel Air, Impala, Caprice	20671
I		65-66-67-68-69-70	Automatic brake pedal pad	2DR SDN 2DR 4DR HTP CNV SWG	65-70 Chevrolet Impala	2064
I		65-66-67-68-69-70	Deluxe clutch & brake pad	2DR 4DR HTP 2DR SDN CNV SWG	65-70 Chevrolet Biscayne, Bel Air, Impala	20641
I		65-66-67-68-69-70	Deluxe manual brake & clutch pedal pad trim fits part 20641	2DR SDN 2DR 4DR HTP CNV SWG	65-70 Chevrolet Bel Air Biscayne Impala	20641A
I		65-66-67-68-69-70	Automatic brake pedal pad with disc brakes	2DR SDN 2DR 4DR HTP CNV SWG	65-70 Chevrolet Biscayne, Bel Air, Impala, Caprice	20642
I		65-66-67-70	Deluxe automatic brake pad trim fits part 2064	2DR SDN 2DR 4DR HTP CNV SWG	65-70 Chevrolet Biscayne, Bel Air, Impala	2064A

Chevrolet • Impala

















CODE	IMAGE	YEAR	DESCRIPTION	BODY	FITS	ITEM#
I		66-67	Upper shift boot with console	2DR SDN 2DR 4DR HTP CNV SWG	66-67 Chevrolet Full Size Impala	2518
M		55-56-57-59-60-61	Gear tube grommet	2DR 4DR HTP SDN CNV SWG	55-57 And 59-60 Chevrolet Pontiac, Oldsmobile, 60-61 Chevrolet Truck, Gmc Truck, 2 Door 4 Door Hardtop Sedan Convertible Station Wagon	1095
M		57-58-59-60-61- 62-63-64-65-66- 67-68-69-70-71-72- 73-74-75-76-77-78- 79-80-81	Bellhousing to clutch fork rubber boot	2DR 4DR HTP SDN CNV SWG	57-81 GM All Manual Transmission	2196
M		58-59-60	Body mounts	CNV	58-60 Chevrolet Impala, Convertible	2062
M		58-59-60-61-62- 63-64-65	Automatic power brake pad	2DR 4DR HTP SDN CNV SWG	58-65 Chevrolet Del Ray Biscayne Bel Air, 62-67 Chevy II Nova Caprice, 63- 67 Corvette, 2 Door 4 Door Hardtop Sedan Convertible Station Wagon	2063
M		58-59-60-61-62- 63-64-65	Power brake pedal pad with standard trans	2DR 4DR HTP SDN CNV SWG	58-65 Full-Size Chevrolet Biscayne Bel Air Impala Caprice, 58-62 Corvette, 58 Del Ray, 2 Door 4 Door Hardtop Sedan Convertible Station Wagon	20651
M		58-59-60-61-62- 63-64-65-66-67	Standard brake & clutch pedal pads	2DR 4DR HTP 2DR SDN CNV SWG	58-67 Chevrolet Del Ray Biscayne Bel Air Impala, 62-67 Chevy II, Nova Caprice 58-62 Corvette	2065
M		58-59-60-61-62- 63-64-65-66-67- 68-69	Automatic brake pad with out power brakes	2DR 4DR HTP SDN CNV SWG	58-69 Chevrolet Biscayne Bel Air Im- pala, 63-67 Corvette 62-67 Chevy II, 65-69 Corvair, 2 Door 4 Door Hardtop Sedan Convertible Station Wagon	2066
M		59	Body mounts	2DR 4DR HTP 2DR SDN SWG	59 Chevrolet Biscayne Bel Air Impala, Except Convertible	2070
M		60-61-62-63-64	Frame to body mount kit	2DR 4DR HTP SDN CNV SWG	60-64 Chevrolet Biscayne Bel Air Impala, 2 Door 4 Door Hardtop Sedan Convertible Station Wagon	2110
M		61-62	Windshield post drain gutters	2DR 4DR HTP SDN CNV SWG	61-62 Chevrolet Biscayne Bel Air Impala, 2 Door 4 Door Hardtop Sedan Convertible Station Wagon	21614
M		61-62	Bellhousing fork boot	2DR 4DR HTP SDN CNV SWG	61-62 Chevrolet Biscayne, Bel Air, Impala, 61-62 Cadillac, 61-62 Oldsmo- bile, 61-62 Buick, 61-62 Buick, 2 Door 4 Door Hardtop Sedan Convertible Station Wagon	2198
M		61-62-63-64	Frame to body mount kit	CNV	61-64 Chevrolet Impala, Convertible	21101
M		61-62-63-64	Frame to body mount bolt kit	CNV	61-64 Chevrolet Impala, Convertible	21103
M		61-62-63-64	Frame to body mount bolt kit	2DR 4DR HTP 2DR SDN	61-64 Chevrolet Biscayne Bel Air Impala, 2 Door 4 Door Hardtop Sedan	2110A















GUIDE TO SOFFSEAL'S PRODUCT CODES

B = Bumper sets **C** = Glass channels **D** = Door related **G** = Seals, gaskets **H** = Under hood items **I** = Interior parts
M = Miscellaneous items **R** = Roofrail, pillar post & convertible items **T** = Trunk related **W** = Window related **Z** = Weatherstrip kits



CODE	IMAGE	YEAR	DESCRIPTION	BODY	FITS	ITEM#
M		63-64	Firewall pad	2DR 4DR HTP SDN CNV SWG	63-64 Chevrolet Biscayne Bel Air Impala, 2 Door 4 Door Hardtop Sedan Convertible Station Wagon	21724
M		65-66	Body mount kit	2DR HTP 2DR SDN	65-66 Chevrolet Impala Caprice, Biscayne, Bel Air, 2 Door Hardtop, Sedan	2392
M		65-66	Body mount kit	CNV	65-66 Chevrolet Impala, Convertible	2393
M		65-66	Body mount bolt kit	2DR HTP 2DR SDN	65-66 Chevrolet Impala Caprice Bel Air Biscayne, 2 Door Hardtop, Sedan	2398
M		65-66	Body mount bolt kit	CNV	65-66 Chevrolet Impala, Convertible	2399
M		65-66-67	Core support bushing bolt kit	2DR HTP 4DR HTP 2DR SDN CNV SWG	65-67 Chevelle 65 Impala	5166
M		65-67-68	Firewall clutch rod boot	2DR HTP CNV 2DR SDN	65-68 Chevrolet Impala Caprice Corvette	2516
M		66-67-68	Radiator support bushings & hardware kit	2DR 4DR HTP SDN CNV SWG	66-68 Chevrolet Biscayne Impala Caprice Bel Air, 2 Door 4 Door Hardtop Sedan Convertible Station Wagon	2407
M		67-68	Body mount bolt kit	2DR HTP 2DR SDN CNV	67-68 Chevrolet Impala Caprice Bel Air Biscayne, 2 Door Hardtop Sedan Convertible	2400
M		67-68	Body mount kit	2DR HTP 2DR SDN	67-68 Chevrolet Impala Caprice Bel Air Biscayne, 2 Door Hardtop, Sedan	2394
M		67-68	Body mount kit	CNV	67-68 Chevrolet Impala, Convertible	2395
M		68-69-70-71-72	Core support bushing bolt kit	2DR 4DR HTP 2DR SDN CNV SWG	68-72 Chevelle El Camino Skylark Special Gran Sport Sports Wagon 442 Cutlass F85 Vista Cruizer Wagon Tempest LeMans GTO T37 Monte Carlo Impala	5167
M		69-70	Body mount kit	2DR HTP 2DR SDN	69-70 Chevrolet Impala, 2 Door Hardtop Sedan	2396
M		69-70	Body mount kit	CNV	69-70 Chevrolet Impala, Convertible	2397
M		69-70	Body mount bolt kit	2DR HTP SDN CNV	69-70 Chevrolet Impala Caprice Bel Air Biscayne, 2 Door Hardtop Sedan Convertible	2401
R		58	Roofrail weatherstrip with clips	2DR HTP	58 Chevrolet Impala, Cadillac, Oldsmobile, Buick, Pontiac, 2 Door Hardtop	2043
R		58-59-60-61-62-63-64	Header seal	CNV	Chevy Impala, Cadillac Series 62 Eldorado, Pontiac Catalina, Bonneville, Oldsmobile 88, 98, Starfire, Buick Lesabre, Invicta, Electra	2153

Chevrolet • Impala

CODE	IMAGE	YEAR	DESCRIPTION	BODY	FITS	ITEM#
R		59-60	Roofrail weatherstrip with clips	2DR HTP	59-60 Chevrolet, Cadillac, Pontiac, Oldsmobile, Buick, 2 Door Hardtop	2090
R		59-60	Pillar post weatherstrip with clips and molded ends	CNV	59-60 Chevrolet Impala, Cadillac Eldorado Series 62, Pontiac Bonneville, Catalina, Oldsmobile 88 Oldsmobile 98, Buick LeSabre, Invicta, Electra	2091
R		59-60	Weatherstrip kit for convertible top with header seal	CNV	59-60 Chevrolet Impala, Cadillac, Oldsmobile 88, Buick LeSabre, Invicta, Pontiac, Convertible	2092
R		59-60	Roofrail weatherstrip	4DR HTP	59-60 Chevrolet Bel Air, Buick Impala, LeSabre, Invicta, 4 Door Hardtop	2220
R		61	Roofrail weatherstrip with molded ends	2DR HTP	61 Chevrolet, Buick, Oldsmobile, Pontiac 2 Door Hardtop	2129
R		61-62	Weatherstrip Kit For Convertible Top With 6-5/8 Between Center Stud	Cnv	61-62 Chevrolet Impala, 61-62 Olds 88, Starfire, 61 Buick LeSabre, 61-62 Invicta, 61-62 Pontiac, Catalina Bonneville Convertible	2156
R		61-62	Roofrail weatherstrip	4DR HTP	61-62 Chevrolet Bel Air, Impala, Buick, LeSabre, Invicta, Oldsmobile 88, Pontiac, 4 Door Hardtop	2223
R		62	Roofrail weatherstrip with molded ends	2DR HTP	62 Chevrolet Impala, 62 Cadillac, 62 Oldsmobile 88, 62 Buick LeSabre, Invicta, Pontiac 2 Door Hardtop	2164
R		62	Pillar post weatherstrip with molded ends	CNV	61-62 Chevrolet Impala, 61-62 Cadillac 61 Series 6200, Eldorado 62 Eldorado, 61-62 Oldsmobile 88 Oldsmobile 98, Starfire, 61-62 Buick Electra, Invicta, LeSabre, 61-62 Catalina, Bonneville, Convertible	2154
R		62-63-64	Weatherstrip kit for convertible top second type with 5 3/8" between center studs	CNV	62-64 Chevrolet Impala, Oldsmobile 88, Starfire, Buick LeSabre, Invicta, Pontiac, Bonneville, Catalina, 63-64 Buick Wildcat Convertible	2152
R		62-63-64	Weatherstrip kit for convertible top with 5 3/8" between center studs cloth covered	CNV	62-64 Chevrolet Impala, Cadillac, Oldsmobile 88, Starfire, Buick LeSabre, Invicta, Wildcat, Pontiac Catalina, Bonneville	2152C
R		63-64	Pillar post weatherstrip with molded ends	CNV	63-64 Chevrolet Impala, 63-64 Cadillac 63 Series 6200, Eldorado 64 Deville, Eldorado, 63-64 Oldsmobile 88 Oldsmobile 98, Starfire, 63-64 Buick LeSabre, Wildcat, 63-64 Pontiac, Convertible	2193
R		63-64	Roofrail weatherstrip with molded ends	2DR HTP	63-64 Chevrolet Impala, 63-64 Cadillac, 63-64 Oldsmobile 88, 63-64 Buick LeSabre, Wildcat, 63-64 Pontiac 2 Door Hardtop	2194
R		63-64	Roofrail weatherstrip with molded ends	4DR HTP	63-64 Chevrolet Impala, Buick LeSabre, Wildcate, Oldsmobile 88, Pontiac, 4 Door Hardtop	2194A











GUIDE TO SOFFSEAL'S PRODUCT CODES					
B = Bumper sets	C = Glass channels	D = Door related	G = Seals, gaskets	H = Under hood items	I = Interior parts
M = Miscellaneous items	R = Roofrail, pillar post & convertible items		T = Trunk related	W = Window related	Z = Weatherstrip kits



CODE	IMAGE	YEAR	DESCRIPTION	BODY	FITS	ITEM#
R		65	Pillar post weatherstrip with molded ends	CNV	65 Chevrolet Impala, 65 Cadillac Deville, Eldorado, 65 Oldsmobile 88 Oldsmobile 98, 65 Buick LeSabre, Wildcat, Electra, Invicta, 65 Pontiac, Convertible	2334
R		65	Weatherstrip kit for convertible top	CNV	65 Chevrolet Impala, 65 Cadillac, 65 Oldsmobile, 65 Buick LeSabre, Wildcat, 65 Pontiac, Convertible	2365
R		65-66	Roofrail weatherstrip with molded ends	2DR HTP	65-66 Chevrolet Impala, Caprice, 65-66 Cadillac Calais, Deville, 65-66 Oldsmobile 88, Jet Star, Star Fire, Oldsmobile 98, 65-66 Buick LeSabre, Wildcat, Electra, 65-66 Pontiac 2 Door Hardtop	2333
R		65-66	Roofrail weatherstrip with molded ends	4DR HTP	65-66 Chevrolet Impala, Caprice, 65-66 Cadillac, 65-66 Oldsmobile 88, 65-66 Buick LeSabre, 65-66 Pontiac, 4 Door Hardtop	2333A
R		65-66-67-68-69-70	Header seal with clips and molded ends	CNV	65 Chevrolet, 66-70 Chevrolet Impala, 65-70 Cadillac Deville, 65-70 Oldsmobile 88 Oldsmobile 98, 65 Oldsmobile Starfire, 65-70 Buick LeSabre, Wildcat, Electra, 65-70 Pontiac, Convertible	23343
R		66-68	Pillar post weatherstrip with molded ends	CNV	66-68 Chevrolet Impala, 66-68 Cadillac Deville, 66 Cadillac Eldorado, 66-68 Oldsmobile 88 Oldsmobile 98, 66-68 Buick Electra, LeSabre, Wildcat, 66-68 Pontiac, Convertible	23341
R		66-67-68-69-70	Weatherstrip kit for convertible top includes header seal (7 piece kit)	CNV	66-70 Chevrolet Impala, 66-70 Oldsmobile 88, 66-70 Buick LeSabre, Wildcat, 66-70 Pontiac Bonneville, Catalina, 67 Pontiac Grand Prix, Convertible	2366
R		67-68	Roofrail weatherstrip with thick c pillar section	4DR HTP	67-68 Chevrolet Impala, Caprice, Buick LeSabre, Wildcat, Pontiac Bonneville, Catalina, Executive 4 Door Hardtop	2351
R		67-68	Roofrail weatherstrip with molded ends	2DR HTP	67-68 Chevrolet Impala, Caprice, 67-68 Cadillac, 67-68 Oldsmobile 88, 67-68 Buick Electra, Wildcat, 67-68 Pontiac Catalina, Executive 2 Door Hardtop	2345
R		69-70	Roofrail weatherstrip with molded ends	2DR HTP	69-70 Chevrolet Caprice, Impala, 69-70 Cadillac, 69-70 Oldsmobile 88, 69-70 Buick LeSabre, Wildcat, 69-70 Pontiac 2 Door Hardtop	2356
R		69-70	Roofrail weatherstrip	4DR HTP	69-70 Chevrolet Impala, Caprice, 69-70 Oldsmobile 88 Oldsmobile 98, 69-70 Buick LeSabre, Wildcat, Electra, 69-70 Pontiac Catalina, Bonneville, Executive 4 Door Hardtop	23561
R		69-70	Pillar post weatherstrip with molded ends	CNV	69-70 Chevrolet Impala, Caprice, 69-70 Cadillac Deville, 69-70 Oldsmobile 88 Oldsmobile 98, 69-70 Buick LeSabre, Wildcat, Electra, 69-70 Pontiac, Convertible	2358
R		71-72-73	Roofrail weatherstrip	2DR HTP	71-73 Chevrolet Impala, 71-73 Cadillac, 71-73 Oldsmobile 88, 71-73 Pontiac, 2 Door Hardtop	2420









Chevrolet • Impala

CODE	IMAGE	YEAR	DESCRIPTION	BODY	FITS	ITEM#
R		71-72-73-74	Roofrail weatherstrip	4DR HTP	71-74 Chevrolet Caprice, Impala, Buick LeSabre, Centurion, Oldsmobile 88, Pontiac Catalina, Bonneville 4 Door Hardtop	2221
R		71-72-73-74-75	Roofrail weatherstrip	2DR HTP	71-73 Impala Custom Coupe Caprice, 74-75 Impala Sport Coupe, 71-76 Cadillac Calais Deville, 71-74 Electra, 74-76 LeSabre, 71-71 98, 74 Oldsmobile 98 Oldsmobile Delta 88, 75-76 Oldsmobile Delta 88, 71-73 Grandville, 74 Bonneville Catalina Grandville, 75-76 Catalina, 2 Door Hardtop	2509
R		71-72-73-74-75-76	Header seal	CNV	71-75 Chevrolet Impala, Caprice, 71-72 Oldsmobile 88, 71-75 Pontiac Catalina, Grandville, 71-75 Buick Lesabre, Centurion, 71-76 Cadillac Eldorado, Convertible	2515
R		71-72-73-74-75-76	Weatherstrip kit for convertible top	CNV	71-72 Chevrolet Impala, 73-76 Caprice, 71-76 Cadillac Eldorado, 71-75 Oldsmobile Delta 88, 71, 72, 74 Buick LeSabre 71-73 Centurion, 71-72 Pontiac Catalina, 71-75 Grandville Convertible	2508
R		71-72-73-74-75-76	Pillar post weatherstrip with molded ends	CNV	71-75 Chevrolet Impala, Caprice 71-72 Oldsmobile 88, 71-75 Pontiac Catalina, Grandville, 71-75 Buick Lesabre, Centurion 71-76 Cadillac Eldorado, Convertible	2094
T		58-59-60-61-62-63-64-65-66-67-68-69	Trunk weatherstrip exact profile	2DR 4DR HTP 2DR SDN CNV	58-64 Chevrolet Biscayne, 58-64 Chevrolet Bel Air, Chevrolet Impala, 60-69 Chevrolet Corvair, 59-64 Pontiac Parisienne, 59-64 Pontiac Catalina, 59-64 Pontiac Star Chief, 60-61 Pontiac Ventura, 62-64 Pontiac Grand Prix, 58-64 Oldsmobile Delta 88, 58-64 Oldsmobile Dynamic 88, Oldsmobile Super 88, Oldsmobile Super 98, 61-64 Oldsmobile Starfire, 64 Oldsmobile Jetstar, 59-64 Buick LeSabre, 59-62 Buick Invicta, 59-64 Buick Electra, 62-64 Buick Wildcat, 63-65 Buick Riviera, 58-60 Cadillac Deville, Cadillac Eldorado, Cadillac Series 62, Cadillac Series 60 Special, Cadillac Series 75, 58-64 C-Body	2001
T		62-63-64	Trunk mat, sport coupe	2DR HTP 2DR SDN	62-64 Chevrolet Biscayne Bel Air Impala	2186
T		62-63-64	Trunk mat	CNV	62-64 Chevrolet Impala, Convertible	2187
T		62-63-64-65-66-67-68-69-70-71-72-73	Door and tailgate bottom drain hole seal	2DR 4DR HTP SDN CNV SWG CPE	62-73 Chevy Nova, Chevelle, Impala, Caprice Pontiac Catalina, Star Chief, Bonneville, Grand Prix Oldsmobile F85	2118













GUIDE TO SOFFSEAL'S PRODUCT CODES					
B = Bumper sets	C = Glass channels	D = Door related	G = Seals, gaskets	H = Under hood items	I = Interior parts
M = Miscellaneous items	R = Roofrail, pillar post & convertible items	T = Trunk related	W = Window related	Z = Weatherstrip kits	



CODE	IMAGE	YEAR	DESCRIPTION	BODY	FITS	ITEM#
T		64-65-66-67-68-69-70-71-72-73-74-75-76-77	Trunk weatherstrip exact profile length 17 feet	2DR 4DR HTP 2DR SDN CNV	65-72 Chevy II, 65-72 Chevrolet Biscayne, 65-75 Chevrolet Bel Air, 65-76 Chevrolet Impala, 65-76 Chevrolet Caprice, 64-77 Chevrolet Chevelle, 70-77 Chevrolet Monte Carlo, 65-76 Buick LeSabre, 64-77 Buick Wildcat, 64-77 Buick Skylark, 71-73 Buick Centurion, 64-72 Buick Grand Special, 73-77 Buick Century, 73-88 Buick Regal, 73-88 Buick Grand National, 65-76 Buick Electra, 65-76 Oldsmobile Delta 88, 67-69 Oldsmobile Delmont 88, 65-66 Oldsmobile Dynamic 88, 65-66 Oldsmobile Starfire, 65 Oldsmobile Jetstar, 64-77 Oldsmobile Cutlass 442, 64-88 Oldsmobile Cutlass, 65-76 Oldsmobile 98, 65-76 Pontiac Parisienne, 64-72 Pontiac LeMans, 65-70 Pontiac Catalina, 65-66 Pontiac Star Chief, 67-70 Pontiac Executive, 71-75 Pontiac Grand Ville, 65-77 Pontiac Grand Prix, 64-72 Pontiac Tempest, 62-72 Nova, Ventura, 73-74 Non-Hatchback, Up to 1975 with groove channel, Apollo, Nova, Omega, Ventura 65-76 C-Body	2003
T		65	Trunk mat	2DR HTP	65 Chevrolet Impala, 2 Door Hardtop	2347
T		65	Trunk mat	CNV	65 Chevrolet Impala, Convertible	2347A
T		66-67	Trunk mat	2DR HTP	66-67 Chevrolet Impala, 2 Door Hardtop	2348
T		66-67	Trunk mat	CNV	66-67 Impala, Convertible	2349
T		68	Trunk mat	2DR HTP	68 Chevrolet Impala Hardtop	2353
T		68	Trunk mat	CNV	68 Chevrolet Impala, Convertible	2354
T		69-70	Trunk mat	2DR HTP	69-70 Chevrolet Impala, 2 Door Hardtop	2355

Chevrolet • Impala

CODE	IMAGE	YEAR	DESCRIPTION	BODY	FITS	ITEM#
T		75-76-77-78-79-80-81-82-83-84-85-86-87-88-89-90-91-92	Trunk and Hatchback weatherstrip	2DR 4DR SDN HTP CNV	77-85 Chevrolet Impala, 77-91 Chevrolet Caprice, 82-92 Chevrolet Camaro, 75-79 Chevrolet Nova, 78-88 Chevrolet Monte Carlo, 78-83 Chevrolet Malibu, 78-83 Pontiac LeMans, 82-92 Pontiac Firebird, 75-91 Pontiac Ventura, 77-86 Pontiac Parisienne, 77-81 Pontiac Catalina, 69-88 Pontiac Grand Prix, 64-87 Pontiac LeMans, Pontiac Grand Am, 64-77 Pontiac GTO, 73-79 Oldsmobile Omega, 77-85 Oldsmobile Delta 88, 77-84 Oldsmobile 98, 77-88 Oldsmobile Cutlass, 73-75 Buick Apollo, 76-79 Buick Skylark, 77-79 Phoenix, 73-88 Buick Regal, 77-84 Buick Electra, 77-85 Buick LeSabre, 77-78 Buick Riviera, 77-91 C-Body	2424
W		58	Quarter window u-jamb	2DR HTP	58 Chevrolet Impala, Cadillac, Oldsmobile, Buick, Pontiac, 2 Door Hardtop	2285
W		58	Window weatherstrip original style with round bead	CNV	58 Chevrolet Impala, 58 Cadillac, 58 Oldsmobile 88 Oldsmobile 98, 58 Buick Special, Century, Roadmaster, 58 Pontiac, Convertible	2038
W		58	Window felts, 8 pc set	2DR HTP	58 Chevrolet Impala 2 Door Hardtop	2039
W		58-59-60	Quarter window u-jamb	CNV	58-60 Chevrolet Impala, 58 Cadillac, 59-60 Cadillac Series 62, Eldorado, 58-60 Oldsmobile 88 Oldsmobile 98, 58 Buick, 59-60 Buick LeSabre, Invicta, Electra, 58 Pontiac, Convertible	2286
W		58-59-60-61-62-63-64	Quarter window seals	2DR HTP CNV	58-64 Chevrolet Impala, 58, 60-62 Bel Air, 58-64 Cadillac Series 62, Deville, Eldorado, 58 Oldsmobile 88 Oldsmobile 98, 59-60 Oldsmobile 88 Oldsmobile 98, 61-64 Oldsmobile 99, Starfire, 98, 64 Jetstar, 59-62 Buick LeSabre, Invicta, Electra 2 Door Hardtop Convertible	2300
W		59-60	Rear quarter stationary vent window seals	4DR SDN	59-60 Chevrolet Buick, Style 4419, 4619, 4719 Oldsmobile, Pontiac 4 Door Sedan	2053
W		59-60	Window weatherstrip replacement style	CNV	59-60 Chevrolet Impala, Convertible	2096
W		59-60	Window weatherstrip replacement style	2DR HTP	59-60 Chevrolet Bel Air Impala, 2 Door Hardtop	2138
W		61-62	Window weatherstrip replacement style	2DR HTP	61 Chevrolet Impala, 62 Chevrolet Bel Air Bubbletop, 2 Door Hardtop	2139
W		61-62	Window weatherstrip replacement style	CNV	61-62 Chevrolet Impala, Convertible	2140















GUIDE TO SOFFSEAL'S PRODUCT CODES
B = Bumper sets **C** = Glass channels **D** = Door related **G** = Seals, gaskets **H** = Under hood items **I** = Interior parts
M = Miscellaneous items **R** = Roofrail, pillar post & convertible items **T** = Trunk related **W** = Window related **Z** = Weatherstrip kits



CODE	IMAGE	YEAR	DESCRIPTION	BODY	FITS	ITEM#
W		61-62	Vent window seals	2DR 4DR HTP CONV	61-62 Chevrolet Bel Air, Impala, 61-62 Cadillac Series 62, Eldorado, 61-62 Oldsmobile 88 Oldsmobile 98, 61-62 Buick LeSabre, Invicta, Electra, 61-62 Pontiac Bonneville, Catalina, Ventura 2 Door 4 Door Hardtop, Convertible	21615
W		61-62-63-64-65-66	Horizontal outer window seals	2DR 4DR HTP SDN CNV SWG	Chevy Biscayne, Bel Air, Impala, Caprice, Cadillac series 62 Deville, Eldorado, Fleetwood, Calais, Oldsmobile 88, Starfire, 98. Buick Lesabre, Invicta, Wildcat, Electra, Pontiac Catalina, Ventura, Star Chief, Bonneville	2310
W		62	Window weatherstrip replacement style	2DR HTP	62 Chevrolet Bel Air Impala, 2 Door Hardtop	2141
W		63-64	Vent window seals	2DR HTP CNV	63-64 Chevrolet Impala, Buick Electra, Lesabre, Wildcat, Oldsmobile 98, Pontiac Catalina, Bonneville, 2 Door Hardtop Convertible, Starfire Convertible Only	21814
W		63-64	Window weatherstrip replacement style	2DR HTP	63-64 Chevrolet Impala, 2 Door Hardtop	2180
W		63-64	Window weatherstrip replacement style	CNV	63-64 Chevrolet Impala, Convertible	2190
W		63-64	Window weatherstrip replacement style	4DR HTP	63-64 Chevrolet Impala, 4 Door Hardtop	21901
W		65	Window weatherstrip replacement style	2DR HTP	65 Chevrolet Impala, 2 Door Hardtop	2335
W		65	Window weatherstrip replacement style	CNV	65 Chevrolet Impala, Convertible	2335A
W		65-66	Quarter window seals	2DR HTP CNV	65-66 Chevrolet Impala, 66 Chevrolet Caprice, 65-66 Cadillac Calais, Deville 65-66 Oldsmobile 88, Jetstar, 65-66 Buick LeSabre, Wildcat, 65-66 Pontiac Bonneville, Catalina, Star Chief 2 Door Hardtop Convertible	2301
W		65-66	Quarter window seals	4DR HTP	65-66 Chevrolet Impala, 66 Chevrolet Caprice, 65-66 Cadillac Calais, Deville, 65-66 Oldsmobile 88 Oldsmobile 98, 65-66 Buick LeSabre, Wildcat, Electra, 65-66 Pontiac Bonneville, Catalina, Star Chief 4 Door Hardtop	23011
W		65-66	Door u-jamb seal	2DR HTP CNV	65-66 Chevrolet Impala, 66 Caprice, 65-66 Cadillac Calais, Deville, Eldorado, 65-66 Oldsmobile 88, Jetstar, Starfire, Oldsmobile 98, 65-66 Buick LeSabre, Wildcat, Electra, 65 Pontiac Bonneville, Catalina, Star Chief 2hardtop Convertible	2368
W		65-66	Window weatherstrip original style with round bead	4DR HTP	65-66 Chevrolet Impala 4 Door Hardtop	2427

Chevrolet • Impala

CODE	IMAGE	YEAR	DESCRIPTION	BODY	FITS	ITEM#
W		65-66-67-68	Vent window weatherstrip	2DR SDN SWG 4DR	65-68 2 Door 4 Door Sedan And Station Wagon	2284
W		65-66-67-68	Vent window weatherstrip	2DR HTP CNV	65-68 Chevrolet Impala, Buick LeSa- bre, Electra, Wildcat, Cadillac Calais, Deville, Oldsmobile 88 Oldsmobile 98 Starfire, Pontiac Bonneville, Catalina, Star Chief 2 Door Hardtop Convertible	2217
W		65-66-67-68	Glass run channel front window	2DR HTP CNV	65-68 Chevrolet Impala, Caprice, 65- 68 Cadillac Calais, Deville 65-66 Eldo- rado, 65-68 Oldsmobile 88 Oldsmobile 98, 65-66 Oldsmobile Jetstar, Starfire, 65-68 Buick LeSabre, Wildcat, Electra, 65-68 Pontiac Bonneville, Catalina, Executive 2 Door Hardtop Convertible	2350
W		66	Window weatherstrip replacement style	CNV	66 Chevrolet Impala, Convertible	2336
W		66	Window weatherstrip replacement style	2DR HTP	66 Chevrolet Impala 2 Door Hardtop	2337
W		67-68	Window weatherstrip replacement style	2DR HTP	67-68 Chevrolet Impala 2 Door Hardtop	2338
W		67-68	Quarter window seals	2DR HTP	67-68 Chevrolet Impala, 67-68 Cadil- lac Calais, Deville 67-68 Oldsmobile 88, 98, 67-68 Buick LeSabre, Wildcat, Electra 67-68 Pontiac Catalina, Bonn- eville, Executive 2 Door Hardtop	2302
W		67-68	Quarter window seals	CNV	67-68 Chevrolet Impala, 67-68 Cadillac Deville, 67-68 Oldsmobile 88 Oldsmobile 98, 67-68 Buick LeSabre, Wildcat, Electra, 67-68 Pontiac Catalina, Bonneville Convertible	23021
W		67-68	Quarter window u-jamb	2DR HTP CNV	67-68 Chevrolet Impala, 67-68 Cadil- lac Calais, Deville, 67 Oldsmobile 98, 67-68 Buick, LeSabre, Wildcat, Electra, 67-68 Pontiac Bonneville, Catalina 2 Door Hardtop	2292
W		67-68	Quarter window u-jamb	2 DR CNV HTP	67-68 Chevy Impala Convertible 68 Caprice Sport Coupe, 67 Buick Lasabre, Wildcat Convertible, 67 Electra 2 Door Hardtop & Convertible, 68 Buick Wildcat, Electra, Lesabre 2 Door Hardtop & Convertible, 67 Cadillac Deville Convertible, 68 Cadillac Calais, Deville Hardtop & Convertible 67-68 Oldsmobile 88, Oldsmobile 98, 67-68 Pontiac Catalina, Bonneville, Executive, Grand Prix Hardtop & Convertible	2294
W		67-68	Window weatherstrip replacement style	2DR HTP	67-68 Chevrolet Caprice Custom, Impala 2 Door Hardtop	2341
W		67-68	Window weatherstrip replacement style	CNV	67-68 Chevrolet Impala, Convertible	2343











GUIDE TO SOFFSEAL'S PRODUCT CODES					
B = Bumper sets	C = Glass channels	D = Door related	G = Seals, gaskets	H = Under hood items	I = Interior parts
M = Miscellaneous items	R = Roofrail, pillar post & convertible items	T = Trunk related	W = Window related	Z = Weatherstrip kits	



CODE	IMAGE	YEAR	DESCRIPTION	BODY	FITS	ITEM#
W		68-69-70-71-72	Quarter window seals, with steel insert	2DR HTP CNV	68-72 Chevrolet Chevelle, Oldsmobile Cutlass, Buick Skylark, Pontiac LeMans, 69-70 Chevrolet Impala, 70-72 Chevrolet Monte Carlo, 2 Door Hardtop Convertible	5112M
W		68-69-70-71-72	Quarter window seals, all rubber	2DR HTP CNV	68-72 Chevrolet Chevelle, Oldsmobile Cutlass, Buick Skylark, Pontiac LeMans, 69-70 Chevrolet Impala, 70-72 Chevrolet Monte Carlo, 2 Door Hardtop Convertible	5112R
W		69-70	Window weatherstrip replacement style	2DR HTP	69-70 Chevrolet Caprice Custom Impala Custom 2 Door Hardtop	2361
W		69-70	Window weatherstrip replacement style	2DR HTP	69-70 Chevrolet Impala Sport Coupe 2 Door Hardtop	2362
W		69-70	Window weatherstrip replacement style	CNV	69-70 Chevrolet Impala, Convertible	2363
W		69-70	Qtr window u jamb	CNV 2DR HTP	69-70 Chevrolet Impala, 69-70 Cadillac, Eldorado, 69-70 Oldsmobile 88 Oldsmobile 98, 69-70 Buick LeSabre, Wildcat, 69 Pontiac Catalina, Executive, Bonneville Convertible 2 Door Hardtop	2293
W		71-72-73	Qtr window u jamb	2DR HTP CNV	71-73 Buick LeSabre, Electra, Riviera, Chevrolet Impala, Caprice, Cadillac Calais, Deville, Oldsmobile 88 Oldsmobile 98, Pontiac Catalina, Bonneville, Grandville 2 Door Hardtop Convertible	2600
W		71-72-73-74-75	Window weatherstrip replacement style outer only	CNV	71-75 Chevrolet Impala, Caprice Convertible	2425
W		71-72-73-74-75-76	Window weatherstrip door outers only replacement style	2DR HTP	71-76 Chevrolet Impala Caprice 2 Door Hardtop	2426
W		71-72-73-74-75-76	Quarter window seals	2DR HTP CNV	71-75 Chevrolet Impala, Caprice, 71-76 Cadillac Eldorado Convertible Only, 71-76 Oldsmobile 88, 76 Oldsmobile 98, 71-73 Buick LeSabre, 71-73 Centurion, 71-75 Pontiac Catalina, Bonneville, Grandville 2 Door Hardtop Convertible	2308
W		71-72-73-74-75-76	Quarter window seals	4DR HTP	71-75 Chevrolet Impala, Caprice, Cadillac Calais, Deville, Pontiac Catalina, Bonneville, Grandville Buick LeSabre, Electra, Oldsmobile 88, 98, 4 Door Hardtop	2309
W		74-75-76	Quarter window u-jamb	2DR HTP CNV	Impala Caprice LeSabre Electra Eldorado Oldsmobile Delta 88 Oldsmobile 98, Tornado Delta Bonneville Catalina Grandville Catalina	2295
W		77-78-79-80-81-82-83-84-85-86-87-88-89-90	Window weatherstrip outers only, rwd with chrome bead	2DR SDN	77-90 Chevrolet Impala, Caprice, Buick LeSabre, Electra, Oldsmobile 88 Oldsmobile 98, Pontiac Catalina, Bonneville, Cadillac Deville, 2 Door Sedan	2369

Chevrolet • Impala

CODE	IMAGE	YEAR	DESCRIPTION	BODY	FITS	ITEM#
W	 IMAGE COMING SOON	77-78-79-80-81- 82-83-84-85-86- 87-88-89-90	Window weatherstrip, outers only, rwd, with o chrome bead	2DR SDN	77-90 Chevrolet Impala, Caprice, Buick LeSabre, Electra, Oldsmobile 88 Oldsmobile 98, Pontiac Catalina, Bonneville, Cadillac Deville, 2 Door Sedan	23691
Z		58	Weatherstrip kit, includes a arm seals, door weatherstrips, lock gaskets, quarter window seals, roofrail weatherstrips, trunk weatherstrip, window weatherstrips, hood to cowl seal, door j weatherstrips, lens gaskets, pillar post seals	2DR HTP	58 Chevrolet Impala 2 Door Hardtop	KIT205
Z		58	Weatherstrip kit, includes a arm seals, door weatherstrips, hood to cowl seal, lock gaskets, quarter window seals, trunk weatherstrip, window weatherstrips, convertible top kit, door j weatherstrips, lens gaskets, pillar post seals	CNV	58 Chevrolet Impala Convertible	KIT206
Z		59	Weatherstrip kit, includes a arm seals, door weatherstrips, lock gaskets, quarter window seals, roofrail weatherstrips, trunk weatherstrip, window weatherstrips, hood to cowl, door j weatherstrips, lens gaskets	2DR HTP	59 Chevrolet Impala 2 Door Hardtop	KIT207
Z		59	Weatherstrip kit, includes a arm seals, door weatherstrips, hood to cowl seal, lock gaskets, quarter window seals, trunk weatherstrip, window weatherstrips, convertible top kit, door j weatherstrips, lens gaskets, pillar post seals	CNV	59 Chevrolet Impala Convertible	KIT208
Z		60	Weatherstrip kit, includes a arm seals, door weatherstrips, lock gaskets, quarter window seals, roofrail weatherstrips, trunk weatherstrip, window weatherstrips, hood to cowl, door j weatherstrips, lens gaskets	2DR HTP	60 Chevrolet Impala 2 Door Hardtop	KIT215
Z		60	Weatherstrip kit, includes a arm seals, door weatherstrips, hood to cowl seal, lock gaskets, quarter window seals, trunk weatherstrip, window weatherstrips, convertible top kit, door j weatherstrips, lens gaskets, pillar post seals	CNV	60 Chevrolet Impala Convertible	KIT216
Z		61	Weatherstrip kit, includes a arm seals, door weatherstrips, lock gaskets, quarter window seals, roofrail weatherstrips, trunk weatherstrip, window weatherstrips, hood to cowl seal, lens gaskets	2DR HTP	61 Chevrolet Impala 2 Door Hardtop	KIT209



GUIDE TO SOFFSEAL'S PRODUCT CODES

B = Bumper sets **C** = Glass channels **D** = Door related **G** = Seals, gaskets **H** = Under hood items **I** = Interior parts
M = Miscellaneous items **R** = Roofrail, pillar post & convertible items **T** = Trunk related **W** = Window related **Z** = Weatherstrip kits



CODE	IMAGE	YEAR	DESCRIPTION	BODY	FITS	ITEM#
Z		61	Weatherstrip kit includes trunk weatherstrip, door weatherstrip, roofrail weatherstrip	2DR HTP	61 Chevrolet Impala, Buick, Cadillac, Oldsmobile, Pontiac 2 Door Hardtop	KIT209X
Z		61	Weatherstrip kit, includes a arm seals, door weatherstrips, hood to cowl seal, lock gaskets, quarter window seals, trunk weatherstrip, window weatherstrips, convertible top kit, lens gaskets	CNV	61 Chevrolet Impala Convertible	KIT210
Z		62	Weatherstrip kit, includes a arm seals, door weatherstrips, lock gaskets, quarter window seals, roofrail weatherstrips, trunk weatherstrip, window weatherstrips, hood to cowl seal, bumper kit, lens gaskets	2DR HTP	62 Chevrolet Impala 2 Door Hardtop	KIT211
Z		62	Weatherstrip kit, includes trunk weatherstrip, door weatherstrip, roofrail weatherstrip	2DR HTP	62 Chevrolet Impala, Buick, Oldsmobile, Pontiac 2 Door Hardtop	KIT211X
Z		62	Weatherstrip kit, includes a arm seals, door weatherstrips, hood to cowl seal, lock gaskets, quarter window seals, trunk weatherstrip, window weatherstrips, bumper kit, convertible top kit kit, lens gaskets, pillar post seals	CNV	62 Chevrolet Impala Convertible	KIT212
Z		63	Weatherstrip kit, includes a arm seals, door weatherstrips, lock gaskets, quarter window seals, roofrail weatherstrips, trunk weatherstrip, window weatherstrips, hood to cowl seal, bumper kit, lens gaskets	2DR HTP	63 Chevrolet Impala 2 Door Hardtop	KIT217
Z		63	Weatherstrip kit, includes a arm seals, door weatherstrips, hood to cowl seal, lock gaskets, quarter window seals, trunk weatherstrip, window weatherstrips, bumper kit, convertible top kit, lens gaskets, pillar post seals	CNV	63 Chevrolet Impala Convertible	KIT219
Z		63-64	Weatherstrip kit, includes trunk weatherstrip, door weatherstrip, roofrail weatherstrip	2DR HTP	63-64 Chevrolet Impala, Buick, Cadillac, Oldsmobile, Pontiac, 2 Door Hardtop	KIT217X
Z		64	Weatherstrip kit, includes a arm seals, door weatherstrips, lock gaskets, quarter window seals, roofrail weatherstrips, trunk weatherstrip, window weatherstrips, hood to cowl seal, bumper kit, lens gaskets	2DR HTP	64 Chevrolet Impala 2 Door Hardtop	KIT218
Z		64	Weatherstrip kit, includes a arm seals, door weatherstrips, hood to cowl seal, lock gaskets, quarter window seals, trunk weatherstrip, window weatherstrips, bumper kit, convertible top kit, lens gaskets, pillar post seals	CNV	64 Chevrolet Impala Convertible	KIT220

Chevrolet • Impala

CODE	IMAGE	YEAR	DESCRIPTION	BODY	FITS	ITEM#
Z		65	Weatherstrip kit, includes a arm seals, door weatherstrips, hood to cowl seal, lock gaskets, quarter window seals, trunk weatherstrip, window weatherstrips, bumper kit, pillar post seals, convertible top kit	CNV	65 Chevrolet Impala Convertible	KIT214
Z		65	Weatherstrip kit, includes a arm seals, door weatherstrips, lock gaskets, quarter window seals, roofrail weatherstrips, trunk weatherstrip, window weatherstrips, hood to cowl seal, bumper kit	2DR HTP	65 Chevrolet Impala 2 Door Hardtop	KIT213
Z		65-66	Weatherstrip kit, includes trunk weatherstrip, door weatherstrip, roofrail weatherstrip	2DR HTP	65-66 Chevrolet Impala, Buick, Cadillac, Oldsmobile, Pontiac, 2 Door Hardtop	KIT213X
Z		66	Weatherstrip kit, includes a arm seals, door weatherstrips, lock gaskets, quarter window seals, roofrail weatherstrips, trunk weatherstrip, window weatherstrips, hood to cowl seal, bumper kit	2DR HTP	66 Chevrolet Impala 2 Door Hardtop	KIT221
Z		66	Weatherstrip kit, includes a arm seals, door weatherstrips, hood to cowl seal, lock gaskets, quarter window seals, trunk weatherstrip, window weatherstrips, bumper kit, pillar post seals, convertible top kit	CNV	66 Chevrolet Impala Convertible	KIT222
Z		67	Weatherstrip kit, includes a arm seals, door weatherstrips, lock gaskets, quarter window seals, roofrail weatherstrips, trunk weatherstrip, window weatherstrips, hood to cowl seal, bumper kit	2DR HTP	67 Chevrolet Impala 2 Door Hardtop	KIT223
Z		68	Weatherstrip kit, includes a arm seals, door weatherstrips, lock gaskets, quarter window seals, roofrail weatherstrips, trunk weatherstrip, window weatherstrips, bumper kit	2DR HTP	68 Chevrolet Impala 2 Door Hardtop	KIT224



WHAT IS A PRODUCT CODE?
 Our catalog is grouped by product CODE (type) then years. See page 1 for details explaining the different Product CODES.









GUIDE TO SOFFSEAL'S PRODUCT CODES					
B = Bumper sets	C = Glass channels	D = Door related	G = Seals, gaskets	H = Under hood items	I = Interior parts
M = Miscellaneous items	R = Roofrail, pillar post & convertible items	T = Trunk related	W = Window related	Z = Weatherstrip kits	



CODE	IMAGE	YEAR	DESCRIPTION	BODY	FITS	ITEM#
B		65	Hood side bumpers	2DR 4DR HTP 2DR SDN CNV SWG	65 Chevrolet Biscayne, Impala, Bel Air, Caprice, Chevelle, Malibu, 65 Cadillac, 65 Oldsmobile, 65 Buick, 65 Pontiac	2182
B		77-78-79-80-81-82-83-84-85-86-87-88-89-90	Hoodsides bumpers	2DR HTP	77-90 Chevrolet Caprice, Impala 78-88 Chevrolet El Camino, Malibu, Monte Carlo, 2 Door Hardtop	2373
B		78-79-80-81-82-83-84-85-86-87-88	Trunk bumpers	2DR SDN 2DR HTP	78-88 Chevrolet Monte Carlo, 78-83 Chevrolet Malibu, Oldsmobile Cutlass	5217
D		73-74-75-76-77	Door weatherstrip with clips & molded ends	2DR HTP	Grand Am 2 Door 73-77 Chevrolet, LeMans, Grand LeMans, Century, Regal, Cutlass, Chevelle Malibu Laguna, El Camino, 2 Door Hardtop	5017
D		73-74-75-76-77	Front door weatherstrip with clips & molded ends	2DR 4DR SDN HTP CNV	73-77 Chevrolet Malibu, Buick Skylark, Oldsmobile Cutlass, 4 Door Sedan	5026
D		78-79-80-81-82-83-84-85-86-87	Door weatherstrip rear door with clips	4DR SDN	78-87 Chevrolet Malibu, Buick Regal, Oldsmobile Cutlass, Pontiac LeMans, 4 Door Sedan	5037
D		78-79-80-81-82-83-84-85-86-87	Door weatherstrip rear door with clips	SWG	78-87 Chevrolet Malibu, Buick Regal, Oldsmobile Cutlass, Pontiac LeMans, Station Wagon	5038
D		78-79-80-81-82-83-84-85-86-87-88	Door weatherstrip a-body with clips & molded ends	2DR HTP	78-88 Chevrolet Malibu, El Camino, Monte Carlo, Oldsmobile Cutlass, Buick Regal, Pontiac LeMans, Grand Prix 2 Door, Replacement Part For Buick, Oldsmobile And Pontiac, 82-88 Is A G Body	5025
D		78-79-80-81-82-83-84-85-87	Door weatherstrip front door with clips	4DR SDN	78-87 Chevrolet Malibu, Buick Regal, Oldsmobile Cutlass, Pontiac LeMans, 4 Door Sedan	5036
G		61-62-63-64-65	Outside mirror gasket	2DR 4DR HTP 2DR SDN CNV SWG	61-65 Chevrolet 68-69 Chevelle Malibu El Camino 63-64 Impala Biscayne Bel Air	2306
G		64	Park light lens gaskets	2DR 4DR HTP 2DR SDN CNV SWG	64 Chevrolet Biscayne Bel Air Impala Chevelle El Camino Malibu	2168
G		64	Taillight, mounting bases, upper & lower	2DR SDN 2DR 4DR HTP CNV SWG	64 Chevrolet Malibu	5183
G		78-79-80-81-82-83-84-85-86-87	Rear side marker gasket	SWG	78-87 Chevrolet El Camino, Gmc Caballero, 78-83 Chevrolet Malibu Wagon, 82-83 Pontiac Bonneville Wagon, 78-81 Pontiac LeMans Wagon, Oldsmobile Cutlass Wagon, 82-86 Oldsmobile Cutlass 4 Door Except Fwd, 78-82 Buick Century Wagon, Station Wagon	5214
H		73-74-75-76-77	Hood insulation with clips	ALL BODY STYLES	73-77 Chevelle Malibu	5177

Chevrolet • Malibu

CODE	IMAGE	YEAR	DESCRIPTION	BODY	FITS	ITEM#
I		62-63-64-65-66-67-68-69-70-71	Accelerator pedal hp with deluxe trim	2DR 4DR HTP 2DR SDN CNV SWG	62-71 Chevrolet Biscayne Bel Air Impala, 64-67 Chevelle, 70-71 Camaro Hi Perfor, 64-67 Buick Special-Skylark El Camino, 64-65 Pontiac A Body	2069
R		73-74-75-76-77	Roofrail weatherstrip	2DR HTP	73-77 Chevrolet Malibu, Pontiac LeMans, Grand Am, Buick Century, Oldsmobile Cutlass, 2 Door Hardtop	5035
R		78-79-80-81	Roofrail weatherstrip	2DR HTP	78-81 Chevrolet Malibu, Pontiac LeMans, 2 Door	5401
T		75-76-77-78-79-80-81-82-83-84-85-86-87-88-89-90-91-92	Trunk and Hatchback weatherstrip	2DR 4DR SDN HTP CNV	77-85 Chevrolet Impala, 77-91 Chevrolet Caprice, 82-92 Chevrolet Camaro, 75-79 Chevrolet Nova, 78-88 Chevrolet Monte Carlo, 78-83 Chevrolet Malibu, 78-83 Pontiac LeMans, 82-92 Pontiac Firebird, 75-91 Pontiac Ventura, 77-86 Pontiac Parisienne, 77-81 Pontiac Catalina, 69-88 Pontiac Grand Prix, 64-87 Pontiac LeMans, Pontiac Grand Am, 64-77 Pontiac GTO, 73-79 Oldsmobile Omega, 77-85 Oldsmobile Delta 88, 77-84 Oldsmobile 98, 77-88 Oldsmobile Cutlass, 73-75 Buick Apollo, 76-79 Buick Skylark, 77-79 Phoenix, 73-88 Buick Regal, 77-84 Buick Electra, 77-85 Buick LeSabre, 77-78 Buick Riviera, 77-91 C-Body	2424
W		78-79-80-81-82-83	Window weatherstrip, outers only original style with flat bead	4DR SDN SWG	78-83 Chevrolet Malibu 4 Door Sedan Station Wagon	5148
W		78-79-80-81-82-83-84-85-86-87	Window weatherstrip replacement style	2DR HTP	78-87 Chevrolet El Camino, 78-83 Chevrolet Malibu	5137
Z		78-79-80-81-82-83	Weatherstrip kit, includes trunk weatherstrip, door weatherstrip, roofrail weatherstrip, window weatherstrip	2DR HTP	78-83 Chevrolet Malibu, 2 Door Hardtop	KIT539



GUIDE TO SOFFSEAL'S PRODUCT CODES						
B = Bumper sets	C = Glass channels	D = Door related	G = Seals, gaskets	H = Under hood items	I = Interior parts	
M = Miscellaneous items	R = Roofrail, pillar post & convertible items		T = Trunk related	W = Window related	Z = Weatherstrip kits	

Chevrolet • Monte Carlo



CODE	IMAGE	YEAR	DESCRIPTION	BODY	FITS	ITEM#
B		62-63-64-65-66-67-68-69-70-71-72-73-74-75	Trunk bumpers	2DR HTP 2DR SDN CNV	70-75 Chevrolet Camaro, Pontiac Firebird, 62-73 Chevy II Nova, 64-72, Pontiac GTO, Tempest, Le Mans, Chevrolet Chevelle, Monte Carlo, Buick Skylark, Oldsmobile Cutlass, 65-69 Chevrolet Corvair, 65-70 Full Size Chevrolet	3112
B		65-66-67-68-69-70-71-72-73-74-75-76-77-78-79-80-81-82-83-84-85-86-87-88-89-90-91-92-93-94-95-96-97-98-99-00-01-02	Door bumpers	2DR 4DR HTP 2DR SDN SWG CNV	65-66 Chevrolet, Pontiac, Oldsmobile, Buick, 65-69 Corvair, 70-02 Chevrolet Camaro, Pontiac Firebird, 68-81 Chevelle, GTO, Cutlass, Skylark, 68-72 El Camino, Tempest, LeMans GTO, 70-72 Monte Carlo	2321
B		66-67-68-69-70-71-72	Bumper kit, includes: door hood trunk glove box	2DR 4DR HTP 2DR SDN CNV SWG	66 Chevrolet Biscayne, Bel Air, Impala, Caprice, 68-69 Chevelle, 70-71 Chevelle, Monte Carlo, 72 Chevelle, 66-72 Cadillac, 66-72 Oldsmobile, 66-72 Buick, 66-72 Pontiac	2371
B		67-68-69-70-71-72-73-74-75-76-77	Hood side bumper, 2 pr. required	2DR HTP CNV 2DR SDN SWG	67-69 Chevrolet Camaro Chevelle, 73-77 Monte Carlo,	3024
B		68-69-70-71-72-73-74-75-76-77	Hood to cowl bumper	2DR SDN 2DR 4DR HTP CNV SWG	68-72 Pontiac GTO, LeMans, 73-77 Chevrolet Monte Carlo, Chevelle	6472
B		77-78-79-80-81-82-83-84-85-86-87-88-89-90	Hoodside bumpers	2DR HTP	77-90 Chevrolet Caprice, Impala 78-88 Chevrolet El Camino, Malibu, Monte Carlo, 2 Door Hardtop	2373
B		78-79-80-81-82-83-84-85-86-87-88	Trunk bumpers	2DR SDN 2DR HTP	78-88 Chevrolet Monte Carlo, 78-83 Chevrolet Malibu, Oldsmobile Cutlass	5217
D		69-70-71-72	Door weatherstrip with clips & molded ends	2DR HTP CNV	69-72 Chevelle, Grand Prix, Monte Carlo, Skylark, Cutlass, 2 Door Hardtop And Convertible	5022
D		73-74-75-76-77	Door weatherstrip with clips & molded ends	2DR HTP	73-77 Chevrolet Monte Carlo 2 Door	5018
D		78-79-80-81-82-83-84-85-86-87-88	Door weatherstrip a-body with clips & molded ends	2DR HTP	78-88 Chevrolet Malibu, El Camino, Monte Carlo, Oldsmobile Cutlass, Buick Regal, Pontiac LeMans, Grand Prix 2 Door, Replacement Part For Buick, Oldsmobile And Pontiac, 82-88 Is A G Body	5025
G		66-67-68-69-70-71-72	Door handle & lock gaskets set	2DR HTP 2DR SDN CNV	67-69 Chevrolet Camaro, Pontiac Firebird, 66-72 Chevy II Nova, 64-72 Chevrolet Chevelle, Pontiac Tempest, LeMans, GTO, Buick Skylark, Oldsmobile Cutlass, 70-72 Chevrolet Monte Carlo	3021
G		68-69	Trunk lock retainer seal	2DR 4DR HTP 2DR SDN 4DR SDN	68-69 Chevrolet Chevelle, Monte Carlo, El Camino	5086
G		68-69-70-71-72	Steering column sponge seal	2DR SDN CNV 2DR HTP SWG	68-72 Chevelle El Camino Monte Carlo, Buick Skylark, Oldsmobile Cutlass	5161

Chevrolet • Monte Carlo

CODE	IMAGE	YEAR	DESCRIPTION	BODY	FITS	ITEM#
G		70	Park lens gaskets	2DR HTP 2DR SDN	70 Chevrolet Monte Carlo, El Camino	5238
G		70	Paint gasket set	2DR HTP	70 Chevrolet Monte Carlo	52381
G		70	Park light lens gaskets	2DR HTP 2DR SDN CNV SWG	70 Chevrolet Chevelle, El Camino, Monte Carlo	5200
G		70-71-72	Taillight lens gaskets	2DR HTP	70-72 Chevrolet Monte Carlo	5240
G		70-71-72	Rear bumper reflector gasket, backup lens gasket	2DR SDN 2DR HTP CNV SWG	70-72 Chevrolet El Camino, Monte Carlo, SWG	5241
G		70-71-72	Body to bumper seals	2DR HTP	70-72 Chevrolet Monte Carlo	5250
G		70-71-72	Fender skirt weatherstrip	2DR HTP	70-72 Chevrolet Monte Carlo	5252
G		71	Paint gasket set	2DR HTP	71 Chevrolet Monte Carlo	52382
G		71-72	Park lens gaskets passenger	2DR HTP 2DR SDN CNV	71-72 Chevrolet Chevelle, El Camino, Monte Carlo	5203
G		72	Park lens gaskets	2DR HTP	72 Chevrolet Monte Carlo	5242
G		72	Paint gasket set	2DR HTP	72 Chevrolet Monte Carlo	52383
H		68-69	Hood to cowl seal clip kit steel	2DR 4DR HTP 2DR SDN CNV SWG	68-69 Chevelle, El Camino, Monte Carlo, GTO, LeMans, Buick Skylark, Oldsmobile Cutlass	5075
H		68-69-70-71-72	Hood to cowl seal clip kit plastic	2DR 4DR HTP 2DR SDN CNV SWG	68-72 Chevrolet Chevelle, El Camino, Monte Carlo, Pontiac GTO LeMans, Buick Skylark, Oldsmobile Cutlass	5077
H		68-69-70-71-72	A-arm seal steel inner fenders with staples	2DR 4DR HTP 2DR SDN CNV SWG	68-72 Chevrolet Chevelle, El Camino	5068
H		68-69-70-71-72	Rear hood seal	2DR 4DR HTP 2DR SDN CNV SWG	68-72 Chevrolet Chevelle, El Camino, Monte Carlo	5070A
H		68-69-70-71-72	Hood to cowl seal dense	2DR 4DR HTP 2DR SDN CNV SWG	68-72 Chevrolet Chevelle, El Camino, Monte Carlo, Pontiac GTO, LeMans, Buick Skylark, Oldsmobile Cutlass	5074
H		68-69-70-71-72	Hood to cowl seal sponge	2DR 4DR HTP 2DR SDN CNV SWG	68-72 Chevrolet Chevelle, El Camino, Monte Carlo, Pontiac GTO, LeMans, Buick Skylark, Oldsmobile Cutlass	50741



GUIDE TO SOFFSEAL'S PRODUCT CODES









B = Bumper sets **C** = Glass channels **D** = Door related **G** = Seals, gaskets **H** = Under hood items **I** = Interior parts
M = Miscellaneous items **R** = Roofrail, pillar post & convertible items **T** = Trunk related **W** = Window related **Z** = Weatherstrip kits

Chevrolet • Monte Carlo



CODE	IMAGE	YEAR	DESCRIPTION	BODY	FITS	ITEM#
H		68-69-70-71-72	Firewall clutch boot	2DR HTP 2DR SDN CNV	68-72 Chevrolet Chevelle, El Camino, Monte Carlo, Pontiac LeMans, Tempest, GTO, Buick Skylark, Oldsmobile Cutlass	5053
H		69-70-71-72	A-arm seal plastic inner fenders with staples	2DR 4DR HTP 2DR SDN CNV SWG	69-72 Chevrolet Chevelle, El Camino	5069
H		70-71-72	Hood insulation with clips	2DR HTP	70-72 Chevrolet Monte Carlo	5180
H		70-72	A-arm seal plastic inner fenders with staples	2DR 4DR HTP 2DR SDN CNV SWG	70-72 Chevrolet Monte Carlo	50691
I		64-65-66-67-68-69-70-71-72-73-74	Park brake pedal pad	2DR HTP CNV	El Camino Cutlass Chevelle Chevy II Camaro Firebird LeMans Tempest GTO Grand Prix Full Size Centurion Century Electra Invicta LeSabre Regal Riviera Skylark Wildcat Monte Carlo	3094
I		66-67-68-69-70-71-72	Brake pedal pad standard disc	2DR HTP 2DR 4DR SDN CNV SWG	67-69 Chevrolet Camaro 66-72 Chevrolet Chevelle 70-72 Chevrolet Monte Carlo	3041
I		66-67-68-69-70-71-72	Auto disc pad	2DR 4DR HTP 2DR SDN CNV SWG	66-72 Chevrolet Chevelle, El Camino, Monte Carlo	5058A
I		68-69-70-71-72	Rubber console sealing strip 4 pre cut	2DR 4DR HTP 2DR SDN CNV SWG	68-72 Chevrolet Chevelle, El Camino, 70-72 Monte Carlo	5059
I		68-69-70-71-72	Shift boot 4-speed with o console	2DR HTP 2DR SDN CNV	68-72 Chevrolet Chevelle, El Camino, Monte Carlo	5062
I		68-69-70-71-72	Shift boot 4 speed with console	2DR 4DR SDN HTP CNV	68-72 Chevelle, El Camino, Monte Carlo	5063
I		68-69-70-71-72	Automatic brake pad	2DR 4DR HTP 2DR SDN CNV SWG	68-72 Chevrolet Chevelle, El Camino, Monte Carlo, Buick Skylark, Oldsmobile Cutlass, 71-72 Pontiac LeMans, Tempest, GTO	5058
M		68-69-70-71-72	Core support bushing bolt kit	2DR 4DR HTP 2DR SDN CNV SWG	68-72 Chevelle El Camino Skylark Special Gran Sport Sports Wagon 442 Cutlass F85 Vista Cruizer Wagon Tempest LeMans GTO T37 Monte Carlo Impala	5167
M		68-69-70-71-72-73-74-75-76-77-78-79	Brake & clutch pedal pad	2DR HTP CNV SDN	67-72 Chevrolet Camaro Standard, Pontiac Firebird, 68-79 Chevrolet Corvette, 68-72 Chevrolet Nova, 64-72 Chevrolet Chevelle, 70-72 Monte Carlo 71-72 GTO, 2 Door Hardtop Convertible Sedan	3096
M		69	Door jamb louvers	2DR 4DR HTP 2DR SDN CNV SWG	69 Chevelle, El Camino, Monte Carlo, Pontiac LeMans, GTO, Tempest	5043

Chevrolet • Monte Carlo

CODE	IMAGE	YEAR	DESCRIPTION	BODY	FITS	ITEM#
M		70-71-72	Body mounts with steel sleeves	2DR HTP	70-72 Chevrolet Monte Carlo, 2 Door Hardtop	51652
R		73-74-75-76-77	Roofrail weatherstrip	2DR HTP	73-77 Pontiac Grand Prix, Chevrolet Monte Carlo, 2 Door Hardtop	5035B
R		78-79-80-81-82-83-84-85-86-87-88	Roofrail weatherstrip	2DR HTP	78-88 Chevrolet Monte Carlo, Oldsmobile Cutlass, Buick Regal, Pontiac Grand Prix, 2 Door	5400
R		78-79-80-81-82-83-84-85-86-87-88	T-top weatherstrip fits on body	2DR HTP	78-88 Chevrolet Monte Carlo, Oldsmobile Cutlass, Buick Regal, Pontiac Grand Prix, 2 Door Hardtop	5402
R		78-79-80-81-82-83-84-85-86-87-88	T-top weatherstrip fits on t-top	2DR HTP	78-88 Chevrolet Monte Carlo, Oldsmobile Cutlass, Buick Regal, Pontiac Grand Prix, 2 Door Hardtop	5403
R		78-79-80-81-82-83-84-85-86-87-88	Auxiliary t-top sealing strips	2DR HTP	78-88 Chevrolet Monte Carlo, Oldsmobile Cutlass, Buick Regal, Pontiac Grand Prix, 2 Door Hardtop	5404
T		64-65-66-67-68-69-70-71-72-73-74-75-76-77	Trunk weatherstrip exact profile length 17 feet	2DR 4DR HTP 2DR SDN CNV	65-72 Chevy II, 65-72 Chevrolet Biscayne, 65-75 Chevrolet Bel Air, 65-76 Chevrolet Impala, 65-76 Chevrolet Caprice, 64-77 Chevrolet Chevelle, 70-77 Chevrolet Monte Carlo, 65-76 Buick LeSabre, 64-77 Buick Wildcat, 64-77 Buick Skylark, 71-73 Buick Centurion, 64-72 Buick Grand Special, 73-77 Buick Century, 73-88 Buick Regal, 73-88 Buick Grand National, 65-76 Buick Electra, 65-76 Oldsmobile Delta 88, 67-69 Oldsmobile Delmont 88, 65-66 Oldsmobile Dynamic 88, 65-66 Oldsmobile Starfire, 65 Oldsmobile Jetstar, 64-77 Oldsmobile Cutlass 442, 64-88 Oldsmobile Cutlass, 65-76 Oldsmobile 98, 65-76 Pontiac Parisienne, 64-72 Pontiac LeMans, 65-70 Pontiac Catalina, 65-66 Pontiac Star Chief, 67-70 Pontiac Executive, 71-75 Pontiac Grand Ville, 65-77 Pontiac Grand Prix, 64-72 Pontiac Tempest, 62-72 Nova, Ventura, 73-74 Non-Hatchback, Up to 1975 with groove channel, Apollo, Nova, Omega, Ventura 65-76 C-Body	2003
T		70	Trunk mat	2DR HTP 2DR SDN CNV	70 Chevrolet Chevelle, Monte Carlo	5147
T		70-71-72	Trunk mat	2DR HTP	70-72 Chevrolet Monte Carlo	5152













GUIDE TO SOFFSEAL'S PRODUCT CODES







B = Bumper sets **C** = Glass channels **D** = Door related **G** = Seals, gaskets **H** = Under hood items **I** = Interior parts
M = Miscellaneous items **R** = Roofrail, pillar post & convertible items **T** = Trunk related **W** = Window related **Z** = Weatherstrip kits

Chevrolet • Monte Carlo



CODE	IMAGE	YEAR	DESCRIPTION	BODY	FITS	ITEM#
T		75-76-77-78-79-80-81-82-83-84-85-86-87-88-89-90-91-92	Trunk and Hatchback weatherstrip	2DR 4DR SDN HTP CNV	77-85 Chevrolet Impala, 77-91 Chevrolet Caprice, 82-92 Chevrolet Camaro, 75-79 Chevrolet Nova, 78-88 Chevrolet Monte Carlo, 78-83 Chevrolet Malibu, 78-83 Pontiac LeMans, 82-92 Pontiac Firebird, 75-91 Pontiac Ventura, 77-86 Pontiac Parisienne, 77-81 Pontiac Catalina, 69-88 Pontiac Grand Prix, 64-87 Pontiac LeMans, Pontiac Grand Am, 64-77 Pontiac GTO, 73-79 Oldsmobile Omega, 77-85 Oldsmobile Delta 88, 77-84 Oldsmobile 98, 77-88 Oldsmobile Cutlass, 73-75 Buick Apollo, 76-79 Buick Skylark, 77-79 Phoenix, 73-88 Buick Regal, 77-84 Buick Electra, 77-85 Buick LeSabre, 77-78 Buick Riviera, 77-91 C-Body	2424
W		68-69-70-71-72	Quarter window seals, with steel insert	2DR HTP CNV	68-72 Chevrolet Chevelle, Oldsmobile Cutlass, Buick Skylark, Pontiac LeMans, 69-70 Chevrolet Impala, 70-72 Chevrolet Monte Carlo, 2 Door Hardtop Convertible	5112M
W		68-69-70-71-72	Quarter window seals, all rubber	2DR HTP CNV	68-72 Chevrolet Chevelle, Oldsmobile Cutlass, Buick Skylark, Pontiac LeMans, 69-70 Chevrolet Impala, 70-72 Chevrolet Monte Carlo, 2 Door Hardtop Convertible	5112R
W		70-71-72	Window weatherstrip replacement style	2DR HTP	70-72 Chevrolet Monte Carlo, 2 Door Hardtop	5132
W		70-71-72	Window weatherstrip, original style with round bead	2DR HTP	70-72 Chevrolet Monte Carlo, 2 Door Hardtop	51321
W		78-79	Window weatherstrip original style with round bead	2DR HTP	78-79 Chevrolet Monte Carlo, 2 Door Hardtop	5134
W		80-81-82-83-84-85-86-87-88	Window weatherstrip, original style with round bead	2DR HTP	80-88 Chevrolet Monte Carlo SS, 80-86 Pontiac Grand Prix With Special Moldings 2 Door Hardtop	5135
W		80-81-82-83-84-85-86-87-88	Window weatherstrip replacement style	2DR HTP	80-88 Chevrolet Monte Carlo Ls 80-87 Pontiac Grand Prix Without Special Moldings, 2 Door Hardtop	5140
Z		70	Weatherstrip kit, includes a arm seals, bumper kit, door weatherstrips, hood to cowl seal, hood to cowl clips, paint gaskets, quarter window seals, roofrail weatherstrips, trunk weatherstrip, door u jamba, window weatherstrips	2DR HTP	70 Chevrolet Monte Carlo 2 Door Hardtop	KIT525
Z		71	Weatherstrip kit, includes a arm seals, bumper kit, door weatherstrips, hood to cowl seal, hood to cowl clips, paint gaskets, quarter window seals, roofrail weatherstrips, trunk weatherstrip, door u jamba, window weatherstrips	2DR HTP	71 Chevrolet Monte Carlo 2 Door Hardtop	KIT526

Chevrolet • Monte Carlo

CODE	IMAGE	YEAR	DESCRIPTION	BODY	FITS	ITEM#
Z		72	Weatherstrip kit, includes a arm seals, bumper kit, door weatherstrips, hood to cowl seal , hood to cowl clips, paint gaskets, quarter window seals, roofrail weatherstrips, trunk weatherstrip, door u jamba, window weatherstrips	2DR HTP	72 Chevrolet Monte Carlo 2 Door Hardtop	KIT527
Z		78-79	Weatherstrip kit, includes door weatherstrips, roofrail weatherstrips, trunk weatherstrip, window weatherstrips	2DR HTP	78-79 Chevrolet Monte Carlo 2 Door Hardtop	KIT536
Z		78-79-80-81-82-83-84-85-86-87-88	Weatherstrip kit, includes door weatherstrip, roofrail weatherstrip, trunk weatherstrip	2DR HTP	78-88 Chevrolet Monte Carlo, Buick Regal, Oldsmobile Cutlass, Pontiac Grand Prix, 2 Door Hardtop	KIT539X
Z		78-79-80-81-82-83-84-85-86-87-88	Weatherstrip kit, includes door weatherstrip, roofrail weatherstrip, trunk weatherstrip	2DR HTP	78-88 Chevrolet Monte Carlo, Buick Regal, Oldsmobile Cutlass, Pontiac Grand Prix, 2 Door Hardtop	KIT539X
Z		80-81-82-83-84-85-86	Weatherstrip kit, includes door weatherstrips, roofrail weatherstrips, trunk weatherstrip, window weatherstrips	2DR HTP	80-86 Monte Carlo SS 2 Door Hardtop	KIT537
Z		80-81-82-83-84-85-86-87-88	Weatherstrip kit, includes door weatherstrips, roofrail weatherstrips, trunk weatherstrip, window weatherstrips	2DR HTP	80-88 Chevrolet Monte Carlo Ls 2 Door Hardtop	KIT538



GUIDE TO SOFFSEAL'S PRODUCT CODES

B = Bumper sets **C** = Glass channels **D** = Door related **G** = Seals, gaskets **H** = Under hood items **I** = Interior parts
M = Miscellaneous items **R** = Roofrail, pillar post & convertible items **T** = Trunk related **W** = Window related **Z** = Weatherstrip kits

Chevrolet • Monza, Vega, Beretta, Corsica, Lumina

















CODE	IMAGE	YEAR	DESCRIPTION	BODY	FITS	ITEM#
D		71-72-73-74-75-76-77	Door weatherstrip with clips	2DR SDN	71-77 Chevrolet Vega, 75-77 Pontiac Astre, 2 Door, Hatchback	8201
D		75-76-77-78-79-80	Door weatherstrip	2DR SDN	75-80 Chevrolet Monza, Oldsmobile Starfire, Buick Skyhawk, Pontiac Sunbird H-Body Coupe	8029
D		82-83-84-85-86-87-88-89-90-91-92	Door weatherstrip front/rear	All	82-89 Skyhawk 92-97 Skylark 82-88 Cimarron 93-96 Fleetwood 82-94 Beretta 82-94 Cavalier 91-96 Caprice 82-96 Corsica 82-94 Lumina 82-93 S10 83-94 S10 Blazer 82-05 Chev Van 83-94 GMC Jimmy 82-93 GMC Sonoma 82-05 GMC Van 82-94 Achieva 82-85 Custom Cruiser 82-94 Firenza 82-94 Grand Am 82-94 Sunbird	9110
M		00-99	Window weld ribbon sealer 3/8 inch round	ALL BODY STYLES	All Makes And Models	08622
M		71-72-73-74-75-76-77	Window weatherstrip replacement style	2DR SDN	71-77 Chevrolet Vega, 2 Door Sedan	8202
M		71-72-73-74-75-76-77	Door weatherstrip	2DR SDN SWG	71-77 Chevrolet Vega, 75-77 Pontiac Astre, 2 Door Sedan Station Wagon Notchback	8200
M		75-76-77-78-79-80	Door weatherstrip hatchback	2DR SDN	75-80 Chevrolet Monza, Oldsmobile Starfire, Buick Skyhawk, Pontiac Sunbird H-Body	8028

WHAT IS A PRODUCT CODE?
 Our catalog is grouped by product CODE (type) then years. See page 1 for details explaining the different Product CODES.



CHEVROLET • Monza, Vega, Beretta, Corsica, Lumina

Chevrolet • Nomad

CODE	IMAGE	YEAR	DESCRIPTION	BODY	FITS	ITEM#
B		39-40-41-42-43-44-45-46-47-48-49-50-51-52-53-54-57-64-65-66-67-68-69-70-71-72	Brake clutch pedal bumpers	2DR 4DR HTP 2DR SDN CNV SWG	39-54 And 57 Chevrolet, 55-57 Pontiac, 64-72 Chevrolet	1058
B		41-42-43-44-45-46-47-48-49-50-51-52-53-54-55-56-57	Firewall/cowl bumper, 41-48 top of firewall, 41-54 side cowl	ALL BODY STYLES	41-57 Chevrolet	0457
B		47-48-49-50-51-52-53-54-55-56-57-58-59-60-61-62-63-64-65-66-67-68-69-70-71-72-73-74-75-76-77-78-79-80-81-82-83-84-85-86-87	Glove box door bumpers	2DR 4DR HTP 2DR SDN CNV SWG TRK	All Chevrolet, Pontiac, Oldsmobile, Buick 47-87 Chevrolet, Gmc Truck	1069
B		49-50-51-52-53-54-55	Gas door bumpers	2DR 4DR HTP 2DR SDN SWG CNV	49-55 Chevrolet 150 210 Bel Air, Nomad, Pontiac, Oldsmobile	1071
B		49-50-51-52-53-54-55-56-57	Door bumpers screw in upper	2DR SDN SWG	49-57 Chevrolet 150 210 Bel Air Styleline Fleetline, Pontiac Sedan, Plus Universal Applications	1054
B		51-52-53-54-55-56-57-58	Upper vent window bumpers	2DR 4DR HTP 2DR SDN CNV SWG	51-58 Chevrolet 150 210 Bel Air Nomad Del Ray Biscayne Impala, 51-54 Chevrolet, Pontiac, Oldsmobile, Buick, Cadillac, Hardtop Convertible	1224
B		55	Hood adjustment bumpers front & rear	2DR 4DR HTP 2DR SDN CNV SWG	55 Chevrolet 150 210 Bel Air Nomad, Pontiac	1072
B		55	Hood to fender bumpers 6 piece	2DR 4DR HTP 2DR SDN CNV SWG	55 Chevrolet 150 210 Bel Air Nomad	1073
B		55-56	Seat back rest bumper	2DR 4DR HTP 2DR SDN CNV SWG	55-56 Chevrolet 150 210 Bel Air Nomad, Pontiac, Safari	1059
B		55-56	Brake clutch pedal bumper	2DR 4DR HTP 2DR SDN CNV SWG	55-56 Chevrolet 150 210 Bel Air, Pontiac, Olds	1057
B		55-56-57	Body bumper kit	2DR SDN	55-57 Chevrolet 150 210 Bel Air, Pontiac, 2 Door, Sedan	1056
B		55-56-57	Body bumper kit	2DR HTP CNV	55-57 Chevrolet 210 Bel Air, 2 Door Hardtop Convertible	1055
B		55-56-57	Door upper bumpers push in	2DR 4DR SDN	55-57 Chevrolet 150 210 Bel Air, Pontiac, Oldsmobile, Sedan	10542
B		55-56-57	Door bumpers	4DR SWG	55-57 Chevrolet 150 210 Bel Air, Pontiac, Oldsmobile, All Station Wagons, 4 Door Sedan Station Wagon	10541



















GUIDE TO SOFFSEAL'S PRODUCT CODES

B = Bumper sets **C** = Glass channels **D** = Door related **G** = Seals, gaskets **H** = Under hood items **I** = Interior parts
M = Miscellaneous items **R** = Roofrail, pillar post & convertible items **T** = Trunk related **W** = Window related **Z** = Weatherstrip kits



CODE	IMAGE	YEAR	DESCRIPTION	BODY	FITS	ITEM#
B		55-56-57	Trunk bumpers	2DR 4DR HTP 2DR SDN CNV	55-57 Chevrolet 150 210 Bel Air, Pontiac	1052
B		55-56-57	Quarter window bumpers	CNV	55-57 Chevrolet Bel Air, Convertible	1221
B		55-56-57	Clutch pedal rebound bumper	2DR SDN 2DR 4DR HTP CNV SWG	55-57 Chevrolet, Pontiac	1096
B		55-56-57	Tailgate bumpers	SWG	55-57 Chevrolet Nomad, Pontiac Safari	1229
B		55-56-57	Tailgate liftgate bumpers	SWG	55-57 Chevrolet 150 210 Bel Air, Pontiac, Station Wagon	1227
B		55-56-57-58	Door bumpers	2DR 4DR HTP 2DR SDN CNV SWG	55-58 Chevrolet, Pontiac, Olds	1053
B		55-56-57-58-59	Upper trunk or rear license plate bumper	2DR 4DR HTP 2DR SDN CNV SWG	55-59 Chevrolet 150 210 Bel Air Nomad, Pontiac, Olds	10521
B		56-57	Door bumpers	4DR HTP	56-57 Chevrolet 210 Bel Air, Pontiac, Oldsmobile, 4 Door Hardtop	10543
B		56-57	Hood to fender bumpers	2DR 4DR HTP 2DR SDN CNV SWG	56-57 Chevrolet 150 210 Bel Air Nomad	1223
B		56-57-58-59-60- 61-62-63-64-65- 66-67-68-69- 70-71-72-73-74	Hood adjustment bumpers round	2DR 4DR HTP 2DR SDN CNV SWG	56-74 Chevrolet, Pontiac, All Models	1222
B		57	Seat back rest bumpers	2DR 4DR HTP 2DR SDN CNV SWG	57 Chevrolet 150 210 Bel Air Nomad, Pontiac, Safari, Oldsmobile	1061
C		55	Rear glass channel	2DR 4DR SDN	55 Chevrolet 210 Bel Air, Pontiac 2 Door 4 Door Sedan	1203
C		55-56-57	Glass channel rear side window curved	2DR SWG	55-57 Chevrolet, Pontiac, Except Nomad And Safari, 2 Door Station Wagon	1121
C		55-56-57	Back glass gasket	SWG	55-57 Chevrolet Nomad Pontiac Safari, Station Wagon	1203C
C		55-56-57	Glass channel rear side window curved 4 door station wagon	SWG 4DR	55-57 Chevrolet, Pontiac, 4 Door Station Wagon	1120

Chevrolet • Nomad

CODE	IMAGE	YEAR	DESCRIPTION	BODY	FITS	ITEM#
C		59-60	Rear quarter stationary vent window seal	SWG 2DR 4DR	59-60 Chevrolet Nomad, Brookwood, Kingswood, Buick LeSabre, Invicta, Oldsmobile Fiesta 88, Pontiac Catalina, Bonneville, Safari 2 Door 4 Door Station Wagon	2218
D		55-56-57	Upper gate auxiliary seal	SWG	55-57 Chevrolet Nomad, Pontiac Safari	1065
D		55-56-57	Upper gate weatherstrip with clips & molded ends	SWG	55-57 Chevrolet 150 210 Bel Air, Pontiac, Station Wagon	1228
D		55-56-57	Door weatherstrip with clips and molded ends	SWG	55-57 Chevrolet Nomad, Pontiac Safari	1002
D		55-56-57	Door weatherstrip with clips with out molded ends	2DR HTP CNV	55-57 Chevrolet, Pontiac, 2 Door Hardtop Convertible	1001
D		55-56-57	Door weatherstrip with clips & molded ends	2DR HTP CNV	55-57 Chevrolet, Pontiac, 2 Door Hardtop Convertible	1000
D		55-56-57	Lower gate weatherstrip with clips & molded corner	SWG	55-57 Chevrolet Nomad, Pontiac Safari	1225
D		55-56-57	Upper gate weatherstrip	SWG	55-57 Chevrolet Nomad, Pontiac Safari	1225A
D		55-56-57	Door j weatherstrip with clips	2DR 4DR HTP 2DR SDN CNV SWG	55-57 Chevrolet, Pontiac, All Models	1204
D		55-56-57	Lower gate weatherstrip with clips & molded corner	SWG	55-57 Chevrolet 150 210 Bel Air, Pontiac Station Wagon	1226
D		55-56-57-58-59-60	Door weatherstrip rear with clips	SWG	55-57 Chevrolet Bel Air 150 210 55-56 Pontiac Chieftain 860 870, Star Chief, 58-60 Chevrolet Sedan Delivery	1230
D		55-56-57-58-59-60	Door weatherstrip with clips sedan front and rear	2DR 4DR SDN SWG	55-60 Chevrolet Bel Air 150 210, Nomad, Pontiac Chieftain, Star Chief, Safari, Super Chief, Bonneville, Buick Century, Roadmaster, Special Also Station Wagon And Sedan Delivery	1003
D		56-57	Front door weatherstrip with clips & molded ends	4DR HTP	56-57 Chevrolet 210 Bel Air, Pontiac, 4 Door Hardtop	1005
D		56-57	Rear door weatherstrip with clips & molded ends	4DR HTP	56-57 Chevrolet 210 Bel Air, Pontiac, 4 Door Hardtop	1004
D		59-60	Door j weatherstrip	2DR 4DR HTP SWG 2DR SDN 4DR SDN	59-60 Chevrolet, Pontiac, Oldsmobile, Buick, Cadillac	2093
D		61-62	Door weatherstrip front with clips	SWG 4 DR SDN	61-62 Chevrolet BelAir, Biscayne, Impala, Pontiac, Station Wagon & 4 Dr Sedan	2019





GUIDE TO SOFFSEAL'S PRODUCT CODES

B = Bumper sets **C** = Glass channels **D** = Door related **G** = Seals, gaskets **H** = Under hood items **I** = Interior parts
M = Miscellaneous items **R** = Roofrail, pillar post & convertible items **T** = Trunk related **W** = Window related **Z** = Weatherstrip kits



CODE	IMAGE	YEAR	DESCRIPTION	BODY	FITS	ITEM#
G		38-39-40-41-42-43-44-45-46-47-48-49-50-51-52-53-54-55-56-57-58-59-60-61-62-63-64-65-66	Gas tank sending unit gasket	2DR 4DR HTP 2DR SDN CNV SWG	38-60 Chevrolet, Pontiac, Oldsmobile, 47-66 Chevrolet Gmc Truck	10522
G		49-50-51-52-53-54-55-56	Door jam switch gasket	2DR 4DR HTP 2DR SDN CNV SWG	49-56 Chevrolet 150 210 Bel Air Nomad, Pontiac Safari, Oldsmobile	1060
G		55	Anti-squeak fender kit	2DR 4DR HTP 2DR SDN CNV SWG	55 Chevrolet 150 210 Bel Air Nomad	1074
G		55	Rear body to bumper seal	2DR SDN 2DR 4DR HTP CNV SWG	55 Chevrolet 150, 210 Bel Air, Nomad	1070
G		55-56	Steering column seal standard inner	2DR 4DR HTP 2DR SDN CNV SWG	55-56 Chevrolet 150 210 Nomad Bel Air, Pontiac	1215
G		55-56	Steering column seal auto inner	2DR 4DR HTP 2DR SDN CNV SWG	55-56 Chevrolet 150 210 Nomad Bel Air, Pontiac	1214
G		55-56	Deluxe heater seal kit	2DR 4DR HTP 2DR SDN CNV SWG	55-56 Chevrolet 150 210 Bel Air Nomad	1083
G		55-56	Anti-squeak hood kit	2DR 4DR HTP 2DR SDN CNV SWG	55-56 Chevrolet 150 210 Bel Air Nomad	1093
G		55-56-57	Steering column seal auto sponge	2DR 4DR HTP 2DR SDN CNV SWG	55-57 Chevrolet 150 210 Nomad Bel Air, Pontiac	1213
G		55-56-57	Chevy Steering Column Firewall Seal, Standard Transmission	2DR 4DR HTP 2DR SDN CNV SWG	55-57 Chevrolet 150 210 Nomad Bel Air, Pontiac	1216
G		55-56-57	Gas tank o ring	2DR 4DR HTP 2DR SDN CNV SWG	55-57 Chevrolet 150 210 Bel Air Nomad	10523
G		56	Taillight, lower seal fits between inner body bezel	2DR 4DR HTP 2DR SDN CNV SWG	56 Chevrolet 150 210 Bel Air Nomad	1085
G		56	Anti-squeak fender kit	2DR 4DR HTP 2DR SDN CNV SWG	56 Chevrolet 150 210 Bel Air Nomad	1092
G		56-57	56 taillight, door seals, 57 headlight, bezel seals	2DR 4DR HTP 2DR SDN CNV SWG	56-57 Chevrolet 150 210 Bel Air Nomad	1091

Chevrolet • Nomad

CODE	IMAGE	YEAR	DESCRIPTION	BODY	FITS	ITEM#
G		56-58	Rear body to bumper seal	2DR 4DR HTP 2DR SDN CNV SWG	56, 58 Chevrolet	1090
G		57	Steering column seal standard inner	2DR 4DR HTP 2DR SDN CNV SWG	57 Chevrolet 150 210 Nomad Bel Air, Pontiac	1215A
G		57	Steering column seal auto inner	2DR 4DR HTP 2DR SDN CNV SWG	57 Chevrolet 150 210 Nomad Bel Air, Pontiac	1214A
G		57	License lens gasket	2DR 4DR HTP 2DR SDN CNV SWG	57 Chevrolet 150 210 Bel Air Nomad	1237
G		57-58-59-60	Inner to outer fender seals	2DR 4DR HTP 2DR SDN CNV SWG	57-60 Chevrolet	1103
G		58	Steering column seal sponge	2DR 4DR HTP 2DR SDN CNV SWG SR	58 Chevrolet Pontiac, Universal Fit Street Rod And Custom, Standard Transmission	2056A
G		58	Steering column seal with automatic trans	2DR 4DR HTP 2DR SDN CNV SWG	58 Chevrolet Pontiac	2056
G		58	Door handle & lock gaskets	2DR 4DR HTP 2DR SDN SWG CNV	58 Chevrolet Pontiac	2059
G		59	Door handle & lock gaskets	2DR 4DR HTP 2DR SDN CNV SWG	59 Chevrolet Pontiac	2073
H		55-56	Hood to cowl seal clips	2DR 4DR HTP 2DR SDN CNV SWG	55-56 Chevrolet 150 210 Bel Air Nomad, Pontiac Safari, Oldsmobile, Chevrolet, Gmc Truck	1081
H		55-56-57	Firewall grommet	2DR 4DR HTP 2DR SDN SWG CNV	55-57 Chevrolet All, Pontiac, Olds	1026
H		55-56-57-58-59	Hood to cowl seal	2DR 4DR HTP 2DR SDN SWG CNV TRK	55-56 Chevrolet, Pontiac, Oldsmobile, 55-59 Chevrolet, Gmc Truck	1080
H		56	A-arm seals with cloth backing	2DR 4DR HTP 2DR SDN CNV SWG	56 Chevrolet 150 210 Bel Air Nomad	1082
H		56-57-58-59-60	Firewall grommet main wiring harness	2DR 4DR HTP 2DR SDN 2DR SDN SWG CNV	56-60 Chevrolet, Pontiac, Olds	1027



















GUIDE TO SOFFSEAL'S PRODUCT CODES					
B = Bumper sets	C = Glass channels	D = Door related	G = Seals, gaskets	H = Under hood items	I = Interior parts
M = Miscellaneous items	R = Roofrail, pillar post & convertible items	T = Trunk related	W = Window related	Z = Weatherstrip kits	



CODE	IMAGE	YEAR	DESCRIPTION	BODY	FITS	ITEM#
H		57	A-arm seals with staples	2DR 4DR HTP 2DR SDN CNV SWG	57 Chevrolet 150 210 Bel Air Nomad	1084
H		57	Hood to cowl seal clips & screws	2DR 4DR HTP 2DR SDN CNV SWG	57 Chevrolet 150 210 Bel Air	1102
H		57	Hood to cowl seal	2DR 4DR HTP 2DR SDN CNV SWG	57 Chevrolet 150 210 Bel Air	1101
H		58	Hood to fender bumpers	2DR 4DR SDN HTP CNV	58 Chevrolet	2086
H		60	A-arm seals without clips	2DR 4DR HTP 2DR SDN CNV SWG	60 Chevrolet Biscayne, Biscane Fleetmaster, Bel Air, Impala, Brookwood, Parkwood, Kingswood, Nomad, El Camino	2100
I		55-56-57- 61-62-63-64	Glove box arm grommet	2DR 4DR HTP 2DR SDN CNV SWG	55-57 And 61-64 Chevrolet, Pontiac, Oldsmobile All	10691
M		55	Firewall pad	2DR 4DR HTP SDN CNV SWG	55 Chevrolet 150 210 Bel Air Nomad, 2 Door 4 Door Hardtop Sedan Convertible Station Wagon	1232
M		55-56	Firewall pad seal	2DR 4DR HTP SDN CNV SWG	55-56 Chevrolet 150 210 Bel Air Nomad, 2 Door 4 Door Hardtop Sedan Convertible Station Wagon	1235
M		55-56-57	Accelerator pedal	2DR 4DR HTP SDN CNV SWG	55-57 Chevrolet 150 210 Bel Air Nomad, Pontiac, 55-57 Corvette, 2 Door 4 Door Hardtop Sedan Convertible Station Wagon	1050
M		55-56-57	Radiator core support bushing kit	2DR 4DR HTP SDN CNV SWG	55-57 Chevrolet 150 210 Bel Air Nomad, 2 Door 4 Door Hardtop Sedan Convertible Station Wagon	1209
M		55-56-57	Body to frame mounts	2DR SDN SWG	55-57 Chevrolet 2 Door 4 Door Sedan, Nomad, Pontiac Safari, Oldsmobile	1206
M		55-56-57-58-59	Motor mounts biscuits 8 in set	2DR 4DR HTP 2DR SDN CNV SWG TRK	55-57 Chevrolet All, 55-59 Chevrolet, Gmc Truck	1208
M		55-56-57-59-60-61	Gear tube grommet	2DR 4DR HTP SDN CNV SWG	55-57 And 59-60 Chevrolet Pontiac, Oldsmobile, 60-61 Chevrolet Truck, Gmc Truck, 2 Door 4 Door Hardtop Sedan Convertible Station Wagon	1095
M		56	Firewall pad	2DR 4DR HTP SDN SWG CNV	56 Chevrolet 150 210 Bel Air Nomad, 2 Door 4 Door Hardtop Sedan Station Wagon Convertible	1233
M		57	Firewall pad	2DR 4DR HTP SDN CNV SWG	57 Chevrolet 150 210 Bel Air Nomad, 2 Door 4 Door Hardtop Sedan Convertible Station Wagon	1234
M		57	Bumper guard bullets	2DR 4DR HTP SDN CNV SWG	57 Chevrolet 150 210 Bel Air Nomad, 2 Door 4 Door Hardtop Sedan Convertible Station Wagon	1076

Chevrolet • Nomad





CODE	IMAGE	YEAR	DESCRIPTION	BODY	FITS	ITEM#
M		57	Firewall pad seal	2DR SDN 4DR HTP	57 Chevrolet 150 210 Bel Air Nomad, 2 Door Sedan 4 Door Hardtop	1236
M		57	Blower motor sleeve	2DR 4DR HTP SDN CNV SWG	57 Chevrolet, All Except A/C Models, 2 Door 4 Door Hardtop Sedan Convertible Station Wagon	1116
R		55-56-57	Roofrail weatherstrips	SWG	55-57 Chevrolet Nomad, Pontiac Safari Station Wagon	1035
R		55-56-57	Header seal	CNV	55-57 Chevrolet Bel Air, Pontiac Convertible	1031
R		55-56-57-58	Windshield Pillar post seals with clips	2DR HTP CNV SWG	55-58 Chevrolet, Nomad, Pontiac Safari, Hardtop Convertible	1231
R		56-57	Roofrail weatherstrip	4DR HTP	56-57 Chevrolet 210 Bel Air, Pontiac, 4 Door Hardtop	1028
T		55-56	Trunk weatherstrip	2DR 4DR HTP 2DR SDN CNV	55-56 Chevrolet 150, Chevrolet 210, Chevrolet Bel Air, Chevrolet Nomad, Oldsmobile 98, Pontiac Chieftan, Pontiac 860, Pontiac 870, Pontiac Super Chief, Pontiac Bonneville, Pontiac Star Chief, Pontiac Safari	6012
T		55-56-57	Spare tire well plugs	2DR 4DR HTP 2DR SDN CNV	55-57 Chevrolet 150 210 Bel Air, Pontiac Chieftan, Starchief, Super Chief, Oldsmobile	1219
T		55-56-57	Trunk area access plugs	2DR 4DR HTP 2DR SDN CNV	55-57 Chevrolet 150 210 Bel Air, Pontiac	1218
T		55-56-57	Trunk mat	CNV	55-57 Chevrolet Bel Air, Pontiac, Convertible	1217A
T		55-56-57	Trunk mat	2DR 4DR HTP 2DR SDN 4DR SDN	55-57 Chevrolet 150 210 Bel Air, Pontiac, Hardtop Sedan	1217
T		57	Trunk weatherstrip with clips	2DR 4DR HTP 2DR SDN CNV	57 Chevrolet, Pontiac Except Star Chief	1011
W		37-38-39-40-41-42-43-44-45-46-47-48-49-50-51-52-53-54	Mohair channel liner, 4 feet of 2 7/8 inch mohair lining material	CNV 2DR 4DR HTP	Bel Air 150 210, Nomad, Chieftan, 860/870 Star Chief, Safari, Super Chief, Bonneville, Nova, Omega, Apollo, Ventura, Skylark	0420
W		55-56-57	Cozy vent seals	2DR SDN 4DR SDN SWG	55-57 Chevrolet, Pontiac, 2 Door And 4 Door Sedan And Station Wagon Except Nomad And Safari	1033
W		55-56-57	Cozy vent seals	2DR 4DR HTP CNV	55-57 Chevrolet All, Nomad, Pontiac All, Safari, 2 Door 4 Door Hardtop Convertible	1032
W		55-56-57	Vertical seal side sliding window	SWG	55-57 Chevrolet Nomad, Pontiac Safari, Station Wagon	1125
W		55-56-57	Window weatherstrip with division bar & window channel replacement style	SWG	55-57 Chevrolet Nomad, Pontiac Safari, Station Wagon	1047



GUIDE TO SOFFSEAL'S PRODUCT CODES

B = Bumper sets **C** = Glass channels **D** = Door related **G** = Seals, gaskets **H** = Under hood items **I** = Interior parts
M = Miscellaneous items **R** = Roofrail, pillar post & convertible items **T** = Trunk related **W** = Window related **Z** = Weatherstrip kits



CODE	IMAGE	YEAR	DESCRIPTION	BODY	FITS	ITEM#
G		56-58	Rear body to bumper seal	2DR 4DR HTP 2DR SDN CNV SWG	56, 58 Chevrolet	1090
G		58	Steering column seal with automatic trans	2DR 4DR HTP 2DR SDN CNV SWG	58 Chevrolet Pontiac	2056
G		58	Steering column seal sponge	2DR 4DR HTP 2DR SDN CNV SWG SR	58 Chevrolet Pontiac, Universal Fit Street Rod And Custom, Standard Transmission	2056A
G		58	Door handle & lock gaskets	2DR 4DR HTP 2DR SDN SWG CNV	58 Chevrolet Pontiac	2059
H		58	Hood to fender bumpers	2DR 4DR SDN HTP CNV	58 Chevrolet	2086

Chevrolet GM GMC • Truck, Van, SUV

CODE	IMAGE	YEAR	DESCRIPTION	BODY	FITS	ITEM#
B		47-48-49-50-51	Door bumpers 4 piece	TRK	47-51 Chevrolet, Gmc Truck	9060
B		47-48-49-50-51-52-53-54-55-56-57-58-59-60-61-62-63-64-65-66-67-68-69-70-71-72-73-74-75-76-77-78-79-80-81-82-83-84-85-86-87	Glove box door bumpers	2DR 4DR HTP 2DR SDN CNV SWG TRK	All Chevrolet, Pontiac, Oldsmobile, Buick 47-87 Chevrolet, Gmc Truck	1069
B		52-53-54-55	Door bumpers 4pc	TRK	52-55 Chevrolet, Gmc Truck	9059
B		55-56-57-58-59	Door bumpers 2nd series	TRK	55-59 Chevrolet, Gmc Truck	9058
B		60-61	Hood bumper kit, 4 piece	TRK	60-61 Chevrolet, Gmc Ck10-30	9818
B		60-61-62-63-64-65-66	Front hood bumpers	TRK	60-66 Chevrolet, Gmc Truck Stepside C&K 10-30	9016
B		60-61-62-63-64-65-66-67-68-69-70-71-72	Door bumpers	TRK	60-72 Chevrolet, Gmc Truck Stepside C&K 10-30	9053
B		62-63-64-65-66	Hood bumper kit, 10 piece	TRK	62-66 Chevrolet, Gmc Ck10-30	9819
B		67-68-69-70-71-72	Hood adjustment bumpers with adjustment screws	TRK	67-72 Chevrolet, Gmc Series 10, 20 And 30 Trucks, 69-72 Blazer	9824
B		67-68-69-70-71-72	Upper tailgate bumper	TRK	67-72 Chevrolet, Gmc Truck	9851
B		67-68-69-70-71-72-73-74-75-76-77-78-79-80-81-82-83-84-85-86-87	Lower tailgate bumpers	TRK	67-87 Chevrolet, Gmc Truck, 69-72 Blazer	9811
B		67-68-69-70-71-72	Hood to fender bumpers	TRK	67-72 Chevrolet, Gmc Truck, Blazer Series 10-30 Stepside C&K 10-30	9041
B		73-74-75-76-77-78-79-80-81-82-83-84-85-86-87	Hoodside bumpers 4 piece	TRK	73-87 Chevrolet, Gmc Truck, 73-91 Suburban, Blazer	9001
B		73-74-75-76-77-78-79-80-81-82-83-84-85-86-87-88-89-90-91	Door bumpers	TRK	73-87 Chevrolet, Gmc Pickup, 73-91 Gmc Suburban, Blazer	9054
B		73-74-75-76-77-78-79-80-81-82-83-84-85-86-87-88-89-90-91	Hood adjustment bumpers with adjustment screws	TRK	73-81 Chevrolet, Gmc Series 10, 20 And 30 Trucks, Blazer, 73-91 Suburban	9825
B		79-80-81-82-83-84-85-86-87	Gas door bumper	TRK	79-87 Chevrolet, Gmc Truck	9840



GUIDE TO SOFFSEAL'S PRODUCT CODES

B = Bumper sets **C** = Glass channels **D** = Door related **G** = Seals, gaskets **H** = Under hood items **I** = Interior parts
M = Miscellaneous items **R** = Roofrail, pillar post & convertible items **T** = Trunk related **W** = Window related **Z** = Weatherstrip kits

Chevrolet GM GMC • Truck, Van, SUV



CODE	IMAGE	YEAR	DESCRIPTION	BODY	FITS	ITEM#
B		82-83-84-85-86-87	Front hood bumpers	TRK	82-87 Chevrolet, Gmc Pickup Full Size	9826
C		42-43-44-45-46-47-48-49-50-51-52-53-54-55-56-57-58-59-60-61-62-63-64-65-66	Rear glass	TRK	42-66 Chevrolet, Gmc Truck Standard	9920
C		47-48-49-50-51-52-53	Front windshield	TRK	47-53 Chevrolet, Gmc Truck Standard	9906
C		47-48-49-50-51-52-53	Front windshield, custom	TRK	47-53 Chevrolet, Gmc Truck	9907
C		47-48-49-50-51-52-53	Three window rear glass	TRK	47-53 Chevrolet, Gmc Truck	9901
C		54-55	Front windshield	TRK	54-55 Chevrolet, Gmc Truck Standard	9908
C		54-55	Front windshield, custom	TRK	54-55 Chevrolet, Gmc	9909
C		55-56	Large rear glass custom with chrome lockstrip	TRK	55-66 Chevrolet, Gmc Truck, Custom	9949
C		55-56-57-58-59	Front window	TRK	55-59 Chevrolet, Gmc Truck Standard	9924
C		55-56-57-58-59	Front windshield, custom	TRK	55-59 Chevrolet, Gmc Truck	9925
C		55-56-57-58-59-60-61-62-63-64-65-66	Large rear glass standard with black lockstrip	TRK	55-66 Chevrolet, Gmc Truck Standard	9948
C		60-61-62-63	Windshield rubber	TRK	60-63 Chevrolet, Gmc Truck Standard	9926
C		60-61-62-63	Windshield rubber	TRK	60-63 Chevrolet, Gmc Truck Standard	9927
C		64-65-66	Windshield rubber	TRK	64-66 Chevrolet, Gmc Truck Standard	9936
C		64-65-66	Windshield rubber	TRK	64-66 Chevrolet, Gmc Truck Custom	9937
C		67-68-69-70-71-72	Windshield rubber, no chrome	TRK	67-72 Chevrolet, Gmc Truck	9914
C		67-68-69-70-71-72	Rear window weatherstrip, small	TRK	67-72 Chevrolet, Gmc Full Size Pick Up	9921
C		67-68-69-70-71-72	Rear glass channel, large window, with o chrome	TRK	67-72 Chevrolet, Gmc Truck	9916

Chevrolet GM GMC • Truck, Van, SUV

CODE	IMAGE	YEAR	DESCRIPTION	BODY	FITS	ITEM#
C		67-68-69-70-71-72	Rear glass channel, large window, with chrome	TRK	67-72 Chevrolet, Gmc Truck	9918
C		67-68-69-70-71-72	Windshield gasket with chrome only	TRK	67-72 Chevrolet, Gmc Truck Stepside C&K 10-30	9032
C		71-72	Windshield gasket with chrome	TRK	71-72 Chevrolet, Gmc Truck Stepside C&K 10-30	9033
C		73-74-75-76-77-78-79-80-81-82-83-84-85-86-87	Windshield with black trim	TRK	73-87 Chevrolet, Gmc Truck, Blazer, Suburban	9915
C		73-74-75-76-77-78-79-80-81-82-83-84-85-86-87	Rear glass channel, no trim	TRK	73-87 Chevrolet, Gmc Truck, Blazer, Suburban	9917
C		73-74-75-76-77-78-79-80-81-82-83-84-85-86-87	Front windshield channel, no trim	TRK	73-87 Chevrolet Truck, Blazer And Suburban, Gmc Truck	9912
C		73-74-75-76-77-78-79-80-81-82-83-84-85-86-87	Rear glass channel with chrome trim	TRK	73-87 Chevrolet Truck, Gmc Truck	9919
C		73-74-75-76-77-78-79-80-81-82-83-84-85-86-87	Windshield with chrome	TRK	73-87 Chevrolet, Gmc Truck, Blazer, Suburban	9913
C		76-77-78-79-80-81-82-83-84-85-86-87-88-89-90-91	Rear quarter window seal, lh or rh	TRK	76-91 Chevrolet, Gmc Suburban	9069
C		76-77-78-79-80-81-82-83-84-85-86-87-88-89-90-91	Rear side window seal with o deep tinted glass	TRK	76-91 Chevrolet Blazer, Gmc Jimmy	9075
C		80-81-82-83-84-85-86-87-88-89-90-91	Rear side sliding window seal	TRK	80-91 Chevrolet Blazer, Gmc Jimmy	9071
C		80-81-82-83-84-85-86-87-88-89-90-91	Rear stationary window seal, sliding side glass	TRK	80-91 Chevrolet Blazer, Gmc Jimmy	9072
C		81-82-83-84-85-86-87-88-89-90-91	Rear side window seal with deep tinted glass	TRK	81-91 Chevrolet Blazer, Gmc Jimmy	9070
D		47-48	Door weatherstrip, attaches to cab	TRK	47-48 Chevrolet, Gmc Truck	9973
D		47-48-49-50-51-52-53-54-55	Weatherstrip door set premium seal with adhesive backing	TRK	47-55 Chevrolet, Gmc Truck, 1st Series	9971
D		55-56-57-58-59	Door weatherstrip with clips	TRK	55-59 Chevrolet, Gmc Truck	9005
D		60-61-62-63-64-65-66	Door weatherstrip	TRK	60-66 Chevrolet, Gmc Truck	9008
D		67-68-69-70-71-72	Door weatherstrip	TRK	67-72 Chevrolet, Gmc Truck	9009



GUIDE TO SOFFSEAL'S PRODUCT CODES						
B = Bumper sets	C = Glass channels	D = Door related	G = Seals, gaskets	H = Under hood items	I = Interior parts	
M = Miscellaneous items	R = Roofrail, pillar post & convertible items		T = Trunk related	W = Window related	Z = Weatherstrip kits	

Chevrolet GM GMC • Truck, Van, SUV



CODE	IMAGE	YEAR	DESCRIPTION	BODY	FITS	ITEM#
D		68-69-70-71-72	Door weatherstrip with clips	2DR SDN	68-72 Chevrolet El Camino, 72 Gmc Sprint	5032
D		73-74-75-76-77-78-79-80-81	Tailgate seal lower	TRK	73-81 Chevrolet Blazer, Gmc Jimmy	9083
D		73-74-75-76-77-78-79-80-81-82-83-84-85-86-87	Upper door weatherstrip, on door	TRK	73-87 Chevrolet, Gmc Truck	9352
D		73-74-75-76-77-78-79-80-81-82-83-84-85-86-87-88-89-90-91	Tailgate weatherstrip	TRK	73-91 Chevrolet Blazer, Gmc Jimmy	9081
D		73-74-75-76-77-78-79-80-81-82-83-84-85-86-87-88-89-90-91	Door weatherstrip front & rear	TRK	73-91 Full size Gm C10-C30, Gmc 1500-3500, Blazer, Jimmy, Suburban	9010
D		74-75-76-77-78-79-80-81-82-83-84-85-86-87-88-89-90-91-92-93-94	Slider door weatherstrip with clips	TRK	74-94 Chevrolet, Gm Series 10 20 30 Van	9501
D		74-75-76-77-78-79-80-81-82-83-84-85-86-87-88-89-90-91-92-93-94	Hinged side door weatherstrip right side with clips	TRK	74-94 Chevrolet, Gmc Series 10 20 30 Van	9504R
D		74-75-76-77-78-79-80-81-82-83-84-85-86-87-88-89-90-91-92-93-94	Hinged side door weatherstrip left side with clips	TRK	74-94 Chevrolet, Gmc 10 20 30 Van	9504L
D		75-76-77-78-79-80-81-82-83-84-85-86-87-88-89-90-91	Upper tailgate seal	TRK	75-91 Chevrolet, Gmc Suburban	9068
D		75-76-77-78-79-80-81-82-83-84-85-86-87-88-89-90-91-92-93-94	Door weatherstrip with clips, front door, right, side	TRK	75-94 Chevrolet, Gmc Series 10, 20, 30 Van	9500R
D		75-76-77-78-79-80-81-82-83-84-85-86-87-88-89-90-91-92-93-94	Door weatherstrip with clips, front door, left side	TRK	75-94 Chevrolet, Gmc Series 10 20 30 Van	9500L
D		76-77-78-79-80-81-82-83-84-85-86-87-88-89-90-91	Rear cab seal	TRK	76-91 Chevrolet Blazer, Gmc Jimmy	9079
D		77-78-79-80-81-82-83-84-85-86-87-88-89-90-91-92-93-94	Door weatherstrip right side rear cargo with clips	TRK	77-94 Chevrolet, Gmc Series 10 20 30 Van	9502R
D		77-78-79-80-82-83-84-85-86-87-88-89-90-91-92-93-94	Door weatherstrip left side rear cargo with clips	TRK	77-94 Chevrolet, Gmc Series 10 20 And 30 Van	9502L
D		79-80-81-82-83-84-85-86-87-88-89-90-91	Rear door seal, upper with clips	TRK	79-91 Chevrolet, Gmc Suburban With Cargo Doors	9065

Chevrolet GM GMC • Truck, Van, SUV

CODE	IMAGE	YEAR	DESCRIPTION	BODY	FITS	ITEM#
D		82-83-84-85-86-87-88-89-90-91-92	Door weatherstrip front/rear	All	82-89 Skyhawk 92-97 Skylark 82-88 Cimarron 93-96 Fleetwood 82-94 Beretta 82-94 Cavalier 91-96 Caprice 82-96 Corsica 82-94 Lumina 82-93 S10 83-94 S10 Blazer 82-05 Chev Van 83-94 GMC Jimmy 82-93 GMC Sonoma 82-05 GMC Van 82-94 Achieva 82-85 Custom Cruiser 82-94 Firenza 82-94 Grand Am 82-94 Sunbird	9110
D		85-86-87-88-89-90-91-92-93-94-95-96-97	Door weatherstrip	TRK	85-97 Chevrolet Astro	9999
D		88-89-90-91-92-93-94-95-96-97-98-99-00-01	Door weatherstrip	TRK	88-01 Chevrolet, Gmc Fullsize Truck, 2 Door, Excludes 88-91 Blazer	9113
D		94-95-96-97-98-99-00-01-02	Door weatherstrip	TRK	94-2002 Chevrolet S10 Gmc S15	9114
G		38-39-40-41-42-43-44-45-46-47-48-49-50-51-52-53-54-55-56-57-58-59-60-61-62-63-64-65-66	Gas tank sending unit gasket	2DR 4DR HTP 2DR SDN CNV SWG	38-60 Chevrolet, Pontiac, Oldsmobile, 47-66 Chevrolet Gmc Truck	10522
G		47-48-49-50-51-52-53-54-55	Steering column to firewall seal, 1 1/4 in column	TRK SR	47-55 Chevrolet, GMC Truck, Except 4-Speed, Universal and Street Rod Fit	9137
G		52-53-54-55-56-57-58-59	Door handle gaskets	TRK	52-59 Chevrolet, Gmc Truck	9408
G		60-61-62-63-64-65-66	Door handle & lock gasket set	ALL BODY STYLES	60-66 Chevrolet, Gmc Truck	9015
G		60-61-62-63-64-65-66	Front parking light, direct signal lens	ALL BODY STYLES	60-66 Chevrolet, Gmc Truck	9014
G		60-61-62-63-64-65-66	Backup light lens gaskets	ALL BODY STYLES	60-66 Chevrolet, Gmc Fleetside Truck	9012
G		60-61-62-63-64-65-66	Taillight lens gaskets	ALL BODY STYLES	60-66 Chevrolet, Gmc Fleetside Truck	9013
G		67-68-69-70-71-72	Taillight lens gaskets	TRK	67-72 Chevrolet, GMC, Truck, Fleetside	9342
G		67-68-69-70-71-72	Reverse light lens gaskets	TRK	67-72 Chevrolet, Gmc Truck, Fleetside Bed, Fleetside Stepside	9341
G		67-68-69-70-71-72	Door handle & lock cyl gaskets	TRK	67-72 Chevrolet, Gmc Truck	9020
G		68-69-70-71-72	Rear body seal	2DR SDN	68-72 Chevrolet El Camino, Sprint	5084
G		73-74-75-76-77-78-79-80	Paint gasket set	TRK	73-80 Chevrolet, Gmc Fleetside Stepside C&K 10-30	9346



GUIDE TO SOFFSEAL'S PRODUCT CODES















B = Bumper sets **C** = Glass channels **D** = Door related **G** = Seals, gaskets **H** = Under hood items **I** = Interior parts
M = Miscellaneous items **R** = Roofrail, pillar post & convertible items **T** = Trunk related **W** = Window related **Z** = Weatherstrip kits

Chevrolet GM GMC • Truck, Van, SUV



CODE	IMAGE	YEAR	DESCRIPTION	BODY	FITS	ITEM#
G		73-74-75-76-77-78-79-80	Front parking lamp lens gaskets	TRK	73-80 Chevrolet, Gmc Pickup, Blazer C&K 10-30	9343
G		73-74-75-76-77-78-79-80-81-82-83-84-85-86-87	Door handle & lock gasket set	TRK	73-87 Chevrolet, Gmc Pickup, Blazer, Suburban C&K 10-30	9345
G		73-74-75-76-77-78-79-80-81-82-83-84-85-86-87	Fleetside taillight lens gaskets	TRK	73-87 Chevrolet, Gmc Pickup, Blazer C&K 10-30	9344
G		78-79-80-81-82-83-84-85-86-87	Rear side marker gasket	SWG	78-87 Chevrolet El Camino, Gmc Caballero, 78-83 Chevrolet Malibu Wagon, 82-83 Pontiac Bonneville Wagon, 78-81 Pontiac LeMans Wagon, Oldsmobile Cutlass Wagon, 82-86 Oldsmobile Cutlass 4 Door Except Fwd, 78-82 Buick Century Wagon, Station Wagon	5214
H		47-48-49-50-51-52-53-54-55	Hood to cowl seal with fasteners 1st series	TRK	47-55 Chevrolet, Gmc 3100, 3600, 3800	9066
H		55-56-57-58-59	Hood to cowl seal	2DR 4DR HTP 2DR SDN SWG CNV TRK	55-56 Chevrolet, Pontiac, Oldsmobile, 55-59 Chevrolet, Gmc Truck	1080
H		60-61-62-63-64-65-66	Hood to cowl seal	TRK	60-66 Chevrolet, Gmc Truck Stepside C&K 10-30	9017
H		67-68-69-70-71-72	Hood to cowl	TRK	69-72 Blazer	9410
H		73-74-75-76-77-78-79-80	Hood to cowl seal	TRK	73-80 Chevrolet, Gmc Truck	9031
H		81-82-83-84-85-86-87	Hood to cowl seal	TRK	81-91 Chevrolet Suburban, 81-87 Chevrolet, Gmc Truck	9405
I		67-68-69-70-71-72	Clutch & brake pads	TRK	67-72 Chevrolet Gmc Stepside C&K 10-30	9050
M		47-48-49-50-51-52-53	Cowl vent seal	TRK	47-53 Chevrolet, Gmc	9062
M		54-55	Cowl vent seal	TRK	54-55 Chevrolet, Gmc	9061
M		55-56-57	Hood to header bar bumper	TRK	55-57 Chevrolet, Gmc Truck C&K 10-30	9030
M		55-56-57-59-60-61	Gear tube grommet	2DR 4DR HTP SDN CNV SWG	55-57 And 59-60 Chevrolet Pontiac, Oldsmobile, 60-61 Chevrolet Truck, Gmc Truck, 2 Door 4 Door Hardtop Sedan Convertible Station Wagon	1095
M		60-61-62-63-64-65-66	Front fenders to cab seal	TRK	60-66 Chevrolet, Gmc Pickup Truck, Stepside C&K 10-30	9347

Chevrolet GM GMC • Truck, Van, SUV

















CODE	IMAGE	YEAR	DESCRIPTION	BODY	FITS	ITEM#
M		60-61-62-63-64-65-66	Front & rear frame mount kit	TRK	60-66 Chevrolet, Gmc Truck	9082
M		60-61-62-63-64-65-66	Door crank felt seals 4 piece	TRK	60-66 Chevrolet, Gmc Truck Stepside C&K 10-30	9019
M		67-66-67-68-69-70-71-72	Complete mounting kit, cab, radiator support, bed to frame, wood bed, 80 piece	TRK	67-72 C20, K10 & 20 Truck Fleetside Stepside, Gmc Truck	9121
M		67-68-69-70-71-72	Complete mounting kit, cab, radiator support, bed to frame, wood bed 83 pieces	TRK	67-72 C10 20 Truck Fleetside Stepside, Gmc Truck	9122
M		71-72	Gas tank cab grommet	TRK	71-72 Chevrolet, Gmc Truck	9040
R		73-74-75-76-77	Roof rail weatherstrip with molded ends	2DR HTP	73-77 Chevrolet El Camino, Gmc Sprint	5034
R		76-77-78-79-80-81-82-83-84-85-86-87-88-89-90-91	Rear cab seal on shell	TRK	76-91 Chevrolet Blazer, Gmc Jimmy	9080
R		78-79-80-81-82-83-84-85-86-87	Roof rail weatherstrip	2DR HTP	78-87 Chevrolet El Camino, Baballero, Diable, 2 Door Hardtop	5049
W		47-48-49-50	Window channel kit, upper channel, window weatherstrip	TRK	47-50 Chevrolet, Gmc Truck	9991
W		51-52-53-54-55	Vent window weatherstrip	TRK	51-55 First Series Chevrolet Gmc, 3100, 3600, 3800	9063
W		51-52-53-54-55	Window channel kit, division bar, channel, window weatherstrip	TRK	51-55 1st Series Chevrolet Truck, Gmc Truck	0554
W		51-52-53-54-55	Division bar channel	TRK	51-55 Chevrolet, Gmc Truck	9992
W		55-56-57-58-59	Window channel kit replacement style	TRK	55-59 Chevrolet, Gmc Truck	9007
W		55-56-57-58-59	Window weatherstrip replacement style	TRK	55-59 Chevrolet, Gmc Truck	9006
W		55-56-57-58-59	Vent window weatherstrip	TRK	55 Second Series 59 Chevrolet Gmc 3100 3600 3800	9064
W		60-61-62-63	Window channel kit with framless glass div bar, win with strp, ch	TRK	60-63 Chevrolet, Gmc Truck	9994
W		60-61-62-63	Vent window weatherstrip	TRK	60-63 Chevrolet, Gmc Truck	9986
W		60-61-62-63	Window weatherstrip replacement style	TRK	60-63 Chevrolet Truck C10-20 Fleet-side Stepside, Gmc Truck	9135



GUIDE TO SOFFSEAL'S PRODUCT CODES
B = Bumper sets **C** = Glass channels **D** = Door related **G** = Seals, gaskets **H** = Under hood items **I** = Interior parts
M = Miscellaneous items **R** = Roofrail, pillar post & convertible items **T** = Trunk related **W** = Window related **Z** = Weatherstrip kits

Chevrolet GM GMC • Truck, Van, SUV



CODE	IMAGE	YEAR	DESCRIPTION	BODY	FITS	ITEM#
W		60-62-63	Window channel kit framed glass division bar, window weatherstrip	TRK	60-63 Chevrolet, Gmc Truck	9993
W		64-65-66	Window channel kit div bar, win weatherstrip win channel	TRK	64-66 Chevrolet, Gmc Truck	9995
W		64-65-66	Vent window weatherstrip	TRK	64-66 Chevrolet, Gmc Truck	9987
W		64-65-66	Window weatherstrip replacement style	TRK	64-66 Chevrolet, Gmc Truck C10-20 Fleetside Stepside	9340
W		67-68-69-70-71-72	Window weatherstrip replacement style	TRK	67-72 Chevrolet, Gmc Truck	9339
W		67-68-69-70-71-72	Vent window weatherstrip	TRK	67-72, 69-72 Chevrolet, Gmc Blazer, Pickup	9934
W		67-68-69-70-71-72	Window channel kit-custom, chrome on window seals	TRK	67-72 Chevrolet, Gmc Pickup	9620
W		67-68-69-70-71-72	Window channel kit-standard, no chrome on window seals	TRK	67-72 Chevrolet, Gmc Pickup	9621
W		73-74-75-76	Rear side door window channel kit	TRK	73-76 Chevrolet, Gmc Suburban	9076
W		73-74-75-76-77-78-79-80	Window channel kit, division bar, window weatherstrip & channel	TRK	73-80 Chevrolet, Gmc Truck	9650
W		73-74-75-76-77-78-79-80	Window weatherstrip authentic style	TRK	73-80 Chevrolet, Gmc Truck	9350
W		73-74-75-76-77-78-79-80	Vent window weatherstripping	TRK	73-80 Chevrolet, Gmc Truck	9928
W		73-74-75-76-77-78-79-80	Window weatherstrip replacement style	TRK	73-80 Chevrolet, Gmc Truck Blazer	9958
W		73-74-75-76-77-78-79-80-81-82-83-84-85-86-87	Window run channel	TRK	73-87 Chevrolet, Gmc Full Size Pickup	9622
W		73-74-75-76-77-78-79-80-81-82-83-84-85-86-87-88-89-90-91	Tailgate windowfelt, inner with silverdo trim	TRK	73-91 Chevrolet, Gmc Suburban	9089
W		73-74-75-76-77-78-79-80-81-82-83-84-85-86-87-88-89-90-91	Tailgate windowfelt, outer suburban, with or without silverado trim	TRK	73-71 Chevrolet, Gmc Suburban	9090
W		73-74-75-76-77-78-79-80-81-82-83-84-85-86-87-88-89-90-91	Tailgate glass run channel	TRK	73-91 Chevrolet, Gmc Suburban	9084

Chevrolet GM GMC • Truck, Van, SUV

CHEVROLET GM GMC • Truck, Van, SUV

CODE	IMAGE	YEAR	DESCRIPTION	BODY	FITS	ITEM#
W		73-74-75-76-77-78-79-80-81-82-83-84-85-86-87-88-89-90-91	Tailgate glass guide channel cup	TRK	73-91 Chevrolet, Gmc Suburban	9085
W		73-74-75-76-77-78-79-80-81-82-83-84-85-86-87-88-89-90-91	Tailgate window felt inner	TRK	73-91 Chevrolet Blazer, Gmc Jimmy	9086
W		73-74-75-76-77-78-79-80-81-82-83-84-85-86-87-88-89-90-91	Tailgate windowfelt outer	TRK	73-91 Chevrolet Blazer, Gmc Jimmy	9087
W		73-74-75-76-77-78-79-80-81-82-83-84-85-86-87-88-89-90-91	Stationary glass seal rear side door suburban	TRK	73-91 Chevrolet, Gmc Suburban	9073
W		75-76-77-78-79-80-81-82-83-84-85-86-87-88-89-90-91	Tailgate windowfelt inner with out silverado trim	TRK	75-91 Chevrolet Blazer, Gmc Jimmy, Suburban	9088
W		75-76-77-78-79-80-81-82-83-84-85-86-87-88-89-90-91-92-93-94	Window run channel	TRK	75-94 Chevrolet, Gmc Full Size Van	9623
W		81-82-83-84-85	Vent window seals 2 piece	TRK	81-85 Chevrolet C Truck, Gmc K Truck, Blazer, Jimmy, Suburban	9002
W		81-82-83-84-85-86-87	Window weatherstripping 81-91 blazer suburban front doors	TRK	81-87 Chevrolet, Gmc Truck Blazer	9968
W		81-82-83-84-85-86-87-88-89-90-91	Window channel kit, window weatherstrip & window channel division bar also fits 81-91 suburban front doors	ALL BODY STYLES	81-87 Chevrolet, Gmc Truck	9651
W		81-82-83-84-85-86-87-88-89-90-91	Vent window weatherstrip	TRK	81-87 Pickup 81-91 Blazer Suburban	9011
W		81-82-83-84-85-86-87-88-89-90-91	Rear side door window channel kit, window weatherstrip, window channel, division bar, with deep tinted windows	TRK	81-91 Chevrolet, Gmc Suburban	9077
W		81-82-83-84-85-86-87-88-89-90-91	Rear side door window channel kit, window weatherstrip, window channel, division bar, with o deep tinted windows	TRK	81-91 Chevrolet, Gmc Suburban	9078
W		82-83-84-85-86-87-88-89-90-91-92-93-94	Window channel kit, window channel & window weatherstrip	TRK	82-94 Chevrolet, Gmc Jimmy, Bravada, Sonoma, S10 Blazer	9990
W		82-83-84-85-86-87-88-89-90-91-92-93-94	Window run channel	TRK	82-94 Chevrolet S10, Gmc S15	9624
Z		47-48-49-50	Truck weatherstrip kit with trim, includes door weatherstrips, front glass channel, glass run channel, window weatherstrip, 3 window rear glass channel	TRK	47-50 Chevrolet Truck, Gmc Truck	KIT900C



GUIDE TO SOFFSEAL'S PRODUCT CODES

B = Bumper sets **C** = Glass channels **D** = Door related **G** = Seals, gaskets **H** = Under hood items **I** = Interior parts
M = Miscellaneous items **R** = Roofrail, pillar post & convertible items **T** = Trunk related **W** = Window related **Z** = Weatherstrip kits

Chevrolet GM GMC • Truck, Van, SUV



CODE	IMAGE	YEAR	DESCRIPTION	BODY	FITS	ITEM#
Z		47-48-49-50	Truck weatherstrip kit with trim, includes door weatherstrips, front glass channel, glass run channel, window weatherstrip, small rear glass channel	TRK	47-50 Chevrolet Truck, Gmc Truck	KIT900B
Z		47-48-49-50	Truck weatherstrip kit no trim, includes door weatherstrips, front glass channel, glass run channel, window weatherstrip, 3 window rear glass channel	TRK	47-50 Chevrolet Truck, Gmc Truck	KIT900A
Z		47-48-49-50	Truck weatherstrip kit no trim, includes door weatherstrips, front glass channel, glass run channel, window weatherstrip, small rear glass channel	TRK	47-50 Chevrolet Truck, Gmc Truck	KIT900
Z		51-52-53	Truck weatherstrip kit with trim, includes door weatherstrips, front glass channel, glass run channel, window weatherstrip, 3 window rear glass channel, division bar channel	TRK	51-53 Chevrolet Truck, Gmc Truck	KIT902C
Z		51-52-53	Truck weatherstrip kit no trim, includes door weatherstrips, front glass channel, glass run channel, window weatherstrip, 3 window rear glass channel, division bar channel	TRK	51-53 Chevrolet Truck, Gmc Truck	KIT902B
Z		51-52-53	Truck weatherstrip kit with trim, includes door weatherstrips, front glass channel, glass run channel, window weatherstrip, small rear rear glass channel, division bar channel	TRK	51-53 Chevrolet Truck, Gmc Truck	KIT902A
Z		51-52-53	Truck weatherstrip kit no trim includes door weatherstrips, front glass channel, glass run channel, window weatherstrip, small rear window glass channel, division bar channel	TRK	51-53 Chevrolet Truck, Gmc Truck	KIT902
Z		54-55	Truck weatherstrip kit with trim small rear glass, includes door weatherstrips, front glass channel, window run channel, window felt, small rear glass run channel	TRK	54-55 Chevrolet Truck, Gmc Truck	KIT909A
Z		54-55	Truck weatherstrip kit no chrome, includes door weatherstrips, front glass channel, window run channel, window felt, small rear glass run channel	TRK	54-55 Chevrolet Truck, Gmc Truck	KIT909C
Z		54-55	Truck weatherstrip kit with chrome, includes door weatherstrips, front glass channel, window run channel, window felt, small rear glass run channel	TRK	54-55 Chevrolet Truck, Gmc Truck	KIT909B

Chevrolet GM GMC • Truck, Van, SUV

CODE	IMAGE	YEAR	DESCRIPTION	BODY	FITS	ITEM#
Z		54-55	Truck weatherstrip kit no chrome, includes front glass channel, door weatherstrip, rear glass channel, window run channel, window felt	TRK	54-55 Chevrolet Truck, Gmc Truck	KIT909D
Z		55-56-57-58-59	Truck kit with trim, includes door weatherstrips, front glass channel, window channel kit, large rear glass run channel	TRK	55-59 Chevrolet Truck, Gmc Truck	KIT910A
Z		55-56-57-58-59	Truck weatherstrip kit with chrome, includes door weatherstrips, front glass channel, window channel kit, small rear glass run channel	TRK	55-59 Chevrolet Truck, Gmc Truck	KIT910D
Z		55-56-57-58-59	Truck weatherstrip kit no trim, includes door weatherstrips, front glass channel, window channel kit, small rear glass run channel	TRK	55-59 Chevrolet Truck, Gmc Truck	KIT910C
Z		55-56-57-58-59	Truck with stip kit no trim, includes door weatherstrips, front glass channel, window channel kit, large rear glass run channel	TRK	55-59 Chevrolet Truck, Gmc Truck	KIT910B
Z		60-61-61-63	Truck weatherstrip kit with trim, includes door weatherstrips, front glass channel, window channel kit, small rear glass run channel, windshield rubber	TRK	60-63 Chevrolet Truck, Gmc Truck	KIT921A
Z		60-61-62-63	Truck weatherstrip with large rear window no chrome, includes door weatherstrips, windshield glass channel, large rear glass run channel, door weatherstrip on door	TRK	60-63 Chevrolet Truck, Gmc Truck	KIT920B
Z		60-61-62-63	Truck weatherstrip kit with trim, includes door weatherstrips, windshield glass channel, window channel kit, large rear glass run channel, door weatherstrips on door	TRK	60-63 Chevrolet Truck, Gmc Truck	KIT920A
Z		60-61-62-63	Truck weatherstrip kit no trim, includes door weatherstrips, front glass channel, window channel kit, small rear glass run channel, windshield rubber	TRK	60-63 Chevrolet Truck, Gmc Truck	KIT921B
Z		64-65-66	Truck weatherstrip kit with trim, includes door weatherstrips, rear glass, windshield rubber, door weatherstrips on door, window channel kit div bar	TRK	64-66 Chevrolet Truck, Gmc Truck	KIT923B
Z		64-65-66	Truck weatherstrip kit no trim, includes door weatherstrips, front glass channel, window channel kit, small rear glass run channel, windshield rubber	TRK	64-66 Chevrolet Truck, Gmc Truck	KIT923A



GUIDE TO SOFFSEAL'S PRODUCT CODES





B = Bumper sets **C** = Glass channels **D** = Door related **G** = Seals, gaskets **H** = Under hood items **I** = Interior parts
M = Miscellaneous items **R** = Roofrail, pillar post & convertible items **T** = Trunk related **W** = Window related **Z** = Weatherstrip kits

Chevrolet GM GMC • Truck, Van, SUV



CODE	IMAGE	YEAR	DESCRIPTION	BODY	FITS	ITEM#
Z		64-65-66	Truck weatherstrip kit with trim, includes door weatherstrips, front glass channel, window channel kit, large rear glass run channel, windshield rubber	TRK	64-66 Chevrolet Truck, Gmc Truck	KIT922B
Z		64-65-66	Truck weatherstrip kit no trim, includes door weatherstrips, front glass channel, window channel kit, large rear glass run channel, windshield rubber	TRK	64-66 Chevrolet Truck, Gmc Truck	KIT922A
Z		67-68	Truck weatherstrip kit no chrome, includes door weatherstrips, front glass channel, window channel kit, small rear glass run channel	TRK	67-68 Chevrolet Truck, Gmc Truck	KIT925B
Z		67-68	Truck weatherstrip kit with chrome, includes door weatherstrips, front glass channel, window channel kit, small rear glass run channel	TRK	67-68 Chevrolet Truck, Gmc Truck	KIT925A
Z		67-68-69-70	Weatherstrip kit large rear window with chrome, includes door weatherstrips, front glass channel, window channel kit, large rear glass run channel	TRK	67-70 Chevrolet Truck, Gmc Truck	KIT925D
Z		67-68-69-70	Truck weatherstrip kit large rear window with chrome, includes door weatherstrips, front glass channel, window channel kit, large rear glass run channel	TRK	67-70 Chevrolet Truck, Gmc Truck	KIT925C
Z		67-68-69-70-71-72	Truck weatherstrip kit large rear window no chrome, includes door weatherstrips, front glass channel, window channel kit, large rear glass run channel	TRK	67-72 Chevrolet Truck, Gmc Truck	KIT925F
Z		67-68-69-70-71-72	Truck weatherstrip kit large rear window no chrome, includes door weatherstrips, front glass channel, window channel kit, large rear glass run channel	TRK	67-72 Chevrolet Truck, Gmc Truck	KIT925E
Z		71-72	Truck weatherstrip kit large rear window with chrome, includes door weatherstrips, front glass channel, window channel kit, large rear glass run channel	TRK	71-72 Chevrolet Truck, Gmc Truck	KIT925H
Z		71-72	Truck weatherstrip kit large rear window with chrome, includes door weatherstrips, front glass channel, window channel kit, large rear glass run channel	TRK	71-72 Chevrolet Truck, Gmc Truck	KIT925G
Z		73-74-75-76-77-78-79-80	Truck weatherstrip kit with black locking strip on windshield, includes door weatherstrips front and rear, vent window weatherstrips, rear glass channel no trim, window channel kit, upper door weatherstrips, windshield with trim	TRK	73-80 Chevrolet Truck, Gmc Truck	KIT930C

Chevrolet GM GMC • Truck, Van, SUV

CODE	IMAGE	YEAR	DESCRIPTION	BODY	FITS	ITEM#
Z		73-74-75-76-77-78-79-80	Truck weatherstrip kit with chrome, includes door weatherstrips, vent window weatherstrips, rear glass channel, window channel kit, front glass channel, upper door weatherstrip on door	TRK	73-80 Chevrolet Truck, Gmc Truck	KIT930B
Z		73-74-75-76-77-78-79-80	Truck weatherstrip kit no chrome, includes door weatherstrips, vent window weatherstrips, rear glass channel, window channel kit, front glass channel, upper door weatherstrip on door	TRK	73-80 Chevrolet Truck, Gmc Truck	KIT930A
Z		81-82-83-84-85-86-87	Truck weatherstrip kit with chrome, includes door weatherstrips, vent window weatherstrips, rear glass channel, window channel kit, front glass channel, upper door weatherstrip on door	TRK	81-87 Chevrolet Truck, Gmc Truck	KIT931B
Z		81-82-83-84-85-86-87	Truck weatherstrip kit no chrome, includes door weatherstrips, vent window weatherstrips, rear glass channel, window channel kit, front glass channel, upper door weatherstrip on door	TRK	81-87 Chevrolet Truck, Gmc Truck	KIT931A
Z		81-82-83-84-85-86-87	Truck weatherstrip kit with black locking on windshield, includes door weatherstrips, vent window weatherstrips, rear glass channel, window channel kit, upper door weatherstrips, windshield with trim	TRK	81-87 Chevrolet Truck, Gmc Truck	KIT931C



GUIDE TO SOFFSEAL'S PRODUCT CODES











B = Bumper sets **C** = Glass channels **D** = Door related **G** = Seals, gaskets **H** = Under hood items **I** = Interior parts
M = Miscellaneous items **R** = Roofrail, pillar post & convertible items **T** = Trunk related **W** = Window related **Z** = Weatherstrip kits



CODE	IMAGE	YEAR	DESCRIPTION	BODY	FITS	ITEM#
B		61-62	Upper vent window bumper	CNV	61-62 Chevrolet Impala, Bel Air, Pontiac Catalina, Bonneville, Oldsmobile 88, 98, Buick LeSabre, Electra 225, Cadillac Deville Convertible	2088
B		63-64	Upper vent window bumpers	CNV	63-64 Impala, Bonneville, Catalina, Oldsmobile 88, 98, LeSabre, Electra 225, Deville, Convertible	2203
B		63-64	Vent window bumpers, upper	2DR 4DR HTP	63-64 Chevrolet Impala, 63-64 Cadillac, Deville, 63-64 Oldsmobile 88, 98, 63-64 Buick LeSabre, Electra, 63-64 Pontiac Bonneville, Catalina, 2 Door 4 Door Hardtop	2204
B		67-68-69-70	Door bumpers	2DR 4DR HTP 2DR SDN CNV SWG	67-70 Chevrolet Biscayne, Bel Air, Impala Caprice, 67-70 Cadillac Calais, Deville, Fleetwood, 67-70 Oldsmobile 88, 98, 67-70 Buick LeSabre, Wildcat, Electra, 67-70 Pontiac	2323
C		59-60	Glass channel	2DR 4DR HTP CNV	59-60 Chevrolet Bel Air, Impala, Cadillac Series 62, Deville, Eldorado, Oldsmobile 88 Oldsmobile 98, Buick LeSabre, Invicta, Electra, Pontiac Catalina, Star Chief, Bonneville 2 Door 4 Door Hardtop Convertible	2080
C		61-62	Glass channel front	2DR HTP	61 Chevrolet Impala, 62 Chevrolet Bel Air, 61 Cadillac Series 62, 62 Cadillac Deville 4 Door S, 61-62 Oldsmobile 88 Oldsmobile 98, 61 Buick LeSabre, Invicta, Electra, 62 Buick, 61-62 Pontiac Catalina, Ventura, Star Chief, Bonneville 2 Door Hardtop	2161
C		62-63-64	Glass channel rear	2DR 4DR SDN	62-63 Chevrolet Biscayne, Bel Air, Impala, 62-64 Cadillac, 62-64 Oldsmobile 88, 62-64 Buick LeSabre, 64 Wildcat, 62-64 Pontiac Catalina, Star Chief 2 Door 4 Door Sedan	2189
C		63-64	Glass channel rear	4DR HTP	63-64 Chevrolet Impala Sport Coupe, Oldsmobile 88 Holiday Sedan, Buick LeSabre, Wildcat, Pontiac Bonneville, Catalina, Star Chief 4 Door Hardtop	2188
C		63-64	Glass channel front	4DR HTP	63-64 Chevrolet Impala, 63-64 Cadillac, 63-64 Oldsmobile 88 Oldsmobile 98, 63-64 Buick, 63-64 Pontiac, 4 Door Hardtop	21841
C		63-64	Windshield gasket	2DR SDN SWG	63-64 Chevrolet Biscayne, Bel Air, Impala, 63-64 Cadillac Series 62, Deville, 63-64 Oldsmobile 88 Oldsmobile 98, 63-64 Buick LeSabre, Wildcat, Electra, 63-64 Pontiac, 2 Door Sedan Station Wagon	2020
C		63-64	Glass channel front	2DR HTP CNV	63-64 Chevrolet Impala, 63-64 Cadillac, 63-64 Oldsmobile 88, Oldsmobile 98 Starfire Convertible Only, 63-64 Buick LeSabre, Wildcat, Electra, 63-64 Pontiac, 2 Door Hardtop Convertible	2021
D		58	Door weatherstrip with clips & molded ends	2DR HTP CNV	58 Chevrolet Impala, Cadillac, Oldsmobile 88 Convertible Only, Buick Century Convertible Only, Pontiac, 2 Door Hardtop Convertible	2010

Oldsmobile • 88, 98

OLDSMOBILE • 88, 98

CODE	IMAGE	YEAR	DESCRIPTION	BODY	FITS	ITEM#
D		58	Door j weatherstrip	2DR 4DR HTP 2DR SDN CNV SWG	58 Chevrolet Del Ray, Biscayne, Bel Air, Impala, 58 Cadillac, 57-58 Oldsmobile 88 Oldsmobile 98, 57-58 Buick Special Century, Super, Roadmaster, 58 Pontiac	2044
D		59-60	Door weatherstrip with clips & molded ends	2DR HTP CNV	59-60 Chevrolet Impala, Bel Air, Pontiac Catalina, Star Chief, Bonneville, Oldsmobile 88, 98, Buick LeSabre, Invicta, Electra, Cadillac Deville, Eldorado, Series 62 Hardtop Convertible	2011
D		59-60	Door weatherstrip front with clips & molded ends	4DR HTP	59-60 Chevrolet Impala, Bel Air, Buick Lesabre, Invicta, Oldsmobile 88, Pontiac Catalina, Star Chief, Bonneville 4 Door Hardtop	2205
D		59-60	Door weatherstrip rear door with clips & molded ends	4DR HTP	59-60 Chevrolet Impala, Bel Air, Buick Electra, Invicta, LeSabre, Cadillac 62 Deville, Eldorado, Oldsmobile 98 Oldsmobile 99, 4 Door Hardtop	2206
D		61-62	Door weatherstrip, front doors	4DR HTP	61-62 Chevrolet Impala, Bel Air, Buick Electra, LeSabre, Invicta, Cadillac Series 60, Oldsmobile 88 Oldsmobile 98, 4 Door Hardtop	2207
D		61-62	Door weatherstrip with clips & molded ends	2DR HTP CNV	61-62 Chevrolet Bel Air Impala, Cad Series 62, Deville, 61-62 Oldsmobile, 61 Hardtop Convertible 88 Star Fire, Oldsmobile 98/62 Oldsmobile 88 Oldsmobile 98 Starfire, 61-62 Buick 61 Hardtop Convertible, 62 Convertible Only LeSabre Invicta Electra, 61-62 Pontiac, 2 Door Hardtop Convertible	2013
D		61-62-63-64	Door weatherstrip rear door with clips	4DR SDN	61-64 Chevrolet Biscayne Bel Air Impala, 61-64 Oldsmobile 88, 98, 61-62 Cadillac, 61-64 Buick LeSabre Electra, 64 Wildcat, 61-64 Pontiac Catalina, Star Chief, 4 Door Sedan	2009
D		61-62-63-64	Door weatherstrip rear with clips	4dr SWG	61-64 Chevrolet Biscayne, Bel Air, Impala, 61-64 Oldsmobile 88, 61-64 Buick LeSabre, 62-63 Invicta 63-64 Wildcat, 61-64 Pontiac Catalina, Bonneville, 4 Door Station Wagon	2018
D		61-62-63-64	Door weatherstrip , rear doors with clips & molded ends	4DR HTP	61-64 Chevrolet Impala, Buick LeSabre, Oldsmobile Wildcat, 88, Pontiac Catalina Starchief Bonneville 4 Door Hardtop	2122
D		63-64	Door weatherstrip with clips & molded ends	2DR HTP CNV	63-64 Chevrolet Impala, 63-64 Cadillac Eldorado, Deville, 63-64 Oldsmobile 88 Oldsmobile 98 Starfire 63-64 Buick LeSabre Wildcat, Electra 63 Invicta, 63-64 Pontiac Catalina, Bonneville, Grand Prix, 2 Door Hardtop Convertible	2014
D		63-64	Door weatherstrip front with clips	4DR SDN SWG	63-64 Chevrolet Biscayne, Bel Air, Impala, 63-64 Cadillac, 63-64 Oldsmobile 88, 63-64 Buick LeSabre, Wildcat, 63-64 Pontiac, 4 Door Sedan Station Wagon	2017



GUIDE TO SOFFSEAL'S PRODUCT CODES

B = Bumper sets **C** = Glass channels **D** = Door related **G** = Seals, gaskets **H** = Under hood items **I** = Interior parts
M = Miscellaneous items **R** = Roofrail, pillar post & convertible items **T** = Trunk related **W** = Window related **Z** = Weatherstrip kits



CODE	IMAGE	YEAR	DESCRIPTION	BODY	FITS	ITEM#
D		65-66	Door weatherstrip front with clips	4DR SDN SWG	65-66 Chevrolet Biscayne Bel Air Impala, 65-66 Cadillac Calais Deville Fleetwood, 65-66 Oldsmobile 88, 65-66 Buick LeSabre Wildcat, 65-66 Pontiac Bonneville, Catalina, Star chief, 4 Door Sedan Swg	2006
D		65-66	Rear door weatherstrip with clips	4DR SDN	65-66 Chevrolet Biscayne Bel Air Impala 65-66 Cadillac Calais Deville Fleetwood 65-66 Oldsmobile 88, 65-66 Buick LeSabre Wildcat, 65-66 Pontiac Catalina, Star Chief, 4 Door Sedan	2007
D		65-66	Door weatherstrip with clips & molded ends	2DR HTP CNV	65-66 Chevrolet Impala, Caprice, 65-66 Cadillac Calais, Deville, 65-66 Oldsmobile 88, Starfire, Oldsmobile 98, 65 Jet Star, 65-66 Buick LeSabre, Wildcat Electra, 65-66 Pontiac 2 Door Hardtop Convertible	2331
D		65-66-67-68	Door weatherstrip front door with clips & molded ends	4DR HTP	65-68 Chevrolet Impala, Buick, Wildcat, LeSabre, Cadillac Calais, Deville, Oldsmobile 98 Oldsmobile 99, Pontiac, 4 Door Hardtop	2210
D		67-68	Door weatherstrip rear with clips	4DR SDN	67-68 Chevrolet Biscayne, Bel Air, Impala, 67-68 Cadillac Calais, Deville, Fleetwood, 67-68 Oldsmobile 88, 67-68 Buick LeSabre, Wildcat, 67-68 Pontiac Bonneville Station Wagon, 67-68 Pontiac Executive, Catalina, 4 Door Sedan	23322
D		67-68	Door weatherstrip with clips & molded ends	CNV 2DR HTP	67-68 Chevrolet Impala, Caprice, Except 68 Caprice 2 Door Hardtop, 67-68 Cadillac Calais, Deville, 67-68 Oldsmobile 88 Oldsmobile 98, 67-68 Buick Electra, Wildcat, 67 Pontiac Catalina, Bonneville, Executive, 67 Grand Prix Convertible 2 Door Hardtop	2342
D		69-70	Door weatherstrip with clips & molded ends	2DR HTP CNV	69-70 Chevrolet Impala, Caprice, 69-70 Cadillac Calais, Deville, 69-70 Oldsmobile 88 Oldsmobile 98, 69-70 Buick LeSabre, Wildcat, Electra, 69-70 Pontiac Catalina, Bonneville, Executive, 2 Door Hardtop Convertible	2357
D		71-72-73-74	Door weatherstrip rear door with clips & molded ends	4DR HTP	71-74 Chevrolet Caprice, Impala, Buick LeSabre, Centurion, Oldsmobile 88, Pontiac, 4 Door Hardtop	2214
D		71-72-73-74-75-76	Door weatherstrip rear	4DR HTP	71-76 Buick Electra, Oldsmobile 98, 4 Door Hardtop	2215
D		71-72-73-74-75-76	Door weatherstrip front doors with clips & molded ends	4DR HTP	71-76 Chevrolet Caprice, Impala, Buick, Electra, LeSabre, Centurion, Cadillac Calais, Deville, Oldsmobile 88 Oldsmobile 98, Catalina, Bonneville, Granville, 4 Door Hardtop	2213
D		71-72-73-74-75-76	Door weatherstrip with clips & molded ends	2DR HTP CNV	71-76 Chevrolet Impala, Caprice, Cadillac Calais, Deville, Buick 71-73 LeSabre, Centurion, Electra, 74-76 LeSabre, Electra, Oldsmobile 88 Oldsmobile 98, Pontiac Bonneville, Catalina, 71-75 Grandville 2 Door Hardtop Convertible	2512

Oldsmobile • 88, 98

OLDSMOBILE • 88, 98

CODE	IMAGE	YEAR	DESCRIPTION	BODY	FITS	ITEM#
D		75-76	Rear Door weatherstrip with clips & molded ends	4DR HTP	75-76 Chevrolet Impala, Caprice, Buick, LeSabre, Centurion, Oldsmobile 88, Pontiac, 4 Door Hardtop	2216
D		77-78-79-80-81-82-83-84-85-86	Front door weatherstrip with clips	4DR SDN RWD	77-86 Impala Caprice, 77-84 Cadillac Deville Fleetwood, 85-86 Fleetwood, 77-84 Oldsmobile 88 89, 85 88, 77-84 Buick LeSabre Electra 85 LeSabre, 77-79 Buick Estate Wagon, 82-83 Buick Park Ave 77-81 Pontiac Bonneville, 83-86 Pontiac Parisienne, 77-80 Pontiac Catalina 4 Door Sedan, RWD Only	2500
D		77-78-79-80-81-82-83-84-85-86-87	Door weatherstrip with clips	2DR SDN RWD	84-87 Chevrolet Caprice, 77-81 Chevrolet Impala, 83 Chevrolet, 77-84 Cadillac Deville, 80-84 Fleetwood, 77-84 Oldsmobile 88 Oldsmobile 98, 85 Oldsmobile 88, 77-84 Buick LeSabre, Electra, 85 LeSabre, 77-81 Pontiac Bonneville, Catalina 2 Door Sedan, RWD Only	2359
D		77-78-79-80-81-82-83-84-85-86-87-88-89-90	Door weatherstrip rear door with clips	4DR SDN RWD	77-90 Chevrolet, 77-90 Cadillac Fleetwood, 77-84 Oldsmobile 98, 77-84 Buick Electra, Park Avenue 77-90 Pontiac, 4 Door Sedan, RWD Only	23591
D		77-78-79-80-81-82-83-84-85-86-87-88-89-90	Rear door weatherstrip with clips	4DR SDN RWD	77-86 Chevrolet Impala Caprice, 87-88 Caprice Caprice Classic, 89 Caprice, 90 Caprice Caprice Classic, 77-84 Cadillac Deville, 77-85 Oldsmobile 88, 77-78 Town Sedan, Custom Crusier, 77-84 Buick LeSabre Electra 85 LeSabre, 77-81 Pontiac Bonneville, Catalina, 83-86 Pontiac Parisienne 4 Door Sedan, RWD Only	2502
D		85-86-87-88-89-90	Door weatherstrip rear with clips	SWG FWD	85-90 Buick Electra, Oldsmobile 98, Station Wagon, FWD	2601
D		85-86-87-88-89-90	Door weatherstrip rear with clips	4DR SDN FWD	85-90 Buick Park Avenue, Electra, Oldsmobile 98, 4 Door Sedan Fwd	2606
D		85-86-87-88-89-90-91	Door weatherstrip front with clips	4DR SDN FWD SWG	85-91 Buick Electra, Oldsmobile 98, 86-91 Buick LeSabre, Oldsmobile 88, 87-91 Pontiac Bonneville, 85-90 Park Avenue, 4 Door Sedan Fwd Station Wagon	2605
G		60-63-64-69-70	Door handle & lock gaskets	2DR 4DR HTP 2DR SDN CNV SWG	60 Chevrolet Biscayne, Impala, Bel Air, Cadillac, Oldsmobile 89 Oldsmobile 98, Buick LeSabre, Invicta, Electra, Wild Cat, Pontiac Catalina, Star Chief, Bonneville, Grand Prix, Ventura	2098
G		61-62-65-66-67-68	Door handle & lock gaskets	2DR 4DR HTP 2DR SDN CNV SWG	61-62 Chevrolet Biscayne, Bel Air, Impala, Cadillac, Oldsmobile 88 Oldsmobile 98, Buick LeSabre, Invicta, Electra, Pontiac	2145
G		71-72-73-74-75-76-77-78	Door handle gaskets	2DR HTP CNV 2DR SDN	71-76 Buick LeSabre, Electra, Oldsmobile 98 Oldsmobile 88, 71-78 Toronado, Cadillac, 74-76 Riviera	2514



GUIDE TO SOFFSEAL'S PRODUCT CODES

B = Bumper sets **C** = Glass channels **D** = Door related **G** = Seals, gaskets **H** = Under hood items **I** = Interior parts
M = Miscellaneous items **R** = Roofrail, pillar post & convertible items **T** = Trunk related **W** = Window related **Z** = Weatherstrip kits



CODE	IMAGE	YEAR	DESCRIPTION	BODY	FITS	ITEM#
H		64-65-66-67-68-69-70-71-72	Firewall wiring gutter plk	2DR 4DR HTP 2DR SDN SWG CNV	Chevy Chevelle, Biscayne, Bel Air, Impala, Caprice, Nova, Camaro, Cadillac Calais, Deville, Fleetwood, Oldsmobile 88, 98, Jetstar, Starfire, Pontiac Catalina, Bonneville, Firebird, Buick Lesabre, Wildcat, Electra	2328
H		71-72-73-74-75-76-77-78	Hood to cowl seal	2DR SDN 2DR HTP CNV SWG	71-78 Chevrolet Impala, Caprice, Biscayne, Bel Air, Brookwood, Townsman, Kingswood, Buick Lesabre, Centurion, Electra 225, Estate Wagon, Cadillac Calais, Deville, Eldorado, Sixty Special Brougham, Oldsmobile 88, 98, Tornado, Pontiac Catalina, Bonneville, Grandville, Safari Full Size	2191
I		58	Gear shift grommet column	2DR 4DR SDN HTP CNV	58 Chevrolet Del Ray, Biscayne, Bel Air, Impala, Cadillac, Oldsmobile 88 Oldsmobile 98, Buick Special, Century, Roadmaster, Riviera, Pontiac	2185
I		59-60-61-62-63-64-65-66	Gear shift grommet column	2DR 4DR SDN HTP CNV	59-66 Chevrolet Biscayne, Bel Air, Impala, 59-66 Cadillac, 59-63 Oldsmobile 88 Oldsmobile 98, 61 Starfire, 64-66 Starfire, Jet Star, 59-66 Buick LeSabre, Invicta, Electra, 63 Wildcat, Riviera, 59-66 Pontiac	2185A
R		58-59-60-61-62-63-64	Header seal	CNV	Chevy Impala, Cadillac Series 62 Eldorado, Pontiac Catalina, Bonneville, Oldsmobile 88, 98, Starfire, Buick Lesabre, Invicta, Electra	2153
R		59-60	Weatherstrip kit for convertible top	CNV	59-60 Cadillac Series 62, Eldorado, 59-60 Oldsmobile 98, 59-60 Buick Electra, 59-60 Pontiac, Convertible	2155
R		59-60	Pillar post weatherstrip with clips and molded ends	CNV	59-60 Chevrolet Impala, Cadillac Eldorado Series 62, Pontiac Bonneville, Catalina, Oldsmobile 88 Oldsmobile 98, Buick LeSabre, Invicta, Electra	2091
R		59-60	Weatherstrip kit for convertible top with header seal	CNV	59-60 Chevrolet Impala, Cadillac, Oldsmobile 88, Buick LeSabre, Invicta, Pontiac, Convertible	2092
R		61-62	Roofrail weatherstrip	4DR HTP	61-62 Chevrolet Bel Air, Impala, Buick, LeSabre, Invicta, Oldsmobile 88, Pontiac, 4 Door Hardtop	2223
R		62	Roofrail weatherstrip with molded ends	2DR HTP	62 Chevrolet Impala, 62 Cadillac, 62 Oldsmobile 88, 62 Buick LeSabre, Invicta, Pontiac 2 Door Hardtop	2164
R		62	Pillar post weatherstrip with molded ends	CNV	61-62 Chevrolet Impala, 61-62 Cadillac 61 Series 6200, Eldorado 62 Eldorado, 61-62 Oldsmobile 88 Oldsmobile 98, Starfire, 61-62 Buick Electra, Invicta, LeSabre, 61-62 Catalina, Bonneville, Convertible	2154
R		62-63-64	Weatherstrip kit for convertible top second type with 5 3/8" between center studs	CNV	62-64 Chevrolet Impala, Oldsmobile 88, Starfire, Buick LeSabre, Invicta, Pontiac, Bonneville, Catalina, 63-64 Buick Wildcat Convertible	2152
R		62-63-64	Weatherstrip kit for convertible top with 5 3/8" between center studs cloth covered	CNV	62-64 Chevrolet Impala, Cadillac, Oldsmobile 88, Starfire, Buick LeSabre, Invicta, Wildcat, Pontiac Catalina, Bonneville	2152C

Oldsmobile • 88, 98

CODE	IMAGE	YEAR	DESCRIPTION	BODY	FITS	ITEM#
R		63-64	Pillar post weatherstrip with molded ends	CNV	63-64 Chevrolet Impala, 63-64 Cadillac 63 Series 6200, Eldorado 64 Deville, Eldorado, 63-64 Oldsmobile 88 Oldsmobile 98, Starfire, 63-64 Buick LeSabre, Wildcat, 63-64 Pontiac, Convertible	2193
R		63-64	Roofrail weatherstrip with molded ends	2DR HTP	63-64 Chevrolet Impala, 63-64 Cadillac, 63-64 Oldsmobile 88, 63-64 Buick LeSabre, Wildcat, 63-64 Pontiac 2 Door Hardtop	2194
R		63-64	Roofrail weatherstrip with molded ends	4DR HTP	63-64 Chevrolet Impala, Buick LeSabre, Wildcat, Oldsmobile 88, Pontiac, 4 Door Hardtop	2194A
R		65	Pillar post weatherstrip with molded ends	CNV	65 Chevrolet Impala, 65 Cadillac Deville, Eldorado, 65 Oldsmobile 88 Oldsmobile 98, 65 Buick LeSabre, Wildcat, Electra, Invicta, 65 Pontiac, Convertible	2334
R		65-66	Roofrail weatherstrip with molded ends	2DR HTP	65-66 Chevrolet Impala, Caprice, 65-66 Cadillac Calais, Deville, 65-66 Oldsmobile 88, Jet Star, Star Fire, Oldsmobile 98, 65-66 Buick LeSabre, Wildcat, Electra, 65-66 Pontiac 2 Door Hardtop	2333
R		65-66	Roofrail weatherstrip with molded ends	4DR HTP	65-66 Chevrolet Impala, Caprice, 65-66 Cadillac, 65-66 Oldsmobile 88, 65-66 Buick LeSabre, 65-66 Pontiac, 4 Door Hardtop	2333A
R		65-66-67-68-69-70	Header seal with clips and molded ends	CNV	65 Chevrolet, 66-70 Chevrolet Impala, 65-70 Cadillac Deville, 65-70 Oldsmobile 88 Oldsmobile 98, 65 Oldsmobile Starfire, 65-70 Buick LeSabre, Wildcat, Electra, 65-70 Pontiac, Convertible	23343
R		66-67-68-69-70	Weatherstrip kit for convertible top with out header seal	CNV	66-70 Cadillac Deville, 66 Cadillac Eldorado, 66-70 Oldsmobile 98, 66-70 Buick Electra, Convertible	23342
R		66-68	Pillar post weatherstrip with molded ends	CNV	66-68 Chevrolet Impala, 66-68 Cadillac Deville, 66 Cadillac Eldorado, 66-68 Oldsmobile 88 Oldsmobile 98, 66-68 Buick Electra, LeSabre, Wildcat, 66-68 Pontiac, Convertible	23341
R		66-67-68-69-70	Weatherstrip kit for convertible top includes header seal (7 piece kit)	CNV	66-70 Chevrolet Impala, 66-70 Oldsmobile 88, 66-70 Buick LeSabre, Wildcat, 66-70 Pontiac Bonneville, Catalina, 67 Pontiac Grand Prix, Convertible	2366
R		67-68	Roofrail weatherstrip with molded ends	2DR HTP	67-68 Chevrolet Impala, Caprice, 67-68 Cadillac, 67-68 Oldsmobile 88, 67-68 Buick Electra, Wildcat, 67-68 Pontiac Catalina, Executive 2 Door Hardtop	2345
R		69-70	Pillar post weatherstrip with molded ends	CNV	69-70 Chevrolet Impala, Caprice, 69-70 Cadillac Deville, 69-70 Oldsmobile 88 Oldsmobile 98, 69-70 Buick LeSabre, Wildcat, Electra, 69-70 Pontiac, Convertible	2358



GUIDE TO SOFFSEAL'S PRODUCT CODES

B = Bumper sets **C** = Glass channels **D** = Door related **G** = Seals, gaskets **H** = Under hood items **I** = Interior parts
M = Miscellaneous items **R** = Roofrail, pillar post & convertible items **T** = Trunk related **W** = Window related **Z** = Weatherstrip kits



CODE	IMAGE	YEAR	DESCRIPTION	BODY	FITS	ITEM#
R		69-70	Roofrail weatherstrip with molded ends	2DR HTP	69-70 Chevrolet Caprice, Impala, 69-70 Cadillac, 69-70 Oldsmobile 88, 69-70 Buick LeSabre, Wildcat, 69-70 Pontiac 2 Door Hardtop	2356
R		69-70	Roofrail weatherstrip	4DR HTP	69-70 Chevrolet Impala, Caprice, 69-70 Oldsmobile 88 Oldsmobile 98, 69-70 Buick LeSabre, Wildcat, Electra, 69-70 Pontiac Catalina, Bonneville, Executive 4 Door Hardtop	23561
R		71-72-73	Roofrail weatherstrip	2DR HTP	71-73 Chevrolet Impala, 71-73 Cadillac, 71-73 Oldsmobile 88, 71-73 Pontiac, 2 Door Hardtop	2420
R		71-72-73-74	Roofrail weatherstrip	4DR HTP	71-74 Chevrolet Caprice, Impala, Buick LeSabre, Centurion, Oldsmobile 88, Pontiac Catalina, Bonneville 4 Door Hardtop	2221
R		71-72-73-74	Roofrail weatherstrip	4DR HTP	71-74 Buick Electra, Oldsmobile 98, Cadillac Deville, 4 Door Hardtop	2224
R		71-72-73-74-75	Roofrail weatherstrip	2DR HTP	71-73 Impala Custom Coupe Caprice, 74-75 Impala Sport Coupe, 71-76 Cadillac Calais Deville, 71-74 Electra, 74-76 LeSabre, 71-71 98, 74 Oldsmobile 98 Oldsmobile Delta 88, 75-76 Oldsmobile Delta 88, 71-73 Grandville, 74 Bonneville Catalina Grandville, 75-76 Catalina, 2 Door Hardtop	2509
R		71-72-73-74-75-76	Header seal	CNV	71-75 Chevrolet Impala, Caprice, 71-72 Oldsmobile 88, 71-75 Pontiac Catalina, Grandville, 71-75 Buick Lesabre, Centurion, 71-76 Cadillac Eldorado, Convertible	2515
R		71-72-73-74-75-76	Pillar post weatherstrip with molded ends	CNV	71-75 Chevrolet Impala, Caprice 71-72 Oldsmobile 88, 71-75 Pontiac Catalina, Grandville, 71-75 Buick Lesabre, Centurion 71-76 Cadillac Eldorado, Convertible	2094
T		55-56	Trunk weatherstrip	2DR 4DR HTP 2DR SDN CNV	55-56 Chevrolet 150, Chevrolet 210, Chevrolet Bel Air, Chevrolet Nomad, Oldsmobile 98, Pontiac Chieftan, Pontiac 860, Pontiac 870, Pontiac Super Chief, Pontiac Bonneville, Pontiac Star Chief, Pontiac Safari	6012









WHAT IS A PRODUCT CODE?

Our catalog is grouped by product CODE (type) then years. See page 1 for details explaining the different Product CODES.



Oldsmobile • 88, 98

CODE	IMAGE	YEAR	DESCRIPTION	BODY	FITS	ITEM#
T		64-65-66-67-68-69-70-71-72-73-74-75-76-77	Trunk weatherstrip exact profile length 17 feet	2DR 4DR HTP 2DR SDN CNV	65-72 Chevy II, 65-72 Chevrolet Biscayne, 65-75 Chevrolet Bel Air, 65-76 Chevrolet Impala, 65-76 Chevrolet Caprice, 64-77 Chevrolet Chevelle, 70-77 Chevrolet Monte Carlo, 65-76 Buick LeSabre, 64-77 Buick Wildcat, 64-77 Buick Skylark, 71-73 Buick Centurion, 64-72 Buick Grand Special, 73-77 Buick Century, 73-88 Buick Regal, 73-88 Buick Grand National, 65-76 Buick Electra, 65-76 Oldsmobile Delta 88, 67-69 Oldsmobile Delmont 88, 65-66 Oldsmobile Dynamic 88, 65-66 Oldsmobile Starfire, 65 Oldsmobile Jetstar, 64-77 Oldsmobile Cutlass 442, 64-88 Oldsmobile Cutlass, 65-76 Oldsmobile 98, 65-76 Pontiac Parisienne, 64-72 Pontiac LeMans, 65-70 Pontiac Catalina, 65-66 Pontiac Star Chief, 67-70 Pontiac Executive, 71-75 Pontiac Grand Ville, 65-77 Pontiac Grand Prix, 64-72 Pontiac Tempest, 62-72 Nova, Ventura, 73-74 Non-Hatchback, Up to 1975 with groove channel, Apollo, Nova, Omega, Ventura 65-76 C-Body	2003
T		75-76-77-78-79-80-81-82-83-84-85-86-87-88-89-90-91-92	Trunk and Hatchback weatherstrip	2DR 4DR SDN HTP CNV	77-85 Chevrolet Impala, 77-91 Chevrolet Caprice, 82-92 Chevrolet Camaro, 75-79 Chevrolet Nova, 78-88 Chevrolet Monte Carlo, 78-83 Chevrolet Malibu, 78-83 Pontiac LeMans, 82-92 Pontiac Firebird, 75-91 Pontiac Ventura, 77-86 Pontiac Parisienne, 77-81 Pontiac Catalina, 69-88 Pontiac Grand Prix, 64-87 Pontiac LeMans, Pontiac Grand Am, 64-77 Pontiac GTO, 73-79 Oldsmobile Omega, 77-85 Oldsmobile Delta 88, 77-84 Oldsmobile 98, 77-88 Oldsmobile Cutlass, 73-75 Buick Apollo, 76-79 Buick Skylark, 77-79 Phoenix, 73-88 Buick Regal, 77-84 Buick Electra, 77-85 Buick LeSabre, 77-78 Buick Riviera, 77-91 C-Body	2424
W		48-49	Windshield post weatherstrip seals	CPE CNV	49 Buick Riviera, Cadillac Coupe Deville, Oldsmobile 98, Holiday Coupe, 48-49 Cadillac, Oldsmobile 98 Convertible	0553
W		58	Window weatherstrip original style with round bead	CNV	58 Chevrolet Impala, 58 Cadillac, 58 Oldsmobile 88 Oldsmobile 98, 58 Buick Special, Century, Roadmaster, 58 Pontiac, Convertible	2038
W		58-59-60	Quarter window u-jamb seals	CNV	58-60 Chevrolet Impala, 58 Cadillac, 59-60 Cadillac Series 62, Eldorado, 58-60 Oldsmobile 88 Oldsmobile 98, 58 Buick, 59-60 Buick LeSabre, Invicta, Electra, 58 Pontiac, Convertible	2286
W		58-59-60-61-62-63-64	Quarter window seals	2DR HTP CNV	58-64 Chevrolet Impala, 58, 60-62 Bel Air, 58-64 Cadillac Series 62, Deville, Eldorado, 58 Oldsmobile 88 Oldsmobile 98, 59-60 Oldsmobile 88 Oldsmobile 98, 61-64 Oldsmobile 99, Starfire, 98, 64 Jetstar, 59-62 Buick LeSabre, Invicta, Electra 2 Door Hardtop Convertible	2300



GUIDE TO SOFFSEAL'S PRODUCT CODES









B = Bumper sets **C** = Glass channels **D** = Door related **G** = Seals, gaskets **H** = Under hood items **I** = Interior parts
M = Miscellaneous items **R** = Roofrail, pillar post & convertible items **T** = Trunk related **W** = Window related **Z** = Weatherstrip kits



CODE	IMAGE	YEAR	DESCRIPTION	BODY	FITS	ITEM#
W		61-62	Vent window seals	2DR 4DR HTP CONV	61-62 Chevrolet Bel Air, Impala, 61-62 Cadillac Series 62, Eldorado, 61-62 Oldsmobile 88 Oldsmobile 98, 61-62 Buick LeSabre, Invicta, Electra, 61-62 Pontiac Bonneville, Catalina, Ventura 2 Door 4 Door Hardtop, Convertible	21615
W		61-62-63-64-65-66	Horizontal outer window seals	2DR 4DR HTP SDN CNV SWG	Chevy Biscayne, Bel Air, Impala, Caprice, Cadillac series 62 Deville, Eldorado, Fleetwood, Calais, Oldsmobile 88, Starfire, 98. Buick Lesabre, Invicta, Wildcat, Electra, Pontiac Catalina, Ventura, Star Chief, Bonneville	2310
W		63-64	Vent window seals	2DR HTP CNV	63-64 Chevrolet Impala, Buick Electra, Lesabre, Wildcat, Oldsmobile 98, Pontiac Catalina, Bonneville, 2 Door Hardtop Convertible, Starfire Convertible Only	21814
W		65-66	Quarter window seals	2DR HTP CNV	65-66 Chevrolet Impala, 66 Chevrolet Caprice, 65-66 Cadillac Calais, Deville 65-66 Oldsmobile 88, Jetstar, 65-66 Buick LeSabre, Wildcat, 65-66 Pontiac Bonneville, Catalina, Star Chief 2 Door Hardtop Convertible	2301
W		65-66	Quarter window seals	4DR HTP	65-66 Chevrolet Impala, 66 Chevrolet Caprice, 65-66 Cadillac Calais, Deville, 65-66 Oldsmobile 88 Oldsmobile 98, 65-66 Buick LeSabre, Wildcat, Electra, 65-66 Pontiac Bonneville, Catalina, Star Chief 4 Door Hardtop	23011
W		65-66	Door u-jamb seal	2DR HTP CNV	65-66 Chevrolet Impala, 66 Caprice, 65-66 Cadillac Calais, Deville, Eldorado, 65-66 Oldsmobile 88, Jetstar, Starfire, Oldsmobile 98, 65-66 Buick LeSabre, Wildcat, Electra, 65 Pontiac Bonneville, Catalina, Star Chief 2hardtop Convertible	2368
W		65-66-67-68	Vent window weatherstrip	2DR HTP CNV	65-68 Chevrolet Impala, Buick LeSabre, Electra, Wildcat, Cadillac Calais, Deville, Oldsmobile 88 Oldsmobile 98 Starfire, Pontiac Bonneville, Catalina, Star Chief 2 Door Hardtop Convertible	2217
W		65-66-67-68	Glass run channel front window	2DR HTP CNV	65-68 Chevrolet Impala, Caprice, 65-68 Cadillac Calais, Deville 65-66 Eldorado, 65-68 Oldsmobile 88 Oldsmobile 98, 65-66 Oldsmobile Jetstar, Starfire, 65-68 Buick LeSabre, Wildcat, Electra, 65-68 Pontiac Bonneville, Catalina, Executive 2 Door Hardtop Convertible	2350
W		67-68	Quarter window u-jamb	2DR HTP CNV	67-68 Chevrolet Impala, 67-68 Cadillac Calais, Deville, 67 Oldsmobile 98, 67-68 Buick, LeSabre, Wildcat, Electra, 67-68 Pontiac Bonneville, Catalina 2 Door Hardtop	2292
W		67-68	Quarter window seals	2DR HTP	67-68 Chevrolet Impala, 67-68 Cadillac Calais, Deville 67-68 Oldsmobile 88, 98, 67-68 Buick LeSabre, Wildcat, Electra 67-68 Pontiac Catalina, Bonneville, Executive 2 Door Hardtop	2302

Oldsmobile • 88, 98

OLDSMOBILE • 88, 98

CODE	IMAGE	YEAR	DESCRIPTION	BODY	FITS	ITEM#
W		67-68	Quarter window seals	CNV	67-68 Chevrolet Impala, 67-68 Cadillac Deville, 67-68 Oldsmobile 88 Oldsmobile 98, 67-68 Buick LeSabre, Wildcat, Electra, 67-68 Pontiac Catalina, Bonneville Convertible	23021
W		67-68	Quarter window u-jamb	2 DR CNV HTP	67-68 Chevy Impala Convertible 68 Caprice Sport Coupe, 67 Buick Lasabre, Wildcat Convertible, 67 Electra 2 Door Hardtop & Convertible, 68 Buick Wildcat, Electra, Lesabre 2 Door Hardtop & Convertible, 67 Cadillac Deville Convertible, 68 Cadillac Calais, Deville Hardtop & Convertible 67-68 Oldsmobile 88, Oldsmobile 98, 67-68 Pontiac Catalina, Bonneville, Executive, Grand Prix Hardtop & Convertible	2294
W		69-70	Qtr window u jamb	CNV 2DR HTP	69-70 Chevrolet Impala, 69-70 Cadillac, Eldorado, 69-70 Oldsmobile 88 Oldsmobile 98, 69-70 Buick LeSabre, Wildcat, 69 Pontiac Catalina, Executive, Bonneville Convertible 2 Door Hardtop	2293
W		71-72-73	Qtr window u jamb	2DR HTP CNV	71-73 Buick LeSabre, Electra, Riviera, Chevrolet Impala, Caprice, Cadillac Calais, Deville, Oldsmobile 88 Oldsmobile 98, Pontiac Catalina, Bonneville, Grandville 2 Door Hardtop Convertible	2600
W		71-72-73-74-75-76	Quarter window seals	2DR HTP CNV	71-75 Chevrolet Impala, Caprice, 71-76 Cadillac Eldorado Convertible Only, 71-76 Oldsmobile 88, 76 Oldsmobile 98, 71-73 Buick LeSabre, 71-73 Centurion, 71-75 Pontiac Catalina, Bonneville, Grandville 2 Door Hardtop Convertible	2308
W		71-72-73-74-75-76	Quarter window seals	4DR HTP	71-75 Chevrolet Impala, Caprice, Cadillac Calais, Deville, Pontiac Catalina, Bonneville, Grandville Buick Lesabre, Electra, Oldsmobile 88, 98, 4 Door Hardtop	2309
W		74-75-76	Quarter window u-jamb	2DR HTP CNV	Impala Caprice LeSabre Electra Eldorado Oldsmobile Delta 88 Oldsmobile 98, Tornado Delta Bonneville Catalina Grandville Catalina	2295
W		77-78-79-80-81-82-83-84-85-86-87-88-89-90	Window weatherstrip outers only, rwd with chrome bead	2DR SDN	77-90 Chevrolet Impala, Caprice, Buick LeSabre, Electra, Oldsmobile 88 Oldsmobile 98, Pontiac Catalina, Bonneville, Cadillac Deville, 2 Door Sedan	2369
W		77-78-79-80-81-82-83-84-85-86-87-88-89-90	Window weatherstrip, outers only, rwd, with o chrome bead	2DR SDN	77-90 Chevrolet Impala, Caprice, Buick LeSabre, Electra, Oldsmobile 88 Oldsmobile 98, Pontiac Catalina, Bonneville, Cadillac Deville, 2 Door Sedan	23691



GUIDE TO SOFFSEAL'S PRODUCT CODES

B = Bumper sets **C** = Glass channels **D** = Door related **G** = Seals, gaskets **H** = Under hood items **I** = Interior parts
M = Miscellaneous items **R** = Roofrail, pillar post & convertible items **T** = Trunk related **W** = Window related **Z** = Weatherstrip kits

Oldsmobile • Achieva, Firenza



CODE	IMAGE	YEAR	DESCRIPTION	BODY	FITS	ITEM#
D		82-83-84-85-86-87-88-89-90-91-92	Door weatherstrip front/rear	All	82-89 Skyhawk 92-97 Skylark 82-88 Cimarron 93-96 Fleetwood 82-94 Beretta 82-94 Cavalier 91-96 Caprice 82-96 Corsica 82-94 Lumina 82-93 S10 83-94 S10 Blazer 82-05 Chev Van 83-94 GMC Jimmy 82-93 GMC Sonoma 82-05 GMC Van 82-94 Achieva 82-85 Custom Cruiser 82-94 Firenza 82-94 Grand Am 82-94 Sunbird	9110



WHAT IS A PRODUCT CODE?

Our catalog is grouped by product CODE (type) then years. See page 1 for details explaining the different Product CODES.



Oldsmobile • Custom Cruiser, Vista Cruiser

CODE	IMAGE	YEAR	DESCRIPTION	BODY	FITS	ITEM#
D		64-65-66-67	Tailgate weatherstrip	SWG	64-67 Chevrolet Chevelle, Buick Special, Oldsmobile Vista Cruiser, F85, Pontiac, Station Wagon	5142
D		64-65-66-67	Door weatherstrip rear door with clips	4DR SDN WGN	64-67 Chevelle, LeMans, Skylark, Cutlass, Except Sport Station Wagon And Vista Cruiser, 4 Door Sedan Station Wagon	5001A
D		68-69-70-71-72	Door weatherstrip rear door with clips	SWG	68-72 Buick Cutlass Vista Cruiser 4 Door Sedan Station Wagon	5021
D		68-69-70-72-72	Door weatherstrip rear door with clips	4DR SDN SWG	68-72 Chevrolet Chevelle, Pontiac LeMans, Buick Skylark, Oldsmobile Cutlass 4 Door Sedan And Station Wagon Except Sport Station Wagon And Vista Cruiser	5020A
D		69-70	Rear door weatherstrip	SWG 4DR	69-70 Chevy Biscayne, Bel Air, Impala, Caprice, Estate, Oldsmobile Vista Cruiser, Pontiac Catalina, Bonneville, Executive, Gm Fullsize Station Wagon 4 Door	2519
D		71-72-73-74	Door weatherstrip rear with clips & molded ends	4DR SDN	71-74 Chevrolet Impala, Bel Air, Biscayne, Brookwood, Townsman, Kingswood, Buick Estate Station Wagon, Pontiac Catalina, Grand Safari, Bonneville, Oldsmobile Custom Cruiser, 4 Door Sedan	2225
D		71-72-73-74-75-76	Door weatherstrip front with clips & molded ends	4DR SWG	71-76 Chevrolet Impala, Bel Air, Biscayne, Brookwood, Townsman, Kingswood, Buick Estate Station Wagon, Pontiac Catalina, Grand Safari, Bonneville, Oldsmobile Custom Cruiser, 4 Door Station Wagon	2228
D		71-72-73-74-75-76	Door weatherstrip rear with clips & molded ends	SWG 4DR	71-76 Chevrolet Bel Air, Caprice, Impala, Brookwood, Townsman, Kingswood, Oldsmobile Custom Cruiser, Pontiac Grand Safari, Buick Estate Wagon, 4 Door Station Wagon	2227
D		75-76	Door weatherstrip rear with clips & molded ends	4DR SDN	75-76 Chevrolet Impala, Bel Air, Brookwood, Townsman, Kingwood, Buick Estate Station Wagon, Pontiac Catalina, Grand Safari, Bonneville, Oldsmobile Custom Cruiser, 4 Door Sedan	2226
D		77-78-79-80-81-82-83-84-85-86-87-88-89-90	Rear door weatherstrip with clips	4 DR SWG, RWD	77-86 Chevrolet Impala Caprice, 87-88 Caprice Caprice Classic, Cadillac, 77-85 Oldsmobile Custom Cruiser, 77-88 Estate Station Wagon, 77-81 Catalina Safari Bonneville Safari, 82 Bonneville Safari, 83 Bonneville Parisienne, 84-89 Parisienne Station Wagon, RWD Only	2503
D		82-83-84-85-86-87-88-89-90-91-92	Door weatherstrip front/rear	All	82-89 Skyhawk 92-97 Skylark 82-88 Cimarron 93-96 Fleetwood 82-94 Beretta 82-94 Cavalier 91-96 Caprice 82-96 Corsica 82-94 Lumina 82-93 S10 83-94 S10 Blazer 82-05 Chev Van 83-94 GMC Jimmy 82-93 GMC Sonoma 82-05 GMC Van 82-94 Achieva 82-85 Custom Cruiser 82-94 Firenza 82-94 Grand Am 82-94 Sunbird	9110















GUIDE TO SOFFSEAL'S PRODUCT CODES						
B = Bumper sets	C = Glass channels	D = Door related	G = Seals, gaskets	H = Under hood items	I = Interior parts	
M = Miscellaneous items	R = Roofrail, pillar post & convertible items		T = Trunk related	W = Window related	Z = Weatherstrip kits	

Oldsmobile • Custom Cruiser, Vista Cruiser



CODE	IMAGE	YEAR	DESCRIPTION	BODY	FITS	ITEM#
M		68-69-70-71-72	Core support bushing bolt kit	2DR 4DR HTP 2DR SDN CNV SWG	68-72 Chevelle El Camino Skylark Special Gran Sport Sports Wagon 442 Cutlass F85 Vista Cruiser Wagon Tempest LeMans GTO T37 Monte Carlo Impala	5167

Oldsmobile • Cutlass, 442

CODE	IMAGE	YEAR	DESCRIPTION	BODY	FITS	ITEM#
B		47-48-49-50-51-52-53-54-55-56-57-58-59-60-61-62-63-64-65-66-67-68-69-70-71-72-73-74-75-76-77-78-79-80-81-82-83-84-85-86-87	Glove box door bumpers	2DR 4DR HTP 2DR SDN CNV SWG TRK	All Chevrolet, Pontiac, Oldsmobile, Buick 47-87 Chevrolet, Gmc Truck	1069
B		59-60-61-62-63-64-65-66-67	Door bumpers	2DR HTP 2DR SDN 2DR SDN CNV SWG	59-67 Chevrolet, Pontiac, Oldsmobile, Buick, Cadillac, 62-67 Chevy II, Nova, 66-67 Chevrolet Chevelle, Oldsmobile Cutlass, Buick Skylark, Pontiac Tempest, LeMans, GTO	2320
B		62-63-64-65-66-67-68-69-70-71-72-73-74-75	Trunk bumpers	2DR HTP 2DR SDN CNV	70-75 Chevrolet Camaro, Pontiac Firebird, 62-73 Chevy II Nova, 64-72, Pontiac GTO, Tempest, Le Mans, Chevrolet Chevelle, Monte Carlo, Buick Skylark, Oldsmobile Cutlass, 65-69 Chevrolet Corvair, 65-70 Full Size Chevrolet	3112
B		64-65-66	Door bumpers	2DR 4DR HTP 2DR SDN CNV SWG	64-66 Chevrolet Chevelle, El Camino, Nova, Pontiac GTO, Tempest, LeMans, Buick Skylark, Oldsmobile Cutlass	5080
B		64-65-66-67-68-69-70-71-72	Hood adjustment bumper Tin x 1 3/4 in long x 5/16 bolt	2DR SDN 2DR 4DR HTP CNV SWG	64-66 Pontiac Tempest, LeMans, GTO, Buick Skylark, Oldsmobile Cutlass	6022
B		65-66-67-68-69-70-71-72-73-74-75-76-77-78-79-80-81-82-83-84-85-86-87-88-89-90-91-92-93-94-95-96-97-98-99-00-01-02	Door bumpers	2DR 4DR HTP 2DR SDN SWG CNV	65-66 Chevrolet, Pontiac, Oldsmobile, Buick, 65-69 Corvair, 70-02 Chevrolet Camaro, Pontiac Firebird, 68-81 Chevelle, GTO, Cutlass, Skylark, 68-72 El Camino, Tempest, LeMans GTO, 70-72 Monte Carlo	2321
B		69	License panel bumpers rear	2DR 4DR SDN HTP CNV	69 Chevrolet Camaro, Pontiac Firebird, 64-72 Chevrolet Chevelle, Pontiac Tempest, LeMans, GTO, Grand Prix, Oldsmobile Cutlass, Buick Special, Skylark	31151
B		78-79-80-81-82-83-84-85-86-87-88	Trunk bumpers	2DR SDN 2DR HTP	78-88 Chevrolet Monte Carlo, 78-83 Chevrolet Malibu, Oldsmobile Cutlass	5217
D		64-65	Door weatherstrip with clips & molded ends	2DR HTP CNV	64-65 Chevrolet Chevelle, Pontiac GTO, LeMans, Oldsmobile Cutlass, Buick Skylark 2 Door Hardtop And Convertible	5004
D		64-65	Door weatherstrip with clips	2DR SDN	64-65 Chevrolet Chevelle, Oldsmobile Cutlass, Buick Skylark, Pontiac Tempest, LeMans, GTO, Buick Special 2 Door Sedan	5003
D		64-65-66-67	Door weatherstrip rear door with clips	4DR SDN WGN	64-67 Chevelle, LeMans, Skylark, Cutlass, Except Sport Station Wagon And Vista Cruiser, 4 Door Sedan Station Wagon	5001A
D		64-65-66-67	Door weatherstrip front door with clips	4DR SDN WGN	64-67 Chevrolet Chevelle, Pontiac LeMans, Oldsmobile Cutlass, 4 Door Sedan Wagon	5001



GUIDE TO SOFFSEAL'S PRODUCT CODES

B = Bumper sets **C** = Glass channels **D** = Door related **G** = Seals, gaskets **H** = Under hood items **I** = Interior parts
M = Miscellaneous items **R** = Roofrail, pillar post & convertible items **T** = Trunk related **W** = Window related **Z** = Weatherstrip kits

Oldsmobile • Cutlass, 442



CODE	IMAGE	YEAR	DESCRIPTION	BODY	FITS	ITEM#
D		66-67	Door weatherstrip with clips	2DR SDN	66-67 Chevrolet Chevelle, Pontiac Tempest, LeMans, GTO, Oldsmobile Cutlass, 442, Buick Special, Skylark 2 Door Sedan	5000
D		66-67	Door weatherstrip with clips & molded ends	2DR HTP CNV	66-67 Pontiac GTO, LeMans, Oldsmobile Cutlass, Buick Skylark, Hardtop Convertible	6407
D		68	Door weatherstrip with clips & molded ends	2DR HTP CNV	68 Chevrolet Chevelle, Oldsmobile Cutlass, Buick Skylark, 2 Door Hardtop And Convertible	5011
D		68-69-70-71-72	Door weatherstrip rear with clips	SWG	68-72 Buick Cutlass Vista Cruiser 4 Door Sedan Station Wagon	5021
D		68-69-70-71-72	Door weatherstrip front door with clips	4DR SWG	68-72 Chevrolet Chevelle, Pontiac LeMans, Buick Skylark, 68-72 Oldsmobile Cutlass 4 Door Station Wagon	5020
D		68-69-70-72-72	Door weatherstrip rear door with clips	4DR SDN SWG	68-72 Chevrolet Chevelle, Pontiac LeMans, Buick Skylark, Oldsmobile Cutlass 4 Door Sedan And Station Wagon Except Sport Station Wagon And Vista Cruiser	5020A
D		68-69-70-71-72	Door weatherstrip with clips	2DR SDN	68-72 Chevelle, Pontiac Tempest, LeMans, GTO, Oldsmobile Cutlass 442, Buick Special, Buick Skylark, 2 Door Sedan	5002
D		69-70-71-72	Door weatherstrip with clips & molded ends	2DR HTP CNV	69-72 Chevelle, Grand Prix, Monte Carlo, Skylark, Cutlass, 2 Door Hardtop And Convertible	5022
D		73-74-75-76-77	Door weatherstrip with clips & molded ends	2DR HTP	Grand Am 2 Door 73-77 Chevrolet, LeMans, Grand LeMans, Century, Regal, Cutlass, Chevelle Malibu Laguna, El Camino, 2 Door Hardtop	5017
D		73-74-75-76-77	Front door weatherstrip with clips & molded ends	2DR 4DR SDN HTP CNV	73-77 Chevrolet Malibu, Buick Skylark, Oldsmobile Cutlass, 4 Door Sedan	5026
D		78-79-80-81-82-83-84-85-86-87	Door weatherstrip rear door with clips	4DR SDN	78-87 Chevrolet Malibu, Buick Regal, Oldsmobile Cutlass, Pontiac LeMans, 4 Door Sedan	5037
D		78-79-80-81-82-83-84-85-86-87	Door weatherstrip rear door with clips	SWG	78-87 Chevrolet Malibu, Buick Regal, Oldsmobile Cutlass, Pontiac LeMans, Station Wagon	5038
D		78-79-80-81-82-83-84-85-86-87-88	Door weatherstrip a-body with clips & molded ends	2DR HTP	78-88 Chevrolet Malibu, El Camino, Monte Carlo, Oldsmobile Cutlass, Buick Regal, Pontiac LeMans, Grand Prix 2 Door, Replacement Part For Buick, Oldsmobile And Pontiac, 82-88 Is A G Body	5025
D		78-79-80-81-82-83-84-85-87	Door weatherstrip front door with clips	4DR SDN	78-87 Chevrolet Malibu, Buick Regal, Oldsmobile Cutlass, Pontiac LeMans, 4 Door Sedan	5036
G		64-65-66-67	Cowl vent gaskets	2DR 4DR HTP 2DR SDN CNV	64-67 Buick Skylark, Oldsmobile Cutlass, Pontiac GTO, Chevrolet Chevelle	5073
G		64-65-66-67	Steering column sponge seal	2DR SDN CNV 2DR 4DR HTP SWG	64-67 Chevrolet Chevelle, El Camino, Pontiac LeMans, GTO, Oldsmobile Cutlass, Buick Skylark	5162

Oldsmobile • Cutlass, 442

CODE	IMAGE	YEAR	DESCRIPTION	BODY	FITS	ITEM#
G		66-67-68-69-70-71-72	Door handle & lock gaskets set	2DR HTP 2DR SDN CNV	67-69 Chevrolet Camaro, Pontiac Firebird, 66-72 Chevy II Nova, 64-72 Chevrolet Chevelle, Pontiac Tempest, LeMans, GTO, Buick Skylark, Oldsmobile Cutlass, 70-72 Chevrolet Monte Carlo	3021
G		68-69-70-71-72	Steering column sponge seal	2DR SDN CNV 2DR HTP SWG	68-72 Chevelle El Camino Monte Carlo, Buick Skylark, Oldsmobile Cutlass	5161
G		68-69-70-71-72	Core support seal kit	2DR HTP 2DR SDN CNV	68-72 Cutlass	7056
G		69	Back up light lens gaskets	2DR HTP 2DR SDN CNV	69 Cutlass	7062
G		69-70	Parklight lens gaskets	2DR HTP 2DR SDN CNV	69-70 Cutlass	7071
G		70	Back up light lens gaskets	2DR HTP 2DR SDN CNV	70 Cutlass	7063
G		70-71-72	Front & rear side marker light gaskets	2DR HTP 2DR SDN CNV	70-72 Oldsmobile Cutlass	7059
G		71-72	Parklight lens gaskets front bumper	2DR HTP 2DR SDN CNV	71-72 Cutlass	7061
G		78-79-80-81-82-83-84-85-86-87	Rear side marker gasket	SWG	78-87 Chevrolet El Camino, Gmc Caballero, 78-83 Chevrolet Malibu Wagon, 82-83 Pontiac Bonneville Wagon, 78-81 Pontiac LeMans Wagon, Oldsmobile Cutlass Wagon, 82-86 Oldsmobile Cutlass 4 Door Except Fwd, 78-82 Buick Century Wagon, Station Wagon	5214
H		68-69	Hood to cowl seal clip kit steel	2DR 4DR HTP 2DR SDN CNV SWG	68-69 Chevelle, El Camino, Monte Carlo, GTO, LeMans, Buick Skylark, Oldsmobile Cutlass	5075
H		68-69-70	Hood insulation	2DR HTP 2DR SDN CNV	68-70 Oldsmobile Cutlass	7057
H		68-69-70-71-72	Hood to cowl seal clip kit plastic	2DR 4DR HTP 2DR SDN CNV SWG	68-72 Chevrolet Chevelle, El Camino, Monte Carlo, Pontiac GTO LeMans, Buick Skylark, Oldsmobile Cutlass	5077
H		68-69-70-71-72	Hood to cowl seal sponge	2DR 4DR HTP 2DR SDN CNV SWG	68-72 Chevrolet Chevelle, El Camino, Monte Carlo, Pontiac GTO, LeMans, Buick Skylark, Oldsmobile Cutlass	50741
H		68-69-70-71-72	Hood to cowl seal dense	2DR 4DR HTP 2DR SDN CNV SWG	68-72 Chevrolet Chevelle, El Camino, Monte Carlo, Pontiac GTO, LeMans, Buick Skylark, Oldsmobile Cutlass	5074
H		68-69-70-71-72	Firewall clutch boot	2DR HTP 2DR SDN CNV	68-72 Chevrolet Chevelle, El Camino, Monte Carlo, Pontiac LeMans, Tempest, GTO, Buick Skylark, Oldsmobile Cutlass	5053



GUIDE TO SOFFSEAL'S PRODUCT CODES

B = Bumper sets **C** = Glass channels **D** = Door related **G** = Seals, gaskets **H** = Under hood items **I** = Interior parts
M = Miscellaneous items **R** = Roofrail, pillar post & convertible items **T** = Trunk related **W** = Window related **Z** = Weatherstrip kits

Oldsmobile • Cutlass, 442



CODE	IMAGE	YEAR	DESCRIPTION	BODY	FITS	ITEM#
H		68-69-70-71-72	A-arm seals with staples	2DR HTP 2DR SDN CNV	68-72 Oldsmobile Cutlass	7054
I		64-65-66-67-68-69-70-71-72-73-74	Park brake pedal pad	2DR HTP CNV	El Camino Cutlass Chevelle Chevy II Camaro Firebird LeMans Tempest GTO Grand Prix Full Size Centurion Century Electra Invicta LeSabre Regal Riviera Skylark Wildcat Monte Carlo	3094
I		68-69-70-71-72	Automatic brake pad	2DR 4DR HTP 2DR SDN CNV SWG	68-72 Chevrolet Chevelle, El Camino, Monte Carlo, Buick Skylark, Oldsmobile Cutlass, 71-72 Pontiac LeMans, Tempest, GTO	5058
M		64-65-66-67	Firewall pad with clips	2DR SDN 4DR HTP CNV SWG	64-67 Chevrolet Chevelle, El Camino, Buick Skylark, Oldsmobile Cutlass, Pontiac GTO, LeMans	5163
M		64-65-66-67-68-69	Rocker panel flap plug, requires 2	2DR 4DR SDN HTP CNV	64-68 Chevrolet Chevelle, Pontiac GTO, Oldsmobile Cutlass, Buick Skylark, 67-69 Chevrolet Camaro, Pontiac Firebird, 2 Door 4 Door Sedan Hardtop Convertible	5013
M		68-69-70-71-72	Core support bushing bolt kit	2DR 4DR HTP 2DR SDN CNV SWG	68-72 Chevelle El Camino Skylark Special Gran Sport Sports Wagon 442 Cutlass F85 Vista Cruiser Wagon Tempest LeMans GTO T37 Monte Carlo Impala	5167
M		68-69-70-71-72	Cnv body mount bolt kit	CNV	68-72 Chevrolet Chevelle, Oldsmobile Cutlass, Pontiac LeMans, Buick Skylark, Convertible	51647
M		68-69-70-71-72	Body mount bolt kit	2DR HTP 2DR SDN	68-72 Chevelle, Cutlass LeMans Skylark, 2 Door 4 Door Hardtop	51646
M		68-69-70-71-72	Firewall insulation pad with clips with a/c	2DR SDN CNV 2DR 4DR HTP SWG	68-72 Chevrolet Chevelle, El Camino, Buick Skylark, Oldsmobile Cutlass, Pontiac GTO, LeMans, All Models	51632
M		68-69-70-71-72	Firewall insulation pad with clips non a/c	2DR SDN CNV 4DR HTP SWG	68-72 Chevrolet Chevelle, El Camino, Buick Skylark, Oldsmobile Cutlass, Pontiac GTO, LeMans	51631
R		64-65	Weatherstrip kit for convertible top	CNV	64-65 Chevrolet Chevelle, Pontiac GTO, LeMans, Oldsmobile Cutlass, 442, Buick Skylark Convertible	5090
R		64-65	Roofrail weatherstrip with molded ends	2DR HTP	64-65 Chevrolet Chevelle, Buick Skylark, Oldsmobile Cutlass, Pontiac LeMans, GTO, 2 Door Hardtop	5005
R		64-65	Pillar post weatherstrip with molded ends	CNV	64-65 Chevrolet Chevelle, Pontiac GTO, Buick Skylark, Oldsmobile Cutlass, Convertible	5039
R		64-65-66-67	Header seal with clips, without molded ends	CNV	64-67 Chevrolet Chevelle, Pontiac GTO, LeMans, Oldsmobile Cutlass, 442, Buick Skylark, Convertible	5091
R		66-67	Header seal with clips and molded ends	CNV	66-67 Chevrolet Chevelle A Body Pontiac LeMans GTO Old Cutlass 442 Buick Special Skylark Convertible	50911

Oldsmobile • Cutlass, 442









CODE	IMAGE	YEAR	DESCRIPTION	BODY	FITS	ITEM#
R		66-67	Weatherstrip kit for convertible top	CNV	66-67 Chevrolet Chevelle, Pontiac GTO, LeMans, Oldsmobile Cutlass 442, Buick Special, Skylark, Convertible	5092
R		66-67	Pillar post weatherstrip with molded ends	CNV	66-67 Chevrolet Chevelle, Pontiac GTO, LeMans, Oldsmobile Cutlass, Buick Skylark Convertible	5040
R		66-67	Roofrail weatherstrip with molded ends	2DR HTP	66-67 Chevelle, Pontiac Tempest, LeMans, GTO, Oldsmobile Cutlass 442, Buick Special, Skylark, 2 Door Hardtop	5009
R		68	Pillar post weatherstrip with molded ends	CNV	68 Chevrolet Chevelle, Pontiac GTO, LeMans, Buick Skylark, Oldsmobile Cutlass Convertible	5041
R		68	Roofrail weatherstrip with molded ends	2DR HTP	68 Chevrolet Chevelle, Pontiac LeMans, GTO, Buick Skylark, Oldsmobile Cutlass, 2 Door Hardtop	5012
R		68-69-70-71-72	Header seal with clips and molded ends	CNV	68-72 Chevrolet Chevelle, Buick Skylark, Oldsmobile Cutlass, Pontiac LeMans, Convertible	5094
R		68-69-70-71-72	Weatherstrip kit for convertible top	CNV	68-72 Chevrolet Chevelle, Buick Skylark, Oldsmobile Cutlass, Pontiac LeMans, Convertible	5093
R		68-69-70-71-72	Conv. top Header Seal	Conv.	68-72 Chevrolet Chevelle, Pontiac LeMans, Tempest, GTO, Buick Skylark, Olds Cutlass	5054
R		69-70-71-72	Roofrail weatherstrip with molded ends	2DR HTP CNV	69-72 Chevrolet, Pontiac GTO, LeMans, Grand Prix, Buick Skylark, Oldsmobile Cutlass 442, 2 Door Hardtop	5024
R		69-70-71-72	Pillar post weatherstrip with molded ends	CNV	69-72 Chevrolet Chevelle, Pontiac LeMans, GTO, Buick Skylark, Oldsmobile Cutlass Convertible	5042
R		73-74-75-76-77	Roofrail weatherstrip	2DR HTP	73-77 Chevrolet Malibu, Pontiac LeMans, Grand Am, Buick Century, Oldsmobile Cutlass, 2 Door Hardtop	5035
R		73-74-75-76-77	Roofrail weatherstrip	2DR HTP	73-77 Cutlass Supreme, Salon, Brougham, Regal, 2 Door Hardtop	5035A
R		78-79-80-81-82-83-84-85-86-87-88	T-top weatherstrip fits on body	2DR HTP	78-88 Chevrolet Monte Carlo, Oldsmobile Cutlass, Buick Regal, Pontiac Grand Prix, 2 Door Hardtop	5402
R	 IMAGE COMING SOON	78-79-80-81-82-83-84-85-86-87-88	Auxiliary t-top sealing strips	2DR HTP	78-88 Chevrolet Monte Carlo, Oldsmobile Cutlass, Buick Regal, Pontiac Grand Prix, 2 Door Hardtop	5404
R		78-79-80-81-82-83-84-85-86-87-88	Roofrail weatherstrip	2DR HTP	78-88 Chevrolet Monte Carlo, Oldsmobile Cutlass, Buick Regal, Pontiac Grand Prix, 2 Door	5400



















GUIDE TO SOFFSEAL'S PRODUCT CODES					
B = Bumper sets	C = Glass channels	D = Door related	G = Seals, gaskets	H = Under hood items	I = Interior parts
M = Miscellaneous items	R = Roofrail, pillar post & convertible items	T = Trunk related	W = Window related	Z = Weatherstrip kits	

Oldsmobile • Cutlass, 442



CODE	IMAGE	YEAR	DESCRIPTION	BODY	FITS	ITEM#
T		64-65-66-67-68-69-70-71-72-73-74-75-76-77	Trunk weatherstrip exact profile length 17 feet	2DR 4DR HTP 2DR SDN CNV	65-72 Chevy II, 65-72 Chevrolet Biscayne, 65-75 Chevrolet Bel Air, 65-76 Chevrolet Impala, 65-76 Chevrolet Caprice, 64-77 Chevrolet Chevelle, 70-77 Chevrolet Monte Carlo, 65-76 Buick LeSabre, 64-77 Buick Wildcat, 64-77 Buick Skylark, 71-73 Buick Centurion, 64-72 Buick Grand Special, 73-77 Buick Century, 73-88 Buick Regal, 73-88 Buick Grand National, 65-76 Buick Electra, 65-76 Oldsmobile Delta 88, 67-69 Oldsmobile Delmont 88, 65-66 Oldsmobile Dynamic 88, 65-66 Oldsmobile Starfire, 65 Oldsmobile Jetstar, 64-77 Oldsmobile Cutlass 442, 64-88 Oldsmobile Cutlass, 65-76 Oldsmobile 98, 65-76 Pontiac Parisienne, 64-72 Pontiac LeMans, 65-70 Pontiac Catalina, 65-66 Pontiac Star Chief, 67-70 Pontiac Executive, 71-75 Pontiac Grand Ville, 65-77 Pontiac Grand Prix, 64-72 Pontiac Tempest, 62-72 Nova, Ventura, 73-74 Non-Hatchback, Up to 1975 with groove channel, Apollo, Nova, Omega, Ventura 65-76 C-Body	2003
T		65	Trunk mat	2DR HTP CNV	65 Oldsmobile Cutlass 442	7046
T		66-67	Trunk mat	2DR HTP CNV	66-67 Oldsmobile Cutlass 442	7047
T		68	Trunk mat	2DR HTP CNV	68 Cutlass 442	7049
T		69	Trunk mat	2DR HTP CNV	69 Oldsmobile Cutlass 442	7050
T		70-71-72	Trunk mat	2DR HTP CNV	70-72 Oldsmobile Cutlass 442	7052
T		75-76-77-78-79-80-81-82-83-84-85-86-87-88-89-90-91-92	Trunk and Hatchback weatherstrip	2DR 4DR SDN HTP CNV	77-85 Chevrolet Impala, 77-91 Chevrolet Caprice, 82-92 Chevrolet Camaro, 75-79 Chevrolet Nova, 78-88 Chevrolet Monte Carlo, 78-83 Chevrolet Malibu, 78-83 Pontiac LeMans, 82-92 Pontiac Firebird, 75-91 Pontiac Ventura, 77-86 Pontiac Parisienne, 77-81 Pontiac Catalina, 69-88 Pontiac Grand Prix, 64-87 Pontiac LeMans, Pontiac Grand Am, 64-77 Pontiac GTO, 73-79 Oldsmobile Omega, 77-85 Oldsmobile Delta 88, 77-84 Oldsmobile 98, 77-88 Oldsmobile Cutlass, 73-75 Buick Apollo, 76-79 Buick Skylark, 77-79 Phoenix, 73-88 Buick Regal, 77-84 Buick Electra, 77-85 Buick LeSabre, 77-78 Buick Riviera, 77-91 C-Body	2424
W		64	Window weatherstrip, original style with round bead	CNV	64 Oldsmobile Cutlass 442 Convertible	70371

Oldsmobile • Cutlass, 442

CODE	IMAGE	YEAR	DESCRIPTION	BODY	FITS	ITEM#
W		64	Window weatherstrip replacement style	2DR HTP	64 Oldsmobile Cutlass 442, 2 Door Hardtop	7037
W		64-65	Vent window seals	2DR HTP CNV	64-65 Chevrolet Chevelle, Pontiac GTO, LeMans, Oldsmobile Cutlass, Buick Skylark, 2 Door Hardtop Convertible	5102
W		64-65	Glass run channel front door window	2DR 4DR HTP CNV	64-65 Chevrolet Chevelle, Pontiac GTO, LeMans, Oldsmobile Cutlass, 442, Buick Skylark, 2 Door 4 Door Hardtop Convertible	5100
W		64-65	Rubber door jams u shape	2DR HTP CNV	64-65 Chevrolet Chevelle, Pontiac LeMans, GTO, Oldsmobile Cutlass, Buick Skylark 2 Door Hardtop Convertible	5113
W		64-65	Quarter window seals steel insert	CNV	64-65 Chevrolet Chevelle, Pontiac GTO, LeMans, Oldsmobile Cutlass, Buick Skylark, Convertible	5110M
W		64-65	Quarter window seals all rubber	2DR HTP	64-65 Chevrolet Chevelle, Pontiac LeMans, GTO, Oldsmobile Cutlass, Buick Skylark, 2 Door Hardtop	5109R
W		64-65	Quarter window seals all rubber	CNV	64-65 Chevrolet Chevelle, Pontiac GTO, LeMans, Oldsmobile Cutlass, Buick Skylark, Convertible	5110R
W		64-65	Quarter window seals steel insert	HTP	64-65 Chevrolet Chevelle, Pontiac LeMans, GTO, Oldsmobile Cutlass, Buick Skylark, Hardtop	5109M
W		64-65-66-67	Quarter window seal rear	CNV	64-67 Chevrolet Chevelle, Pontiac Tempest, LeMans, GTO, Oldsmobile Cutlass, 442, Buick Skylark, Convertible	5108
W		64-65-66-67	Vent window seals	2DR 4DR SDN	64-67 Chevelle, El Camino, 66-67 Oldsmobile Cutlass, Buick Skylark, 64-65 Pontiac GTO, LeMans 2 Door 4 Door Sedan	51021
W		65	Window weatherstrip replacement style	2DR HTP	65 Oldsmobile Cutlass 442, 2 Door Hardtop	70372
W		65	Window weatherstrip, original style with round bead	CNV	65 Oldsmobile Cutlass 442 Convertible	70373
W		66-67	Vent window seals	2DR HTP CNV	66-67 Chevrolet Chevelle, Pontiac GTO, LeMans, Oldsmobile Cutlass, Buick Skylark, 2 Door Hardtop Convertible	5103
W		66-67	Glass run channel front door window	2DR 4DR HTP CNV	66-67 Chevrolet Chevelle, Pontiac GTO, LeMans, Oldsmobile Cutlass, 442, Buick Skylark, Hardtop Convertible	5101
W		66-67	Window weatherstrip	CNV	66-67 Oldsmobile Cutlass 442 Convertible	7039
W		66-67	Window weatherstrip replacement style	2DR SDN	66-67 Oldsmobile Cutlass 442 2 Door Sedan	70381
W		66-67	Window weatherstrip replacement style	2DR HTP	66-67 Oldsmobile Cutlass 442 Hardtop	7038



GUIDE TO SOFFSEAL'S PRODUCT CODES











B = Bumper sets **C** = Glass channels **D** = Door related **G** = Seals, gaskets **H** = Under hood items **I** = Interior parts
M = Miscellaneous items **R** = Roofrail, pillar post & convertible items **T** = Trunk related **W** = Window related **Z** = Weatherstrip kits

Oldsmobile • Cutlass, 442



CODE	IMAGE	YEAR	DESCRIPTION	BODY	FITS	ITEM#
W		66-67	Rubber door jambs u shape	2DR HTP CNV	66-67 Chevrolet Chevelle, Pontiac LeMans, GTO, Oldsmobile Cutlass, Buick Skylark, 2 Door Hardtop Convertible	51131
W		66-67	Quarter window seals all rubber	2DR HTP CNV	66-67 Chevrolet Chevelle, Buick Skylark, Pontiac GTO, Oldsmobile Cutlass, 2 Door Hardtop Convertible	5111R
W		66-67	Quarter window seals, all rubber	2DR HTP CNV	66-67 Buick Special, Skylark, Gran Sport, Oldsmobile F85, Cutlass, 442, Pontiac Tempest, LeMans, GTO, 2 Door Hardtop Convertible	6497R
W		66-67	Quarter window seals, steel insert	2DR HTP CNV	66-67 Pontiac GTO, LeMans, Oldsmobile Cutlass, Buick Skylark, 2 Door Hardtop Convertible	6497M
W		66-67	Quarter window seals with steel insert	2DR HTP CNV	66-67 Chevrolet Chevelle, Buick Skylark, Pontiac GTO, Oldsmobile Cutlass, 2 Door Hardtop Convertible	5111M
W		67-68	Glass run channel front door window	2DR 4DR HTP CNV	67 Chevrolet Camaro, Pontiac Firebird, 68 Chevrolet Chevelle, Oldsmobile Cutlass 68, Buick Special, Skylark, 2 Door 4 Door Hardtop Convertible	3126
W		68	Vent window weatherstrip	2DR 4DR HTP	68 Chevrolet Chevelle, Pontiac LeMans, GTO, Oldsmobile Cutlass 442, Buick Special, Skylark, 2 Door Hardtop Convertible	51022
W		68	Window weatherstrip replacement style	CNV	68 Oldsmobile Cutlass 442 Convertible	7041
W		68	Window weatherstrip replacement style	2DR HTP	68 Oldsmobile Cutlass 442 2 Door Hardtop	7040
W		68-69-70-71-72	Quarter window seals, all rubber	2DR HTP CNV	68-72 Chevrolet Chevelle, Oldsmobile Cutlass, Buick Skylark, Pontiac LeMans, 69-70 Chevrolet Impala, 70-72 Chevrolet Monte Carlo, 2 Door Hardtop Convertible	5112R
W		68-69-70-71-72	Vent window weatherstrip	2DR 4DR SDN	68 Chevrolet Chevelle, Pontiac LeMans, GTO, Oldsmobile Cutlass, 442, Buick Skylark, 68-72 Chevrolet El Camino, Sedan	51031
W		68-69-70-71-72	Rubber door jambs u shape	2DR HTP CNV	68-72 Chevelle GTO Cutlass Skylark, 2 Door Hardtop Convertible	51132
W		68-69-70-71-72	Quarter window seals, with steel insert	2DR HTP CNV	68-72 Chevrolet Chevelle, Oldsmobile Cutlass, Buick Skylark, Pontiac LeMans, 69-70 Chevrolet Impala, 70-72 Chevrolet Monte Carlo, 2 Door Hardtop Convertible	5112M
W		69-70-71-72	Window weatherstrip replacement style	CNV	69-72 Cutlass 442 Convertible	7043
W		69-70-71-72	Window weatherstrip replacement style	2DR HTP	69-72 Oldsmobile Cutlass, Fast Back, 2 Door Hardtop	7042
W		69-70-71-72	Window weatherstrip replacement style	2DR HTP	69-72 Cutlass Supreme 442, 2 Door Hardtop, Square Top	7064

Oldsmobile • Cutlass, 442

CODE	IMAGE	YEAR	DESCRIPTION	BODY	FITS	ITEM#
W		70-71-72	Window weatherstrip, original style with round bead	2DR HTP	70-72 Oldsmobile Cutlass 2 Door Hardtop	7065
W		81-82-83-84-85-86-87-88	Window weatherstrip replacement style	2DR HTP	81-88 Oldsmobile Cutlass, Buick Regal, 2 Door Hardtop	7080
W		81-82-83-84-85-86-87-88	Window weatherstrip, original style with round bead	2DR HTP	81-88 Oldsmobile Cutlass, Buick Regal, 2 Door Hardtop	7081
Z		64	Weatherstrip kit, includes convertible top kit, door weatherstrips, lock gaskets, pillar post seals, quarter window seals, trunk weatherstrip, door u jamba, window weatherstrips	CNV	64 Oldsmobile Cutlass, 442, Convertible	KIT703
Z		64	Weatherstrip kit, includes door weatherstrips, door u jamba, lock gaskets, quarter window seals, roofrail weatherstrips, trunk weatherstrip, window weatherstrips	2DR HTP	64 Oldsmobile Cutlass, 442, 2 Door Hardtop	KIT705
Z		65	Weatherstrip kit, includes door weatherstrips, door u jamba, lock gaskets, quarter window seals, roofrail weatherstrips, trunk weatherstrip, window weatherstrips	2DR HTP	65 Oldsmobile Cutlass, 442, 2 Door Hardtop	KIT706
Z		65	Weatherstrip kit, includes convertible top kit, door weatherstrips, lock gaskets, pillar post seals, quarter window seals, trunk weatherstrip, door u jamba, window weatherstrips	CNV	65 Oldsmobile Cutlass, 442, Convertible	KIT725
Z		66-67	Weatherstrip kit, includes convertible top kit, door weatherstrips, lock gaskets, pillar post seals, quarter window seals, trunk weatherstrip, door u jamba, window weatherstrips	CNV	66-67 Oldsmobile Cutlass, 442, Buick Skylark, Convertible	KIT712
Z		66-67	Weatherstrip kit, includes convertible top kit, door weatherstrips, lock gaskets, pillar post seals, quarter window seals, trunk weatherstrip, door u jamba, window weatherstrips	CNV	66-67 Oldsmobile Cutlass, 442, Convertible	KIT711
Z		66-67	Weatherstrip kit, includes door weatherstrips, door u jamba, lock gaskets, quarter window seals, roofrail weatherstrips, trunk weatherstrip, window weatherstrips	2DR HTP	66-67 Oldsmobile Cutlass, 442, 2 Door Hardtop	KIT707
Z		68	Weatherstrip kit, includes door weatherstrips, door u jamba, lock gaskets, quarter window seals, roofrail weatherstrips, trunk weatherstrip, window weatherstrips. hood to cowl seal & clips	2DR HTP	68 Oldsmobile Cutlass, 442, 2 Door Hardtop	KIT713



GUIDE TO SOFFSEAL'S PRODUCT CODES











B = Bumper sets **C** = Glass channels **D** = Door related **G** = Seals, gaskets **H** = Under hood items **I** = Interior parts
M = Miscellaneous items **R** = Roofrail, pillar post & convertible items **T** = Trunk related **W** = Window related **Z** = Weatherstrip kits

Oldsmobile • Cutlass, 442



CODE	IMAGE	YEAR	DESCRIPTION	BODY	FITS	ITEM#
Z		68	Weatherstrip kit, includes convertible top kit, door weatherstrips, lock gaskets, pillar post seals, quarter window seals, trunk weatherstrip, door u jombs, window weatherstrips, hood to cowl seal & clips	CNV	68 Oldsmobile Cutlass, 442, Convertible	KIT719
Z		69-70-71-72	Weatherstrip kit, includes door weatherstrips, door u jombs, lock gaskets, quarter window seals, roofrail weatherstrips, trunk weatherstrip, window weatherstrips, hood to cowl seal & clips	2DR HTP	69-72 Oldsmobile Cutlass 2 Door Hardtop	KIT714
Z		69-70-71-72	Weatherstrip kit, includes convertible top kit, door weatherstrips, lock gaskets, pillar post seals, quarter window seals, trunk weatherstrip, door u jombs, window weatherstrips, hood to cowl seal & clips	CNV	69-72 Oldsmobile Cutlass, 442, Convertible	KIT720
Z		69-70-71-72	Weatherstrip kit, includes trunk weatherstrip, door weatherstrip, roofrail weatherstrip	2DR HTP	69-72 Buick Skylark, Chevrolet Chevelle, Oldsmobile Cutlass, 442, 2 Door Hardtop	KIT510X
Z		78-79-80-81-82-83-84-85-86-87-88	Weatherstrip kit, includes door weatherstrip, roofrail weatherstrip, trunk weatherstrip	2DR HTP	78-88 Chevrolet Monte Carlo, Buick Regal, Oldsmobile Cutlass, Pontiac Grand Prix, 2 Door Hardtop	KIT539X
Z		78-79-80-81-82-83-84-85-86-87-88	Weatherstrip kit, includes door weatherstrip, roofrail weatherstrip, trunk weatherstrip	2DR HTP	78-88 Chevrolet Monte Carlo, Buick Regal, Oldsmobile Cutlass, Pontiac Grand Prix, 2 Door Hardtop	KIT539X

Oldsmobile • Starfire, Toronado

CODE	IMAGE	YEAR	DESCRIPTION	BODY	FITS	ITEM#
C		63-64	Glass channel front	2DR HTP CNV	63-64 Chevrolet Impala, 63-64 Cadillac, 63-64 Oldsmobile 88, Oldsmobile 98 Starfire Convertible Only, 63-64 Buick LeSabre, Wildcat, Electra, 63-64 Pontiac, 2 Door Hardtop Convertible	2021
D		61-62	Door weatherstrip with clips & molded ends	2DR HTP CNV	61-62 Chevrolet Bel Air Impala, Cad Series 62, Deville, 61-62 Oldsmobile, 61 Hardtop Convertible 88 Star Fire, Oldsmobile 98/62 Oldsmobile 88 Oldsmobile 98 Starfire, 61-62 Buick 61 Hardtop Convertible, 62 Convertible Only LeSabre Invicta Electra, 61-62 Pontiac, 2 Door Hardtop Convertible	2013
D		63-64	Door weatherstrip with clips & molded ends	2DR HTP CNV	63-64 Chevrolet Impala, 63-64 Cadillac Eldorado, Deville, 63-64 Oldsmobile 88 Oldsmobile 98 Starfire 63-64 Buick LeSabre Wildcat, Electra 63 Invicta, 63-64 Pontiac Catalina, Bonneville, Grand Prix, 2 Door Hardtop Convertible	2014
D		65-66	Door weatherstrip with clips & molded ends	2DR HTP CNV	65-66 Chevrolet Impala, Caprice, 65-66 Cadillac Calais, Deville, 65-66 Oldsmobile 88, Starfire, Oldsmobile 98, 65 Jet Star, 65-66 Buick LeSabre, Wildcat Electra, 65-66 Pontiac 2 Door Hardtop Convertible	2331
D		75-76-77-78-79-80	Door weatherstrip	2DR SDN	75-80 Chevrolet Monza, Oldsmobile Starfire, Buick Skyhawk, Pontiac Sunbird H-Body Coupe	8029
G		71-72-73-74-75-76-77-78	Door handle gaskets	2DR HTP CNV 2DR SDN	71-76 Buick LeSabre, Electra, Oldsmobile 98 Oldsmobile 88, 71-78 Toronado, Cadillac, 74-76 Riviera	2514
H		64-65-66-67-68-69-70-71-72	Firewall wiring gutter plk	2DR 4DR HTP 2DR SDN SWG CNV	Chevy Chevelle, Biscayne, Bel Air, Impala, Caprice, Nova, Camaro, Cadillac Calais, Deville, Fleetwood, Oldsmobile 88, 98, Jetstar, Starfire, Pontiac Catalina, Bonneville, Firebird, Buick Lesabre, Wildcat, Electra	2328
H		71-72-73-74-75-76-77-78	Hood to cowl seal	2DR SDN 2DR HTP CNV SWG	71-78 Chevrolet Impala, Caprice, Biscayne, Bel Air, Brookwood, Townsman, Kingswood, Buick Lesabre, Centurion, Electra 225, Estate Wagon, Cadillac Calais, Deville, Eldorado, Sixty Special Brougham, Oldsmobile 88, 98, Toronado, Pontiac Catalina, Bonneville, Grandville, Safari Full Size	2191
I		55-56-57	Gear shift grommet	2DR 4DR HTP 2DR SDN CNV SWG	55-57 Chevrolet, Pontiac, Oldsmobile All	1094
I		59-60-61-62-63-64-65-66	Gear shift grommet column	2DR 4DR SDN HTP CNV	59-66 Chevrolet Biscayne, Bel Air, Impala, 59-66 Cadillac, 59-63 Oldsmobile 88 Oldsmobile 98, 61 Starfire, 64-66 Starfire, Jet Star, 59-66 Buick LeSabre, Invicta, Electra, 63 Wildcat, Riviera, 59-66 Pontiac	2185A
M		00-99	Window weld ribbon sealer 3/8 inch round	ALL BODY STYLES	All Makes And Models	08622



GUIDE TO SOFFSEAL'S PRODUCT CODES









B = Bumper sets **C** = Glass channels **D** = Door related **G** = Seals, gaskets **H** = Under hood items **I** = Interior parts
M = Miscellaneous items **R** = Roofrail, pillar post & convertible items **T** = Trunk related **W** = Window related **Z** = Weatherstrip kits

Oldsmobile • Starfire, Toronado



CODE	IMAGE	YEAR	DESCRIPTION	BODY	FITS	ITEM#
M		75-76-77-78-79-80	Door weatherstrip hatchback	2DR SDN	75-80 Chevrolet Monza, Oldsmobile Starfire, Buick Skyhawk, Pontiac Sunbird H-Body	8028
R		58-59-60-61-62-63-64	Header seal	CNV	Chevy Impala, Cadillac Series 62 Eldorado, Pontiac Catalina, Bonneville, Oldsmobile 88, 98, Starfire, Buick Lesabre, Invicta, Electra	2153
		61-62	Weatherstrip Kit For Convertible Top With 6-5/8 Between Center Stud	Cnv	61-62 Chevrolet Impala, 61-62 Olds 88, Starfire, 61 Buick LeSabre, 61-62 Invicta, 61-62 Pontiac, Catalina Bonneville Convertible	2156
<p>IMAGE COMING SOON</p>						
R		62	Pillar post weatherstrip with molded ends	CNV	61-62 Chevrolet Impala, 61-62 Cadillac 61 Series 6200, Eldorado 62 Eldorado, 61-62 Oldsmobile 88 Oldsmobile 98, Starfire, 61-62 Buick Electra, Invicta, LeSabre, 61-62 Catalina, Bonneville, Convertible	2154
R		62-63-64	Weatherstrip kit for convertible top second type with 5 3/8" between center studs	CNV	62-64 Chevrolet Impala, Oldsmobile 88, Starfire, Buick LeSabre, Invicta, Pontiac, Bonneville, Catalina, 63-64 Buick Wildcat Convertible	2152
R		62-63-64	Weatherstrip kit for convertible top with 5 3/8" between center studs cloth covered	CNV	62-64 Chevrolet Impala, Cadillac, Oldsmobile 88, Starfire, Buick LeSabre, Invicta, Wildcat, Pontiac Catalina, Bonneville	2152C
R		63-64	Pillar post weatherstrip with molded ends	CNV	63-64 Chevrolet Impala, 63-64 Cadillac 63 Series 6200, Eldorado 64 Deville, Eldorado, 63-64 Oldsmobile 88 Oldsmobile 98, Starfire, 63-64 Buick LeSabre, Wildcat, 63-64 Pontiac, Convertible	2193
R		65-66-67-68-69-70	Header seal with clips and molded ends	CNV	65 Chevrolet, 66-70 Chevrolet Impala, 65-70 Cadillac Deville, 65-70 Oldsmobile 88 Oldsmobile 98, 65 Oldsmobile Starfire, 65-70 Buick LeSabre, Wildcat, Electra, 65-70 Pontiac, Convertible	23343
T		58-59-60-61-62-63-64-65-66-67-68-69	Trunk weatherstrip exact profile	2DR 4DR HTP 2DR SDN CNV	58-64 Chevrolet Biscayne, 58-64 Chevrolet Bel Air, Chevrolet Impala, 60-69 Chevrolet Corvair, 59-64 Pontiac Parisienne, 59-64 Pontiac Catalina, 59-64 Pontiac Star Chief, 60-61 Pontiac Ventura, 62-64 Pontiac Grand Prix, 58-64 Oldsmobile Delta 88, 58-64 Oldsmobile Dynamic 88, Oldsmobile Super 88, Oldsmobile Super 98, 61-64 Oldsmobile Starfire, 64 Oldsmobile Jetstar, 59-64 Buick LeSabre, 59-62 Buick Invicta, 59-64 Buick Electra, 62-64 Buick Wildcat, 63-65 Buick Riviera, 58-60 Cadillac Deville, Cadillac Eldorado, Cadillac Series 62, Cadillac Series 60 Special, Cadillac Series 75, 58-64 C-Body	2001

Oldsmobile • Starfire, Toronado

CODE	IMAGE	YEAR	DESCRIPTION	BODY	FITS	ITEM#
T		64-65-66-67-68-69-70-71-72-73-74-75-76-77	Trunk weatherstrip exact profile length 17 feet	2DR 4DR HTP 2DR SDN CNV	65-72 Chevy II, 65-72 Chevrolet Biscayne, 65-75 Chevrolet Bel Air, 65-76 Chevrolet Impala, 65-76 Chevrolet Caprice, 64-77 Chevrolet Chevelle, 70-77 Chevrolet Monte Carlo, 65-76 Buick LeSabre, 64-77 Buick Wildcat, 64-77 Buick Skylark, 71-73 Buick Centurion, 64-72 Buick Grand Special, 73-77 Buick Century, 73-88 Buick Regal, 73-88 Buick Grand National, 65-76 Buick Electra, 65-76 Oldsmobile Delta 88, 67-69 Oldsmobile Delmont 88, 65-66 Oldsmobile Dynamic 88, 65-66 Oldsmobile Starfire, 65 Oldsmobile Jetstar, 64-77 Oldsmobile Cutlass 442, 64-88 Oldsmobile Cutlass, 65-76 Oldsmobile 98, 65-76 Pontiac Parisienne, 64-72 Pontiac LeMans, 65-70 Pontiac Catalina, 65-66 Pontiac Star Chief, 67-70 Pontiac Executive, 71-75 Pontiac Grand Ville, 65-77 Pontiac Grand Prix, 64-72 Pontiac Tempest, 62-72 Nova, Ventura, 73-74 Non-Hatchback, Up to 1975 with groove channel, Apollo, Nova, Omega, Ventura 65-76 C-Body	2003
W		55-56-57	Glass setting channel, doors only	2DR HTP 2DR SDN	55-57 Chevrolet, Pontiac Safari, Oldsmobile, 2 Door Hardtop	1211
W		55-56-57	Front of door flipper stops	2DR HTP	55-57 Chevrolet, Pontiac, Oldsmobile 2 Door Hardtop	1086
W		55-56-57	Front flipper to vent stop	2DR HTP	55-57 Chevrolet, Pontiac, Oldsmobile, 2 Door Hardtop	1088
W		55-56-57	Flipper reline kit	2DR HTP	55-57 Chevrolet, Oldsmobile, Pontiac, 2 Door Hardtop	1089
W		58-59-60-61-62-63-64	Quarter window seals	2DR HTP CNV	58-64 Chevrolet Impala, 58, 60-62 Bel Air, 58-64 Cadillac Series 62, Deville, Eldorado, 58 Oldsmobile 88 Oldsmobile 98, 59-60 Oldsmobile 88 Oldsmobile 98, 61-64 Oldsmobile 99, Starfire, 98, 64 Jetstar, 59-62 Buick LeSabre, Invicta, Electra 2 Door Hardtop Convertible	2300
W		61-62-63-64-65-66	Horizontal outer window seals	2DR 4DR HTP SDN CNV SWG	Chevy Biscayne, Bel Air, Impala, Caprice, Cadillac series 62 Deville, Eldorado, Fleetwood, Calais, Oldsmobile 88, Starfire, 98. Buick Lesabre, Invicta, Wildcat, Electra, Pontiac Catalina, Ventura, Star Chief, Bonneville	2310
W		63-64	Vent window seals	2DR HTP CNV	63-64 Chevrolet Impala, Buick Electra, Lesabre, Wildcat, Oldsmobile 98, Pontiac Catalina, Bonneville, 2 Door Hardtop Convertible, Starfire Convertible Only	21814







GUIDE TO SOFFSEAL'S PRODUCT CODES

B = Bumper sets **C** = Glass channels **D** = Door related **G** = Seals, gaskets **H** = Under hood items **I** = Interior parts
M = Miscellaneous items **R** = Roofrail, pillar post & convertible items **T** = Trunk related **W** = Window related **Z** = Weatherstrip kits

Oldsmobile • Starfire, Toronado













CODE	IMAGE	YEAR	DESCRIPTION	BODY	FITS	ITEM#
W		63-64	Vent window weatherstrip	2DR 4DR HTP	63-64 LeSabre Wildcat Coupe Deville Starfire Grand Prix	21815
W		65-66	Door u-jamb seal	2DR HTP CNV	65-66 Chevrolet Impala, 66 Caprice, 65-66 Cadillac Calais, Deville, Eldorado, 65-66 Oldsmobile 88, Jetstar, Starfire, Oldsmobile 98, 65-66 Buick LeSabre, Wildcat, Electra, 65 Pontiac Bonneville, Catalina, Star Chief 2hardtop Convertible	2368
W		65-66-67-68	Vent window weatherstrip	2DR HTP CNV	65-68 Chevrolet Impala, Buick LeSa- bre, Electra, Wildcat, Cadillac Calais, Deville, Oldsmobile 88 Oldsmobile 98 Starfire, Pontiac Bonneville, Catalina, Star Chief 2 Door Hardtop Convertible	2217
W		65-66-67-68	Glass run channel front window	2DR HTP CNV	65-68 Chevrolet Impala, Caprice, 65- 68 Cadillac Calais, Deville 65-66 Eldo- rado, 65-68 Oldsmobile 88 Oldsmobile 98, 65-66 Oldsmobile Jetstar, Starfire, 65-68 Buick LeSabre, Wildcat, Electra, 65-68 Pontiac Bonneville, Catalina, Executive 2 Door Hardtop Convertible	2350



WHAT IS A PRODUCT CODE?
 Our catalog is grouped by
 product CODE (type) then
 years. See page 1 for details
 explaining the different
 Product CODES.







Oldsmobile • Omega

CODE	IMAGE	YEAR	DESCRIPTION	BODY	FITS	ITEM#
B		47-48-49-50-51-52-53-54-55-56-57-58-59-60-61-62-63-64-65-66-67-68-69-70-71-72-73-74-75-76-77-78-79-80-81-82-83-84-85-86-87	Glove box door bumpers	2DR 4DR HTP 2DR SDN CNV SWG TRK	All Chevrolet, Pontiac, Oldsmobile, Buick 47-87 Chevrolet, Gmc Truck	1069
D		68-69-70-71-72-73-74	Door weatherstrip rear door with clips	4DR SDN	68-74 Nova 73-74 Buick Apollo, 73-74 Oldsmobile Omega, 71-74 Pontiac Ventura, 4 Door Sedan	4081A
D		68-69-70-71-72-73-74	Door weatherstrip with clips	2DR SDN	68-74 Nova 73-74 Apollo, Omega, 71-74 Ventura 2 Door Sedan	4020
D		68-69-70-71-72-73-74	Door weatherstrip front door with clips	4DR SDN	68-74 Nova 73-74 Buick Apollo, 73-74 Oldsmobile Omega, 71-74 Pontiac Ventura, 4 Door Sedan	4081
D		75-76-77-78-79	Door weatherstrip with clips	2DR SDN	75-79 Nova, 75 Apollo, 75-79 Oldsmobile Omega, 75-77 Pontiac Ventura, 77-79 Pontiac Phoenix 76-79 Buick Skylark, 2 Door Sedan	4024
D		75-76-77-78-79	Door weatherstrip rear door with clips	4DR SDN	75-79 Chevy II Nova, 75 Buick Apollo, 76-79 Buick Skylark, 75-79 Oldsmobile Omega, 75-77 Pontiac Ventura, 78-79 Phoenix, 4 Door Sedan	40814
D		75-76-77-78-79	Door weatherstrip front door with clips	4DR SDN	75-79 Chevy II Nova, 75 Buick Apollo, 76-79 Buick Skylark, 75-79 Oldsmobile Omega, 75-77 Pontiac Ventura, 78-79 Phoenix, 4 Door Sedan	40813
H		ALL-MODELS-WHERE-APPLICABLE	Air cleaner lid seal, cut to fit	2DR 4DR HTP 2DR SDN CNV SWG	GM All	2099
I		64-65-66-67-68-69-70	Sun visor tip	2DR 4DR SDN HTP CNV	64-70 All Makes And Models	4006
M		00-99	Window weld ribbon sealer 3/8 inch round	ALL BODY STYLES	All Makes And Models	08622
M		67-68-69-70-71-72-73-74-75-76-77-78-79-80-81-82-83-84	Oil filler cap	2DR 4DR SDN HTP CNV	67-84 GM All Models	5044





GUIDE TO SOFFSEAL'S PRODUCT CODES					
B = Bumper sets	C = Glass channels	D = Door related	G = Seals, gaskets	H = Under hood items	I = Interior parts
M = Miscellaneous items	R = Roofrail, pillar post & convertible items	T = Trunk related	W = Window related	Z = Weatherstrip kits	



CODE	IMAGE	YEAR	DESCRIPTION	BODY	FITS	ITEM#
T		64-65-66-67-68-69-70-71-72-73-74-75-76-77	Trunk weatherstrip exact profile length 17 feet	2DR 4DR HTP 2DR SDN CNV	65-72 Chevy II, 65-72 Chevrolet Biscayne, 65-75 Chevrolet Bel Air, 65-76 Chevrolet Impala, 65-76 Chevrolet Caprice, 64-77 Chevrolet Chevelle, 70-77 Chevrolet Monte Carlo, 65-76 Buick LeSabre, 64-77 Buick Wildcat, 64-77 Buick Skylark, 71-73 Buick Centurion, 64-72 Buick Grand Special, 73-77 Buick Century, 73-88 Buick Regal, 73-88 Buick Grand National, 65-76 Buick Electra, 65-76 Oldsmobile Delta 88, 67-69 Oldsmobile Delmont 88, 65-66 Oldsmobile Dynamic 88, 65-66 Oldsmobile Starfire, 65 Oldsmobile Jetstar, 64-77 Oldsmobile Cutlass 442, 64-88 Oldsmobile Cutlass, 65-76 Oldsmobile 98, 65-76 Pontiac Parisienne, 64-72 Pontiac LeMans, 65-70 Pontiac Catalina, 65-66 Pontiac Star Chief, 67-70 Pontiac Executive, 71-75 Pontiac Grand Ville, 65-77 Pontiac Grand Prix, 64-72 Pontiac Tempest, 62-72 Nova, Ventura, 73-74 Non-Hatchback, Up to 1975 with groove channel, Apollo, Nova, Omega, Ventura 65-76 C-Body	2003
T		73-74	Hatchback weatherstrip	2DR CPE	73-74 Buick Apollo, Chevrolet Nova, Oldsmobile Omega, Pontiac Ventura, 2 Door Coupe	4013
T		75-76-77-78-79-80-81-82-83-84-85-86-87-88-89-90-91-92	Trunk and Hatchback weatherstrip	2DR 4DR SDN HTP CNV	77-85 Chevrolet Impala, 77-91 Chevrolet Caprice, 82-92 Chevrolet Camaro, 75-79 Chevrolet Nova, 78-88 Chevrolet Monte Carlo, 78-83 Chevrolet Malibu, 78-83 Pontiac LeMans, 82-92 Pontiac Firebird, 75-91 Pontiac Ventura, 77-86 Pontiac Parisienne, 77-81 Pontiac Catalina, 69-88 Pontiac Grand Prix, 64-87 Pontiac LeMans, Pontiac Grand Am, 64-77 Pontiac GTO, 73-79 Oldsmobile Omega, 77-85 Oldsmobile Delta 88, 77-84 Oldsmobile 98, 77-88 Oldsmobile Cutlass, 73-75 Buick Apollo, 76-79 Buick Skylark, 77-79 Phoenix, 73-88 Buick Regal, 77-84 Buick Electra, 77-85 Buick LeSabre, 77-78 Buick Riviera, 77-91 C-Body	2424
W		37-38-39-40-41-42-43-44-45-46-47-48-49-50-51-52-53-54	Mohair channel liner, 4 feet of 2 7/8 inch mohair lining material	CNV 2DR 4DR HTP	Bel Air 150 210, Nomad, Chieftain, 860/870 Star Chief, Safari, Super Chief, Bonneville, Nova, Omega, Apollo, Ventura, Skylark	0420

Pontiac • Astre, Phoenix

CODE	IMAGE	YEAR	DESCRIPTION	BODY	FITS	ITEM#
D		71-72-73-74-75-76-77	Door weatherstrip with clips	2DR SDN	71-77 Chevrolet Vega, 75-77 Pontiac Astre, 2 Door, Hatchback	8201
D		75-76-77-78-79	Door weatherstrip rear door with clips	4DR SDN	75-79 Chevy II Nova, 75 Buick Apollo, 76-79 Buick Skylark, 75-79 Oldsmobile Omega, 75-77 Pontiac Ventura, 78-79 Phoenix, 4 Door Sedan	40814
D		75-76-77-78-79	Door weatherstrip front door with clips	4DR SDN	75-79 Chevy II Nova, 75 Buick Apollo, 76-79 Buick Skylark, 75-79 Oldsmobile Omega, 75-77 Pontiac Ventura, 78-79 Phoenix, 4 Door Sedan	40813
D		75-76-77-78-79	Door weatherstrip with clips	2DR SDN	75-79 Nova, 75 Apollo, 75-79 Oldsmobile Omega, 75-77 Pontiac Ventura, 77-79 Pontiac Phoenix 76-79 Buick Skylark, 2 Door Sedan	4024
M		00-99	Window weld ribbon sealer 3/8 inch round	ALL BODY STYLES	All Makes And Models	08622
M		71-72-73-74-75-76-77	Door weatherstrip	2DR SDN SWG	71-77 Chevrolet Vega, 75-77 Pontiac Astre, 2 Door Sedan Station Wagon Notchback	8200
T		64-65-66-67-68-69-70-71-72-73-74-75-76-77	Trunk weatherstrip exact profile length 17 feet	2DR 4DR HTP 2DR SDN CNV	65-72 Chevy II, 65-72 Chevrolet Biscayne, 65-75 Chevrolet Bel Air, 65-76 Chevrolet Impala, 65-76 Chevrolet Caprice, 64-77 Chevrolet Chevelle, 70-77 Chevrolet Monte Carlo, 65-76 Buick LeSabre, 64-77 Buick Wildcat, 64-77 Buick Skylark, 71-73 Buick Centurion, 64-72 Buick Grand Special, 73-77 Buick Century, 73-88 Buick Regal, 73-88 Buick Grand National, 65-76 Buick Electra, 65-76 Oldsmobile Delta 88, 67-69 Oldsmobile Delmont 88, 65-66 Oldsmobile Dynamic 88, 65-66 Oldsmobile Starfire, 65 Oldsmobile Jetstar, 64-77 Oldsmobile Cutlass 442, 64-88 Oldsmobile Cutlass, 65-76 Oldsmobile 98, 65-76 Pontiac Parisienne, 64-72 Pontiac LeMans, 65-70 Pontiac Catalina, 65-66 Pontiac Star Chief, 67-70 Pontiac Executive, 71-75 Pontiac Grand Ville, 65-77 Pontiac Grand Prix, 64-72 Pontiac Tempest, 62-72 Nova, Ventura, 73-74 Non-Hatchback, Up to 1975 with groove channel, Apollo, Nova, Omega, Ventura 65-76 C-Body	2003



WHAT IS A PRODUCT CODE?

Our catalog is grouped by product CODE (type) then years. See page 1 for details explaining the different Product CODES.



GUIDE TO SOFFSEAL'S PRODUCT CODES















B = Bumper sets **C** = Glass channels **D** = Door related **G** = Seals, gaskets **H** = Under hood items **I** = Interior parts
M = Miscellaneous items **R** = Roofrail, pillar post & convertible items **T** = Trunk related **W** = Window related **Z** = Weatherstrip kits

Pontiac • Astre, Phoenix



CODE	IMAGE	YEAR	DESCRIPTION	BODY	FITS	ITEM#
T		75-76-77-78-79-80-81-82-83-84-85-86-87-88-89-90-91-92	Trunk and Hatchback weatherstrip	2DR 4DR SDN HTP CNV	77-85 Chevrolet Impala, 77-91 Chevrolet Caprice, 82-92 Chevrolet Camaro, 75-79 Chevrolet Nova, 78-88 Chevrolet Monte Carlo, 78-83 Chevrolet Malibu, 78-83 Pontiac LeMans, 82-92 Pontiac Firebird, 75-91 Pontiac Ventura, 77-86 Pontiac Parisienne, 77-81 Pontiac Catalina, 69-88 Pontiac Grand Prix, 64-87 Pontiac LeMans, Pontiac Grand Am, 64-77 Pontiac GTO, 73-79 Oldsmobile Omega, 77-85 Oldsmobile Delta 88, 77-84 Oldsmobile 98, 77-88 Oldsmobile Cutlass, 73-75 Buick Apollo, 76-79 Buick Skylark, 77-79 Phoenix, 73-88 Buick Regal, 77-84 Buick Electra, 77-85 Buick LeSabre, 77-78 Buick Riviera, 77-91 C-Body	2424

Pontiac • Bonneville

CODE	IMAGE	YEAR	DESCRIPTION	BODY	FITS	ITEM#
B		39-40-41-42-43-44-45-46-47-48-49-50-51-52-53-54-57-64-65-66-67-68-69-70-71-72	Brake clutch pedal bumpers	2DR 4DR HTP 2DR SDN CNV SWG	39-54 And 57 Chevrolet, 55-57 Pontiac, 64-72 Chevrolet	1058
B		41-42-43-44-45-46-47-48-49-50-51-52-53-54-55-56-57	Firewall/cowl bumper, 41-48 top of firewall, 41-54 side cowl	ALL BODY STYLES	41-57 Chevrolet	0457
B		47-48-49-50-51-52-53-54-55-56-57-58-59-60-61-62-63-64-65-66-67-68-69-70-71-72-73-74-75-76-77-78-79-80-81-82-83-84-85-86-87	Glove box door bumpers	2DR 4DR HTP 2DR SDN CNV SWG TRK	All Chevrolet, Pontiac, Oldsmobile, Buick 47-87 Chevrolet, Gmc Truck	1069
B		49-50-51-52-53-54-55-56-57	Door bumpers screw in upper	2DR SDN SWG	49-57 Chevrolet 150 210 Bel Air Styleline Fleetline, Pontiac Sedan, Plus Universal Applications	1054
B		51-52-53-54-55-56-57-58	Upper vent window bumpers	2DR 4DR HTP 2DR SDN CNV SWG	51-58 Chevrolet 150 210 Bel Air Nomad Del Ray Biscayne Impala, 51-54 Chevrolet, Pontiac, Oldsmobile, Buick, Cadillac, Hardtop Convertible	1224
B		55-56-57	Tailgate liftgate bumpers	SWG	55-57 Chevrolet 150 210 Bel Air, Pontiac, Station Wagon	1227
B		55-56-57	Quarter window bumpers	CNV	55-57 Chevrolet Bel Air, Convertible	1221
B		55-56-57	Door bumpers	4DR SWG	55-57 Chevrolet 150 210 Bel Air, Pontiac, Oldsmobile, All Station Wagons, 4 Door Sedan Station Wagon	10541
B		55-56-57	Door upper bumpers push in	2DR 4DR SDN	55-57 Chevrolet 150 210 Bel Air, Pontiac, Oldsmobile, Sedan	10542
B		55-56-57	Trunk bumpers	2DR 4DR HTP 2DR SDN CNV	55-57 Chevrolet 150 210 Bel Air, Pontiac	1052
B		55-56-57	Body bumper kit	2DR HTP CNV	55-57 Chevrolet 210 Bel Air, 2 Door Hardtop Convertible	1055
B		55-56-57	Body bumper kit	2DR SDN	55-57 Chevrolet 150 210 Bel Air, Pontiac, 2 Door, Sedan	1056
B		55-56-57	Clutch pedal rebound bumper	2DR SDN 2DR 4DR HTP CNV SWG	55-57 Chevrolet, Pontiac	1096
B		55-56-57-58	Door bumpers	2DR 4DR HTP 2DR SDN CNV SWG	55-58 Chevrolet, Pontiac, Olds	1053
B		55-56-57-58-59	Upper trunk or rear license plate bumper	2DR 4DR HTP 2DR SDN CNV SWG	55-59 Chevrolet 150 210 Bel Air Nomad, Pontiac, Olds	10521





GUIDE TO SOFFSEAL'S PRODUCT CODES

B = Bumper sets **C** = Glass channels **D** = Door related **G** = Seals, gaskets **H** = Under hood items **I** = Interior parts
M = Miscellaneous items **R** = Roofrail, pillar post & convertible items **T** = Trunk related **W** = Window related **Z** = Weatherstrip kits



CODE	IMAGE	YEAR	DESCRIPTION	BODY	FITS	ITEM#
B		56-57	Door bumpers	4DR HTP	56-57 Chevrolet 210 Bel Air, Pontiac, Oldsmobile, 4 Door Hardtop	10543
B		56-57	Hood to fender bumpers	2DR 4DR HTP 2DR SDN CNV SWG	56-57 Chevrolet 150 210 Bel Air Nomad	1223
B		56-57-58-59-60-61-62-63-64-65-66-67-68-69-70-71-72-73-74	Hood adjustment bumpers round	2DR 4DR HTP 2DR SDN CNV SWG	56-74 Chevrolet, Pontiac, All Models	1222
B		57	Seat back rest bumpers	2DR 4DR HTP 2DR SDN CNV SWG	57 Chevrolet 150 210 Bel Air Nomad, Pontiac, Safari, Oldsmobile	1061
B		59-60-61-62-63	Hood to fender bumpers, 4 piece	2DR SDN 2DR 4DR HTP CNV SWG	59-63 Pontiac All	2055
B		61-62	Upper vent window bumper	2DR HTP	61-62 Chevrolet Bel Air, Impala, Pontiac Catalina, Bonneville, Ventura, Cadillac, Buick, Oldsmobile, 2 Door 4 Door Hardtop	2087
B		61-62	Upper vent window bumper	CNV	61-62 Chevrolet Impala, Bel Air, Pontiac Catalina, Bonneville, Oldsmobile 88, 98, Buick LeSabre, Electra 225, Cadillac Deville Convertible	2088
B		63-64	Upper vent window bumpers	CNV	63-64 Impala, Bonneville, Catalina, Oldsmobile 88, 98, LeSabre, Electra 225, Deville, Convertible	2203
B		63-64	Vent window bumpers, upper	2DR 4DR HTP	63-64 Chevrolet Impala, 63-64 Cadillac, Deville, 63-64 Oldsmobile 88, 98, 63-64 Buick LeSabre, Electra, 63-64 Pontiac Bonneville, Catalina, 2 Door 4 Door Hardtop	2204
B		67-68-69-70	Door bumpers	2DR 4DR HTP 2DR SDN CNV SWG	67-70 Chevrolet Biscayne, Bel Air, Impala Caprice, 67-70 Cadillac Calais, Deville, Fleetwood, 67-70 Oldsmobile 88, 98, 67-70 Buick LeSabre, Wildcat, Electra, 67-70 Pontiac	2323
C		55-56-57	Glass channel rear side window curved 4 door station wagon	SWG 4DR	55-57 Chevrolet, Pontiac, 4 Door Station Wagon	1120
C		55-56-57	Glass channel rear side window curved	2DR SWG	55-57 Chevrolet, Pontiac, Except Nomad And Safari, 2 Door Station Wagon	1121
C		55-56-57	Front glass channel	2DR 4DR HTP 2DR SDN CNV SWG	55-57 Chevrolet, Pontiac Safari, Except 55, 150 Convertible	1201
C		58	Glass channel front	2DR HTP CNV	58 Chevrolet Impala, 58 Cadillac, 58 Oldsmobile, 58 Buick, 58 Pontiac, 2 Door Hardtop	2040
C		58	Glass channel rear	2DR HTP	58 Chevrolet Impala Sport Coupe, Pontiac Bonneville Sport Coupe 2 Door Coupe	2041

Pontiac • Bonneville

CODE	IMAGE	YEAR	DESCRIPTION	BODY	FITS	ITEM#
C		59-60	Glass channel	2DR 4DR HTP CNV	59-60 Chevrolet Bel Air, Impala, Cadillac Series 62, Deville, Eldorado, Oldsmobile 88 Oldsmobile 98, Buick LeSabre, Invicta, Electra, Pontiac Catalina, Star Chief, Bonneville 2 Door 4 Door Hardtop Convertible	2080
C		59-60	Rear quarter stationary vent window seal	SWG 2DR 4DR	59-60 Chevrolet Nomad, Brookwood, Kingswood, Buick LeSabre, Invicta, Oldsmobile Fiesta 88, Pontiac Catalina, Bonneville, Safari 2 Door 4 Door Station Wagon	2218
C		61-62	Glass channel front	2DR HTP	61 Chevrolet Impala, 62 Chevrolet Bel Air, 61 Cadillac Series 62, 62 Cadillac Deville 4 Door S, 61-62 Oldsmobile 88 Oldsmobile 98, 61 Buick LeSabre, Invicta, Electra, 62 Buick, 61-62 Pontiac Catalina, Ventura, Star Chief, Bonneville 2 Door Hardtop	2161
C		61-62	Front glass channel	2DR SDN SWG 4DR	61-62 Chevrolet, Pontiac, 2 Door 4 Door Sedan And Station Wagon	21621
C		63-64	Glass channel rear	4DR HTP	63-64 Chevrolet Impala Sport Coupe, Oldsmobile 88 Holiday Sedan, Buick Lesabre, Wildcat, Pontiac Bonneville, Catalina, Star Chief 4 Door Hardtop	2188
C		63-64	Glass channel front	4DR HTP	63-64 Chevrolet Impala, 63-64 Cadillac, 63-64 Oldsmobile 88 Oldsmobile 98, 63-64 Buick, 63-64 Pontiac, 4 Door Hardtop	21841
C		63-64	Glass channel rear side stationary window	4DR SWG	61-64 Chevrolet, Buick, Oldsmobile, Pontiac 4 Door Station Wagon, All	2123
C		63-64	Windshield gasket	2DR SDN SWG	63-64 Chevrolet Biscayne, Bel Air, Impala, 63-64 Cadillac Series 62, Deville, 63-64 Oldsmobile 88 Oldsmobile 98, 63-64 Buick LeSabre, Wildcat, Electra, 63-64 Pontiac, 2 Door Sedan Station Wagon	2020
C		63-64	Glass channel front	2DR HTP CNV	63-64 Chevrolet Impala, 63-64 Cadillac, 63-64 Oldsmobile 88, Oldsmobile 98 Starfire Convertible Only, 63-64 Buick LeSabre, Wildcat, Electra, 63-64 Pontiac, 2 Door Hardtop Convertible	2021
D		55-56-57	Lower gate weatherstrip with clips & molded corner	SWG	55-57 Chevrolet 150 210 Bel Air, Pontiac Station Wagon	1226
D		55-56-57	Upper gate weatherstrip with clips & molded ends	SWG	55-57 Chevrolet 150 210 Bel Air, Pontiac, Station Wagon	1228
D		55-56-57	Door j weatherstrip with clips	2DR 4DR HTP 2DR SDN CNV SWG	55-57 Chevrolet, Pontiac, All Models	1204
D		55-56-57	Door weatherstrip with clips & molded ends	2DR HTP CNV	55-57 Chevrolet, Pontiac, 2 Door Hardtop Convertible	1000
D		55-56-57	Door weatherstrip with clips with out molded ends	2DR HTP CNV	55-57 Chevrolet, Pontiac, 2 Door Hardtop Convertible	1001



GUIDE TO SOFFSEAL'S PRODUCT CODES











B = Bumper sets **C** = Glass channels **D** = Door related **G** = Seals, gaskets **H** = Under hood items **I** = Interior parts
M = Miscellaneous items **R** = Roofrail, pillar post & convertible items **T** = Trunk related **W** = Window related **Z** = Weatherstrip kits

Pontiac • Bonneville



CODE	IMAGE	YEAR	DESCRIPTION	BODY	FITS	ITEM#
D		55-56-57-58-59-60	Door weatherstrip with clips sedan front and rear	2DR 4DR SDN SWG	55-60 Chevrolet Bel Air 150 210, Nomad, Pontiac Chieftain, Star Chief, Safari, Super Chief, Bonneville, Buick Century, Roadmaster, Special Also Station Wagon And Sedan Delivery	1003
D		56-57	Rear door weatherstrip with clips & molded ends	4DR HTP	56-57 Chevrolet 210 Bel Air, Pontiac, 4 Door Hardtop	1004
D		56-57	Front door weatherstrip with clips & molded ends	4DR HTP	56-57 Chevrolet 210 Bel Air, Pontiac, 4 Door Hardtop	1005
D		58	Door weatherstrip with clips & molded ends	2DR HTP CNV	58 Chevrolet Impala, Cadillac, Oldsmobile 88 Convertible Only, Buick Century Convertible Only, Pontiac, 2 Door Hardtop Convertible	2010
D		59-60	Door weatherstrip with clips & molded ends	2DR HTP CNV	59-60 Chevrolet Impala, Bel Air, Pontiac Catalina, Star Chief, Bonneville, Oldsmobile 88, 98, Buick LeSabre, Invicta, Electra, Cadillac Deville, Eldorado, Series 62 Hardtop Convertible	2011
D		59-60	Door j weatherstrip	2DR 4DR HTP SWG 2DR SDN 4DR SDN	59-60 Chevrolet, Pontiac, Oldsmobile, Buick, Cadillac	2093
D		59-60	Door weatherstrip front with clips & molded ends	4DR HTP	59-60 Chevrolet Impala, Bel Air, Buick LeSabre, Invicta, Oldsmobile 88, Pontiac Catalina, Star Chief, Bonneville 4 Door Hardtop	2205
D		61-62	Door weatherstrip with clips & molded ends	2DR HTP CNV	61-62 Chevrolet Bel Air Impala, Cad Series 62, Deville, 61-62 Oldsmobile, 61 Hardtop Convertible 88 Star Fire, Oldsmobile 98/62 Oldsmobile 88 Oldsmobile 98 Starfire, 61-62 Buick 61 Hardtop Convertible, 62 Convertible Only LeSabre Invicta Electra, 61-62 Pontiac, 2 Door Hardtop Convertible	2013
D		61-62	Door weatherstrip front with clips	SWG 4 DR SDN	61-62 Chevrolet BelAir, Biscayne, Impala, Pontiac, Station Wagon & 4 Dr Sedan	2019
D		61-62-63-64	Door weatherstrip rear with clips	4dr SWG	61-64 Chevrolet Biscayne, Bel Air, Impala, 61-64 Oldsmobile 88, 61-64 Buick LeSabre, 62-63 Invicta 63-64 Wildcat, 61-64 Pontiac Catalina, Bonneville, 4 Door Station Wagon	2018
D		61-62-63-64	Door weatherstrip, rear doors with clips & molded ends	4DR HTP	61-64 Chevrolet Impala, Buick LeSabre, Oldsmobile Wildcat, 88, Pontiac Catalina Star Chief Bonneville 4 Door Hardtop	2122
D		63-64	Front door weatherstrip with molded ends	4DR HTP	63-64 Chevrolet Biscayne, Bel Air, Impala, Buick Wildcat, LeSabre, Electra, Pontiac Catalina, Star Chief, Bonneville, Oldsmobile Dynamic 88, 98 4 Door Ht	2121

Pontiac • Bonneville

CODE	IMAGE	YEAR	DESCRIPTION	BODY	FITS	ITEM#
D		63-64	Door weatherstrip with clips & molded ends	2DR HTP CNV	63-64 Chevrolet Impala, 63-64 Cadillac Eldorado, Deville, 63-64 Oldsmobile 88 Oldsmobile 98 Starfire 63-64 Buick LeSabre Wildcat, Electra 63 Invicta, 63-64 Pontiac Catalina, Bonneville, Grand Prix, 2 Door Hardtop Convertible	2014
D		63-64	Door weatherstrip front with clips	4DR SDN SWG	63-64 Chevrolet Biscayne, Bel Air, Impala, 63-64 Cadillac, 63-64 Oldsmobile 88, 63-64 Buick LeSabre, Wildcat, 63-64 Pontiac, 4 Door Sedan Station Wagon	2017
D		65-66	Door weatherstrip front with clips	4DR SDN SWG	65-66 Chevrolet Biscayne Bel Air Impala, 65-66 Cadillac Calais Deville Fleetwood, 65-66 Oldsmobile 88, 65-66 Buick LeSabre Wildcat, 65-66 Pontiac Bonneville, Catalina, Star chief, 4 Door Sedan Swg	2006
D		65-66	Door weatherstrip rear station wagon with clips	4DR SWG	65-66 Chevrolet Biscayne, Bel Air, Impala, 65-66 Oldsmobile, 65-66 Buick, 65-66 Pontiac	2008
D		65-66	Door weatherstrip rear doors with clips & molded ends	4DR HTP	65-66 Chevrolet Impala, Pontiac Catalina, Bonneville, 4 Door Hardtop	2211
D		65-66	Door weatherstrip with clips & molded ends	2DR HTP CNV	65-66 Chevrolet Impala, Caprice, 65-66 Cadillac Calais, Deville, 65-66 Oldsmobile 88, Starfire, Oldsmobile 98, 65 Jet Star, 65-66 Buick LeSabre, Wildcat Electra, 65-66 Pontiac 2 Door Hardtop Convertible	2331
D		65-66-67-68	Door weatherstrip front door with clips & molded ends	4DR HTP	65-68 Chevrolet Impala, Buick, Wildcat, LeSabre, Cadillac Calais, Deville, Oldsmobile 98 Oldsmobile 99, Pontiac, 4 Door Hardtop	2210
D		67-68	Door weatherstrip rear doors with clips & molded ends	4DR HTP	67-68 Chevrolet Impala, Pontiac Catalina, Bonneville, 4 Door Hardtop	2212
D		67-68	Front door weatherstrip with clips	4DR SDN SWG	67-68 Chevrolet Biscayne, Bel Air, Impala, 67-68 Cadillac Calais, Deville, Fleetwood, 67-68 Oldsmobile Delmont 88, Delta 88, 98, 67-68 Buick LeSabre, Wildcat, Electra 67-68 Pontiac Catalina, Executive, Bonneville, 4 Door Sedan Station Wagon	23321
D		67-68	Door weatherstrip rear with clips	4DR SDN	67-68 Chevrolet Biscayne, Bel Air, Impala, 67-68 Cadillac Calais, Deville, Fleetwood, 67-68 Oldsmobile 88, 67-68 Buick LeSabre, Wildcat, 67-68 Pontiac Bonneville Station Wagon, 67-68 Pontiac Executive, Catalina, 4 Door Sedan	23322
D		67-68	Door weatherstrip with clips & molded ends	CNV 2DR HTP	67-68 Chevrolet Impala, Caprice, Except 68 Caprice 2 Door Hardtop, 67-68 Cadillac Calais, Deville, 67-68 Oldsmobile 88 Oldsmobile 98, 67-68 Buick Electra, Wildcat, 67 Pontiac Catalina, Bonneville, Executive, 67 Grand Prix Convertible 2 Door Hardtop	2342













GUIDE TO SOFFSEAL'S PRODUCT CODES					
B = Bumper sets	C = Glass channels	D = Door related	G = Seals, gaskets	H = Under hood items	I = Interior parts
M = Miscellaneous items	R = Roofrail, pillar post & convertible items	T = Trunk related	W = Window related	Z = Weatherstrip kits	

Pontiac • Bonneville



CODE	IMAGE	YEAR	DESCRIPTION	BODY	FITS	ITEM#
D		69-70	Door weatherstrip with clips & molded ends	2DR HTP CNV	69-70 Chevrolet Impala, Caprice, 69-70 Cadillac Calais, Deville, 69-70 Oldsmobile 88 Oldsmobile 98, 69-70 Buick LeSabre, Wildcat, Electra, 69-70 Pontiac Catalina, Bonneville, Executive, 2 Door Hardtop Convertible	2357
D		69-70	Door weatherstrip front doors with clips	4DR SDN SWG	69-70 Chevrolet Biscayne, Bel Air, Impala, Cadillac, Buick La Sabre, Wildcat, Pontiac, 4 Door Sedan Station Wagon	2510
D		69-70	Door weatherstrip rear doors with clips	4DR SDN	69-70 Chevrolet, Buick, Oldsmobile Delta 88, Pontiac Catalina, Bonneville Executive, 4 Door Sedan	2511
D		69-70	Rear door weatherstrip	SWG 4DR	69-70 Chevy Biscayne, Bel Air, Impala, Caprice, Estate, Oldsmobile Vista Cruiser, Pontiac Catalina, Bonneville, Executive, Gm Fullsize Station Wagon 4 Door	2519
D		71-72-73-74	Door weatherstrip rear door with clips & molded ends	4DR HTP	71-74 Chevrolet Caprice, Impala, Buick LeSabre, Centurion, Oldsmobile 88, Pontiac, 4 Door Hardtop	2214
D		71-72-73-74	Door weatherstrip rear with clips & molded ends	4DR SDN	71-74 Chevrolet Impala, Bel Air, Biscayne, Brookwood, Townsman, Kingswood, Buick Estate Station Wagon, Pontiac Catalina, Grand Safari, Bonneville, Oldsmobile Custom Cruiser, 4 Door Sedan	2225
D		71-72-73-74-75-76	Door weatherstrip front with clips & molded ends	SWG	71-76 Chevrolet Impala, Bel Air, Biscayne, Brookwood, Townsman, Kingswood, Buick Estate Station Wagon, Pontiac Catalina, Grand Safari, Bonneville, Oldsmobile Custom Cruiser, 4 Door Station Wagon	2228
D		71-72-73-74-75-76	Door weatherstrip front doors with clips & molded ends	4DR HTP	71-76 Chevrolet Caprice, Impala, Buick, Electra, LeSabre, Centurion, Cadillac Calais, Deville, Oldsmobile 88 Oldsmobile 98, Catalina, Bonneville, Granville, 4 Door Hardtop	2213
D		71-72-73-74-75-76	Door weatherstrip with clips & molded ends	2DR HTP CNV	71-76 Chevrolet Impala, Caprice, Cadillac Calais, Deville, Buick 71-73 LeSabre, Centurion, Electra, 74-76 LeSabre, Electra, Oldsmobile 88 Oldsmobile 98, Pontiac Bonneville, Catalina, 71-75 Grandville 2 Door Hardtop Convertible	2512
D		75-76	Rear Door weatherstrip with clips & molded ends	4DR HTP	75-76 Chevrolet Impala, Caprice, Buick, LeSabre, Centurion, Oldsmobile 88, Pontiac, 4 Door Hardtop	2216
D		75-76	Door weatherstrip rear with clips & molded ends	4DR SDN	75-76 Chevrolet Impala, Bel Air, Brookwood, Townsman, Kingwood, Buick Estate Station Wagon, Pontiac Catalina, Grand Safari, Bonneville, Oldsmobile Custom Cruiser, 4 Door Sedan	2226

Pontiac • Bonneville

CODE	IMAGE	YEAR	DESCRIPTION	BODY	FITS	ITEM#
D		77-78-79-80-81-82-83-84-85-86	Front door weatherstrip with clips	4DR SDN RWD	77-86 Impala Caprice, 77-84 Cadillac Deville Fleetwood, 85-86 Fleetwood, 77-84 Oldsmobile 88 89, 85 88, 77-84 Buick LeSabre Electra 85 LeSabre, 77-79 Buick Estate Wagon, 82-83 Buick Park Ave 77-81 Pontiac Bonneville, 83-86 Pontiac Parisienne, 77-80 Pontiac Catalina 4 Door Sedan, RWD Only	2500
D		77-78-79-80-81-82-83-84-85-86-87	Door weatherstrip with clips	2DR SDN RWD	84-87 Chevrolet Caprice, 77-81 Chevrolet Impala, 83 Chevrolet, 77-84 Cadillac Deville, 80-84 Fleetwood, 77-84 Oldsmobile 88 Oldsmobile 98, 85 Oldsmobile 88, 77-84 Buick LeSabre, Electra, 85 LeSabre, 77-81 Pontiac Bonneville, Catalina 2 Door Sedan, RWD Only	2359
D		77-78-79-80-81-82-83-84-85-86-87-88-89-90	Rear door weatherstrip with clips	4DR SDN RWD	77-86 Chevrolet Impala Caprice, 87-88 Caprice Caprice Classic, 89 Caprice, 90 Caprice Caprice Classic, 77-84 Cadillac Deville, 77-85 Oldsmobile 88, 77-78 Town Sedan, Custom Crusier, 77-84 Buick LeSabre Electra 85 LeSabre, 77-81 Pontiac Bonneville, Catalina, 83-86 Pontiac Parisienne 4 Door Sedan, RWD Only	2502
D		77-78-79-80-81-82-83-84-85-86-87-88-89-90	Rear door weatherstrip with clips	4 DR SWG, RWD	77-86 Chevrolet Impala Caprice, 87-88 Caprice Caprice Classic, Cadillac, 77-85 Oldsmobile Custom Cruiser, 77-88 Estate Station Wagon, 77-81 Catalina Safari Bonneville Safari, 82 Bonneville Safari, 83 Bonneville Parisienne, 84-89 Parisienne Station Wagon, RWD Only	2503
D		85-86-87-88-89-90-91	Door weatherstrip front with clips	4DR SDN FWD SWG	85-91 Buick Electra, Oldsmobile 98, 86-91 Buick LeSabre, Oldsmobile 88, 87-91 Pontiac Bonneville, 85-90 Park Avenue, 4 Door Sedan Fwd Station Wagon	2605
D		86-87-88-89-90-91	Rear door weatherstrip with clips	4DR SDN FWD	86-91 Buick LeSabre, Oldsmobile 87-91 Pontiac Bonneville, 4 Door Sedan Fwd	2603
G		58	Steering column seal with automatic trans	2DR 4DR HTP 2DR SDN CNV SWG	58 Chevrolet Pontiac	2056
G		58	Steering column seal sponge	2DR 4DR HTP 2DR SDN CNV SWG SR	58 Chevrolet Pontiac, Universal Fit Street Rod And Custom, Standard Transmission	2056A
G		58	Door handle & lock gaskets	2DR 4DR HTP 2DR SDN SWG CNV	58 Chevrolet Pontiac	2059
G		59	Door handle & lock gaskets	2DR 4DR HTP 2DR SDN CNV SWG	59 Chevrolet Pontiac	2073

















GUIDE TO SOFFSEAL'S PRODUCT CODES						
B = Bumper sets	C = Glass channels	D = Door related	G = Seals, gaskets	H = Under hood items	I = Interior parts	
M = Miscellaneous items	R = Roofrail, pillar post & convertible items		T = Trunk related	W = Window related	Z = Weatherstrip kits	

Pontiac • Bonneville



CODE	IMAGE	YEAR	DESCRIPTION	BODY	FITS	ITEM#
G		60-63-64-69-70	Door handle & lock gaskets	2DR 4DR HTP 2DR SDN CNV SWG	60 Chevrolet Biscayne, Impala, Bel Air, Cadillac, Oldsmobile 89 Oldsmobile 98, Buick LeSabre, Invicta, Electra, Wild Cat, Pontiac Catalina, Star Chief, Bonneville, Grand Prix, Ventura	2098
G		61-62-65-66-67-68	Door handle & lock gaskets	2DR 4DR HTP 2DR SDN CNV SWG	61-62 Chevrolet Biscayne, Bel Air, Impala, Cadillac, Oldsmobile 88 Oldsmobile 98, Buick LeSabre, Invicta, Electra, Pontiac	2145
G		78-79-80-81-82-83-84-85-86-87	Rear side marker gasket	SWG	78-87 Chevrolet El Camino, Gmc Caballero, 78-83 Chevrolet Malibu Wagon, 82-83 Pontiac Bonneville Wagon, 78-81 Pontiac LeMans Wagon, Oldsmobile Cutlass Wagon, 82-86 Oldsmobile Cutlass 4 Door Except Fwd, 78-82 Buick Century Wagon, Station Wagon	5214
H		55-56-57	Firewall grommet	2DR 4DR HTP 2DR SDN SWG CNV	55-57 Chevrolet All, Pontiac, Olds	1026
H		56-57-58-59-60	Firewall grommet main wiring harness	2DR 4DR HTP 2DR SDN 2DR SDN SWG CNV	56-60 Chevrolet, Pontiac, Olds	1027
H		57	A-arm seals with staples	2DR 4DR HTP 2DR SDN CNV SWG	57 Chevrolet 150 210 Bel Air Nomad	1084
H		57	Hood to cowl seal	2DR 4DR HTP 2DR SDN CNV SWG	57 Chevrolet 150 210 Bel Air	1101
H		57	Hood to cowl seal clips & screws	2DR 4DR HTP 2DR SDN CNV SWG	57 Chevrolet 150 210 Bel Air	1102
H		64	Hood insulation	2DR 4DR HTP 2DR SDN CNV SWG	64 Pontiac	2150
H		64-65-66-67-68-69-70-71-72	Firewall wiring gutter plk	2DR 4DR HTP 2DR SDN SWG CNV	Chevy Chevelle, Biscayne, Bel Air, Impala, Caprice, Nova, Camaro, Cadillac Calais, Deville, Fleetwood, Oldsmobile 88, 98, Jetstar, Starfire, Pontiac Catalina, Bonneville, Firebird, Buick Lesabre, Wildcat, Electra	2328
H		71-72-73-74-75-76-77-78	Hood to cowl seal	2DR SDN 2DR HTP CNV SWG	71-78 Chevrolet Impala, Caprice, Biscayne, Bel Air, Brookwood, Townsman, Kingswood, Buick Lesabre, Centurion, Electra 225, Estate Wagon, Cadillac Calais, Deville, Eldorado, Sixty Special Brougham, Oldsmobile 88, 98, Tornado, Pontiac Catalina, Bonneville, Grandville, Safari Full Size	2191
I		55-56-57	Gear shift grommet	2DR 4DR HTP 2DR SDN CNV SWG	55-57 Chevrolet, Pontiac, Oldsmobile All	1094

Pontiac • Bonneville

CODE	IMAGE	YEAR	DESCRIPTION	BODY	FITS	ITEM#
I		55-56-57-61-62-63-64	Glove box arm grommet	2DR 4DR HTP 2DR SDN CNV SWG	55-57 And 61-64 Chevrolet, Pontiac, Oldsmobile All	10691
I		58	Gear shift grommet column	2DR 4DR SDN HTP CNV	58 Chevrolet Del Ray, Biscayne, Bel Air, Impala, Cadillac, Oldsmobile 88 Oldsmobile 98, Buick Special, Century, Roadmaster, Riviera, Pontiac	2185
I		59-60-61-62-63-64-65-66	Gear shift grommet column	2DR 4DR SDN HTP CNV	59-66 Chevrolet Biscayne, Bel Air, Impala, 59-66 Cadillac, 59-63 Oldsmobile 88 Oldsmobile 98, 61 Starfire, 64-66 Starfire, Jet Star, 59-66 Buick LeSabre, Invicta, Electra, 63 Wildcat, Riviera, 59-66 Pontiac	2185A
M		55-56-57	Lower speedo cable wiring harness grommet	2DR 4DR HTP SDN CNV SWG	55-57 Chevrolet, Pontiac, 2 Door 4 Door Hardtop Sedan Convertible Station Wagon	1099
M		55-56-57-59-60-61	Gear tube grommet	2DR 4DR HTP SDN CNV SWG	55-57 And 59-60 Chevrolet Pontiac, Oldsmobile, 60-61 Chevrolet Truck, Gmc Truck, 2 Door 4 Door Hardtop Sedan Convertible Station Wagon	1095
R		55-56-57	Header seal	CNV	55-57 Chevrolet Bel Air, Pontiac Convertible	1031
R		56-57	Roofrail weatherstrip	4DR HTP	56-57 Chevrolet 210 Bel Air, Pontiac, 4 Door Hardtop	1028
R		58	Roofrail weatherstrip with clips	2DR HTP	58 Chevrolet Impala, Cadillac, Oldsmobile, Buick, Pontiac, 2 Door Hardtop	2043
R		58-59-60-61-62-63-64	Header seal	CNV	Chevy Impala, Cadillac Series 62 Eldorado, Pontiac Catalina, Bonneville, Oldsmobile 88, 98, Starfire, Buick Lesabre, Invicta, Electra	2153
R		59-60	Roofrail weatherstrip with clips	2DR HTP	59-60 Chevrolet, Cadillac, Pontiac, Oldsmobile, Buick, 2 Door Hardtop	2090
R		59-60	Pillar post weatherstrip with clips and molded ends	CNV	59-60 Chevrolet Impala, Cadillac Eldorado Series 62, Pontiac Bonneville, Catalina, Oldsmobile 88 Oldsmobile 98, Buick LeSabre, Invicta, Electra	2091
R		61	Roofrail weatherstrip with molded ends	2DR HTP	61 Chevrolet, Buick, Oldsmobile, Pontiac 2 Door Hardtop	2129
R		61-62	Weatherstrip Kit For Convertible Top With 6-5/8 Between Center Stud	Cnv	61-62 Chevrolet Impala, 61-62 Olds 88, Starfire, 61 Buick LeSabre, 61-62 Invicta, 61-62 Pontiac, Catalina Bonneville Convertible	2156
R		61-62	Roofrail weatherstrip	4DR HTP	61-62 Chevrolet Bel Air, Impala, Buick, LeSabre, Invicta, Oldsmobile 88, Pontiac, 4 Door Hardtop	2223
R		62	Pillar post weatherstrip with molded ends	CNV	61-62 Chevrolet Impala, 61-62 Cadillac 61 Series 6200, Eldorado 62 Eldorado, 61-62 Oldsmobile 88 Oldsmobile 98, Starfire, 61-62 Buick Electra, Invicta, LeSabre, 61-62 Catalina, Bonneville, Convertible	2154



GUIDE TO SOFFSEAL'S PRODUCT CODES







B = Bumper sets **C** = Glass channels **D** = Door related **G** = Seals, gaskets **H** = Under hood items **I** = Interior parts
M = Miscellaneous items **R** = Roofrail, pillar post & convertible items **T** = Trunk related **W** = Window related **Z** = Weatherstrip kits

Pontiac • Bonneville



CODE	IMAGE	YEAR	DESCRIPTION	BODY	FITS	ITEM#
R		62	Roofrail weatherstrip with molded ends	2DR HTP	62 Chevrolet Impala, 62 Cadillac, 62 Oldsmobile 88, 62 Buick LeSabre, Invicta, Pontiac 2 Door Hardtop	2164
R		62-63-64	Weatherstrip kit for convertible top second type with 5 3/8" between center studs	CNV	62-64 Chevrolet Impala, Oldsmobile 88, Starfire, Buick LeSabre, Invicta, Pontiac, Bonneville, Catalina, 63-64 Buick Wildcat Convertible	2152
R		62-63-64	Weatherstrip kit for convertible top with 5 3/8" between center studs cloth covered	CNV	62-64 Chevrolet Impala, Cadillac, Oldsmobile 88, Starfire, Buick LeSabre, Invicta, Wildcat, Pontiac Catalina, Bonneville	2152C
R		63-64	Pillar post weatherstrip with molded ends	CNV	63-64 Chevrolet Impala, 63-64 Cadillac 63 Series 6200, Eldorado 64 Deville, Eldorado, 63-64 Oldsmobile 88 Oldsmobile 98, Starfire, 63-64 Buick LeSabre, Wildcat, 63-64 Pontiac, Convertible	2193
R		63-64	Roofrail weatherstrip with molded ends	2DR HTP	63-64 Chevrolet Impala, 63-64 Cadillac, 63-64 Oldsmobile 88, 63-64 Buick LeSabre, Wildcat, 63-64 Pontiac 2 Door Hardtop	2194
R		63-64	Roofrail weatherstrip with molded ends	4DR HTP	63-64 Chevrolet Impala, Buick LeSabre, Wildcat, Oldsmobile 88, Pontiac, 4 Door Hardtop	2194A
R		65	Weatherstrip kit for convertible top	CNV	65 Chevrolet Impala, 65 Cadillac, 65 Oldsmobile, 65 Buick LeSabre, Wildcat, 65 Pontiac, Convertible	2365
R		65-66	Roofrail weatherstrip with molded ends	2DR HTP	65-66 Chevrolet Impala, Caprice, 65-66 Cadillac Calais, Deville, 65-66 Oldsmobile 88, Jet Star, Star Fire, Oldsmobile 98, 65-66 Buick LeSabre, Wildcat, Electra, 65-66 Pontiac 2 Door Hardtop	2333
R		65-66	Roofrail weatherstrip with molded ends	4DR HTP	65-66 Chevrolet Impala, Caprice, 65-66 Cadillac, 65-66 Oldsmobile 88, 65-66 Buick LeSabre, 65-66 Pontiac, 4 Door Hardtop	2333A
R		65-66-67-68-69-70	Header seal with clips and molded ends	CNV	65 Chevrolet, 66-70 Chevrolet Impala, 65-70 Cadillac Deville, 65-70 Oldsmobile 88 Oldsmobile 98, 65 Oldsmobile Starfire, 65-70 Buick LeSabre, Wildcat, Electra, 65-70 Pontiac, Convertible	23343
R		66-68	Pillar post weatherstrip with molded ends	CNV	66-68 Chevrolet Impala, 66-68 Cadillac Deville, 66 Cadillac Eldorado, 66-68 Oldsmobile 88 Oldsmobile 98, 66-68 Buick Electra, LeSabre, Wildcat, 66-68 Pontiac, Convertible	23341
R		66-67-68-69-70	Weatherstrip kit for convertible top includes header seal (7 piece kit)	CNV	66-70 Chevrolet Impala, 66-70 Oldsmobile 88, 66-70 Buick LeSabre, Wildcat, 66-70 Pontiac Bonneville, Catalina, 67 Pontiac Grand Prix, Convertible	2366
R		67-68	Roofrail weatherstrip with thick c pillar section	4DR HTP	67-68 Chevrolet Impala, Caprice, Buick LeSabre, Wildcat, Pontiac Bonneville, Catalina, Executive 4 Door Hardtop	2351

Pontiac • Bonneville

CODE	IMAGE	YEAR	DESCRIPTION	BODY	FITS	ITEM#
R		69-70	Roofrail weatherstrip with molded ends	2DR HTP	69-70 Chevrolet Caprice, Impala, 69-70 Cadillac, 69-70 Oldsmobile 88, 69-70 Buick LeSabre, Wildcat, 69-70 Pontiac 2 Door Hardtop	2356
R		69-70	Roofrail weatherstrip	4DR HTP	69-70 Chevrolet Impala, Caprice, 69-70 Oldsmobile 88 Oldsmobile 98, 69-70 Buick LeSabre, Wildcat, Electra, 69-70 Pontiac Catalina, Bonneville, Executive 4 Door Hardtop	23561
R		69-70	Pillar post weatherstrip with molded ends	CNV	69-70 Chevrolet Impala, Caprice, 69-70 Cadillac Deville, 69-70 Oldsmobile 88 Oldsmobile 98, 69-70 Buick LeSabre, Wildcat, Electra, 69-70 Pontiac, Convertible	2358
R		71-72-73	Roofrail weatherstrip	2DR HTP	71-73 Chevrolet Impala, 71-73 Cadillac, 71-73 Oldsmobile 88, 71-73 Pontiac, 2 Door Hardtop	2420
R		71-72-73-74	Roofrail weatherstrip	4DR HTP	71-74 Chevrolet Caprice, Impala, Buick LeSabre, Centurion, Oldsmobile 88, Pontiac Catalina, Bonneville 4 Door Hardtop	2221
R		71-72-73-74-75	Roofrail weatherstrip	2DR HTP	71-73 Impala Custom Coupe Caprice, 74-75 Impala Sport Coupe, 71-76 Cadillac Calais Deville, 71-74 Electra, 74-76 LeSabre, 71-71 98, 74 Oldsmobile 98 Oldsmobile Delta 88, 75-76 Oldsmobile Delta 88, 71-73 Grandville, 74 Bonneville Catalina Grandville, 75-76 Catalina, 2 Door Hardtop	2509
T		55-56	Trunk weatherstrip	2DR 4DR HTP 2DR SDN CNV	55-56 Chevrolet 150, Chevrolet 210, Chevrolet Bel Air, Chevrolet Nomad, Oldsmobile 98, Pontiac Chieftan, Pontiac 860, Pontiac 870, Pontiac Super Chief, Pontiac Bonneville, Pontiac Star Chief, Pontiac Safari	6012
T		55-56-57	Trunk mat	2DR 4DR HTP 2DR SDN 4DR SDN	55-57 Chevrolet 150 210 Bel Air, Pontiac, Hardtop Sedan	1217
T		55-56-57	Trunk mat	CNV	55-57 Chevrolet Bel Air, Pontiac, Convertible	1217A
T		55-56-57	Trunk area access plugs	2DR 4DR HTP 2DR SDN CNV	55-57 Chevrolet 150 210 Bel Air, Pontiac	1218
T		55-56-57	Spare tire well plugs	2DR 4DR HTP 2DR SDN CNV	55-57 Chevrolet 150 210 Bel Air, Pontiac Chieftan, Starchief, Super Chief, Oldsmobile	1219
T		57	Trunk weatherstrip with clips	2DR 4DR HTP 2DR SDN CNV	57 Chevrolet, Pontiac Except Star Chief	1011
T		62-63-64-65-66-67-68-69-70-71-72-73	Door and tailgate bottom drain hole seal	2DR 4DR HTP SDN CNV SWG CPE	62-73 Chevy Nova, Chevelle, Impala, Caprice Pontiac Catalina, Star Chief, Bonneville, Grand Prix Oldsmobile F85	2118
W		37-38-39-40-41-42-43-44-45-46-47-48-49-50-51-52-53-54	Mohair channel liner, 4 feet of 2 7/8 inch mohair lining material	CNV 2DR 4DR HTP	Bel Air 150 210, Nomad, Chieftan, 860/870 Star Chief, Safari, Super Chief, Bonneville, Nova, Omega, Apollo, Ventura, Skylark	0420



GUIDE TO SOFFSEAL'S PRODUCT CODES











B = Bumper sets **C** = Glass channels **D** = Door related **G** = Seals, gaskets **H** = Under hood items **I** = Interior parts
M = Miscellaneous items **R** = Roofrail, pillar post & convertible items **T** = Trunk related **W** = Window related **Z** = Weatherstrip kits

Pontiac • Bonneville



CODE	IMAGE	YEAR	DESCRIPTION	BODY	FITS	ITEM#
W		55-56-57	Glass setting channel, doors only	2DR HTP 2DR SDN	55-57 Chevrolet, Pontiac Safari, Oldsmobile, 2 Door Hardtop	1211
W		55-56-57	Front of door flipper stops	2DR HTP	55-57 Chevrolet, Pontiac, Oldsmobile 2 Door Hardtop	1086
W		55-56-57	Front flipper to vent stop	2DR HTP	55-57 Chevrolet, Pontiac, Oldsmobile, 2 Door Hardtop	1088
W		55-56-57	Flipper reline kit	2DR HTP	55-57 Chevrolet, Oldsmobile, Pontiac, 2 Door Hardtop	1089
W		58	Quarter window u-jamb	2DR HTP	58 Chevrolet Impala, Cadillac, Oldsmobile, Buick, Pontiac, 2 Door Hardtop	2285
W		58-59-60	Quarter window u-jamb	CNV	58-60 Chevrolet Impala, 58 Cadillac, 59-60 Cadillac Series 62, Eldorado, 58-60 Oldsmobile 88 Oldsmobile 98, 58 Buick, 59-60 Buick LeSabre, Invicta, Electra, 58 Pontiac, Convertible	2286
W		58-59-60-61-62-63-64	Quarter window seals	2DR HTP CNV	58-64 Chevrolet Impala, 58, 60-62 Bel Air, 58-64 Cadillac Series 62, Deville, Eldorado, 58 Oldsmobile 88 Oldsmobile 98, 59-60 Oldsmobile 88 Oldsmobile 98, 61-64 Oldsmobile 99, Starfire, 98, 64 Jetstar, 59-62 Buick LeSabre, Invicta, Electra 2 Door Hardtop Convertible	2300
W		61-62	Vent window seals	2DR 4DR HTP CNV	61-62 Chevrolet Bel Air, Impala, 61-62 Cadillac Series 62, Eldorado, 61-62 Oldsmobile 88 Oldsmobile 98, 61-62 Buick LeSabre, Invicta, Electra, 61-62 Pontiac Bonneville, Catalina, Ventura 2 Door 4 Door Hardtop, Convertible	21615
W		61-62-63-64-65-66	Horizontal outer window seals	2DR 4DR HTP SDN CNV SWG	Chevy Biscayne, Bel Air, Impala, Caprice, Cadillac series 62 Deville, Eldorado, Fleetwood, Calais, Oldsmobile 88, Starfire, 98. Buick Lesabre, Invicta, Wildcat, Electra, Pontiac Catalina, Ventura, Star Chief, Bonneville	2310
W		63-64	Vent window seals	2DR HTP CNV	63-64 Chevrolet Impala, Buick Electra, Lesabre, Wildcat, Oldsmobile 98, Pontiac Catalina, Bonneville, 2 Door Hardtop Convertible, Starfire Convertible Only	21814
W		65-66	Door u-jamb seal	2DR HTP CNV	65-66 Chevrolet Impala, 66 Caprice, 65-66 Cadillac Calais, Deville, Eldorado, 65-66 Oldsmobile 88, Jetstar, Starfire, Oldsmobile 98, 65-66 Buick LeSabre, Wildcat, Electra, 65 Pontiac Bonneville, Catalina, Star Chief 2hardtop Convertible	2368
W		65-66	Quarter window seals	2DR HTP CNV	65-66 Chevrolet Impala, 66 Chevrolet Caprice, 65-66 Cadillac Calais, Deville 65-66 Oldsmobile 88, Jetstar, 65-66 Buick LeSabre, Wildcat, 65-66 Pontiac Bonneville, Catalina, Star Chief 2 Door Hardtop Convertible	2301

Pontiac • Bonneville

CODE	IMAGE	YEAR	DESCRIPTION	BODY	FITS	ITEM#
W		65-66	Quarter window seals	4DR HTP	65-66 Chevrolet Impala, 66 Chevrolet Caprice, 65-66 Cadillac Calais, Deville, 65-66 Oldsmobile 88 Oldsmobile 98, 65-66 Buick LeSabre, Wildcat, Electra, 65-66 Pontiac Bonneville, Catalina, Star Chief 4 Door Hardtop	23011
W		65-66-67-68	Vent window weatherstrip	2DR HTP CNV	65-68 Chevrolet Impala, Buick LeSabre, Electra, Wildcat, Cadillac Calais, Deville, Oldsmobile 88 Oldsmobile 98 Starfire, Pontiac Bonneville, Catalina, Star Chief 2 Door Hardtop Convertible	2217
W		65-66-67-68	Glass run channel front window	2DR HTP CNV	65-68 Chevrolet Impala, Caprice, 65-68 Cadillac Calais, Deville 65-66 Eldorado, 65-68 Oldsmobile 88 Oldsmobile 98, 65-66 Oldsmobile Jetstar, Starfire, 65-68 Buick LeSabre, Wildcat, Electra, 65-68 Pontiac Bonneville, Catalina, Executive 2 Door Hardtop Convertible	2350
W		67-68	Quarter window u-jamb	2DR HTP CNV	67-68 Chevrolet Impala, 67-68 Cadillac Calais, Deville, 67 Oldsmobile 98, 67-68 Buick LeSabre, Wildcat, Electra, 67-68 Pontiac Bonneville, Catalina 2 Door Hardtop	2292
W		67-68	Quarter window seals	2DR HTP	67-68 Chevrolet Impala, 67-68 Cadillac Calais, Deville 67-68 Oldsmobile 88, 98, 67-68 Buick LeSabre, Wildcat, Electra 67-68 Pontiac Catalina, Bonneville, Executive 2 Door Hardtop	2302
W		67-68	Quarter window seals	CNV	67-68 Chevrolet Impala, 67-68 Cadillac Deville, 67-68 Oldsmobile 88 Oldsmobile 98, 67-68 Buick LeSabre, Wildcat, Electra, 67-68 Pontiac Catalina, Bonneville Convertible	23021
W		67-68	Quarter window u-jamb	2 DR CNV HTP	67-68 Chevy Impala Convertible 68 Caprice Sport Coupe, 67 Buick Lasabre, Wildcat Convertible, 67 Electra 2 Door Hardtop & Convertible, 68 Buick Wildcat, Electra, Lesabre 2 Door Hardtop & Convertible, 67 Cadillac Deville Convertible, 68 Cadillac Calais, Deville Hardtop & Convertible 67-68 Oldsmobile 88, Oldsmobile 98, 67-68 Pontiac Catalina, Bonneville, Executive, Grand Prix Hardtop & Convertible	2294
W		69-70	Qtr window u jamb	CNV 2DR HTP	69-70 Chevrolet Impala, 69-70 Cadillac, Eldorado, 69-70 Oldsmobile 88 Oldsmobile 98, 69-70 Buick LeSabre, Wildcat, 69 Pontiac Catalina, Executive, Bonneville Convertible 2 Door Hardtop	2293
W		71-72-73	Qtr window u jamb	2DR HTP CNV	71-73 Buick LeSabre, Electra, Riviera, Chevrolet Impala, Caprice, Cadillac Calais, Deville, Oldsmobile 88 Oldsmobile 98, Pontiac Catalina, Bonneville, Grandville 2 Door Hardtop Convertible	2600
W		71-72-73-74-75-76	Quarter window seals	2DR HTP CNV	71-75 Chevrolet Impala, Caprice, 71-76 Cadillac Eldorado Convertible Only, 71-76 Oldsmobile 88, 76 Oldsmobile 98, 71-73 Buick LeSabre, 71-73 Centurion, 71-75 Pontiac Catalina, Bonneville, Grandville 2 Door Hardtop Convertible	2308







GUIDE TO SOFFSEAL'S PRODUCT CODES

B = Bumper sets **C** = Glass channels **D** = Door related **G** = Seals, gaskets **H** = Under hood items **I** = Interior parts
M = Miscellaneous items **R** = Roofrail, pillar post & convertible items **T** = Trunk related **W** = Window related **Z** = Weatherstrip kits

Pontiac • Bonneville



CODE	IMAGE	YEAR	DESCRIPTION	BODY	FITS	ITEM#
W		71-72-73-74-75-76	Quarter window seals	4DR HTP	71-75 Chevrolet Impala, Caprice, Cadillac Calais, Deville, Pontiac Catalina, Bonneville, Grandville Buick Lesabre, Electra, Oldsmobile 88, 98, 4 Door Hardtop	2309
W		74-75-76	Quarter window u-jamb	2DR HTP CNV	Impala Caprice LeSabre Electra Eldorado Oldsmobile Delta 88 Oldsmobile 98, Tornado Delta Bonneville Catalina Grandville Catalina	2295
W		77-78-79-80-81-82-83-84-85-86-87-88-89-90	Window weatherstrip outers only, rwd with chrome bead	2DR SDN	77-90 Chevrolet Impala, Caprice, Buick LeSabre, Electra, Oldsmobile 88 Oldsmobile 98, Pontiac Catalina, Bonneville, Cadillac Deville, 2 Door Sedan	2369
W		77-78-79-80-81-82-83-84-85-86-87-88-89-90	Window weatherstrip, outers only, rwd, with chrome bead	2DR SDN	77-90 Chevrolet Impala, Caprice, Buick LeSabre, Electra, Oldsmobile 88 Oldsmobile 98, Pontiac Catalina, Bonneville, Cadillac Deville, 2 Door Sedan	23691

Pontiac • Catalina













CODE	IMAGE	YEAR	DESCRIPTION	BODY	FITS	ITEM#
B		59-60	Vent window bumpers upper	2DR HTP	59-60 Chevrolet Bel Air, Impala Pontiac Catalina, Star chief Oldsmobile Dynamic 88, Super 88, 98, Cadillac Deville, Eldorado, Series 62, Buick Lesabre, Invicta, Electra Full Size 2 Door Hardtop	2202
B		59-60-61-62-63	Hood to fender bumpers, 4 piece	2DR SDN 2DR 4DR HTP CNV SWG	59-63 Pontiac All	2055
B		61-62	Upper vent window bumper	2DR HTP	61-62 Chevrolet Bel Air, Impala, Pontiac Catalina, Bonneville, Ventura, Cadillac, Buick, Oldsmobile, 2 Door 4 Door Hardtop	2087
B		61-62	Upper vent window bumper	CNV	61-62 Chevrolet Impala, Bel Air, Pontiac Catalina, Bonneville, Oldsmobile 88, 98, Buick LeSabre, Electra 225, Cadillac Deville Convertible	2088
B		63-64	Upper vent window bumpers	CNV	63-64 Impala, Bonneville, Catalina, Oldsmobile 88, 98, LeSabre, Electra 225, Deville, Convertible	2203
B		63-64	Vent window bumpers, upper	2DR 4DR HTP	63-64 Chevrolet Impala, 63-64 Cadillac, Deville, 63-64 Oldsmobile 88, 98, 63-64 Buick LeSabre, Electra, 63-64 Pontiac Bonneville, Catalina, 2 Door 4 Door Hardtop	2204
B		67-68-69-70	Door bumpers	2DR 4DR HTP 2DR SDN CNV SWG	67-70 Chevrolet Biscayne, Bel Air, Impala Caprice, 67-70 Cadillac Calais, Deville, Fleetwood, 67-70 Oldsmobile 88, 98, 67-70 Buick LeSabre, Wildcat, Electra, 67-70 Pontiac	2323
C		59-60	Rear quarter stationary vent window seal	SWG 2DR 4DR	59-60 Chevrolet Nomad, Brookwood, Kingswood, Buick LeSabre, Invicta, Oldsmobile Fiesta 88, Pontiac Catalina, Bonneville, Safari 2 Door 4 Door Station Wagon	2218
C		59-60	Glass channel	2DR 4DR HTP CNV	59-60 Chevrolet Bel Air, Impala, Cadillac Series 62, Deville, Eldorado, Oldsmobile 88 Oldsmobile 98, Buick LeSabre, Invicta, Electra, Pontiac Catalina, Star Chief, Bonneville 2 Door 4 Door Hardtop Convertible	2080
C		61-62	Glass channel front	2DR HTP	61 Chevrolet Impala, 62 Chevrolet Bel Air, 61 Cadillac Series 62, 62 Cadillac Deville 4 Door S, 61-62 Oldsmobile 88 Oldsmobile 98, 61 Buick LeSabre, Invicta, Electra, 62 Buick, 61-62 Pontiac Catalina, Ventura, Star Chief, Bonneville 2 Door Hardtop	2161
C		61-62	Glass channel front	CNV HT	62 Chevrolet, Pontiac, Oldsmobile, Buick, Cadillac Formal Roof Hardtop, 61-62 Convertible, 61 Pontiac, Oldsmobile, Buick, Cadillac Formal Roof Hardtop	2162
C		61-62	Front glass channel	2DR SDN SWG 4DR	61-62 Chevrolet, Pontiac, 2 Door 4 Door Sedan And Station Wagon	21621













GUIDE TO SOFFSEAL'S PRODUCT CODES

B = Bumper sets **C** = Glass channels **D** = Door related **G** = Seals, gaskets **H** = Under hood items **I** = Interior parts
M = Miscellaneous items **R** = Roofrail, pillar post & convertible items **T** = Trunk related **W** = Window related **Z** = Weatherstrip kits



CODE	IMAGE	YEAR	DESCRIPTION	BODY	FITS	ITEM#
C		62-63-64	Glass channel rear	2DR 4DR SDN	62-63 Chevrolet Biscayne, Bel Air, Impala, 62-64 Cadillac, 62-64 Oldsmobile 88, 62-64 Buick LeSabre, 64 Wildcat, 62-64 Pontiac Catalina, Star Chief 2 Door 4 Door Sedan	2189
C		62-63-64	Glass channel rear except 1963-64 gran prix	2DR HTP	62 Buick LeSabre, Invicta, 63-64 Buick LeSabre, Wildcat, 62-64 Chevrolet Impala, 62-63 Oldsmobile S88, 62-64 Oldsmobile D88, 64 Oldsmobile J88, 62-64 Pontiac Catalina 2 Door Hardtop	2184
C		63-64	Glass channel front	4DR HTP	63-64 Chevrolet Impala, 63-64 Cadillac, 63-64 Oldsmobile 88 Oldsmobile 98, 63-64 Buick, 63-64 Pontiac, 4 Door Hardtop	21841
C		63-64	Glass channel rear	4DR HTP	63-64 Chevrolet Impala Sport Coupe, Oldsmobile 88 Holiday Sedan, Buick Lesabre, Wildcat, Pontiac Bonneville, Catalina, Star Chief 4 Door Hardtop	2188
C		63-64	Glass channel rear side stationary window	4DR SWG	61-64 Chevrolet, Buick, Oldsmobile, Pontiac 4 Door Station Wagon, All	2123
C		63-64	Windshield gasket	2DR SDN SWG	63-64 Chevrolet Biscayne, Bel Air, Impala, 63-64 Cadillac Series 62, Deville, 63-64 Oldsmobile 88 Oldsmobile 98, 63-64 Buick LeSabre, Wildcat, Electra, 63-64 Pontiac, 2 Door Sedan Station Wagon	2020
C		63-64	Glass channel front	2DR HTP CNV	63-64 Chevrolet Impala, 63-64 Cadillac, 63-64 Oldsmobile 88, Oldsmobile 98 Starfire Convertible Only, 63-64 Buick LeSabre, Wildcat, Electra, 63-64 Pontiac, 2 Door Hardtop Convertible	2021
D		58	Door weatherstrip with molded corner	2DR SDN	58 Chevrolet Bel Air, Del Ray, Pontiac Chieftain, Catalina, 2 Door Sedan	2004
D		59-60	Door weatherstrip with clips & molded ends	2DR HTP CNV	59-60 Chevrolet Impala, Bel Air, Pontiac Catalina, Star Chief, Bonneville, Oldsmobile 88, 98, Buick LeSabre, Invicta, Electra, Cadillac Deville, Eldorado, Series 62 Hardtop Convertible	2011
D		59-60	Door j weatherstrip	2DR 4DR HTP SWG 2DR SDN 4DR SDN	59-60 Chevrolet, Pontiac, Oldsmobile, Buick, Cadillac	2093
D		59-60	Door weatherstrip front with clips & molded ends	4DR HTP	59-60 Chevrolet Impala, Bel Air, Buick Lesabre, Invicta, Oldsmobile 88, Pontiac Catalina, Star Chief, Bonneville 4 Door Hardtop	2205
D		61-62	Door weatherstrip front with clips	SWG 4 DR SDN	61-62 Chevrolet BelAir, Biscayne, Impala, Pontiac, Station Wagon & 4 Dr Sedan	2019
D		61-62	Door weatherstrip with clips & molded ends	2DR HTP CNV	61-62 Chevrolet Bel Air Impala, Cad Series 62, Deville, 61-62 Oldsmobile, 61 Hardtop Convertible 88 Star Fire, Oldsmobile 98/62 Oldsmobile 88 Oldsmobile 98 Starfire, 61-62 Buick 61 Hardtop Convertible, 62 Convertible Only LeSabre Invicta Electra, 61-62 Pontiac, 2 Door Hardtop Convertible	2013

Pontiac • Catalina

CODE	IMAGE	YEAR	DESCRIPTION	BODY	FITS	ITEM#
D		61-62-63-64	Door weatherstrip rear door with clips	4DR SDN	61-64 Chevrolet Biscayne Bel Air Impala, 61-64 Oldsmobile 88, 98, 61-62 Cadillac, 61-64 Buick LeSabre Electra, 64 Wildcat, 61-64 Pontiac Catalina, Star Chief, 4 Door Sedan	2009
D		61-62-63-64	Door weatherstrip rear with clips	4dr SWG	61-64 Chevrolet Biscayne, Bel Air, Impala, 61-64 Oldsmobile 88, 61-64 Buick LeSabre, 62-63 Invicta 63-64 Wildcat, 61-64 Pontiac Catalina, Bonneville, 4 Door Station Wagon	2018
D		61-62-63-64	Door weatherstrip with clips	2DR SDN	61-64 Chevrolet, Pontiac, Buick, Oldsmobile, 2 Door Sedan	2005
D		61-62-63-64	Door weatherstrip, rear doors with clips & molded ends	4DR HTP	61-64 Chevrolet Impala, Buick LeSabre, Oldsmobile Wildcat, 88, Pontiac Catalina Starchief Bonneville 4 Door Hardtop	2122
D		63-64	Door weatherstrip with clips & molded ends	2DR HTP CNV	63-64 Chevrolet Impala, 63-64 Cadillac Eldorado, Deville, 63-64 Oldsmobile 88 Oldsmobile 98 Starfire 63-64 Buick LeSabre Wildcat, Electra 63 Invicta, 63-64 Pontiac Catalina, Bonneville, Grand Prix, 2 Door Hardtop Convertible	2014
D		63-64	Door weatherstrip front with clips	4DR SDN SWG	63-64 Chevrolet Biscayne, Bel Air, Impala, 63-64 Cadillac, 63-64 Oldsmobile 88, 63-64 Buick LeSabre, Wildcat, 63-64 Pontiac, 4 Door Sedan Station Wagon	2017
D		63-64	Front door weatherstrip with molded ends	4DR HTP	63-64 Chevrolet Biscayne, Bel Air, Impala, Buick Wildcat, Lesabre, Electra, Pontiac Catalina, Star Chief, Bonneville, Oldsmobile Dynamic 88, 98 4 Door Ht	2121
D		65-66	Door weatherstrip front with clips	4DR SDN SWG	65-66 Chevrolet Biscayne Bel Air Impala, 65-66 Cadillac Calais Deville Fleetwood, 65-66 Oldsmobile 88, 65-66 Buick LeSabre Wildcat, 65-66 Pontiac Bonneville, Catalina, Star chief, 4 Door Sedan Swg	2006
D		65-66	Rear door weatherstrip with clips	4DR SDN	65-66 Chevrolet Biscayne Bel Air Impala 65-66 Cadillac Calais Deville Fleetwood 65-66 Oldsmobile 88, 65-66 Buick LeSabre Wildcat, 65-66 Pontiac Catalina, Star Chief, 4 Door Sedan	2007
D		65-66	Door weatherstrip rear station wagon with clips	4DR SWG	65-66 Chevrolet Biscayne, Bel Air, Impala, 65-66 Oldsmobile, 65-66 Buick, 65-66 Pontiac	2008
D		65-66	Door weatherstrip rear doors with clips & molded ends	4DR HTP	65-66 Chevrolet Impala, Pontiac Catalina, Bonneville, 4 Door Hardtop	2211
D		65-66	Door weatherstrip with clips & molded ends	2DR HTP CNV	65-66 Chevrolet Impala, Caprice, 65-66 Cadillac Calais, Deville, 65-66 Oldsmobile 88, Starfire, Oldsmobile 98, 65 Jet Star, 65-66 Buick LeSabre, Wildcat Electra, 65-66 Pontiac 2 Door Hardtop Convertible	2331











GUIDE TO SOFFSEAL'S PRODUCT CODES

B = Bumper sets **C** = Glass channels **D** = Door related **G** = Seals, gaskets **H** = Under hood items **I** = Interior parts
M = Miscellaneous items **R** = Roofrail, pillar post & convertible items **T** = Trunk related **W** = Window related **Z** = Weatherstrip kits



CODE	IMAGE	YEAR	DESCRIPTION	BODY	FITS	ITEM#
D		65-66	Door weatherstrip with clips	2DR SDN	65-66 Chevrolet Biscayne, Bel Air, 65-66 Cadillac, 65-66 Oldsmobile, 65-66 Buick, 65-66 Pontiac, 2 Door Sedan	2332
D		67-68	Front door weatherstrip with clips	4DR SDN SWG	67-68 Chevrolet Biscayne, Bel Air, Impala, 67-68 Cadillac Calais, Deville, Fleetwood, 67-68 Oldsmobile Delmont 88, Delta 88, 98, 67-68 Buick LeSabre, Wildcat, Electra 67-68 Pontiac Catalina, Executive, Bonneville, 4 Door Sedan Station Wagon	23321
D		67-68	Door weatherstrip rear with clips	4DR SDN	67-68 Chevrolet Biscayne, Bel Air, Impala, 67-68 Cadillac Calais, Deville, Fleetwood, 67-68 Oldsmobile 88, 67-68 Buick LeSabre, Wildcat, 67-68 Pontiac Bonneville Station Wagon, 67-68 Pontiac Executive, Catalina, 4 Door Sedan	23322
D		67-68	Door weatherstrip with clips	2DR SDN	67-68 Chevrolet Biscayne, Bel Air, 67-68 Cadillac, 67-68 Oldsmobile, 67-68 Buick, 67-68 Pontiac, 2 Door Sedan	2329
D		67-68	Door weatherstrip with clips & molded ends	CNV 2DR HTP	67-68 Chevrolet Impala, Caprice, Except 68 Caprice 2 Door Hardtop, 67-68 Cadillac Calais, Deville, 67-68 Oldsmobile 88 Oldsmobile 98, 67-68 Buick Electra, Wildcat, 67 Pontiac Catalina, Bonneville, Executive, 67 Grand Prix Convertible 2 Door Hardtop	2342
D		67-68	Door weatherstrip rear doors with clips & molded ends	4DR HTP	67-68 Chevrolet Impala, Pontiac Catalina, Bonneville, 4 Door Hardtop	2212
D		69-70	Door weatherstrip with clips & molded ends	2DR HTP CNV	69-70 Chevrolet Impala, Caprice, 69-70 Cadillac Calais, Deville, 69-70 Oldsmobile 88 Oldsmobile 98, 69-70 Buick LeSabre, Wildcat, Electra, 69-70 Pontiac Catalina, Bonneville, Executive, 2 Door Hardtop Convertible	2357
D		69-70	Door weatherstrip front doors with clips	4DR SDN SWG	69-70 Chevrolet Biscayne, Bel Air, Impala, Cadillac, Buick La Sabre, Wildcat, Pontiac, 4 Door Sedan Station Wagon	2510
D		69-70	Door weatherstrip rear doors with clips	4DR SDN	69-70 Chevrolet, Buick, Oldsmobile Delta 88, Pontiac Catalina, Bonneville Executive, 4 Door Sedan	2511
D		69-70	Rear door weatherstrip	SWG 4DR	69-70 Chevy Biscayne, Bel Air, Impala, Caprice, Estate, Oldsmobile Vista Cruiser, Pontiac Catalina, Bonneville, Executive, Gm Fullsize Station Wagon 4 Door	2519
D		71-72-73-74	Door weatherstrip rear door with clips & molded ends	4DR HTP	71-74 Chevrolet Caprice, Impala, Buick LeSabre, Centurion, Oldsmobile 88, Pontiac, 4 Door Hardtop	2214
D		71-72-73-74	Door weatherstrip rear with clips & molded ends	4DR SDN	71-74 Chevrolet Impala, Bel Air, Biscayne, Brookwood, Townsman, Kingswood, Buick Estate Station Wagon, Pontiac Catalina, Grand Safari, Bonneville, Oldsmobile Custom Cruiser, 4 Door Sedan	2225

Pontiac • Catalina

CODE	IMAGE	YEAR	DESCRIPTION	BODY	FITS	ITEM#
D		71-72-73-74-75-76	Door weatherstrip front with clips & molded ends	SWG	71-76 Chevrolet Impala, Bel Air, Biscayne, Brookwood, Townsman, Kingswood, Buick Estate Station Wagon, Pontiac Catalina, Grand Safari, Bonneville, Oldsmobile Custom Cruiser, 4 Door Station Wagon	2228
D		71-72-73-74-75-76	Door weatherstrip front doors with clips & molded ends	4DR HTP	71-76 Chevrolet Caprice, Impala, Buick, Electra, LeSabre, Centurion, Cadillac Calais, Deville, Oldsmobile 88 Oldsmobile 98, Catalina, Bonneville, Granville, 4 Door Hardtop	2213
D		71-72-73-74-75-76	Door weatherstrip with clips & molded ends	2DR HTP CNV	71-76 Chevrolet Impala, Caprice, Cadillac Calais, Deville, Buick 71-73 LeSabre, Centurion, Electra, 74-76 LeSabre, Electra, Oldsmobile 88 Oldsmobile 98, Pontiac Bonneville, Catalina, 71-75 Grandville 2 Door Hardtop Convertible	2512
D		75-76	Rear Door weatherstrip with clips & molded ends	4DR HTP	75-76 Chevrolet Impala, Caprice, Buick, LeSabre, Centurion, Oldsmobile 88, Pontiac, 4 Door Hardtop	2216
D		75-76	Door weatherstrip rear with clips & molded ends	4DR SDN	75-76 Chevrolet Impala, Bel Air, Brookwood, Townsman, Kingwood, Buick Estate Station Wagon, Pontiac Catalina, Grand Safari, Bonneville, Oldsmobile Custom Cruiser, 4 Door Sedan	2226
D		77-78-79-80-81-82-83-84-85-86	Front door weatherstrip with clips	4DR SDN RWD	77-86 Impala Caprice, 77-84 Cadillac Deville Fleetwood, 85-86 Fleetwood, 77-84 Oldsmobile 88 89, 85 88, 77-84 Buick LeSabre Electra 85 LeSabre, 77-79 Buick Estate Wagon, 82-83 Buick Park Ave 77-81 Pontiac Bonneville, 83-86 Pontiac Parisienne, 77-80 Pontiac Catalina 4 Door Sedan, RWD Only	2500
D		77-78-79-80-81-82-83-84-85-86-87	Door weatherstrip with clips	2DR SDN RWD	84-87 Chevrolet Caprice, 77-81 Chevrolet Impala, 83 Chevrolet, 77-84 Cadillac Deville, 80-84 Fleetwood, 77-84 Oldsmobile 88 Oldsmobile 98, 85 Oldsmobile 88, 77-84 Buick LeSabre, Electra, 85 LeSabre, 77-81 Pontiac Bonneville, Catalina 2 Door Sedan, RWD Only	2359
D		77-78-79-80-81-82-83-84-85-86-87-88-89-90	Rear door weatherstrip with clips	4DR SDN RWD	77-86 Chevrolet Impala Caprice, 87-88 Caprice Caprice Classic, 89 Caprice, 90 Caprice Caprice Classic, 77-84 Cadillac Deville, 77-85 Oldsmobile 88, 77-78 Town Sedan, Custom Crusier, 77-84 Buick LeSabre Electra 85 LeSabre, 77-81 Pontiac Bonneville, Catalina, 83-86 Pontiac Parisienne 4 Door Sedan, RWD Only	2502
D		77-78-79-80-81-82-83-84-85-86-87-88-89-90	Rear door weatherstrip with clips	4 DR SWG, RWD	77-86 Chevrolet Impala Caprice, 87-88 Caprice Caprice Classic, Cadillac, 77-85 Oldsmobile Custom Cruiser, 77-88 Estate Station Wagon, 77-81 Catalina Safari Bonneville Safari, 82 Bonneville Safari, 83 Bonneville Parisienne, 84-89 Parisienne Station Wagon, RWD Only	2503















GUIDE TO SOFFSEAL'S PRODUCT CODES						
B = Bumper sets	C = Glass channels	D = Door related	G = Seals, gaskets	H = Under hood items	I = Interior parts	
M = Miscellaneous items	R = Roofrail, pillar post & convertible items		T = Trunk related	W = Window related	Z = Weatherstrip kits	

Pontiac • Catalina



CODE	IMAGE	YEAR	DESCRIPTION	BODY	FITS	ITEM#
G		60-63-64-69-70	Door handle & lock gaskets	2DR 4DR HTP 2DR SDN CNV SWG	60 Chevrolet Biscayne, Impala, Bel Air, Cadillac, Oldsmobile 89 Oldsmobile 98, Buick LeSabre, Invicta, Electra, Wild Cat, Pontiac Catalina, Star Chief, Bonneville, Grand Prix, Ventura	2098
G		61-62-65-66-67-68	Door handle & lock gaskets	2DR 4DR HTP 2DR SDN CNV SWG	61-62 Chevrolet Biscayne, Bel Air, Impala, Cadillac, Oldsmobile 88 Oldsmobile 98, Buick LeSabre, Invicta, Electra, Pontiac	2145
G		68	Taillamp lens gaskets, bonneville can be modified to fit catalina & ventura	2DR 4DR HTP CNV SWG	68 Pontiac	6854
H		64	Hood insulation	2DR 4DR HTP 2DR SDN CNV SWG	64 Pontiac	2150
H		64-65-66-67-68-69-70-71-72	Firewall wiring gutter plk	2DR 4DR HTP 2DR SDN SWG CNV	Chevy Chevelle, Biscayne, Bel Air, Impala, Caprice, Nova, Camaro, Cadillac Calais, Deville, Fleetwood, Oldsmobile 88, 98, Jetstar, Starfire, Pontiac Catalina, Bonneville, Firebird, Buick Lesabre, Wildcat, Electra	2328
H		71-72-73-74-75-76-77-78	Hood to cowl seal	2DR SDN 2DR HTP CNV SWG	71-78 Chevrolet Impala, Caprice, Biscayne, Bel Air, Brookwood, Townsman, Kingswood, Buick Lesabre, Centurion, Electra 225, Estate Wagon, Cadillac Calais, Deville, Eldorado, Sixty Special Brougham, Oldsmobile 88, 98, Tornado, Pontiac Catalina, Bonneville, Grandville, Safari Full Size	2191
I		55-56-57-61-62-63-64	Glove box arm grommet	2DR 4DR HTP 2DR SDN CNV SWG	55-57 And 61-64 Chevrolet, Pontiac, Oldsmobile All	10691
M		55-56-57-59-60-61	Gear tube grommet	2DR 4DR HTP SDN CNV SWG	55-57 And 59-60 Chevrolet Pontiac, Oldsmobile, 60-61 Chevrolet Truck, Gmc Truck, 2 Door 4 Door Hardtop Sedan Convertible Station Wagon	1095
R		58-59-60-61-62-63-64	Header seal	CNV	Chevy Impala, Cadillac Series 62 Eldorado, Pontiac Catalina, Bonneville, Oldsmobile 88, 98, Starfire, Buick Lesabre, Invicta, Electra	2153
R		59-60	Roofrail weatherstrip with clips	2DR HTP	59-60 Chevrolet, Cadillac, Pontiac, Oldsmobile, Buick, 2 Door Hardtop	2090
R		59-60	Pillar post weatherstrip with clips and molded ends	CNV	59-60 Chevrolet Impala, Cadillac Eldorado Series 62, Pontiac Bonneville, Catalina, Oldsmobile 88 Oldsmobile 98, Buick LeSabre, Invicta, Electra	2091
R		61	Roofrail weatherstrip with molded ends	2DR HTP	61 Chevrolet, Buick, Oldsmobile, Pontiac 2 Door Hardtop	2129
R		61-62	Weatherstrip Kit For Convertible Top With 6-5/8 Between Center Stud	Cnv	61-62 Chevrolet Impala, 61-62 Olds 88, Starfire, 61 Buick LeSabre, 61-62 Invicta, 61-62 Pontiac, Catalina Bonneville Convertible	2156
R		61-62	Roofrail weatherstrip	4DR HTP	61-62 Chevrolet Bel Air, Impala, Buick, LeSabre, Invicta, Oldsmobile 88, Pontiac, 4 Door Hardtop	2223

Pontiac • Catalina

CODE	IMAGE	YEAR	DESCRIPTION	BODY	FITS	ITEM#
R		62	Pillar post weatherstrip with molded ends	CNV	61-62 Chevrolet Impala, 61-62 Cadillac 61 Series 6200, Eldorado 62 Eldorado, 61-62 Oldsmobile 88 Oldsmobile 98, Starfire, 61-62 Buick Electra, Invicta, LeSabre, 61-62 Catalina, Bonneville, Convertible	2154
R		62	Roofrail weatherstrip with molded ends	2DR HTP	62 Chevrolet Impala, 62 Cadillac, 62 Oldsmobile 88, 62 Buick LeSabre, Invicta, Pontiac 2 Door Hardtop	2164
R		62-63-64	Weatherstrip kit for convertible top second type with 5 3/8" between center studs	CNV	62-64 Chevrolet Impala, Oldsmobile 88, Starfire, Buick LeSabre, Invicta, Pontiac, Bonneville, Catalina, 63-64 Buick Wildcat Convertible	2152
R		62-63-64	Weatherstrip kit for convertible top with 5 3/8" between center studs cloth covered	CNV	62-64 Chevrolet Impala, Cadillac, Oldsmobile 88, Starfire, Buick LeSabre, Invicta, Wildcat, Pontiac Catalina, Bonneville	2152C
R		63-64	Pillar post weatherstrip with molded ends	CNV	63-64 Chevrolet Impala, 63-64 Cadillac 63 Series 6200, Eldorado 64 Deville, Eldorado, 63-64 Oldsmobile 88 Oldsmobile 98, Starfire, 63-64 Buick LeSabre, Wildcat, 63-64 Pontiac, Convertible	2193
R		63-64	Roofrail weatherstrip with molded ends	2DR HTP	63-64 Chevrolet Impala, 63-64 Cadillac, 63-64 Oldsmobile 88, 63-64 Buick LeSabre, Wildcat, 63-64 Pontiac 2 Door Hardtop	2194
R		63-64	Roofrail weatherstrip with molded ends	4DR HTP	63-64 Chevrolet Impala, Buick LeSabre, Wildcat, Oldsmobile 88, Pontiac, 4 Door Hardtop	2194A
R		65	Weatherstrip kit for convertible top	CNV	65 Chevrolet Impala, 65 Cadillac, 65 Oldsmobile, 65 Buick LeSabre, Wildcat, 65 Pontiac, Convertible	2365
R		65-66	Roofrail weatherstrip with molded ends	2DR HTP	65-66 Chevrolet Impala, Caprice, 65-66 Cadillac Calais, Deville, 65-66 Oldsmobile 88, Jet Star, Star Fire, Oldsmobile 98, 65-66 Buick LeSabre, Wildcat, Electra, 65-66 Pontiac 2 Door Hardtop	2333
R		65-66	Roofrail weatherstrip with molded ends	4DR HTP	65-66 Chevrolet Impala, Caprice, 65-66 Cadillac, 65-66 Oldsmobile 88, 65-66 Buick LeSabre, 65-66 Pontiac, 4 Door Hardtop	2333A
R		65-66-67-68-69-70	Header seal with clips and molded ends	CNV	65 Chevrolet, 66-70 Chevrolet Impala, 65-70 Cadillac Deville, 65-70 Oldsmobile 88 Oldsmobile 98, 65 Oldsmobile Starfire, 65-70 Buick LeSabre, Wildcat, Electra, 65-70 Pontiac, Convertible	23343
R		66-68	Pillar post weatherstrip with molded ends	CNV	66-68 Chevrolet Impala, 66-68 Cadillac Deville, 66 Cadillac Eldorado, 66-68 Oldsmobile 88 Oldsmobile 98, 66-68 Buick Electra, LeSabre, Wildcat, 66-68 Pontiac, Convertible	23341







GUIDE TO SOFFSEAL'S PRODUCT CODES

B = Bumper sets **C** = Glass channels **D** = Door related **G** = Seals, gaskets **H** = Under hood items **I** = Interior parts
M = Miscellaneous items **R** = Roofrail, pillar post & convertible items **T** = Trunk related **W** = Window related **Z** = Weatherstrip kits



CODE	IMAGE	YEAR	DESCRIPTION	BODY	FITS	ITEM#
R		66-67-68-69-70	Weatherstrip kit for convertible top includes header seal (7 piece kit)	CNV	66-70 Chevrolet Impala, 66-70 Oldsmobile 88, 66-70 Buick LeSabre, Wildcat, 66-70 Pontiac Bonneville, Catalina, 67 Pontiac Grand Prix, Convertible	2366
R		67-68	Roofrail weatherstrip with molded ends	2DR HTP	67-68 Chevrolet Impala, Caprice, 67-68 Cadillac, 67-68 Oldsmobile 88, 67-68 Buick Electra, Wildcat, 67-68 Pontiac Catalina, Executive 2 Door Hardtop	2345
R		67-68	Roofrail weatherstrip with thick c pillar section	4DR HTP	67-68 Chevrolet Impala, Caprice, Buick LeSabre, Wildcat, Pontiac Bonneville, Catalina, Executive 4 Door Hardtop	2351
R		69-70	Roofrail weatherstrip with molded ends	2DR HTP	69-70 Chevrolet Caprice, Impala, 69-70 Cadillac, 69-70 Oldsmobile 88, 69-70 Buick LeSabre, Wildcat, 69-70 Pontiac 2 Door Hardtop	2356
R		69-70	Roofrail weatherstrip	4DR HTP	69-70 Chevrolet Impala, Caprice, 69-70 Oldsmobile 88 Oldsmobile 98, 69-70 Buick LeSabre, Wildcat, Electra, 69-70 Pontiac Catalina, Bonneville, Executive 4 Door Hardtop	23561
R		69-70	Pillar post weatherstrip with molded ends	CNV	69-70 Chevrolet Impala, Caprice, 69-70 Cadillac Deville, 69-70 Oldsmobile 88 Oldsmobile 98, 69-70 Buick LeSabre, Wildcat, Electra, 69-70 Pontiac, Convertible	2358
R		71-72-73	Roofrail weatherstrip	2DR HTP	71-73 Chevrolet Impala, 71-73 Cadillac, 71-73 Oldsmobile 88, 71-73 Pontiac, 2 Door Hardtop	2420
R		71-72-73-74	Roofrail weatherstrip	4DR HTP	71-74 Chevrolet Caprice, Impala, Buick LeSabre, Centurion, Oldsmobile 88, Pontiac Catalina, Bonneville 4 Door Hardtop	2221
R		71-72-73-74-75	Roofrail weatherstrip	2DR HTP	71-73 Impala Custom Coupe Caprice, 74-75 Impala Sport Coupe, 71-76 Cadillac Calais Deville, 71-74 Electra, 74-76 LeSabre, 71-71 98, 74 Oldsmobile 98 Oldsmobile Delta 88, 75-76 Oldsmobile Delta 88, 71-73 Grandville, 74 Bonneville Catalina Grandville, 75-76 Catalina, 2 Door Hardtop	2509
R		71-72-73-74-75-76	Header seal	CNV	71-75 Chevrolet Impala, Caprice, 71-72 Oldsmobile 88, 71-75 Pontiac Catalina, Grandville, 71-75 Buick LeSabre, Centurion, 71-76 Cadillac Eldorado, Convertible	2515
R		71-72-73-74-75-76	Weatherstrip kit for convertible top	CNV	71-72 Chevrolet Impala, 73-76 Caprice, 71-76 Cadillac Eldorado, 71-75 Oldsmobile Delta 88, 71,72, 74 Buick LeSabre 71-73 Centurion, 71-72 Pontiac Catalina, 71-75 Grandville Convertible	2508
R		71-72-73-74-75-76	Pillar post weatherstrip with molded ends	CNV	71-75 Chevrolet Impala, Caprice 71-72 Oldsmobile 88, 71-75 Pontiac Catalina, Grandville, 71-75 Buick LeSabre, Centurion 71-76 Cadillac Eldorado, Convertible	2094

Pontiac • Catalina

CODE	IMAGE	YEAR	DESCRIPTION	BODY	FITS	ITEM#
T		58-59-60-61-62-63-64-65-66-67-68-69	Trunk weatherstrip exact profile	2DR 4DR HTP 2DR SDN CNV	58-64 Chevrolet Biscayne, 58-64 Chevrolet Bel Air, Chevrolet Impala, 60-69 Chevrolet Corvair, 59-64 Pontiac Parisienne, 59-64 Pontiac Catalina, 59-64 Pontiac Star Chief, 60-61 Pontiac Ventura, 62-64 Pontiac Grand Prix, 58-64 Oldsmobile Delta 88, 58-64 Oldsmobile Dynamic 88, Oldsmobile Super 88, Oldsmobile Super 98, 61-64 Oldsmobile Starfire, 64 Oldsmobile Jetstar, 59-64 Buick LeSabre, 59-62 Buick Invicta, 59-64 Buick Electra, 62-64 Buick Wildcat, 63-65 Buick Riviera, 58-60 Cadillac Deville, Cadillac Eldorado, Cadillac Series 62, Cadillac Series 60 Special, Cadillac Series 75, 58-64 C-Body	2001
T		62-63-64-65-66-67-68-69-70-71-72-73	Door and tailgate bottom drain hole seal	2DR 4DR HTP SDN CNV SWG CPE	62-73 Chevy Nova, Chevelle, Impala, Caprice Pontiac Catalina, Star Chief, Bonneville, Grand Prix Oldsmobile F85	2118
T		64-65-66-67-68-69-70-71-72-73-74-75-76-77	Trunk weatherstrip exact profile length 17 feet	2DR 4DR HTP 2DR SDN CNV	65-72 Chevy II, 65-72 Chevrolet Biscayne, 65-75 Chevrolet Bel Air, 65-76 Chevrolet Impala, 65-76 Chevrolet Caprice, 64-77 Chevrolet Chevelle, 70-77 Chevrolet Monte Carlo, 65-76 Buick LeSabre, 64-77 Buick Wildcat, 64-77 Buick Skylark, 71-73 Buick Centurion, 64-72 Buick Grand Special, 73-77 Buick Century, 73-88 Buick Regal, 73-88 Buick Grand National, 65-76 Buick Electra, 65-76 Oldsmobile Delta 88, 67-69 Oldsmobile Delmont 88, 65-66 Oldsmobile Dynamic 88, 65-66 Oldsmobile Starfire, 65 Oldsmobile Jetstar, 64-77 Oldsmobile Cutlass 442, 64-88 Oldsmobile Cutlass, 65-76 Oldsmobile 98, 65-76 Pontiac Parisienne, 64-72 Pontiac LeMans, 65-70 Pontiac Catalina, 65-66 Pontiac Star Chief, 67-70 Pontiac Executive, 71-75 Pontiac Grand Ville, 65-77 Pontiac Grand Prix, 64-72 Pontiac Tempest, 62-72 Nova, Ventura, 73-74 Non-Hatchback, Up to 1975 with groove channel, Apollo, Nova, Omega, Ventura 65-76 C-Body	2003
T		75-76-77-78-79-80-81-82-83-84-85-86-87-88-89-90-91-92	Trunk and Hatchback weatherstrip	2DR 4DR SDN HTP CNV	77-85 Chevrolet Impala, 77-91 Chevrolet Caprice, 82-92 Chevrolet Camaro, 75-79 Chevrolet Nova, 78-88 Chevrolet Monte Carlo, 78-83 Chevrolet Malibu, 78-83 Pontiac LeMans, 82-92 Pontiac Firebird, 75-91 Pontiac Ventura, 77-86 Pontiac Parisienne, 77-81 Pontiac Catalina, 69-88 Pontiac Grand Prix, 64-87 Pontiac LeMans, Pontiac Grand Am, 64-77 Pontiac GTO, 73-79 Oldsmobile Omega, 77-85 Oldsmobile Delta 88, 77-84 Oldsmobile 98, 77-88 Oldsmobile Cutlass, 73-75 Buick Apollo, 76-79 Buick Skylark, 77-79 Phoenix, 73-88 Buick Regal, 77-84 Buick Electra, 77-85 Buick LeSabre, 77-78 Buick Riviera, 77-91 C-Body	2424













GUIDE TO SOFFSEAL'S PRODUCT CODES

B = Bumper sets **C** = Glass channels **D** = Door related **G** = Seals, gaskets **H** = Under hood items **I** = Interior parts
M = Miscellaneous items **R** = Roofrail, pillar post & convertible items **T** = Trunk related **W** = Window related **Z** = Weatherstrip kits



CODE	IMAGE	YEAR	DESCRIPTION	BODY	FITS	ITEM#
W		58	Vent window weatherstrip	2DR 4DR HTP	58 Chevrolet Bel Air, Pontiac Catalina, Super Chief, 2d4, 4 Door Hardtop	2278
W		58-59-60	Quarter window u-jamb	CNV	58-60 Chevrolet Impala, 58 Cadillac, 59-60 Cadillac Series 62, Eldorado, 58-60 Oldsmobile 88 Oldsmobile 98, 58 Buick, 59-60 Buick LeSabre, Invicta, Electra, 58 Pontiac, Convertible	2286
W		58-59-60-61-62-63-64	Quarter window seals	2DR HTP CNV	58-64 Chevrolet Impala, 58, 60-62 Bel Air, 58-64 Cadillac Series 62, Deville, Eldorado, 58 Oldsmobile 88 Oldsmobile 98, 59-60 Oldsmobile 88 Oldsmobile 98, 61-64 Oldsmobile 99, Starfire, 98, 64 Jetstar, 59-62 Buick LeSabre, Invicta, Electra 2 Door Hardtop Convertible	2300
W		59-60	Rear quarter stationary vent window seals	4DR SDN	59-60 Chevrolet Buick, Style 4419, 4619, 4719 Oldsmobile, Pontiac 4 Door Sedan	2053
W		61-62	Vent window seals	2DR 4DR HTP CONV	61-62 Chevrolet Bel Air, Impala, 61-62 Cadillac Series 62, Eldorado, 61-62 Oldsmobile 88 Oldsmobile 98, 61-62 Buick LeSabre, Invicta, Electra, 61-62 Pontiac Bonneville, Catalina, Ventura 2 Door 4 Door Hardtop, Convertible	21615
W		61-62-63-64-65-66	Horizontal outer window seals	2DR 4DR HTP SDN CNV SWG	Chevy Biscayne, Bel Air, Impala, Caprice, Cadillac series 62 Deville, Eldorado, Fleetwood, Calais, Oldsmobile 88, Starfire, 98. Buick Lesabre, Invicta, Wildcat, Electra, Pontiac Catalina, Ventura, Star Chief, Bonneville	2310
W		63-64	Vent window seals	2DR HTP CNV	63-64 Chevrolet Impala, Buick Electra, Lesabre, Wildcat, Oldsmobile 98, Pontiac Catalina, Bonneville, 2 Door Hardtop Convertible, Starfire Convertible Only	21814
W		65-66	Quarter window seals	2DR HTP CNV	65-66 Chevrolet Impala, 66 Chevrolet Caprice, 65-66 Cadillac Calais, Deville 65-66 Oldsmobile 88, Jetstar, 65-66 Buick LeSabre, Wildcat, 65-66 Pontiac Bonneville, Catalina, Star Chief 2 Door Hardtop Convertible	2301
W		65-66	Quarter window seals	4DR HTP	65-66 Chevrolet Impala, 66 Chevrolet Caprice, 65-66 Cadillac Calais, Deville, 65-66 Oldsmobile 88 Oldsmobile 98, 65-66 Buick LeSabre, Wildcat, Electra, 65-66 Pontiac Bonneville, Catalina, Star Chief 4 Door Hardtop	23011
W		65-66	Door u-jamb seal	2DR HTP CNV	65-66 Chevrolet Impala, 66 Caprice, 65-66 Cadillac Calais, Deville, Eldorado, 65-66 Oldsmobile 88, Jetstar, Starfire, Oldsmobile 98, 65-66 Buick LeSabre, Wildcat, Electra, 65 Pontiac Bonneville, Catalina, Star Chief 2hardtop Convertible	2368
W		65-66-67-68	Vent window weatherstrip	2DR HTP CNV	65-68 Chevrolet Impala, Buick LeSabre, Electra, Wildcat, Cadillac Calais, Deville, Oldsmobile 88 Oldsmobile 98 Starfire, Pontiac Bonneville, Catalina, Star Chief 2 Door Hardtop Convertible	2217

Pontiac • Catalina

CODE	IMAGE	YEAR	DESCRIPTION	BODY	FITS	ITEM#
W		65-66-67-68-69	Doorglass run channel, upper & rear	2DR SDN	65-72 Chevrolet Pontiac, 2 Door Sedan	2517
W		65-66-67-68	Glass run channel front window	2DR HTP CNV	65-68 Chevrolet Impala, Caprice, 65-68 Cadillac Calais, Deville 65-66 Eldorado, 65-68 Oldsmobile 88 Oldsmobile 98, 65-66 Oldsmobile Jetstar, Starfire, 65-68 Buick LeSabre, Wildcat, Electra, 65-68 Pontiac Bonneville, Catalina, Executive 2 Door Hardtop Convertible	2350
W		67-68	Quarter window seals	2DR HTP	67-68 Chevrolet Impala, 67-68 Cadillac Calais, Deville 67-68 Oldsmobile 88, 98, 67-68 Buick LeSabre, Wildcat, Electra 67-68 Pontiac Catalina, Bonneville, Executive 2 Door Hardtop	2302
W		67-68	Quarter window seals	CNV	67-68 Chevrolet Impala, 67-68 Cadillac Deville, 67-68 Oldsmobile 88 Oldsmobile 98, 67-68 Buick LeSabre, Wildcat, Electra, 67-68 Pontiac Catalina, Bonneville Convertible	23021
W		67-68	Quarter window u-jamb	2 DR CNV HTP	67-68 Chevy Impala Convertible 68 Caprice Sport Coupe, 67 Buick LeSabre, Wildcat Convertible, 67 Electra 2 Door Hardtop & Convertible, 68 Buick Wildcat, Electra, LeSabre 2 Door Hardtop & Convertible, 67 Cadillac Deville Convertible, 68 Cadillac Calais, Deville Hardtop & Convertible 67-68 Oldsmobile 88, Oldsmobile 98, 67-68 Pontiac Catalina, Bonneville, Executive, Grand Prix Hardtop & Convertible	2294
W		67-68	Quarter window u-jamb	2DR HTP CNV	67-68 Chevrolet Impala, 67-68 Cadillac Calais, Deville, 67 Oldsmobile 98, 67-68 Buick, LeSabre, Wildcat, Electra, 67-68 Pontiac Bonneville, Catalina 2 Door Hardtop	2292
W		69-70	Qtr window u jamb	CNV 2DR HTP	69-70 Chevrolet Impala, 69-70 Cadillac, Eldorado, 69-70 Oldsmobile 88 Oldsmobile 98, 69-70 Buick LeSabre, Wildcat, 69 Pontiac Catalina, Executive, Bonneville Convertible 2 Door Hardtop	2293
W		71-72-73	Qtr window u jamb	2DR HTP CNV	71-73 Buick LeSabre, Electra, Riviera, Chevrolet Impala, Caprice, Cadillac Calais, Deville, Oldsmobile 88 Oldsmobile 98, Pontiac Catalina, Bonneville, Grandville 2 Door Hardtop Convertible	2600
W		71-72-73-74-75-76	Quarter window seals	2DR HTP CNV	71-75 Chevrolet Impala, Caprice, 71-76 Cadillac Eldorado Convertible Only, 71-76 Oldsmobile 88, 76 Oldsmobile 98, 71-73 Buick LeSabre, 71-73 Centurion, 71-75 Pontiac Catalina, Bonneville, Grandville 2 Door Hardtop Convertible	2308
W		71-72-73-74-75-76	Quarter window seals	4DR HTP	71-75 Chevrolet Impala, Caprice, Cadillac Calais, Deville, Pontiac Catalina, Bonneville, Grandville Buick LeSabre, Electra, Oldsmobile 88, 98, 4 Door Hardtop	2309





GUIDE TO SOFFSEAL'S PRODUCT CODES











B = Bumper sets **C** = Glass channels **D** = Door related **G** = Seals, gaskets **H** = Under hood items **I** = Interior parts
M = Miscellaneous items **R** = Roofrail, pillar post & convertible items **T** = Trunk related **W** = Window related **Z** = Weatherstrip kits

Pontiac • Catalina



CODE	IMAGE	YEAR	DESCRIPTION	BODY	FITS	ITEM#
W		74-75-76	Quarter window u-jamb	2DR HTP CNV	Impala Caprice LeSabre Electra Eldorado Oldsmobile Delta 88 Oldsmobile 98, Tornado Delta Bonneville Catalina Grandville Catalina	2295
W		77-78-79-80-81-82-83-84-85-86-87-88-89-90	Window weatherstrip outers only, rwd with chrome bead	2DR SDN	77-90 Chevrolet Impala, Caprice, Buick LeSabre, Electra, Oldsmobile 88 Oldsmobile 98, Pontiac Catalina, Bonneville, Cadillac Deville, 2 Door Sedan	2369
W		77-78-79-80-81-82-83-84-85-86-87-88-89-90	Window weatherstrip, outers only, rwd, with o chrome bead	2DR SDN	77-90 Chevrolet Impala, Caprice, Buick LeSabre, Electra, Oldsmobile 88 Oldsmobile 98, Pontiac Catalina, Bonneville, Cadillac Deville, 2 Door Sedan	23691

Pontiac • Chieftain

CODE	IMAGE	YEAR	DESCRIPTION	BODY	FITS	ITEM#
B		39-40-41-42-43-44-45-46-47-48-49-50-51-52-53-54-57-64-65-66-67-68-69-70-71-72	Brake clutch pedal bumpers	2DR 4DR HTP 2DR SDN CNV SWG	39-54 And 57 Chevrolet, 55-57 Pontiac, 64-72 Chevrolet	1058
B		41-42-43-44-45-46-47-48-49-50-51-52-53-54-55-56-57	Firewall/cowl bumper, 41-48 top of firewall, 41-54 side cowl	ALL BODY STYLES	41-57 Chevrolet	0457
B		47-48-49-50-51-52-53-54-55-56-57-58-59-60-61-62-63-64-65-66-67-68-69-70-71-72-73-74-75-76-77-78-79-80-81-82-83-84-85-86-87	Glove box door bumpers	2DR 4DR HTP 2DR SDN CNV SWG TRK	All Chevrolet, Pontiac, Oldsmobile, Buick 47-87 Chevrolet, Gmc Truck	1069
B		49-50-51-52-53-54-55-56-57	Door bumpers screw in upper	2DR SDN SWG	49-57 Chevrolet 150 210 Bel Air Styleline Fleetline, Pontiac Sedan, Plus Universal Applications	1054
B		51-52-53-54-55-56-57-58	Upper vent window bumpers	2DR 4DR HTP 2DR SDN CNV SWG	51-58 Chevrolet 150 210 Bel Air Nomad Del Ray Biscayne Impala, 51-54 Chevrolet, Pontiac, Oldsmobile, Buick, Cadillac, Hardtop Convertible	1224
B		55	Hood adjustment bumpers front & rear	2DR 4DR HTP 2DR SDN CNV SWG	55 Chevrolet 150 210 Bel Air Nomad, Pontiac	1072
B		55	Hood to fender bumpers 6 piece	2DR 4DR HTP 2DR SDN CNV SWG	55 Chevrolet 150 210 Bel Air Nomad	1073
B		55-56	Seat back rest bumper	2DR 4DR HTP 2DR SDN CNV SWG	55-56 Chevrolet 150 210 Bel Air Nomad, Pontiac, Safari	1059
B		55-56	Brake clutch pedal bumper	2DR 4DR HTP 2DR SDN CNV SWG	55-56 Chevrolet 150 210 Bel Air, Pontiac, Olds	1057
B		55-56-57	Trunk bumpers	2DR 4DR HTP 2DR SDN CNV	55-57 Chevrolet 150 210 Bel Air, Pontiac	1052
B		55-56-57	Body bumper kit	2DR HTP CNV	55-57 Chevrolet 210 Bel Air, 2 Door Hardtop Convertible	1055
B		55-56-57	Body bumper kit	2DR SDN	55-57 Chevrolet 150 210 Bel Air, Pontiac, 2 Door, Sedan	1056
B		55-56-57	Door bumpers	4DR SWG	55-57 Chevrolet 150 210 Bel Air, Pontiac, Oldsmobile, All Station Wagons, 4 Door Sedan Station Wagon	10541
B		55-56-57	Door upper bumpers push in	2DR 4DR SDN	55-57 Chevrolet 150 210 Bel Air, Pontiac, Oldsmobile, Sedan	10542















GUIDE TO SOFFSEAL'S PRODUCT CODES

B = Bumper sets **C** = Glass channels **D** = Door related **G** = Seals, gaskets **H** = Under hood items **I** = Interior parts
M = Miscellaneous items **R** = Roofrail, pillar post & convertible items **T** = Trunk related **W** = Window related **Z** = Weatherstrip kits



CODE	IMAGE	YEAR	DESCRIPTION	BODY	FITS	ITEM#
B		55-56-57	Clutch pedal rebound bumper	2DR SDN 2DR 4DR HTP CNV SWG	55-57 Chevrolet, Pontiac	1096
B		55-56-57	Quarter window bumpers	CNV	55-57 Chevrolet Bel Air, Convertible	1221
B		55-56-57	Tailgate liftgate bumpers	SWG	55-57 Chevrolet 150 210 Bel Air, Pontiac, Station Wagon	1227
B		55-56-57-58	Door bumpers	2DR 4DR HTP 2DR SDN CNV SWG	55-58 Chevrolet, Pontiac, Olds	1053
B		55-56-57-58-59	Upper trunk or rear license plate bumper	2DR 4DR HTP 2DR SDN CNV SWG	55-59 Chevrolet 150 210 Bel Air Nomad, Pontiac, Olds	10521
B		56-57	Door bumpers	4DR HTP	56-57 Chevrolet 210 Bel Air, Pontiac, Oldsmobile, 4 Door Hardtop	10543
B		56-57	Hood to fender bumpers	2DR 4DR HTP 2DR SDN CNV SWG	56-57 Chevrolet 150 210 Bel Air Nomad	1223
B		56-57-58-59-60- 61-62-63-64-65- 66-67-68-69-70- 71-72-73-74	Hood adjustment bumpers round	2DR 4DR HTP 2DR SDN CNV SWG	56-74 Chevrolet, Pontiac, All Models	1222
B		57	Seat back rest bumpers	2DR 4DR HTP 2DR SDN CNV SWG	57 Chevrolet 150 210 Bel Air Nomad, Pontiac, Safari, Oldsmobile	1061
C		55	Rear glass channel	2DR 4DR SDN	55 Chevrolet 210 Bel Air, Pontiac 2 Door 4 Door Sedan	1203
C		55-56-57	Glass channel rear side window curved 4 door station wagon	SWG 4DR	55-57 Chevrolet, Pontiac, 4 Door Station Wagon	1120
C		55-56-57	Glass channel rear side window curved	2DR SWG	55-57 Chevrolet, Pontiac, Except Nomad And Safari, 2 Door Station Wagon	1121
C		55-56-57	Front glass channel	2DR 4DR HTP 2DR SDN CNV SWG	55-57 Chevrolet, Pontiac Safari, Except 55, 150 Convertible	1201
C		55-56-57	Glass channel rear	2DR HTP	55-57 Chevrolet 210 Bel Air, Pontiac, Hardtop	1202
C		56-57	Glass channel rear	4DR HTP	56-57 Chevrolet 210 Bel Air, Pontiac, 4 Door Hardtop	1202A
C		56-57	Rear glass channel	2DR 4DR SDN	56-57 Chevrolet 210 Bel Air, Pontiac, 2 Door 4 Door Sedan	1203A

Pontiac • Chieftain

CODE	IMAGE	YEAR	DESCRIPTION	BODY	FITS	ITEM#
D		55-56-57	Door j weatherstrip with clips	2DR 4DR HTP 2DR SDN CNV SWG	55-57 Chevrolet, Pontiac, All Models	1204
D		55-56-57	Door weatherstrip with clips & molded ends	2DR HTP CNV	55-57 Chevrolet, Pontiac, 2 Door Hardtop Convertible	1000
D		55-56-57	Door weatherstrip with clips with out molded ends	2DR HTP CNV	55-57 Chevrolet, Pontiac, 2 Door Hardtop Convertible	1001
D		55-56-57	Lower gate weatherstrip with clips & molded corner	SWG	55-57 Chevrolet 150 210 Bel Air, Pontiac Station Wagon	1226
D		55-56-57	Upper gate weatherstrip with clips & molded ends	SWG	55-57 Chevrolet 150 210 Bel Air, Pontiac, Station Wagon	1228
D		55-56-57-58-59-60	Door weatherstrip rear with clips	SWG	55-57 Chevrolet Bel Air 150 210 55-56 Pontiac Chieftain 860 870, Star Chief, 58-60 Chevrolet Sedan Delivery	1230
D		55-56-57-58-59-60	Door weatherstrip with clips sedan front and rear	2DR 4DR SDN SWG	55-60 Chevrolet Bel Air 150 210, Nomad, Pontiac Chieftain, Star Chief, Safari, Super Chief, Bonneville, Buick Century, Roadmaster, Special Also Station Wagon And Sedan Delivery	1003
D		56-57	Rear door weatherstrip with clips & molded ends	4DR HTP	56-57 Chevrolet 210 Bel Air, Pontiac, 4 Door Hardtop	1004
D		56-57	Front door weatherstrip with clips & molded ends	4DR HTP	56-57 Chevrolet 210 Bel Air, Pontiac, 4 Door Hardtop	1005
D		58	Door weatherstrip with molded corner	2DR SDN	58 Chevrolet Bel Air, Del Ray, Pontiac Chieftain, Catalina, 2 Door Sedan	2004
D		58	Door j weatherstrip	2DR 4DR HTP 2DR SDN CNV SWG	58 Chevrolet Del Ray, Biscayne, Bel Air, Impala, 58 Cadillac, 57-58 Oldsmobile 88 Oldsmobile 98, 57-58 Buick Special Century, Super, Roadmaster, 58 Pontiac	2044
D		59-60	Door j weatherstrip	2DR 4DR HTP SWG 2DR SDN 4DR SDN	59-60 Chevrolet, Pontiac, Oldsmobile, Buick, Cadillac	2093
D		61-62	Door weatherstrip front with clips	SWG 4 DR SDN	61-62 Chevrolet BelAir, Biscayne, Impala, Pontiac, Station Wagon & 4 Dr Sedan	2019
G		55-56	Steering column seal standard inner	2DR 4DR HTP 2DR SDN CNV SWG	55-56 Chevrolet 150 210 Nomad Bel Air, Pontiac	1215
G		55-56	Steering column seal auto inner	2DR 4DR HTP 2DR SDN CNV SWG	55-56 Chevrolet 150 210 Nomad Bel Air, Pontiac	1214
G		55-56-57	Chevy Steering Column Firewall Seal, Standard Transmission	2DR 4DR HTP 2DR SDN CNV SWG	55-57 Chevrolet 150 210 Nomad Bel Air, Pontiac	1216

















GUIDE TO SOFFSEAL'S PRODUCT CODES

B = Bumper sets **C** = Glass channels **D** = Door related **G** = Seals, gaskets **H** = Under hood items **I** = Interior parts
M = Miscellaneous items **R** = Roofrail, pillar post & convertible items **T** = Trunk related **W** = Window related **Z** = Weatherstrip kits



CODE	IMAGE	YEAR	DESCRIPTION	BODY	FITS	ITEM#
G		55-56-57	Door handle & lock gasket set	2DR 4DR HTP 2DR SDN CNV SWG	55-57 Chevrolet, Pontiac, 2 Door	1019
G		55-56-57	Paint gasket kit	4DR HTP SWG	55-57 Chevrolet 4 Door	1021
G		55-56-57	Door handle gaskets	2DR 4DR HTP 2DR SDN CNV SWG	55-57 Chevrolet, Pontiac	1022
G		55-56-57	Lock cylinder gasket	2DR 4DR HTP 2DR SDN CNV SWG	55-57 Chevrolet, Pontiac	1023
G		55-56-57	Antenna base gasket	2DR 4DR HTP 2DR SDN SWG CNV	55-57 Chevrolet, Pontiac	1024
G		55-56-57	Mirror gasket	2DR 4DR HTP 2DR SDN SWG CNV	55-57 Chevrolet, Pontiac	1025
G		55-56-57	Steering column seal auto sponge	2DR 4DR HTP 2DR SDN CNV SWG	55-57 Chevrolet 150 210 Nomad Bel Air, Pontiac	1213
G		55-56-57	Rear wheel housing seal all	ALL BODY STYLES	55-57 Chevrolet, Pontiac	1220A
G		57	Steering column seal standard inner	2DR 4DR HTP 2DR SDN CNV SWG	57 Chevrolet 150 210 Nomad Bel Air, Pontiac	1215A
G		57	Steering column seal auto inner	2DR 4DR HTP 2DR SDN CNV SWG	57 Chevrolet 150 210 Nomad Bel Air, Pontiac	1214A
G		58	Steering column seal with automatic trans	2DR 4DR HTP 2DR SDN CNV SWG	58 Chevrolet Pontiac	2056
G		58	Steering column seal sponge	2DR 4DR HTP 2DR SDN CNV SWG SR	58 Chevrolet Pontiac, Universal Fit Street Rod And Custom, Standard Transmission	2056A
G		58	Door handle & lock gaskets	2DR 4DR HTP 2DR SDN SWG CNV	58 Chevrolet Pontiac	2059
H		55-56-57	Firewall grommet	2DR 4DR HTP 2DR SDN SWG CNV	55-57 Chevrolet All, Pontiac, Olds	1026
H		55-56-57-58-59	Hood to cowl seal	2DR 4DR HTP 2DR SDN SWG CNV TRK	55-56 Chevrolet, Pontiac, Oldsmobile, 55-59 Chevrolet, Gmc Truck	1080

Pontiac • Chieftain

CODE	IMAGE	YEAR	DESCRIPTION	BODY	FITS	ITEM#
H		56	A-arm seals with cloth backing	2DR 4DR HTP 2DR SDN CNV SWG	56 Chevrolet 150 210 Bel Air Nomad	1082
H		56-57-58-59-60	Firewall grommet main wiring harness	2DR 4DR HTP 2DR SDN 2DR SDN SWG CNV	56-60 Chevrolet, Pontiac, Olds	1027
H		57	A-arm seals with staples	2DR 4DR HTP 2DR SDN CNV SWG	57 Chevrolet 150 210 Bel Air Nomad	1084
H		57	Hood to cowl seal	2DR 4DR HTP 2DR SDN CNV SWG	57 Chevrolet 150 210 Bel Air	1101
H		57	Hood to cowl seal clips & screws	2DR 4DR HTP 2DR SDN CNV SWG	57 Chevrolet 150 210 Bel Air	1102
I		55-56-57	Gear shift grommet	2DR 4DR HTP 2DR SDN CNV SWG	55-57 Chevrolet, Pontiac, Oldsmobile All	1094
I		55-56-57-61-62-63-64	Glove box arm grommet	2DR 4DR HTP 2DR SDN CNV SWG	55-57 And 61-64 Chevrolet, Pontiac, Oldsmobile All	10691
I		58	Gear shift grommet column	2DR 4DR SDN HTP CNV	58 Chevrolet Del Ray, Biscayne, Bel Air, Impala, Cadillac, Oldsmobile 88 Oldsmobile 98, Buick Special, Century, Roadmaster, Riviera, Pontiac	2185
M		55-56-57	Lower speedo cable wiring harness grommet	2DR 4DR HTP SDN CNV SWG	55-57 Chevrolet, Pontiac, 2 Door 4 Door Hardtop Sedan Convertible Station Wagon	1099
M		55-56-57	Accelerator pedal	2DR 4DR HTP SDN CNV SWG	55-57 Chevrolet 150 210 Bel Air Nomad, Pontiac, 55-57 Corvette, 2 Door 4 Door Hardtop Sedan Convertible Station Wagon	1050
M		55-56-57-59-60-61	Gear tube grommet	2DR 4DR HTP SDN CNV SWG	55-57 And 59-60 Chevrolet Pontiac, Oldsmobile, 60-61 Chevrolet Truck, Gmc Truck, 2 Door 4 Door Hardtop Sedan Convertible Station Wagon	1095
R		55-56-57	Header seal	CNV	55-57 Chevrolet Bel Air, Pontiac Convertible	1031
R		56-57	Roofrail weatherstrip	4DR HTP	56-57 Chevrolet 210 Bel Air, Pontiac, 4 Door Hardtop	1028
R		58	Roofrail weatherstrip	2DR HTP	58 Chevrolet Bel Air Sport Coupe, Pontiac Chieftain, 2 Door Hardtop	20431
T		49-50-51-52-53	Trunk weatherstrip	2DR SDN 4DR SDN 2DR HTP 4DR HTP CNV	49-52 Chevrolet, Pontiac, 49-53 Oldsmobile, 49-50 Buick	0494



GUIDE TO SOFFSEAL'S PRODUCT CODES						
B = Bumper sets	C = Glass channels	D = Door related	G = Seals, gaskets	H = Under hood items	I = Interior parts	Z = Weatherstrip kits
M = Miscellaneous items	R = Roofrail, pillar post & convertible items		T = Trunk related	W = Window related		



CODE	IMAGE	YEAR	DESCRIPTION	BODY	FITS	ITEM#
T		55-56	Trunk weatherstrip	2DR 4DR HTP 2DR SDN CNV	55-56 Chevrolet 150, Chevrolet 210, Chevrolet Bel Air, Chevrolet Nomad, Oldsmobile 98, Pontiac Chieftain, Pontiac 860, Pontiac 870, Pontiac Super Chief, Pontiac Bonneville, Pontiac Star Chief, Pontiac Safari	6012
T		55-56-57	Trunk mat	2DR 4DR HTP 2DR SDN 4DR SDN	55-57 Chevrolet 150 210 Bel Air, Pontiac, Hardtop Sedan	1217
T		55-56-57	Trunk mat	CNV	55-57 Chevrolet Bel Air, Pontiac, Convertible	1217A
T		55-56-57	Trunk area access plugs	2DR 4DR HTP 2DR SDN CNV	55-57 Chevrolet 150 210 Bel Air, Pontiac	1218
T		55-56-57	Spare tire well plugs	2DR 4DR HTP 2DR SDN CNV	55-57 Chevrolet 150 210 Bel Air, Pontiac Chieftain, Starchief, Super Chief, Oldsmobile	1219
T		57	Trunk weatherstrip with clips	2DR 4DR HTP 2DR SDN CNV	57 Chevrolet, Pontiac Except Star Chief	1011
W		37-38-39-40-41-42-43-44-45-46-47-48-49-50-51-52-53-54	Mohair channel liner, 4 feet of 2 7/8 inch mohair lining material	CNV 2DR 4DR HTP	Bel Air 150 210, Nomad, Chieftain, 860/870 Star Chief, Safari, Super Chief, Bonneville, Nova, Omega, Apollo, Ventura, Skylark	0420
W		49-50-51-52-53-54-55-56-57	Quarter glass vertical seals cloth covered	2DR HTP CNV	53-57 Chevrolet Bel Air, 49-52 Styleline, Fleetline, Pontiac, 2 Door Hardtop Convertible	1212
W		49-50-51-52-53-54-55-56-57	Quarter glass vertical seals not cloth covered	2DR HTP CNV	53-57 Chevrolet Bel Air, 49-52 Styleline, Pontiac, 2 Door Hardtop Convertible	1212A
W		55-56-57	Glass setting channel, doors only	2DR HTP 2DR SDN	55-57 Chevrolet, Pontiac Safari, Oldsmobile, 2 Door Hardtop	1211
W		55-56-57	Front of door flipper stops	2DR HTP	55-57 Chevrolet, Pontiac, Oldsmobile 2 Door Hardtop	1086
W		55-56-57	Front flipper to vent stop	2DR HTP	55-57 Chevrolet, Pontiac, Oldsmobile, 2 Door Hardtop	1088
W		55-56-57	Flipper reline kit	2DR HTP	55-57 Chevrolet, Oldsmobile, Pontiac, 2 Door Hardtop	1089
W		55-56-57	Cozy vent seals	2DR SDN 4DR SDN SWG	55-57 Chevrolet, Pontiac, 2 Door And 4 Door Sedan And Station Wagon Except Nomad And Safari	1033
W		55-56-57	Window weatherstrip with division bar & window channel replacement style	2DR SDN	55-57 Chevrolet 150 210 Bel Air, Pontiac, 2 Door, Sedan	1042
W		55-56-57	Window weatherstrip replacement style	2DR SDN	55-57 Chevrolet 150 210 Bel Air, Pontiac 2 Door Sedan	1042A
W		55-56-57	Window weatherstrip with division bar & window channel replacement style	4DR SDN	55-57 Chevrolet 150 210 Bel Air, Pontiac, 4 Door Sedan	1043

Pontiac • Chieftain

CODE	IMAGE	YEAR	DESCRIPTION	BODY	FITS	ITEM#
W		56-57	Window weatherstrip replacement style	4DR HTP	56-57 Chevrolet 210 Bel Air, Pontiac, 4 Door Hardtop	1044



GUIDE TO SOFFSEAL'S PRODUCT CODES

B = Bumper sets **C** = Glass channels **D** = Door related **G** = Seals, gaskets **H** = Under hood items **I** = Interior parts
M = Miscellaneous items **R** = Roofrail, pillar post & convertible items **T** = Trunk related **W** = Window related **Z** = Weatherstrip kits



CODE	IMAGE	YEAR	DESCRIPTION	BODY	FITS	ITEM#
B		47-48-49-50-51-52-53-54-55-56-57-58-59-60-61-62-63-64-65-66-67-68-69-70-71-72-73-74-75-76-77-78-79-80-81-82-83-84-85-86-87	Glove box door bumpers	2DR 4DR HTP 2DR SDN CNV SWG TRK	All Chevrolet, Pontiac, Oldsmobile, Buick 47-87 Chevrolet, Gmc Truck	1069
B		58-59-60-61-62-63-64-65-66-67-68	Trunk bumpers	2DR 4DR HTP 2DR SDN CNV SWG	58-64 Chevrolet, Pontiac, Oldsmobile, Buick, Cadillac, 67-68 Pontiac Firebird, Chevrolet Camaro	2322
B		62-63-64-65-66-67-68-69-70-71-72-73-74-75	Trunk bumpers	2DR HTP 2DR SDN CNV	70-75 Chevrolet Camaro, Pontiac Firebird, 62-73 Chevy II Nova, 64-72, Pontiac GTO, Tempest, Le Mans, Chevrolet Chevelle, Monte Carlo, Buick Skylark, Oldsmobile Cutlass, 65-69 Chevrolet Corvair, 65-70 Full Size Chevrolet	3112
B		65-66-67-68-69-70-71-72-73-74-75-76-77-78-79-80-81-82-83-84-85-86-87-88-89-90-91-92-93-94-95-96-97-98-99-00-01-02	Door bumpers	2DR 4DR HTP 2DR SDN SWG CNV	65-66 Chevrolet, Pontiac, Oldsmobile, Buick, 65-69 Corvair, 70-02 Chevrolet Camaro, Pontiac Firebird, 68-81 Chevelle, GTO, Cutlass, Skylark, 68-72 El Camino, Tempest, LeMans GTO, 70-72 Monte Carlo	2321
B		67	Fold down seat bumper	2DR HTP CNV	67 Chevrolet Camaro, Pontiac Firebird 2 Door Hardtop Convertible	30702
B		67-68	Hood side bumpers	2DR HTP CNV	67-68 Pontiac Firebird	6832
B		67-68-69	Bucket seat bumpers	2DR HTP CNV	67-69 Chevrolet Camaro, Pontiac Firebird 2 Door Hardtop Convertible	3070
B		67-68-69	Bumper kit convertible top	CNV	67-69 Chevrolet Camaro, Pontiac Firebird Convertible	30431
B		67-68-69	Door bumpers	2DR HTP CNV	67-69 Chevrolet Camaro, Pontiac Firebird 2 Door Hardtop Convertible	31101
B		67-68-69-70-71-72	Rubber ash tray bumpers 2 per car	2DR HTP CNV	67-72 Chevrolet Camaro, Pontiac Firebird 2 Door Hardtop Coupe Convertible	3057
B		68-69	Fold down seat bumper	2DR HTP CNV	68-69 Chevrolet Camaro, Pontiac Firebird 2 Door Hardtop Convertible	30701
B		69	Trunk bumpers	2DR HTP CNV	69 Chevrolet Camaro, Pontiac Firebird 2 Door Hardtop Convertible	3113
B		69	License panel bumpers rear	2DR 4DR SDN HTP CNV	69 Chevrolet Camaro, Pontiac Firebird, 64-72 Chevrolet Chevelle, Pontiac Tempest, LeMans, GTO, Grand Prix, Oldsmobile Cutlass, Buick Special, Skylark	31151
B		69	Hood side bumpers set of 4	2DR HTP CNV	69 Pontiac Firebird	6831

Pontiac • Firebird

CODE	IMAGE	YEAR	DESCRIPTION	BODY	FITS	ITEM#
B		70-71-72-73-74-75-76-77-78-79-80-81	Hood side bumpers 6 per car	2DR HTP	70-81 Pontiac Firebird	6833
B		70-71-72-73-74-75-76-77-78-79-80-81	Hood side bumpers 4 per car	2DR HTP	70-81 Chevrolet Camaro, Pontiac Firebird 2 Door Hardtop Coupe	30241
D		67	Door weatherstrip with clips & molded ends	2DR HTP CNV	67 Chevrolet Camaro, Pontiac Firebird 2 Door Hardtop Convertible	3000
D		68-69	Door weatherstrip with clips & molded ends	2DR HTP CNV	68-69 Chevrolet Camaro, Pontiac Firebird, 2 Door Hardtop Convertible	3010
D		70-71-72-73-74-75-76-77-78-79-80-81	Door weatherstrip with clips & molded ends	2DR CPE	70-81 Chevrolet Camaro, Pontiac Firebird, F-Body, 2 Door Coupe	3015
D		82-83-84-85-86-87-88-89-90-91-92	Door weatherstrip with clips & molded ends	2DR CPE	82-92 Chevrolet Camaro, Pontiac Firebird, 2 Door Coupe	3016
D		93-94-95-96-97-98-99-00-01-02	Bottom of Door Seal	2DR CNV T-TOP	93-02 Chevrolet Camaro, 93-02 Pontiac Firebird	3202
D		93-94-95-96-97-98-99-00-01-02	Top of door seal front	2DR CNV T-TOP	93-02 Chevrolet Camaro, 93-02 Pontiac Firebird	3203
D		93-94-95-96-97-98-99-00-01-02	Top of Door Seal, Rear	2DR CNV T-TOP	93-02 Chevrolet Camaro, 93-02 Pontiac Firebird	3204
D		93-94-95-96-97-98-99-00-01-02	Header / Front of door seal	2DR CNV	93-02 Chevrolet Camaro, 93-02 Pontiac Firebird	3206
D		93-94-95-96-97-98-99-00-01-02	Rear of door seal	2DR CNV	93-02 Chevrolet Camaro, 93-02 Pontiac Firebird	3207
D		93-94-95-96-97-98-99-2000-2001-2002	Door Weatherstrips	2DR CPE	93-02 Fourth Generation Chevrolet Camaro Pontiac Firebird	3197
D		93-94-95-96-97-98-99-2000-2001-2002	T-Top door seal weatherstrip	2DR CPE	93-02 Fourth Generation Chevrolet Camaro Pontiac Firebird	3198
D		93-94-95-96-97-98-99-2000-2001-2002	T-Top Weatherstrip end of top seal	2DR CPE	93-02 Fourth Generation Chevrolet Camaro Pontiac Firebird	3199
G		00-99	Gas tank anti squeak strips	2DR 4DR HTP SDN CNV SWG TRK	All Except Camaro And Firebird	1012
G		65-66-67-68-69	Antenna gasket	2DR 4DR SDN HTP CNV	68 Chevrolet 67-69 Chevrolet Camaro, Pontiac Firebird, 68-69 Chevrolet Chevelle, El Camino, 66-69 Chevrolet Nova	2409
G		65-66-67-68-69-70-71-72-73-74-75-76-77-78-79	Mirror gasket	2DR 4DR HTP 2DR SDN CNV SWG	68-69 Chevrolet 65-66 Bel Air Biscayne Impala 67-79 Chevrolet Camaro 66-72 Nova 66-72 Chevelle 70 El Camino 67-68 Pontiac Firebird	2305



GUIDE TO SOFFSEAL'S PRODUCT CODES

B = Bumper sets **C** = Glass channels **D** = Door related **G** = Seals, gaskets **H** = Under hood items **I** = Interior parts
M = Miscellaneous items **R** = Roofrail, pillar post & convertible items **T** = Trunk related **W** = Window related **Z** = Weatherstrip kits



CODE	IMAGE	YEAR	DESCRIPTION	BODY	FITS	ITEM#
G		66-67-68-69-70-71-72	Door handle & lock gaskets set	2DR HTP 2DR SDN CNV	67-69 Chevrolet Camaro, Pontiac Firebird, 66-72 Chevy II Nova, 64-72 Chevrolet Chevelle, Pontiac Tempest, LeMans, GTO, Buick Skylark, Oldsmobile Cutlass, 70-72 Chevrolet Monte Carlo	3021
G		66-67-68-69-70-71-72	License light gasket	2DR 4DR HTP SDN CNV SWG	66-72 Chevy II Nova, Biscayne, Bel Air, Impala, Chevelle, 67-72 Chevrolet Camaro, Pontiac Firebird	2378
G		67	Wiper motor to firewall seal	2DR HTP CNV	67 Chevrolet Camaro, Pontiac Firebird 2 Door Hardtop Convertible	30301
G		67-68	Taillight, housing seals	2DR HTP CNV	67-68 Pontiac Firebird	6846
G		67-68-69-70-71-72-73-74-75-76-77-78-79-80-81	Door lock cylinder gasket	2DR HTP 2DR SDN CNV	67-81 Chevrolet Camaro, Pontiac Firebird 2 Door Hardtop Coupe Convertible	30211
G		68	Parklight lens gaskets	2DR SDN 2DR 4DR HTP CNV	68 Pontiac Firebird, LeMans, GTO	6461
G		68	Rear sidemarker gaskets	2DR HTP CNV	68 Pontiac Firebird	6844
G		68-69	Wiper motor to firewall seal	2DR HTP CNV	68-69 Chevy II Nova, Chevelle, Camaro, Pontiac Firebird	30303
G		69	Taillight housing seals	2DR HTP CNV	69 Pontiac Firebird	6847
G		69	Rear sidemarker gaskets	2DR HTP CNV	69 Pontiac Firebird	6845
G		70-71-72-73	Taillamp housing gaskets	2DR HTP	70-73 Pontiac Firebird	6849
G		70-71-72-73	Taillamp lens gaskets	2DR HTP	70-73 Pontiac Firebird	6850
G		70-71-72-73-74-75-76	Shaker scoop to hood seal	2DR HTP	70-76 Pontiac Firebird	6835
G		70-71-72-73-74-75-76-77-78-79-80-81	Front & rear side lamp marker gaskets	2DR HTP CNV	70-81 Pontiac Firebird	30513
G		74-75-76-77	Front side marker gaskets	2DR HTP CNV	74-77 Chevrolet Camaro, Pontiac Firebird 2 Door Hardtop Coupe Convertible	30511
G		78-79-80-81	Front side marker gaskets	2DR HTP CNV	78-81 Chevrolet Camaro, Pontiac Firebird 2 Door Hardtop Coupe Convertible	30512
H		64-65-66-67-68-69-70-71-72	Firewall wiring gutter plk	2DR 4DR HTP 2DR SDN SWG CNV	Chevy Chevelle, Biscayne, Bel Air, Impala, Caprice, Nova, Camaro, Cadillac Calais, Deville, Fleetwood, Oldsmobile 88, 98, Jetstar, Starfire, Pontiac Catalina, Bonneville, Firebird, Buick Lesabre, Wildcat, Electra	2328

Pontiac • Firebird

CODE	IMAGE	YEAR	DESCRIPTION	BODY	FITS	ITEM#
H		67	Cowl firewall seal set	2DR HTP CNV	67 Chevrolet Camaro, Pontiac Firebird 2 Door Hardtop Convertible	30302
H		67-68	Splash flap with staples, 5 pc set	2DR HTP CNV	67-68 Chevrolet Camaro, Pontiac Firebird 2 Door Hardtop Convertible	3045
H		67-68-69	Wiper motor grommets	2DR HTP CNV	67-69 Chevrolet Camaro, Pontiac Firebird 2 Door Hardtop Convertible	3046
H		67-68-69	Hood to cowl seal	2DR HTP CNV	67-69 Chevrolet Camaro, Pontiac Firebird, 2 Door Hardtop And Convertible	3023
H		67-68-69	Hood insulation with clips	ALL BODY STYLES	67-69 Pontiac Firebird	6853
H		67-68-69	Speedo cable grommets	2DR HTP CNV	67-69 Chevrolet Camaro, Pontiac Firebird 2 Door Hardtop Convertible	3047
H		68	Cowl firewall seal set	2DR HTP CNV	68 Chevrolet Camaro, Pontiac Firebird 2 Door Hardtop Convertible	3030
H		68-69	Firewall grommet	2DR HTP CNV	68-69 Chevrolet Camaro, Pontiac Firebird 2 Door Hardtop Convertible	30331
H		68-69	Core support to radiator seal with a/c	2DR HTP CNV	68-69 Chevrolet Camaro, Pontiac Firebird, 2 Door Hardtop And Convertible	30235
H		68-69-70-71-72-73-74	Firewall cowl seal set	2DR HTP CNV	69 Chevrolet Camaro, Pontiac Firebird, 68-74 Chevy II Nova	3032
H		69	Splash flap set with staples 5 piece	2DR HTP CNV	69 Chevrolet Camaro, Pontiac Firebird 2 Door Hardtop Convertible	3045A
H		69	Plastic wiring gutter	2DR HTP CNV	69 Pontiac Firebird	6840
H		70-71-72-73	Front of hood seal with a/c	2DR HTP CNV	70-73 Chevrolet Camaro, Pontiac Firebird 2 Door Hardtop Coupe Convertible	30233
H		70-71-72-73-74-75-76-77	Hood insulation	2DR HTP	70-77 Pontiac Firebird	6834
H		70-71-72-73-74-75-76-77-78-79-80-81	Hood to cowl seal	2DR HTP	70-81 Chevrolet Camaro, Pontiac Firebird 2 Door Hardtop Coupe	30231
H		70-71-72-73-74-75-76-77-78-79-80-81	Hood to cowl seal clip kit, plastic	2DR HTP	70-81 Chevrolet Camaro, Pontiac Firebird 2 Door Hardtop Coupe	30232
H		70-71-72-73-74-75-76-77-78-79-80-81	Hood insulation with clips	2DR HTP CNV	70-81 Chevrolet Camaro, Pontiac Firebird, Except 80-81 Air Induction	3039
H		82-83-84-85-86-87-88-89-90-91-92	Hood to cowl seal with clips	2DR HTP	82-92 Chevrolet Camaro, Pontiac Firebird 2 Door Coupe Hardtop	30236



GUIDE TO SOFFSEAL'S PRODUCT CODES						
B = Bumper sets	C = Glass channels	D = Door related	G = Seals, gaskets	H = Under hood items	I = Interior parts	
M = Miscellaneous items	R = Roofrail, pillar post & convertible items		T = Trunk related	W = Window related	Z = Weatherstrip kits	



CODE	IMAGE	YEAR	DESCRIPTION	BODY	FITS	ITEM#
H		ALL-MODELS- WHERE-APPLICABLE	Air cleaner lid seal, cut to fit	2DR 4DR HTP 2DR SDN CNV SWG	GM All	2099
I		64-65-66-67-68- 69-70	Sun visor tip	2DR 4DR SDN HTP CNV	64-70 All Makes And Models	4006
I		64-65-66-67-68- 69-70-71-72-73-74	Park brake pedal pad	2DR HTP CNV	El Camino Cutlass Chevelle Chevy II Camaro Firebird LeMans Tempest GTO Grand Prix Full Size Centurion Century Electra Invicta LeSabre Regal Riviera Skylark Wildcat Monte Carlo	3094
I		65-66-67-68	Standard horn cap rubber retainer ring	2DR HTP CNV 2DR SDN SWG	67-68 Chevrolet Camaro, Pontiac Firebird 65-67 Chevelle	3079
I		67-68-69	Shift boot 3 & 4-speed with console	2DR HTP 2DR SDN CNV	67-69 Chevrolet Camaro, 67 Pontiac Firebird, 68-73 Chevrolet Nova	3072
I		67-68-69	Lower steering column boot	2DR HTP CNV	67-69 Chevrolet Camaro, Pontiac Firebird 2 Door Hardtop Convertible	3075
I		67-68-69	Brake pedal pad automatic disc	2DR HTP CNV	67-69 Chevrolet Camaro, Pontiac Firebird 2 Door Hardtop Convertible	3040
I		69-70-71-72-73- 74-75	Park brake pedal pad	2DR HTP CNV	69-75 Chevy II Nova, Camaro, Pontiac Firebird	3095
I		70-71-72-73-74-75	Upper shift boot	2DR HTP CNV	70-75 Chevrolet Camaro, Pontiac Firebird 2 Door Hardtop Convertible	3077
I		73-74-75-76-77-78- 79-80-81	Clutch pedal pad	2DR HTP CNV	73-81 Chevrolet Camaro, Pon- tiac Firebird 2 Door Hardtop Coupe Convertible	30961
K		87-88-89-90-91-92	Kit, includes horizontal and vertical roofrails, rear bow seal, header seal	2DR CNV	87-92 Chevrolet Camaro, Pontiac Firebird 2 Door Convertible	3187
M		00-99	Window weld ribbon sealer 3/8 inch round	ALL BODY STYLES	All Makes And Models	08622
M		57-58-59-60-61- 62-63-64-65-66- 67-68-69-70-71-72- 73-74-75-76-77-78- 79-80-81	Bellhousing to clutch fork rubber boot	2DR 4DR HTP SDN CNV SWG	57-81 GM All Manual Transmission	2196
M		64-65-66-67-68-69	Rocker panel flap plug, requires 2	2DR 4DR SDN HTP CNV	64-68 Chevrolet Chevelle, Pontiac GTO, Oldsmobile Cutlass, Buick Sky- lark, 67-69 Chevrolet Camaro, Pontiac Firebird, 2 Door 4 Door Sedan Hardtop Convertible	5013
M		66-67-68-69-70- 71-72-73-74-75	Accelerator pedal	2DR HTP CNV SDN SWG	67-75 Chevrolet Camaro, Pontiac Firebird, 68-72 Chevrolet Corvette, Chevelle, 68-75 Chevy II Nova, 66-72 Pontiac Tempest, LeMans, GTO, 2 Door Hardtop Convertible Sedan Station Wagon	3090

Pontiac • Firebird

CODE	IMAGE	YEAR	DESCRIPTION	BODY	FITS	ITEM#
M		67-68-69	Anti-squeak gas tank kit	2DR HTP CNV	67-69 Chevrolet Camaro, Pontiac Firebird, 2 Door Hardtop Convertible	3117
M		67-68-69-70-71-72	Core support bushing & bolt kit	2DR HTP CNV SDN	67-72 Chevy II Nova 2 Door 4 Door Sedan, Camaro, Pontiac Firebird, 2 Door Hardtop Convertible	3069
M		67-68-69-70-71-72	Firewall insulation pad with clips without a/c	2DR SDN 4DR HTP CNV	67-69 Chevrolet Camaro, Pontiac Firebird 2 Door Hardtop Convertible, 68-72 Chevrolet Nova, 2 Door 4 Door Sedan	3033
M		67-68-69-70-71-72	Firewall insulation pad with clips with a/c	2DR SDN 4DR HTP CNV SWG	67-69 Chevrolet Camaro, Pontiac Firebird 2 Door Hardtop Convertible, 68-72 Nova, 2 Door 4 Door Sedan	3033A
M		67-68-69-70-71-72	Body mount hardware kit	2DR HTP CNV SDN	67-72 Chevrolet Camaro, Pontiac Firebird 2 Door Hardtop Convertible, 68-72 Chevrolet Nova, 2 Door 4 Door Sedan	3027
M		67-68-69-70-71-72	Body mount set with steel sleeves	2DR HTP CNV SDN	67-72 Chevrolet Camaro, Pontiac Firebird, 68-72 Nova, 2 Door 4 Door Sedan	3025
M		67-68-69-70-71-72	Body Mount/bushing Bolt Kit	ALL BODY STYLES	67-72 Chevrolet Camaro, Pontiac Firebird, 68-72 Nova, 2 Door 4 Door Sedan	3025K
M		67-68-69-70-71-72-73-74-75-76-77-78-79-80-81-82-83-84	Oil filler cap	2DR 4DR SDN HTP CNV	67-84 GM All Models	5044
M		68-69-70-71-72	Door jamb louver	2DR HTP CNV SDN	68-69 Chevrolet Camaro, Pontiac Firebird, 2 Door Hardtop Convertible, Chevrolet Nova 2 Door Sedan	3026
M		68-69-70-71-72-73-74-75-76-77-78-79	Brake & clutch pedal pad	2DR HTP CNV SDN	67-72 Chevrolet Camaro Standard, Pontiac Firebird, 68-79 Chevrolet Corvette, 68-72 Chevrolet Nova, 64-72 Chevrolet Chevelle, 70-72 Monte Carlo 71-72 GTO, 2 Door Hardtop Convertible Sedan	3096
M		70-71-72-73-74-75-76-77-78-79-80-81	Firewall pad with clips with a/c	2DR SDN 4DR HTP CNV SWG	70-81 Chevrolet Camaro, Pontiac Firebird, 2 Door Coupe	30332
M		70-71-72-73-74-75-76-77-78-79-80-81	Firewall pad with clips without a/c	2DR CPE	70-81 Chevrolet Camaro, Pontiac Firebird, 2 Door Coupe	30333
R		67	Roofrail weatherstrip with molded ends	2DR HTP	67 Chevrolet Camaro, Pontiac Firebird, 2 Door Hardtop	3002
R		67	Pillar post weatherstrip with molded ends	CNV	67 Chevrolet Camaro, Pontiac Firebird Convertible	3140
R		67-68-69	Weatherstrip kit for convertible top	CNV	67-69 Chevrolet Camaro, Pontiac Firebird, Convertible	3043
R		67-68-69	Header seal kit with clips and molded end	CNV	67-69 Chevrolet Camaro, Pontiac Firebird Convertible	3044



GUIDE TO SOFFSEAL'S PRODUCT CODES









B = Bumper sets **C** = Glass channels **D** = Door related **G** = Seals, gaskets **H** = Under hood items **I** = Interior parts
M = Miscellaneous items **R** = Roofrail, pillar post & convertible items **T** = Trunk related **W** = Window related **Z** = Weatherstrip kits

Pontiac • Firebird



CODE	IMAGE	YEAR	DESCRIPTION	BODY	FITS	ITEM#
R		67-68-69	Header seal with clips and without molded ends	CNV	67-69 Chevrolet Camaro, Pontiac Firebird, Convertible	3044A
R		68-69	Roofrail weatherstrip with molded ends	2DR HTP CNV	68-69 Chevrolet Camaro, Pontiac Firebird, 2 Door Hardtop	3013
R		68-69	Pillar post weatherstrip and molded ends	CNV	68-69 Chevrolet Camaro, Pontiac Firebird Convertible	3142
R		70-71-72-73-74-75-76-77-78-79-80-81	Roofrail weatherstrip with molded ends	2DR CPE	70-81 Chevrolet Camaro, Pontiac Firebird, 2 Door Coupe	3100
R		78-79-80-81	T-top weatherstrip kit for body, outer edge of t-top and auxiliary seal	2DR	78-81 Chevrolet Camaro, Pontiac Firebird	3189
R		78-79-80-81	T-top seals fisher style single release	2DR CPE	78-81 Chevrolet Camaro, Pontiac Firebird, 2 Door Coupe	3190
R		78-79-80-81	T-top weatherstrip fits on outer edge of t-top includes auxiliary seal, fisher t-tops only	2DR CPE	78-81 Chevrolet Camaro, Pontiac Firebird, 2 Door Coupe	3192
R		78-79-80-81	Auxiliary t-top sealing strips	2DR CPE	78-81 Chevrolet Camaro, Pontiac Firebird, 2 Door Coupe	3192A
R		82-83-84-85-86-87-88-89-90-91-92	T-top roofrail weatherstrip fits t-top	2DR CPE	82-92 Chevrolet Camaro, Pontiac Firebird, 2 Door Coupe	3193
R		82-83-84-85-86-87-88-89-90-91-92	T-top weatherstrip on body	2DR CPE	82-92 Chevrolet Camaro, Pontiac Firebird, 2 Door Coupe	3191
R		82-83-84-85-86-87-88-89-90-91-92	T-Top Auxiliary Seal	2DR	82-92 Chevrolet Camaro Pontiac Firebird	3188
R		82-83-84-85-86-87-88-89-90-91-92	T-top weatherstrip kit seal for body & outer edge of t-top	2DR CPE	82-92 Chevrolet Camaro, Pontiac Firebird, 2 Door Coupe	3196
R		82-83-84-85-86-87-88-89-90-91-92	Roofrail weatherstrip third generation f-body	2DR CPE	82-92 Chevrolet Camaro, Pontiac Firebird, 2 Door Coupe	3101
R		87-88-89-90-91-92	Horizontal and vertical roofrails	2DR CNV	87-92 Chevrolet Camaro, Pontiac Firebird 2 Door Convertible	3184
R		87-88-89-90-91-92	Rear bow seal	2DR CNV	87-92 Chevrolet Camaro, Pontiac Firebird 2 Door Convertible	3185
R		87-88-89-90-91-92	Header seal	2DR CNV	87-92 Chevrolet Camaro, Pontiac Firebird 2 Door Convertible	3186
R		93-94-95-96-97-98-99-00-01-02	Convertible Top Seals, 4 pieces, No Header Seal	2DR CNV	93-02 Chevrolet Camaro, 93-02 Pontiac Firebird	3208

Pontiac • Firebird

CODE	IMAGE	YEAR	DESCRIPTION	BODY	FITS	ITEM#
R		93-94-95-96-97-98-99-00-01-02	Quarter Panel to Convertible Top Seal	2DR CNV	93-02 Chevrolet Camaro, Pontiac Firebird	3210
T		67-68	Trunk mat aqua	2DR HTP CNV	67-68 Chevrolet Camaro, Pontiac Firebird 2 Door Hardtop Convertible	3120
T		67-68-69-70-71-72	Filler neck hose	2DR HTP 2DR SDN CNV	67-68 Chevrolet Camaro, Pontiac Firebird, 68-72 Nova	3028
T		67-68-69-70-71-72	Gas tank filler neck sleeve	2DR HTP 2DR SDN CNV	67-68 Chevrolet Camaro, Pontiac Firebird, 68-72 Nova	3029
T		67-68-69-70-71-72-73-74-75-76-77-78-79-80-81	Trunk weatherstrip	2DR HTP	67-81 Chevrolet Camaro, Pontiac Firebird 2 Door Hardtop Coupe	3020
T		69	Trunk mat	2DR HTP CNV	69 Chevrolet Camaro, Pontiac Firebird 2 Door Hardtop Convertible	3122
T		75-76-77-78-79-80-81-82-83-84-85-86-87-88-89-90-91-92	Trunk and Hatchback weatherstrip	2DR 4DR SDN HTP CNV	77-85 Chevrolet Impala, 77-91 Chevrolet Caprice, 82-92 Chevrolet Camaro, 75-79 Chevrolet Nova, 78-88 Chevrolet Monte Carlo, 78-83 Chevrolet Malibu, 78-83 Pontiac LeMans, 82-92 Pontiac Firebird, 75-91 Pontiac Ventura, 77-86 Pontiac Parisienne, 77-81 Pontiac Catalina, 69-88 Pontiac Grand Prix, 64-87 Pontiac LeMans, Pontiac Grand Am, 64-77 Pontiac GTO, 73-79 Oldsmobile Omega, 77-85 Oldsmobile Delta 88, 77-84 Oldsmobile 98, 77-88 Oldsmobile Cutlass, 73-75 Buick Apollo, 76-79 Buick Skylark, 77-79 Phoenix, 73-88 Buick Regal, 77-84 Buick Electra, 77-85 Buick LeSabre, 77-78 Buick Riviera, 77-91 C-Body	2424
T		93-94-95-96-97-98-99-00-01-02	Trunk Weatherstrip, 2 Door Coupe and T-Top	2DR CPE T-TOP	93-02 Chevrolet Camaro, 93-02 Pontiac Firebird	3201
T		93-94-95-96-97-98-99-00-01-02	Trunk Weatherstrip	2DR CNV	93-02 Chevrolet Camaro, 93-02 Pontiac Firebird	3205
W		67	Vent window seals	2DR HTP CNV	67 Chevrolet Camaro, Pontiac Firebird, 2 Door Hardtop Convertible	3125
W		67	Window weatherstrip, replacement style	2DR HTP	67 Chevrolet Camaro, Pontiac Firebird, 2 Door Hardtop	3130
W		67	Window weatherstrip, original style with round bead	2DR HTP	67 Chevrolet Camaro, Pontiac Firebird, 2 Door Hardtop	31301
W		67	Window weatherstrip, replacement style	CNV	67 Chevrolet Camaro, Pontiac Firebird Convertible	3131



GUIDE TO SOFFSEAL'S PRODUCT CODES

B = Bumper sets **C** = Glass channels **D** = Door related **G** = Seals, gaskets **H** = Under hood items **I** = Interior parts
M = Miscellaneous items **R** = Roofrail, pillar post & convertible items **T** = Trunk related **W** = Window related **Z** = Weatherstrip kits



CODE	IMAGE	YEAR	DESCRIPTION	BODY	FITS	ITEM#
W		67	Window weatherstrip, original style with round bead	CNV	67 Chevrolet Camaro, Pontiac Firebird, Convertible	31310
W		67	Window weatherstrip, original style with round bead outers only	2DR HTP	67 Chevrolet Camaro, Pontiac Firebird 2 Door Hardtop	31322
W		67-68	Glass run channel front door window	2DR 4DR HTP CNV	67 Chevrolet Camaro, Pontiac Firebird, 68 Chevrolet Chevelle, Oldsmobile Cutlass 68, Buick Special, Skylark, 2 Door 4 Door Hardtop Convertible	3126
W		67-68-69	Rubber door jamb u-shape	2DR HTP CNV	67-69 Chevrolet Camaro, Pontiac Firebird, 2 Door Hardtop And Convertible	3022A
W		67-68-69	Quarter window seals exact steel insert	2DR HTP CNV	67-69 Chevrolet Camaro, Pontiac Firebird, 2 Door Hardtop Convertible	3022M
W		67-68-69	Quarter window seals, all rubber	CNV 2DR HTP	67-69 Chevrolet Camaro, Pontiac Firebird 2 Door Hardtop Convertible	3022R
W		68	Window weatherstrip, original style with round bead	2DR HTP	68 Chevrolet Camaro, Pontiac Firebird, Standard Interior, 2 Door Hardtop	3134
W		68	Window weatherstrip, original style with round bead	CNV	68 Chevrolet Camaro, Pontiac Firebird, Standard Interior, Convertible	3135
W		68-67-69	Window weatherstrip replacement style	2DR HTP	68-69 Chevrolet Camaro, Pontiac Firebird 2 Door Hardtop	3132
W		68-69	Window weatherstrip, original style with round bead	2DR HTP	68-69 Chevrolet Camaro, Pontiac Firebird, Deluxe Interior, 2 Door Hardtop	31321
W		68-69	Window weatherstrip, original style with round bead, outers only	2DR HTP	68-69 Chevrolet Camaro, Pontiac Firebird 2 Door Hardtop	313221
W		68-69	Window weatherstrip replacement style	CNV	68-69 Chevrolet Camaro, Pontiac Firebird Convertible	3133
W		68-69	Window weatherstrip, original style with round bead	CNV	68-69 Chevrolet Camaro, Pontiac Firebird Convertible	31331
W		70-71-72-73-74-75-76-77-78-79-80-81	Window weatherstrip, original style with flat bead 4 piece	2DR CPE	70-81 Chevrolet Camaro Except Z-28 And Berlinetta, Pontiac Firebird Except Trans-Am	3136
W		70-71-72-73-74-75-76-77-78-79-80-81	Window weatherstrip, original style with flat bead, outers only	2DR CPE	70-81 Chevrolet Camaro, Pontiac Firebird, 2 Door Coupe	31360
W		70-71-72-73-74-75-76-77-78-79-80-81	Window weatherstrip, original style	2DR CPE	70-81 Chevrolet Camaro, Pontiac Firebird, 2 Door Coupe	3137
W		70-71-72-73-74-75-76-77-78-79-80-81	Window weatherstrip original style, outers only	2DR CPE	70-81 Chevrolet Camaro, Pontiac Firebird, 2 Door Coupe	31370
W		70-71-72-73-74-75-76-77-78-79-80-81	Window weatherstrip original style with flat bead (replacement style)	2DR CPE	78-81 Chevrolet Camaro Z28, Berlinetta, 70-81 Pontiac Firebird, Trans Am 2 Door Coupe	3141

Pontiac • Firebird

CODE	IMAGE	YEAR	DESCRIPTION	BODY	FITS	ITEM#
W		82-83-84-85-86-87-88-89-90-91-92	Window weatherstrip outers only, original style	2DR CPE	82-92 Chevrolet Camaro, Pontiac Firebird, 2 Door Coupe	3138
W		82-83-84-85-86-87-88-89-90-91-92	Window weatherstrip inners only, original style with round bead	2DR CPE	82-92 Chevrolet Camaro, Pontiac Firebird, 2 Door Coupe	3139
W		82-83-84-85-86-87-88-89-90-91-92	Front door glass seals	2DR CPE	82-92 Chevrolet Camaro, Pontiac Firebird, 2 Door Coupe	3195
Z		67	Weatherstrip kit, includes trunk weatherstrip, door weatherstrip, roofrail weatherstrip	2DR HTP	67 Chevrolet Camaro, Pontiac Firebird 2 Door Hardtop	KIT305X
Z		67	Weatherstrip kit, includes door weatherstrips, hood to cowl seal, trunk weatherstrip, window weatherstrips, lock gaskets, quarter. window seals, roofrail weatherstrips, door u jamba	2DR HTP	67 Pontiac Firebird 2 Door Hardtop	KIT655
Z		67	Weatherstrip kit, includes door weatherstrips, hood to cowl seal, trunk weatherstrip, window weatherstrips, convertible top kit, lock gaskets, pillar post seals, quarter window seals, door u jamba	CNV	67 Pontiac Firebird Convertible	KIT657
Z		68	Weatherstrip kit with wide belt chrome, includes door, roofrail, trunk weatherstrip, quarter. window seals, rubber door u jamb, hood to cowl seal, splash flap set, paint gasket kit, bumper kit, window weatherstrip, park light lens gasket, taillight lens gasket	2DR HTP	68 Chevrolet Camaro 2 Door Hardtop	KIT306E
Z		68-69	Weatherstrip kit, includes trunk weatherstrip, door weatherstrip, roofrail weatherstrip	2DR HTP	68-69 Chevrolet Camaro, Pontiac Firebird, 2 Door Hardtop	KIT306X
Z		68-69	Weatherstrip kit, includes door weatherstrips, hood to cowl seal, trunk weatherstrip, window weatherstrips, convertible top kit, lock gaskets, pillar post seals, quarter window seals, door u jamba	CNV	68-69 Pontiac Firebird Convertible	KIT658
Z		68-69	Weatherstrip kit, includes door weatherstrips, hood to cowl seal, trunk weatherstrip, window weatherstrips, lock gaskets, quarter window seals, roofrail weatherstrips, door u jamba	2DR HTP	68-69 Pontiac Firebird 2 Door Hardtop	KIT656
Z		68-69	Weatherstrip kit standard interior, weatherstrip original, includes door weatherstrip, roofrail weatherstrip, trunk weatherstrip, door handle and lock gasket set, quarter window seals, rubber door jamb, hood to cowl, window weatherstrips	2DR HTP	68-69 Pontiac Firebird 2 Door Hardtop	KIT656A







GUIDE TO SOFFSEAL'S PRODUCT CODES

B = Bumper sets **C** = Glass channels **D** = Door related **G** = Seals, gaskets **H** = Under hood items **I** = Interior parts
M = Miscellaneous items **R** = Roofrail, pillar post & convertible items **T** = Trunk related **W** = Window related **Z** = Weatherstrip kits



CODE	IMAGE	YEAR	DESCRIPTION	BODY	FITS	ITEM#
Z		70-71-72-73-74-75-76-77-78-79-80-81	Weatherstrip kit, includes trunk weatherstrip, door weatherstrip, roofrail weatherstrip	2DR CPE	70-81 Chevrolet Camaro, Pontiac Firebird 2 Door Coupe	KIT311X
Z		70-71-72-73-74-75-76-77-78-79-80-81	Weatherstrip kit, includes door weatherstrip, trunk weatherstrip, hood to cowl seal, hood to cowl seal clip kit, bumper kit, roofrail weatherstrip, window weatherstrip with round bead	2DR HTP CPE	70-81 Chevrolet Camaro, Berlinetta, Z-28, Pontiac Firebird, Trans Am, 2 Door Hardtop Coupe	KIT311B
Z		70-71-72-73-74-75-76-77-78-79-80-81	Weatherstrip kit, includes bumper kit, door weatherstrips, hood to cowl seal, roofrail weatherstrips, trunk weatherstrip, window weatherstrips, hood to cowl seal clips	2DR CPE	70-81 Chevrolet Camaro, Pontiac Firebird, 2 Door Coupe	KIT311
Z		78-79-80-81	Weatherstrip kit, includes door weatherstrip, trunk weatherstrip, hood to cowl seal, hood to cowl seal clip kit, bumper kit, t-top weatherstrip, window weatherstrip	2DR CPE	78-81 Chevrolet Camaro, Pontiac Firebird, 2 Door Coupe	KIT311AT
Z		78-79-80-81	Weatherstrip kit, includes door weatherstrip, trunk weatherstrip, hood to cowl seal, hood to cowl seal clip kit, bumper kit, t-top weatherstrip, window weatherstrip with round bead	2DR CPE	78-81 Chevrolet Camaro, Pontiac Firebird, 2 Door Coupe	KIT311BT
Z		78-79-80-81	Weatherstrip kit, includes door weatherstrip, trunk weatherstrip, hood to cowl seal, hood to cowl seal clip kit, bumper kit, t-top weatherstrip, window weatherstrip with flat bead	2DR CPE	78-81 Chevrolet Camaro, Pontiac Firebird, 2 Door Coupe	KIT311T
Z		78-79-80-81	Weatherstrip kit, includes door, trunk and t-top roofrail weatherstrips	2DR CPE	78-81 Chevrolet Camaro, Pontiac Firebird, 2 Door Coupe	KIT311XT
Z		82-83-84-85-86-87-88-89-90-91-92	Weatherstrip kit, includes hood to cowl seal with clips, door weatherstrips, roofrail weatherstrips, hatch seal, outer window weatherstrips only	2DR CPE	82-92 Chevrolet Camaro, Pontiac Firebird 2 Door Coupe	KIT312
Z		82-83-84-85-86-87-88-89-90-91-92	Weatherstrip kit, includes trunk weatherstrip, door weatherstrip, hood to cowl seal with clips, window weatherstrip, and t-top weatherstrip	2DR CPE	82-92 Chevrolet Camaro, Pontiac Firebird, 2 Door Coupe	KIT312T
Z		82-83-84-85-86-87-88-89-90-91-92	Weatherstrip kit, includes trunk weatherstrip, door weatherstrip, roofrail weatherstrip	2DR CPE	82-92 Chevrolet Camaro, Pontiac Firebird, 2 Door Coupe	KIT312X
Z		82-83-84-85-86-87-88-89-90-91-92	Weatherstrip kit, includes trunk, door and t-top roofrail weatherstrip	2DR CPE	82-92 Chevrolet Camaro, Pontiac Firebird, 2 Door, Coupe	KIT312XT

Pontiac • Grand Am

CODE	IMAGE	YEAR	DESCRIPTION	BODY	FITS	ITEM#
D		73-74-75-76-77	Door weatherstrip with clips & molded ends	2DR HTP	Grand Am 2 Door 73-77 Chevrolet, LeMans, Grand LeMans, Century, Regal, Cutlass, Chevelle Malibu Laguna, El Camino, 2 Door Hardtop	5017
D		82-83-84-85-86-87-88-89-90-91-92	Door weatherstrip front/rear	All	82-89 Skyhawk 92-97 Skylark 82-88 Cimarron 93-96 Fleetwood 82-94 Beretta 82-94 Cavalier 91-96 Caprice 82-96 Corsica 82-94 Lumina 82-93 S10 83-94 S10 Blazer 82-05 Chev Van 83-94 GMC Jimmy 82-93 GMC Sonoma 82-05 GMC Van 82-94 Achieva 82-85 Custom Cruiser 82-94 Firenza 82-94 Grand Am 82-94 Sunbird	9110
R		73-74-75-76-77	Roofrail weatherstrip	2DR HTP	73-77 Chevrolet Malibu, Pontiac LeMans, Grand Am, Buick Century, Oldsmobile Cutlass, 2 Door Hardtop	5035
T		75-76-77-78-79-80-81-82-83-84-85-86-87-88-89-90-91-92	Trunk and Hatchback weatherstrip	2DR 4DR SDN HTP CNV	77-85 Chevrolet Impala, 77-91 Chevrolet Caprice, 82-92 Chevrolet Camaro, 75-79 Chevrolet Nova, 78-88 Chevrolet Monte Carlo, 78-83 Chevrolet Malibu, 78-83 Pontiac LeMans, 82-92 Pontiac Firebird, 75-91 Pontiac Ventura, 77-86 Pontiac Parisienne, 77-81 Pontiac Catalina, 69-88 Pontiac Grand Prix, 64-87 Pontiac LeMans, Pontiac Grand Am, 64-77 Pontiac GT0, 73-79 Oldsmobile Omega, 77-85 Oldsmobile Delta 88, 77-84 Oldsmobile 98, 77-88 Oldsmobile Cutlass, 73-75 Buick Apollo, 76-79 Buick Skylark, 77-79 Phoenix, 73-88 Buick Regal, 77-84 Buick Electra, 77-85 Buick LeSabre, 77-78 Buick Riviera, 77-91 C-Body	2424













WHAT IS A PRODUCT CODE?
 Our catalog is grouped by product CODE (type) then years. See page 1 for details explaining the different Product CODES.



GUIDE TO SOFFSEAL'S PRODUCT CODES					
B = Bumper sets	C = Glass channels	D = Door related	G = Seals, gaskets	H = Under hood items	I = Interior parts
M = Miscellaneous items	R = Roofrail, pillar post & convertible items	T = Trunk related	W = Window related	Z = Weatherstrip kits	

Pontiac • Grand Prix



CODE	IMAGE	YEAR	DESCRIPTION	BODY	FITS	ITEM#
B		47-48-49-50-51-52-53-54-55-56-57-58-59-60-61-62-63-64-65-66-67-68-69-70-71-72-73-74-75-76-77-78-79-80-81-82-83-84-85-86-87	Glove box door bumpers	2DR 4DR HTP 2DR SDN CNV SWG TRK	All Chevrolet, Pontiac, Oldsmobile, Buick 47-87 Chevrolet, Gmc Truck	1069
B		66-67	Bumpers bucket seat back oval 4 per car	2DR HTP CNV 2DR SDN	66-67 Chevrolet Chevelle, El Camino, Nova, Pontiac GTO, Tempest, LeMans, Grand Prix	5085
B		69	License panel bumpers rear	2DR 4DR SDN HTP CNV	69 Chevrolet Camaro, Pontiac Firebird, 64-72 Chevrolet Chevelle, Pontiac Tempest, LeMans, GTO, Grand Prix, Oldsmobile Cutlass, Buick Special, Skylark	31151
B		70	Hood bumpers 4 per car	2DR SDN 2DR 4DR HTP CNV	70 Pontiac Grand Prix, GTO, LeMans	6447
B		71-72	Hood to fender bumpers 4 per car	2DR SDN 2DR 4DR HTP CNV	71-72 Pontiac Grand Prix, GTO, LeMans	6473
D		63-64	Door weatherstrip with clips & molded ends	2DR HTP CNV	63-64 Chevrolet Impala, 63-64 Cadillac Eldorado, Deville, 63-64 Oldsmobile 88 Oldsmobile 98 Starfire 63-64 Buick LeSabre Wildcat, Electra 63 Invicta, 63-64 Pontiac Catalina, Bonneville, Grand Prix, 2 Door Hardtop Convertible	2014
D		65-66	Door weatherstrip with clips & molded ends	2DR HTP CNV	65-66 Chevrolet Impala, Caprice, 65-66 Cadillac Calais, Deville, 65-66 Oldsmobile 88, Starfire, Oldsmobile 98, 65 Jet Star, 65-66 Buick LeSabre, Wildcat Electra, 65-66 Pontiac 2 Door Hardtop Convertible	2331
D		67-68	Door weatherstrip with clips & molded ends	CNV 2DR HTP	67-68 Chevrolet Impala, Caprice, Except 68 Caprice 2 Door Hardtop, 67-68 Cadillac Calais, Deville, 67-68 Oldsmobile 88 Oldsmobile 98, 67-68 Buick Electra, Wildcat, 67 Pontiac Catalina, Bonneville, Executive, 67 Grand Prix Convertible 2 Door Hardtop	2342
D		69-70-71-72	Door weatherstrip with clips & molded ends	2DR HTP CNV	69-72 Chevelle, Grand Prix, Monte Carlo, Skylark, Cutlass, 2 Door Hardtop And Convertible	5022
D		73-74-75-76-77	Door weatherstrip with clips	2DR HTP	73-77 Pontiac Grand Prix 2 Door Hardtop	5019
D		78-79-80-81-82-83-84-85-86-87-88	Door weatherstrip a-body with clips & molded ends	2DR HTP	78-88 Chevrolet Malibu, El Camino, Monte Carlo, Oldsmobile Cutlass, Buick Regal, Pontiac LeMans, Grand Prix 2 Door, Replacement Part For Buick, Oldsmobile And Pontiac, 82-88 Is A G Body	5025
G		60-63-64-69-70	Door handle & lock gaskets	2DR 4DR HTP 2DR SDN CNV SWG	60 Chevrolet Biscayne, Impala, Bel Air, Cadillac, Oldsmobile 89 Oldsmobile 98, Buick LeSabre, Invicta, Electra, Wild Cat, Pontiac Catalina, Star Chief, Bonneville, Grand Prix, Ventura	2098

Pontiac • Grand Prix





CODE	IMAGE	YEAR	DESCRIPTION	BODY	FITS	ITEM#
H		ALL-MODELS- WHERE-APPLICABLE	Air cleaner lid seal, cut to fit	2DR 4DR HTP 2DR SDN CNV SWG	GM All	2099
I		59-60-61-62-63- 64-65-66	Gear shift grommet column	2DR 4DR SDN HTP CNV	59-66 Chevrolet Biscayne, Bel Air, Impala, 59-66 Cadillac, 59-63 Oldsmo- bile 88 Oldsmobile 98, 61 Starfire, 64-66 Starfire, Jet Star, 59-66 Buick LeSabre, Invicta, Electra, 63 Wildcat, Riviera, 59-66 Pontiac	2185A
I		64-65-66-67-68- 69-70-71-72	Brake & clutch pedal pads	2DR HTP 2DR SDN CNV SWG	64-72 Pontiac Grand Prix, GTO	6422
I		64-65-66-67-68- 69-70-71-72	Brake pedal pad automatic trans	2DR SDN CNV 2DR 4DR HTP	69-72 Pontiac Grand Prix 64-70 Pontiac GTO, Le Mans	6423
I		64-65-66-67-68- 69-70-71-72-73-74	Park brake pedal pad	2DR HTP CNV	El Camino Cutlass Chevelle Chevy II Camaro Firebird LeMans Tempest GTO Grand Prix Full Size Centurion Century Electra Invicta LeSabre Regal Riviera Skylark Wildcat Monte Carlo	3094
I		65-66-67-68-69-70	Park brake pedal pad	2DR SDN CNV 2DR 4DR HTP	65-70 Pontiac Grand Prix, GTO, LeMans	6425
R		65-66	Roofrail weatherstrip with molded ends	2DR HTP	65-66 Chevrolet Impala, Caprice, 65-66 Cadillac Calais, Deville, 65-66 Oldsmobile 88, Jet Star, Star Fire, Oldsmobile 98, 65-66 Buick LeSabre, Wildcat, Electra, 65-66 Pontiac 2 Door Hardtop	2333
R		66-67-68-69-70	Weatherstrip kit for convertible top includes header seal (7 piece kit)	CNV	66-70 Chevrolet Impala, 66-70 Oldsmobile 88, 66-70 Buick LeSabre, Wildcat, 66-70 Pontiac Bonneville, Catalina, 67 Pontiac Grand Prix, Convertible	2366
R		69-70-71-72	Roofrail weatherstrip with molded ends	2DR HTP CNV	69-72 Chevrolet, Pontiac GTO, LeMans, Grand Prix, Buick Skylark, Oldsmobile Cutlass 442, 2 Door Hardtop	5024
R		73-74-75-76-77	Roofrail weatherstrip	2DR HTP	73-77 Pontiac Grand Prix, Chevrolet Monte Carlo, 2 Door Hardtop	5035B
R		78-79-80-81-82- 83-84-85-86-87-88	Roofrail weatherstrip	2DR HTP	78-88 Chevrolet Monte Carlo, Oldsmo- bile Cutlass, Buick Regal, Pontiac Grand Prix, 2 Door	5400
R		78-79-80-81-82- 83-84-85-86-87-88	T-top weatherstrip fits on body	2DR HTP	78-88 Chevrolet Monte Carlo, Oldsmo- bile Cutlass, Buick Regal, Pontiac Grand Prix, 2 Door Hardtop	5402
R		78-79-80-81-82- 83-84-85-86-87-88	T-top weatherstrip fits on t-top	2DR HTP	78-88 Chevrolet Monte Carlo, Oldsmo- bile Cutlass, Buick Regal, Pontiac Grand Prix, 2 Door Hardtop	5403
R		78-79-80-81-82- 83-84-85-86-87-88	Auxiliary t-top sealing strips	2DR HTP	78-88 Chevrolet Monte Carlo, Oldsmo- bile Cutlass, Buick Regal, Pontiac Grand Prix, 2 Door Hardtop	5404



GUIDE TO SOFFSEAL'S PRODUCT CODES

B = Bumper sets **C** = Glass channels **D** = Door related **G** = Seals, gaskets **H** = Under hood items **I** = Interior parts
M = Miscellaneous items **R** = Roofrail, pillar post & convertible items **T** = Trunk related **W** = Window related **Z** = Weatherstrip kits



CODE	IMAGE	YEAR	DESCRIPTION	BODY	FITS	ITEM#
T		58-59-60-61-62-63-64-65-66-67-68-69	Trunk weatherstrip exact profile	2DR 4DR HTP 2DR SDN CNV	58-64 Chevrolet Biscayne, 58-64 Chevrolet Bel Air, Chevrolet Impala, 60-69 Chevrolet Corvair, 59-64 Pontiac Parisienne, 59-64 Pontiac Catalina, 59-64 Pontiac Star Chief, 60-61 Pontiac Ventura, 62-64 Pontiac Grand Prix, 58-64 Oldsmobile Delta 88, 58-64 Oldsmobile Dynamic 88, Oldsmobile Super 88, Oldsmobile Super 98, 61-64 Oldsmobile Starfire, 64 Oldsmobile Jetstar, 59-64 Buick LeSabre, 59-62 Buick Invicta, 59-64 Buick Electra, 62-64 Buick Wildcat, 63-65 Buick Riviera, 58-60 Cadillac Deville, Cadillac Eldorado, Cadillac Series 62, Cadillac Series 60 Special, Cadillac Series 75, 58-64 C-Body	2001
T		62-63-64-65-66-67-68-69-70-71-72-73	Door and tailgate bottom drain hole seal	2DR 4DR HTP SDN CNV SWG CPE	62-73 Chevy Nova, Chevelle, Impala, Caprice Pontiac Catalina, Star Chief, Bonneville, Grand Prix Oldsmobile F85	2118
T		64-65-66-67-68-69-70-71-72-73-74-75-76-77	Trunk weatherstrip exact profile length 17 feet	2DR 4DR HTP 2DR SDN CNV	65-72 Chevy II, 65-72 Chevrolet Biscayne, 65-75 Chevrolet Bel Air, 65-76 Chevrolet Impala, 65-76 Chevrolet Caprice, 64-77 Chevrolet Chevelle, 70-77 Chevrolet Monte Carlo, 65-76 Buick LeSabre, 64-77 Buick Wildcat, 64-77 Buick Skylark, 71-73 Buick Centurion, 64-72 Buick Grand Special, 73-77 Buick Century, 73-88 Buick Regal, 73-88 Buick Grand National, 65-76 Buick Electra, 65-76 Oldsmobile Delta 88, 67-69 Oldsmobile Delmont 88, 65-66 Oldsmobile Dynamic 88, 65-66 Oldsmobile Starfire, 65 Oldsmobile Jetstar, 64-77 Oldsmobile Cutlass 442, 64-88 Oldsmobile Cutlass, 65-76 Oldsmobile 98, 65-76 Pontiac Parisienne, 64-72 Pontiac LeMans, 65-70 Pontiac Catalina, 65-66 Pontiac Star Chief, 67-70 Pontiac Executive, 71-75 Pontiac Grand Ville, 65-77 Pontiac Grand Prix, 64-72 Pontiac Tempest, 62-72 Nova, Ventura, 73-74 Non-Hatchback, Up to 1975 with groove channel, Apollo, Nova, Omega, Ventura 65-76 C-Body	2003
T		75-76-77-78-79-80-81-82-83-84-85-86-87-88-89-90-91-92	Trunk and Hatchback weatherstrip	2DR 4DR SDN HTP CNV	77-85 Chevrolet Impala, 77-91 Chevrolet Caprice, 82-92 Chevrolet Camaro, 75-79 Chevrolet Nova, 78-88 Chevrolet Monte Carlo, 78-83 Chevrolet Malibu, 78-83 Pontiac LeMans, 82-92 Pontiac Firebird, 75-91 Pontiac Ventura, 77-86 Pontiac Parisienne, 77-81 Pontiac Catalina, 69-88 Pontiac Grand Prix, 64-87 Pontiac LeMans, Pontiac Grand Am, 64-77 Pontiac GTO, 73-79 Oldsmobile Omega, 77-85 Oldsmobile Delta 88, 77-84 Oldsmobile 98, 77-88 Oldsmobile Cutlass, 73-75 Buick Apollo, 76-79 Buick Skylark, 77-79 Phoenix, 73-88 Buick Regal, 77-84 Buick Electra, 77-85 Buick LeSabre, 77-78 Buick Riviera, 77-91 C-Body	2424

Pontiac • Grand Prix

CODE	IMAGE	YEAR	DESCRIPTION	BODY	FITS	ITEM#
W		63-64	Vent window weatherstrip	2DR 4DR HTP	63-64 LeSabre Wildcat Coupe Deville Starfire Grand Prix	21815
W		67-68	Quarter window u-jamb	2 DR CNV HTP	67-68 Chevy Impala Convertible 68 Caprice Sport Coupe, 67 Buick Lasabre, Wildcat Convertible, 67 Electra 2 Door Hardtop & Convertible, 68 Buick Wildcat, Electra, Lesabre 2 Door Hardtop & Convertible, 67 Cadillac Deville Convertible, 68 Cadillac Calais, Deville Hardtop & Convertible 67-68 Oldsmobile 88, Oldsmobile 98, 67-68 Pontiac Catalina, Bonneville, Executive, Grand Prix Hardtop & Convertible	2294
W		69-70-71-72	Window weatherstrip original style 8 pcs	2DR HTP	69-72 Pontiac Grand Prix 2 Door Hardtop	6491
W		73-74-75-76-77	Window weatherstrip outers only replacement style	2DR HTP	73-77 Pontiac Grand Prix, 2 Door Hardtop	6483
W		80-81-82-83-84- 85-86-87-88	Window weatherstrip, original style with round bead	2DR HTP	80-88 Chevrolet Monte Carlo SS, 80-86 Pontiac Grand Prix With Special Moldings 2 Door Hardtop	5135
W		80-81-82-83-84- 85-86-87-88	Window weatherstrip replacement style	2DR HTP	80-88 Chevrolet Monte Carlo Ls 80-87 Pontiac Grand Prix Without Special Moldings, 2 Door Hardtop	5140
Z		78-79-80-81-82- 83-84-85-86-87-88	Weatherstrip kit, includes door weatherstrip, roofrail weatherstrip, trunk weatherstrip	2DR HTP	78-88 Chevrolet Monte Carlo, Buick Regal, Oldsmobile Cutlass, Pontiac Grand Prix, 2 Door Hardtop	KIT539X
Z		78-79-80-81-82- 83-84-85-86-87-88	Weatherstrip kit, includes door weatherstrip, roofrail weatherstrip, trunk weatherstrip	2DR HTP	78-88 Chevrolet Monte Carlo, Buick Regal, Oldsmobile Cutlass, Pontiac Grand Prix, 2 Door Hardtop	KIT539X



GUIDE TO SOFFSEAL'S PRODUCT CODES

















B = Bumper sets **C** = Glass channels **D** = Door related **G** = Seals, gaskets **H** = Under hood items **I** = Interior parts
M = Miscellaneous items **R** = Roofrail, pillar post & convertible items **T** = Trunk related **W** = Window related **Z** = Weatherstrip kits

Pontiac • Grand Safari, Safari



CODE	IMAGE	YEAR	DESCRIPTION	BODY	FITS	ITEM#
B		39-40-41-42-43-44-45-46-47-48-49-50-51-52-53-54-57-64-65-66-67-68-69-70-71-72	Brake clutch pedal bumpers	2DR 4DR HTP 2DR SDN CNV SWG	39-54 And 57 Chevrolet, 55-57 Pontiac, 64-72 Chevrolet	1058
B		41-42-43-44-45-46-47-48-49-50-51-52-53-54-55-56-57	Firewall/cowl bumper, 41-48 top of firewall, 41-54 side cowl	ALL BODY STYLES	41-57 Chevrolet	0457
B		47-48-49-50-51-52-53-54-55-56-57-58-59-60-61-62-63-64-65-66-67-68-69-70-71-72-73-74-75-76-77-78-79-80-81-82-83-84-85-86-87	Glove box door bumpers	2DR 4DR HTP 2DR SDN CNV SWG TRK	All Chevrolet, Pontiac, Oldsmobile, Buick 47-87 Chevrolet, Gmc Truck	1069
B		49-50-51-52-53-54-55-56-57	Door bumpers screw in upper	2DR SDN SWG	49-57 Chevrolet 150 210 Bel Air Styleline Fleetline, Pontiac Sedan, Plus Universal Applications	1054
B		51-52-53-54-55-56-57-58	Upper vent window bumpers	2DR 4DR HTP 2DR SDN CNV SWG	51-58 Chevrolet 150 210 Bel Air Nomad Del Ray Biscayne Impala, 51-54 Chevrolet, Pontiac, Oldsmobile, Buick, Cadillac, Hardtop Convertible	1224
B		55	Hood adjustment bumpers front & rear	2DR 4DR HTP 2DR SDN CNV SWG	55 Chevrolet 150 210 Bel Air Nomad, Pontiac	1072
B		55	Hood to fender bumpers 6 piece	2DR 4DR HTP 2DR SDN CNV SWG	55 Chevrolet 150 210 Bel Air Nomad	1073
B		55-56	Seat back rest bumper	2DR 4DR HTP 2DR SDN CNV SWG	55-56 Chevrolet 150 210 Bel Air Nomad, Pontiac, Safari	1059
B		55-56	Brake clutch pedal bumper	2DR 4DR HTP 2DR SDN CNV SWG	55-56 Chevrolet 150 210 Bel Air, Pontiac, Olds	1057
B		55-56-57	Door bumpers	4DR SWG	55-57 Chevrolet 150 210 Bel Air, Pontiac, Oldsmobile, All Station Wagons, 4 Door Sedan Station Wagon	10541
B		55-56-57	Door upper bumpers push in	2DR 4DR SDN	55-57 Chevrolet 150 210 Bel Air, Pontiac, Oldsmobile, Sedan	10542
B		55-56-57	Trunk bumpers	2DR 4DR HTP 2DR SDN CNV	55-57 Chevrolet 150 210 Bel Air, Pontiac	1052
B		55-56-57	Body bumper kit	2DR HTP CNV	55-57 Chevrolet 210 Bel Air, 2 Door Hardtop Convertible	1055
B		55-56-57	Body bumper kit	2DR SDN	55-57 Chevrolet 150 210 Bel Air, Pontiac, 2 Door, Sedan	1056
B		55-56-57	Tailgate liftgate bumpers	SWG	55-57 Chevrolet 150 210 Bel Air, Pontiac, Station Wagon	1227

Pontiac • Grand Safari, Safari

CODE	IMAGE	YEAR	DESCRIPTION	BODY	FITS	ITEM#
B		55-56-57	Tailgate bumpers	SWG	55-57 Chevrolet Nomad, Pontiac Safari	1229
B		55-56-57	Quarter window bumpers	CNV	55-57 Chevrolet Bel Air, Convertible	1221
B		55-56-57	Clutch pedal rebound bumper	2DR SDN 2DR 4DR HTP CNV SWG	55-57 Chevrolet, Pontiac	1096
B		55-56-57-58	Door bumpers	2DR 4DR HTP 2DR SDN CNV SWG	55-58 Chevrolet, Pontiac, Olds	1053
B		55-56-57-58-59	Upper trunk or rear license plate bumper	2DR 4DR HTP 2DR SDN CNV SWG	55-59 Chevrolet 150 210 Bel Air Nomad, Pontiac, Olds	10521
B		56-57	Door bumpers	4DR HTP	56-57 Chevrolet 210 Bel Air, Pontiac, Oldsmobile, 4 Door Hardtop	10543
B		56-57	Hood to fender bumpers	2DR 4DR HTP 2DR SDN CNV SWG	56-57 Chevrolet 150 210 Bel Air Nomad	1223
B		56-57-58-59-60-61-62-63-64-65-66-67-68-69-70-71-72-73-74	Hood adjustment bumpers round	2DR 4DR HTP 2DR SDN CNV SWG	56-74 Chevrolet, Pontiac, All Models	1222
B		57	Seat back rest bumpers	2DR 4DR HTP 2DR SDN CNV SWG	57 Chevrolet 150 210 Bel Air Nomad, Pontiac, Safari, Oldsmobile	1061
C		55	Rear glass channel	2DR 4DR SDN	55 Chevrolet 210 Bel Air, Pontiac 2 Door 4 Door Sedan	1203
C		55-56-57	Back glass gasket	SWG	55-57 Chevrolet Nomad Pontiac Safari, Station Wagon	1203C
C		55-56-57	Front glass channel	2DR 4DR HTP 2DR SDN CNV SWG	55-57 Chevrolet, Pontiac Safari, Except 55, 150 Convertible	1201
C		55-56-57	Glass channel rear side window curved 4 door station wagon	SWG 4DR	55-57 Chevrolet, Pontiac, 4 Door Station Wagon	1120
C		55-56-57	Glass channel rear side window curved	2DR SWG	55-57 Chevrolet, Pontiac, Except Nomad And Safari, 2 Door Station Wagon	1121
C		59-60	Rear quarter stationary vent window seal	SWG 2DR 4DR	59-60 Chevrolet Nomad, Brookwood, Kingswood, Buick LeSabre, Invicta, Oldsmobile Fiesta 88, Pontiac Catalina, Bonneville, Safari 2 Door 4 Door Station Wagon	2218
D		55-56-57	Upper gate auxiliary seal	SWG	55-57 Chevrolet Nomad, Pontiac Safari	1065



GUIDE TO SOFFSEAL'S PRODUCT CODES

B = Bumper sets **C** = Glass channels **D** = Door related **G** = Seals, gaskets **H** = Under hood items **I** = Interior parts
M = Miscellaneous items **R** = Roofrail, pillar post & convertible items **T** = Trunk related **W** = Window related **Z** = Weatherstrip kits

Pontiac • Grand Safari, Safari



CODE	IMAGE	YEAR	DESCRIPTION	BODY	FITS	ITEM#
D		55-56-57	Door j weatherstrip with clips	2DR 4DR HTP 2DR SDN CNV SWG	55-57 Chevrolet, Pontiac, All Models	1204
D		55-56-57	Upper gate weatherstrip with clips & molded ends	SWG	55-57 Chevrolet 150 210 Bel Air, Pontiac, Station Wagon	1228
D		55-56-57	Lower gate weatherstrip with clips & molded corner	SWG	55-57 Chevrolet Nomad, Pontiac Safari	1225
D		55-56-57	Upper gate weatherstrip	SWG	55-57 Chevrolet Nomad, Pontiac Safari	1225A
D		55-56-57	Lower gate weatherstrip with clips & molded corner	SWG	55-57 Chevrolet 150 210 Bel Air, Pontiac Station Wagon	1226
D		55-56-57	Door weatherstrip with clips & molded ends	2DR HTP CNV	55-57 Chevrolet, Pontiac, 2 Door Hardtop Convertible	1000
D		55-56-57	Door weatherstrip with clips with out molded ends	2DR HTP CNV	55-57 Chevrolet, Pontiac, 2 Door Hardtop Convertible	1001
D		55-56-57	Door weatherstrip with clips and molded ends	SWG	55-57 Chevrolet Nomad, Pontiac Safari	1002
D		55-56-57-58-59-60	Door weatherstrip with clips sedan front and rear	2DR 4DR SDN SWG	55-60 Chevrolet Bel Air 150 210, Nomad, Pontiac Chieftain, Star Chief, Safari, Super Chief, Bonneville, Buick Century, Roadmaster, Special Also Station Wagon And Sedan Delivery	1003
D		55-56-57-58-59-60	Door weatherstrip rear with clips	SWG	55-57 Chevrolet Bel Air 150 210 55-56 Pontiac Chieftain 860 870, Star Chief, 58-60 Chevrolet Sedan Delivery	1230
D		56-57	Rear door weatherstrip with clips & molded ends	4DR HTP	56-57 Chevrolet 210 Bel Air, Pontiac, 4 Door Hardtop	1004
D		56-57	Front door weatherstrip with clips & molded ends	4DR HTP	56-57 Chevrolet 210 Bel Air, Pontiac, 4 Door Hardtop	1005
D		71-72-73-74	Door weatherstrip rear with clips & molded ends	4DR SDN	71-74 Chevrolet Impala, Bel Air, Biscayne, Brookwood, Townsman, Kingswood, Buick Estate Station Wagon, Pontiac Catalina, Grand Safari, Bonneville, Oldsmobile Custom Cruiser, 4 Door Sedan	2225
D		71-72-73-74-75-76	Door weatherstrip rear with clips & molded ends	SWG 4DR	71-76 Chevrolet Bel Air, Caprice, Impala, Brookwood, Townsman, Kingswood, Oldsmobile Custom Cruiser, Pontiac Grand Safari, Buick Estate Wagon, 4 Door Station Wagon	2227
D		71-72-73-74-75-76	Door weatherstrip front with clips & molded ends	SWG	71-76 Chevrolet Impala, Bel Air, Biscayne, Brookwood, Townsman, Kingswood, Buick Estate Station Wagon, Pontiac Catalina, Grand Safari, Bonneville, Oldsmobile Custom Cruiser, 4 Door Station Wagon	2228

Pontiac • Grand Safari, Safari

CODE	IMAGE	YEAR	DESCRIPTION	BODY	FITS	ITEM#
D		75-76	Door weatherstrip rear with clips & molded ends	4DR SDN	75-76 Chevrolet Impala, Bel Air, Brookwood, Townsman, Kingwood, Buick Estate Station Wagon, Pontiac Catalina, Grand Safari, Bonneville, Oldsmobile Custom Cruiser, 4 Door Sedan	2226
D		77-78-79-80-81-82-83-84-85-86-87-88-89-90	Rear door weatherstrip with clips	4 DR SWG, RWD	77-86 Chevrolet Impala Caprice, 87-88 Caprice Caprice Classic, Cadillac, 77-85 Oldsmobile Custom Cruiser, 77-88 Estate Station Wagon, 77-81 Catalina Safari Bonneville Safari, 82 Bonneville Safari, 83 Bonneville Parisienne, 84-89 Parisienne Station Wagon, RWD Only	2503
D		82-83-84-85-86-87-88-89-90-91-92	Door weatherstrip front/rear	All	82-89 Skyhawk 92-97 Skylark 82-88 Cimarron 93-96 Fleetwood 82-94 Beretta 82-94 Cavalier 91-96 Caprice 82-96 Corsica 82-94 Lumina 82-93 S10 83-94 S10 Blazer 82-05 Chev Van 83-94 GMC Jimmy 82-93 GMC Sonoma 82-05 GMC Van 82-94 Achieva 82-85 Custom Cruiser 82-94 Firenza 82-94 Grand Am 82-94 Sunbird	9110
G		49-50-51-52-53-54-55-56	Door jam switch gasket	2DR 4DR HTP 2DR SDN CNV SWG	49-56 Chevrolet 150 210 Bel Air Nomad, Pontiac Safari, Oldsmobile	1060
G		55-56	Steering column seal standard inner	2DR 4DR HTP 2DR SDN CNV SWG	55-56 Chevrolet 150 210 Nomad Bel Air, Pontiac	1215
G		55-56	Steering column seal auto inner	2DR 4DR HTP 2DR SDN CNV SWG	55-56 Chevrolet 150 210 Nomad Bel Air, Pontiac	1214
G		55-56-57	Steering column seal auto sponge	2DR 4DR HTP 2DR SDN CNV SWG	55-57 Chevrolet 150 210 Nomad Bel Air, Pontiac	1213
G		55-56-57	Chevy Steering Column Firewall Seal, Standard Transmission	2DR 4DR HTP 2DR SDN CNV SWG	55-57 Chevrolet 150 210 Nomad Bel Air, Pontiac	1216
G		57	Steering column seal standard inner	2DR 4DR HTP 2DR SDN CNV SWG	57 Chevrolet 150 210 Nomad Bel Air, Pontiac	1215A
G		57	Steering column seal auto inner	2DR 4DR HTP 2DR SDN CNV SWG	57 Chevrolet 150 210 Nomad Bel Air, Pontiac	1214A
H		55-56	Hood to cowl seal clips	2DR 4DR HTP 2DR SDN CNV SWG	55-56 Chevrolet 150 210 Bel Air Nomad, Pontiac Safari, Oldsmobile, Chevrolet, Gmc Truck	1081
H		55-56-57	Firewall grommet	2DR 4DR HTP 2DR SDN SWG CNV	55-57 Chevrolet All, Pontiac, Olds	1026



GUIDE TO SOFFSEAL'S PRODUCT CODES











B = Bumper sets **C** = Glass channels **D** = Door related **G** = Seals, gaskets **H** = Under hood items **I** = Interior parts
M = Miscellaneous items **R** = Roofrail, pillar post & convertible items **T** = Trunk related **W** = Window related **Z** = Weatherstrip kits

Pontiac • Grand Safari, Safari



CODE	IMAGE	YEAR	DESCRIPTION	BODY	FITS	ITEM#
H		55-56-57-58-59	Hood to cowl seal	2DR 4DR HTP 2DR SDN SWG CNV TRK	55-56 Chevrolet, Pontiac, Oldsmobile, 55-59 Chevrolet, Gmc Truck	1080
H		56	A-arm seals with cloth backing	2DR 4DR HTP 2DR SDN CNV SWG	56 Chevrolet 150 210 Bel Air Nomad	1082
H		56-57-58-59-60	Firewall grommet main wiring harness	2DR 4DR HTP 2DR SDN 2DR SDN SWG CNV	56-60 Chevrolet, Pontiac, Olds	1027
H		57	A-arm seals with staples	2DR 4DR HTP 2DR SDN CNV SWG	57 Chevrolet 150 210 Bel Air Nomad	1084
H		57	Hood to cowl seal	2DR 4DR HTP 2DR SDN CNV SWG	57 Chevrolet 150 210 Bel Air	1101
H		57	Hood to cowl seal clips & screws	2DR 4DR HTP 2DR SDN CNV SWG	57 Chevrolet 150 210 Bel Air	1102
H		71-72-73-74-75-76-77-78	Hood to cowl seal	2DR SDN 2DR HTP CNV SWG	71-78 Chevrolet Impala, Caprice, Biscayne, Bel Air, Brookwood, Townsmen, Kingswood, Buick Lesabre, Centurion, Electra 225, Estate Wagon, Cadillac Calais, Deville, Eldorado, Sixty Special Brougham, Oldsmobile 88, 98, Tornado, Pontiac Catalina, Bonneville, Grandville, Safari Full Size	2191
M		55-56-57	Body to frame mounts	2DR SDN SWG	55-57 Chevrolet 2 Door 4 Door Sedan, Nomad, Pontiac Safari, Oldsmobile	1206
M		55-56-57	Accelerator pedal	2DR 4DR HTP SDN CNV SWG	55-57 Chevrolet 150 210 Bel Air No- mad, Pontiac, 55-57 Corvette, 2 Door 4 Door Hardtop Sedan Convertible Station Wagon	1050
R		55-56-57	Roofrail weatherstrips	SWG	55-57 Chevrolet Nomad, Pontiac Safari Station Wagon	1035
R		55-56-57	Header seal	CNV	55-57 Chevrolet Bel Air, Pontiac Convertible	1031
R		55-56-57-58	Windshield Pillar post seals with clips	2DR HTP CNV SWG	55-58 Chevrolet, Nomad, Pontiac Safari, Hardtop Convertible	1231
R		56-57	Roofrail weatherstrip	4DR HTP	56-57 Chevrolet 210 Bel Air, Pontiac, 4 Door Hardtop	1028
T		55-56	Trunk weatherstrip	2DR 4DR HTP 2DR SDN CNV	55-56 Chevrolet 150, Chevrolet 210, Chevrolet Bel Air, Chevrolet Nomad, Oldsmobile 98, Pontiac Chieftan, Pon- tiac 860, Pontiac 870, Pontiac Super Chief, Pontiac Bonneville, Pontiac Star Chief, Pontiac Safari	6012

Pontiac • Grand Safari, Safari

CODE	IMAGE	YEAR	DESCRIPTION	BODY	FITS	ITEM#
T		55-56-57	Trunk mat	2DR 4DR HTP 2DR SDN 4DR SDN	55-57 Chevrolet 150 210 Bel Air, Pontiac, Hardtop Sedan	1217
T		55-56-57	Trunk mat	CNV	55-57 Chevrolet Bel Air, Pontiac, Convertible	1217A
T		55-56-57	Trunk area access plugs	2DR 4DR HTP 2DR SDN CNV	55-57 Chevrolet 150 210 Bel Air, Pontiac	1218
T		55-56-57	Spare tire well plugs	2DR 4DR HTP 2DR SDN CNV	55-57 Chevrolet 150 210 Bel Air, Pontiac Chieftain, Starchief, Super Chief, Oldsmobile	1219
T		57	Trunk weatherstrip with clips	2DR 4DR HTP 2DR SDN CNV	57 Chevrolet, Pontiac Except Star Chief	1011
W		37-38-39-40-41-42-43-44-45-46-47-48-49-50-51-52-53-54	Mohair channel liner, 4 feet of 2 7/8 inch mohair lining material	CNV 2DR 4DR HTP	Bel Air 150 210, Nomad, Chieftain, 860/870 Star Chief, Safari, Super Chief, Bonneville, Nova, Omega, Apollo, Ventura, Skylark	0420
W		55-56-57	Window weatherstrip with division bar & window channel replacement style	SWG	55-57 Chevrolet Nomad, Pontiac Safari, Station Wagon	1047
W		55-56-57	Cozy vent seals	2DR 4DR HTP CNV	55-57 Chevrolet All, Nomad, Pontiac All, Safari, 2 Door 4 Door Hardtop Convertible	1032
W		55-56-57	Cozy vent seals	2DR SDN 4DR SDN SWG	55-57 Chevrolet, Pontiac, 2 Door And 4 Door Sedan And Station Wagon Except Nomad And Safari	1033
W		55-56-57	Glass setting channel, doors only	2DR HTP 2DR SDN	55-57 Chevrolet, Pontiac Safari, Oldsmobile, 2 Door Hardtop	1211
W		55-56-57	Vertical seal side sliding window	SWG	55-57 Chevrolet Nomad, Pontiac Safari, Station Wagon	1125







GUIDE TO SOFFSEAL'S PRODUCT CODES

B = Bumper sets **C** = Glass channels **D** = Door related **G** = Seals, gaskets **H** = Under hood items **I** = Interior parts
M = Miscellaneous items **R** = Roofrail, pillar post & convertible items **T** = Trunk related **W** = Window related **Z** = Weatherstrip kits



CODE	IMAGE	YEAR	DESCRIPTION	BODY	FITS	ITEM#
D		71-72-73-74-75-76	Door weatherstrip with clips & molded ends	2DR HTP CNV	71-76 Chevrolet Impala, Caprice, Cadillac Calais, Deville, Buick 71-73 LeSabre, Centurion, Electra, 74-76 LeSabre, Electra, Oldsmobile 88 Oldsmobile 98, Pontiac Bonneville, Catalina, 71-75 Grandville 2 Door Hardtop Convertible	2512
H		71-72-73-74-75-76-77-78	Hood to cowl seal	2DR SDN 2DR HTP CNV SWG	71-78 Chevrolet Impala, Caprice, Biscayne, Bel Air, Brookwood, Townsman, Kingswood, Buick Lesabre, Centurion, Electra 225, Estate Wagon, Cadillac Calais, Deville, Eldorado, Sixty Special Brougham, Oldsmobile 88, 98, Tornado, Pontiac Catalina, Bonneville, Grandville, Safari Full Size	2191
R		71-72-73-74-75	Roofrail weatherstrip	2DR HTP	71-73 Impala Custom Coupe Caprice, 74-75 Impala Sport Coupe, 71-76 Cadillac Calais Deville, 71-74 Electra, 74-76 LeSabre, 71-71 98, 74 Oldsmobile 98 Oldsmobile Delta 88, 75-76 Oldsmobile Delta 88, 71-73 Grandville, 74 Bonneville Catalina Grandville, 75-76 Catalina, 2 Door Hardtop	2509
R		71-72-73-74-75-76	Weatherstrip kit for convertible top	CNV	71-72 Chevrolet Impala, 73-76 Caprice, 71-76 Cadillac Eldorado, 71-75 Oldsmobile Delta 88, 71,72, 74 Buick LeSabre 71-73 Centurion, 71-72 Pontiac Catalina, 71-75 Grandville Convertible	2508
R		71-72-73-74-75-76	Pillar post weatherstrip with molded ends	CNV	71-75 Chevrolet Impala, Caprice 71-72 Oldsmobile 88, 71-75 Pontiac Catalina, Grandville, 71-75 Buick Lesabre, Centurion 71-76 Cadillac Eldorado, Convertible	2094
R		71-72-73-74-75-76	Header seal	CNV	71-75 Chevrolet Impala, Caprice, 71-72 Oldsmobile 88, 71-75 Pontiac Catalina, Grandville, 71-75 Buick Lesabre, Centurion, 71-76 Cadillac Eldorado, Convertible	2515
T		64-65-66-67-68-69-70-71-72-73-74-75-76-77	Trunk weatherstrip exact profile length 17 feet	2DR 4DR HTP 2DR SDN CNV	65-72 Chevy II, 65-72 Chevrolet Biscayne, 65-75 Chevrolet Bel Air, 65-76 Chevrolet Impala, 65-76 Chevrolet Caprice, 64-77 Chevrolet Chevelle, 70-77 Chevrolet Monte Carlo, 65-76 Buick LeSabre, 64-77 Buick Wildcat, 64-77 Buick Skylark, 71-73 Buick Centurion, 64-72 Buick Grand Special, 73-77 Buick Century, 73-88 Buick Regal, 73-88 Buick Grand National, 65-76 Buick Electra, 65-76 Oldsmobile Delta 88, 67-69 Oldsmobile Delmont 88, 65-66 Oldsmobile Dynamic 88, 65-66 Oldsmobile Starfire, 65 Oldsmobile Jetstar, 64-77 Oldsmobile Cutlass 442, 64-88 Oldsmobile Cutlass, 65-76 Oldsmobile 98, 65-76 Pontiac Parisienne, 64-72 Pontiac LeMans, 65-70 Pontiac Catalina, 65-66 Pontiac Star Chief, 67-70 Pontiac Executive, 71-75 Pontiac Grand Ville, 65-77 Pontiac Grand Prix, 64-72 Pontiac Tempest, 62-72 Nova, Ventura, 73-74 Non-Hatchback, Up to 1975 with groove channel, Apollo, Nova, Omega, Ventura 65-76 C-Body	2003

Pontiac • Grand Ville

CODE	IMAGE	YEAR	DESCRIPTION	BODY	FITS	ITEM#
W		71-72-73	Qtr window u jamb	2DR HTP CNV	71-73 Buick LeSabre, Electra, Riviera, Chevrolet Impala, Caprice, Cadillac Calais, Deville, Oldsmobile 88 Oldsmobile 98, Pontiac Catalina, Bonneville, Grandville 2 Door Hardtop Convertible	2600
W		71-72-73-74-75-76	Quarter window seals	2DR HTP CNV	71-75 Chevrolet Impala, Caprice, 71-76 Cadillac Eldorado Convertible Only, 71-76 Oldsmobile 88, 76 Oldsmobile 98, 71-73 Buick LeSabre, 71-73 Centurion, 71-75 Pontiac Catalina, Bonneville, Grandville 2 Door Hardtop Convertible	2308
W		71-72-73-74-75-76	Quarter window seals	4DR HTP	71-75 Chevrolet Impala, Caprice, Cadillac Calais, Deville, Pontiac Catalina, Bonneville, Grandville Buick Lesabre, Electra, Oldsmobile 88, 98, 4 Door Hardtop	2309
W		74-75-76	Quarter window u-jamb	2DR HTP CNV	Impala Caprice LeSabre Electra Eldorado Oldsmobile Delta 88 Oldsmobile 98, Tornado Delta Bonneville Catalina Grandville Catalina	2295



GUIDE TO SOFFSEAL'S PRODUCT CODES

B = Bumper sets **C** = Glass channels **D** = Door related **G** = Seals, gaskets **H** = Under hood items **I** = Interior parts
M = Miscellaneous items **R** = Roofrail, pillar post & convertible items **T** = Trunk related **W** = Window related **Z** = Weatherstrip kits

Pontiac • LeMans, GTO, Tempest



CODE	IMAGE	YEAR	DESCRIPTION	BODY	FITS	ITEM#
B		47-48-49-50-51-52-53-54-55-56-57-58-59-60-61-62-63-64-65-66-67-68-69-70-71-72-73-74-75-76-77-78-79-80-81-82-83-84-85-86-87	Glove box door bumpers	2DR 4DR HTP 2DR SDN CNV SWG TRK	All Chevrolet, Pontiac, Oldsmobile, Buick 47-87 Chevrolet, Gmc Truck	1069
B		59-60-61-62-63-64-65-66-67	Door bumpers	2DR HTP 2DR SDN 2DR SDN CNV SWG	59-67 Chevrolet, Pontiac, Oldsmobile, Buick, Cadillac, 62-67 Chevy II, Nova, 66-67 Chevrolet Chevelle, Oldsmobile Cutlass, Buick Skylark, Pontiac Tempest, LeMans, GTO	2320
B		62-63-64-65-66-67-68-69-70-71-72-73-74-75	Trunk bumpers	2DR HTP 2DR SDN CNV	70-75 Chevrolet Camaro, Pontiac Firebird, 62-73 Chevy II Nova, 64-72, Pontiac GTO, Tempest, Le Mans, Chevrolet Chevelle, Monte Carlo, Buick Skylark, Oldsmobile Cutlass, 65-69 Chevrolet Corvair, 65-70 Full Size Chevrolet	3112
B		64-65	Bumper kit, doors, trunk, glove box, hood side, hood adjustment	2DR SDN 2DR HTP CNV	64-65 Pontiac LeMans, GTO	6023
B		64-65-66	Door bumpers	2DR 4DR HTP 2DR SDN CNV SWG	64-66 Chevrolet Chevelle, El Camino, Nova, Pontiac GTO, Tempest, LeMans, Buick Skylark, Oldsmobile Cutlass	5080
B		64-65-66-67	Hood to fender bumpers 4 per car	2DR SDN 2DR 4DR HTP CNV	64-67 Pontiac GTO, LeMans, Tempest	6470
B		64-65-66-67-68-69-70-71-72	Hood adjustment bumper Tin x 1 3/4 in long x 5/16 bolt	2DR SDN 2DR 4DR HTP CNV SWG	64-66 Pontiac Tempest, LeMans, GTO, Buick Skylark, Oldsmobile Cutlass	6022
B		64-65-66-67-68-69-70-71-72	Seat back bumpers bench round 4 per car	2DR SDN 2DR 4DR HTP CNV	64-72 Pontiac LeMans, Tempest, GTO	6460
B		65-66-67-68-69-70-71-72-73-74-75-76-77-78-79-80-81-82-83-84-85-86-87-88-89-90-91-92-93-94-95-96-97-98-99-00-01-02	Door bumpers	2DR 4DR HTP 2DR SDN SWG CNV	65-66 Chevrolet, Pontiac, Oldsmobile, Buick, 65-69 Corvair, 70-02 Chevrolet Camaro, Pontiac Firebird, 68-81 Chevelle, GTO, Cutlass, Skylark, 68-72 El Camino, Tempest, LeMans GTO, 70-72 Monte Carlo	2321
B		66-67	Bumpers bucket seat back oval 4 per car	2DR HTP CNV 2DR SDN	66-67 Chevrolet Chevelle, El Camino, Nova, Pontiac GTO, Tempest, LeMans, Grand Prix	5085
B		66-67	Bumper kit, door trunk glove box hoodside hood adjustment	2DR SDN 2DR HTP CNV	66-67 Pontiac LeMans, GTO	6024
B		66-67-68-69-70-71-72-73	Hood adjustment bumper	2DR SDN 2DR HTP CNV	66-73 Pontiac	6445
B		68-69	Bumper kit, doors, trunk, glove box, hoodside adj	ALL BODY STYLES	68-69 Pontiac LeMans, GTO, Tempest	6025

Pontiac • LeMans, GTO, Tempest

CODE	IMAGE	YEAR	DESCRIPTION	BODY	FITS	ITEM#
B		68-69	Hood bumpers 4 per car	2DR HTP CNV	68-69 Pontiac GTO, LeMans, Tempest	6446
B		68-69-70-71-72-73-74-75-76-77	Hood to cowl bumper	2DR SDN 2DR 4DR HTP CNV SWG	68-72 Pontiac GTO, LeMans, 73-77 Chevrolet Monte Carlo, Chevelle	6472
B		69	License panel bumpers rear	2DR 4DR SDN HTP CNV	69 Chevrolet Camaro, Pontiac Firebird, 64-72 Chevrolet Chevelle, Pontiac Tempest, LeMans, GTO, Grand Prix, Oldsmobile Cutlass, Buick Special, Skylark	31151
B		70	Hood bumpers 4 per car	2DR SDN 2DR 4DR HTP CNV	70 Pontiac Grand Prix, GTO, LeMans	6447
B		70	Bumper kit, doors, trunk, glove box, hoodside adj, hood to cowl	ALL BODY STYLES	70 Pontiac LeMans, GTO	6026
B		71-72	Bumper kit, doors, trunk, glove box hoodside hood adj hood to cowl	ALL BODY STYLES	71-72 Pontiac LeMans, GTO	6027
B		71-72	Hood to fender bumpers 4 per car	2DR SDN 2DR 4DR HTP CNV	71-72 Pontiac Grand Prix, GTO, LeMans	6473
D		64-65	Door weatherstrip with clips & molded ends	2DR HTP CNV	64-65 Chevrolet Chevelle, Pontiac GTO, LeMans, Oldsmobile Cutlass, Buick Skylark 2 Door Hardtop And Convertible	5004
D		64-65	Door weatherstrip with clips	2DR SDN	64-65 Chevrolet Chevelle, Oldsmobile Cutlass, Buick Skylark, Pontiac Tempest, LeMans, GTO, Buick Special 2 Door Sedan	5003
D		64-65-66-67	Door weatherstrip rear door with clips	4DR SDN WGN	64-67 Chevelle, LeMans, Skylark, Cutlass, Except Sport Station Wagon And Vista Cruiser, 4 Door Sedan Station Wagon	5001A
D		64-65-66-67	Door weatherstrip front door with clips	4DR SDN WGN	64-67 Chevrolet Chevelle, Pontiac LeMans, Oldsmobile Cutlass, 4 Door Sedan Wagon	5001
D		64-65-66-67	Tailgate weatherstrip	SWG	64-67 Chevrolet Chevelle, Buick Special, Oldsmobile Vista Cruiser, F85, Pontiac, Station Wagon	5142
D		66-67	Door weatherstrip with clips	2DR SDN	66-67 Chevrolet Chevelle, Pontiac Tempest, LeMans, GTO, Oldsmobile Cutlass, 442, Buick Special, Skylark 2 Door Sedan	5000
D		66-67	Door weatherstrip with clips & molded ends	2DR HTP CNV	66-67 Pontiac GTO, LeMans, Oldsmobile Cutlass, Buick Skylark, Hardtop Convertible	6407
D		68	Door weatherstrip with clips & molded ends	2DR HTP CNV	68 Pontiac GTO, LeMans Hardtop Convertible	6413
D		68-69-70-71-72	Door weatherstrip front door with clips	4DR SWG	68-72 Chevrolet Chevelle, Pontiac LeMans, Buick Skylark, 68-72 Oldsmobile Cutlass 4 Door Station Wagon	5020



















GUIDE TO SOFFSEAL'S PRODUCT CODES						
B = Bumper sets	C = Glass channels	D = Door related	G = Seals, gaskets	H = Under hood items	I = Interior parts	
M = Miscellaneous items	R = Roofrail, pillar post & convertible items		T = Trunk related	W = Window related	Z = Weatherstrip kits	

Pontiac • LeMans, GTO, Tempest



CODE	IMAGE	YEAR	DESCRIPTION	BODY	FITS	ITEM#
D		68-69-70-72-72	Door weatherstrip rear door with clips	4DR SDN SWG	68-72 Chevrolet Chevelle, Pontiac LeMans, Buick Skylark, Oldsmobile Cutlass 4 Door Sedan And Station Wagon Except Sport Station Wagon And Vista Cruiser	5020A
D		68-69-70-71-72	Door weatherstrip with clips	2DR SDN	68-72 Chevelle, Pontiac Tempest, LeMans, GTO, Oldsmobile Cutlass 442, Buick Special, Buick Skylark, 2 Door Sedan	5002
D		69-70-71-72	Door weatherstrip with clips & molded ends	2DR HTP CNV	69-72 Pontiac GTO, LeMans Hardtop Convertible	6410
D		73-74-75-76-77	Door weatherstrip with clips & molded ends	2DR HTP	Grand Am 2 Door 73-77 Chevrolet, LeMans, Grand LeMans, Century, Regal, Cutlass, Chevelle Malibu Laguna, El Camino, 2 Door Hardtop	5017
D		78-79-80-81-82-83-84-85-86-87	Door weatherstrip rear door with clips	4DR SDN	78-87 Chevrolet Malibu, Buick Regal, Oldsmobile Cutlass, Pontiac LeMans, 4 Door Sedan	5037
D		78-79-80-81-82-83-84-85-86-87	Door weatherstrip rear door with clips	SWG	78-87 Chevrolet Malibu, Buick Regal, Oldsmobile Cutlass, Pontiac LeMans, Station Wagon	5038
D		78-79-80-81-82-83-84-85-86-87-88	Door weatherstrip a-body with clips & molded ends	2DR HTP	78-88 Chevrolet Malibu, El Camino, Monte Carlo, Oldsmobile Cutlass, Buick Regal, Pontiac LeMans, Grand Prix 2 Door, Replacement Part For Buick, Oldsmobile And Pontiac, 82-88 Is A G Body	5025
D		78-79-80-81-82-83-84-85-87	Door weatherstrip front door with clips	4DR SDN	78-87 Chevrolet Malibu, Buick Regal, Oldsmobile Cutlass, Pontiac LeMans, 4 Door Sedan	5036
G		64	Window weatherstrip replacement style	2DR HTP	64 Pontiac GTO, LeMans, 2 Door Hardtop	6481
G		64-65-66-67	Steering column sponge seal	2DR SDN CNV 2DR 4DR HTP SWG	64-67 Chevrolet Chevelle, El Camino, Pontiac LeMans, GTO, Oldsmobile Cutlass, Buick Skylark	5162
G		64-65-66-67	Cowl vent gaskets	2DR 4DR HTP 2DR SDN CNV	64-67 Buick Skylark, Oldsmobile Cutlass, Pontiac GTO, Chevrolet Chevelle	5073
G		64-65-66-67-68	Mirror gasket standard	ALL BODY STYLES	64-68 Pontiac GTO, LeMans	6468
G		65	Headlight, bezel seal	2DR SDN 2DR HTP CNV	65 Pontiac GTO, LeMans	6462
G		65	Tempest taillight, gasket	2DR HTP 2DR 4DR HTP CNV	65 Pontiac GTO, LeMans	6839
G		66-67-68-69-70-71-72	Door handle & lock gaskets set	2DR HTP 2DR SDN CNV	67-69 Chevrolet Camaro, Pontiac Firebird, 66-72 Chevy II Nova, 64-72 Chevrolet Chevelle, Pontiac Tempest, LeMans, GTO, Buick Skylark, Oldsmobile Cutlass, 70-72 Chevrolet Monte Carlo	3021

Pontiac • LeMans, GTO, Tempest

CODE	IMAGE	YEAR	DESCRIPTION	BODY	FITS	ITEM#
G		67	Taillight to body gasket	2DR SDN 2DR 4DR HTP CNV SWG	67 Pontiac GTO, LeMans	6838
G		67	Taillight gaskets	2DR 4DR HTP CNV SDN	67 Pontiac LeMans, Tempest, Tempest Custom 2 Door 4 Door Hardtop Convertible Sedan	6498
G		68	Parklight lens gaskets	2DR SDN 2DR 4DR HTP CNV	68 Pontiac Firebird, LeMans, GTO	6461
G		68	Rear sidemarker gaskets	2DR HTP 2DR SDN CNV	68 Pontiac GTO, 68-69 Pontiac Le Mans, Tempest	6843
G		68	Outer taillight, housing to bumper gaskets	2DR SDN 2DR HTP CNV	68 Pontiac GTO, LeMans, Tempest	6464
G		68	Taillamp housing gaskets	2DR HTP 2DR SDN CNV	68 Pontiac LeMans, GTO	6851
G		68	Taillight lens gaskets	ALL BODY STYLES	68 Pontiac GTO, LeMans, Tempest	6467
G		69	Taillamp housing gaskets	2DR HTP 2DR SDN CNV	69 Pontiac LeMans, GTO	6852
G		69	Sidemarker gaskets on quarter panel	2DR HTP CNV	69 Pontiac GTO, LeMans, Tempest	6848
G		70	Parking lamp lens gaskets	2DR HTP 2DR SDN CNV	70 Pontiac LeMans, Tempest	6842
G		70-71-72	Taillight lens gaskets	2DR HTP 2DR SDN CNV	70-72 Pontiac, LeMans, Tempest	6841
G		78-79-80-81-82- 83-84-85-86-87	Rear side marker gasket	SWG	78-87 Chevrolet El Camino, Gmc Caballero, 78-83 Chevrolet Malibu Wagon, 82-83 Pontiac Bonneville Wagon, 78-81 Pontiac LeMans Wagon, Oldsmobile Cutlass Wagon, 82-86 Oldsmobile Cutlass 4 Door Except Fwd, 78-82 Buick Century Wagon, Station Wagon	5214
H		64-65-66	Inner fender seal a-arm with staples	2DR SDN 2DR 4DR HTP CNV	64-66 Pontiac GTO, LeMans	6465
H		64-65-66-67	Hood to cowl seal	2DR 4DR HTP 2DR SDN CNV SWG	64-67 Chevrolet Chevelle, El Camino, Pontiac GTO, LeMans	5070
H		64-65-66-67-68-69	Firewall grommet, antenna lead, fits 9/16 hole	2DR SDN 2DR 4DR HTP CNV	64-69 Pontiac GTO, LeMans	6459
H		67-68-69-70-71-72	Inner fender seal a-arm with staples	2DR SDN 2DR 4DR HTP CNV	67-72 Pontiac GTO, LeMans	6466

















GUIDE TO SOFFSEAL'S PRODUCT CODES					
B = Bumper sets	C = Glass channels	D = Door related	G = Seals, gaskets	H = Under hood items	I = Interior parts
M = Miscellaneous items	R = Roofrail, pillar post & convertible items	T = Trunk related	W = Window related	Z = Weatherstrip kits	

Pontiac • LeMans, GTO, Tempest



CODE	IMAGE	YEAR	DESCRIPTION	BODY	FITS	ITEM#
H		68-69	Hood to cowl seal clip kit steel	2DR 4DR HTP 2DR SDN CNV SWG	68-69 Chevelle, El Camino, Monte Carlo, GTO, LeMans, Buick Skylark, Oldsmobile Cutlass	5075
H		68-69-70-71-72	Hood to cowl seal sponge	2DR 4DR HTP 2DR SDN CNV SWG	68-72 Chevrolet Chevelle, El Camino, Monte Carlo, Pontiac GTO, LeMans, Buick Skylark, Oldsmobile Cutlass	50741
H		68-69-70-71-72	Hood to cowl seal dense	2DR 4DR HTP 2DR SDN CNV SWG	68-72 Chevrolet Chevelle, El Camino, Monte Carlo, Pontiac GTO, LeMans, Buick Skylark, Oldsmobile Cutlass	5074
H		68-69-70-71-72	Hood to cowl seal clip kit plastic	2DR 4DR HTP 2DR SDN CNV SWG	68-72 Chevrolet Chevelle, El Camino, Monte Carlo, Pontiac GTO, LeMans, Buick Skylark, Oldsmobile Cutlass	5077
H		68-69-70-71-72	Firewall clutch boot	2DR HTP 2DR SDN CNV	68-72 Chevrolet Chevelle, El Camino, Monte Carlo, Pontiac LeMans, Tempest, GTO, Buick Skylark, Oldsmobile Cutlass	5053
H		68-69-70-71-72	Wiper motor gasket	2DR 4DR HTP CNV SDN	68-72 Pontiac GTO, LeMans, 2 Door 4 Door Sedan Hardtop Convertible	6424
H		ALL-MODELS- WHERE-APPLICABLE	Air cleaner lid seal, cut to fit	2DR 4DR HTP 2DR SDN CNV SWG	GM All	2099
I		64-65-66-67	Standard brake clutch pedal pad trim	4DR HTP CNV	64-67 Pontiac GTO	6427
I		64-65-66-67-68- 69-70-71-72	Brake pedal pad automatic trans	2DR SDN CNV 2DR 4DR HTP	69-72 Pontiac Grand Prix 64-70 Pontiac GTO, Le Mans	6423
I		64-65-66-67-68- 69-70-71-72	Brake & clutch pedal pads	2DR HTP 2DR SDN CNV SWG	64-72 Pontiac Grand Prix, GTO	6422
I		64-65-66-67-68- 69-70-71-72-73-74	Park brake pedal pad	2DR HTP CNV	El Camino Cutlass Chevelle Chevy II Camaro Firebird LeMans Tempest GTO Grand Prix Full Size Centurion Century Electra Invicta LeSabre Regal Riviera Skylark Wildcat Monte Carlo	3094
I		64-65-66-67-68- 69-70-71-72	Brake pedal pad trim automatic	2DR HTP CNV	64-72 Pontiac GTO	6426
I		65-66	Shift boot 4-speed with console	2DR SDN 2DR 4DR HTP CNV	65-66 Pontiac GTO, LeMans	6452
I		65-66-67-68-69-70	Park brake pedal pad	2DR SDN CNV 2DR 4DR HTP	65-70 Pontiac Grand Prix, GTO, LeMans	6425
I		68-69-70-71-72	Shift boot 4-speed with console	2DR HTP 2DR SDN CNV	69 Chevrolet Camaro with Console, 67 GTO without Console, 68-72 GTO with & without Console	30731
I		68-69-70-71-72	Automatic brake pad	2DR 4DR HTP 2DR SDN CNV SWG	68-72 Chevrolet Chevelle, El Camino, Monte Carlo, Buick Skylark, Oldsmobile Cutlass, 71-72 Pontiac LeMans, Tempest, GTO	5058

Pontiac • LeMans, GTO, Tempest

CODE	IMAGE	YEAR	DESCRIPTION	BODY	FITS	ITEM#
M		64-65-66-67	Firewall pad with clips	2DR SDN 4DR HTP CNV SWG	64-67 Chevrolet Chevelle, El Camino, Buick Skylark, Oldsmobile Cutlass, Pontiac GTO, LeMans	5163
M		64-65-66-67	Firewall clutch boot	2DR HTP SDN CNV	64-67 Chevrolet Chevelle, El Camino, Pontiac GTO, 2 Door Hardtop Sedan Convertible	50521
M		64-65-66-67	Body mount bolt kit	CNV	64-67 Chevrolet Chevelle, Pontiac LeMans, GTO, Convertible	51645
M		64-65-66-67	Body mounts with steel sleeves	2DR HTP	64-67 Chevrolet Chevelle, El Camino, Pontiac LeMans, GTO, 2 Door Hardtop Sedan	51642
M		64-65-66-67-68-69	Rocker panel flap plug, requires 2	2DR 4DR SDN HTP CNV	64-68 Chevrolet Chevelle, Pontiac GTO, Oldsmobile Cutlass, Buick Skylark, 67-69 Chevrolet Camaro, Pontiac Firebird, 2 Door 4 Door Sedan Hardtop Convertible	5013
M		66-67-68-69-70-71-72-73-74-75	Accelerator pedal	2DR HTP CNV SDN SWG	67-75 Chevrolet Camaro, Pontiac Firebird, 68-72 Chevrolet Corvette, Chevelle, 68-75 Chevy II Nova, 66-72 Pontiac Tempest, LeMans, GTO, 2 Door Hardtop Convertible Sedan Station Wagon	3090
M		68-69-70-71-72	Firewall insulation pad with clips with a/c	2DR SDN CNV 2DR 4DR HTP SWG	68-72 Chevrolet Chevelle, El Camino, Buick Skylark, Oldsmobile Cutlass, Pontiac GTO, LeMans, All Models	51632
M		68-69-70-71-72	Firewall insulation pad with clips non a/c	2DR SDN CNV 4DR HTP SWG	68-72 Chevrolet Chevelle, El Camino, Buick Skylark, Oldsmobile Cutlass, Pontiac GTO, LeMans	51631
M		68-69-70-71-72	Core support bushing bolt kit	2DR 4DR HTP 2DR SDN CNV SWG	68-72 Chevelle El Camino Skylark Special Gran Sport Sports Wagon 442 Cutlass F85 Vista Cruiser Wagon Tempest LeMans GTO T37 Monte Carlo Impala	5167
M		68-69-70-71-72	Cnv body mount bolt kit	CNV	68-72 Chevrolet Chevelle, Oldsmobile Cutlass, Pontiac LeMans, Buick Skylark, Convertible	51647
M		68-69-70-71-72	Body mount bolt kit	2DR HTP 2DR SDN	68-72 Chevelle, Cutlass LeMans Skylark, 2 Door 4 Door Hardtop	51646
M		68-69-70-71-72	Body mounts with steel sleeves	CNV	68-72 Pontiac LeMans, GTO, Convertible	6531
M		68-69-70-71-72	Body to frame mount kit with steel sleeves	2DR HTP	68-72 Pontiac GTO, 2 Door Hardtop Sedan	6530
M		68-69-70-71-72-73-74-75-76-77-78-79	Brake & clutch pedal pad	2DR HTP CNV SDN	67-72 Chevrolet Camaro Standard, Pontiac Firebird, 68-79 Chevrolet Corvette, 68-72 Chevrolet Nova, 64-72 Chevrolet Chevelle, 70-72 Monte Carlo 71-72 GTO, 2 Door Hardtop Convertible Sedan	3096
M		69	Door jamb louvers	2DR 4DR HTP 2DR SDN CNV SWG	69 Chevelle, El Camino, Monte Carlo, Pontiac LeMans, GTO, Tempest	5043



GUIDE TO SOFFSEAL'S PRODUCT CODES









B = Bumper sets **C** = Glass channels **D** = Door related **G** = Seals, gaskets **H** = Under hood items **I** = Interior parts
M = Miscellaneous items **R** = Roof/rail, pillar post & convertible items **T** = Trunk related **W** = Window related **Z** = Weatherstrip kits

Pontiac • LeMans, GTO, Tempest



CODE	IMAGE	YEAR	DESCRIPTION	BODY	FITS	ITEM#
P		00-99	Hood bumpers; has a width of 1.655", a height of 11/16", and an installed height of .84". It is typically used in metal applications and has a drill/slot of .14".	ALL BODY STYLES	Universal Fit And GTO	K167
R		64-65	Weatherstrip kit for convertible top	CNV	64-65 Chevrolet Chevelle, Pontiac GTO, LeMans, Oldsmobile Cutlass, 442, Buick Skylark Convertible	5090
R		64-65	Pillar post weatherstrip with molded ends	CNV	64-65 Chevrolet Chevelle, Pontiac GTO, Buick Skylark, Oldsmobile Cutlass, Convertible	5039
R		64-65	Roofrail weatherstrip with molded ends	2DR HTP	64-65 Chevrolet Chevelle, Buick Skylark, Oldsmobile Cutlass, Pontiac LeMans, GTO, 2 Door Hardtop	5005
R		64-65-66-67	Header seal with clips, without molded ends	CNV	64-67 Chevrolet Chevelle, Pontiac GTO, LeMans, Oldsmobile Cutlass, 442, Buick Skylark, Convertible	5091
R		66-67	Header seal with clips and molded ends	CNV	66-67 Chevrolet Chevelle A Body Pontiac LeMans GTO Old Cutlass 442 Buick Special Skylark Convertible	50911
R		66-67	Roofrail weatherstrip with molded ends	2DR HTP	66-67 Chevelle, Pontiac Tempest, LeMans, GTO, Oldsmobile Cutlass 442, Buick Special, Skylark, 2 Door Hardtop	5009
R		66-67	Pillar post weatherstrip with molded ends	CNV	66-67 Chevrolet Chevelle, Pontiac GTO, LeMans, Oldsmobile Cutlass, Buick Skylark Convertible	5040
R		66-67	Weatherstrip kit for convertible top	CNV	66-67 Chevrolet Chevelle, Pontiac GTO, LeMans, Oldsmobile Cutlass 442, Buick Special, Skylark, Convertible	5092
R		68	Roofrail weatherstrip with molded ends	2DR HTP	68 Chevrolet Chevelle, Pontiac LeMans, GTO, Buick Skylark, Oldsmobile Cutlass, 2 Door Hardtop	5012
R		68	Pillar post weatherstrip with molded ends	CNV	68 Chevrolet Chevelle, Pontiac GTO, LeMans, Buick Skylark, Oldsmobile Cutlass Convertible	5041
R		68-69-70-71-72	Header seal with clips and molded ends	CNV	68-72 Chevrolet Chevelle, Buick Skylark, Oldsmobile Cutlass, Pontiac LeMans, Convertible	5094
R		68-69-70-71-72	Weatherstrip kit for convertible top	CNV	68-72 Chevrolet Chevelle, Buick Skylark, Oldsmobile Cutlass, Pontiac LeMans, Convertible	5093
R		68-69-70-71-72	Conv. top Header Seal	Conv.	68-72 Chevrolet Chevelle, Pontiac LeMans, Tempest, GTO, Buick Skylark, Olds Cutlass	5054
R		69-70-71-72	Roofrail weatherstrip with molded ends	2DR HTP CNV	69-72 Chevrolet, Pontiac GTO, LeMans, Grand Prix, Buick Skylark, Oldsmobile Cutlass 442, 2 Door Hardtop	5024

Pontiac • LeMans, GTO, Tempest

CODE	IMAGE	YEAR	DESCRIPTION	BODY	FITS	ITEM#
R		69-70-71-72	Pillar post weatherstrip with molded ends	CNV	69-72 Chevrolet Chevelle, Pontiac LeMans, GTO, Buick Skylark, Oldsmobile Cutlass Convertible	5042
R		73-74-75-76-77	Roofrail weatherstrip	2DR HTP	73-77 Chevrolet Malibu, Pontiac LeMans, Grand Am, Buick Century, Oldsmobile Cutlass, 2 Door Hardtop	5035
R		78-79-80-81	Roofrail weatherstrip	2DR HTP	78-81 Chevrolet Malibu, Pontiac LeMans, 2 Door	5401
T		64-65-66-67-68-69-70-71-72-73-74-75-76-77	Trunk weatherstrip exact profile length 17 feet	2DR 4DR HTP 2DR SDN CNV	65-72 Chevy II, 65-72 Chevrolet Biscayne, 65-75 Chevrolet Bel Air, 65-76 Chevrolet Impala, 65-76 Chevrolet Caprice, 64-77 Chevrolet Chevelle, 70-77 Chevrolet Monte Carlo, 65-76 Buick LeSabre, 64-77 Buick Wildcat, 64-77 Buick Skylark, 71-73 Buick Centurion, 64-72 Buick Grand Special, 73-77 Buick Century, 73-88 Buick Regal, 73-88 Buick Grand National, 65-76 Buick Electra, 65-76 Oldsmobile Delta 88, 67-69 Oldsmobile Delmont 88, 65-66 Oldsmobile Dynamic 88, 65-66 Oldsmobile Starfire, 65 Oldsmobile Jetstar, 64-77 Oldsmobile Cutlass 442, 64-88 Oldsmobile Cutlass, 65-76 Oldsmobile 98, 65-76 Pontiac Parisienne, 64-72 Pontiac LeMans, 65-70 Pontiac Catalina, 65-66 Pontiac Star Chief, 67-70 Pontiac Executive, 71-75 Pontiac Grand Ville, 65-77 Pontiac Grand Prix, 64-72 Pontiac Tempest, 62-72 Nova, Ventura, 73-74 Non-Hatchback, Up to 1975 with groove channel, Apollo, Nova, Omega, Ventura 65-76 C-Body	2003
T		64-65-66	Trunk mat 2 piece	2DR SDN 2DR 4DR HTP CNV	64-66 Pontiac GTO, LeMans	6492
T		67	Trunk mat	2DR SDN 2DR 4DR HTP CNV	67 Pontiac GTO, LeMans	6493
T		68	Trunk mat	2DR SDN 2DR 4DR HTP CNV	68 Pontiac GTO, LeMans	6494
T		69-70-71-72	Trunk mat	2DR SDN 2DR 4DR HTP CNV	69-72 Pontiac GTO, LeMans	6494A



GUIDE TO SOFFSEAL'S PRODUCT CODES

B = Bumper sets **C** = Glass channels **D** = Door related **G** = Seals, gaskets **H** = Under hood items **I** = Interior parts
M = Miscellaneous items **R** = Roofrail, pillar post & convertible items **T** = Trunk related **W** = Window related **Z** = Weatherstrip kits

Pontiac • LeMans, GTO, Tempest



CODE	IMAGE	YEAR	DESCRIPTION	BODY	FITS	ITEM#
T		75-76-77-78-79-80-81-82-83-84-85-86-87-88-89-90-91-92	Trunk and Hatchback weatherstrip	2DR 4DR SDN HTP CNV	77-85 Chevrolet Impala, 77-91 Chevrolet Caprice, 82-92 Chevrolet Camaro, 75-79 Chevrolet Nova, 78-88 Chevrolet Monte Carlo, 78-83 Chevrolet Malibu, 78-83 Pontiac LeMans, 82-92 Pontiac Firebird, 75-91 Pontiac Ventura, 77-86 Pontiac Parisienne, 77-81 Pontiac Catalina, 69-88 Pontiac Grand Prix, 64-87 Pontiac LeMans, Pontiac Grand Am, 64-77 Pontiac GTO, 73-79 Oldsmobile Omega, 77-85 Oldsmobile Delta 88, 77-84 Oldsmobile 98, 77-88 Oldsmobile Cutlass, 73-75 Buick Apollo, 76-79 Buick Skylark, 77-79 Phoenix, 73-88 Buick Regal, 77-84 Buick Electra, 77-85 Buick LeSabre, 77-78 Buick Riviera, 77-91 C-Body	2424
W		64	Window weatherstrip replacement style	CNV	64 Pontiac GTO, LeMans, Convertible	6482
W		64	Window weatherstrip original style with round bead	2DR SDN	64 Pontiac GTO, LeMans, 2 Door Sedan	6480
W		64-65	Rubber door jambs u shape	2DR HTP CNV	64-65 Chevrolet Chevelle, Pontiac LeMans, GTO, Oldsmobile Cutlass, Buick Skylark 2 Door Hardtop Convertible	5113
W		64-65	Vent window seals	2DR HTP CNV	64-65 Chevrolet Chevelle, Pontiac GTO, LeMans, Oldsmobile Cutlass, Buick Skylark, 2 Door Hardtop Convertible	5102
W		64-65	Glass run channel front door window	2DR 4DR HTP CNV	64-65 Chevrolet Chevelle, Pontiac GTO, LeMans, Oldsmobile Cutlass, 442, Buick Skylark, 2 Door 4 Door Hardtop Convertible	5100
W		64-65	Quarter window seals steel insert	HTP	64-65 Chevrolet Chevelle, Pontiac LeMans, GTO, Oldsmobile Cutlass, Buick Skylark, Hardtop	5109M
W		64-65	Quarter window seals steel insert	CNV	64-65 Chevrolet Chevelle, Pontiac GTO, LeMans, Oldsmobile Cutlass, Buick Skylark, Convertible	5110M
W		64-65	Quarter window seals all rubber	2DR HTP	64-65 Chevrolet Chevelle, Pontiac LeMans, GTO, Oldsmobile Cutlass, Buick Skylark, 2 Door Hardtop	5109R
W		64-65	Quarter window seals all rubber	CNV	64-65 Chevrolet Chevelle, Pontiac GTO, LeMans, Oldsmobile Cutlass, Buick Skylark, Convertible	5110R
W		64-65-66-67	Quarter window seal rear	CNV	64-67 Chevrolet Chevelle, Pontiac Tempest, LeMans, GTO, Oldsmobile Cutlass, 442, Buick Skylark, Convertible	5108
W		64-65-66-67	Vent window seals	2DR 4DR SDN	64-67 Chevelle, El Camino, 66-67 Oldsmobile Cutlass, Buick Skylark, 64-65 Pontiac GTO, LeMans 2 Door 4 Door Sedan	51021
W		65	Window weatherstrip replacement style	2DR HTP	65 Pontiac GTO, LeMans, 2 Door Hardtop	6485
W		65	Window weatherstrip, original style with round bead	2DR SDN	65 Pontiac GTO, LeMans, 2 Door Sedan	6484

Pontiac • LeMans, GTO, Tempest

CODE	IMAGE	YEAR	DESCRIPTION	BODY	FITS	ITEM#
W		65	Window weatherstrip replacement style	CNV	65 Pontiac GTO, LeMans, Convertible	6486
W		66-67	Vent window seals	2DR HTP CNV	66-67 Chevrolet Chevelle, Pontiac GTO, LeMans, Oldsmobile Cutlass, Buick Skylark, 2 Door Hardtop Convertible	5103
W		66-67	Glass run channel front door window	2DR 4DR HTP CNV	66-67 Chevrolet Chevelle, Pontiac GTO, LeMans, Oldsmobile Cutlass, 442, Buick Skylark, Hardtop Convertible	5101
W		66-67	Rubber door jams u shape	2DR HTP CNV	66-67 Chevrolet Chevelle, Pontiac LeMans, GTO, Oldsmobile Cutlass, Buick Skylark, 2 Door Hardtop Convertible	51131
W		66-67	Window weatherstrip replacement style	CNV	66-67 Pontiac GTO, LeMans, Convertible	6490
W		66-67	Window weatherstrip replacement style	2DR HTP	66-67 Pontiac GTO, LeMans, 2 Door Hardtop	6489
W		66-67	Window weatherstrip original style with round bead	2DR SDN	66-67 Pontiac GTO, LeMans, 2 Door Sedan	6488
W		66-67	Quarter window seals all rubber	2DR HTP CNV	66-67 Chevrolet Chevelle, Buick Skylark, Pontiac GTO, Oldsmobile Cutlass, 2 Door Hardtop Convertible	5111R
W		66-67	Quarter window seals, all rubber	2DR HTP CNV	66-67 Buick Special, Skylark, Gran Sport, Oldsmobile F85, Cutlass, 442, Pontiac Tempest, LeMans, GTO, 2 Door Hardtop Convertible	6497R
W		66-67	Quarter window seals, steel insert	2DR HTP CNV	66-67 Pontiac GTO, LeMans, Oldsmobile Cutlass, Buick Skylark, 2 Door Hardtop Convertible	6497M
W		66-67	Quarter window seals with steel insert	2DR HTP CNV	66-67 Chevrolet Chevelle, Buick Skylark, Pontiac GTO, Oldsmobile Cutlass, 2 Door Hardtop Convertible	5111M
W		68	Vent window weatherstrip	2DR 4DR HTP	68 Chevrolet Chevelle, Pontiac LeMans, GTO, Oldsmobile Cutlass 442, Buick Special, Skylark, 2 Door Hardtop Convertible	51022
W		68	Window weatherstrip, original style with round bead	CNV	68 Pontiac GTO, LeMans, Convertible	65031
W		68	Window weatherstrip, original style with round bead	2DR HTP	68 Pontiac GTO, LeMans, 2 Door Hardtop	65011
W		68	Window weatherstrip replacement style	2DR HTP	68 Pontiac GTO, LeMans, 2 Door Hardtop	6501
W		68	Window weatherstrip replacement style	CNV	68 Pontiac GTO, LeMans, Convertible	6503
W		68-69-70-71-72	Quarter window seals, all rubber	2DR HTP CNV	68-72 Chevrolet Chevelle, Oldsmobile Cutlass, Buick Skylark, Pontiac LeMans, 69-70 Chevrolet Impala, 70-72 Chevrolet Monte Carlo, 2 Door Hardtop Convertible	5112R



GUIDE TO SOFFSEAL'S PRODUCT CODES









B = Bumper sets **C** = Glass channels **D** = Door related **G** = Seals, gaskets **H** = Under hood items **I** = Interior parts
M = Miscellaneous items **R** = Roofrail, pillar post & convertible items **T** = Trunk related **W** = Window related **Z** = Weatherstrip kits

Pontiac • LeMans, GTO, Tempest



CODE	IMAGE	YEAR	DESCRIPTION	BODY	FITS	ITEM#
W		68-69-70-71-72	Door u-jamb seals	2DR HTP CNV	68-72 Pontiac GTO, LeMans 2 Door Hardtop Convertible	6508
W		68-69-70-71-72	Vent window weatherstrip	2DR 4DR SDN	68 Chevrolet Chevelle, Pontiac Le Mans, GTO, Oldsmobile Cutlass, 442, Buick Skylark, 68-72 Chevrolet El Camino, Sedan	51031
W		68-69-70-71-72	Rubber door jambs u shape	2DR HTP CNV	68-72 Chevelle GTO Cutlass Skylark, 2 Door Hardtop Convertible	51132
W		68-69-70-71-72	Quarter window seals, with steel insert	2DR HTP CNV	68-72 Chevrolet Chevelle, Oldsmobile Cutlass, Buick Skylark, Pontiac LeMans, 69-70 Chevrolet Impala, 70-72 Chevrolet Monte Carlo, 2 Door Hardtop Convertible	5112M
W		69	Window weatherstrip original style with round bead	2DR SDN	69 Pontiac LeMans, GTO, 2 Door Sedan	6507
W		69-70-71-72	Window weatherstrip replacement style	CNV	69-72 Pontiac GTO, LeMans Convertible	6510
W		69-70-71-72	Window weatherstrip replacement style	2DR HTP	69-72 Pontiac GTO, LeMans, 2 Door Hardtop	6509
Z		64	Weatherstrip kit, includes door weatherstrips, hood to cowl seal, lock gaskets, quarter window seals, roofrail weatherstrips, trunk weatherstrip, window weatherstrips, door u-jambs	2DR HTP	64 Pontiac LeMans, GTO, 2 Door Hardtop	KIT605
Z		64	Weatherstrip kit, includes convertible top kit, door weatherstrips, hood to cowl seal, lock gaskets, pillar post seals, quarter window seals, trunk weatherstrip, door u jambs, window weatherstrips	CNV	64 Pontiac LeMans, GTO, Convertible	KIT608
Z		65	Weatherstrip kit, includes door weatherstrips, hood to cowl seal, lock gaskets, quarter window seals, roofrail weatherstrips, trunk weatherstrip, window weatherstrips, door u-jambs	2DR HTP	65 Pontiac LeMans, GTO, 2 Door Hardtop	KIT606
Z		65	Weatherstrip kit, includes convertible top kit, door weatherstrips, hood to cowl seal, lock gaskets, pillar post seals, quarter window seals, trunk weatherstrip, door u jambs, window weatherstrips	CNV	65 Pontiac LeMans, GTO, Convertible	KIT609
Z		66-67	Weatherstrip kit, includes convertible top kit, door weatherstrips, hood to cowl seal, lock gaskets, pillar post seals, quarter window seals, trunk weatherstrip, door u jambs, window weatherstrips	CNV	66-67 Pontiac LeMans, GTO, Convertible	KIT610

Pontiac • LeMans, GTO, Tempest

CODE	IMAGE	YEAR	DESCRIPTION	BODY	FITS	ITEM#
Z		66-67	Weatherstrip kit, includes trunk weatherstrip, door weatherstrip, roofrail weatherstrip	2DR HTP	66-67 Pontiac Tempest, LeMans, GTO, 2 Door Hardtop	KIT607X
Z		66-67	Weatherstrip kit, includes door weatherstrips, hood to cowl seal, lock gaskets, quarter window seals, roofrail weatherstrips, trunk weatherstrip, window weatherstrips, rubber door u-jambs	2DR HTP	66-67 Pontiac LeMans, GTO, 2 Door Hardtop	KIT607
Z		68	Weatherstrip kit, includes door weatherstrips, hood to cowl seal, lock gaskets, quarter window seals, roofrail weatherstrips, trunk weatherstrip, window weatherstrips, hood to cowl seal clips, door u-jamb seals	2DR HTP	68 Pontiac LeMans, GTO, 2 Door Hardtop	KIT611
Z		68	Weatherstrip kit, includes convertible top kit, door weatherstrips, hood to cowl seal, lock gaskets, pillar post seals, quarter window seals, trunk weatherstrip, door u jamba, window weatherstrips, hood to cowl seal clips	CNV	68 Pontiac LeMans, GTO, Convertible	KIT614
Z		69	Weatherstrip kit, includes door weatherstrips, hood to cowl seal, door handle & lock gaskets, quarter window seals, roofrail weatherstrips, trunk weatherstrip, window weatherstrips, hood to cowl seal clips, door U jamb seals	2DR HTP	69 Pontiac LeMans, GTO, 2 Door Hardtop	KIT612
Z		69	Weatherstrip kit includes convertible top kit, door weatherstrips, hood to cowl seal, lock gaskets, pillar post seals, quarter window seals, trunk weatherstrip, door u jamba, window weatherstrips, hood to cowl seal clips	CNV	69 Pontiac LeMans, GTO, Convertible	KIT615
Z		69-70-71-72	Weatherstrip kit, includes trunk weatherstrip, door weatherstrip, roofrail weatherstrip	2DR HTP	69-72 Pontiac Tempest, LeMans, GTO, 2 Door Hardtop	KIT612X
Z		70-71-72	Weatherstrip kit, includes door weatherstrips, hood to cowl seal, door handle & lock gaskets, quarter window seals, roofrail weatherstrips, trunk weatherstrip, window weatherstrips, hood to cowl seal clips, door U jamb seal	2DR HTP	70-72 Pontiac LeMans, GTO, 2 Door Hardtop	KIT613
Z		70-71-72	Weatherstrip kit includes convertible top kit, door weatherstrips, hood to cowl seal, lock gaskets, pillar post seals, quarter window seals, trunk weatherstrip, door u jamba, window weatherstrips, hood to cowl seal clips	CNV	70-72 Pontiac LeMans, GTO, Convertible	KIT616



GUIDE TO SOFFSEAL'S PRODUCT CODES

B = Bumper sets **C** = Glass channels **D** = Door related **G** = Seals, gaskets **H** = Under hood items **I** = Interior parts
M = Miscellaneous items **R** = Roofrail, pillar post & convertible items **T** = Trunk related **W** = Window related **Z** = Weatherstrip kits

Pontiac • Parisienne



CODE	IMAGE	YEAR	DESCRIPTION	BODY	FITS	ITEM#
D		77-78-79-80-81-82-83-84-85-86	Front door weatherstrip with clips	4DR SDN RWD	77-86 Impala Caprice, 77-84 Cadillac Deville Fleetwood, 85-86 Fleetwood, 77-84 Oldsmobile 88 89, 85 88, 77-84 Buick LeSabre Electra 85 LeSabre, 77-79 Buick Estate Wagon, 82-83 Buick Park Ave 77-81 Pontiac Bonneville, 83-86 Pontiac Parisienne, 77-80 Pontiac Catalina 4 Door Sedan, RWD Only	2500
D		77-78-79-80-81-82-83-84-85-86-87-88-89-90	Rear door weatherstrip with clips	4DR SDN RWD	77-86 Chevrolet Impala Caprice, 87-88 Caprice Caprice Classic, 89 Caprice, 90 Caprice Caprice Classic, 77-84 Cadillac Deville, 77-85 Oldsmobile 88, 77-78 Town Sedan, Custom Crusier, 77-84 Buick LeSabre Electra 85 LeSabre, 77-81 Pontiac Bonneville, Catalina, 83-86 Pontiac Parisienne 4 Door Sedan, RWD Only	2502
D		77-78-79-80-81-82-83-84-85-86-87-88-89-90	Rear door weatherstrip with clips	4 DR SWG, RWD	77-86 Chevrolet Impala Caprice, 87-88 Caprice Caprice Classic, Cadillac, 77-85 Oldsmobile Custom Cruiser, 77-88 Estate Station Wagon, 77-81 Catalina Safari Bonneville Safari, 82 Bonneville Safari, 83 Bonneville Parisienne, 84-89 Parisienne Station Wagon, RWD Only	2503
T		64-65-66-67-68-69-70-71-72-73-74-75-76-77	Trunk weatherstrip exact profile length 17 feet	2DR 4DR HTP 2DR SDN CNV	65-72 Chevy II, 65-72 Chevrolet Biscayne, 65-75 Chevrolet Bel Air, 65-76 Chevrolet Impala, 65-76 Chevrolet Caprice, 64-77 Chevrolet Chevelle, 70-77 Chevrolet Monte Carlo, 65-76 Buick LeSabre, 64-77 Buick Wildcat, 64-77 Buick Skylark, 71-73 Buick Centurion, 64-72 Buick Grand Special, 73-77 Buick Century, 73-88 Buick Regal, 73-88 Buick Grand National, 65-76 Buick Electra, 65-76 Oldsmobile Delta 88, 67-69 Oldsmobile Delmont 88, 65-66 Oldsmobile Dynamic 88, 65-66 Oldsmobile Starfire, 65 Oldsmobile Jetstar, 64-77 Oldsmobile Cutlass 442, 64-88 Oldsmobile Cutlass, 65-76 Oldsmobile 98, 65-76 Pontiac Parisienne, 64-72 Pontiac LeMans, 65-70 Pontiac Catalina, 65-66 Pontiac Star Chief, 67-70 Pontiac Executive, 71-75 Pontiac Grand Ville, 65-77 Pontiac Grand Prix, 64-72 Pontiac Tempest, 62-72 Nova, Ventura, 73-74 Non-Hatchback, Up to 1975 with groove channel, Apollo, Nova, Omega, Ventura 65-76 C-Body	2003

Pontiac • Parisienne

CODE	IMAGE	YEAR	DESCRIPTION	BODY	FITS	ITEM#
T		75-76-77-78-79-80-81-82-83-84-85-86-87-88-89-90-91-92	Trunk and Hatchback weatherstrip	2DR 4DR SDN HTP CNV	77-85 Chevrolet Impala, 77-91 Chevrolet Caprice, 82-92 Chevrolet Camaro, 75-79 Chevrolet Nova, 78-88 Chevrolet Monte Carlo, 78-83 Chevrolet Malibu, 78-83 Pontiac LeMans, 82-92 Pontiac Firebird, 75-91 Pontiac Ventura, 77-86 Pontiac Parisienne, 77-81 Pontiac Catalina, 69-88 Pontiac Grand Prix, 64-87 Pontiac LeMans, Pontiac Grand Am, 64-77 Pontiac GTO, 73-79 Oldsmobile Omega, 77-85 Oldsmobile Delta 88, 77-84 Oldsmobile 98, 77-88 Oldsmobile Cutlass, 73-75 Buick Apollo, 76-79 Buick Skylark, 77-79 Phoenix, 73-88 Buick Regal, 77-84 Buick Electra, 77-85 Buick LeSabre, 77-78 Buick Riviera, 77-91 C-Body	2424



WHAT IS A PRODUCT CODE?

Our catalog is grouped by product CODE (type) then years. See page 1 for details explaining the different Product CODES.





GUIDE TO SOFFSEAL'S PRODUCT CODES

B = Bumper sets **C** = Glass channels **D** = Door related **G** = Seals, gaskets **H** = Under hood items **I** = Interior parts
M = Miscellaneous items **R** = Roofrail, pillar post & convertible items **T** = Trunk related **W** = Window related **Z** = Weatherstrip kits



CODE	IMAGE	YEAR	DESCRIPTION	BODY	FITS	ITEM#
B		39-40-41-42-43-44-45-46-47-48-49-50-51-52-53-54-57-64-65-66-67-68-69-70-71-72	Brake clutch pedal bumpers	2DR 4DR HTP 2DR SDN CNV SWG	39-54 And 57 Chevrolet, 55-57 Pontiac, 64-72 Chevrolet	1058
B		41-42-43-44-45-46-47-48-49-50-51-52-53-54-55-56-57	Firewall/cowl bumper, 41-48 top of firewall, 41-54 side cowl	ALL BODY STYLES	41-57 Chevrolet	0457
B		47-48-49-50-51-52-53-54-55-56-57-58-59-60-61-62-63-64-65-66-67-68-69-70-71-72-73-74-75-76-77-78-79-80-81-82-83-84-85-86-87	Glove box door bumpers	2DR 4DR HTP 2DR SDN CNV SWG TRK	All Chevrolet, Pontiac, Oldsmobile, Buick 47-87 Chevrolet, Gmc Truck	1069
B		49-50-51-52-53-54-55-56-57	Door bumpers screw in upper	2DR SDN SWG	49-57 Chevrolet 150 210 Bel Air Styleline Fleetline, Pontiac Sedan, Plus Universal Applications	1054
B		51-52-53-54-55-56-57-58	Upper vent window bumpers	2DR 4DR HTP 2DR SDN CNV SWG	51-58 Chevrolet 150 210 Bel Air Nomad Del Ray Biscayne Impala, 51-54 Chevrolet, Pontiac, Oldsmobile, Buick, Cadillac, Hardtop Convertible	1224
B		55	Hood adjustment bumpers front & rear	2DR 4DR HTP 2DR SDN CNV SWG	55 Chevrolet 150 210 Bel Air Nomad, Pontiac	1072
B		55	Hood to fender bumpers 6 piece	2DR 4DR HTP 2DR SDN CNV SWG	55 Chevrolet 150 210 Bel Air Nomad	1073
B		55-56	Seat back rest bumper	2DR 4DR HTP 2DR SDN CNV SWG	55-56 Chevrolet 150 210 Bel Air Nomad, Pontiac, Safari	1059
B		55-56	Brake clutch pedal bumper	2DR 4DR HTP 2DR SDN CNV SWG	55-56 Chevrolet 150 210 Bel Air, Pontiac, Olds	1057
B		55-56-57	Body bumper kit	2DR HTP CNV	55-57 Chevrolet 210 Bel Air, 2 Door Hardtop Convertible	1055
B		55-56-57	Body bumper kit	2DR SDN	55-57 Chevrolet 150 210 Bel Air, Pontiac, 2 Door, Sedan	1056
B		55-56-57	Door bumpers	4DR SWG	55-57 Chevrolet 150 210 Bel Air, Pontiac, Oldsmobile, All Station Wagons, 4 Door Sedan Station Wagon	10541
B		55-56-57	Door upper bumpers push in	2DR 4DR SDN	55-57 Chevrolet 150 210 Bel Air, Pontiac, Oldsmobile, Sedan	10542
B		55-56-57	Trunk bumpers	2DR 4DR HTP 2DR SDN CNV	55-57 Chevrolet 150 210 Bel Air, Pontiac	1052

Pontiac • Star Chief

CODE	IMAGE	YEAR	DESCRIPTION	BODY	FITS	ITEM#
B		55-56-57	Tailgate liftgate bumpers	SWG	55-57 Chevrolet 150 210 Bel Air, Pontiac, Station Wagon	1227
B		55-56-57	Clutch pedal rebound bumper	2DR SDN 2DR 4DR HTP CNV SWG	55-57 Chevrolet, Pontiac	1096
B		55-56-57	Quarter window bumpers	CNV	55-57 Chevrolet Bel Air, Convertible	1221
B		55-56-57-58	Door bumpers	2DR 4DR HTP 2DR SDN CNV SWG	55-58 Chevrolet, Pontiac, Olds	1053
B		55-56-57-58-59	Upper trunk or rear license plate bumper	2DR 4DR HTP 2DR SDN CNV SWG	55-59 Chevrolet 150 210 Bel Air Nomad, Pontiac, Olds	10521
B		56-57	Door bumpers	4DR HTP	56-57 Chevrolet 210 Bel Air, Pontiac, Oldsmobile, 4 Door Hardtop	10543
B		56-57	Hood to fender bumpers	2DR 4DR HTP 2DR SDN CNV SWG	56-57 Chevrolet 150 210 Bel Air Nomad	1223
B		56-57-58-59-60-61-62-63-64-65-66-67-68-69-70-71-72-73-74	Hood adjustment bumpers round	2DR 4DR HTP 2DR SDN CNV SWG	56-74 Chevrolet, Pontiac, All Models	1222
B		57	Seat back rest bumpers	2DR 4DR HTP 2DR SDN CNV SWG	57 Chevrolet 150 210 Bel Air Nomad, Pontiac, Safari, Oldsmobile	1061
B		59-60	Vent window bumpers upper	2DR HTP	59-60 Chevrolet Bel Air, Impala Pontiac Catalina, Star chief Oldsmobile Dynamic 88, Super 88, 98, Cadillac Deville, Eldorado, Series 62, Buick Lesabre, Invicta, Electra Full Size 2 Door Hardtop	2202
B		59-60-61-62-63	Hood to fender bumpers, 4 piece	2DR SDN 2DR 4DR HTP CNV SWG	59-63 Pontiac All	2055
C		55	Rear glass channel	2DR 4DR SDN	55 Chevrolet 210 Bel Air, Pontiac 2 Door 4 Door Sedan	1203
C		55-56-57	Glass channel rear side window curved 4 door station wagon	SWG 4DR	55-57 Chevrolet, Pontiac, 4 Door Station Wagon	1120
C		55-56-57	Glass channel rear side window curved	2DR SWG	55-57 Chevrolet, Pontiac, Except Nomad And Safari, 2 Door Station Wagon	1121
C		55-56-57	Front glass channel	2DR 4DR HTP 2DR SDN CNV SWG	55-57 Chevrolet, Pontiac Safari, Except 55, 150 Convertible	1201















GUIDE TO SOFFSEAL'S PRODUCT CODES

B = Bumper sets **C** = Glass channels **D** = Door related **G** = Seals, gaskets **H** = Under hood items **I** = Interior parts
M = Miscellaneous items **R** = Roofrail, pillar post & convertible items **T** = Trunk related **W** = Window related **Z** = Weatherstrip kits



CODE	IMAGE	YEAR	DESCRIPTION	BODY	FITS	ITEM#
C		59-60	Glass channel	2DR 4DR HTP CNV	59-60 Chevrolet Bel Air, Impala, Cadillac Series 62, Deville, Eldorado, Oldsmobile 88 Oldsmobile 98, Buick LeSabre, Invicta, Electra, Pontiac Catalina, Star Chief, Bonneville 2 Door 4 Door Hardtop Convertible	2080
C		61-62	Glass channel front	2DR HTP	61 Chevrolet Impala, 62 Chevrolet Bel Air, 61 Cadillac Series 62, 62 Cadillac Deville 4 Door S, 61-62 Oldsmobile 88 Oldsmobile 98, 61 Buick LeSabre, Invicta, Electra, 62 Buick, 61-62 Pontiac Catalina, Ventura, Star Chief, Bonneville 2 Door Hardtop	2161
C		61-62	Glass channel front	CNV HT	62 Chevrolet, Pontiac, Oldsmobile, Buick, Cadillac Formal Roof Hardtop, 61-62 Convertible, 61 Pontiac, Oldsmobile, Buick, Cadillac Formal Roof Hardtop	2162
C		62-63-64	Glass channel rear	2DR 4DR SDN	62-63 Chevrolet Biscayne, Bel Air, Impala, 62-64 Cadillac, 62-64 Oldsmobile 88, 62-64 Buick LeSabre, 64 Wildcat, 62-64 Pontiac Catalina, Star Chief 2 Door 4 Door Sedan	2189
C		63-64	Glass channel rear	4DR HTP	63-64 Chevrolet Impala Sport Coupe, Oldsmobile 88 Holiday Sedan, Buick LeSabre, Wildcat, Pontiac Bonneville, Catalina, Star Chief 4 Door Hardtop	2188
D		55-56-57	Door j weatherstrip with clips	2DR 4DR HTP 2DR SDN CNV SWG	55-57 Chevrolet, Pontiac, All Models	1204
D		55-56-57	Upper gate weatherstrip with clips & molded ends	SWG	55-57 Chevrolet 150 210 Bel Air, Pontiac, Station Wagon	1228
D		55-56-57	Lower gate weatherstrip with clips & molded corner	SWG	55-57 Chevrolet 150 210 Bel Air, Pontiac Station Wagon	1226
D		55-56-57	Door weatherstrip with clips & molded ends	2DR HTP CNV	55-57 Chevrolet, Pontiac, 2 Door Hardtop Convertible	1000
D		55-56-57	Door weatherstrip with clips with out molded ends	2DR HTP CNV	55-57 Chevrolet, Pontiac, 2 Door Hardtop Convertible	1001
D		55-56-57-58-59-60	Door weatherstrip with clips sedan front and rear	2DR 4DR SDN SWG	55-60 Chevrolet Bel Air 150 210, Nomad, Pontiac Chieftain, Star Chief, Safari, Super Chief, Bonneville, Buick Century, Roadmaster, Special Also Station Wagon And Sedan Delivery	1003
D		55-56-57-58-59-60	Door weatherstrip rear with clips	SWG	55-57 Chevrolet Bel Air 150 210 55-56 Pontiac Chieftain 860 870, Star Chief, 58-60 Chevrolet Sedan Delivery	1230
D		56-57	Rear door weatherstrip with clips & molded ends	4DR HTP	56-57 Chevrolet 210 Bel Air, Pontiac, 4 Door Hardtop	1004
D		56-57	Front door weatherstrip with clips & molded ends	4DR HTP	56-57 Chevrolet 210 Bel Air, Pontiac, 4 Door Hardtop	1005

Pontiac • Star Chief

CODE	IMAGE	YEAR	DESCRIPTION	BODY	FITS	ITEM#
D		58	Door weatherstrip	2DR 4DR HTP 2DR SDN CNV SWG	58 Chevrolet Del Ray, Biscayne, Bel Air, Impala, 58 Cadillac, 57-58 Oldsmobile 88 Oldsmobile 98, 57-58 Buick Special Century, Super, Roadmaster, 58 Pontiac	2044
D		59-60	Door weatherstrip front with clips & molded ends	4DR HTP	59-60 Chevrolet Impala, Bel Air, Buick Lesabre, Invicta, Oldsmobile 88, Pontiac Catalina, Star Chief, Bonneville 4 Door Hardtop	2205
D		59-60	Door weatherstrip with clips & molded ends	2DR HTP CNV	59-60 Chevrolet Impala, Bel Air, Pontiac Catalina, Star Chief, Bonneville, Oldsmobile 88, 98, Buick LeSabre, Invicta, Electra, Cadillac Deville, Eldorado, Series 62 Hardtop Convertible	2011
D		61-62-63-64	Door weatherstrip rear door with clips	4DR SDN	61-64 Chevrolet Biscayne Bel Air Impala, 61-64 Oldsmobile 88, 98, 61-62 Cadillac, 61-64 Buick LeSabre Electra, 64 Wildcat, 61-64 Pontiac Catalina, Star Chief, 4 Door Sedan	2009
D		63-64	Front door weatherstrip with molded ends	4DR HTP	63-64 Chevrolet Biscayne, Bel Air, Impala, Buick Wildcat, Lesabre, Electra, Pontiac Catalina, Star Chief, Bonneville, Oldsmobile Dynamic 88, 98 4 Door Ht	2121
D		65-66	Door weatherstrip front with clips	4DR SDN SWG	65-66 Chevrolet Biscayne Bel Air Impala, 65-66 Cadillac Calais Deville Fleetwood, 65-66 Oldsmobile 88, 65-66 Buick LeSabre Wildcat, 65-66 Pontiac Bonneville, Catalina, Star chief, 4 Door Sedan Swg	2006
D		65-66	Rear door weatherstrip with clips	4DR SDN	65-66 Chevrolet Biscayne Bel Air Impala 65-66 Cadillac Calais Deville Fleetwood 65-66 Oldsmobile 88, 65-66 Buick LeSabre Wildcat, 65-66 Pontiac Catalina, Star Chief, 4 Door Sedan	2007
D		65-66-67-68	Door weatherstrip front door with clips & molded ends	4DR HTP	65-68 Chevrolet Impala, Buick, Wildcat, LeSabre, Cadillac Calais, Deville, Oldsmobile 98 Oldsmobile 99, Pontiac, 4 Door Hardtop	2210
G		55-56-57	Rear wheel housing seal all	ALL BODY STYLES	55-57 Chevrolet, Pontiac	1220A
G		55-56-57	Door handle & lock gasket set	2DR 4DR HTP 2DR SDN CNV SWG	55-57 Chevrolet, Pontiac, 2 Door	1019
G		55-56-57	Paint gasket kit	4DR HTP SWG	55-57 Chevrolet 4 Door	1021
G		55-56-57	Door handle gaskets	2DR 4DR HTP 2DR SDN CNV SWG	55-57 Chevrolet, Pontiac	1022
G		55-56-57	Lock cylinder gasket	2DR 4DR HTP 2DR SDN CNV SWG	55-57 Chevrolet, Pontiac	1023

















GUIDE TO SOFFSEAL'S PRODUCT CODES						
B = Bumper sets	C = Glass channels	D = Door related	G = Seals, gaskets	H = Under hood items	I = Interior parts	
M = Miscellaneous items	R = Roofrail, pillar post & convertible items		T = Trunk related	W = Window related	Z = Weatherstrip kits	



CODE	IMAGE	YEAR	DESCRIPTION	BODY	FITS	ITEM#
G		55-56-57	Antenna base gasket	2DR 4DR HTP 2DR SDN SWG CNV	55-57 Chevrolet, Pontiac	1024
G		55-56-57	Mirror gasket	2DR 4DR HTP 2DR SDN SWG CNV	55-57 Chevrolet, Pontiac	1025
G		58	Steering column seal with automatic trans	2DR 4DR HTP 2DR SDN CNV SWG	58 Chevrolet Pontiac	2056
G		58	Steering column seal sponge	2DR 4DR HTP 2DR SDN CNV SWG SR	58 Chevrolet Pontiac, Universal Fit Street Rod And Custom, Standard Transmission	2056A
G		58	Door handle & lock gaskets	2DR 4DR HTP 2DR SDN SWG CNV	58 Chevrolet Pontiac	2059
G		59	Door handle & lock gaskets	2DR 4DR HTP 2DR SDN CNV SWG	59 Chevrolet Pontiac	2073
G		60-63-64-69-70	Door handle & lock gaskets	2DR 4DR HTP 2DR SDN CNV SWG	60 Chevrolet Biscayne, Impala, Bel Air, Cadillac, Oldsmobile 89 Oldsmobile 98, Buick LeSabre, Invicta, Electra, Wild Cat, Pontiac Catalina, Star Chief, Bonneville, Grand Prix, Ventura	2098
G		61-62-65-66-67-68	Door handle & lock gaskets	2DR 4DR HTP 2DR SDN CNV SWG	61-62 Chevrolet Biscayne, Bel Air, Impala, Cadillac, Oldsmobile 88 Oldsmobile 98, Buick LeSabre, Invicta, Electra, Pontiac	2145
H		55-56-57	Firewall grommet	2DR 4DR HTP 2DR SDN SWG CNV	55-57 Chevrolet All, Pontiac, Olds	1026
H		55-56-57-58-59	Hood to cowl seal	2DR 4DR HTP 2DR SDN SWG CNV TRK	55-56 Chevrolet, Pontiac, Oldsmobile, 55-59 Chevrolet, Gmc Truck	1080
H		56	A-arm seals with cloth backing	2DR 4DR HTP 2DR SDN CNV SWG	56 Chevrolet 150 210 Bel Air Nomad	1082
H		56-57-58-59-60	Firewall grommet main wiring harness	2DR 4DR HTP 2DR SDN 2DR SDN SWG CNV	56-60 Chevrolet, Pontiac, Olds	1027
H		57	A-arm seals with staples	2DR 4DR HTP 2DR SDN CNV SWG	57 Chevrolet 150 210 Bel Air Nomad	1084
H		57	Hood to cowl seal	2DR 4DR HTP 2DR SDN CNV SWG	57 Chevrolet 150 210 Bel Air	1101









Pontiac • Star Chief

CODE	IMAGE	YEAR	DESCRIPTION	BODY	FITS	ITEM#
H		57	Hood to cowl seal clips & screws	2DR 4DR HTP 2DR SDN CNV SWG	57 Chevrolet 150 210 Bel Air	1102
I		55-56-57	Gear shift grommet	2DR 4DR HTP 2DR SDN CNV SWG	55-57 Chevrolet, Pontiac, Oldsmobile All	1094
I		59-60-61-62-63-64-65-66	Gear shift grommet column	2DR 4DR SDN HTP CNV	59-66 Chevrolet Biscayne, Bel Air, Impala, 59-66 Cadillac, 59-63 Oldsmobile 88 Oldsmobile 98, 61 Starfire, 64-66 Starfire, Jet Star, 59-66 Buick LeSabre, Invicta, Electra, 63 Wildcat, Riviera, 59-66 Pontiac	2185A
M		55-56-57	Lower speedo cable wiring harness grommet	2DR 4DR HTP SDN CNV SWG	55-57 Chevrolet, Pontiac, 2 Door 4 Door Hardtop Sedan Convertible Station Wagon	1099
R		55-56-57	Header seal	CNV	55-57 Chevrolet Bel Air, Pontiac Convertible	1031
R		56-57	Roofrail weatherstrip	4DR HTP	56-57 Chevrolet 210 Bel Air, Pontiac, 4 Door Hardtop	1028
R		61	Roofrail weatherstrip with molded ends	2DR HTP	61 Chevrolet, Buick, Oldsmobile, Pontiac 2 Door Hardtop	2129
R		61-62	Roofrail weatherstrip	4DR HTP	61-62 Chevrolet Bel Air, Impala, Buick, LeSabre, Invicta, Oldsmobile 88, Pontiac, 4 Door Hardtop	2223
R		65-66	Roofrail weatherstrip with molded ends	4DR HTP	65-66 Chevrolet Impala, Caprice, 65-66 Cadillac, 65-66 Oldsmobile 88, 65-66 Buick LeSabre, 65-66 Pontiac, 4 Door Hardtop	2333A
T		55-56	Trunk weatherstrip	2DR 4DR HTP 2DR SDN CNV	55-56 Chevrolet 150, Chevrolet 210, Chevrolet Bel Air, Chevrolet Nomad, Oldsmobile 98, Pontiac Chieftan, Pontiac 860, Pontiac 870, Pontiac Super Chief, Pontiac Bonneville, Pontiac Star Chief, Pontiac Safari	6012
T		55-56-57	Trunk mat	2DR 4DR HTP 2DR SDN 4DR SDN	55-57 Chevrolet 150 210 Bel Air, Pontiac, Hardtop Sedan	1217
T		55-56-57	Trunk mat	CNV	55-57 Chevrolet Bel Air, Pontiac, Convertible	1217A
T		55-56-57	Trunk area access plugs	2DR 4DR HTP 2DR SDN CNV	55-57 Chevrolet 150 210 Bel Air, Pontiac	1218
T		55-56-57	Spare tire well plugs	2DR 4DR HTP 2DR SDN CNV	55-57 Chevrolet 150 210 Bel Air, Pontiac Chieftan, Starchief, Super Chief, Oldsmobile	1219
T		57	Trunk weatherstrip with clips	2DR 4DR HTP 2DR SDN CNV	57 Pontiac Star Chief	6016











GUIDE TO SOFFSEAL'S PRODUCT CODES					
B = Bumper sets	C = Glass channels	D = Door related	G = Seals, gaskets	H = Under hood items	I = Interior parts
M = Miscellaneous items	R = Roofrail, pillar post & convertible items	T = Trunk related	W = Window related	Z = Weatherstrip kits	



CODE	IMAGE	YEAR	DESCRIPTION	BODY	FITS	ITEM#
T		58-59-60-61-62-63-64-65-66-67-68-69	Trunk weatherstrip exact profile	2DR 4DR HTP 2DR SDN CNV	58-64 Chevrolet Biscayne, 58-64 Chevrolet Bel Air, Chevrolet Impala, 60-69 Chevrolet Corvair, 59-64 Pontiac Parisienne, 59-64 Pontiac Catalina, 59-64 Pontiac Star Chief, 60-61 Pontiac Ventura, 62-64 Pontiac Grand Prix, 58-64 Oldsmobile Delta 88, 58-64 Oldsmobile Dynamic 88, Oldsmobile Super 88, Oldsmobile Super 98, 61-64 Oldsmobile Starfire, 64 Oldsmobile Jetstar, 59-64 Buick LeSabre, 59-62 Buick Invicta, 59-64 Buick Electra, 62-64 Buick Wildcat, 63-65 Buick Riviera, 58-60 Cadillac Deville, Cadillac Eldorado, Cadillac Series 62, Cadillac Series 60 Special, Cadillac Series 75, 58-64 C-Body	2001
T		62-63-64-65-66-67-68-69-70-71-72-73	Door and tailgate bottom drain hole seal	2DR 4DR HTP SDN CNV SWG CPE	62-73 Chevy Nova, Chevelle, Impala, Caprice Pontiac Catalina, Star Chief, Bonneville, Grand Prix Oldsmobile F85	2118
T		64-65-66-67-68-69-70-71-72-73-74-75-76-77	Trunk weatherstrip exact profile length 17 feet	2DR 4DR HTP 2DR SDN CNV	65-72 Chevy II, 65-72 Chevrolet Biscayne, 65-75 Chevrolet Bel Air, 65-76 Chevrolet Impala, 65-76 Chevrolet Caprice, 64-77 Chevrolet Chevelle, 70-77 Chevrolet Monte Carlo, 65-76 Buick LeSabre, 64-77 Buick Wildcat, 64-77 Buick Skylark, 71-73 Buick Centurion, 64-72 Buick Grand Special, 73-77 Buick Century, 73-88 Buick Regal, 73-88 Buick Grand National, 65-76 Buick Electra, 65-76 Oldsmobile Delta 88, 67-69 Oldsmobile Delmont 88, 65-66 Oldsmobile Dynamic 88, 65-66 Oldsmobile Starfire, 65 Oldsmobile Jetstar, 64-77 Oldsmobile Cutlass 442, 64-88 Oldsmobile Cutlass, 65-76 Oldsmobile 98, 65-76 Pontiac Parisienne, 64-72 Pontiac LeMans, 65-70 Pontiac Catalina, 65-66 Pontiac Star Chief, 67-70 Pontiac Executive, 71-75 Pontiac Grand Ville, 65-77 Pontiac Grand Prix, 64-72 Pontiac Tempest, 62-72 Nova, Ventura, 73-74 Non-Hatchback, Up to 1975 with groove channel, Apollo, Nova, Omega, Ventura 65-76 C-Body	2003
W		37-38-39-40-41-42-43-44-45-46-47-48-49-50-51-52-53-54	Mohair channel liner, 4 feet of 2 7/8 inch mohair lining material	CNV 2DR 4DR HTP	Bel Air 150 210, Nomad, Chieftain, 860/870 Star Chief, Safari, Super Chief, Bonneville, Nova, Omega, Apollo, Ventura, Skylark	0420
W		55-56-57	Front of door flipper stops	2DR HTP	55-57 Chevrolet, Pontiac, Oldsmobile 2 Door Hardtop	1086
W		55-56-57	Front flipper to vent stop	2DR HTP	55-57 Chevrolet, Pontiac, Oldsmobile, 2 Door Hardtop	1088
W		55-56-57	Flipper reline kit	2DR HTP	55-57 Chevrolet, Oldsmobile, Pontiac, 2 Door Hardtop	1089
W		55-56-57	Cozy vent seals	2DR SDN 4DR SDN SWG	55-57 Chevrolet, Pontiac, 2 Door And 4 Door Sedan And Station Wagon Except Nomad And Safari	1033

Pontiac • Star Chief

CODE	IMAGE	YEAR	DESCRIPTION	BODY	FITS	ITEM#
W		55-56-57	Window weatherstrip with division bar & window channel replacement style	4DR SWG	55-57 Chevrolet Bel Air, Pontiac Star Chief 4 Door Station Wagon	1048
W		55-56-57	Glass setting channel, doors only	2DR HTP 2DR SDN	55-57 Chevrolet, Pontiac Safari, Oldsmobile, 2 Door Hardtop	1211
W		56-57	Quarter window seals	4DR HTP	56-57 Chevrolet And Pontiac, 4 Door Hardtop	1239
W		59-60	Rear quarter stationary vent window seals	4DR SDN	59-60 Chevrolet Buick, Style 4419, 4619, 4719 Oldsmobile, Pontiac 4 Door Sedan	2053
W		61-62-63-64-65-66	Horizontal outer window seals	2DR 4DR HTP SDN CNV SWG	Chevy Biscayne, Bel Air, Impala, Caprice, Cadillac series 62 Deville, Eldorado, Fleetwood, Calais, Oldsmobile 88, Starfire, 98. Buick Lesabre, Invicta, Wildcat, Electra, Pontiac Catalina, Ventura, Star Chief, Bonneville	2310
W		65-66	Door u-jamb seal	2DR HTP CNV	65-66 Chevrolet Impala, 66 Caprice, 65-66 Cadillac Calais, Deville, Eldorado, 65-66 Oldsmobile 88, Jetstar, Starfire, Oldsmobile 98, 65-66 Buick LeSabre, Wildcat, Electra, 65 Pontiac Bonneville, Catalina, Star Chief 2hardtop Convertible	2368
W		65-66	Quarter window seals	2DR HTP CNV	65-66 Chevrolet Impala, 66 Chevrolet Caprice, 65-66 Cadillac Calais, Deville 65-66 Oldsmobile 88, Jetstar, 65-66 Buick LeSabre, Wildcat, 65-66 Pontiac Bonneville, Catalina, Star Chief 2 Door Hardtop Convertible	2301
W		65-66	Quarter window seals	4DR HTP	65-66 Chevrolet Impala, 66 Chevrolet Caprice, 65-66 Cadillac Calais, Deville, 65-66 Oldsmobile 88 Oldsmobile 98, 65-66 Buick LeSabre, Wildcat, Electra, 65-66 Pontiac Bonneville, Catalina, Star Chief 4 Door Hardtop	23011
W		65-66-67-68	Vent window weatherstrip	2DR HTP CNV	65-68 Chevrolet Impala, Buick LeSabre, Electra, Wildcat, Cadillac Calais, Deville, Oldsmobile 88 Oldsmobile 98 Starfire, Pontiac Bonneville, Catalina, Star Chief 2 Door Hardtop Convertible	2217



GUIDE TO SOFFSEAL'S PRODUCT CODES

B = Bumper sets **C** = Glass channels **D** = Door related **G** = Seals, gaskets **H** = Under hood items **I** = Interior parts
M = Miscellaneous items **R** = Roofrail, pillar post & convertible items **T** = Trunk related **W** = Window related **Z** = Weatherstrip kits

Pontiac • Sunbird, Sunfire



CODE	IMAGE	YEAR	DESCRIPTION	BODY	FITS	ITEM#
D		75-76-77-78-79-80	Door weatherstrip	2DR SDN	75-80 Chevrolet Monza, Oldsmobile Starfire, Buick Skyhawk, Pontiac Sunbird H-Body Coupe	8029
D		82-83-84-85-86-87	Door Weatherstrips	Cnv	82-87 Chevrolet Cavalier, Pontiac Sunbird	8703
D		82-83-84-85-86-87-88-89-90-91-92	Door weatherstrip front/rear	All	82-89 Skyhawk 92-97 Skylark 82-88 Cimarron 93-96 Fleetwood 82-94 Beretta 82-94 Cavalier 91-96 Caprice 82-96 Corsica 82-94 Lumina 82-93 S10 83-94 S10 Blazer 82-05 Chev Van 83-94 GMC Jimmy 82-93 GMC Sonoma 82-05 GMC Van 82-94 Achieva 82-85 Custom Cruiser 82-94 Firenza 82-94 Grand Am 82-94 Sunbird	9110
D		88-89-90-91-92-93-94	Door weatherstrips	Cnv	88-94 Chevrolet Cavalier, Pontiac Sunbird Convertible	8704
D		95-96-97-98-99-00	Door Weatherstrips	CNV	95-00 Chevrolet Cavalier, Pontiac Sunfire Convertible	8700
M		00-99	Window weld ribbon sealer 3/8 inch round	ALL BODY STYLES	All Makes And Models	08622
M		75-76-77-78-79-80	Door weatherstrip hatchback	2DR SDN	75-80 Chevrolet Monza, Oldsmobile Starfire, Buick Skyhawk, Pontiac Sunbird H-Body	8028
R		82-83-84-85-86-87-88-89-90-91-92-93-94	Convertible top kit	CNV	82-94 Chevrolet Cavalier, Pontiac Sunbird Convertible	8705
R		95-96-97-98-99-00	Header seal	CNV	95-00 Chevrolet Cavalier, Pontiac Sunfire Convertible	8701
R		95-96-97-98-99-00	Roofrail weatherstrips	CNV	95-00 Chevrolet Cavalier, Pontiac Sunfire Convertible	8702
T		82-83-84-85-86-87-88-89-90-91-92-93-94-95-96-97-98-99-00	Trunk weatherstrip	CNV	82-00 Chevrolet Cavalier Pontiac Sunbird, Sunfire Convertible	8706
W		83-84-85-86-87-88-89-90-91-92-93-94	Quarter Window Leading Edge Seal, CNV only	CNV	83-94 Pontiac Sunbird, Chevrolet Cavalier	8708
W		88-89-90-91-92-93-94	Rear of Door Glass Seal	CNV	88-94 Cavalier, Sunbird	8707

Pontiac • Ventura

CODE	IMAGE	YEAR	DESCRIPTION	BODY	FITS	ITEM#
B		47-48-49-50-51-52-53-54-55-56-57-58-59-60-61-62-63-64-65-66-67-68-69-70-71-72-73-74-75-76-77-78-79-80-81-82-83-84-85-86-87	Glove box door bumpers	2DR 4DR HTP 2DR SDN CNV SWG TRK	All Chevrolet, Pontiac, Oldsmobile, Buick 47-87 Chevrolet, Gmc Truck	1069
B		59-60-61-62-63	Hood to fender bumpers, 4 piece	2DR SDN 2DR 4DR HTP CNV SWG	59-63 Pontiac All	2055
B		61-62	Upper vent window bumper	2DR HTP	61-62 Chevrolet Bel Air, Impala, Pontiac Catalina, Bonneville, Ventura, Cadillac, Buick, Oldsmobile, 2 Door 4 Door Hardtop	2087
C		61-62	Glass channel front	2DR HTP	61 Chevrolet Impala, 62 Chevrolet Bel Air, 61 Cadillac Series 62, 62 Cadillac Deville 4 Door S, 61-62 Oldsmobile 88 Oldsmobile 98, 61 Buick LeSabre, Invicta, Electra, 62 Buick, 61-62 Pontiac Catalina, Ventura, Star Chief, Bonneville 2 Door Hardtop	2161
D		59-60	Door j weatherstrip	2DR 4DR HTP SWG 2DR SDN 4DR SDN	59-60 Chevrolet, Pontiac, Oldsmobile, Buick, Cadillac	2093
D		61-62	Door weatherstrip with clips & molded ends	2DR HTP CNV	61-62 Chevrolet Bel Air Impala, Cad Series 62, Deville, 61-62 Oldsmobile, 61 Hardtop Convertible 88 Star Fire, Oldsmobile 98/62 Oldsmobile 88 Oldsmobile 98 Starfire, 61-62 Buick 61 Hardtop Convertible, 62 Convertible Only LeSabre Invicta Electra, 61-62 Pontiac, 2 Door Hardtop Convertible	2013
D		61-62	Door weatherstrip front with clips	SWG 4 DR SDN	61-62 Chevrolet BelAir, Biscayne, Impala, Pontiac, Station Wagon & 4 Dr Sedan	2019
D		68-69-70-71-72-73-74	Door weatherstrip with clips	2DR SDN	68-74 Nova 73-74 Apollo, Omega, 71-74 Ventura 2 Door Sedan	4020
D		68-69-70-71-72-73-74	Door weatherstrip front door with clips	4DR SDN	68-74 Nova 73-74 Buick Apollo, 73-74 Oldsmobile Omega, 71-74 Pontiac Ventura, 4 Door Sedan	4081
D		68-69-70-71-72-73-74	Door weatherstrip rear door with clips	4DR SDN	68-74 Nova 73-74 Buick Apollo, 73-74 Oldsmobile Omega, 71-74 Pontiac Ventura, 4 Door Sedan	4081A
D		75-76-77-78-79	Door weatherstrip front door with clips	4DR SDN	75-79 Chevy II Nova, 75 Buick Apollo, 76-79 Buick Skylark, 75-79 Oldsmobile Omega, 75-77 Pontiac Ventura, 78-79 Phoenix, 4 Door Sedan	40813
D		75-76-77-78-79	Door weatherstrip rear door with clips	4DR SDN	75-79 Chevy II Nova, 75 Buick Apollo, 76-79 Buick Skylark, 75-79 Oldsmobile Omega, 75-77 Pontiac Ventura, 78-79 Phoenix, 4 Door Sedan	40814
D		75-76-77-78-79	Door weatherstrip with clips	2DR SDN	75-79 Nova, 75 Apollo, 75-79 Oldsmobile Omega, 75-77 Pontiac Ventura, 77-79 Pontiac Phoenix 76-79 Buick Skylark, 2 Door Sedan	4024









GUIDE TO SOFFSEAL'S PRODUCT CODES					
B = Bumper sets	C = Glass channels	D = Door related	G = Seals, gaskets	H = Under hood items	I = Interior parts
M = Miscellaneous items	R = Roofrail, pillar post & convertible items	T = Trunk related	W = Window related	Z = Weatherstrip kits	



CODE	IMAGE	YEAR	DESCRIPTION	BODY	FITS	ITEM#
G		60-63-64-69-70	Door handle & lock gaskets	2DR 4DR HTP 2DR SDN CNV SWG	60 Chevrolet Biscayne, Impala, Bel Air, Cadillac, Oldsmobile 89 Oldsmobile 98, Buick LeSabre, Invicta, Electra, Wild Cat, Pontiac Catalina, Star Chief, Bonneville, Grand Prix, Ventura	2098
G		61-62-65-66-67-68	Door handle & lock gaskets	2DR 4DR HTP 2DR SDN CNV SWG	61-62 Chevrolet Biscayne, Bel Air, Impala, Cadillac, Oldsmobile 88 Oldsmobile 98, Buick LeSabre, Invicta, Electra, Pontiac	2145
G		68	Taillamp lens gaskets, bonneville can be modified to fit catalina & ventura	2DR 4DR HTP CNV SWG	68 Pontiac	6854
H		ALL-MODELS-WHERE-APPLICABLE	Air cleaner lid seal, cut to fit	2DR 4DR HTP 2DR SDN CNV SWG	GM All	2099
I		55-56-57-61-62-63-64	Glove box arm grommet	2DR 4DR HTP 2DR SDN CNV SWG	55-57 And 61-64 Chevrolet, Pontiac, Oldsmobile All	10691
I		64-65-66-67-68-69-70	Sun visor tip	2DR 4DR SDN HTP CNV	64-70 All Makes And Models	4006
M		00-99	Window weld ribbon sealer 3/8 inch round	ALL BODY STYLES	All Makes And Models	08622
M		55-56-57-59-60-61	Gear tube grommet	2DR 4DR HTP SDN CNV SWG	55-57 And 59-60 Chevrolet Pontiac, Oldsmobile, 60-61 Chevrolet Truck, Gmc Truck, 2 Door 4 Door Hardtop Sedan Convertible Station Wagon	1095
M		67-68-69-70-71-72-73-74-75-76-77-78-79-80-81-82-83-84	Oil filler cap	2DR 4DR SDN HTP CNV	67-84 GM All Models	5044
T		58-59-60-61-62-63-64-65-66-67-68-69	Trunk weatherstrip exact profile	2DR 4DR HTP 2DR SDN CNV	58-64 Chevrolet Biscayne, 58-64 Chevrolet Bel Air, Chevrolet Impala, 60-69 Chevrolet Corvair, 59-64 Pontiac Pariseinne, 59-64 Pontiac Catalina, 59-64 Pontiac Star Chief, 60-61 Pontiac Ventura, 62-64 Pontiac Grand Prix, 58-64 Oldsmobile Delta 88, 58-64 Oldsmobile Dynamic 88, Oldsmobile Super 88, Oldsmobile Super 98, 61-64 Oldsmobile Starfire, 64 Oldsmobile Jetstar, 59-64 Buick LeSabre, 59-62 Buick Invicta, 59-64 Buick Electra, 62-64 Buick Wildcat, 63-65 Buick Riviera, 58-60 Cadillac Deville, Cadillac Eldorado, Cadillac Series 62, Cadillac Series 60 Special, Cadillac Series 75, 58-64 C-Body	2001

Pontiac • Ventura

CODE	IMAGE	YEAR	DESCRIPTION	BODY	FITS	ITEM#
T		64-65-66-67-68-69-70-71-72-73-74-75-76-77	Trunk weatherstrip exact profile length 17 feet	2DR 4DR HTP 2DR SDN CNV	65-72 Chevy II, 65-72 Chevrolet Biscayne, 65-75 Chevrolet Bel Air, 65-76 Chevrolet Impala, 65-76 Chevrolet Caprice, 64-77 Chevrolet Chevelle, 70-77 Chevrolet Monte Carlo, 65-76 Buick LeSabre, 64-77 Buick Wildcat, 64-77 Buick Skylark, 71-73 Buick Centurion, 64-72 Buick Grand Special, 73-77 Buick Century, 73-88 Buick Regal, 73-88 Buick Grand National, 65-76 Buick Electra, 65-76 Oldsmobile Delta 88, 67-69 Oldsmobile Delmont 88, 65-66 Oldsmobile Dynamic 88, 65-66 Oldsmobile Starfire, 65 Oldsmobile Jetstar, 64-77 Oldsmobile Cutlass 442, 64-88 Oldsmobile Cutlass, 65-76 Oldsmobile 98, 65-76 Pontiac Parisienne, 64-72 Pontiac LeMans, 65-70 Pontiac Catalina, 65-66 Pontiac Star Chief, 67-70 Pontiac Executive, 71-75 Pontiac Grand Ville, 65-77 Pontiac Grand Prix, 64-72 Pontiac Tempest, 62-72 Nova, Ventura, 73-74 Non-Hatchback, Up to 1975 with groove channel, Apollo, Nova, Omega, Ventura 65-76 C-Body	2003
T		73-74	Hatchback weatherstrip	2DR CPE	73-74 Buick Apollo, Chevrolet Nova, Oldsmobile Omega, Pontiac Ventura, 2 Door Coupe	4013
T		75-76-77-78-79-80-81-82-83-84-85-86-87-88-89-90-91-92	Trunk and Hatchback weatherstrip	2DR 4DR SDN HTP CNV	77-85 Chevrolet Impala, 77-91 Chevrolet Caprice, 82-92 Chevrolet Camaro, 75-79 Chevrolet Nova, 78-88 Chevrolet Monte Carlo, 78-83 Chevrolet Malibu, 78-83 Pontiac LeMans, 82-92 Pontiac Firebird, 75-91 Pontiac Ventura, 77-86 Pontiac Parisienne, 77-81 Pontiac Catalina, 69-88 Pontiac Grand Prix, 64-87 Pontiac LeMans, Pontiac Grand Am, 64-77 Pontiac GTO, 73-79 Oldsmobile Omega, 77-85 Oldsmobile Delta 88, 77-84 Oldsmobile 98, 77-88 Oldsmobile Cutlass, 73-75 Buick Apollo, 76-79 Buick Skylark, 77-79 Phoenix, 73-88 Buick Regal, 77-84 Buick Electra, 77-85 Buick LeSabre, 77-78 Buick Riviera, 77-91 C-Body	2424
W		37-38-39-40-41-42-43-44-45-46-47-48-49-50-51-52-53-54	Mohair channel liner, 4 feet of 2 7/8 inch mohair lining material	CNV 2DR 4DR HTP	Bel Air 150 210, Nomad, Chieftain, 860/870 Star Chief, Safari, Super Chief, Bonneville, Nova, Omega, Apollo, Ventura, Skylark	0420
W		58-59-60-61-62-63-64	Quarter window seals	2DR HTP CNV	58-64 Chevrolet Impala, 58, 60-62 Bel Air, 58-64 Cadillac Series 62, Deville, Eldorado, 58 Oldsmobile 88 Oldsmobile 98, 59-60 Oldsmobile 88 Oldsmobile 98, 61-64 Oldsmobile 99, Starfire, 98, 64 Jetstar, 59-62 Buick LeSabre, Invicta, Electra 2 Door Hardtop Convertible	2300
W		61-62	Vent window seals	2DR 4DR HTP CNV	61-62 Chevrolet Bel Air, Impala, 61-62 Cadillac Series 62, Eldorado, 61-62 Oldsmobile 88 Oldsmobile 98, 61-62 Buick LeSabre, Invicta, Electra, 61-62 Pontiac Bonneville, Catalina, Ventura 2 Door 4 Door Hardtop, Convertible	21615













GUIDE TO SOFFSEAL'S PRODUCT CODES

B = Bumper sets **C** = Glass channels **D** = Door related **G** = Seals, gaskets **H** = Under hood items **I** = Interior parts
M = Miscellaneous items **R** = Roofrail, pillar post & convertible items **T** = Trunk related **W** = Window related **Z** = Weatherstrip kits



CODE	IMAGE	YEAR	DESCRIPTION	BODY	FITS	ITEM#
W		61-62-63-64-65-66	Horizontal outer window seals	2DR 4DR HTP SDN CNV SWG	Chevy Biscayne, Bel Air, Impala, Caprice, Cadillac series 62 Deville, Eldorado, Fleetwood, Calais, Oldsmobile 88, Starfire, 98. Buick Lesabre, Invicta, Wildcat, Electra, Pontiac Catalina, Ventura, Star Chief, Bonneville	2310

Performance Chrysler • Dodge, Plymouth

CODE	IMAGE	YEAR	DESCRIPTION	BODY	FITS	ITEM#
B		63-64-65-66-67-68-69-70-71-72-73-74	Tailgate bumper	TRK	63-74 Dodge Truck	CH9032
B		64	Hood side bumpers	ALL BODY STYLES	64 Dodge Chrysler Plymouth, All Except Valiant	CH1031
B		64-65-66-67-68-69-70	Rear hood bumpers	ALL BODY STYLES	64 Dodge 22, 440, Polara, 65-70 Coronet, 66-70 Charger, 68 Super Bee, 69 Daytona, 70 Challenger, Plymouth 64 Fury, 65-70 Belvedere, Satellite, 67-70 Gtx, 68-70 Road Runner, 70 Cuda, Barracuda	CH2006
B		64-65-66-67-68-69-70-71-72-73-74	Hood adjustment bumpers	ALL BODY STYLES	64-72 Dodge Dart, 64 330, 440, Polara, 65-70 Coronet, 66-70 Charger, 68 Super Bee, 69 Daytona, 70-72 Challenger, 71-72 Demon, Swinger, Plymouth 64-72 Valiant, Barracuda, 64 Fury, 65-70 Belvedere, Satellite, 67-70 Gtx, 68-70 Roadrunner, 70-72 Cuda	CH1010
B		66-67-68-69-70-71-72-73-74	Trunk bumpers	ALL BODY STYLES	66-74 Dodge Dart, 66-70 Coronet, Charger, 68 Super Bee, 69 Daytona, 71-71 Demon, 71-74 Swinger, 73 Dart Sport, 66-74 Plymouth 66-74 Valiant, 66-69 Barracuda, 66-70 Bevedere, Satellite, 67-70 Gtx, 68-70 Road Runner, 70-74 Duster 71-74 Scamp	CH1006
B		67	Hood bumper	TRK	67 Dodge Truck	CH9033
B		67-68-69-70	Door bumpers rounded	ALL BODY STYLES	67-70 Dodge Dart, Coronet, Charger, 68 Super Bee, 69 Daytona, 70 Challenger, 67-70 Plymouth Valiant, Barracuda, Satellite, Gtx, 68-70 Road Runner, 70 Duster, Cuda	CH1007
B		67-68-69-70-71	Hood side bumpers	ALL BODY STYLES	67-71 Dodge Dart, 71 Demon Swinger, Plymouth 67-71 Valiant, 67-69 Barracuda, 70-71 Duster, 71 Scamp	CH1008
B		67-68-69-70-71-72-73-74-75-76	Glove box bumpers all models	ALL BODY STYLES	64-76 Dodge Dart, 64 330, 440, Polara, 65-70 Coronet, 66-70 Charger, 68 Super Bee, 69 Daytona, 70-74 Challenger, 71-72 Demon, 73 Dart Sport, 71-76 Swinger, 75-76 Dart Sport, 64-76 Plymouth Valiant, 64-74 Barracuda, 64 Fury, 65-70 Belvedere, Satellite,	CH1069
B		68-69-70	Hood side front corner bumper	ALL BODY STYLES	68-70 Charger	CH2008
B		68-69-70	Trunk bumpers	2DR HTP 2DR SDN CNV 4DR HTP	68-70 Plymouth	CH2009
B		68-69-70-71	Hood side bumper	ALL BODY STYLES	68-70 Dodge Coronet, Charger, 68 Super Bee, 69 Daytona, Plymouth 68-70 Belvedere, 68-71 Satellite, Road Runner	CH2005



GUIDE TO SOFFSEAL'S PRODUCT CODES

B = Bumper sets **C** = Glass channels **D** = Door related **G** = Seals, gaskets **H** = Under hood items **I** = Interior parts
M = Miscellaneous items **R** = Roofrail, pillar post & convertible items **T** = Trunk related **W** = Window related **Z** = Weatherstrip kits

Performance Chrysler • Dodge, Plymouth



CODE	IMAGE	YEAR	DESCRIPTION	BODY	FITS	ITEM#
B		68-69-70-71-72-73-74	Trunk bumpers	2DR HTP 2DR SDN CNV	68-74 Dodge Dart, 68-70 Coronet, 68 Super Bee, 68-70 Charger, 69 Daytona, 70-74 Challenger, 71-72 Demon, 71-74 Swinger, 73 Dart Sport, 71-74 Plymouth Valiant, Scamp, Duster, Cuda, Barracuda	CH2002
B		69	Trunk bumpers	2DR HTP CNV	69 Coronet	CH2003
B		70-71-72-73-74	Hood side bumper	2DR HTP CNV	70-74 Barracuda	CH3006
B		70-71-72-73-74	Hood side front corner bumper	2DR HTP CNV	70-74 Challenger	CH3007
B		71-72	Door bumper	ALL BODY STYLES	71-72 Dodge Demon, Dart Swinger, Challenger, Plymouth Valiant, Duster, Scamp, Barracuda	CH1012
B		71-72-73-74	Hood side bumper	ALL BODY STYLES	71-74 Dodge Dart, Swinger, 71-72 Demon, 73 Dart Sport, Plymouth 71-74 Valiant Duster, Scamp	CH1009
B		72-73	Door bumpers rectangle	ALL BODY STYLES	73-73 Dodge Dart, Swinger, Challenger, 72 Demon, 73 Dart Sport, Plymouth 72-73 Valiant, Scamp, Duster, Cuda, Barracuda,	CH1013
C		63-64-65-66	Front glass channel	2DR HTP SDN SWG	63 Dodge Dart, Plymouth 63-66 Valiant, 64-66 Barcuda, 2 Door Hardtop Sedan Station Wagon	CH1403
C		64-65	Windshield gasket with chrome trim	ALL BODY STYLES	64-65 Dodge Coronet, Polara, Belvedere, 64 Fury, 65 Satellite 2 Door Hardtop Sedan	CH2085
C		64-65	Windshield gasket with chrome trim	CNV	64-65 Dodge Coronet, Polara, Plymouth Fury, Belvedere, Satellite, Convertible	CH2087
C		66-67	Windshield gasket	2DR HTP	66-67 Dodge Charger, Coronet, Plymouth Belvedere, Satellite, 2 Door Hardtop Sedan	CH2088
C		66-67	Rear window gasket	2DR HTP	66-67 Dodge Coronet, Plymouth Belvedere, Satellite, 2 Door Hardtop	CH2086
C		67-68-69	Windshield gasket with locking strip	CNV	67-69 Dodge Dart, Plymouth Barracuda Convertible	CH1404
C		67-68-69	Rear glass channel	2DR HTP	67-69 Barracuda Fastback, 2 Door Hardtop	CH1402
C		67-68-69	Rear glass channel	2DR HTP	67-69 Barracuda Sport Coupe Notchback, 2 Door Hardtop	CH1057
C		68-69-70	Windshield gasket	ALL BODY STYLES	68-70 Dodge Coronet, Charger, 68 Super Bee, 69 Daytona, 68-70 Plymouth Belvedere, Satellite, Gtx, Road Runner, 2 Door Hardtop Sedan	CH2080
C		68-69-70	Glass channel front	CNV	68-70 Dodge Coronet, Plymouth Road Runner, Satellite, Convertible	CH2401

Performance Chrysler • Dodge, Plymouth

CODE	IMAGE	YEAR	DESCRIPTION	BODY	FITS	ITEM#
C		68-69-70-71-72-73-75-76	Glass channel rear	2DR HTP	68-76 Dodge Dart, 2 Door Hardtop	CH1400
C		68-69-70-71-72-73-75-76	Glass channel front	2DR HTP	68-76Chry A Body 68-69 Barracuda,68-76Dart Swinger,Valiant 2 Door Hardtop	CH1401
C		70	Paint gasket set	2DR HTP CNV	70 Challenger	CH3041
C		70-71-72-73-74-75-76	Windshield weatherstrip channel	2DR HTP	71-76 Demon Dart Sport/70-76 Duster Custom, 2 Door Hardtop	CH1405
C		71-72-73-74-75-76	Rear glass channel	2DR HTP	71-76 Dart Sport Demon, 73 Duster, 2 Door Hardtop	CH1026
D		61-62-63-64-65-66-67-68-69-70-71-72-73-74-75-76	Door weatherstrip fits on body a&b body, black other colors available by special order	2DR HTP CNV	63-76 Dodge Dart, 61-62 Dodge Lancer, Plymouth Valiant, 62 Dodge Dart, Polara, 330, Coronet, Plymouth Savoy, Belvedere, Fury, 2 Door Hardtop Convertible	CH1016
D		62-63-64-65-66	Door weatherstrip fits on body a&b body, black other colors available by special order	2DR SDN	63-67 Dodge Dart, 61-62 Dodge Lancer, Plymouth Valiant, 62 Dodge Dart, Polara, 330, Coronet, Plymouth Savoy, Bevedere, Fury,, 2 Door SDN	CH1017
D		66-67	Door weatherstrip with clips	2DR HTP CNV	66-67 Dodge Charger, Coronet, Plymouth Satellite, 2 Door Hardtop Convertible	CH2105
D		66-67	Door seal end cap	2DR HTP CNV	Dodge Charger, Coronet, Plymouth Belvedere, Satellite, Gtx, 2 Door Hardtop Convertible	CH2013
D		67-68-69	Door weatherstrip	2DR SDN	67-69 Dodge Dart, Plymouth Valiant, 2 Door Sedan	CH1014
D		68-69-70	Door weatherstrip with clips & molded ends	2DR HTP CNV	68-70 Satellite Gtx Roadrunner Coronet R/T And Super Bee, Convertible, 2 Door with Pop Out Side Quarter Window	CH2010
D		70-71-72	Door weatherstrip with clips	2DR HTP	70-72 Dodge Demon, Plymouth Duster	CH1028
D		70-71-72	End Cap Filler	2DR HTP	70-72 Dodge Demon, Plymouth Duster	CH1039
D		70-71-72-73-74	Chrysler e-body door weatherstrip with clips	2DR HTP CNV	70-74 Challenger, Barracuda, 2 Door Hardtop, Convertible	CH3500
D		71-72-73-74	Door weatherstrip with clips	2DR HTP	71-74 Dodge Charger, Charger Se, Plymouth Belvedere, Satellite, Roadrunner, Gtx	CH2116
D		73-74-75-76	Door weatherstrip with clips & molded ends	2DR HTP	73-76 Dodge Dart Swinger, Plymouth Duster, Valiant, Scamp 2 Dr Hardtop	CH1021
D		78-79-80-81-82-83-84-85-86-87-88-89-90-91-92-93	Door weatherstrip	TRK	78-93 Fullsize Dodge Truck	CH9010

















GUIDE TO SOFFSEAL'S PRODUCT CODES
B = Bumper sets **C** = Glass channels **D** = Door related **G** = Seals, gaskets **H** = Under hood items **I** = Interior parts
M = Miscellaneous items **R** = Roofrail, pillar post & convertible items **T** = Trunk related **W** = Window related **Z** = Weatherstrip kits

Performance Chrysler • Dodge, Plymouth



CODE	IMAGE	YEAR	DESCRIPTION	BODY	FITS	ITEM#
G		00-99	Backup light lens gaskets	ALL BODY STYLES	Chrysler All B Body	CH2213
G		00-99	Axle bearing retainer gasket for 8 3/4 inch, 9 1/4 inch, 9 3/4 inch rear end	ALL BODY STYLES	All Chrysler	CH1030
G		62-63-64-65	Master cylinder to plate gasket	ALL BODY STYLES	62-65 Dodge 330, 440, Polara, 65 Coronet, 62,63,65 Plymouth Belvedere, 62-64 Fury, 62-63 Sport Fury, 65 Satellite	CH2323
G		62-63-64-65	Master cylinder bracket to cowl gasket	ALL BODY STYLES	62-64 Dodge 330, 440, Polara, 65 Coronet, 62,63,65 Belvedere, 62-64 Fury, 62-63 Sport Fury, 65 Satellite	CH2324
G		62-63-64-65	Master cylinder to plate gaskets	ALL BODY STYLES	62-64 Dodge 330, 440, Polara, 65 Coronet, 62,63,65 Belvedere, 64 Fury, 62-63 Sport Fury, 65 Satellite	CH2325
G		62-63-64-65	Splash shields brake line	ALL BODY STYLES	62-64 Dodge Polara, 330, 440, 65 Coronet, 62, 63, 65 Plymouth Belvedere, 62-64 Fury, 62-63 Sport Fury, 65 Satellite	CH2315
G		62-63-64-65	Splash shield -rear frame	ALL BODY STYLES	62-64 Dodge Polara, 330, 440, 54 Rolara, 65 Coronet, 62, 63, 65 Belvedere, 62-64 Fury, 62-63 Sport Fury, 65 Belvedere, Satellite	CH2316
G		62-63-64-65	Splash shield starter	ALL BODY STYLES	62-64 Dodge Polara, 330, 440, 65 Coronet, 62,63,65, Plymouth Belvedere, 62-64 Fury, 62-63 Sport Fury, 65 Satellite	CH2317
G		62-63-64-65	Backup lamp housing to body seals	ALL BODY STYLES	62-65 Plymouth B-Body	CH2329
G		62-63-64-65	Splash shields strut	ALL BODY STYLES	62-65 Chrysler B-Body	CH2330
G		63-64-65	Reverse light, gaskets	ALL BODY STYLES	63-65 33, 440, Fury, Coronet	CH2321
G		64	Taillamp lens gaskets	2DR HTP	64 Plymouth Fury	CH2322
G		64	Splash shield front fender top rear	ALL BODY STYLES	64 Plymouth B Body	CH2318
G		64	Splash shield front fender top front	ALL BODY STYLES	64 Plymouth B Body	CH2319
G		64	Taillamp housing gaskets	2DR HTP	64 Plymouth Fury	CH2320
G		64	Parklight lens gaskets	ALL BODY STYLES	64 Plymouth B-Body	CH2331
G		64-65	Steering column seal	ALL BODY STYLES	64-65 Chrysler B Body	CH2208

Performance Chrysler • Dodge, Plymouth

CODE	IMAGE	YEAR	DESCRIPTION	BODY	FITS	ITEM#
G		64-65-66-67-68-69-70-71-72-73-74	Antenna gasket	ALL BODY STYLES	67-74 Dodge Dart, 64 330, Polara, 440, 65-70 Charger, 68 Super Bee, 69 Daytona, 70-74 Challenger, 71-74 Swinger, 67-74 Plymouth Valiant, Barracuda, 64 Fury, 65-70- Bevedere, Satellite, 67-70 Gix, 68-70 Road Runner, 70-74 Duster, Cuda, 71-74 Scamp	CH1025
G		66-67	Rear body to bumper seal	2DR HTP	66-67 Dodge Charger	CH2115
G		66-67-68-69-70	Door & trunk lock gaskets	2DR HTP 2DR SDN CNV	66-70 Dodge Dart, 66-70 Plymouth Valiant, 66-69 Barracuda, 70 Duster 70-74 E Body	CH1019
G		66-67-68-69-70	Accelerator pedal seal	ALL BODY STYLES	66-70 B Body Chrysler	CH2053
G		66-67-68-69-70-71-72-73-74	Power brake booster to firewall gasket	2DR HTP 2DR SDN CNV	66-74 Dodge Dart, 66-70 Coronet, Charger, 68 Super Bee, 70-74 Challenger, 71-72 Demon, 71-74 Swinger, 73 Dart Sport, 66-74 Plymouth Valiant, Barracuda, 66-70 Belvedere, Satellite, 67-70 GTX, 68-70 Road Runner, 70-74 Duster, Cuda, 71-74 Scamp	CH1053
G		66-67-68-69-70-71-72-73-74	Master cylinder gasket, standard and pwr brake, plus universal and street rod & custom	2DR HTP 2DR SDN CNV SR	66-74 Dodge Dart, 66-70 Coronet, Charger, 68 Roadrunner, Super Bee, 69 Daytona, 70-74 Challenger, 71-72 Demon, 71-74 Swinger, 73 Dart Sport, 66-74 Plymouth Valiant, Barracuda, 66-70 Belvedere, Satellite 67-69 Gtx, 7-74 Duster, Cuda, 71-74 Scamp,	CH1054
G		67	Steering column seal	ALL BODY STYLES	67 Dart, Valiant Barracuda	CH1201
G		67-68-69-70	Door handle gasket set	2DR HTP 2DR SDN CNV	67-70 Dodge Coronet, Charger, 68 Super Bee, 69 Daytona, Plymouth 67-70 Belvedere, Satellite Gtx, 68-70 Road Runner	CH1015
G		67-68-69-70	Mirror gasket all models	ALL BODY STYLES	67-70 Dodge Dart, Coronet, Charger, 68 Super Bee, 69 Daytona, 70 Challenger, 67-70 Plymouth Valiant, Barracuda, Belvedere, Satellite, GTX 68-70 Road Runner, 70 Duster, Cuda	CH2030
G		68	Taillight lens gaskets	2DR HTP	68 Charger	CH2046
G		68	Taillight lens gaskets	2DR HTP	68 Coronet	CH2054
G		68	Taillight lens gaskets	2DR HTP	68 Roadrunner	CH2055
G		68	Paint gasket set	2DR HTP	68 Charger	CH2037
G		68	Paint gasket set	2DR HTP	68 Coronet Super Bee	CH2038





















GUIDE TO SOFFSEAL'S PRODUCT CODES					
B = Bumper sets	C = Glass channels	D = Door related	G = Seals, gaskets	H = Under hood items	I = Interior parts
M = Miscellaneous items	R = Roofrail, pillar post & convertible items	T = Trunk related	W = Window related	Z = Weatherstrip kits	

Performance Chrysler • Dodge, Plymouth



CODE	IMAGE	YEAR	DESCRIPTION	BODY	FITS	ITEM#
G		68	Paint gasket set	2DR HTP	68 Roadrunner Gtx Satellite	CH2039
G		68	Reverse light, gaskets	ALL BODY STYLES	68 Charger	CH2051
G		68	Paint gasket set	2DR HTP	68 Dodge Dart	CH1037
G		68-69	Taillight lens gaskets	2DR HTP	68-69 Dodge Dart	CH1036
G		68-69	Park light lens gaskets	2DR HTP CNV	68-69 Belvedere Roadrunner Satellite	CH2091
G		68-69	Park light lens gaskets	2DR HTP CNV	68-69 Charger	CH2092
G		68-69-70	Steering column seal	ALL BODY STYLES	68-70 B Body Chrysler	CH2209
G		68-69-70	Inner fender to firewall seals	ALL BODY STYLES	68-70 Dodge Coronet, 68 Super Bee, 69 Daytona, 68-70 Plymouth Belvedere, Satellite, Gtx, Road Runner	CH2211
G		68-69-70-71-72-74	License plate lens gasket	ALL BODY STYLES	68-74 Chrysler B Body Except 68-70 Charger	CH2210
G		69	Paint body gasket set	2DR HTP	69 Charger	CH2040
G		69	Paint gasket set	2DR HTP	69 Super Bee Coronet	CH2041
G		69	Paint body gasket set	2DR HTP	69 Roadrunner	CH2042
G		69	Taillamp lens gaskets	2DR HTP	69 Plymouth Gtx	CH2056
G		69	Taillight lens gasket	ALL BODY STYLES	69 Roadrunner Satellite	CH2047
G		69	Paint gasket set	2DR HTP	69 Dodge Dart	CH1038
G		69-70	Taillight lens gaskets	2DR HTP CNV	69-70 Charger	CH2093
G		70	Taillight lens gaskets	2DR HTP CNV	70 Roadrunner	CH2094
G		70	Parklight lens gaskets	2DR HTP CNV	70 Roadrunner	CH2095

Performance Chrysler • Dodge, Plymouth

CODE	IMAGE	YEAR	DESCRIPTION	BODY	FITS	ITEM#
G		70	Taillight lens gaskets taillight, housing body seal standard	ALL BODY STYLES	70 Belvedere Satellite	CH2036
G		70	Taillight lens gaskets	2DR HTP	70 Coronet Super Bee	CH2057
G		70	Paint body gasket set	2DR HTP	70 Charger	CH2043
G		70	Paint body gasket set	2DR HTP	70 Super Bee Coronet	CH2044
G		70	Paint body gasket set	2DR HTP	70 Belvedere Satellite	CH2045
G		70	Reverse light, gaskets	2DR HTP CNV	70 Plymouth Gtx	CH2327
G		70	Mirror gasket all	2DR HTP CNV	70 Challenger Barracuda	CH3030
G		70	Taillight lens gaskets	2DR HTP CNV	70 Challenger	CH3050
G		70-71	Taillight lens gasket	2DR HTP CNV	70-71 Barracuda	CH3048
G		70-71	Side marker gasket set front & rear	2DR HTP CNV	70-71 Challenger	CH3052
G		70-71	Paint gasket set	2DR HTP CNV	70-71 Cuda	CH3040
G		70-71-72-73-74	Heater duct seal non a/c	2DR HTP CNV	70-74 Challenger Barracuda	CH3033
G		70-71-72-73-74	Door handle gasket set	2DR HTP CNV	70-74 E Body Chrysler	CH3015
G		70-71-72-73-74	Steering column seal	2DR HTP CNV	70-74 E Body Chrysler	CH3209
G		70-71-72-73-74	Blower motor seal non-a/c	2DR HTP CNV SR	70-74 Chrysler E Body, Universal Fit Street Rod And Custom	CH3403
G		70-71-72-73-74	Park light lens gaskets	2DR HTP CNV	70-74 Challenger 70 Charger	CH2090
G		71	Sport mirror gasket left side	ALL BODY STYLES	71 Barracuda, Challenger	CH2031L
G		71	Sport mirror gasket right, side	ALL BODY STYLES	71 Barracuda, Challenger	CH2031R



















GUIDE TO SOFFSEAL'S PRODUCT CODES
B = Bumper sets **C** = Glass channels **D** = Door related **G** = Seals, gaskets **H** = Under hood items **I** = Interior parts
M = Miscellaneous items **R** = Roofrail, pillar post & convertible items **T** = Trunk related **W** = Window related **Z** = Weatherstrip kits

Performance Chrysler • Dodge, Plymouth



CODE	IMAGE	YEAR	DESCRIPTION	BODY	FITS	ITEM#
G		71	Park lens gaskets	2DR HTP CNV	71 Barracuda	CH3047
G		71	Taillight lens gaskets	2DR HTP CNV	71 Challenger	CH3049
G		71	Tail lens to body seal	2DR HTP CNV	71 Challenger	CH3044
G		71	Paint gasket set	2DR HTP CNV	71 Challenger	CH3045
G		72-73-74	Paint gasket set	2DR HTP CNV	72-74 Barracuda	CH3046
G		72-73-74	Paint gasket set	2DR HTP CNV	72-74 Challenger	CH3042
G		72-73-74	Tail lens to body seal	2DR HTP CNV	72-74 Barracuda	CH3043
G		72-73-74	Taillight lens gaskets	2DR HTP CNV	72-74 Challenger	CH3051
G		78-79	Park Light Gasket	2 Dr Htp	78-79 Chrysler	CH4002
H		62-63-64-65	Front hood to radiator support seal narrow type with clips installed	2DR SDN 2DR 4DR HTP CNV SWG	62-65 Dodge, Plymouth B Body, With Small Block	CH2023
H		62-63-64-65	Front hood to radiator support seal wide type with clips installed	2DR SDN 2DR 4DR HTP CNV SWG	62-65 Dodge, Plymouth, B Body, With Big Block Or Ac	CH2024
H		62-63-64-65-66	Hood to cowl seal	2DR SDN 2DR HTP CNV SWG	62-65 Dodge Dart, Polara, Plymouth Valiant, Savoy, Belvedere	CH2076
H		63-64-65-66	Hood to cowl seal original with clips installed	2DR SDN 2DR HTP CNV SWG	63-66 Dodge Dart, Plymouth Valiant	CH1034
H		64-65-66-67-68-69-70-71-72-73-74	Hood insulation clips	ALL BODY STYLES	64-74 Dodge Dart, 64 330, 440, Polara, 65-70 Coronet, Charger, 68 Super Bee, 69 Daytona, 70-74 Challenger, 71-72 Demon, 71-74 Swinger, 73 Dart Sport, 64-74 Plymouth Valiant, Barracuda, 64 Fury, 65-70 Belvedere, 65-70 Satellite, 67-70 Gtx, 68-70 Road R	CH2069
H		66-67	Front hood to radiator support seal with clips installed	2DR SDN 2DR 4DR HTP CNV SWG	66-67 Dodge Plymouth B Body	CH2025
H		66-67	Hood insulation	ALL BODY STYLES	66-67 Dodge Coronet, Charger, 66-67 Plymouth Belvedere, Satellite, 67 Gtx	CH2058

Performance Chrysler • Dodge, Plymouth

















CODE	IMAGE	YEAR	DESCRIPTION	BODY	FITS	ITEM#
H		66-67-68-69-70	Hood to cowl seal with clips installed	2DR SDN 2DR 4DR HTP CNV SWG	66-70 Dodge Plymouth B Body	CH2011
H		66-67-68-69-70	Hood to cowl seal with clips	ALL BODY STYLES	66-70 B Body Chrysler	CH2077
H		66-68-69-70	Splash guard seals with clips	ALL BODY STYLES	66-70 Dodge Coronet, Charger, 68 Super Bee, 69 Daytona, 66-70 Plymouth Belvedere, Satellite, 67-70 Gtx, 68-70 Road Runner	CH2070
H		67-68-69-70	Hood to cowl seal	2DR HTP	63-74 Dodge Dart Valiant 70-74 Duster And Swinger	CH1064
H		67-68-69-70-71-72	Front hood to radiator support seal with clips installed	2DR SDN 2DR 4DR HTP CNV SWG	67-72 Plymouth, Dodge, 67-69 Barracuda, Dart, 67-72 Valiant, 70-72 Duster, Demon	CH1406
H		67-68-69-70-71-72-73-74	Hood insulation with clips	2DR HTP	67-74 Barracuda Dart 70-74 Duster	CH1060
H		68	Trunk and under hood bumpers	2DR SDN 2DR HTP CNV	68 B Body Chrysler Except Charger, 70-74 Barracuda Rear Of Hood Center Bumper	CH2001
H		68-69	Hood insulation with clips	ALL BODY STYLES	68-69 Dodge Coronet, Charger, 68 Super Bee, 69 Daytona, 68-69 Plymouth Belvedere, Satellite, Gtx, Roadrunner	CH2059
H		68-69-70	Front hood to radiator support seal	ALL BODY STYLES	68-70 Dodge Coronet, Charger, 68 Super Bee, 69 Daytona, 68-70 Plymouth Belvedere, Satellite, Gtx, Road Runner	CH2072
H		70	Hood insulation with clips	ALL BODY STYLES	70 Dodge Coronet, Charger, 70 Plymouth Belvedere, Road Runner, Satellite, Gtx	CH2060
H		70-71	Front hood to radiator support seal with clips installed	2DR SDN 2DR 4DR HTP CNV SWG	70-71 Dodge Dart	CH1407
H		70-71	Front hood to radiator support seal with clips installed	2DR HTP CNV	70-71 Dodge Challenger, Plymouth Cuda	CH3020
H		70-71-72-73-74	Hood to cowl seal with clips installed	2DR HTP CNV	70-74 Dodge Challenger, Plymouth Cuda	CH3025
H		70-71-72-73-74	Hood to cowl seal with clips	2DR HTP CNV	70-74 Challenger, Barracuda	CH3008
H		70-71-72-73-74	Splash guard seals with clips	2DR HTP CNV	70-74 E Body Chrysler	CH3071
H		70-71-73-74	Hood insulation with clips	2DR HTP CNV	70-74 Challenger Barracuda	CH2062
H		71-72	Front hood to radiator support seals with clips installed	2DR SDN 2DR 4DR HTP CNV SWG	71-72 Dodge, Plymouth, B-Body	CH2026



GUIDE TO SOFFSEAL'S PRODUCT CODES						
B = Bumper sets	C = Glass channels	D = Door related	G = Seals, gaskets	H = Under hood items	I = Interior parts	
M = Miscellaneous items	R = Roofrail, pillar post & convertible items		T = Trunk related	W = Window related	Z = Weatherstrip kits	

Performance Chrysler • Dodge, Plymouth



CODE	IMAGE	YEAR	DESCRIPTION	BODY	FITS	ITEM#
H		71-72-73-74	Hood to cowl seal with clips installed	2DR SDN 2DR HTP CNV SWG	71-74 Dodge, Plymouth, B Body	CH2012
H		71-73-74	Hood insulation with clips	ALL BODY STYLES	71-74 Dodge Charger, 71-74 Plymouth Road Runner, Satellite	CH2061
H		72-73-74	Front hood to radiator support seal with clips installed	2DR HTP CNV	72-74 Dodge Challenger, Plymouth Cuda	CH3021
H		73-74	Front hood to radiator support seal with clips installed	2DR SDN 2DR 4DR HTP CNV SWG	73-74 Dodge, Plymouth, B Body	CH2027
H		73-74-75	Front hood to radiator support seal with clips installed	2DR SDN 2DR 4DR HTP CNV SWG	73-74 Duster, Demon, 72-75 Dart, 73-75 Valiant	CH1408
I		62-63-64-65	Accelerator shaft bracket to firewall seal	ALL BODY STYLES	62-65 Chrysler B-Body	CH2328
I		64-65-66-67-68-69-70	Sun visor tip	ALL BODY STYLES	64-70 Chrysler	CH4006
I		66-67-68-69-70-71-72-73-74-75-76-77-78-79-80	Park brake pedal pad	2DR 4DR HTP SDN SWG CNV TRK	71-79 Dodge B Body Charger R/T Se, Coronet, Super Bee 440, Magnum, Plymouth B Body Satellite, Belvedere, Gtx, Roadrunner, Cordoba, Fury, 66-74 C Body Plymouth Sport Fury I II Ili Vip, Manaca, Dodge Polara 500, Chrysler Cordoba, New Yorker, New Port 300,	CH2052
I		68-69-70	Shift boot with o console/pistol grip, 4 speed	2DR HTP 2DR SDN CNV	68-70 Dodge Coronet, Charger, 68 Super Bee, 69 Daytona, 68-70 Plymouth Belvedere, Satellite, Gtx, Road Runner	CH1090
I		69-70	Shift boot 4 speed with consle with out pistol grip	ALL BODY STYLES	69-70 Dodge Charger, Coronet, 69 Daytona, 69-70 Plymouth Belvedere, Satellite, Road Runner, Gtx	CH2098
I		72-73-74	Clutch & brake pad	ALL BODY STYLES	72-74 Chrysler A Body, 73-74 Chrysler B And E Body	CH1052
I		73-74	Automatic brake pedal pad	ALL BODY STYLES	72-74 Chrysler A, B & E Body	CH1055
M		63-64-65	Rear bumper seal	2DR SDN HTP CNV SWG	63-65 Plymouth Valiant Savoy Belvedere, 2 Door Sedan Hardtop Convertible Station Wagon	CH2078
M		65-66	Rear bumper seal	2DR SDN HTP CNV SWG	65-66 Plymouth Fury, C-Body, 2 Door Sedan Hardtop Convertible Station Wagon	CH2079
R		64-65	Roofrail weatherstip	2DR HTP	64-65 Dodge Dart 2 Door Hardtop	CH1033
R		64-65-66	Roofrail weatherstrip	2DR HTP	64-66 Plymouth Barracuda 2 Door Hardtop	CH1032

Performance Chrysler • Dodge, Plymouth

CODE	IMAGE	YEAR	DESCRIPTION	BODY	FITS	ITEM#
R		65-66-67	Roofrail weatherstrip	ALL BODY STYLES	65-67 Plymouth Coronet, Satellite, Road Runner, Gtx, 2 Door Hardtop	CH1020
R		65-66-67-68	Weatherstrip kit for convertible top without header seal	CNV	65-68 Chrysler C Body Convertible	CH4000
R		66-67	Roofrail weatherstrip	2DR HTP	66-67 Dodge Charger, 2 Door Hardtop	CH2107
R		66-67-68-69-70	Pillar post weatherstrip	CNV	66-70 Chrysler B Body Convertible	CH2017
R		66-67-68-69-70	Weatherstrip kit for convertible top	CNV	67-69 A Body 66-70 B Body Chrysler Convertible	CH1024
R		66-67-68-69-70	Convertible top header seal	CNV	67-69 A Body 66-70 B Body Chrysler Convertible	CH1027
R		66-67-68-69-70	Pillar post seals	CNV	66-70 Plymouth Belvedere, Satellite, Road Runner, Coronet, Gtx, Convertible	CH2114
R		67-68-69	Pillar post seals	CNV	67-69 Dodge Dart, Plymouth Barracuda, Convertible	CH1018
R		67-68-69-70-71-72	Roofrail with vent window	2DR HTP	67-72 Chrysler A Body Except Fastback 2 Door Hardtop	CH1029
R		68-69-70	Roofrail weatherstrip	2DR HTP	68-70 B Body Chrysler 2 Door Hardtop	CH2015
R		68-69-70	Roofrail weatherstrip	2DR SDN	68-70 B Body Chrysler, 2 Door Sedan	CH2016
R		70	Roofrail weatherstrip with molded ends	2DR HTP	70 Challenger Barracuda, 2 Door Hardtop	CH3016
R		70-71	Weatherstrip kit for convertible top	CNV	70-71 Chrysler E Body Convertible	CH3400
R		70-71	Header seal	CNV	70-71 Chrysler E Body Convertible	CH3401
R		70-71	Pillar post weatherstrip	CNV	70-71 Chrysler E Body Convertible	CH3402
R		70-71-72	Roofrail weatherstrip	2DR HTP	70-72 Plymouth Duster, Dodge Demon, 2 Door Hardtop	CH1035
R		71	Window weatherstrip	CNV	71 Dodge Barracuda, Plymouth Challenger, Convertible	CH3104
R		71-72-73-74	Roofrail weatherstrip with molded ends	2DR HTP	71-74 Challenger Barracuda, 2 Door Hardtop	CH3017



GUIDE TO SOFFSEAL'S PRODUCT CODES

















B = Bumper sets **C** = Glass channels **D** = Door related **G** = Seals, gaskets **H** = Under hood items **I** = Interior parts
M = Miscellaneous items **R** = Roofrail, pillar post & convertible items **T** = Trunk related **W** = Window related **Z** = Weatherstrip kits

Performance Chrysler • Dodge, Plymouth



CODE	IMAGE	YEAR	DESCRIPTION	BODY	FITS	ITEM#
R		71-72-73-74	Roofrail weatherstrip	2DR HTP	71-74 Dodge Charger, Except Se, Plymouth Satellite, Road Runner 2 Door Hardtop	CH2089
R		73-74	Roofrail weatherstrip	2DR HTP	73-74 Dodge Dart Swinger, Plymouth Scamp Valiant, 2 Door Hardtop	CH2110
R		73-74	Roofrail weatherstrip	2DR HTP	73-74 Dodge Charger Se, 2 Door Hardtop	CH2111
R		73-74-75-76	Roofrail weatherstrip	2DR HTP	73-76 Dodge Demon, Dart Sport, Plymouth Duster, 2 Door Hardtop	CH2109
T		64-65-66-67-68-69-70-71-72	Trunk weatherstrip	2DR HTP 2DR SDN CNV	64 Dodge 330, Dodge 440, Dodge Polara, 65-67 Dodge Coronet, 66-67 Dodge Charger, 64-mid 72 Dodge Dart, 68-71 Dodge Super Bee, 69 Dodge Daytona, 70-72 Challenger, 71-72 Dodge Demon, 69-72 Dodge Swinger, Plymouth 64 Fury, 65-67 Belvedere, 65-72 Satellite, 67-71 GTX, 64-69 Plymouth Barracuda Fastback, 64-72 Valiant, 64-69 Barracuda, 68-72 Road Runner, 72 Scamp, 70-72 Duster, 64-Mid 72 A-Body, 68-Mid 72 B-Body, 70-Mid 72 E-Body Chrysler	CH2004
T		66-67	Trunk mat	2DR HTP	66-67 Satellite Gtx	CH2306
T		66-67	Trunk mat	2DR HTP	66-67 Coronet R T	CH2307
T		67-68-69	Trunk mat	2DR HTP	67-69 Dodge Dart	CH1309
T		67-68-69	Trunk mat	2DR HTP	67-69 Barracuda Fastback	CH1310
T		68-69	Trunk mat	2DR HTP	68-69 Satellite Gtx	CH2308
T		68-69	Trunk mat	2DR HTP	68-69 Dodge Coronet Rt Except Charger	CH2309
T		68-69-70	Trunk mat	2DR HTP	68-70 Charger	CH2305
T		70	Trunk mat	2DR HTP	70 Satellite Gtx Road Runner	CH2310
T		70	Trunk mat	2DR HTP	70 Dodge Coronet Rt Superbee	CH2311
T		70	Trunk mat	2DR HTP	70 Dart	CH1312
T		70-71-72-73-74	Trunk mat	2DR HTP CNV	70-74 Dodge Challenger	CH3300

Performance Chrysler • Dodge, Plymouth

CODE	IMAGE	YEAR	DESCRIPTION	BODY	FITS	ITEM#
T		70-71-72-73-74	Trunk mat	2DR HTP CNV	70-74 Barracuda	CH3301
T		70-71-72-73-74-75-76	Trunk mat	2DR HTP	70-76 Plymouth Duster, 71-76 Dodge Dart, Demon	CH1311
T		71-72-73-74	Trunk mat	2DR HTP	71-74 B Body Chrysler	CH2312
T		72-73-74	Trunk weatherstrip	2DR HTP CNV 2DR SDN 4DR SDN	72-74 Dodge Charger, 72-74 Plymouth Satellite, 72-74 Plymouth Road Runner, 70-72 Plymouth Barracuda, 70-72 Dodge Challenger, 73-74 Dodge Dart Sport, 72 Dodge Demon, 72-72 Dodge Dart, 72-74 Plymouth Sport Duster, 73-74 B-Body, 72-74 E-Body	CH3302
W		62	Window weatherstrip	2DR HTP	62 Dodge 330, 440, Polara, Plymouth Savoy, Belvedere, 2 Door Hardtop	CH2120
W		62	Window weatherstrip	2DR SDN	62 Dodge 330, 440, Polara, Plymouth Savoy, Belvedere, 2 Door Sedan	CH2121
W		62	Window weatherstrip	CNV	62 Dodge 330, 440, Polara, Plymouth Savoy, Belvedere Convertible	CH2122
W		62	Window weatherstrip	2DR HTP	62 Plymouth Valiant 2 Door Hardtop	CH1108
W		63	Window weatherstrip	2DR HTP	63 Dodge 330, 440, Polara, Plymouth Savoy, Belvedere, 2 Door Hardtop	CH2123
W		63-64-65	Window weatherstrip	2DR SDN	63-65 Dodge 330, 440, 64 Polara, 65 Coronet, Plymouth Belvedere, 64 Fury, Savoy, 2 Door Sedan	CH2124
W		63-64-65	Window weatherstrip with flat bead on inside	2DR SDN	63-65 Dodge 330, 440, 64 Polara, 65 Coronet, Plymouth Belvedere, 64 Fury, Savoy, 2 Door Sedan	CH2125
W		63-64-65	Window weatherstrip	CNV	63-65 Dodge 330, 440, 64 Polara, 65 Coronet, Plymouth Belvedere, 64 Fury, Savoy, Convertible	CH2126
W		63-64-65-66	Window weatherstrip	CNV	63-66 Dodge Dart Convertible	CH1109
W		63-64-65-66	Window weatherstrip	2DR HTP	63-66 Plymouth Valiant 2 Door Hardtop	CH1110
W		63-64-65-66	Window weatherstrip	2DR SDN	63-66 Plymouth Valiant 2 Door Sedan	CH1111
W		63-64-65-66	Window weatherstrip	2DR HTP	63-66 Dodge Dart 2 Door Hardtop	CH1112
W		63-64-65-66	Window weatherstrip	2DR SDN	63-66 Dodge Dart 2 Door Sedan	CH1113





















GUIDE TO SOFFSEAL'S PRODUCT CODES



















B = Bumper sets **C** = Glass channels **D** = Door related **G** = Seals, gaskets **H** = Under hood items **I** = Interior parts
M = Miscellaneous items **R** = Roofrail, pillar post & convertible items **T** = Trunk related **W** = Window related **Z** = Weatherstrip kits

Performance Chrysler • Dodge, Plymouth



CODE	IMAGE	YEAR	DESCRIPTION	BODY	FITS	ITEM#
W		64-65	Window weatherstrip with round bead on inside	2DR HTP	64-65 Dodge 330, 440, 64 Polara, 65 Coronet, Plymouth Belvedere, 64 Fury, Savoy, 2 Door Hardtop	CH2127
W		64-65	Window weatherstrip with flat bead on inside	2DR HTP	64-65 Dodge 330, 440, 64 Polara, 65 Coronet, Plymouth Belvedere, 64 Fury, Savoy, 2 Door Hardtop	CH2128
W		64-65-66	Window weatherstrip original style	2DR HTP	64-66 Barracuda Fastback, 2 Door Hardtop	CH1103
W		64-65-66	Window weatherstrip	2DR HTP CNV	64-66 Dodge Dart Gt, 2 Door Hardtop Convertible Sedan	CH1104
W		66-67	Window weatherstrip, original style	2DR HTP	66-67 Dodge Coronet, Plymouth Belvedere, Satellite, Gtx 2 Door Hardtop	CH2096
W		66-67	Window weatherstrip original style	CNV	66-67 Dodge Coronet, Plymouth Belvedere, Satellite, Gtx, Convertible	CH2097
W		66-67	Window weatherstrip, original style	2DR HTP	66-67 Dodge Charger 2 Door Hardtop	CH2103
W		66-67	Window weatherstrip	2DR SDN	66-67 Dodge Coronet, Plymouth Belvedere, Satellite, 2 Door Sedan	CH2129
W		66-67	Qtr window u-jamb	2DR HTP CNV	66-67 Plymouth Belvedere, Satellite, Dodge Coronet, Charger, 2 Door Hardtop And Convertible	CH2113
W		67-68-69	Quarter window seals fastback	2DR HTP	67-69 Plymouth Barracuda, 68-70 B Body 2 Door Hardtop	CH2022
W		67-68-69	Window weatherstrip	2DR HTP	67-69 Plymouth Barracuda Notchback, 2 Door Hardtop	CH1105
W		67-68-69	Window weatherstrip	2DR SDN	67-69 Dodge Dart, Plymouth Valiant 2 Door Sedan	CH1115
W		67-68-69	Window weatherstrip original style	2DR HTP	67-69 Barracuda Fastback, 2 Door Hardtop	CH1099
W		67-68-69	Window weatherstrip original style	2DR HTP	67-69 Dodge Dart 2 Door Hardtop	CH1101
W		67-68-69	Cnv window weatherstrip original style	CNV	67-69 Dodge Dart Convertible	CH1102
W		67-68-69	Hardtop Quarter window seals	2DR HTP FASTBACK	67-69 Plymouth Barracuda, Fastback Hardtop	CH1022
W		67-68-69-70-71-72	Quarter window seals	2DR HTP CNV	67-72 Dart Barracuda Convertible Hardtop	CH1023
W		68	Window weatherstrip original style	CNV	68 Dodge Coronet, Super Bee, 500, Rt, Convertible	CH2101

Performance Chrysler • Dodge, Plymouth









CODE	IMAGE	YEAR	DESCRIPTION	BODY	FITS	ITEM#
W		68	Window weatherstrip	CNV	68 Plymouth Gtx, Satellite Convertible	CH2083
W		68-69-70	Vent window weatherstrip	2DR HTP	68-70 Dodge Satellite, Gtx, Coronet R/T, Super Bee, Plymouth Roadrunner, 2 Door Hardtop, Charger	CH2084
W		68-69-70	Window weatherstrip pop out rear window original style	2DR SDN	68-70 Dodge Super Bee, 500, Rt, Coronet, Plymouth Belvedere, Satellite, Road Runner, Gtx, 2 Door Sedan	CH2099
W		68-69-70	Window weatherstrip, except charger, original style	2DR HTP	68-70 Dodge Coronet Super Bee 500 Rt, 2 Door Hardtop	CH2100
W		68-69-70	Window weatherstrip original style	2DR HTP	68-70 Dodge Charger 2 Door Hardtop	CH2104
W		68-69-70	Window weatherstrip	2DR HTP	68-70 Plymouth Satellite, Road Runner, Gtx, 2 Door Hardtop	CH2082
W		69-70	Window weatherstrip, original style	CNV	69-70 Dodge Coronet, Rt Convertible	CH2102
W		69-70	Window weatherstrip	CNV	69-70 Plymouth Road Runner, Satellite, Gtx Convertible	CH2081
W		70	Quarter window seals, flocked	2DR HTP CNV	70 Barracuda, Challenger E Body, 2 Door Hardtop And Convertible	CH3022
W		70	Window weatherstrip original style	2DR HTP	70 Plymouth Barracuda, 2 Door Hardtop	CH3099
W		70	Window weatherstrip original style	CNV	70 Dodge Challenger, Plymouth Barracuda, Convertible	CH3103
W		70	Window weatherstrip original style	2DR HTP	70 Dodge Challenger 2 Door Hardtop	CH3101
W		70-71	Window weatherstrip	2DR HTP	70-71 Dodge Dart 2 Door Hardtop	CH1106
W		70-71-72	Window weatherstrip	2DR HTP	70-72 Dodge Demon, Plymouth Duster, 2 Door Hardtop	CH1107
W		71-72-73-74	Qtr window seals	2DR HTP	71-74 Dodge Charger, Except 73-74 Se, Plymouth Satellite, 2 Door Hardtop	CH2108
W		71-72-73-74	Window weatherstrip original style	2DR HTP	71-74 Dodge Challenger, 2 Door Hardtop	CH3102
W		71-72-73-74	Window weatherstrip original style	2DR HTP	71-74 Plymouth Barracuda 2 Door Hardtop	CH3100
W		71-72-73-74	Quarter window seals with metal insert	2DR HTP CNV	71-74 Barracuda, Challenger, E Body, 2 Door Hardtop And Convertible	CH3022A











GUIDE TO SOFFSEAL'S PRODUCT CODES
B = Bumper sets **C** = Glass channels **D** = Door related **G** = Seals, gaskets **H** = Under hood items **I** = Interior parts
M = Miscellaneous items **R** = Roofrail, pillar post & convertible items **T** = Trunk related **W** = Window related **Z** = Weatherstrip kits

Performance Chrysler • Dodge, Plymouth



CODE	IMAGE	YEAR	DESCRIPTION	BODY	FITS	ITEM#
W		71-72-73-74	Qtr window u-jamb	2DR HTP CNV	71-74 Plymouth Belvedere, Satellite, Dodge Coronet, Charger, 2 Door Hardtop And Convertible	CH2112
Z		68	Weatherstrip kit, includes door weatherstrips, roofrail weatherstrips, trunk weatherstrips, a arm seals, quarter window seals, hood to cowl seal, window weatherstrip, paint gasket kit	2DR HTP	68 Dodge Charger 2 Door Hardtop	KITCH230
Z		68	Weatherstrip kit, includes door weatherstrips, roofrail weatherstrips, trunk weatherstrips, a arm seals, quarter window seals, hood to cowl seal, window weatherstrip, paint gasket kit	2DR HTP	68 Dodge Coronet, Superbee, 500, Rt, 2 Door Hardtop	KITCH231
Z		68	Weatherstrip kit, includes door weatherstrips, roofrail weatherstrips, trunk weatherstrips, a arm seals, quarter window seals, hood to cowl seal, window weatherstrip, paint gasket kit	2DR HTP	68 Plymouth Belvedere, Satellite, Road Runner, Gtx , 2 Door Hardtop	KITCH232
Z		68	Weatherstrip kit, includes door weatherstrips, roofrail weatherstrips, trunk weatherstrips, a arm seals, hood to cowl seal, window weatherstrip, paint gasket kit	2DR SDN	68 Dodge Coronet, Superbee, 500, Rt, 2 Door Sedan	KITCH233
Z		68	Weatherstrip kit, includes door weatherstrips, roofrail weatherstrips, trunk weatherstrips, a arm seals, hood to cowl seal, window weatherstrip, paint gasket kit	2DR SDN	68 Plymouth Belvedere, Satellite, Roadrunner, Gtx, 2 Door Sedan	KITCH234
Z		68	Weatherstrip kit, includes pillar post seals, trunk weatherstrips, a arm seals, quarter window seals, hood to cowl seal, window weatherstrips, paint gasket kit, convertible top kit, door weatherstrips with clips	CNV	68 Dodge Coronet, Superbee, 500 R/T, Convertible	KITCH235
Z		68	Weatherstrip kit, includes pillar post seals, trunk weatherstrips, a arm seals, quarter window seals, hood to cowl seal, window weatherstrips, paint gasket kit, convertible top kit, door weatherstrip with clips	CNV	68 Plymouth Belvedere, Satellite, Roadrunner, Gtx , Convertible	KITCH236
Z		69	Weatherstrip kit, includes door weatherstrips, roofrail weatherstrips, trunk weatherstrips, a arm seals, quarter window seals, hood to cowl seal, window weatherstrip, paint gasket kit	2DR HTP	69 Dodge Charger 2 Door Hardtop	KITCH237

Performance Chrysler • Dodge, Plymouth

CODE	IMAGE	YEAR	DESCRIPTION	BODY	FITS	ITEM#
Z		69	Weatherstrip kit, includes door weatherstrips, roofrail weatherstrips, trunk weatherstrips, a arm seals, quarter window seals, hood to cowl seal, window weatherstrip, paint gasket kit	2DR HTP	69 Dodge Coronet, Super Bee 500 Rt, 2 Door Hardtop	KITCH238
Z		69	Weatherstrip kit, includes door weatherstrips, roofrail weatherstrips, trunk weatherstrips, a arm seals, quarter window seals, hood to cowl seal, window weatherstrip, paint gasket kit	2DR HTP	69 P Plymouth Belvedere, Satellite, Roadrunner, Gtx, 2 Door Hardtop	KITCH239
Z		69	Window weatherstrip kit, includes door weatherstrips, roofrail weatherstrips, trunk weatherstrips, a arm seals, hood to cowl seal, window weatherstrip, paint gasket kit	2DR SDN	69 Dodge Coronet, Super Bee, 500, Rt, 2 Door Sedan	KITCH240
Z		69	Weatherstrip kit, includes door weatherstrips, roofrail weatherstrips, trunk weatherstrips, a arm seals, hood to cowl seal, window weatherstrip, paint gasket kit	2DR SDN	69 Plymouth, Belvedere, Satellite, Road Runner, Gtx, 2 Door Sedan	KITCH241
Z		69	Weatherstrip kit, includes pillar post seals, trunk weatherstrips, a arm seals, quarter window seals, hood to cowl seal, window weatherstrips, paint gasket kit, convertible top kit, door weatherstrip with clips	CNV	69 Dodge Coronet, Super Bee, 500, Rt, Convertible	KITCH242
Z		69	Weatherstrip kit, includes pillar post seals, trunk weatherstrips, splash guard seals, quarter window seals, hood to cowl seal, window weatherstrips, paint gasket kit, convertible top kit, door weatherstrips with clips	CNV	69 Plymouth Belvedere, Satellite, Roadrunner, Gtx, Convertible	KITCH243
Z		70	Weatherstrip kit, includes door weatherstrips, roofrail weatherstrips, trunk weatherstrips, splash guard seals, quarter window seals, hood to cowl seal, window weatherstrip, paint gasket kit, door weatherstrips with clips	2DR HTP	70 Dodge Charger 2 Door Hardtop	KITCH244
Z		70	Weatherstrip kit, includes door weatherstrips, roofrail weatherstrips, trunk weatherstrips, splash guard seals, quarter window seals, hood to cowl seal, window weatherstrip, paint gasket kit	2DR HTP	70 Dodge Coronet, Superbee, 500, Rt, 2 Door Hardtop	KITCH245
Z		70	Weatherstrip kit, includes door weatherstrips, roofrail weatherstrips, trunk weatherstrips, splash guard seals, quarter window seals, hood to cowl seal, window weatherstrip, paint gasket kit	2DR HTP	70 Plymouth Belvedere, Satellite, Roadrunner, Gtx, 2 Door Hardtop	KITCH246









GUIDE TO SOFFSEAL'S PRODUCT CODES					
B = Bumper sets	C = Glass channels	D = Door related	G = Seals, gaskets	H = Under hood items	I = Interior parts
M = Miscellaneous items	R = Roofrail, pillar post & convertible items	T = Trunk related	W = Window related	Z = Weatherstrip kits	

Performance Chrysler • Dodge, Plymouth



CODE	IMAGE	YEAR	DESCRIPTION	BODY	FITS	ITEM#
Z		70	Weatherstrip kit, includes door weatherstrips, roofrail weatherstrips, trunk weatherstrips, splash guard seals, hood to cowl seal, window weatherstrip, paint gasket kit	2DR SDN	70 Dodge Coronet, Super Bee, 500, Rt, 2 Door Sedan	KITCH247
Z		70	Weatherstrip kit, includes door weatherstrips, roofrail weatherstrips, trunk weatherstrips, splash guard seals, hood to cowl seal, window weatherstrip, paint gasket kit	2DR SDN	70 Plymouth, Belvedere, Satellite, Road Runner, Gtx, 2 Door Sedan	KITCH248
Z		70	Weatherstrip kit, includes pillar post seals, trunk weatherstrips, splash guard seals, quarter window seals, hood to cowl seal, window weatherstrips, paint gasket kit, convertible top kit, door weatherstrips with clips	CNV	70 Dodge Coronet, Super Bee, 500, Rt, Convertible	KITCH249
Z		70	Weatherstrip kit, includes pillar post seals, trunk weatherstrips, splash guard seals, quarter window seals, hood to cowl seal, window weatherstrips, paint gasket kit, convertible top kit, door weatherstrips with clips	CNV	70 Plymouth Belvedere, Satellite, Roadrunner, Gtx Convertible	KITCH250
Z		70	Weatherstrip kit, includes door weatherstrips, roofrail weatherstrips, hood adj bumpers, door bumpers, glove box bumper, hood to cowl seal, window weatherstrip, paint gasket kit, trunk bumpers, hood side bumper, splash guard seals, trunk weatherstrip, trunk and under hood bumpers	2DR HTP	70 Plymouth Barracuda 2 Door Hardtop	KITCH300
Z		70	Weatherstrip kit, includes trunk weatherstrips, door bumpers, hood adj bumpers, glove box bumpers, trunk & under hood bumpers, trunk bumpers, hood side bumpers, hood to cowl seal, paint gaskets, splash guard seals, window weatherstrips, conv top kit, pillar post, chrysler e-body door weatherstrips with clips	CNV	70 Plymouth Barracuda Convertible	KITCH301
Z		70	Weatherstrip kit, includes door weatherstrips, roofrail weatherstrips, hood adj bumpers, door bumpers, glove box bumper, hood to cowl seal, window weatherstrip, paint gasket kit, trunk bumpers, hood side bumper, splash guard seals, trunk weatherstrip	2DR HTP	70 Dodge Challenger 2 Door Hardtop	KITCH302

Performance Chrysler • Dodge, Plymouth

CODE	IMAGE	YEAR	DESCRIPTION	BODY	FITS	ITEM#
Z		70	Weatherstrip kit, includes door weatherstrip, hood adj bumpers, door bumpers, glove box bumpers, trunk bumpers, hood side bumpers, hood to cowl seals, paint gasket seals, splash guard seals, window weatherstrip, pillar post weatherstrip, trunk weatherstrips, conv top kit, chrysler e-body door weatherstrips	CNV	70 Dodge Challenger Convertible	KITCH303
Z		70	Weatherstrip kit, includes trunk weatherstrip, quarter window seals, weatherstrip kit convertible, door weatherstrip, pillar post weatherstrip, paint body gasket set, splash guard seals, hood to cowl seal, window weatherstrip	CNV	70 Plymouth Belvedere, Satellite, Roadrunner, Gtx, Convertible	KITCH350
Z		71	Weatherstrip kit, includes door weatherstrips, roofrail weatherstrips, hood adj bumpers, door bumpers, glove box bumper, hood to cowl seal, window weatherstrip, paint gasket kit, trunk bumpers, hood side bumper, splash guard seals, trunk weatherstrip, trunk & under hood bumpers	2DR HTP	71 Plymouth Barracuda 2 Door Hardtop	KITCH304
Z		71	Weatherstrip kit, includes chrysler e-body door weatherstrip, hood adj bumpers, door bumpers, glove box bumpers, trunk bumpers, hood side bumpers, hood to cowl seals, paint gasket seals, splash guard seals, window weatherstrip, pillar post weatherstrip, trunk weatherstrips, trunk & under hood bumpers, conv top kit	CNV	71 Plymouth Barracuda Convertible	KITCH305
Z		71	Weatherstrip kit, includes door weatherstrips, roofrail weatherstrips, hood adj bumpers, door bumpers, glove box bumper, hood to cowl seal, window weatherstrip, paint gasket kit, trunk bumpers, hood side bumper, splash guard seals, trunk weatherstrip	2DR HTP	71 Dode Challenger 2 Door Hardtop	KITCH306
Z		71	Weatherstrip kit, includes chrysler e-body door weatherstrip, hood adj bumpers, door bumpers, glove box bumpers, trunk bumpers, hood side bumpers, hood to cowl seals, paint gasket seals, splash guard seals, window weatherstrip, pillar post weatherstrip, trunk weatherstrips, hood adj bumpers, weatherstrip for conv top	CNV	71 Dodge Challenger Convertible	KITCH307





GUIDE TO SOFFSEAL'S PRODUCT CODES

B = Bumper sets **C** = Glass channels **D** = Door related **G** = Seals, gaskets **H** = Under hood items **I** = Interior parts
M = Miscellaneous items **R** = Roofrail, pillar post & convertible items **T** = Trunk related **W** = Window related **Z** = Weatherstrip kits

Performance Chrysler • Dodge, Plymouth



CODE	IMAGE	YEAR	DESCRIPTION	BODY	FITS	ITEM#
Z		72-73-74	Weatherstrip kit, includes door weatherstrips, roofrail weatherstrips, hood adj bumpers, door bumpers, glove box bumper, hood to cowl seal, window weatherstrip, paint gasket kit, trunk bumpers, hood side bumper, splash guard seals, trunk weatherstrip	2DR HTP	72-74 Plymouth Barracuda 2 Door Hardtop	KITCH308
Z		72-73-74	Weatherstrip kit, includes door weatherstrips, roofrail weatherstrips, hood adj bumpers, door bumpers, glove box bumper, hood to cowl seal, window weatherstrip, paint gasket kit, trunk bumpers, hood side bumper, splash guard seals, trunk weatherstrip	2DR HTP	72-74 Dodge Challenger 2 Door Hardtop	KITCH309

Ford • Mustang











CODE	IMAGE	YEAR	DESCRIPTION	BODY	FITS	ITEM#
D		79-80-81-82-83-84-85-86-87-88-89-90-91-92-93	Door weatherstrip	2DR HTP	79-93 Ford Mustang 2 Door Hardtop	FD3000
D		79-80-81-82-83-84-85-86-87-88-89-90-91-92-93	Cnv t top door weatherstrip	CNV	79-93 Ford Mustang	FD3001
M		00-99	Window weld ribbon sealer 3/8 inch round	ALL BODY STYLES	All Makes And Models	08622
R		81-82-83-84	T top to body weatherstrip, right side	2DR HTP	81-84 Ford Mustang, 2 Door Hardtop	FD3028
R		81-82-83-84	T top to body weatherstrip, left side	2DR HTP	81-84 Ford Mustang 2 Door Hardtop	FD3029
R		81-82-83-84	T top to body weatherstrip	2DR HTP	81-84 Ford Mustang, 2 Door Hardtop	FD3030
R		81-82-83-84	T top weatherstrip kit	2DR HTP	81-84 Ford Mustang, 2 Door Hardtop	FD3031
R		81-82-83-84-85-86-87-88	T top panel to door window weatherstrip, right, side	2DR HTP	81-88 Ford Mustang, 2 Door Hardtop	FD3025
R		81-82-83-84-85-86-87-88	T top panel to door window weatherstrip, left side	2DR HTP	81-88 Ford Mustang 2 Door Hardtop	FD3026
R		81-82-83-84-85-86-87-88	T top panel to door window weatherstrip	2DR HTP	81-88 Ford Mustang, 2 Door Hardtop	FD3027
R		83-84-85-86-87-88-89-90-91-92-93	Pillar post weatherstrip, left side	CNV	83-93 Ford Mustang Convertible	FD3036
R		83-84-85-86-87-88-89-90-91-92-93	Pillar post weatherstrip, right, side	CNV	83-93 Ford Mustang Convertible	FD3037
R		83-84-85-86-87-88-89-90-91-92-93	Pillar post weatherstrip	CNV	83-93 Ford Mustang Convertible	FD3038
R		83-84-85-86-87-88-89-90-91-92-93	Convertible top side rail, right, side	CNV	83-93 Ford Mustang Convertible	FD3009
R		83-84-85-86-87-88-89-90-91-92-93	Convertible top side rail, left side	CNV	83-93 Ford Mustang Convertible	FD3010
R		84-85-86-87-88	T top to body weatherstrip, left side	2DR HTP	84-88 Ford Mustang 2 Door Hardtop	FD3032
R		84-85-86-87-88	T top to body weatherstrip, right, side	2DR HTP	84-88 Ford Mustang 2 Door Hardtop	FD3033
R		84-85-86-87-88	T top to body weatherstrip	2DR HTP	84-88 Ford Mustang, 2 Door Hardtop	FD3034







GUIDE TO SOFFSEAL'S PRODUCT CODES

B = Bumper sets **C** = Glass channels **D** = Door related **G** = Seals, gaskets **H** = Under hood items **I** = Interior parts
M = Miscellaneous items **R** = Roofrail, pillar post & convertible items **T** = Trunk related **W** = Window related **Z** = Weatherstrip kits



CODE	IMAGE	YEAR	DESCRIPTION	BODY	FITS	ITEM#
R		84-85-86-87-88	T top weatherstrip kit	2DR HTP	84-88 Ford Mustang, 2 Door Hardtop	FD3035
R		85-86-87-88-89-90-91-92-93	Convertible top kit, side rails & header seal	CNV	85-93 Ford Mustang Convertible	FD3011
R		85-86-87-88-89-90-91-92-93	Convertible top header seal	CNV	85-96 Ford Mustang Convertible	FD3008
T		79-80-81-82-83-84-85-86-87-88-89-90-91-92-93	Liftgate/trunk weatherstrip hatchback	ALL BODY STYLES	79-93 Ford Mustang	FD3006
T		79-80-81-82-83-84-85-86-87-88-89-90-91-92-93	Liftgate/trunk weatherstrip	CNV	79-93 Ford Mustang Convertible	FD3007
W		79-80-81-82-83-84-85-86-87-88-89-90-91-92-93	Door glass run channel, left side	2DR HTP	79-93 Ford Mustang 2 Door Hardtop	FD3015
W		79-80-81-82-83-84-85-86-87-88-89-90-91-92-93	Door glass run channel, right side	2DR HTP	79-93 Ford Mustang 2 Door Hardtop	FD3016
W		79-80-81-82-83-84-85-86-87-88-89-90-91-92-93	Door glass run channel	2DR HTP	79-93 Ford Mustang 2 Door Hardtop	FD3017
W		83-84-85-86-87-88-89-90-91-92-93	Quarter window seals	CNV	83-93 Ford Mustang Convertible	FD3012
Z		79-80-81-82-83-84-85-86-87-88-89-90-91-92-93	Weatherstrip kit, includes i-top door weatherstrip, trunk weatherstrip	2DR HTP	79-93 Ford Mustang 2 Door Hardtop	KITFD100H
Z		85-86-87-88-89-90-91-92-93	Weatherstrip kit, includes t-top door weatherstrip, side rail weatherstrip, trunk weatherstrip	2DR CNV	85-93 Ford Mustang 2 Door Convertible	KITFD101C

Ford Taurus • Mercury Sable

CODE	IMAGE	YEAR	DESCRIPTION	BODY	FITS	ITEM#
D		86-87-88	Rear door weatherstrip	ALL BODY STYLES	86-88 Ford Taurus Mercury Sable	FD9292
D		86-87-88	Front door weatherstrip	ALL BODY STYLES	86-88 Ford Taurus Mercury Sable	FD9291
M		00-99	Window weld ribbon sealer 3/8 inch round	ALL BODY STYLES	All Makes And Models	08622
T		86-87-88	Trunk weatherstrip	ALL BODY STYLES	86-88 Ford Taurus Mercury Sable	FD9290













WHAT IS A PRODUCT CODE?
 Our catalog is grouped by product CODE (type) then years. See page 1 for details explaining the different Product CODES.



GUIDE TO SOFFSEAL'S PRODUCT CODES					
B = Bumper sets	C = Glass channels	D = Door related	G = Seals, gaskets	H = Under hood items	I = Interior parts
M = Miscellaneous items	R = Roofrail, pillar post & convertible items	T = Trunk related	W = Window related	Z = Weatherstrip kits	

Ford • Trucks, Vans, SUV



CODE	IMAGE	YEAR	DESCRIPTION	BODY	FITS	ITEM#
C		48-49-50	Windshield rubber standard	TRK	48-50 Ford Pickup F1 F2 F3	FD9210
C		48-49-50	Rear window rubber standard	TRK	48-50 Ford Pickup F1 F2 F2	FD9250
C		51-52	Windshield rubber custom	TRK	51-52 Ford Pickup F1 F2 F3	FD9211
C		51-52	Rear window rubber standard	TRK	51-52 Ford Pickup F1 F2 F2	FD9251
C		53-54-55	Windshield rubber standard	TRK	53-55 Ford F100 And F250 Pickup	FD9214
C		53-54-55-56	Window rubber standard	TRK	53-56 Ford F100 & F250 Pickup	FD9255
C		53-54-55-56	Rear window rubber custom	TRK	53-56 Ford F100 And F250 Pickup	FD9258
C		56	Windshield rubber custom	TRK	56 Ford F100 And F250 Pickup	FD9216
C		56	Windshield rubber standard	TRK	56 Ford F100 And F250 Pickup	FD9217
C		57-58-59-60	Front glass channel custom	TRK	57-60 Ford Pickup F100 F250 F350	FD9221
C		57-58-59-60	Rear glass channel standard small glass	TRK	57-60 Ford Pickup F100 F250 F350	FD9260
C		57-58-59-60	Rear glass channel standard wrap around rear window	TRK	57-60 Ford Pickup F100 F250 F350	FD9261
C		57-58-59-60	Front glass channel standard	TRK	57-60 Ford Pickup F100 F250 F350	FD9220
C		61-62-63-64-65-66	Rear glass channel standard	TRK	61-66 Ford Pickup F100 F250	FD9266
C		61-62-63-64-65-66	Glass channel standard	TRK	61-66 Ford Pickup F100 F250	FD9226
C		61-62-63-64-65-66	Front glass channel custom	TRK	61-66 Ford Pickup F100 F250	FD9228
C		67-68-69-70-71-72	Front glass channel, custom	TRK	67-72 Ford Truck Pickup	FD9234
C		67-68-69-70-71-72	Front glass channel standard	TRK	67-72 Ford Truck Pickup	FD9235

Ford • Trucks, Vans, SUV

CODE	IMAGE	YEAR	DESCRIPTION	BODY	FITS	ITEM#
C		67-68-69-70-71-72	Rear glass channel custom	TRK	67-72 Ford Pickup F100 F250	FD9273
C		67-68-69-70-71-72	Rear glass channel, standard	TRK	67-72 Ford Pickup F100 F250	FD9271
C		73-74-75-76-77	Front glass channel wide chrome molding	TRK	73-77 Ford Pickup F100 F150 F250	FD9233
C		73-74-75-76-77-78-79	Rear glass channel wide chrome trim	TRK	73-79 Ford Truck F100 F150 F250	FD9287
C		73-74-75-76-77-78-79	Front glass channel standard	TRK	73-79 Ford Pickup F100 F150 F250	FD9231
C		73-74-75-76-77-78-79-80-81-82-83-84-85-86	Rear glass channel narrow chrome	TRK	73-86 Ford Truck Pickup	FD9288
C		73-74-75-76-77-78-79-80-81-82-83-84-85-86-87-88-89-90-91-92-93-94-95-96-97-98	Rear glass channel standard	TRK	73-98 Ford Pickup	FD9286
C		77-78-79	Front glass channel narrow chrome trim	TRK	77-79 Ford Pickup F100 F150 F250	FD9238
D		37-38-39-40-41-42-43-44-45-46-47-48	Top of door seals	4DR TRK	37-48 Ford 4 Door Closed Car, 32-47 Ford Pickup	FD0540
D		48-49-50-51-52	Door weatherstrip set	TRK	48-52 Ford Pickup F1 F2 F3	FD9310
D		48-49-50-51-52	Door seal set lower	TRK	48-52 Ford Pickup F1 F2 F3	FD9530
D		53-54-55	Door weatherstrip set	TRK	53-55 Ford F100 & F250 Pickup	FD9315
D		56	Door weatherstrip set	TRK	56 Ford F100 And F250 Pickup	FD9316
D		57-58-59-60	Door weatherstrip	TRK	57-60 Ford Pickup F100 And F250 Pickup	FD9320
D		61-62-63-64-65-66	Door weatherstrip	TRK	61-66 Ford Pickup	FD9325
D		66-67-68-69-70-71-72-73-74-75-76-77	Door weatherstrip, lower, with molded ends	TRK	66-77 Ford Bronco	FD9008
D		66-67-68-69-70-71-72-73-74-75-76-77	Door weatherstrip, upper	TRK	66-77 Ford Bronco	FD9007



GUIDE TO SOFFSEAL'S PRODUCT CODES

B = Bumper sets **C** = Glass channels **D** = Door related **G** = Seals, gaskets **H** = Under hood items **I** = Interior parts
M = Miscellaneous items **R** = Roofrail, pillar post & convertible items **T** = Trunk related **W** = Window related **Z** = Weatherstrip kits

Ford • Trucks, Vans, SUV



CODE	IMAGE	YEAR	DESCRIPTION	BODY	FITS	ITEM#
D		67-68-69-70-71-72	Front and rear door weatherstrip fits on cab	TRK	67-79 F100 Thru F700, 73-79 Ford Bronco	FD9009
D		75-76-77-78-79-80-81-82-83-84-85-86-87-88-89-90-91	Door weatherstrip	TRK	75-91 Ford Econoline Van	FD9531
D		80-81-82-83-84-85-86-87-88-89-90-91-92-93-94-95-96-97	Door weatherstrip	TRK	80-97 Ford Truck F150 F350	FD9110
D		83-84-85-86-87-88-89-90-91-92	Door weatherstrip	TRK	83-92 Ford Ranger	FD9111
M		48-49-50-51-52	Radiator support pad	TRK	48-52 Ford Pickup	FD9026
M		48-49-50-51-52	Hood bumper kit	TRK	48-52 Ford Pickup	FD9500
M		48-49-50-51-52	Cowl vent gasket	TRK	48-52 Ford Pickup F1 F2 F3	FD9525
M		48-49-50-51-52	Fuel neck grommet	TRK	48-52 Ford Pickup F1 F2 F3	FD9550
M		48-49-50-51-52	Cab/frame bolt kit, 24 piece	TRK	48-52 Ford Pickup F1 F2 F3	FD9112
M		48-49-50-51-52-53-54-55-56	Cowl lacing kit with tacks	TRK	48-56 Ford Pickup F1 F2 F3 F100 F250 F350	FD9510
M		53-54-55	Radiator support pad kit	TRK	53-55 Ford Pickup	FD9950
M		53-54-55	Fuel neck grommet	TRK	53-55 Ford F100 & F250 Pickup	FD9551
M		53-54-55-56	Cab/frame bushing kit 10 piece	TRK	53-56 Ford Pickup F100f250 F350	FD9116
M		53-54-55-56	Cowl vent gasket	TRK	53-56 Ford F100 And F250 Pickup	FD9526
M		53-54-55-56	Cab/frame bolt kit 14 piece	TRK	53-56 Ford Pickup F100f250 F350	FD9118
M		56	Fuel neck grommet	TRK	56 Ford F100 And F250 Pickup F350	FD9552
M		56	Radiator support pad kit	TRK	56 Ford Pickup	FD9952
W		48-49-50-51-52	Vent window weatherstrip main seal & back edge	TRK	48-52 Ford Pickup F1 F2 F3	FD9350

Ford • Trucks, Vans, SUV

CODE	IMAGE	YEAR	DESCRIPTION	BODY	FITS	ITEM#
W		53-54-55	Vent window seal & back edge	TRK	53-55 Ford F100 And F250 Pickup	FD9381
W		53-54-55	Window channel kit, division bar, window weatherstrip window chann	TRK	53-55 Ford Pick Up F100 F250 F350	FD7141
W		56	Window channel kit, division bar, weatherstrip window channel	TRK	56 Ford Pick Up F100 F250 F350	FD7142
W		56	Vent window weatherstrip main seal & back edge	TRK	56 Ford F100 And F250 Pickup	FD9382
W		57-58-59-60	Anti rattle kit door	TRK	57-60 Ford Pick Up F100 F250 F350	FD7143
W		57-58-59-60	Vent window weatherstrip main seal & body edge	TRK	57-60 Ford Pickup	FD9353
W		61-62-63-64-65-66	Vent window weatherstrip main seal & back edge	TRK	61-66 Ford Pickup F100 F250	FD9355
W		67-68-69-70	Window weatherstrip	TRK	67-70 Full Size Ford Pickup	FD9362
W		67-68-69-70	Window channel kit, division bar, window weatherstrip, & channel	TRK	67-70 Ford Pick Up F100 F250	FD7145
W		67-68-69-70-71-72	Vent window weatherstrip	TRK	67-72 Ford Pickup F100 F250	FD9360
W		71-72	Window channel kit, division bar, window weatherstrip & channel	TRK	71-72 Ford Pick Up F100 F250	FD7148
W		71-72	Window weatherstrip	TRK	71-72 Full Size Ford Pickup Pickup	FD9361
W		73-74-75-76-77-78-79	Window weatherstrip	TRK	73-79 Full Size Ford Pickup 78-79 Bronco Pickup	FD9364
W		73-74-75-76-77-78-79	Window channel kit	TRK	73-79 Full Size Ford Pickup 78-79 Bronco	FD7147
W		73-74-75-76-77-78-79	Vent window weatherstrip	TRK	73-79 Ford Pickup	FD9365
W		80-81-82-83-84-85-86-87-88-89-90-91-92-93-94-95-96	Window run channel	TRK	80-96 Ford Full Size Pickup And Bronco	FD9665
W		80-81-82-83-84-85-86-87-88-89-90-91-92-93-94-95-96	Window weatherstrip	TRK	80-96 Full Size Ford Pickup Bronco Pickup	FD9363



GUIDE TO SOFFSEAL'S PRODUCT CODES

B = Bumper sets **C** = Glass channels **D** = Door related **G** = Seals, gaskets **H** = Under hood items **I** = Interior parts
M = Miscellaneous items **R** = Roofrail, pillar post & convertible items **T** = Trunk related **W** = Window related **Z** = Weatherstrip kits

Ford • Trucks, Vans, SUV



CODE	IMAGE	YEAR	DESCRIPTION	BODY	FITS	ITEM#
W	A small placeholder icon with the text "IMAGE COMING SOON" and a small Ford logo below it.	80-81-82-83-84- 85-86-87-88-89- 90-91-92-93-94- 95-96	Window channel kit	TRK	80-96 Full Size Ford Pickup 80-96 Bronco	FD7146

Street Rods & Customs

CODE	IMAGE	YEAR	DESCRIPTION	BODY	FITS	ITEM#
B		32-33-34-35-36-37-38-39-40	Door Access Bumpers Weatherstrip with screws	2DR 4DR SDN	32-33 Closed Car, 34-35 Standard Closed Car, 36 Doors with Retainer, 37-40 Closed Car	0190
B		37	Hood panel to grille bumpers	ALL BODY STYLES	37 Chevrolet	0206
B		37-38-39-40-41-42-43-44-45-46-47-48-49-50-51-52-53-54	Door bumpers, one prong 4 piece	2DR 4DR COUPE SDN	37-54 Chevrolet, Pontiac, 2 Door, Coupe, Sedan, 4 Door Sedan	0300
B		41-42-43-44-45-46-47-48-49-50-51-52-53-54-55-56-57	Firewall/cowl bumper, 41-48 top of firewall, 41-54 side cowl	ALL BODY STYLES	41-57 Chevrolet	0457
B		42-43-44-45-46-47-48	Hood fender bumpers need 10	ALL BODY STYLES	42-48 Chevrolet	0407
B		49-50-51-52	Bumper, folding top rear bow	CNV	49-52 Chevrolet, Oldsmobile, Pontiac Convertible	0403
B		49-50-51-52	Hood to grille bumpers	ALL BODY STYLES	49-52 Chevrolet	0504
B		49-50-51-52-53	Cowl panel bumpers	ALL BODY STYLES	49-53 Chevrolet	0506
B		49-50-51-52-53-54	Firewall grommet, oil pressure	ALL BODY STYLES	49-54 Chevrolet	0411
B		49-50-51-52-53-54	Hood/fender bumper need 8	ALL BODY STYLES	49-54 Chevrolet	0502
B		53-54	Trunk lid bumpers	ALL BODY STYLES	53-54 Chevrolet	0700
B		ALL	Street rod bumper box 50 pieces 5 of each bumper k102, k103, k121, k124, k162, k183, k188, k190, k191, k192	ALL BODY STYLES	Universal Fit Street Rod And Custom	SRBOX
B		ALL	Street rod bumper box 100 pieces 10 of each bumper k102, k103, k121, k124, k162, k183, k188, k190, k191, k192	ALL BODY STYLES	Universal Fit Street Rod And Custom	SRBOXL
C		00-99	Glass run channel black length: 6 ft	ALL BODY STYLES	Universal Fit Street Rod And Custom	SRC072
C		00-99	Glass run channel 8ft	ALL BODY STYLES	Universal Fit And Street Rod	SRC073
C		00-99	Window run channel, 8 ft length	ALL BODY STYLES	Universal Fit And Street Rod	SRC111
C		00-99	Glass trim channel, black, flush mount	SR	Universal Fit Street Rod And Custom	SRW014



















GUIDE TO SOFFSEAL'S PRODUCT CODES





B = Bumper sets **C** = Glass channels **D** = Door related **G** = Seals, gaskets **H** = Under hood items **I** = Interior parts
M = Miscellaneous items **R** = Roofrail, pillar post & convertible items **T** = Trunk related **W** = Window related **Z** = Weatherstrip kits

Street Rods & Customs



CODE	IMAGE	YEAR	DESCRIPTION	BODY	FITS	ITEM#
C		00-99	Glass trim channel - black, flush mount	SR	Universal Fit Street Rod And Custom	SRW017
C		00-99	Glass trim channel - black, flush mount	SR	Universal Fit Street Rod And Custom	SRW020
C		28-29-30-31-32-33-34-35-36-37-38-39-40-41-42-43-44-45-46-47-48	Glass run channel flexible pile lining rubber length 5FT	ALL BODY STYLES	Universal Fit Street Rod And Custom	SRC048
C		30-31-32-33-34-35-36-37-38-39-40-41-42-43-44-45-46-47-48-49-50-51-52-53-55	Run channel kit post with vent windows	ALL BODY STYLES	Mid 30s To Mids 50s Street Rod	SRS3050
C		34-35	Windshield gasket	ALL BODY STYLES	34-35 Chevrolet, Pontiac, Oldsmobile, Buick, Standard	0192
C		37-38	Closed car windshield gasket	ALL BODY STYLES	37-38 Chevrolet Pontiac	0220
C		37-38-39-40	Rear glass channel	ALL BODY STYLES EX Sedan Del	37-40 Chevrolet Pontiac All Models	0226
C		39	Closed car windshield gasket	ALL BODY STYLES	39 Chevrolet Pontiac	0222
C		40	Front glass channel closed car without chrome	ALL BODY STYLES	40 Chevrolet Pontiac	0225
C		41-42-43-44-45-46-47-48	Front glass channel closed car without chrome	ALL BODY STYLES	41-48 Chevrolet Except Aero	0412
C		41-42-43-44-45-46-47-48	Rear glass channel without chrome	Chevrolet Oldsmobile Buick Pontiac	41-48 Chevrolet All Models Oldsmobile Buick Pontiac Except Aero	0416
C		41-42-43-44-45-46-47-48	Rear glass channel with chrome	ALL BODY STYLES	41-48 Chevrolet Aero Sedan	0417
C		41-42-43-44-45-46-47-48	Rear glass channel with chrome	ALL BODY STYLES	41-48 Chevrolet All Models Oldsmobile Pontiac Except Aero	0418
C		42-43-44-45-46-47-48	Front glass channel	2DR SDN	42-48 Chevrolet Aero Sedan	0415
C		49-50-51-52	Windshield channel with chrome	2DR HTP CNV	49-52 Chevrolet Bel Air Hardtop Convertible	0520
C		49-50-51-52	Hood to cowl seal	ALL BODY STYLES	49-52 Chevrolet Oldsmobile Pontiac	0570
C		49-50-51-52	Front glass channel with chrome	2DR 4DR SDN	49-52 Chevrolet Sedan 2 Door 4 Door Sedan Except Fast Back	0535

Street Rods & Customs

CODE	IMAGE	YEAR	DESCRIPTION	BODY	FITS	ITEM#
C		49-50-51-52	Front glass channel with chrome	2DR 4DR SDN	49-52 Chevrolet 2 Door 4 Door Sedan Except Fast Back	0537
C		49-50-51-52	Rear glass channel with chrome	2DR 4DR SDN	49-52 Chevrolet All, Except Fastback	0541
C		49-50-51-52	Rear glass channel	2DR 4DR SDN	49-52 Chevrolet Fastback Only	0539
C		50-51-52	Rear glass channel, with chrome	2DR HTP	50-52 Oldsmobile, Pontiac, Chevrolet Bel Air Hardtop	0530
C		53-54	Rear glass channel	2DR HTP	53-54 Old, Pontiac, Chevrolet Bel Air Hardtop	0532
C		53-54	Rear glass channel	2DR SDN	53-54 Chevrolet Sedan	0534
C		53-54	Windshield channel	2DR SDN	53-54 Chevrolet Bel Air 210 Oldsmobile, Pontiac, Sedan	0522
C		53-54	Front glass channel	2DR 4DR SDN	53-54 Chevrolet 150 Sedan	0523
C		53-54	Windshield channel	2DR HTP CNV	53-54 Chevrolet Bel Air, Oldsmobile, Buick, Pontiac, Hardtop Convertible	0524
C		54	Rear glass channel	2DR 4DR SDN	54 Chevrolet 2 Door 4 Door Sedan 150 Only	0531
D		28-29-30-31	Door seal kit model A door w/strips	SR	28-31 Ford Model A	SRS2831
D		32-33-34	Door seal kit, steel or fiberglass bodies	ALL BODY STYLES	32-34 Ford Street Rod	SRS3234
D		35-36	Door weatherstrip	2DR SDN	35-36 Chevrolet Series 1001-09-11-19-57-36-1201-09-11-17	0204
D		36-37-38-39-40-41-42-43-44-45-46-47-48	Door weatherstrip universal	SR	36-40 Street Rod, 36-48 Cars	SRS3640
D		36-37-38-39-40-41-42-43-44-45-46-47-48	Door universal weatherstrip	SR	41-48 Street Rod, 36-48 Cars	SRS4148
D		36-37-38-39-40-41-42-43-44-45-46-47-48-49-50-51-52-53-54	Door weatherstrip, universal Street Rod Truck	SR	36-54 Street Rod Truck	SRS3654T
D		37-38-39	Door weatherstrip, upper	2DR SDN	37-39 Chevrolet 2 Door	0240
D		37-38-39	Door weatherstrip, lower	2DR SDN	37-39 Chevrolet 2 Door	0242











GUIDE TO SOFFSEAL'S PRODUCT CODES						
B = Bumper sets	C = Glass channels	D = Door related	G = Seals, gaskets	H = Under hood items	I = Interior parts	
M = Miscellaneous items	R = Roofrail, pillar post & convertible items		T = Trunk related	W = Window related	Z = Weatherstrip kits	

Street Rods & Customs



CODE	IMAGE	YEAR	DESCRIPTION	BODY	FITS	ITEM#
D		40-41	Door weatherstrip	2DR SDN	40-41 Chevrolet Closed Cars 2 Door	0430
D		41-42-43-44-45-46-47-48	Door weatherstrip molded	CNV	41-48 Chevrolet Convertible	0432
D		42-43-44-45-46-47-48	Door weatherstrip, closed car, front doors	2DR SDN	42-48 Chevrolet Closed Car	0434
D		49-50-51-52	Door weatherstrip with molded ends, without top hinge pillar seals	CNV 2DR HTP	49-52 Chevrolet, Pont, 49-50 Oldsmobile Hardtop Convertible	0540
D		49-50-51-52	Door weatherstrips with top hinge seals and body to fender seals	HTP CNV	49-52 Chevrolet, Pontiac Hardtop Convertible 2 Door, 49-50 Oldsmobile Hardtop Convertible	0547
D		49-50-51-52	Upper door hinge seal	2DR HTP CNV	49-52 Chevrolet, Pontiac, 49-50 Oldsmobile, 2 Door Hardtop Convertible	0551
D		49-50-51-52	Door weatherstrip	2DR SDN	49-52 Chevrolet Oldsmobile Pontiac Sedan	0536
D		53-54	Door weatherstrip	CNV 2DR HTP	53-54 Chevrolet, 2 Door Hardtop Convertible	0542
D		53-54	Door weatherstrip	2DR SDN	53-54 Chevrolet Sedan 2 Door	0543
D		54-55-56	Door weatherstrip	CNV	54-56 Buick Super, Roadmaster Riviera, Cadillac Convertible	0549
E		00-99	Header seal convertible top, universal sponge extrusion, height of 3/4" and a width of 13/16"	ALL BODY STYLES	Universal Fit And Street Rod	E006
E		00-99	Extrusion with adhesive backing, universal sponge extrusion, height of 3/4" and a width of 13/16"	ALL BODY STYLES	Universal Fit And Street Rod	E006A
E		00-99	Universal weatherstrip extrusion, sponge, height of 1/2" and a width of 1 1/4"	ALL BODY STYLES	Universal Fit And Street Rod	E1027
E		00-99	Weatherstrip extrusion, universal sponge extrusion, with adhesive backing, height of 1/8" and a width of 5/16"	ALL BODY STYLES	Universal Fit And Street Rod	E1076
E		00-99	Weatherstrip extrusion, universal sponge extrusion, with adhesive backing, height of 7/32" and a width of 3/8"	ALL BODY STYLES	Universal Fit And Street Rod	E1077
E		00-99	Universal weatherstrip sponge extrusion, with adhesive backing, height of 3/16" and a width of 7/16"	ALL BODY STYLES	Universal Fit And Street Rod	E1078

Street Rods & Customs

CODE	IMAGE	YEAR	DESCRIPTION	BODY	FITS	ITEM#
E		00-99	Universal weatherstrip sponge extrusion, with adhesive backing, height of 3/8" and a width of 5/8"	ALL BODY STYLES	Universal Fit And Street Rod	E1083
E		00-99	Universal weatherstrip sponge extrusion, with adhesive backing, height of 1/4" and a width of 3/8"	ALL BODY STYLES	Universal Fit And Street Rod	E1085
E		00-99	Sponge universal sponge weatherstrip with adhesive backing, height of 1/2" and a width of 1/2"	ALL BODY STYLES	Universal Fit And Street Rod	E1704
E		00-99	Universal weatherstrip sponge extrusion, height of 3/8" and a width of 5/8"	ALL BODY STYLES	Universal Fit And Street Rod	E1723
E		00-99	Universal weatherstrip extrusion, with adhesive backing, height of 5/8" and a width of 3/4"	ALL BODY STYLES	Universal Fit And Street Rod	E518
E		00-99	Dense u channel extrusion, height of 1/2" and a width of 1/2"	ALL BODY STYLES	Universal Fit And Street Rod	E613
E		00-99	T-grip Extrusion Blk Extruded 70 Durometer EPDM, width of 7/8 and 3/8 tall	ALL BODY STYLES	Universal Fit and Street Rod	E614
E		00-99	Door Glass Run Channel 96"length, width of 3/4 and 17/32 tall	ALL BODY STYLES	Universal Fit and Street Rod	E634
E		00-99	Extrusion with adhesive, universal sponge extrusion, height of 1/4" and a width of 1/2"	ALL BODY STYLES	Universal Fit And Street Rod	E707A
E		00-99	Doghouse to cab seal extrusion, universal sponge extrusion, height of 7/8" and a width of 1/2"	ALL BODY STYLES	Universal Fit And Street Rod	E715
E		00-99	Extrusion, black, universal with adhesive, height of 7/16" and a width of 7/16"	ALL BODY STYLES	Universal Fit And Street Rod	E725A
E		00-99	Universal weatherstrip extrusion, height of 9/16" and a width of 3/8"	ALL BODY STYLES	Universal Fit And Street Rod	E798
E		00-99	Sponge extrusion universal extrusion, with adhesive backing, height of 1/2" and a width of 3/8"	ALL BODY STYLES	Universal Fit And Street Rod	E970
E		00-99	Epdm sponge extrusion with 3/8 inch adhesive, universal extrusion, height of 5/8" and a width of 1/2"	ALL BODY STYLES	Universal Fit And Street Rod	E971
E		00-99	Universal weatherstrip sponge extrusion, with adhesive backing, height of 11/16" and a width of 11/16"	ALL BODY STYLES	Universal Fit And Street Rod	E1935
E		00-99	Roofrail weatherstrip, universal sponge extrusion, height of 7/8" and a width of 5/8"	ALL BODY STYLES	Universal Fit And Street Rod	E204





















GUIDE TO SOFFSEAL'S PRODUCT CODES



















B = Bumper sets **C** = Glass channels **D** = Door related **G** = Seals, gaskets **H** = Under hood items **I** = Interior parts
M = Miscellaneous items **R** = Roofrail, pillar post & convertible items **T** = Trunk related **W** = Window related **Z** = Weatherstrip kits

Street Rods & Customs



CODE	IMAGE	YEAR	DESCRIPTION	BODY	FITS	ITEM#
E		00-99	1/8 inch x 2 inch neopren 25 ft roll goes between body & frame	ALL BODY STYLES	Universal Fit Street Rod And Custom	SRE001
E		00-99	Fender welt ext goes between body & fender black 25 ft	ALL BODY STYLES	Universal Fit Street Rod And Custom	SRE002A
E		00-99	Fender Welt Extrusion Goes Between Body & Fender Yellow 30 Ft	ALL BODY STYLES	Street Rod	SRE002B
E		00-99	Fender Welt Extrusion Goes Between Body & Fender Blue 30 Ft Length	ALL BODY STYLES	Street Rod	SRE002C
E		00-99	Fender Welt Extrusion Goes Between Body & Fender Red 30 Ft Length	ALL BODY STYLES	Street Rod	SRE002D
E		00-99	Fender Welt Extrusion Goes Between Body & Fender White 30 Ft	ALL BODY STYLES	Street Rod	SRE002E
E		00-99	Fender Welt Extrusion Goes Between Body/fender Beige 30 Ft	ALL BODY STYLES	Street Rod	SRE002F
E		00-99	Fender Welt Extrusion Goes Between Body/fender Grey 30 Feet Length	ALL BODY STYLES	Street Rod	SRE002G
E		00-99	Fender Welt Ext.goes Between Body & Fender Chrome 25 Ft.	ALL BODY STYLES	Street Rod	SRE002H
E		00-99	Fender Welt Extrusion Goes Between Body & Fender Orange 30 Ft.	ALL BODY STYLES	Street Rod	SRE002I
E		00-99	Extrusion 5 ft of e006a	ALL BODY STYLES	Universal Fit Street Rod And Custom	SRE006A05
E		00-99	Extrusion 10ft of e006a	ALL BODY STYLES	Universal Fit Street Rod And Custom	SRE006A10
E		00-99	Extrusion 15 ft of e 006a	ALL BODY STYLES	Universal Fit Street Rod And Custom	SRE006A15
E		00-99	Extrusion 20 ft of e006a	ALL BODY STYLES	Universal Fit Street Rod And Custom	SRE006A20
E		00-99	Extrusion 5 ft of e107	ALL BODY STYLES	Universal Fit Street Rod And Custom	SRE10705
E		00-99	Extrusion 10 ft of e107	ALL BODY STYLES	Universal Fit Street Rod And Custom	SRE10710
E		00-99	Extrusion 15 ft of e107	ALL BODY STYLES	Universal Fit Street Rod And Custom	SRE10715
E		00-99	Extrusion 20 ft of e107	ALL BODY STYLES	Universal Fit Street Rod And Custom	SRE10720

Street Rods & Customs





CODE	IMAGE	YEAR	DESCRIPTION	BODY	FITS	ITEM#
E		00-99	Extrusion 5 ft of e1076	ALL BODY STYLES	Universal Fit Street Rod And Custom	SRE107605
E		00-99	Extrusion 10 ft of e1076	ALL BODY STYLES	Universal Fit Street Rod And Custom	SRE107610
E		00-99	Extrusion 15 ft of e1076	ALL BODY STYLES	Universal Fit Street Rod And Custom	SRE107615
E		00-99	Extrusion 20 ft of e1076	ALL BODY STYLES	Universal Fit Street Rod And Custom	SRE107620
E		00-99	Extrusion 5 ft of e1077	ALL BODY STYLES	Universal Fit Street Rod And Custom	SRE107705
E		00-99	Extrusion 10 ft of e1077	ALL BODY STYLES	Universal Fit Street Rod And Custom	SRE107710
E		00-99	Extrusion 15 ft of e1077	ALL BODY STYLES	Universal Fit Street Rod And Custom	SRE107715
E		00-99	Extrusion 20 ft of e1077	ALL BODY STYLES	Universal Fit Street Rod And Custom	SRE107720
E		00-99	Extrusion 5 ft of e1085	ALL BODY STYLES	Universal Fit Street Rod And Custom	SRE108505
E		00-99	Extrusion 10 ft of e1085	ALL BODY STYLES	Universal Fit Street Rod And Custom	SRE108510
E		00-99	Extrusion 15 ft of e1085	ALL BODY STYLES	Universal Fit Street Rod And Custom	SRE108515
E		00-99	Extrusion 20 ft of e1085	ALL BODY STYLES	Universal Fit Street Rod And Custom	SRE108520
E		00-99	Extrusion 5 ft of e1704	ALL BODY STYLES	Universal Fit Street Rod And Custom	SRE170405
E		00-99	Extrusion 10 ft of e1704	ALL BODY STYLES	Universal Fit Street Rod And Custom	SRE170410
E		00-99	Extrusion 15 ft of e1704	ALL BODY STYLES	Universal Fit Street Rod And Custom	SRE170415
E		00-99	Extrusion 20 ft of e1704	ALL BODY STYLES	Universal Fit Street Rod And Custom	SRE170420
E		00-99	Extrusion 5 ft of e1723	ALL BODY STYLES	Universal Fit Street Rod And Custom	SRE172305
E		00-99	Extrusion 10 ft of e1723	ALL BODY STYLES	Universal Fit Street Rod And Custom	SRE172310



















GUIDE TO SOFFSEAL'S PRODUCT CODES					
B = Bumper sets	C = Glass channels	D = Door related	G = Seals, gaskets	H = Under hood items	I = Interior parts
M = Miscellaneous items	R = Roofrail, pillar post & convertible items	T = Trunk related	W = Window related	Z = Weatherstrip kits	

Street Rods & Customs



CODE	IMAGE	YEAR	DESCRIPTION	BODY	FITS	ITEM#
E		00-99	Extrusion 15 ft of e1723	ALL BODY STYLES	Universal Fit Street Rod And Custom	SRE172315
E		00-99	Extrusion 20 ft of e1723	ALL BODY STYLES	Universal Fit Street Rod And Custom	SRE172320
E		00-99	Extrusion 5 ft of e204	ALL BODY STYLES	Universal Fit Street Rod And Custom	SRE20405
E		00-99	Extrusion 10 ft of e204	ALL BODY STYLES	Universal Fit Street Rod And Custom	SRE20410
E		00-99	Extrusion 15 ft of e204	ALL BODY STYLES	Universal Fit Street Rod And Custom	SRE20415
E		00-99	Extrusion 20 ft of e204	ALL BODY STYLES	Universal Fit Street Rod And Custom	SRE20420
E		00-99	Extrusion 5 ft of e707a	ALL BODY STYLES	Universal Fit Street Rod And Custom	SRE707A05
E		00-99	Extrusion 10 ft of e707a	ALL BODY STYLES	Universal Fit Street Rod And Custom	SRE707A10
E		00-99	Extrusion 15 ft of e707a	ALL BODY STYLES	Universal Fit Street Rod And Custom	SRE707A15
E		00-99	Extrusion 20 ft of e707a	ALL BODY STYLES	Universal Fit Street Rod And Custom	SRE707A20
E		00-99	Extrusion 5 ft of e715	ALL BODY STYLES	Universal Fit Street Rod And Custom	SRE71505
E		00-99	Extrusion 10 ft of e715	ALL BODY STYLES	Universal Fit Street Rod And Custom	SRE71510
E		00-99	Extrusion 15 ft of e715	ALL BODY STYLES	Universal Fit Street Rod And Custom	SRE71515
E		00-99	Extrusion 20 ft of e715	ALL BODY STYLES	Universal Fit Street Rod And Custom	SRE71520
E		00-99	Extrusion with adhesive backing 5 ft length	ALL BODY STYLES	Universal Fit Street Rod And Custom	SRE725A05
E		00-99	Extrusion 10 ft e725a	ALL BODY STYLES	Universal Fit Street Rod And Custom	SRE725A10
E		00-99	Extrusion 15 ft e725a	ALL BODY STYLES	Universal Fit Street Rod And Custom	SRE725A15
E		00-99	Extrusion 20ft e725a	ALL BODY STYLES	Universal Fit Street Rod And Custom	SRE725A20

Street Rods & Customs

CODE	IMAGE	YEAR	DESCRIPTION	BODY	FITS	ITEM#
E		00-99	Extrusion 30 ft e725a	ALL BODY STYLES	Universal Fit Street Rod And Custom	SRE725A30
E		00-99	Extrusion 5 ft of e798	ALL BODY STYLES	Universal Fit Street Rod And Custom	SRE79805
E		00-99	Extrusion 10 ft of e798	ALL BODY STYLES	Universal Fit Street Rod And Custom	SRE79810
E		00-99	Extrusion 15 ft of e798	ALL BODY STYLES	Universal Fit Street Rod And Custom	SRE79815
E		00-99	Extrusion 20 ft of e798	ALL BODY STYLES	Universal Fit Street Rod And Custom	SRE79820
E		00-99	Extrusion with adhesive backing 5ft length	ALL BODY STYLES	Universal Fit Street Rod And Custom	SRE97005
E		00-99	Extrusion with adhesive 10ft length	ALL BODY STYLES	Universal Fit Street Rod And Custom	SRE97010
E		00-99	Extrusion with adhesive backing 15ft length	ALL BODY STYLES	Universal Fit Street Rod And Custom	SRE97015
E		00-99	Extrusion with adhesive backing 20ft	ALL BODY STYLES	Universal Fit Street Rod And Custom	SRE97020
E		00-99	Extrusion with 3/8 inch adhesive 5 ft e971 5/8 inch t x 1/2 inch w	ALL BODY STYLES	Universal Fit Street Rod And Custom	SRE97105
E		00-99	Extrusion with 3/8 inch adhesive 10 ft of e971 5/8 inch t x 1/2 inch w	ALL BODY STYLES	Universal Fit Street Rod And Custom	SRE97110
E		00-99	Extrusion with 3/8 inch adhesive 15 ft of e971 5/8 inch t x 1/2 inch w	ALL BODY STYLES	Universal Fit Street Rod And Custom	SRE97115
E		00-99	Extrusion with 3/8 inch adhesive 20 ft of e971 5/8 inch t x 1/2 inch w	ALL BODY STYLES	Universal Fit Street Rod And Custom	SRE97120
E		ALL	Flat gasket with pressure sensitive adhesive street rod universal, height of 0.841 and width of 0.045	ALL	Universal Fit and Street Rod	E1776
E		AllYears	Weatherstrip Universal Extrusion with adhesive backing	All Body Styles	Universal Fit And Street Rod	E237A
G		37-38-39-40-41-42-43-44-45-46-47-48	Cowl vent seal	ALL BODY STYLES	37-48 Chevrolet	0650
G		47-48-49-50-51-52-53-54-55	Steering column to firewall seal, 1 1/4 in column	TRK SR	47-55 Chevrolet, GMC Truck, Except 4-Speed, Universal and Street Rod Fit	9137



GUIDE TO SOFFSEAL'S PRODUCT CODES

B = Bumper sets **C** = Glass channels **D** = Door related **G** = Seals, gaskets **H** = Under hood items **I** = Interior parts
M = Miscellaneous items **R** = Roofrail, pillar post & convertible items **T** = Trunk related **W** = Window related **Z** = Weatherstrip kits

Street Rods & Customs



CODE	IMAGE	YEAR	DESCRIPTION	BODY	FITS	ITEM#
G		49-48-49-50	Park lens gasket	ALL BODY STYLES	49-50 Chevrolet	0590
G		49-50	Taillight mounting pad	2 DR 4DR HTP SDN CNV	49-50 Chevy except Sedan Delivery	0579
G		49-50	License lens gasket	ALL BODY STYLES	49-50 Chevrolet	0599
G		49-50	Taillight, gasket except wagon/delivery	ALL BODY STYLES	49-50 Chevrolet	0595
G		49-50,54-55	Rear license light mounting pad	2 DR 4DR HTP SDN CNV	49-50 Except Sedan Delivery; 54-55 Chev Truck; 54 Chevy Sedan Delivery	0601
G		49-50-51-52	Front fender to door seal	ALL BODY STYLES	49-52 Chevrolet	0544
G		49-50-51-52-53-54	Door handle & lock gaskets	ALL BODY STYLES	49-54 Chevrolet, 2 Door	0560
G		49-50-51-52-53-54	Rear body to bumper seal	ALL BODY STYLES	49-54 Chevrolet	0620
G		49-50-51-52-53-54	Steering column sponge seal	ALL BODY STYLES	49-54 Chevrolet	0626
G		49-50-51-52-53-54	Door handle and lock gasket set	2DR 4DR HTP SDN CNV SWG CPE	All Buick, Cadillac, Chevrolet, Olds, Pontiac	0421
G		50-51-52	Pad backup lamp	2DR 4DR HTP SDN CNV CPE	50-52 Chevrolet 2 Door 4 Door Hardtop Sedan Convertible Coupe	0585
G		51	Park lens gaskets	ALL BODY STYLES	51 Chevrolet	0591
G		51-52	Taillight mounting pad	2 DR 4DR HTP SDN CNV	51-52 Chevy except Sedan Delivery	0584
G		51-52	License lens gasket	ALL BODY STYLES	51-52 Chevrolet	0600
G		51-52	Taillight lens gasket	SWG	51-52 Chevrolet Except Station Wagon/Delivery	0596
G		52	Park lens gasket	ALL BODY STYLES	52 Chevrolet	0592
G		53	Park lens gasket	ALL BODY STYLES	53 Chevrolet	0593
G		53	Taillight and lens gaskets	ALL BODY STYLES	53 Chevrolet	0597

Street Rods & Customs

CODE	IMAGE	YEAR	DESCRIPTION	BODY	FITS	ITEM#
G		53-54	Taillight housing to body seal	2DR 4DR HTP SDN CPE	53-54 Chevrolet	0581
G		54	Park lens gasket	ALL BODY STYLES	54 Chevrolet	0594
G		54	Taillight and lens gaskets	ALL BODY STYLES	54 Chevrolet	0598
G		58	Steering column seal sponge	2DR 4DR HTP 2DR SDN CNV SWG SR	58 Chevrolet Pontiac, Universal Fit Street Rod And Custom, Standard Transmission	2056A
G		66-67-68-69-70- 71-72-73-74	Master cylinder gasket, standard and pwr brake, plus universal and street rod & custom	2DR HTP 2DR SDN CNV SR	66-74 Dodge Dart, 66-70 Coronet, Charger, 68 Roadrunner, Super Bee, 69 Daytona, 70-74 Challenger, 71-72 Demon, 71-74 Swinger, 73 Dart Sport, 66-74 Plymouth Valiant, Barracuda, 66-70 Belvedere, Satellite 67-69 Gtx, 7-74 Duster, Cuda, 71-74 Scamp,	CH1054
G		70-71-72-73-74	Blower motor seal non-a/c	2DR HTP CNV SR	70-74 Chrysler E Body, Universal Fit Street Rod And Custom	CH3403
H		00-99	Hoodside Bumper; has a width of 1.14", a length of 10/16", and an installed height of .65". It is typically used in metal applications and has a drill/slot of .188".	ALL BODY STYLES	Universal Fit and Universal Fit Street Rod And Custom	K184
H		42-43-44-45-46- 47-48	Top of firewall cowl seal	ALL BODY STYLES	42-48 Chevrolet	0470
H		53	Hood to cowl seal	ALL BODY STYLES	53 Chevrolet Oldsmobile Pontiac	0572
H		54	Hood to cowl seal	ALL BODY STYLES	54 Chevrolet Oldsmobile Pontiac	0574
I		49-50-51-52-53-54	Steering gear to toe board cover	ALL BODY STYLES	49-54 Chevrolet All Except P.B.	0627
I		All	Master Cylinder Floor Plug Steel Floor	SR	Universal	SRP001
K		28-29-30-31	Weatherstrip kit, 1 front & rear doors, except hinge plate, 1 hinge plate, 1 hood to cowl shell, 1 bottom door body, 1 door top	SR	28-31 Ford 2 Door, Sedan And Closed Cab Pick Up, Original Ford Body	SRS2006
K		28-29-30-31	Weatherstrip kit 1 front & rear doors, except hinge plate, 1 hinge plate, 1 hood to cowl shell, 1 bottom door body, 1 door top, 1 deck lid	SR	28-31 Ford Model A Coupe Stree, Original Ford t RodBody	SRS2007



GUIDE TO SOFFSEAL'S PRODUCT CODES

B = Bumper sets **C** = Glass channels **D** = Door related **G** = Seals, gaskets **H** = Under hood items **I** = Interior parts
M = Miscellaneous items **R** = Roofrail, pillar post & convertible items **T** = Trunk related **W** = Window related **Z** = Weatherstrip kits

Street Rods & Customs



CODE	IMAGE	YEAR	DESCRIPTION	BODY	FITS	ITEM#
K		29	Weatherstrip kit, 1 deck lid, 1 hood to cowl/shell, 1 front & rear of doors, except hinge plate, 1 hinge plate, 1 top of doors, 1 door bottom body	SR	29 Ford Model A Coupe Street Rod, Gibbon Fiberglass Reproduction Inc. Fiberglass Body	SRS504
K		31	Weatherstrip kit, 1 hood to cowl/shell, 1 door rear and front, 1 hinge plate, 1 door bottom body, 1 door top	SR	31 Ford Closed Cab Pick Up, Wescott Auto Restyling Fiberglass Body	SRS401
K		32	Weatherstrip kit, 1 bottom of trunk, 1 trunk, 2 doors, 1 hood to shell, 1 hood to cowl	SR	32 Ford 3 Window Coupe, Redneck Corporation	SRS302
K		32	Weatherstrip kit, 1 trunk, 2 doors, 1 hood to cowl, 1 hood to shell	SR	32 Ford Roadster/Cabriolet, Gibbon Fiberglass Reproduction Inc. Fiberglass Body	SRS500
K		32	Weatherstrip kit, 1 trunk, 2 door seals, front, top, bottom, 1 hood to cowl, 1 hood to shell	SR	32 Ford 3 Window Coupe, Gibbon Fiberglass Reproduction Inc. Fiberglass Body	SRS501
K		32	Weatherstrip kit, 1 trunk, 1 trunk front, 1 hood to cowl, 1 radiator to grill, 2 doors	SR	32 Ford Roadster, Wescott Auto Restyling Fiberglass Body	SRS400
K		32	Weatherstrip kit, 2 doors, 1 trunk, 1 bottom of trunk, 1 hood to shell & cowl	SR	32 Ford Coupe, Downs Manufacturing Fiberglass Body	SRS904
K		32	Weatherstrip kit, 2 doors, 1 hood to cowl, 1 hood to shell, 1 trunk, 1 glass run channel	SR	32 Ford 3 Window Coupe, Dearborn Deuce	SRSDD32
K		32	Weatherstrip kit, 2 doors, 1 trunk, 1 hood to cowl, 1 hood to shell	SR	32 Ford Roaster Street Rod, P And J Automotive, Inc	SRS604
K		32	Weatherstrip kit, 1 hood to cowl, 1 hood to shell, 2 door seals, 1 trunk, 1 trunk bottom	SR	32 Ford Roadster, Hastings Fiberglass Bodies	SRS700
K		32	Weatherstrip kit, 1 hood to cowl, 1 hood to shell, 2 doors, 1 trunk, 1 trunk bottom	SR	32 Ford 3 Window Coupe, Hastings Fiberglass Bodies	SRS701
K		32	Weatherstrip kit, 2 doors, 1 hood to cowl, 1 hood to grill shell	SR	32 Ford Victoria, Hastings Fiberglass Bodies	SRS702
K		32	Weatherstrip kit, 2 doors, 1 trunk, 1 hood to cowl, 1 hood to shell	SR	32 Ford 3 Window 2 Door Street Rod, Outlaw Performance, Inc	SRS200
K		32	Weatherstrip kit, 2 doors, 1 trunk, sides and top, 1 trunk bottom, 1 hood to cowl, 1 hood to shell	SR	32 Street Rod 3 Window Coupe Steel Body, Original Ford Body	SRS2000
K		32	Weatherstrip kit, 2 doors, 1 trunk, sides and top, 1 trunk bottom, 1 hood to cowl, 1 hood to shell	SR	32 Ford Roadster/Steel Body, Original Ford Body	SRS2001
K		32	Weatherstrip kit, 1 hood to shell, 1 hood to cowl, 2 doors	SR	32 Ford Tudor Sedan, Original Ford Body	SRS2002
K		32	Weatherstrip kit, 1 hood to shell, 1 hood to cowl, 1 trunk, 2 door seals	SR	32 Ford 3 Window Coupe, Hardwood Industries Fiberglass Body	SRS3000

STREET RODS & CUSTOMS

Street Rods & Customs

CODE	IMAGE	YEAR	DESCRIPTION	BODY	FITS	ITEM#
K		32	Weatherstrip kit, 1 hood to shell, 1 hood to cowl, 2 door seals, 1 trunk	SR	32 Ford Roadster, Hardwood Industries Fiberglass Body	SRS3001
K		32	Weatherstrip kit, 1 hood to shell, 1 hood to cowl, 2 door seals	SR	32 Ford Tudor Sedan, Hardwood Industries Fiberglass Body	SRS3002
K		32	Weatherstrip kit, 1 hood to cowl, 1 hood to shell, 1 rear door, 2 door seals	SR	32 Ford Sedan Delivery, Hardwood Industries Fiberglass Body	SRS3003
K		32	Weatherstrip kit, 2 doors, 1 trunk, sides and top, 1 trunk bottom, 1 hood to cowl, 1 hood to shell	SR	32 Street Rod 5 Window Coupe/Steel Body, Kilbourne Rod Shop	SRS1000
K		32	Weatherstrip kit, 2 door seals, 1 trunk, sides and top, 1 trunk bottom, 1 hood to cowl, 1 hood to shell	SR	32 Street Rod Roadster, Kilbourne Rod Shop	SRS1001
K		32	Weatherstrip kit, 2 doors, 1 trunk, 1 hood to shell, 1 hood to cowl	SR	32 Street Rod Ford 3 Window Coupe, Kilbourne Rod Shop	SRS1002
K		32-33-34	Weatherstrip kit, 2 doors, 1 bottom of doors, 1 trunk, 1 hood to cowl, 1 hood to shell	SR	32-34 Ford 3 Window Coupe Street Rod, P And J Automotive, Inc	SRS601
K		33	Weatherstrip kit, 2 doors, hinge bumpers, 1 hood to cowl seal, 10 hood to shell bumpers, 4 hoodside panel bumpers, 1 trunk seal	2DR SDN	33 Willys Coupe, Rod Craft	SRSRC33
K		33	Weatherstrip kit, 2 doors, 1 trunk, 1 hood to cowl, 1 hood to grill	SR	33 Ford 3 Window Coupe, Downs Manufacturing Fiberglass Body	SRS902
K		33	Weatherstrip kit, 2 door seals, 1 trunk, 1 hood to cowl, bumper pack, 1 hood side bumpers	SR	33 Willys Coupe Street Rod, Fiberglass Fabrication Co, Inc Fiberglass Body	SRS1101
K		33	Weatherstrip kit, 2 doors, 1 hood to cowl, 1 hood to shell	SR	33 Ford Sedan, Redneck Corporation	SRS301
K		33	Weatherstrip kit, 2 doors, 1 trunk, 1 hood to cowl, 1 hood to shell	SR	33 Ford 3 Window Coupe, Redneck Corporation	SRS300
K		33-34	Weatherstrip kit, 1 hood to shell, 1 hood to cowl, 2 doors, 1 trunk, 1 trunk bottom	SR	33-34 Ford 3 And 5 Window Coupe, Original Ford Body	SRS2004
K		33-34	Weatherstrip kit, 2 doors, 1 trunk, 1 hood to cowl, 1 hood to shell	SR	33-34 Ford Roadster 3 Window Coupe, Outlaw Performance, Inc	SRS201
K		33-34	Weatherstrip kit, 2 doors, 1 trunk bottom, 1 hood to cowl/shell, 1 trunk	SR	33-34 Ford 3 Window Coupe, Ronson Street Rods	SRS1800
K		33-34	Weatherstrip kit, 2 doors bottom on door, 1 trunk, sides and top, 1 trunk bottom, 1 hood to cowl, 1 hood to grill	SR	33-34 Ford 3 Window Coupe Street Rod, Windsor Fabrication	SRS1400
K		33-34	Weatherstrip kit, 1 hood to cowl, 1 hood to shell, 3 doors 2 sides and rear	SR	33-34 Ford Sedan Delivery Street Rod, Windsor Fabrication	SRS1401



GUIDE TO SOFFSEAL'S PRODUCT CODES















B = Bumper sets **C** = Glass channels **D** = Door related **G** = Seals, gaskets **H** = Under hood items **I** = Interior parts
M = Miscellaneous items **R** = Roofrail, pillar post & convertible items **T** = Trunk related **W** = Window related **Z** = Weatherstrip kits

Street Rods & Customs



CODE	IMAGE	YEAR	DESCRIPTION	BODY	FITS	ITEM#
K		33-34	Weatherstrip kit, 2 doors bottom on door, 1 hood to cowl, 1 hood to shell, 1 trunk sides and top, 1 trunk bottom	SR	33-34 Ford Cabriolet Street Rod, Windsor Fabrication	SRS1402
K		33-34	Weatherstrip kit, 2 doors, 1 hood to cowl, 1 hood to shell	SR	33-34 Ford Victoria Street Rod, Windsor Fabrication	SRS1403
K		33-34	Weatherstrip kit, 2 doors bottom on door, 1 hood to cowl, 1 hood to shell, 1 trunk sides & top, 1 bottom of trunk	SR	33-34 Ford 3 Window Coupe Street Rod, Rats Glass Bodies	SRS1500
K		33-34	Weatherstrip kit, 2 doors, 1 hood to cowl, 1 hood to shell	SR	33-34 Ford 2 Door Sedan, Downs Manufacturing Fiberglass Body	SRS903
K		33-34	Weatherstrip kit, 2 doors, 1 rocker, 1 trunk, 1 hood to cowl, 1 hood to shell	SR	33-34 Ford Cabriolet Street Rod, P And J Automotive, Inc	SRS605
K		33-34	Weatherstrip kit, 2 door seals, 1 trunk, 1 trunk bottom, 1 hood to shell, 1 hood to cowl	SR	33-34 Ford 3 Window Coupe Street Rod, Gibbon Fiberglass Reproduction Inc. Fiberglass Body	SRS503
K		34	Weatherstrip kit, 2 doors, 1 trunk, 1 hood to cowl, 1 hood sides	SR	34 Cabriolet, Phaeton, Roadster, Old Chicago Street Rods Fiberglass Body	SRS800
K		34	Weatherstrip kit, 2 doors, 1 trunk, 1 hood to cowl, 1 hood to shell	SR	34 Chevrolet Coupe, Old Chicago Street Rods Fiberglass Body	SRS801
K		34	Street rod kit, 2 doors, 1 hood to cowl, 1 hood to shell, 1 trunk	SR	34 Street Rod 2 Door, Coupe, Street Beast	SRS4000
K		34	Weatherstrip kit, 2 doors, 1 hood to cowl, 1 hood to shell	SR	34 Vicky Street Rod, Street Beast	SRS4001
K		34	Weatherstrip kit, 2 doors, 1 hood to cowl, 1 hood to shell, 1 trunk, 1 roofrail	SR	34 Street Rod Cabriolet, Street Beast	SRS4002
K		34	Weatherstrip kit, 2 doors, 1 hood to cowl, 1 hood to shell, 1 trunk	SR	34 Ford Street Rod, Poli Form Industries	SRS1600
K		34	Weatherstrip kit, 2 doors, 1 door bottom/front, 1 hood to cowl, 1 hood to shell, 1 hoodside bumpers	SR	34 Chevrolet Sedan, Outlaw Performance, Inc	SRS203
K		34	Weatherstrip kit, 2 doors, 1 hood to cowl, 1 hood to shell, 1 rear hatch seal	Street Rod	34 Chevrolet Sedan Delivery, Outlaw Performance, Inc	SRS204
K		34	Weatherstrip kit, 2 doors, 1 trunk, 1 hood to cowl, 1 hood to shell	SR	34 Chevrolet 3 Window Coupe, Outlaw Performance, Inc	SRS205
K		34-35-36-37	Weatherstrip kit, 2 doors, 1 trunk, hood bumpers	SR	37 Ford 3 Window Hi Boy, Phaeton, 34 3 Window Coupe, Minottis Fiberglass Products, Inc Fiberglass Body	SRS100

Street Rods & Customs

CODE	IMAGE	YEAR	DESCRIPTION	BODY	FITS	ITEM#
K		35-36	Weatherstrip kit, 2 door seals, 1 sides & top of trunk, 1 bottom of trunk, 1 hood side at cowl & shell bumpers, 1 top of hood sides & grill where hood top meets them	SR	35-36 Street Rod Ford Roadster, Fairlane Company Fiberglass Body	SRS1300
K		35-36-37-38-39-40-41-42-43-44-45-46-47-48	Weatherstrip kit, 2 doors, 1 trunk, 1 hood to cowl/shell, 1 hood bumpers	SR	35-48 Universal 2 Door Street Rod, Original Ford Body	SRS2500
K		36	Weatherstrip kit, 1 lid	SR	36 Mullins Trailer, Outlaw Performance, Inc	SRS207
K		37	Weatherstrip kit, 2 doors, 1 trunk, 1 hood bumper, 1 left and right roofrail, 1 door glass/quarter. seal	ALL BODY STYLES	37 Ford Coupe, Oze	SRS5500
K		37	Weatherstrip kit, 2 doors, 1 trunk, 1 hood to cowl, 1 hood sides	SR CNV	37 Ford Phaeton Convertible, Downs Manufacturing Fiberglass Body	SRS900
K		37	Weatherstrip kit, 1 trunk, 1 hood side, 2 door seals, 1 hood to cowl	SR	37 Ford 3 Window Coupe, Downs Manufacturing Fiberglass Body	SRS901
K		39	Weatherstrip kit, 1 trunk/ rumble seat on body, 1 bumper pack, 1 hood lip where hood meets fender, 2 door seals	SR CNV	39 Ford Convertible Street Rod, Gibbon Fiberglass Reproduction Inc. Fiberglass Body	SRS502
K		39-40	Weatherstrip kit, 2 doors seals, sides, 4 doors top & bottom, 1 trunk back, 1 trunk sides & bottom	SR	39-40 Ford 3 Window, P And J Automotive, Inc	SRS600
K		39-40	Weatherstrip kit, 2 doors, 4 doors top and bottom, 1 trunk back, 1 trunk sides and bottom, 1 hood to cowl	SR	39-40 Ford 5 Window Coupe Street Rod, P And J Automotive, Inc	SRS602
K		39-40	Weatherstrip kit, 2 doors seals sides, 2 doors bottom, 1 trunk back, 1 trunk sides and bottom, 1 roofrail, 1 header seal, rear of top to body	SR CNV	39-40 Ford Convertible Street Rod, P And J Automotive, Inc	SRS603
K		40-41	Weatherstrip kit, 2 doors, 1 trunk, 1 hood to cowl seal, 2 hood to fender bumper	SR	40-41 Willys Coupe, Dennis Taylor Reproductions	SRS5000
K		40-41	Weatherstrip kit, 2 doors, 1 trunk, 1 hood to grill shell, 2 hood to cowl bumpers	SR	40-41 Willys Coupe, Outlaw Performance, Inc	SRS206
K		41	Weatherstrip kit, 1 trunk, 2 doors, 1 hood to cowl, 1 hood bumper, 2 adj bumpers, 2 glass run channel, 2 weatherstrip, 1 glass trim channel	ALL BODY STYLES	41 Willys, Street Beast	SRS4003
K		41	Weatherstrip kit, 2 doors, 1 hood to cowl seal, 2 grill shell bumpers, 1 trunk seal	2DR SDN	41 Willys Coupe, Redneck Corporation	SRSRC41
K		48	Weatherstrip kit, 2 door seals, 1 trunk, 1 hood seal	SR	48 Anglia Street Rod, Fiberglass Fabrication Co, Inc Fiberglass Body	SRS1100



















GUIDE TO SOFFSEAL'S PRODUCT CODES

B = Bumper sets **C** = Glass channels **D** = Door related **G** = Seals, gaskets **H** = Under hood items **I** = Interior parts
M = Miscellaneous items **R** = Roofrail, pillar post & convertible items **T** = Trunk related **W** = Window related **Z** = Weatherstrip kits

Street Rods & Customs



CODE	IMAGE	YEAR	DESCRIPTION	BODY	FITS	ITEM#
M		00-99	Drain plug	ALL BODY STYLES	Universal Fit Street Rod And Custom	SRD01
M		00-99	Bug screen clip small, rubber	ALL BODY STYLES	Universal Fit Street Rod And Custom	SRK10
M		00-99	Bug screen clip small 4 piece, rubber	ALL BODY STYLES	Universal Fit Street Rod And Custom	SRK1004
M	Image not found	00-99	Bug screen clip small 6 piece, rubber	ALL BODY STYLES	Universal Fit Street Rod And Custom	SRK1006
M		00-99	Bug screen clip small 8 piece, rubber	ALL BODY STYLES	Universal Fit Street Rod And Custom	SRK1008
M		00-99	Bug screen clip large, rubber	ALL BODY STYLES	Universal Fit Street Rod And Custom	SRK20
M		00-99	Bug screen clip large 4 piece, rubber	ALL BODY STYLES	Universal Fit Street Rod And Custom	SRK2004
M		00-99	Bug screen clip large 6 piece, rubber	ALL BODY STYLES	Universal Fit Street Rod And Custom	SRK2006
M		00-99	Bug screen clip large 8 piece, rubber	ALL BODY STYLES	Universal Fit Street Rod And Custom	SRK2008
M		00-99	Rubber bug screen mounting clip, extra large	ALL BODY STYLES	Universal Fit Street Rod And Custom	SRK30
M		00-99	Window weld ribbon sealer 3/8 inch round	ALL BODY STYLES	All Makes And Models	08622
M		00-99	Rubber hole plug 3/8 inch, used on floor, firewall & trunk	ALL BODY STYLES	All Makes And Models	0180
M		00-99	Rubber hole plugs 1/2 inch, used on floor, firewall & trunk	ALL BODY STYLES	All Makes And Models	0181
M		00-99	Rubber hole plug 5/8 inch, used on floor, firewall & trunk	ALL BODY STYLES	All Makes And Models	0182
M		00-99	Rubber hole plug 3/4 inch, used on floor, firewall & trunk	ALL BODY STYLES	All Makes And Models	0183
M		00-99	Rubber hole plug 7/8 inch, used on floor, firewall & trunk	ALL BODY STYLES	All Makes And Models	0184
M		00-99	Rubber hole plug 1 inch used on floor, firewall & trunk	ALL BODY STYLES	All Makes And Models	0185
M		00-99	Rubber hole plug 1 1/4 inch, used on floor, firewall & trunk	ALL BODY STYLES	All Makes And Models	0186

Street Rods & Customs

CODE	IMAGE	YEAR	DESCRIPTION	BODY	FITS	ITEM#
M		37-38	Speedo grommet on toe board	ALL BODY STYLES	37-38 Chevrolet	0211
M		37-38	Taillight, wire thru floor grommet	ALL BODY STYLES	37-38 Chevrolet	0214
M		37-38-39	Door window stops, in door, closed car	ALL BODY STYLES	37-39 Chevrolet	0212
M		37-38-39	Body to frame mounts	ALL BODY STYLES	37-39 Chevrolet All Models	0280
M		37-38-39	Firewall grommet, oil, temp throttle	ALL BODY STYLES	37-39 Chevrolet	0210
M		39	Taillight wire thru floor grommet	ALL BODY STYLES	39 Chevrolet	0216
M		39-40-41-42-43-44-45-46-47-48-49-50	Firewall grommet, main wiring harness	ALL BODY STYLES	39-50 Chevrolet	0202
M		40-41-42-43-44-45-46-47-48	Body to frame mounts	ALL BODY STYLES	40-48 Chevrolet Coupe/Sedan	0480
M		40-41-42-43-44-45-46-47-48	Body to frame mounts	CNV	40-48 Chevrolet Convertible	0482
M		40-41-42-43-44-45-46-47-48	Firewall grommet coil, temp, throttle	ALL BODY STYLES	40-48 Chevrolet	0410
M		40-41-42-43-44-45-46-47-48-49-50-51-52-53	Horn wire grommet	ALL BODY STYLES	40-53 Chevrolet	0404
M		41-42-43-44-45-46-47-48-49-50-51-52-53-54-55-56	Headlight, bucket wire grommets	ALL BODY STYLES	41-56 Chevrolet	0406
M		42-43-44-45-46-47-48	Top hydraulic line firewall grommet	CNV	42-48 Chevrolet, Convertible	0401
M		42-43-44-45-46-47-48	Front fender anti squeak kit	ALL BODY STYLES	42-48 Chevrolet	0460
M		46-47-48-49-50-51-52-53-54-55-56-57-58-59-60-61	Spacer folding top power cylinder	CNV	46-61 Chevrolet, Oldsmobile, Pontiac Convertible	0402
M		49-50-51-52-53-54	Speedo cable grommet	ALL BODY STYLES	49-54 Chevrolet	0509
M		49-50-51-52-53-54	Spare tire well grommets 4 piece	ALL BODY STYLES	49-54 Chevrolet	0511
M		49-50-51-52-53-54	Body to frame mounts	HTP CNV CPE	49-54 Chevrolet Coupe Hardtop Convertible	0580













GUIDE TO SOFFSEAL'S PRODUCT CODES

B = Bumper sets **C** = Glass channels **D** = Door related **G** = Seals, gaskets **H** = Under hood items **I** = Interior parts
M = Miscellaneous items **R** = Roofrail, pillar post & convertible items **T** = Trunk related **W** = Window related **Z** = Weatherstrip kits

Street Rods & Customs



CODE	IMAGE	YEAR	DESCRIPTION	BODY	FITS	ITEM#
M		49-50-51-52-53-54	Fender skirt rubber weatherstrip	ALL BODY STYLES	49-54 Chevrolet	0566
M		49-50-51-52-53-54	Body mount set	2DR SDN SWG	49-54 Chevrolet 2 Door 4 Door Sedan, Station Wagon	0582
M		68-69	Carpet insert for seat belts	2DR HTP CNV	68-69 Chevrolet Corvette Coupe, Convertible	0900
P		00-99	Glove box bumper; has a diameter of .312" and an installed height of .28". It is typically used in metal applications and has a drill/slot size of .156" with a cone shaped head.	ALL BODY STYLES	Universal Fit Street Rod And Custom	K103
P		00-99	Wiper motor grommet; has a diameter of .85" and an installed height of .11x2". It has .23" between the flats and a drill size of .625"	ALL BODY STYLES	Universal Fit And Universal Fit Street Rod And Custom	K106
P		00-99	Console lid bumpers; has a diameter of .312", and an installed height of .145". It is typically used in metal applications and has a drill/slot size of .14" and features a 1/16" radius on top.	ALL BODY STYLES	Universal Fit And Universal Fit Street Rod And Custom	K121
P		00-99	Door bumper; has a width of .812", a length of 1", and an installed height of .755". It is typically used in metal applications and has a drill/slot size of .25" and features off center holes.	ALL BODY STYLES	Universal Fit And Universal Fit Street Rod And Custom	K122
P		00-99	Rubber bumpers fiberglass vehicle; has a diameter of .59", and an installed height of .28". It is typically used in fiberglass applications and has a drill/slot of .25" with a 1/16" radius on top.	ALL BODY STYLES	Universal Fit And Universal Fit Street Rod And Custom	K183
P		00-99	Bumpers fiberglass vehicle; has a diameter of .312", and an installed height of .28". It is typically used in fiberglass applications and has a drill/slot of .172" with a cone shaped head.	ALL BODY STYLES	Universal Fit And Universal Fit Street Rod And Custom	K188
P		00-99	Bumpers fiberglass vehicle ; diameter of .3", and an installed height of .09". It is typically used in fiberglass applications and has a drill/slot of .188" with a 3/32" radius on top.	ALL BODY STYLES	Universal Fit And Universal Fit Street Rod And Custom	K189

Street Rods & Customs

CODE	IMAGE	YEAR	DESCRIPTION	BODY	FITS	ITEM#
P		00-99	Bumpers fiberglass vehicle; has a diameter of .5", and an installed height of .25". It is typically used in fiberglass applications and has a drill/slot of .25" with a 1/16" radius on top with a center hole.	ALL BODY STYLES	Universal Fit And Universal Fit Street Rod And Custom	K190
P		00-99	Bumpers fiberglass vehicle; has a diameter of .48", and an installed height of .09". It is typically used in fiberglass applications and has a drill/slot of .25" with a 3/32" radius on top with a center hole.	ALL BODY STYLES	Universal Fit And Universal Fit Street Rod And Custom	K191
P		00-99	Bumpers fiberglass vehicle; has a diameter of .77", and an installed height of .17". It is typically used in fiberglass applications and has a drill/slot of .25" with a button head and center hole.	ALL BODY STYLES	Universal Fit And Universal Fit Street Rod And Custom	K192
P		00-99	Fiberglass body bumper pack, includes 4-K183, 4-K192, 4-K106, 4-K189	ALL BODY STYLES	Universal Fit Street Rod And Custom	SR079
P		00-99	Steel body bumper kit, includes 4-K103, 4-K106, 4-K121, 4-K162	ALL BODY STYLES	Universal Fit Street Rod And Custom	SR080
P		00-99	Rubber bumpers fiberglass street rods	ALL BODY STYLES	Universal Fit Street Rod And Custom	SR081
P		00-99	Bumper kit	ALL BODY STYLES	Universal Fit Street Rod And Custom	SR083
P		00-99	Bumpers fiberglass vehicle	ALL BODY STYLES	Universal Fit Street Rod And Custom	SR084
P		00-99	Bumpers fiberglass vehicle	ALL BODY STYLES	Universal Fit Street Rod And Custom	SR085
P		00-99	Bumpers fiberglass vehicle	ALL BODY STYLES	Universal Fit Street Rod And Custom	SR086
P		00-99	Bumpers fiberglass vehicle	ALL BODY STYLES	Universal Fit Street Rod And Custom	SR087
P		00-99	Bumper kit 8 piece k144	ALL BODY STYLES	Universal Fit Street Rod And Custom	SR088
P		00-99	Bumper kit 8 piece k162	ALL BODY STYLES	Universal Fit Street Rod And Custom	SR089
P		00-99	Bumper kit 8 piece k103	ALL BODY STYLES	Universal Fit Street Rod And Custom	SR090
P		00-99	Bumper kit 8 piece k106	ALL BODY STYLES	Universal Fit Street Rod And Custom	SR091



GUIDE TO SOFFSEAL'S PRODUCT CODES



















B = Bumper sets **C** = Glass channels **D** = Door related **G** = Seals, gaskets **H** = Under hood items **I** = Interior parts
M = Miscellaneous items **R** = Roofrail, pillar post & convertible items **T** = Trunk related **W** = Window related **Z** = Weatherstrip kits

Street Rods & Customs



CODE	IMAGE	YEAR	DESCRIPTION	BODY	FITS	ITEM#
P		00-99	Bumper kit 8 piece k121	ALL BODY STYLES	Universal Fit Street Rod And Custom	SR092
P		00-99	Adjustable bumper; has a diameter of .74", and an installed height of .51". It features a #10-32 threaded stud which is 1" long.	ALL BODY STYLES	Universal Fit Street Rod And Custom	SRB1
R		42-43-44-45-46-47-48	Conv top header seal on windshield	ALL BODY STYLES	42-48 Chevrolet	0408
R		49-50-51-52	Windshield pillar post seals	CNV	49-52 Chevrolet Convertible	0552
R		53-54	Roofrail weatherstrip	2DR HTP	53-54 Chevrolet Oldsmobile Buick Pontiac, Hardtop	0550
R		62-63-64-65	Front rear license plate bumper; has a diameter of .48", and an installed height of .1". It is typically used in fiberglass applications and has a drill/slot of .281" with a 3/32" radius on top and a center hole.	ALL BODY STYLES	Universal Fit And 62-65 Chevy II And Universal Fit Street Rod And Custom	K162
T		37-38-39-40	Trunk weatherstrip	ALL BODY STYLES	37-40 Chevrolet Sedan Pontiac	0291
T		38-39-40	Trunk weatherstrip	ALL BODY STYLES	38-40 Chevrolet Coupe, Pontiac	0290
T		41-42-43-44-45-46-47	Trunk weatherstrip	ALL BODY STYLES	41-47 Chevrolet Coupe Oldsmobile Pontiac	0491
T		48	Trunk weatherstrip	ALL BODY STYLES	48 Chevrolet Coupe Oldsmobile Pontiac	0493
T		49-50-51-52-53	Trunk weatherstrip	2DR SDN 4DR SDN 2DR HTP 4DR HTP CNV	49-52 Chevrolet, Pontiac, 49-53 Oldsmobile, 49-50 Buick	0494
T		53-54	Trunk weatherstrip with molded corners, 2 molded corners & 2 extrusions, complete kit	ALL BODY STYLES	53-54 Chevrolet	0583
W		00-99	Universal fit channel and felt kit, fiberglass and steel body street rod	2DR 4DR HTP SDN SWG	Universal Fit Street Rod And Custom	SRCF1
W		00-99	Window felt	ALL BODY STYLES	Universal Fit Street Rod And Custom	SRF1369
W		00-99	Street Rod felt, 8 ft length	ALL BODY STYLES	Universal Fit Street Rod And Custom	SRF143
W		00-99	Street Rod felt, 8 ft length	ALL BODY STYLES	Universal Fit Street Rod And Custom	SRF148

Street Rods & Customs

CODE	IMAGE	YEAR	DESCRIPTION	BODY	FITS	ITEM#
W		00-99	Street Rod beltline weatherstrip 8 FT length	ALL BODY STYLES	Universal Fit Street Rod And Custom	SRF150
W		00-99	Street Rod felt, 8 ft length	ALL BODY STYLES	Universal Fit Street Rod And Custom	SRF194
W		00-99	Window felt	ALL BODY STYLES	Universal Fit Street Rod And Custom	SRF199
W		37-38	Quarter window glass channel	ALL BODY STYLES	37-38 Chevrolet Coupe	0248
W		37-38-39-40-60	Vent window division post seals	ALL BODY STYLES	37-38 Chevrolet, Oldsmobile, Pontiac	0304
W		37-3839-40-60	Vent window weatherstrip	ALL BODY STYLES	37-38 Chevrolet, Oldsmobile, Pontiac Closed Car	0302
W		37-38-39-40-41- 42-43-44-45-46- 47-48-49-50-51-52- 53-54	Mohair channel liner, 4 feet of 2 7/8 inch mohair lining material	CNV 2DR 4DR HTP	Bel Air 150 210, Nomad, Chieftain, 860/870 Star Chief, Safari, Super Chief, Bonneville, Nova, Omega, Apollo, Ventura, Skylark	0420
W		39	Quarter window glass channel	ALL BODY STYLES	39 Chevrolet Coupe	0249
W		40	Vent window division post seal	ALL BODY STYLES	40 Chevrolet	0244
W		40	Vent window seals closed car	ALL BODY STYLES	40 Chevrolet	0245
W		41-42-43-44-45- 46-47-48	Quarter window glass channel, coupe	ALL BODY STYLES	41-48 Chevrolet Coupe	0449
W		47-48-49-50	Window channel kit	TRK	1947-50 Chevy Truck	0538
W		48-49	Windshield post weatherstrip seals	CPE CNV	49 Buick Riviera, Cadillac Coupe Deville, Oldsmobile 98, Holiday Coupe, 48-49 Cadillac, Oldsmobile 98 Convertible	0553
W		49-50-51-52	Convertible top header seal	CNV	49-52 Chevrolet	0409
W		49-50-51-52-53-54	Glass setting channel hardtop	2DR HTP	50-54 Chevrolet 49-54 Pontiac, 2 Door Hardtop	0496
W		49-50-51-52-53-54- 55-56-57	Glass setting channel Sedan	SDN	49-57 Chevrolet Pontiac Sedan	0495
W		51-52-53-54-55	Window channel kit, division bar, channel, window weatherstrip	TRK	51-55 1st Series Chevrolet Truck, Gmc Truck	0554
W		53-54	Vent window division post seals	ALL BODY STYLES	53-54 Chevrolet Hardtop Convertible	0548



GUIDE TO SOFFSEAL'S PRODUCT CODES







B = Bumper sets **C** = Glass channels **D** = Door related **G** = Seals, gaskets **H** = Under hood items **I** = Interior parts
M = Miscellaneous items **R** = Roofrail, pillar post & convertible items **T** = Trunk related **W** = Window related **Z** = Weatherstrip kits

Street Rods & Customs



CODE	IMAGE	YEAR	DESCRIPTION	BODY	FITS		ITEM#
W		53-54	Vent window seals	ALL BODY STYLES	53-54 Chevrolet Sedan		0546

Universal Items • Extrusion















Image	Description		Item #
	Inner and outer fender seal, sponge, 3/4" wide x 5/8" high		E003
	Header seal convertible top, universal sponge extrusion, width of 3/4" and a height of 3/4"		E004
	Header seal convertible, universal sponge extrusion, width of 1 1/8" and a height of 11/16"		E005
	Header seal convertible top, universal sponge extrusion, height of 3/4" and a width of 13/16"		E006
	Extrusion with adhesive backing, universal sponge extrusion, height of 3/4" and a width of 13/16"		E006A
	Convertible top header seal universal extrusion, sponge, height of 1 1/8" and a width of 7/16"		E008
	Fender skirt rubber, universal dense extrusion, height of 3/8" and a width of 7/8"		E009









GUIDE TO SOFFSEAL'S PRODUCT CODES					
B = Bumper sets	C = Glass channels	D = Door related	G = Seals, gaskets	H = Under hood items	I = Interior parts
M = Miscellaneous items	R = Roofrail, pillar post & convertible items	T = Trunk related	W = Window related	Z = Weatherstrip kits	

Universal Items • Extrusion



Image	Description		Item #
 	Convertible top header seal, universal extrusion, height of 5/16" and a width of 1 5/16"		E010
 	Door weatherstrip, universal sponge extrusion, height of 5/8" and a width of 3/4"		E100
 	Door weatherstrip, universal sponge extrusion, height of 7/8" and a width of 23/32"		E101
 	Universal weatherstrip extrusion, sponge, height of 1/2" and a width of 1 1/4"		E1027
 	Door weatherstrip extrusion sponge, universal extrusion, height of 31/32" and a width of 5/8"		E103
 	Door seal universal sponge extrusion, height of 1 1/4" and a width of 5/8"		E104
 	Door weatherstrip, universal extrusion, Dense, height of 9/16" and a width of 3/8"		E105

Universal Items • Extrusion

Image	Description		Item #
	door weatherstrip extrusion, universal sponge extrusion, height of 41/64" and a width of 15/32"		E106
	Door weatherstrip, universal sponge extrusion, height of 1 1/16" and a width of 3/4"		E107
	Weatherstrip extrusion, universal sponge extrusion, with adhesive backing, height of 1/8" and a width of 5/16"		E1076
	Weatherstrip extrusion, universal sponge extrusion, with adhesive backing, height of 7/32" and a width of 3/8"		E1077
	Universal weatherstrip sponge extrusion, with adhesive backing, height of 3/16" and a width of 7/16"		E1078
	Universal weatherstrip sponge extrusion, with adhesive backing, height of 3/8" and a width of 5/8"		E1083
	Universal weatherstrip sponge extrusion, with adhesive backing, height of 1/4" and a width of 3/8"		E1085









GUIDE TO SOFFSEAL'S PRODUCT CODES







B = Bumper sets **C** = Glass channels **D** = Door related **G** = Seals, gaskets **H** = Under hood items **I** = Interior parts
M = Miscellaneous items **R** = Roofrail, pillar post & convertible items **T** = Trunk related **W** = Window related **Z** = Weatherstrip kits

Universal Items • Extrusion



Image	Description		Item #
	Lower door panel seal universal sponge extrusion, height of 8/32" and a width of 11/32"		E110
	Door universal weatherstrip extrusion, height of 1/2" and a width of 1 1/8"		E112
	Door universal weatherstrip extrusion, bulb diameter of 5/8" and a height of 1"		E118
	Door weatherstrip extrusion, height of 0.935 and bulb diameter of 0.550		E118A
	Door weatherstrip extrusion universal, height of 0.925 and width of 0.843		E145
	Sponge universal sponge weatherstrip with adhesive backing, height of 1/2" and a width of 1/2"		E1704
	Universal weatherstrip sponge extrusion, height of 3/8" and a width of 5/8"		E1723

Universal Items • Extrusion







Image	Description		Item #
	Flat gasket with pressure sensitive adhesive street rod universal, height of 0.841 and width of 0.045		E1776
	Universal weatherstrip sponge extrusion, with adhesive backing, height of 11/16" and a width of 11/16"		E1935
	Roofrail seal, universal sponge extrusion, height of 7/8" and a width of 7/8"		E200
	Roofrail weatherstrip, universal sponge extrusion, height of 1 3/32" and a width of 7/8"		E201
	Roofrail weatherstrip ext, universal sponge extrusion, height of 1 3/32" and a width of 7/8"		E201A
	Roofrail weatherstrip, universal sponge extrusion, height of 1 1/16" and a width of 1 1/8"		E202
	Roofrail weatherstrip, universal sponge extrusion, height of 1 3/8" and a width of 13/16"		E203









GUIDE TO SOFFSEAL'S PRODUCT CODES					
B = Bumper sets	C = Glass channels	D = Door related	G = Seals, gaskets	H = Under hood items	I = Interior parts
M = Miscellaneous items	R = Roofrail, pillar post & convertible items	T = Trunk related	W = Window related	Z = Weatherstrip kits	

Universal Items • Extrusion



Image	Description		Item #
	Roofrail weatherstrip, universal sponge extrusion, height of 7/8" and a width of 5/8"		E204
	Windshield pillar post seal, universal sponge extrusion, height of 9/16" and a width of 7/16"		E205
	Roofrail weatherstrip, universal sponge extrusion, height of 1 5/32" and a width of 7/8"		E206
	Front roofrail weatherstrip, universal sponge extrusion, height of 1 1/32" and a width of 1 1/4"		E207
	Roofrail weatherstrip, universal sponge extrusion, height of 1 3/8" and a width of 1 1/8"		E208
	Roofrail weatherstrip, universal sponge extrusion, height of 1 9/16" and a width of 11/16"		E209
	Roofrail weatherstrip, universal sponge extrusion, height of 1 1/2" and a width of 3/4"		E210

Universal Items • Extrusion







Image	Description		Item #
	Roofrail weatherstrip, universal sponge extrusion, height of 1 3/8" and a width of 3/4"		E211
	Roofrail weatherstrip, universal sponge extrusion, height of 1 1/2" and a width of 3/4"		E212
	Roofrail universal weatherstrip sponge extrusion, height of 1 3/8" and a width of 15/16"		E213
	Convertible top universal extrusion sponge, height of 1 1/4" and a width of 3/4"		E214
	Weatherstrip convertible top universal extrusion, height of 15/16" and a width of 7/8"		E215
	Roofrail weatherstrip ext, universal extrusion, height of 1 1/8" and a width of 1"		E216
	roofrail universal weatherstrip extrusion, height of 3/4" and a width of 1 1/16"		E220









GUIDE TO SOFFSEAL'S PRODUCT CODES					
B = Bumper sets	C = Glass channels	D = Door related	G = Seals, gaskets	H = Under hood items	I = Interior parts
M = Miscellaneous items	R = Roofrail, pillar post & convertible items	T = Trunk related	W = Window related	Z = Weatherstrip kits	

Universal Items • Extrusion



Image	Description		Item #
	Pillar post universal weatherstrip extrusion, height of 3/4" and a width of 1 1/8"		E228
	roofrail universal weatherstrip extrusion, height of 5/8" and a width of 1 1/16"		E229
	Roofrail weatherstrip, universal extrusion, height of 1 1/4" and a width of 1 3/8"		E230
	roofrail universal weatherstrip extrusion, height of 1 3/16" and a width of 1 5/16"		E231
	Roofrail weatherstrip ext, universal extrusion, height of 1" and a width of 1 3/8"		E235
	Roofrail/pillar Post Extrusion, height of 0.680 and width of 0.750		E236
	Weatherstrip Universal Extrusion with adhesive backing		E237A

Universal Items • Extrusion







Image	Description		Item #
	Trunk universal weatherstrip sponge extrusion, height of 1 3/16" and a width of 9/16"		E304
	Trunk connection extrusion, universal extrusion, Diameter of 9/16" and a width of 3/4"		E315
	Tailgate Weatherstrip, height of 1.115 and width of bulb 0.605		E324
	Quarter window seal, universal extrusion, Dense, Height of 15/16" and a width of 1/2"		E400
	Quarter window seal, universal extrusion, Dense, height of 15/16" and a width of 1/2"		E401
	Quarter window seal, universal extrusion, Dense, height of 13/16" and a width of 1/2"		E402
	Hood to cowl seal, universal extrusion, Dense, height of 11/16" and a width of 3/4"		E500









GUIDE TO SOFFSEAL'S PRODUCT CODES					
B = Bumper sets	C = Glass channels	D = Door related	G = Seals, gaskets	H = Under hood items	I = Interior parts
M = Miscellaneous items	R = Roofrail, pillar post & convertible items	T = Trunk related	W = Window related	Z = Weatherstrip kits	

Universal Items • Extrusion



Image	Description		Item #
	Hood to cowl seal, universal extrusion, Dense, height of 3/8" and a width of 5/8"		E501
	Hood to cowl seal, universal extrusion, Dense, height of 11/16" and a width of 7/8"		E502
	Hood to cowl seal, universal extrusion, Dense, height of 3/4" and a width of 5/8"		E503
	Hood to cowl seal sponge, universal extrusion, height of 1" and a width of 7/8"		E504
	Hood to cowl seal universal extrusion, Dense, height of 7/8" and a width of 7/16"		E507
	Hood to cowl seal dense, universal extrusion, height of 7/8" and a width of 3/4"		E508
	Instrument panel dash seal universal extrusion, Dense, height of 5/8" and a width of 7/16"		E509

Universal Items • Extrusion







Image	Description		Item #
	Dash mounted tach housing seal universal extrusion, Dense, height of 1/4" and a width of 3/16"		E510
	Hood to cowl seal extrusion, height of 1.480 and width of 0.825		E512
	Hood to cowl seal, universal extrusion, Dense, height of 3/4" and a width of 7/8"		E515
	Universal weatherstrip extrusion, with adhesive backing, height of 5/8" and a width of 3/4"		E518
	Dense epdm universal extrusion, height of 5/16" and a width of 1 5/16"		E525
	Flocked rubber channel 96 inch length, universal extrusion, height of 1/2" and a width of 1 3/8"		E566
	Rear Body Bumper Seal, height of 0.400 and width of 1.484		E602









GUIDE TO SOFFSEAL'S PRODUCT CODES					
B = Bumper sets	C = Glass channels	D = Door related	G = Seals, gaskets	H = Under hood items	I = Interior parts
M = Miscellaneous items	R = Roofrail, pillar post & convertible items	T = Trunk related	W = Window related	Z = Weatherstrip kits	

Universal Items • Extrusion

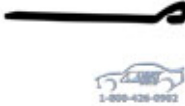

Image	Description		Item #
	Rear body to bumper seal, universal dense extrusion, height of 3/8" and a width of 3 1/4"		E603
	60 Durometer Epdm extrusion With 3/8" 3m-4237 Hats Tape, 18"		E611A
	Black Extruded 70 Durometer Epdm Extrusion, height of 0.910 and width of 0.863		E612
	Dense u channel extrusion, height of 1/2" and a width of 1/2"		E613
	T-grip Extrusion Blk Extruded 70 Durometer EPDM, width of 7/8 and 3/8 tall		E614
	Door Glass Run Channel 96"length, width of 3/4 and 17/32 tall		E634
	Front glass channel seal, universal dense extrusion, height of 1 3/16" and a width of 1 1/64"		E700A

Universal Items • Extrusion







Image	Description		Item #
	Front glass channel extrusion, universal dense extrusion, height of 1 1/8" and a width of 1 1/8"		E700B
	Headlight, taillight, bezel seal, universal dense extrusion, height of 5/16" and a width of 1/4"		E701
	Tailgate seal, universal sponge extrusion, height of 3/4" and a width of 5/8"		E703
	Front pan seal, universal dense extrusion, height of 5/16" and a width of 3 3/8"		E704
	Rear glass channel seal, universal dense extrusion, height of 5/16" and a width of 3 3/8"		E706A
	Rear glass channel seal, universal dense extrusion, height of 1 7/16" and a width of 3/4"		E706B
	Extrusion with adhesive, universal sponge extrusion, height of 1/4" and a width of 1/2"		E707A









GUIDE TO SOFFSEAL'S PRODUCT CODES					
B = Bumper sets	C = Glass channels	D = Door related	G = Seals, gaskets	H = Under hood items	I = Interior parts
M = Miscellaneous items	R = Roofrail, pillar post & convertible items	T = Trunk related	W = Window related	Z = Weatherstrip kits	

Universal Items • Extrusion



Image	Description		Item #
	Bottom glass channel extrusion, height of 1 3/8" and a width of 1 1/16"		E708A
	Taillight Seal Extrusion, height left of 0.223 height right of 1.154 and width of 0.276		E709
	Air cleaner lid seal universal sponge extrusion, height of 3/8" and a width of 5/16".		E710
	Front hood to radiator support seal, universal extrusion, height of 1/2" and a width of 2 7/8"		E711
	Glass channel ext, height of 1" and a width of 3/4".		E712
	Glass channel ext, height of 1" and a width of 5/8"		E713
	Taillamp housing to body seal, universal dense extrusion, height of 1/8" and a width of 1/8"		E714

Universal Items • Extrusion

Image	Description		Item #
	Doghouse to cab seal extrusion, universal sponge extrusion, height of 7/8" and a width of 1/2"		E715
	Taillight, lower seal universal extrusion, height of 3/16" and a width of 1/16"		E718
	Hoodside bumper, universal extrusion, height of 1 3/16" and a width of 5/8"		E720
	Epdm glass channel universal extrusion, height of 1 5/8" and a width of 5/8"		E723
	Extrusion, black, universal with adhesive, height of 7/16" and a width of 7/16"		E725A
	Chevrolet taillamp to body seal universal extrusion, height of 3/16" and a width of 3/16"		E730
	Glass run channel flocked, universal extrusion, height of 1/2" and a width of 13/16"		E731









GUIDE TO SOFFSEAL'S PRODUCT CODES







B = Bumper sets **C** = Glass channels **D** = Door related **G** = Seals, gaskets **H** = Under hood items **I** = Interior parts
M = Miscellaneous items **R** = Roofrail, pillar post & convertible items **T** = Trunk related **W** = Window related **Z** = Weatherstrip kits

Universal Items • Extrusion



Image	Description		Item #
	Glass channel ext, small profile , universal extrusion, height of 1 1/32" and a width of 13/16"		E732
	Glass channel extrusion, large profile , universal extrusion, height of 13/16" and a width of 1 1/4"		E733
	Glass channel universal extrusion, height of 9/16" and a width of 5/8"		E750
	Verticle seal side sliding window universal extrusion, height of 7/8" and a width of 3/4"		E751
	Door Weatherstrip Extrusion, width of 17/32 and it is 13/16 tall		E755
	Universal weatherstrip extrusion, height of 9/16" and a width of 3/8"		E798
	Universal extrusion, height of 9/16" and a width of 2 1/2"		E800

Universal Items • Extrusion

Image	Description		Item #
	Universal extrusion, height of 1 1/8" and a width of 1 1/8"		E802
	Universal extrusion, height of 7/16" and a width of 3/4"		E804
	Roofside ext, height of 1 1/8" and a width of 1 1/8"		E806
	Door universal weatherstrip extrusion, height of 7/8" and a width of 5/8"		E905
	Inside door edge trim with metal insert, universal extrusion, height of 3/4" and a width of 3/8"		E910
	Trim edge window lower door height of 1/4" and a width of 5/16"		E911
	Roof side rail extrusion, special project, universal extrusion, height of 5/16" and a width of 1 1/4"		E960









GUIDE TO SOFFSEAL'S PRODUCT CODES

B = Bumper sets **C** = Glass channels **D** = Door related **G** = Seals, gaskets **H** = Under hood items **I** = Interior parts
M = Miscellaneous items **R** = Roofrail, pillar post & convertible items **T** = Trunk related **W** = Window related **Z** = Weatherstrip kits

Universal Items • Extrusion



Image	Description		Item #
	<p>Sponge extrusion universal extrusion, with adhesive backing, height of 1/2" and a width of 3/8"</p>		E970
	<p>Epdm sponge extrusion with 3/8 inch adhesive, universal extrusion, height of 5/8" and a width of 1/2"</p>		E971
	<p>Door weatherstrip with clips, universal extrusion, height of 5/8" and a width of 3/4"</p>		EC100
	<p>Door weatherstrip extrusion with clips, universal sponge extrusion, height of 55/64" and a width of 23/32"</p>		EC101
	<p>Door weatherstrip extrusion with clips, universal extrusion, height of 31/32" and a width of 5/8"</p>		EC103
	<p>Clipped convertible door weatherstrip extrusion, height of 41/64" and a width of 15/32"</p>		EC106
	<p>Trunk weatherstrip extrusion with clips, universal extrusion, height of 1 3/16" and a width of 9/16"</p>		EC304

Universal Items • Bumpers

Image	Description		Item #
	<p>Grille bar spacer, bumper has an outer diameter of .93" and an inner diameter of .375". Its installed height is .53".</p>		K050
	<p>Upper door bumper push in; diameter of .48" and an installed height of .375". It is typically used in metal applications, and has a drill size of .25" with a center hole, dome.</p>		K100
	<p>Hood adjustment bumper Cover; has a diameter of .87" and an overall height of .39". It has a hole diameter of .375, with a .52" undercut that is .2" deep with a 120 groove.</p>		K101
	<p>Bumper rs; has a diameter of .6" and an installed height of .27". It is typically used in metal applications, and has a drill/slot size of .25" with a 3/32 radius on top.</p>		K102
	<p>Glove box bumper; has a diameter of .312" and an installed height of .28". It is typically used in metal applications and has a drill/slot size of .156" with a cone shaped head.</p>		K103
	<p>Door bumper; has a width of .375", a length of 13/16", and an installed height of .49". It is typically used in metal applications and has a drill/slot size of 2x.25@.45" and center holes</p>		K104



GUIDE TO SOFFSEAL'S PRODUCT CODES

B = Bumper sets **C** = Glass channels **D** = Door related **G** = Seals, gaskets **H** = Under hood items **I** = Interior parts
M = Miscellaneous items **R** = Roofrail, pillar post & convertible items **T** = Trunk related **W** = Window related **Z** = Weatherstrip kits

Universal Items • Bumpers



Image	Description		Item #
	<p>Trunk bumpers; has a diameter of .865" and an installed height of .3". It is typically used in metal applications and has a drill/slot size of .25" and a center hole.</p>		K105
	<p>Wiper motor grommet; has a diameter of .85" and an installed height of .11x2". It has .23" between the flats and a drill size of .625"</p>		K106
	<p>Trunk bumpers; has a diameter of .905" and an installed height of .365". It is typically used in steel applications and has a drill/slot size of .25" and a 3/32 radius on top with a center hole.</p>		K108
	<p>Door bumpers; has a width of .52", a length of 15/16", and an installed height of .405". It is typically used in metal applications and has a drill/slot size of 2x.25@.45" and center holes.</p>		K109
	<p>Seat back bumpers; has a width of 1.3", a length of 14/16", and an installed height of .295". This bumper also has a .19x.435 counter bore.</p>		K112
	<p>Hood side bumper; has a width of .82", a length of 10/16", and an installed height of .73". It is typically used in metal applications and has a drill/slot size of .172".</p>		K113

Universal Items • Bumpers

Image	Description		Item #
	<p>Hood side bumper; has a width of 1.255", a length of 1", and an installed height of 1.5". It is typically used in metal applications and has a drill/slot size of .250".</p>		K114
	<p>Hood side bumpers; has a width of .965", a length of 10/16", and an installed height of .94". It is typically used in metal applications and has a drill/slot size of .188".</p>		K115
	<p>Hood side bumpers; has a width of 1.05", a length of 12/16", and an installed height of .775". It has a drill/slot size of .203".</p>		K116
	<p>Hood side bumpers; has a width of 1.28", a length of 11/16", and an installed height of 1.41". It is typically used in metal applications and has a drill/slot size of .140".</p>		K117
	<p>Hood side bumpers; has a width of 1.14", a length of 12/16", and an installed height of .34 to .23". It is typically used in metal applications and has a drill/slot size of .172" and is tapered.</p>		K118
	<p>Trunk bumpers; has a diameter of .85", and an installed height of .2". It is typically used in metal applications and has a drill/slot size of .375" and has a center hole.</p>		K119



GUIDE TO SOFFSEAL'S PRODUCT CODES

B = Bumper sets **C** = Glass channels **D** = Door related **G** = Seals, gaskets **H** = Under hood items **I** = Interior parts
M = Miscellaneous items **R** = Roofrail, pillar post & convertible items **T** = Trunk related **W** = Window related **Z** = Weatherstrip kits

Universal Items • Bumpers



Image	Description		Item #
	<p>Console lid bumpers; has a diameter of .312", and an installed height of .145". It is typically used in metal applications and has a drill/slot size of .14" and features a 1/16" radius on top.</p>		<p>K121</p>
	<p>Door bumper; has a width of .812", a length of 1", and an installed height of .755". It is typically used in metal applications and has a drill/slot size of .25" and features off center holes.</p>		<p>K122</p>
	<p>Hood side bumpers; has a width of 1.2", a length of 10/16", and an installed height of 1.2". It is typically used in metal applications and has a drill/slot size of .172".</p>		<p>K123</p>
	<p>Upper door bumper; has a diameter of .495", and an installed height of .52". It has a counter bore size of .19x.275".</p>		<p>K124</p>
	<p>Seat back bumpers; has a diameter of 1.02", and an installed height of .61". It has a taper, with a counter bore size of .19x.375".</p>		<p>K125</p>
	<p>Door bumpers; has a width of .64" at the base and .45" thru the body, a length of 1", and an installed height of .78". It is typically used in metal applications and has a drill/slot size of 2x.25@.45" and sits off center.</p>		<p>K126</p>

Universal Items • Bumpers

Image	Description		Item #
	<p>Seat back bumpers; has a width of .86", a length of 1 and 8/16", and an installed height of .45". It has a counter bore size of .19x.375".</p>		K127
	<p>Hoodside bumpers ; has a width of 1.27", a length of 10/16", and an installed height of .4". It is typically used in metal applications and has a drill/slot of .172".</p>		K128
	<p>Rear hood side bumper; has a width of 1.125", a length of 10/16", and an installed height of .6". It is typically used in metal applications and has a drill/slot of .140".</p>		K130
	<p>Front hood side bumper; has a width of .95", a length of 1", and an installed height of 1". It is typically used in metal applications and has a drill/slot of .109".</p>		K131
	<p>Hood bumpers; has a width of 1.35", a length of 10/16", and an installed height of .73". It is typically used in metal applications and has a drill/slot of .172".</p>		K133
	<p>Door bumpers; has a width of .625", a length of 10/16", and an installed height of .43". It is typically used in metal applications and has a drill/slot of .25" and is half round.</p>		K134



GUIDE TO SOFFSEAL'S PRODUCT CODES					
B = Bumper sets	C = Glass channels	D = Door related	G = Seals, gaskets	H = Under hood items	I = Interior parts
M = Miscellaneous items	R = Roofrail, pillar post & convertible items	T = Trunk related	W = Window related	Z = Weatherstrip kits	

Universal Items • Bumpers



Image	Description		Item #
	<p>Hood side bumpers; has a width of .9", a length of 1", and an installed height of .75". It is typically used in metal applications and has a drill/slot of .205".</p>		<p>K135</p>
	<p>Hood side bumpers a body; has a width of 1.41", a length of 1", and an installed height of .855". It is typically used in metal applications and has a drill/slot of .188".</p>		<p>K136</p>
	<p>Hoodsid bumpers; has a width of 1.125", a length of 10/16" and an installed height of .665". It is typically used in metal applications and has a drill/slot of .250".</p>		<p>K137</p>
	<p>Hood side bumper; has a width of .79", a length of 1", and an installed height of .37". It is typically used in metal applications and has a drill/slot of .343".</p>		<p>K138</p>
	<p>License plate bumper; has a diameter of .5", and an installed height of .25". It is typically used in metal applications and has a drill/slot of .250" with 1/16" radius on top and center hole.</p>		<p>K143</p>
	<p>Gas tank door ash tray bumpers; has a diameter of .3", and an installed height of .09". It is typically used in metal applications and has a drill/slot of .172" and a button head.</p>		<p>K144</p>

Universal Items • Bumpers



Image	Description		Item #
	<p>Rear hood bumpers; has a width of 1.46", a length of 1", and an installed height of .375". It is typically used in metal applications and has a drill/slot of .312".</p>		K145
	<p>Door bumper; has a width of .425", a length of 10/16", and an installed height of .35". It is typically used in metal applications and has a drill/slot of .250" and features a split.</p>		K146
	<p>Door bumper; has a width of .4", a length of 15/16", and an installed height of .45". It is typically used in metal applications and has a drill/slot of .188" and features a split.</p>		K147
	<p>Glove box arm grommets; has a width of .73", a length of 6/16", and an installed height of .335". It features a .35x.09" slot.</p>		K148
	<p>Brake clutch pedal Bumper; has a width of .63", a length of 10/16", and an installed height of .6". It is typically used in metal applications and has a drill/slot of .312".</p>		K149
	<p>Brake clutch pedal bumpers; has a width of .9", a length of 9/16", and an installed height of .57". It is typically used in metal applications and has a drill/slot of .375".</p>		K150



GUIDE TO SOFFSEAL'S PRODUCT CODES					
B = Bumper sets	C = Glass channels	D = Door related	G = Seals, gaskets	H = Under hood items	I = Interior parts
M = Miscellaneous items	R = Roofrail, pillar post & convertible items	T = Trunk related	W = Window related	Z = Weatherstrip kits	

Universal Items • Bumpers



Image	Description		Item #
	<p>Hood panel grille bumper; has a diameter of 1.05", and an installed height of .18". It is typically used in metal applications and has a drill/slot of .375" with a center hole.</p>		<p>K152</p>
	<p>Rear license plate bumper; has a diameter of .55", a length of .34", and an installed height of .51". It is typically used in metal applications and has a drill/slot of .281" with a cone shaped head.</p>		<p>K163</p>
	<p>Trunk bumpers; has a width of .96", a height of 10/16", and an installed height of .625". It is typically used in metal applications and has a drill/slot of .25".</p>		<p>K166</p>
	<p>Hood bumpers; has a width of 1.655", a height of 11/16", and an installed height of .84". It is typically used in metal applications and has a drill/slot of .14".</p>		<p>K167</p>
	<p>Door bumpers; has a diameter of .715", an upper diameter of .5", and an installed height of .68". It is typically used in metal applications and has a drill/slot of .343" cone shaped with a radius and hole.</p>		<p>K168</p>
	<p>Hood to fender bumpers; has a width of .84", a length of 5/8", and an installed height of .75". It is typically used in metal applications and has a drill/slot of .172".</p>		<p>K169</p>

Universal Items • Bumpers



Image	Description		Item #
	<p>Trunk bumpers; has a width of 1", a length of 10/16", and an installed height of .47". It is typically used in metal applications and has a drill/slot of .250".</p>		K170
	<p>Hood side bumper; has a width of 1.54", a height of 1", and an installed height of .8". It is typically used in metal applications and has a drill/slot of .250".</p>		K171
	<p>Door bumper all rear; has a width of .67", a height of 10/16", and an installed height of .48". It is typically used in metal applications and has a drill/slot of .281".</p>		K172
	<p>Door bumpers all rear; has a width of .58", a height of 11/16", and an installed height of .455". It is typically used in metal applications and has a drill/slot of .250".</p>		K173
	<p>Trunk bumpers; has a diameter of .88", and an installed height of .735". It is typically used in metal applications and has a drill/slot of .250" and a center hole.</p>		K174
	<p>Trunk bumper; has a diameter of .89", and an installed height of .415". It is typically used in metal applications and has a drill/slot of .250" and a center hole.</p>		K175



GUIDE TO SOFFSEAL'S PRODUCT CODES					
B = Bumper sets	C = Glass channels	D = Door related	G = Seals, gaskets	H = Under hood items	I = Interior parts
M = Miscellaneous items	R = Roofrail, pillar post & convertible items	T = Trunk related	W = Window related	Z = Weatherstrip kits	

Universal Items • Bumpers



Image	Description		Item #
	<p>Trunk bumpers; has a diameter of .89", and an installed height of .725". It is typically used in metal applications and has a drill/slot of .375" and a center hole.</p>		<p>K176</p>
	<p>Hood side front bumper; has a width of .92", a length of 15/16", and an installed height of .67". It is typically used in metal applications and has a drill/slot of .25".</p>		<p>K177</p>
	<p>Hood side bumper; has a width of 1.37", a length of 1", and an installed height of .55". It is typically used in metal applications and has a drill/slot of .281".</p>		<p>K178</p>
	<p>Hood side front corner bumper; has a width of 1", a length of 1", and an installed height of .63". It is typically used in metal applications and has a drill/slot of .281".</p>		<p>K179</p>
	<p>Rubber bumpers fiberglass vehicle; has a diameter of .59", and an installed height of .28". It is typically used in fiberglass applications and has a drill/slot of .25" with a 1/16" radius on top.</p>		<p>K183</p>
	<p>Bumpers fiberglass vehicle; has a diameter of .312", and an installed height of .28". It is typically used in fiberglass applications and has a drill/slot of .172" with a cone shaped head.</p>		<p>K188</p>

Universal Items • Bumpers

Image	Description		Item #
	<p>Bumpers fiberglass vehicle ; diameter of .3", and an installed height of .09". It is typically used in fiberglass applications and has a drill/slot of .188" with a 3/32" radius on top.</p>		K189
	<p>Bumpers fiberglass vehicle; has a diameter of .5", and an installed height of .25". It is typically used in fiberglass applications and has a drill/slot of .25" with a 1/16" radius on top with a center hole.</p>		K190
	<p>Bumpers fiberglass vehicle; has a diameter of .48", and an installed height of .09". It is typically used in fiberglass applications and has a drill/slot of .25" with a 3/32" radius on top with a center hole.</p>		K191
	<p>Bumpers fiberglass vehicle; has a diameter of .77", and an installed height of .17". It is typically used in fiberglass applications and has a drill/slot of .25" with a button head and center hole.</p>		K192
	<p>Trunk bumper; has a diameter of .77", and an installed height of .17". It is typically used in metal applications and has a drill/slot of .25" with a button head and center hole.</p>		K193



GUIDE TO SOFFSEAL'S PRODUCT CODES

B = Bumper sets **C** = Glass channels **D** = Door related **G** = Seals, gaskets **H** = Under hood items **I** = Interior parts
M = Miscellaneous items **R** = Roofrail, pillar post & convertible items **T** = Trunk related **W** = Window related **Z** = Weatherstrip kits

Universal Items • Body Mounts



Image	Description		Item #
	<p>Lower body mounts, Inside diameter 0.98"; outside diameter 1.72"; 0.8" high</p>		<p>K200</p>
	<p>Upper body mount ; 19/32" Inside Diameter; 2 1/2" Outside Diameter; 13/16" high; Boss Outside Diameter 1 9/64"; Boss Height 5/32"; with Metal Insert</p>		<p>K202</p>
	<p>Body mount; 7/8" Inside Diameter; 2 1/8" Outside Diameter; .8" high; Boss Outside Diameter 1.45"; Boss Height .36"; with Metal Insert ; 1 1/2" over all height</p>		<p>K207</p>
	<p>Body mount 2 1/2" Outside Diameter; 1" High; Boss Outside Diameter 1 3/8"; 5/16" high; Snaps in</p>		<p>K208</p>
	<p>Lower body mount 1 3/32" Inside Diameter; 2 1/32" Outside Diameter; .7/8" High; Counterbore is 1 7/16" Inside diameter; 5/16" Deep</p>		<p>K209</p>
	<p>Upper body mount 19/32" Inside Diameter; 2" Outside Diameter; 1" high; Boss Outside Diameter 1 15/32"; Boss height 15/32"; with Metal Insert 1 1/2" Over All Height</p>		<p>K210</p>

Universal Items • Body Mounts

Image	Description		Item #
Image not found	Lower body mount 1" Inside Diameter; 2" Outside Diameter; 3/4" high; Boss Inside Diameter 1 1/2"; Boss height 5/8"		K213
	Upper body mount 19/32" Inside Diameter; 2 19/32" Outside Diameter; 1 1/8" high; Boss Outside Diameter 1 17/32"; Boss height 1/4"; with Metal Insert 1 1/4" Over All Height		K219
	Body mount 1/2" Inside Diameter; 2" Outside Diameter; 7/8" high; Counter Bore Inside Diameter 1 17/32"; Depth 9/16; with Metal Washer		K242
	Rectangular body mount 1 3/4" x 2 7/16" Boss Outside Diameter 1 1/4"; Boss height 3/16"; with Metal Insert 1 1/8" Over All Height; Rectangle		K277



GUIDE TO SOFFSEAL'S PRODUCT CODES

B = Bumper sets **C** = Glass channels **D** = Door related **G** = Seals, gaskets **H** = Under hood items **I** = Interior parts
M = Miscellaneous items **R** = Roofrail, pillar post & convertible items **T** = Trunk related **W** = Window related **Z** = Weatherstrip kits